



**Johnson**  
electronic equipment

**OPERATING MANUAL  
VIKING RANGER  
TRANSMITTER/EXCITER**



**E. F. Johnson Company**

W A S E C A , M I N N E S O T A

## Johnson Viking Ranger Transmitter Installation and Operation

The successful operation of any radio equipment is largely dependent upon the operator's understanding of the equipment. This operating instruction manual is set up in several parts, each with the purpose of making the operator more familiar with the Viking Ranger. It is strongly recommended that this manual be read prior to attempting operation of the equipment. The main parts of the manual are:

	<u>Page</u>
A. Set-Up Instruction for Factory Wired Transmitters	1
B. Theory of Operation - Circuits	4
C. Viking Ranger Tuning Procedure	8
D. Pi-Network Tuning and Harmonic Suppression	10
E. VFO Calibration Procedure	15
F. Exciter Operation, VFO Zeroing, Push-to-Talk	19
G. Typical Operating Data and Trouble Shooting, Adjustments	22
H. Photographs, Charts and Schematic Diagram	Following Page 25
I. Parts List	At rear of book

The Viking Ranger should be given the good care usually accorded any other fine electronic instrument and in return will provide long trouble-free service. Periodic cleaning, dust removal, tube checking, etc. will maintain the equipment's appearance and performance.

### W A R N I N G

The voltages encountered in this piece of equipment are high enough to cause fatal injury! Practice safety rules until they are second nature. Always turn off the high voltage before making any adjustment inside the transmitter. Never depend on a bleeder resistor to discharge filter condensers. After the power is turned off, short circuit the high voltage circuit. Never operate the transmitter with any other than the recommended fuses in the primary circuit. The fuses will protect your equipment - in the case of accidental contact with the high voltage, they may save your life. If children have access to the open transmitter, always disable the primary circuit by removing the fuses, or the high voltage circuits by removing the rectifiers. Always remove the line cord plug from the power source when working inside the transmitter.

# STANDARD WARRANTY

Adopted and Recommended by the  
Electronic Industries Association

The E. F. Johnson Company warrants each new radio product manufactured by it to be free from defective material and workmanship and agrees to remedy any such defect or to furnish a new part, except for electron tubes, in exchange for any part of any unit of its manufacture which under normal installation, use and service disclosed such defect, provided the unit is delivered by the owner to us or to our authorized radio dealer or wholesaler from whom purchased, intact, for our examination, with all transportation charges prepaid to our factory, within ninety days from the date of sale to original purchaser and provided that such examination discloses, in our judgement, that it is thus defective.

This warranty does not extend to any of our radio products which have been subjected to misuse, neglect, accident, incorrect wiring not our own, improper installation, unauthorized modifications, or to use in violation of instructions furnished by us, nor extend to units which have been repaired or altered outside of our factory, nor to cases where the serial number thereof has been removed, defaced or changed, nor to accessories used therewith not of our own manufacture, nor to electron tubes.

The Radio Parts Distributor will assume the responsibility for replacement or exchange of any component part of a unit approved for remedy or exchange hereunder, through the factory Customer Service Department, without charge to the owner.

Defective electron tubes and executed service report should be returned prepaid directly to the tube manufacturer for adjustment at the following addresses:

(a) RCA tubes to: Adjustment Service, RCA at the nearest of the following addresses:  
34 Exchange Place                      3601 South Adams St.                      6355 East Washington Blvd.  
Jersey City 2, N. J.                      Marion, Indiana                      Los Angeles 22, California

(b) General Electric tubes to:                      (c) Amperex tubes to:                      (d) Eimac tubes to:  
Adjustment Service                      Amperex Electronic Corp.                      Eitel-McCullough, Inc.  
Owensboro Tube Works                      230 Duffey Avenue                      San Bruno,  
General Electric Co.                      Hickville, Long Island                      California  
Owensboro, Kentucky                      New York

(e) Sylvania tubes to: Any Authorized Sylvania Distributor.

This warranty is in lieu of all other warranties expressed or implied and no representative or person is authorized to assume for us any other liability in connection with the sale of our radio products.

## A. SET-UP INSTRUCTIONS FOR FACTORY WIRED TRANSMITTERS

1. After unpacking the transmitter, inspect thoroughly for any possible damage or marks from shipping. Claims against the carrier delivering the equipment must be made to the carrier agent at the point of delivery. DO NOT SHIP DAMAGED EQUIPMENT BACK TO MANUFACTURER UNTIL NOTIFIED TO DO SO BY THE MANUFACTURER. NOTIFY THE SERVICE DIVISION THAT A CLAIM IS BEING MADE AGAINST THE CARRIER.
2. In order to attach the knobs, install tubes and remove packing material, remove the transmitter from the cabinet as follows:
  - a. Loosen and remove the three tie bolts which are located at the rear of the cabinet, top center, right and left side center.
  - b. Loosen and remove the eight screws around the periphery of the cutouts (four at each cutout) for the line cord and the output cable connector.
  - c. Slide the chassis out of the cabinet, carefully training the line cord through the opening provided.
3. Remove the packages containing the knobs, plug X-13B and antenna relay plug.
4. Remove the packing around the final coil and any additional packing inside the cabinet and on the chassis.
5. Remove the supports provided underneath the chassis on the transformer and choke mounting screws.
6. Installation of tubes - (In most cases tubes will already be in place.) Refer to Figure 1 for tube locations.
  - a. To facilitate removal of the VFO side cover, CH9, the crystal holder socket, X14 should be pivoted to one side to provide better access to the spade lug nearer the front panel. The mounting screw of X14, which can be seen in Figure 2, should be removed and the socket pivoted toward the right, in the direction of the bleeder resistor, R35. Be sure to replace the screw after the side cover has been secured in a later step.
    - (1) Place the OA2 tube, V2, in the socket nearest the front panel inside the VFO.
    - (2) Place the 6AU6 tube, V1, in the remaining socket inside the VFO. Do not replace side cover at this time. No tube shields are used in this transmitter.
  - b. Place V3, 6CL6 oscillator-multiplier tube, in socket X3.
  - c. Place V4, 6CL6 tube, in socket X4.
  - d. Place V12, 6AX5GT L.V. rectifier, in socket X12.
  - e. Place V11, 5R4GY H.V. rectifier, in socket X11.
  - f. Place V5, 6L46 final amplifier, in socket X5. Attach the plate cap J6.
  - g. Place the two modulator tubes, V9 and V10, 1614's, in sockets X9 and X10.
  - h. Place V8, 12AU7 audio driver, in socket X8.
  - i. Place V7, 12AX7 1st and 2nd audio speech amplifiers, in socket X7.
  - j. Place V6, 6AG5 clamper tube, in socket X6.
  - k. Place V13, 12AU7 keyer tube, in socket X36.
  - l. Place V14, 6AL5 bias rectifier tube, in socket X35.
7. Install knobs as follows (set screws for all knobs are packaged separately and are installed at time of mounting):

7. a. Place a 1/4" I.D. deformed washer on all shafts except buffer, final and VFO shafts.
  - b. Install the large 2 3/8" knob, using one 10-32 set screw, on the 1/4" shaft extending from the VFO planetary drive, being careful not to place the knob too close to the dial plate which would cause rubbing against the dial. Tighten the set screw.
  - c. Install the 1 5/8" knob on the "BAND" switch shaft extension, using one 8-32 set screw, making sure the knob marker coincides with the panel markings by turning the switch to the maximum counter-clockwise position and setting the knob marker to coincide with the 160M marker. Tighten the set screw.
  - d. Install the seven single marker phenolic knobs as follows, using 8-32 setscrews:
    - (1) Turn the "DRIVE" control shaft fully counter-clockwise. Install one of the phenolic knobs with the marker at the "0" position and tighten the setscrew.
    - (2) Turn the "OPERATE" switch (SW4) to the counter-clockwise position, install one of the single marker phenolic knobs with the marker on the "OFF" position. Tighten the set screw.
    - (3) Turn the "CRYSTAL-VFO" switch (SW2) to the counter-clockwise position, install one of the single marker phenolic knobs with the marker on the "XT1" position. Tighten the setscrew.
    - (4) Turn the "AUXILIARY" switch (SW6) to the counter-clockwise position, install one of the single marker phenolic knobs, with the marker on numeral "1". Tighten the setscrew.
    - (5) Turn the "COUPLING" condenser (C9) into the fully meshed position. Install one of the single marker phenolic knobs with the marker on the "0" position. Tighten the setscrew.
    - (6) Turn the "AUDIO" gain control to the maximum counter-clockwise position, install one of the single marker phenolic knobs with the marker on the "0" position. Tighten the setscrew.
    - (7) Turn the "METER" switch (SW5) to the maximum counter-clockwise position. Install one of the single marker phenolic knobs, with marker on the "OFF" position. Tighten the setscrew.
  - e. Install the two 0 to 100 skirted knobs as follows, using 8-32 setscrews:
    - (1) Turn the buffer tuning condenser (C7) shaft until fully meshed. Install one of the knobs with the 0 directly under the green dot on the dial escutcheon. Tighten the setscrew.
    - (2) Turn the final tuning condenser (C8) shaft until the condenser is fully meshed. Install one of the knobs with the 0 directly under the green dot on the dial escutcheon. Tighten the setscrew.
  - f. Before installing the crystal knob cover, it may be necessary to reform the contact fingers on the knob in order to reduce some of the pressure experienced in installing and removing the cover. This is done by pressing the contact fingers inward toward the center of the cover, a little at a time, until the cover can be installed relatively easy and still have a firm feeling when in place.
  - g. At this time, check the function of each knob to see if the indexing agrees with the markings on the panel (i.e. bandswitch on 160M when counter-clockwise and 11M when fully clockwise).
8. With the transmitter out of the cabinet and the VFO side plate removed for observing the oscillator tube and the VR OA2 tube, initial checks can begin:

- A. 8. a. Check to see that both the 5 amp fuse and 3 amp Fusetron, or Slo-Blo fuse, are installed in the fused type line cord plug.
- b. Place the "OPERATE" switch in the "OFF" position, and plug the line cord into a 117V AC receptacle. Plug X-13B into the X-13A socket on the back of transmitter.
- c. (1) Set the VFO pointer at mid-scale. Turn the drive control to position #5.
- (2) Turn the "BAND" switch to 160M.
- (3) Turn the "CRYSTAL-VFO" switch to "VFO".
- (4) Turn "OPERATE" switch to the "TUNE" position.
- (5) Check all tubes for evidence of filament lighting.
- (6) After sufficient warm-up period, check for a purple glow inside the envelope of the OA2 VR tube inside the VFO compartment.
- (7) Turn the meter switch to the "OSC" position.
- a. Reading should be 24 to 32 ma. (This will be lower on 15 and 20 meters).
- b. Turn the "CRYSTAL-VFO" switch to "XT1" position (with no crystal installed). Meter reading should be approximately 16 to 20 ma.
- c. Install a crystal and check for increase in "OSC" current when switching from crystal to the blank crystal socket.
- (8) Turn the "BAND" switch to "40" meter position and repeat step 7. Readings should be comparable.
9. Turn the "BAND" switch back to the "160" position and turn the "OPERATE" switch to the "OFF" position. Remove the line cord from the 117V AC receptacle.
10. Install the VFO side cover with the eight 1/4" #4 screws and #4 shakeproof washers, and the two 6-32 hex nuts and #6 shakeproof washers. DO NOT TIGHTEN ANY OF THE SHEET METAL SCREWS UNTIL THE TWO 6-32 HEX NUTS ON THE BOTTOM SIDE OF CHASSIS HAVE BEEN TIGHTENED. After the two 6-32 hex nuts are tightened securely, tighten the eight #4 screws securely.
11. At this time, refer to Section E of the Operating Manual, in order to determine if there has been an appreciable change in the calibration of the VFO due to possible changes in the VFO trimmer and padder condenser settings as a result of rough handling in shipment. It is doubtful that any pronounced deviation will occur when changing from one set of tubes to another in the VFO, since circuit design considerations guard against normal internal variances in the tubes. Occasional spot checks on both the 160 or 80 and the 40 meter bands against a frequency standard of reputable calibration accuracy will verify the VFO calibration accuracy. If the calibration is not accurate, proceed to recalibrate as directed in Section E.
12. Read Sections B, Theory of Operation; C, Tuning Procedure; and D, Pi Network Tuning and Harmonic Suppression, in order to gain familiarity with the equipment before continuing tuneup.
13. Tune up the transmitter on all bands 160 - 11 meters, following the procedure in Section C, checking for grid drive, proper loading and operation on all bands.
14. With the transmitter operating at normal full load (140 ma.) on "PHONE", check the "MOD" (modulator) plate current. It should read 55 to 70 ma. If the reading is not within this range, adjust the tap on resistor R35 - toward the panel for a lower current reading and away from the panel for a higher reading.

- A. 15. With the modulator current adjusted properly, the transmitter operating on "PHONE" and with microphone connected (left rear of cabinet, J1), advance the "AUDIO" gain control while speaking into the microphone. The "MOD" current should kick upward with voice peaks and the dummy light bulb should increase in brilliance. The current peak swings should not exceed 120-130 ma. for 100% modulation.
16. Operation of the clamper tube may be checked by leaving the transmitter on the phone or CW position, turning the VFO off by switching to an empty crystal socket position and watching the final plate current. The final plate current under excitation failure should be less than 50 ma.
17. After completing the initial testing of the transmitter, place it back into the cabinet, training the AC line cord through the proper opening. Gradually slide the chassis on the rails, carefully engaging the cabinet into the front panel; and checking the line cord clearance at the rear opening.
- Install the three tie rods, engaging the rods into the front panel loosely, but insuring a good start.
  - Install the eight self tapping screws around the periphery of the cutouts for the line cord and the output coax connector. Gradually tighten all eight screws securely while checking for proper engagement of the front panel and the cabinet.
  - Tighten the three tie rods securely.

The cabinet installation and transmitter set up are now completed.

## B. JOHNSON VIKING RANGER THEORY OF OPERATION

### 1. Viking Ranger block diagram.

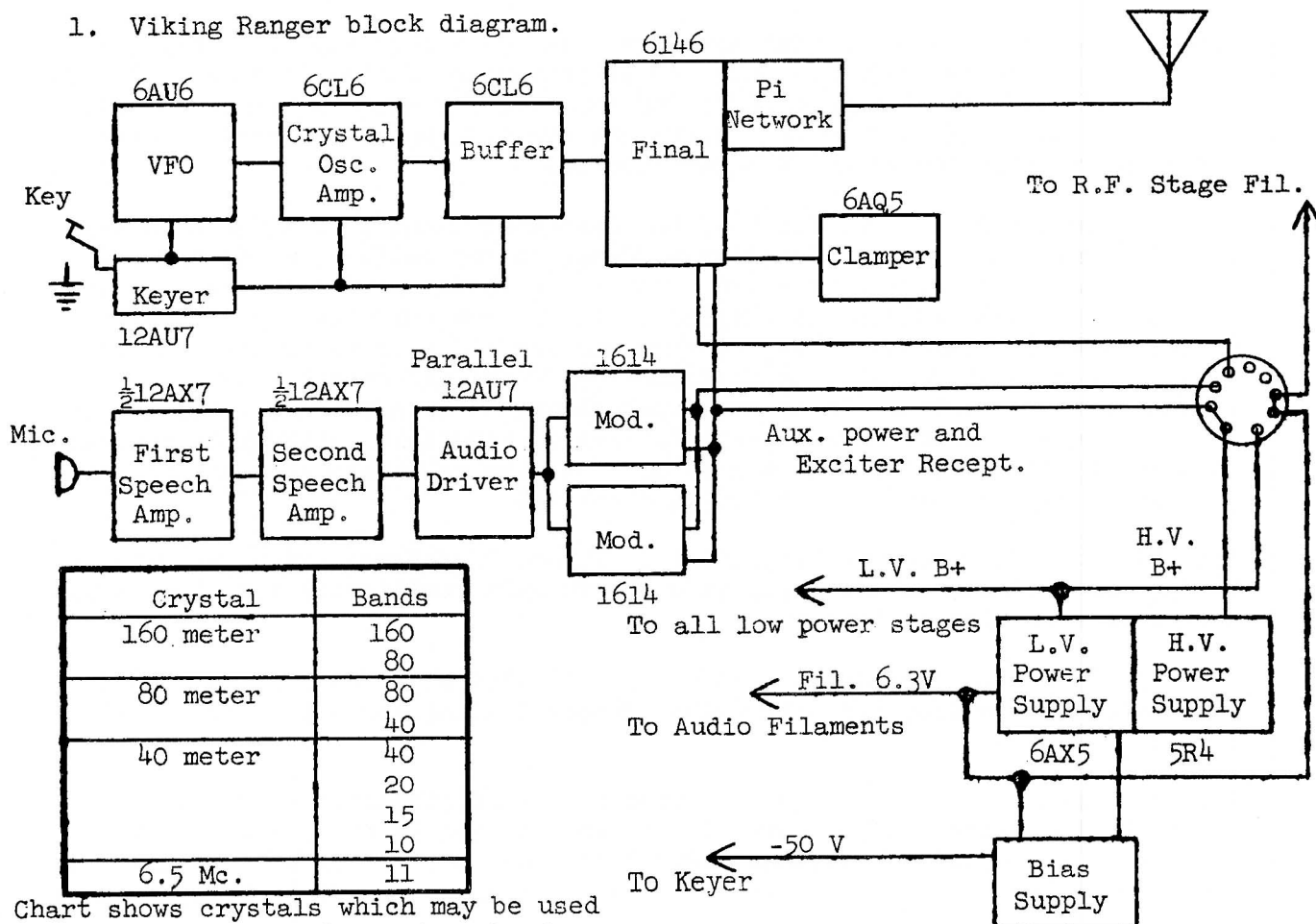

Chart shows crystals which may be used for full output on the amateur bands covered by the "Ranger."

3. The Variable Frequency Oscillator is patterned after the famous Johnson Model 122, employing a series tuned Colpitts circuit. Two separate tank circuits are employed. One tank circuit covers the 1.75 mc to 2.0 mc frequency range and the other tank circuit covers the 7.000 mc to 7.425 mc range. The VFO tank circuits and output circuits are controlled by the internal VFO switch SW1. This switch is mechanically linked with the band switch insuring the proper VFO output frequency for the band selected by the bandswitch. A high degree of stability is insured by proper circuit design, rigid construction, temperature compensation, and by voltage regulation in the VFO circuit. The plate circuit of the VFO is broad tuned to maintain a constant output level over the entire frequency excursion when employing the 40 meter tank. Additional circuit design considerations eliminate any interaction between the oscillator stage and succeeding stages in the RF exciter section.

On the 160M and 80M bands, the VFO output remains on the 160M tank. On the 40, 20, 15 and 10 meter bands the VFO output changes to the 40 meter tank. On the 11M band, an additional capacitor, C4, is switched across the 40M tank, to lower the VFO frequency to a harmonic relation to the 11M band. In "VFO" operation both the VFO and the first frequency multiplier are keyed for CW transmission.

4. Crystal oscillator - frequency multiplier stage. This stage employs a 6CL6 pentode tube of excellent RF characteristics. During VFO operation, this stage acts as an isolater-frequency multiplier, being broad tuned on all bands 160 through 20 meters. The plate circuit is band switched automatically by the band switch. During crystal operation, this stage replaces the VFO and acts as a hot cathode crystal oscillator. During "CRYSTAL" operation this stage is keyed for CW transmission.
5. Crystal - VFO switch. This switch selects either of two crystals that may be plugged into the crystal socket, X14, submounted at the front of the transmitter. In the XT1 position, a crystal connected between pin 3 and 5 of X14 is operative. In the XT2 position, the crystal connected between pins 1 and 7 is in use.
  - a. In the two crystal positions, XT1 and XT2, the switch disables the VFO and converts the first 6CL6 from an isolater-multiplier to a crystal oscillator and/or frequency multiplier.
  - b. In the "VFO" position, the switch places the VFO in operation and connects and converts the first 6CL6 from a crystal oscillator-multiplier to an isolater-frequency multiplier.
  - c. In the VFO "ZERO" position, it places the VFO in operation - plus whatever additional stages are required in each individual installation for a comfortable injection level into the receiver for positive zero beating purposes. A simple internal wiring change permits either the VFO alone or one or both of the 6CL6's to be energized in the VFO "ZERO" position.
6. Buffer Stage. This stage employs a 6CL6 RF pentode, employing a tuned high Q plate circuit, which is tuned to the same frequency as the final on all bands. This stage is protected against excitation failure by the cathode resistor R12. The buffer switch and coils are fully shielded to avoid any possible interaction. The drive control, R13, controls the screen voltage of this stage thus controlling its output and the final grid drive.



- B. 7. Final Amplifier. This stage employes a 6146 beam power amplifier with completely band switched pi-network plate circuit of Hi Q design. Great consideration and study has been made in the final coil assembly to maintain a constant Hi Q circuit for maximum degree of efficiency on all bands. The range of antenna impedances which may be matched on all bands is 50-500 ohms plus tuning out wide range of inductive or capacitive reactance. These output capacitance switching provisions are strategically located to avoid inductive loops coupling back to the previous stages. The range of antenna impedance which may be matched at frequencies above 7 mc extends, roughly, from 25 to 2000 ohms.
8. Clamper Tube. This stage employes a 6AQ5 tube to furnish protection for the 6146 final amplifier in case of excitation failure. With excitation failure, the 6AQ5, connected in shunt with the screen dropping resistor, conducts and lowers the screen potential to approximately plate current cut off in the 6146. The screen of the clamper is connected to a voltage divider making the stage continue to conduct even at extremely low plate potential values. Under this cutoff condition, it will be noticed that 35 to 40 ma. current is indicated on the meter. This is not plate current of the 6146 - it is the plate current through the series screen dropping resistor, R15, drawn by the clamper tube.
9. First and Second Speech Amplifiers. These stages employ a dual triode 12AX7 tube cascade connected with high gain design. Additional circuit design considerations control the response characteristics of these two stages. A three circuit microphone jack is provided to accommodate the addition of a push-to-talk relay, if so desired.
10. Audio Driver. This stage employes a 12AU7 dual triode, parallel connected and transformer connected to the modulator grids to furnish low impedance drive to the modulators.
11. Modulator. This stage employes a pair of 1614 transmitting type tubes, operating push-pull class AB. The modulators operate well within their ratings, and will deliver more than sufficient audio power for 100% amplitude modulation. Plate saturation limiting prevents large swings beyond full modulation thereby providing some limiting to reduce distortion and spurious output. The modulation transformer has a tertiary feed-back winding coupled to the grid of the audio power driver. This provides damping for improved regulation, stability and flat response and is particularly helpful in providing improved regulation for directly driving class B2 modulators when the Ranger is used as an exciter. The secondary winding of the modulation transformer is center tapped, to fill the requirements as an audio driver transformer when using the Ranger as an exciter, working directly into the grids of a pair of Class B modulators. These leads are filtered and by-passed, and made available at the exciter-auxiliary plug at the rear of the chassis. By using one-half of the secondary winding, a nominal 500-600 ohm output can be obtained for driving large speakers used in paging or public address work. 33 watts of audio are available at the output of the modulators for any application required.

The frequency response range of the modulator section is flat within 3DB from 250 to 3000 CPS with very pronounced roll off above and below these frequencies. The audio quality is pleasing, yet retains the extra audio punch desirable for communications effectiveness.

B. 12. Power Supplies. A dual voltage power supply, employing a 5R4GY HV rectifier tube and a 6AX5GT LV rectifier tube, furnishes the voltages required for the Viking Ranger. Both the high voltages and low voltages power supplies employ choke input filtering for improved voltage regulation. The high voltage supply will deliver 500 - 525 VDC for final modulators, and the low voltage supply delivers 300 - 320 VDC for the RF exciter and speech low level stages. A 6AL5, V14, is used as a bias rectifier to supply bias voltage for the keying circuits and modulator bias.

If it is desired to power an external equipment, power may be taken from the exciter-auxiliary plug. In addition to 33 watts of audio, there is available 6.3 VAC at 5.5 amperes for filament supply, 300 VDC at 50 ma. and 500 VDC at 210 ma. When the auxiliary plug is wired for external power, the complete RF section of the Ranger (including filaments) is de-energized - the power supplies cannot supply the normal Ranger full power requirements and external power simultaneously.

13. Keyer Control Circuitry. Grid-block keying is used on V1, V3 and V4. To avoid unnecessary interference with signals on adjacent channels, a wave-shaping filter consisting of R42-R43 and C89 is used on V3 and V4. To avoid chirp when the VFO is keyed, the keyer tube, V13, 12AU7, allows the VFO to start quickly - before V3 and V4 start conducting - and then continue operating until after V3 and V4 have stopped conducting.

The VFO keyer adjust control, R39, adjusts the "hold" time for VFO operation after the key is opened. This may be adjusted to cutoff the VFO between marks of keyed characters thus allowing rapid CW break-in operation by enabling the operator to be aware of incoming signals while he is keying the transmitter. When operating in this fashion, the slight arcing at the key may be noticed as a click in the local receiver only. It is not on the carrier. It can be reduced by installing a 2 1/2 millihenry RF choke (the ordinary receiver type) in each key lead as close to the key as possible, to reduce radiation of the spark energy by the key leads.

14. Operate Switch. This switch, located to the left of the VFO escutcheon, is a dual ceramic wafer rotary switch that provides the following functions:

- a. "Off" position. No voltages applied to any circuits.
- b. "Tune" position.

- (1) Turns on all filaments, dial light, meter light.
- (2) Turns on low and hi voltage power supplies.
- (3) Leaves screen voltage off modulators.
- (4) Disables final amplifier.

- c. "Phone" position.

- (1) Turns on HV indicator light.
- (2) Places final amp in operate condition.
- (3) Applies screen voltage to modulators.
- (4) Applies 117VAC to ANT relay jack.

- d. "Stand-by"

- (1) Turns off HV indicator light.
- (2) Disables final.
- (3) Turns off modulator screen source.
- (4) Turns off 117VAC power to ANT relay jac.
- (5) Disable exciter.

B. 14. e. "CW"

- (1) Turns on HV indicator light.
  - (2) Short circuits modulation transformer secondary.
  - (3) Leaves screen source off modulators
  - (4) Places final into operating condition.
  - (5) Applies 117VAC to ANT relay jack.
- f. The antenna relay jack in supplying 117VAC for external relay control is ideally suited to handle the switch functions of a larger final when the Viking Ranger is used as an exciter.
- g. The problem of disabling the audio of a larger modulator in the "CW" position is partially solved since the grids would be short circuited when the Ranger is in the "CW" position as an exciter. In addition, the secondary of the high-powered modulator should be shorted on "CW".

C. VIKING RANGER TUNING PROCEDURE

1. NOTICE! The regulations of the Federal Communications Commission require a suitable license for operation of this equipment. Refer to publications of the Federal Communications Commission or the American Radio Relay League for the latest rules governing station and operator licensing.

Be sure to return the enclosed warranty registration card. This will register your transmitter at the factory. If it becomes necessary to write to the factory regarding your transmitter, refer to it by serial number.

The tuning procedure for the Viking Ranger is identical on all bands of operation, 160 through 10 meters. Therefore, the discussion of tuning on one band will apply to all bands. Only the dial and switch settings will change when going from one band to another. A 40-75 watt light bulb should be used as a dummy load.

2. Set all knobs on the settings given below:

- a. Operate switch, "OFF" position.
- b. Drive control on "#5" position.
- c. Xtal - VFO SW on "VFO" position.
- d. VFO - Pointer mid scale (7.215 mc).
- e. Band switch, "40" meters.
- f. Auxiliary coupling switch, position "5".
- g. Coupling, position "5".
- h. Meter switch, "GRID" position.
- i. Audio, "0" position.

3. With the dummy load attached to J3, the transmitter connected to an adequate ground, and the AC plug in the 117VAC 60 CPS receptacle, all knobs set on the positions given above, tuning on 40 meters is accomplished as follows:

- a. Turn the Operate switch to the "TUNE" position. The meter should be illuminated and the VFO dial lighted. After a normal warm up period, tune the "BUFFER" tuning knob for an indication of grid current on the meter. Adjust the drive control for a reading of 2.5 ma. on the center scale which reads 0-10 ma.

NOTICE !!

DO NOT EXCEED 4 MA GRID CURRENT UNDER ANY  
CIRCUMSTANCES OR 3 MA FOR PROLONGED PERIODS OF TIME

C. 3. b. Keyer Control Adjustment.

- (1) Couple the VFO output to a receiver (OPERATE switch in CW position).
  - (2) Close key and tune receiver to a VFO signal.
  - (3) Open key.
  - (4) Turn VFO keyer adjust control, R39, counter-clockwise until VFO signal starts.
  - (5) Turn VFO keyer adjust control, R39, clockwise just slightly beyond the point at which the VFO signal stops. Adjustment in the extreme clockwise position may cut off the VFO too soon and result in "squaring" or "sharpening" of the keying envelope at the break with attendant clicks.
- c. Turn the Meter switch to "PLATE" position.
- d. Turn the Operate switch to "PHONE" position and immediately tune the "FINAL" tuning knob to plate current dip (resonance) on the plate current meter.
- e. Increase the loading on the final by adjusting the Coupling controls. After changing the Coupling controls, return the final dip (plate resonance) on the meter. Successively adjust these controls (always dip final last) until a plate current of 130 ma. is read on the top meter scale, 0-200 ma. On CW (key down), the plate current should be 140-150 ma.
- f. This completes the tuning and loading of the transmitter on the 40 meter band, phone or CW operation. Operation on other bands merely requires switching the bandswitch to the desired band and adjusting of the Buffer, Final, and Coupling controls to obtain proper final amplifier loading. As previously listed, proper loading is obtained at a plate current of 140 - 150 ma. on CW and 130 ma. on Phone. The drive control should be adjusted to provide a grid current of 2.5 ma. on all bands when the final is fully loaded at the above values.
- g. The following table of dial settings gives the approximate dial settings for fully loaded operation into a 52 ohm non-inductive load:

Line Voltage 117.5 VAC Phone Operation 52 Ohm Coax Load				
Frequency Megacycles	Buffer Tuning	Final Tuning	Auxiliary Coupling	Coupling
29.700	64	84	7	5.25
28.000	51	77	7	5.5
27.250	44	78	7	5.5
26.900	40	76	7	6
21.450	69	71	7	4.5
21.000	62	69	6	7.5
14.350	44	63	7	3.5
14.000	39	61	6	7
7.300	52	46	5	4
7.000	43	27	5	2
4.000	84	71	4	4
3.500	43	37	3	5
2.000	62	80	6	5
1.750	13	48	5	5

- C. 3. g. It should be borne in mind that reactances at the feed point, or impedances different than the 52 ohms used in compiling the chart on opposite page will cause a change in all the dial settings except buffer tuning.

#### D. VIKING RANGER PI-NETWORK TUNING AND HARMONIC SUPPRESSION

The pi-tuning/coupling network in the Viking Ranger is designed to load the final amplifier into antenna resistances of nominally 50 to 500 ohms throughout the frequency range of the transmitter. In addition, it is capable of "tuning out" series antenna reactances up to several hundred ohms to complete a good match to most unbalanced antenna systems. The range of antenna impedances which may be matched by the pi-network at frequencies higher than 7.0 mcs. extends from roughly 25 - 2000 ohms.

When the transmitter is well grounded and properly tuned, the higher harmonic suppression is excellent, generally much better than with other conventional methods of antenna coupling. This should be of interest to amateurs afflicted with TVI or other high frequency interference problems.

##### 1. Importance of grounding:

To obtain proper tuning, coupling and harmonic suppression with any transmitter antenna coupling system, the part of the circuit designed to operate at RF ground potential must be at RF ground potential. A "room full of RF" is evidenced that a high RF potential exists on something in or near the room. In many cases the source of RF is the transmitter's chassis and power cord. This condition is very undesirable for several reasons. The power cord is very closely coupled to the chassis by the electrostatic shields of the power transformers. Three objectional factors which obviously affect the loading of the transmitter when poor grounds are involved are:

- a. The impedance that the output terminal of the transmitter looks into includes not only the true antenna to ground impedance as presented by the antenna feedline but also the transmitter chassis to ground impedance. This additional impedance in some cases will raise the apparent antenna impedance to such a high value that it cannot be loaded by the pi-network.
- b. Part of the transmitter's power is lost in the ground system due to radiation of the ground lead, power cord or cabinet. This power is quickly dissipated in surrounding objects and contributes nothing to effective radiated power except to distort the antenna's normal field pattern.
- c. It is conventional, in designing a transmitter, to by-pass harmonics or any possible sources of stray high frequency currents to the chassis on the assumption the chassis will be kept as near ground potential as possible. When a high impedance is presented to these currents at the chassis they are able to radiate to some extent rather than be passed harmlessly to ground.

##### 2. How to obtain a good ground:

What may appear to be a good ground at one frequency may prove to be a poor ground at another. A single ground lead may have "standing waves" on it due to its length. While it may seem difficult to obtain a good ground over a wide range of frequencies, it can be done and will be well-worth the trouble when increased radiation efficiency, ease of antenna loading, and reduced TVI and BCI result. There is also reduced danger of damaging microphones, receivers, and other associated equipment with excessive RF fields.

- D. 2. Avoid using the power line, power line conduit or gas lines for RF grounding. Some suggestions which may help to obtain a good ground are:
- a. Water pipes or metal building structural members are usually good sources of earth grounds.
  - b. Use heavy conductors (#14 or larger) between the connection at the ground point and the transmitter. Copper ribbon is excellent for this purpose.
  - c. The use of several ground leads, each of a different length and selected at random may be helpful in keeping grounding impedance low at the transmitter, even though the transmitter is some distance from a true earth ground. The possibility of obtaining an effective ground at any frequency throughout the transmitter's range is quite good. If at any one frequency, one of the ground leads presents a low impedance at the chassis, the chassis is effectively grounded. By changing the length of one of the ground leads experimentally, a good ground can often be obtained at a frequency which has been troublesome. In bringing several leads to the transmitter, small closed loops near the transmitter or antenna feed line should be avoided. Induction fields will tend to raise the impedance of the ground leads.
  - d. In cases where it is impossible to obtain a good earth ground, connecting the transmitter chassis to some system of conductors having a very low effective impedance to ground compared to the antenna impedance may be helpful. Usually this artificial "ground" takes the form of a system of radial wires spread horizontally on the floor, a gridwork of wires, or a large metal sheet on the floor below the transmitter. To be most effective, the minimum area covered by the metal conductors should be roughly equivalent to a square, the length of one side of which approaches a quarter wavelength. This system of "grounding" should be experimented with before committing the location of any permanent installation.
  - e. A simple counterpoise made up of a single wire attached to the chassis may be helpful. On 10 meters, a length of 6 to 8 feet may be attached and the open end cut off 4 inches at a time until the chassis becomes "cold". The open wire may be allowed to drop along the floor although its open end will be somewhat "hot".
  - f. A rough check on the effectiveness of the transmitter ground may be made by touching the chassis while watching the PA plate current and grid current with the transmitter operating into an antenna. A change in current upon touching the chassis is indicative of an ineffective ground. If a neon bulb, held between the fingers, can be ignited by touching it to the chassis, the RF present is excessive and is another indication of an ineffective ground. In cases where the transmitter is feeding a low impedance antenna, the test by touching the chassis is more reliable since 50 to 60 volts is required to ignite the neon lamp.

### 3. Loading Random Antennas with the Pi-Network:

With the transmitter chassis well grounded, correctly designed antenna systems having relatively "flat" unbalanced feeder systems, can easily be loaded by following the instructions already given, provided the antenna terminal impedances fall within the range of the pi-network. Feeding a balanced system with a feedline over a quarter of one wavelength long, may prove to be surprisingly successful if the transmitter chassis is held at ground potential. The transmission line between the transmitter and antenna will tend to assume a partial balance at the antenna. Some standing waves will result but may not be excessive. The Johnson Viking Matchbox, a universal all band, bandswitched antenna coupler will permit loading of the Viking Ranger transmitter to any practical antenna system. In addition, it provides for the use of the Johnson 250-20 Low Pass Filter for increased harmonic suppression.

- D. 3. Antennas having random lengths, random feed points and various types of feed lines will exhibit widely different resistance and reactance characteristics. It is well to remember that the feedline is a very important part of the system. A common example of the random antenna is a horizontal wire fed by a single wire feed line. The feed line in this case actually becomes part of the radiating system. An antenna of this type can, in most instances, be fed by the pi-network directly but there are critical dimensions where the antenna resistance can become either too high or too low to be matched by the pi-network.

Antennas with high terminal resistance or reactance can usually be recognized while loading the final stage of the Viking Ranger. The final amplifier is normally loaded by reducing the output coupling capacitor, C9, in small steps, returning the amplifier to resonance each time. This results in an increase in PA plate current and is continued until full loading is achieved. If, however, a point is reached where decreasing the output coupling capacitor, C9, does not result in a marked increase in PA plate current and the PA is not fully loaded, the antenna can be assumed to have a high resistance or reactance at this frequency.

Antennas with low terminal impedance (resistance and reactance both low) can usually be recognized by a noticeable lack of coupling condenser effect in the range of settings normally used at the operating frequency. There will be little or no detuning evidenced as the coupling control is changed.

Several things can be tried in an effort to bring the antenna system into the tuning range of the pi-network:

- a. Change the length of the feeder line between the antenna and transmitter experimentally  $1/8$  to  $1/4$  wavelength.
- b. Change the point of connection of the feedline to the antenna  $1/8$  to  $1/4$  wavelength.
- c. Change the antenna length  $1/8$  to  $1/4$  wavelength. Antennas shorter than  $1/8$  wavelength (antenna and feeder) may be difficult to load. They present a high capacitive reactance to the transmitter output terminals. Effective antenna lengths in the vicinity of  $1/2$  wavelength will in general exhibit characteristics of high resistance, high reactance, (inductive or capacitive), or both.
- d. "Load" the antenna feeder by placing an inductor or capacitor in series to cancel out the reactance of the antenna feeder. This may require considerable cut and try and will affect only the reactive component of the antenna impedance. However, it can prove useful in some cases.
- e. L type matching networks of inductance and capacitance may be used to aid impedance matching. Much discussion of this more elaborate method of bringing the antenna impedance within the range of the pi-network could be included, however, the few cases where it is necessary do not justify inclusion herein. Textbook and handbook discussions will be helpful if work along this line is pursued. There is danger of resonating the coupling condenser of the pi-network when using an external coil. This should be watched as excessive voltage built up across the coupling condensers can cause damage. Improper coupling or loading will take place under these conditions.

D. 4. Dangers to be avoided and hints which may further aid in harmonic and TVI reduction.

- a. When loading high impedance antennas there is a temptation to "squeeze" the last watt into the antenna by opening the coupling condensers as much as possible. Harmonic suppression is dependent, to a great extent, on the amount of coupling capacity in the circuit. It is wise to use as much coupling capacity as practical at all times. The proper amount of coupling when the antenna impedance is high, can be conveniently determined by holding a neon lamp against the antenna feeder. The coupling condenser can then be opened until little increase in glow is noticed when the coupling condenser and tuning controls are adjusted for maximum output. A decrease in coupling capacitance beyond this point may cause a higher plate current reading due to reduced plate circuit efficiency. Higher harmonic output will also result as the coupling capacity is reduced beyond the point where the output has leveled off. The random antenna system may present a more favorable impedance to harmonic output than the output on the fundamental frequency; hence it is well to use as much coupling capacity as is practical. It is well to remember that the amount of coupling capacitance needed is dependent on the operating frequency. For example, 2,000 micro microfarads at 3.5 mcs. corresponds to 160 micro microfarads at 28.0 mcs. These are the values necessary to couple resistive loads of approximately 50 ohms, at the frequencies stated.
- b. If the power line voltage is low or the high voltage rectifiers have low emission, the loaded plate current may not reach the normal value. This condition should not be confused with the inability of the pi-network to load an antenna system.

5. Coupling to balanced antennas:

Balanced antennas such as center fed "Zepps", beams and folded dipoles normally use a two wire transmission line and should have equal voltages, 180 degrees out of phase, applied to each feedline terminal. Since the output of the Viking Ranger is single ended, unbalanced, a coupler is required for balanced antenna systems. The Johnson Matchbox, a universal all band, band-switched antenna coupler will permit loading of the Viking Ranger to any practical antenna system. In addition, it provides for the use of the Johnson 250-20 Low Pass Filter for increased harmonic suppression. A simple coupler for this purpose is shown below. The tank circuit is resonant at the operating frequency and can be excited by a coaxial line and coupling link. Line impedance is not critical although 52 ohm line will be most desirable if a Johnson Low Pass Filter is to be used.

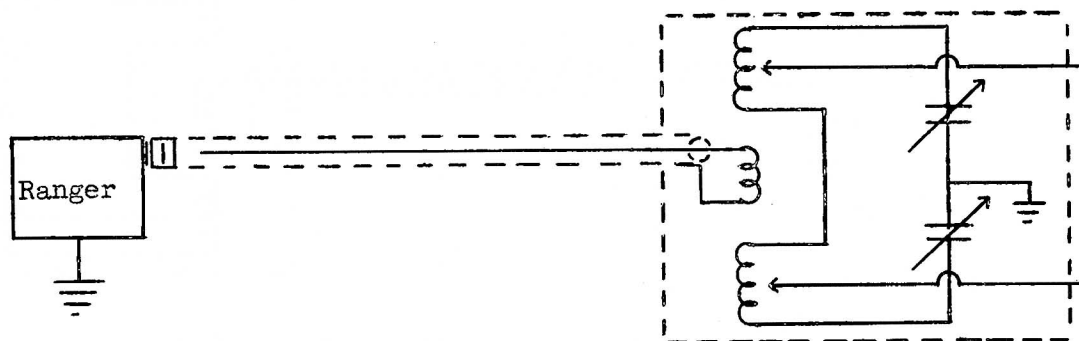

Feedpoint impedance of the coupler is adjusted by means of the inductor taps. Tap adjustment is unnecessary with the Johnson Matchbox. Final amplifier loading is adjusted with the transmitter output coupling controls.



- D. 5. Tuning of the coupler can be made quite broad by making the L/C ratio as high as possible (low "Q") while still permitting the desired loading. Inductive reactance of the coupling link may make it impossible to reduce the SWR of the coaxial line to or below 1 1/2 to 1. If so, the link circuit may be made series resonant by adding capacitor C1 as shown below:

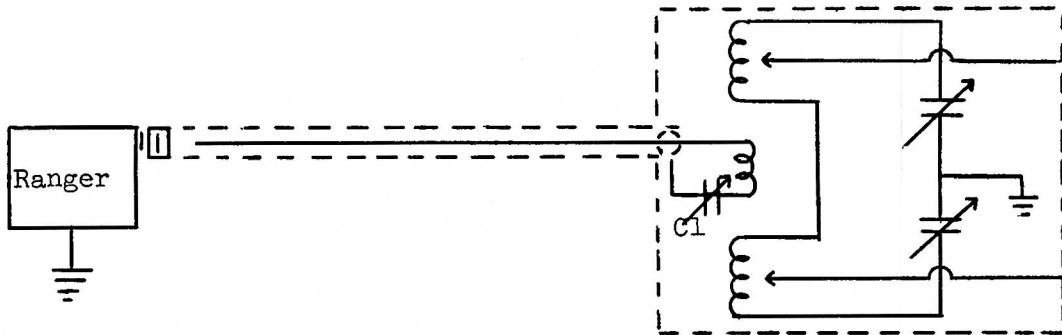

The above problem is non-existent with the Matchbox.

6. Use of Low Pass Filters:

Depending upon how it is tuned, 2nd harmonic attenuation of the Viking Ranger amplifier can be as high as 30 db. Since this will permit operation in many locations without television interference, the Johnson 250-20 Low Pass Filter is not an integral component of the Viking Ranger but is available as an optional accessory. This filter will provide an additional 75db or more harmonic attenuation with insertion loss less than .25 db. Characteristic impedance is 52 ohms, power rating 1 KW. The low pass filter may be inserted in the coaxial line between the transmitter and the antenna coupler. Coaxial connectors are used at the transmitter and at both ends of the low pass filter to preserve the shielding provided by the coaxial line. It is preferable that the standing wave ratio on the coaxial line be maintained at 2 to 1 or less, therefore the impedance of the line between the Viking Ranger and the coupling link should be the same as the characteristic impedance of the filter. (The Johnson 250-20 Low Pass Filter and Johnson Matchbox are 52 ohm impedance.) The section of coaxial line between the transmitter and the low pass filter should be as short as possible and electrical quarter waves should be avoided. An RF bridge such as the Johnson 250-24, for measuring SWR will prove invaluable for both initial set-up and for operational checks.

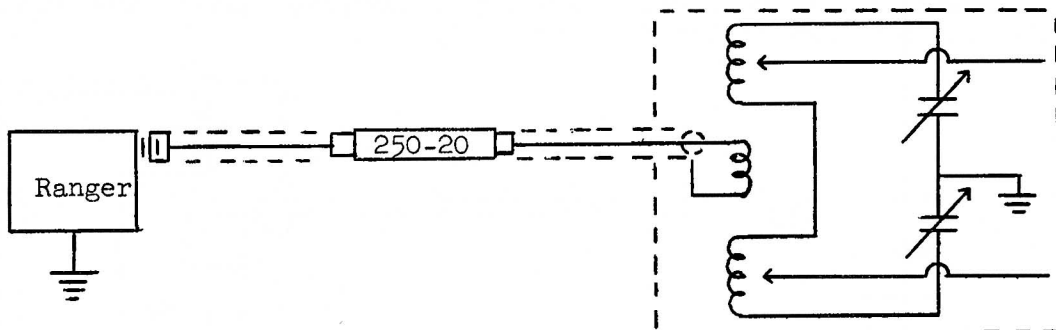

An end fed half-wave antenna may present loading problems, both from the standpoint that its impedance is higher than can be matched by the pi-network amplifier of the Viking Ranger, or that the low output coupling capacitance used reduces inherent harmonic attenuation below tolerable values.

D. 6. Therefore, the use of a half wave antenna may create TVI problems, while other antennas prove perfectly satisfactory. In these cases, it is recommended that the Johnson Matchbox be used.

#### E. VFO CALIBRATION PROCEDURE

1. Signal generator, receiver, and VFO setup for the Viking Ranger VFO calibration.

a. The accuracy of the Viking Ranger VFO will be no better than that of the signal generator used to calibrate it. To fully utilize the stability and calibration capabilities of the VFO, the frequency standard used to calibrate it should have an accuracy of .005% or better. Most crystal standards or crystal calibrated variable frequency standards are satisfactory for normal calibration purposes. A moderate signal output, capable of being easily detected by the receiver to be used for zero beat indication, is necessary at the following frequencies:

F1a Any given frequency (preferably a VFO low frequency scale mark frequency) between 1.75 to 1.78 mc or any of the first eight harmonics of 1.75 to 1.78 mc in the range of the receiver. 1.76, 3.52, 5.28, 7.04, and 8.80 mc are good calibrating frequencies.

F2a Any given frequency (preferably a VFO low frequency scale mark frequency) between 1.96 and 2.00 mc or any of the first eight harmonics of 1.96 to 2.00 mc in the range of the receiver. 1.97, 3.94, 5.91, 7.88, and 9.85 mc are good calibrating frequencies.

F3a Any given frequency (preferably a VFO high frequency scale mark frequency) between 7.00 and 7.07 mc or any of the first four harmonics of 7.00 to 7.07 mc in the range of the receiver. 7.03, 14.06, 21.09, and 28.12 mc are good calibrating frequencies.

F4a Any given frequency (preferably a VFO high frequency scale mark frequency) between 7.35 and 7.425 or any of the first four harmonics of 7.35 and 7.425 mc. 7.40, 14.800, 22.2, and 29.6 mc are good calibrating frequencies.

- b. Warm up the signal generator for at least 1/2 hour or as long as suggested by the signal generator instructions before using it for VFO calibration.
- c. Set up a receiver capable of detecting each of the frequencies chosen in 1a. Attach antenna leads to the receiver input and the signal generator output and bring the leads together until signal generator output can be picked up by the receiver. Separate and shorten the leads as found necessary to keep the receiver from blocking due to excessive signal input. Allow the receiver to warm-up for about 1/2 hour to stabilize the local oscillator, and log dial settings for frequencies F1a, F2a, F3a and F4a. The beat frequency oscillator in the receiver may be used to log and compare the signal generator and VFO frequencies but it is desirable to obtain the final zero beat indications between the VFO and signal generator signals without the beat frequency oscillator. Avoid setting the receiver on or logging image frequencies.
- d. Warm-up the Viking Ranger in the "Tune" position for 1/2 hour. Turn the bandswitch to the 160 or 80 position. Turn the VFO dial pointer to the frequency F1, between 1.75 and 1.78 mc., chosen as the low 160 meter calibrating point, and find it or its harmonic (near F1a) on the receiver. Repeat the same procedure at the high 160 meter calibrating point and the 40 meter high and low points after moving the Bandswitch to the 40 meter position.

E. 2. 160, 80 meter VFO scale calibration

- a. Set the Bandswitch on the 160 or 80 meter position and the dial at F2, the frequency between 1.96 and 2.00 mc chosen for the high 160 meter calibrating point. Set the signal generator and the receiver at F2a. Adjust the "160 hi" trimmer at the top of the VFO (refer to Figure 11) until the VFO zero beats with the signal generator.
- b. Turn the VFO to F1, the receiver to Fla, the signal generator to Fla, and adjust the "160 lo" padder until the VFO zero beats with the signal generator.
- c. Repeat the "160 hi" and "160 lo" adjustment, zero beating the signal generator and VFO as accurately as the ability to reset the two units warrants.

3. 40, 20, 15, 10 meter VFO scale calibration

- a. Set the Bandswitch on the 40 or 20 meter position and the dial pointer at F4 on high frequency dial scale, the frequency between 7.35 and 7.425 mc chosen for the high 40 meter calibration. Set the signal generator and the receiver at F4a. Adjust the "40 hi" trimmer at the top of the VFO until the VFO zero beats with the signal generator.
- b. Turn the VFO to F3, the frequency between 7.00 and 7.07 mc chosen for the low 40 meter calibration, the receiver to F3a, the signal generator to F3a, and adjust the "40 lo" padder until the VFO zero beats with the signal generator.
- c. Repeat the "40 hi" and "40 lo" adjustment, zero beating the VFO as accurately as the ability to reset the two units warrants.

4. 11 meter calibration

- a. The 11 meter band VFO output is in the neighborhood of 6.75 mc. A given frequency, F5A, in the range 6.7 to 6.85 mc or any of the first four harmonics of the 6.7 to 6.85 mc range may be used to calibrate the 11 meter range. Turn the bandswitch to the 11 meter position and set the dial pointer on the standard frequency F5 or the harmonic of the standard signal which falls in the 11 meter band. Set the receiver to the 11 meter range or a sub-harmonic and detect the standard signal frequency. Adjust the "11 meter" trimmer until the VFO zero beats with the standard frequency.
- b. Recheck the 40 or 20 calibration after the 11 meter adjustment. There is little likelihood that further re-adjustments are necessary unless a large change was required in the "11 meter" setting.

5. VFO Calibration Using the Transmitter Crystal Oscillator or other Standard Signal Sources.

- a. Crystals of known frequency and accuracy in the frequency ranges Fla, F2a, F3a and F4a (designated in paragraph E1a) can be used in the transmitter crystal oscillator to provide standard frequency signals for the VFO calibration. The stability of the receiver local oscillator and beat frequency oscillator must be nominally good as the technique of beating the receiver BFO to the crystal and then beating the VFO signal to the receiver will be used. The receiver thus "remembers" the crystal frequency. Reduce the coupling of the receiver antenna to the minimum usable amount to avoid "pulling" the receiver local oscillator.

- E. 5. b. An example of calibrating the VFO using actual crystal values may be helpful. Assume that the following crystals have been found as part of the amateur station equipment: 7060 kc, 3690 kc, and 1980 kc. The dial calibration points then become:

$$F1 = \frac{7.060}{4} = 1.765 \text{ mc.}$$

$$F2 = 1.980 \times 1 = 1.980 \text{ mc.}$$

$$F3 = 7.060 \times 1 = 7.060 \text{ mc.}$$

$$F4 = 3.690 \times 2 = 7.380 \text{ mc.}$$

The receiver setting and VFO harmonic which may be used for each respective dial calibration frequency becomes:

$$F1a = 7.060 \times 1 = 7.060 \text{ mc.}$$

$$F2a = 1.980 \times 4 = 7.920 \text{ mc.}$$

$$F3a = 7.060 \times 1 = 7.060 \text{ mc.}$$

$$F4a = 3.690 \times 2 = 7.380 \text{ mc.}$$

Proceed as follows:

- (1) Place the 1.980 mc. crystal in the XT1 position and the 7.060 mc. crystal in the XT2 position.
  - (2) Set the Bandswitch on 160 or 80 meters, the VFO dial pointer on the 1.980 mc. mark, the Crystal-VFO switch to the 1.980 mc. crystal position (XT1). Tune the receiver to zero beat the BFO with the crystal. Turn the Crystal-VFO switch to "VFO" and adjust the "160 hi" trimmer to zero beat the BFO.
  - (3) Set the VFO pointer on the 1.765 mc. mark, and the Crystal-VFO switch to the 7.060 mc. position (XT2). Tune the receiver to zero beat the VFO with the crystal. Turn the Crystal-VFO switch to "VFO" and adjust the "160 lo" padder to zero beat the BFO. Repeat steps (2) and (3) to minimize adjustment interaction.
  - (4) Remove the 1.980 mc. crystal and replace it with the 3.690 mc. crystal in the XT1 position.
  - (5) Set the Bandswitch on 40 meters, the VFO dial pointer to 7.380 mc., and the Crystal-VFO switch to XT1. Tune the receiver to zero beat the BFO with the crystal. Turn the Crystal-VFO switch to VFO and adjust the "40 hi" trimmer to zero beat the BFO.
  - (6) Set the VFO pointer on 7.060 mc. and the Crystal-VFO switch to XT2. Tune the receiver to zero beat the BFO with the crystal. Turn the Crystal-VFO switch to VFO and adjust the "40 lo" padder to zero beat the BFO. Repeat steps (5) and (6) to minimize adjustment interaction.
  - (7) The 11 meter band setting may be made with a crystal which will place a harmonic signal in the 11 meter band. Set the Bandswitch on 11 meters, the Crystal-VFO switch to the crystal (assume 1.810 mc is available) position. Zero beat the receiver BFO to 27.150 mc (the 15th harmonic of 1.810 mc). Turn the Crystal-VFO switch to "VFO" and adjust the "11M" trimmer to zero beat the VFO to the receiver BFO.
- c. The user may think of several sources of standard signals other than those mentioned. In each case, the accuracy of the source should be known before using it. Many combinations of harmonics can be found and no attempt has been made to cover all of them in this discussion. Other signal sources which may be used but have not been discussed are:

- E. 5. c. (1) The signal of another amateur station whose frequency has been determined by a standard.  
(2) The harmonics of a signal generator whose output signal has been zero beat with a broadcast station.  
(3) Signals of W W V discussed in the next topic.

The VFO user must adapt his techniques to the signal source he has available.

- d. Band edge crystals or crystals near the usual operating frequencies of the amateur stations are always valuable for occasional monitoring of the VFO signals. They may be used in a separate oscillator circuit or the crystal oscillator stage of the transmitter.
6. VFO calibration using the W W V 10 mc signal. This calibration is not recommended if other standard signal sources are available. It will be noted that most calibration points are on the ends of the bands and the 40, 20, 15 or 10 meter band high scale calibration includes the tracking error of the low frequency 160, 80, or 40 meter band. The receiver, the receiver BFO, and the VFO should be warmed up for 1/2 hour before calibrating.
- a. 160, 80 meter calibration.
- (1) Zero beat the receiver BFO to the 10 mc W W V signal.
  - (2) Set VFO dial pointer to 2.00 mc and the Bandswitch on 160 or 80 meters.
  - (3) Adjust the "160 hi" VFO trimmer until the fifth harmonic of the VFO is zero beat with the receiver BFO.
  - (4) Leaving the VFO at this setting, zero beat the receiver BFO with the seventh harmonic of the VFO (14 mc).
  - (5) Turn the VFO to 1.75 mc and adjust the "160 lo" VFO padder to zero beat the eighth harmonic of the VFO with the receiver BFO.
  - (6) Adjust both ends of the 160 or 80 meter bands to zero beat the eighth and seventh harmonics of the VFO with the receiver BFO as necessary.
- b. 40, 20 15, 10 meter calibration
- (1) Set the VFO dial at the 1.85 mc mark and zero beat the receiver BFO to the eighth harmonic of the VFO frequency at 14.8 mc.
  - (2) Set the Bandswitch to 40 meters and the dial pointer to the 7.40-29.6 mc mark. Zero beat the second harmonic of the VFO to the 14.8 mc receiver setting by adjusting the "40 hi" trimmer.
  - (3) Set the bandswitch and dial pointer for 1.75 mc output again and zero beat the receiver BFO at 14 mc. Set the bandswitch and dial at the 40 band low frequency end (7.00 mc) and adjust the "40 lo" padder to zero beat the VFO second harmonic with the receiver 14.0 mc BFO setting.
- c. 11 meter calibration
- (1) Set the Bandswitch and dial for 1.80 mc output.
  - (2) Tune the receiver to 27 mc and zero beat the receiver BFO to the 15th harmonic of the VFO.
  - (3) Set the Bandswitch on 11 and the dial pointer on 27.0 mc. Adjust the "11 meter" trimmer to zero beat the fourth harmonic of the VFO to the receiver BFO setting.

- E. 7. Things to look for if the VFO frequency cannot be adjusted to the dial markings due to apparent lack of trimmer or padder range.
- a. Check to make certain the frequency standard used is accurate (crystals used in amateur service are often found to differ from their marked frequency due to holder conditions, oscillator circuit loading, or non-critical original calibration).
  - b. Make certain image frequencies are not being mistaken for desired frequencies in the receiver.
  - c. If, after checking the frequency standard and receiver settings, the VFO frequency cannot be adjusted to chosen dial marks, adjust the trimmers and padders to bring the VFO frequency as close as possible to the dial mark frequencies. Remove the VFO side cover and recheck the dial location relative to the tuning condenser shaft. The VFO tuning condenser should be exactly meshed (not necessarily the stop position) when the dial pointer is at the left horizontal position. If the dial requires relocating, try calibrating the VFO scale again, as directed in previous instructions, with the side covers on.

F. EXCITER OPERATION, FOR ZEROING, PUSH-TO-TALK

1. Instructions for using the Johnson Viking Ranger as an exciter and audio driver. To utilize the Ranger as an exciter rather than as a transmitter, no internal changes are required, as can be seen by studying the schematic diagram at the rear of this manual. The exciter-auxiliary power socket, a 9-pin octal style socket, makes all the internal sources of operating potentials readily accessible with all outgoing leads filtered and by-passed for TVI suppression.

The audio output of the modulator section can be coupled directly into the grids of a high powered modulator by observing the following steps in making connections to the exciter-auxiliary power plug:

- a. Using shielded leads, and not exceeding runs of 26 feet in length, connect the two modulator grids to pins 2 and 3 of the plug. Shields should be connected to pin 9. If runs exceeding 25 feet in length are anticipated, connections can be made to terminals 1 and 2, and a 500 - 600 ohm to push-pull grids transformer used at the modulator. This transformer must be a driver type if the modulator is operated class AB2 or class B2.
- b. Connect the bias supply to pin 1 of the plug to furnish bias on the modulator grids, using a shielded lead. The shield should be connected to terminal 9 which is chassis ground at the Ranger exciter. If a separate line of grid transformer is used, the bias must be supplied through the center-tap of this transformer.
- c. Connect jumpers from pins 7 to 8 (for filaments) and from pins 5 to 6 (for H.V. to final).
- d. RF excitation can be obtained at the coax connector J3 at a level depending upon the requirements of the external amplifier. Continuous control is easily accomplished by merely varying the "DRIVE" control on the Viking Ranger. A maximum of 40 to 45 watts output is available on Phone and 45-50 watts on CW under normal line voltage conditions. When connected to the external amplifier which is being driven, the Ranger should be loaded to provide slightly more than the required grid drive on the external amplifier (the Ranger should be dipped, of course, at this loading point with the Ranger grid current at the normal value of 2.5 ma.). The drive control on the Ranger should then be turned counter-clockwise (toward zero, thus reducing the power output of the Ranger) to obtain the specified drive to the external amplifier.

F. 2. VFO Injection in Receiver - Control of

As normally wired, the "CRYSTAL-VFO" switch "ZERO" position energizes the VFO and the first 6CL6, V3, when it is desired to zero beat an incoming received signal. Dependent upon the individual station setup (relative location of transmitter, receiver, transmission lines, etc.), it may be desired to either increase or decrease the injection level which is accomplished as follows:

- a. To increase injection, place a short jumper between clips 11 (normally not connected) and 12 of the forward wafer of the Operate switch, SW4A. These clips are accessible from the top of the chassis. This change adds the buffer 6CL6, V4, in the "ZERO" position.

3. Push-to-talk Addition (see following page for schematic diagram)

- a. Procure the relay, two 20,000 ohm resistors, a 5 mfd 250 VWDC condenser, a VHF choke and the .005 bypass condenser as indicated on the schematic diagram.
- b. Attach the relay on the top side of the chassis between V3 and V4, shown in Figure 1, taking care to clear parts when drilling the mounting holes and a clearance hole for two insulated leads, in the chassis. Install a solder terminal at one of the mounting feet, on the topside of the chassis.
- c. Connect one of the 20,000 ohm resistors between terminal 2 (the second from the rear) of terminal strip X15 (to left of socket X12) and terminal 2 (the second from the rear) of terminal strip X16 (to left of socket X11). Connect the other 20,000 ohm resistor between terminal 2 of X16 and a solder terminal (must be installed) at the high voltage filter condenser mounting stud (ground). Connect an insulated wire to terminal 2 of X16 extending it through the chassis to one of the coil terminals of the relay. Solder all connections made thus far.
- d. Connect and solder the lead from terminal 2 of X16 to the relay coil. Connect the other terminal of the relay coil to a long insulated lead, capable of reaching the terminal strip, X26, near the microphone jack, as it is trained along the harness to X26. Train the lead, pass it through one of the microphone-key shield notches and connect it to the middle terminal of X26. The shield may be removed to facilitate this step and the one following.
- e. Connect a .005 mfd. disc ceramic condenser between the ground teardrop near the microphone jack, J1, and terminal 2 on J1. Connect the VHF choke between terminal 2 of J1 and the middle terminal of X26. Solder all teardrop and terminal connections made in this step. Replace the shield.
- f. Remove the black jumper from clips 3 and 5 on the "Operate" switch SW4A (front wafer). Connect and solder a twisted pair of leads between these clips and one set of normally open contacts on the relay. The blue-orange lead should remain connected to clip 5.
- g. Remove the two black leads from clip 8 of SW4A. Connect one lead of another twisted pair to clip 8 and the other lead to the two black leads just removed from clip 8. A single terminal can be installed beside SW4 for this connection or the connected can be soldered and taped neatly. Connect the other end of the twisted pair across the other set of normally open contacts on the relay. Solder all of the last twisted pair connections. Connect a lead from clip 6 of SW4A to the normally closed contacts on the same side of the relay.
- h. Connect the positive end of the 5 mfd condenser to the coil terminal previously connected to terminal 2 of X16 and the negative lead to the teardrop at the foot of the relay. Solder both leads.

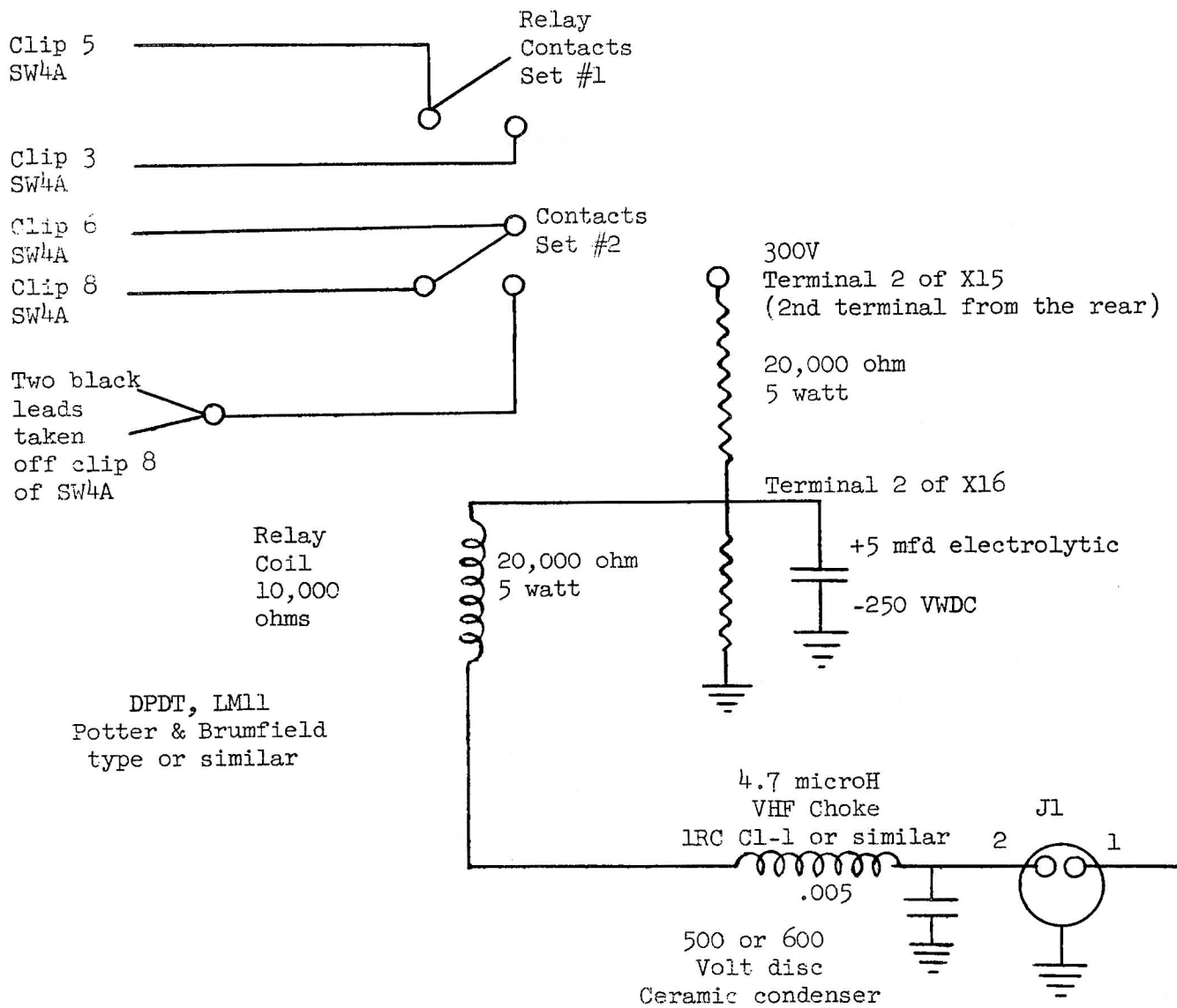

Schematic-Wiring Connections of the Push-to-Talk Circuit

- F. 3. i. The microphone plug and push-to-talk circuit should be wired to correspond to the J1 connections.
- j. For operation, the Operate switch should be placed in the Phone position thus permitting control by the microphone push-to-talk switch.



G. TYPICAL OPERATING DATA AND TROUBLE SHOOTING

1. Typical Voltage, Current, and Resistance Data

a. Typical Viking Ranger voltages and currents with the 6146 final loaded into a 52 ohm load. Normal operation with line voltage of 117VAC. Voltage measurements made with 20,000 ohm/volt voltmeter.

<u>Tube and Function</u>	<u>Plate Voltage</u>	<u>Screen Voltage</u>	<u>Cathode Voltage</u>	<u>Plate Current</u>
6AU6 VFO	310	150		
6CL6 Crystal Oscillator-Isolater	310	95		"OSC" 23 ma (may be lower on 15 and 20 meters)
6CL6 Buffer	310	185	7	"BUFF" 15
6146 Final Amp.	500 525	190 190		"FINAL" 140 (PHONE) "FINAL" 150 (CW)
12AX7 Speech Amp. First half	120		1.3	
Second half	135		1.5	
12AU7 Audio Driver	310		13	
1614's Modulators	500	300	grid bias-28	"MOD" 65
6AQ5 Clamper	185	255		
5R4GY H.V. Rectifier	670 A.C.			
6AX5GT L.V. Rectifier	425 A.C.			
H. V. Supply	500 Phone 530 CW 600 Standby		Grid Current	2.5 ma.
L. V. Supply	310 Phone 320 CW 335 Standby			
Bias Supply	-65			
12AU7 Keyer Control	+320 (pin 6)			
OA2 Regulator	150			

Individual transmitters may vary somewhat from the values listed above but no more than 10 to 20%.

G. 1. b. Transformer and choke winding resistances and open circuit voltages.

<u>Unit</u>	<u>Winding</u>	<u>Color of Leads</u>	<u>Resistance</u>	<u>Open Ckt. A.C. Voltage</u>
T1, Power Transformer	117 volt pri.	black to black	0.9 ohms	
	H.V. sec.	red to yel-red	95	750 volts
		yel-red to other red	95	750
	L.V. sec.	blue to yel-red	55	460
		yel-red to other blue	55	460
	Fil.	green to green	0.7	6.9
	H.V. rect.	yel to yel	0.5	5.6
Bias rect.	brown to brown		150	
T2, Mod Transformer	Pri.	red to brown	100	
		red to blue	100	
	Sec.	green to black	28	
		black to yel	28	
tertiary	white to black-white	7		
T3, Audio Driver Transformer	Pri.	red to blue	270	
	Sec.	yel to black	135	
		black to green	135	
LP1	H.V. choke	black to black	95	
IP2	L.V. choke	black to black	280	

Individual transmitters may vary somewhat from the values listed above but no more than 10 to 20%.

2. Trouble Shooting

- a. Be careful while making High Voltage Measurements. Do not take chances.
- b. Never depend on Bleeder Resistors to discharge Condensers. When turning equipment off, discharge each filter condenser with a screw driver equipped with a well insulated handle.
- c. All Power Supplies must be off and discharged when making ohmmeter measurements to prevent damage to the ohmmeter.
- d. Schematics, photographs, and charts aid greatly in trouble shooting and are furnished in this section for reference. Particularly useful will be the typical operating voltages, current reading, and the resistance measurements. Use these charts and listings to save time in locating trouble.

- G. 3. It is almost impossible to anticipate all troubles, operating errors, or component failures in the following listing. It is attempted however, to list possible combinations that will aid in correcting trouble normally encountered in transmitter construction and operation.

NEVER REPLACE THE FUSE, FUSETRON OR SLO-BLO FUSE, WITH VALUES LARGER THAN THOSE SUPPLIED AND RECOMMENDED.

4. Fuse blows when Operate switch is turned to the "TUNE" position.
- In order to help determine the location of the short, remove the exciter-auxiliary power plug. This will disable the filaments and low voltage supply to the VFO and RF section. If the short condition prevails, it will be found in the modulator section or power supplies.
  - With the plug, X13B, removed, power off, measure the resistance from pin 4 of the exciter-auxiliary power plug to ground. The reading should be 25,000 ohms. If reading is correct, the L.V. Supply is probably alright.
  - Check all tubes for internal shorts between plate and other elements.
  - Measure primary resistance of power transformer T1.
5. Fuse blows when "Operate" switch is turned to "PHONE" position.
- With the plug, X13B, removed and power off, measure between pins 5 and 6 and ground, this will check for shorts in the final plate, screen and clamper circuit. Resistance should be many megohms.
  - Measure secondary resistances of the power transformer T1. CHECK THE H.V. CONDENSER, C77.
  - With the exciter-auxiliary power plug removed, measure from pins 1, 2 and 3 of X13 to ground. Readings should be many megohms.
  - Check all tube sockets for evidence of shorts. Any "sweating" tendency on the part of the disc ceramics may indicate an internal high resistance leakage.
6. RF Exciter section. "TUNE" position of Operate switch.
- No "OSC" indication on meter. Exciter-auxiliary plug is not installed, or jumpered incorrectly.
  - No "buffer" current indication. Drive control either fully counter-clockwise or open.
  - No "grid" current indication. Check position of crystal - VFO switch. Check crystals, check setting of drive control. Check the emission of the buffer by switching to "buffer" position and advancing drive control fully clockwise. Current should go to 40 ma. Check clamper tube as shorted clamper tube will short out final grid.
7. Final tuning. "Phone" position of Operate switch.
- Unable to load final. Check ground leads, antenna leads, antenna change-over relay leads, and proper functioning of the relay. Check action of band switch rear wafer SW3D.
  - Read and understand the section "D Pi Network Tuning and Harmonic Suppression".
  - Check the final plate and screen voltage. Defective clamper tube will keep final from operating. Also check drive to final - normal grid drive is 2.5 ma.

- G. 8. Reports of excessive harmonics or spurious signals; Phone or CW.
- a. Read discussion on providing a good ground and pi-network tuning and harmonic suppression.
  - b. Overmodulating transmitter on phone can cause spurious signals.
  - c. Poor crystals.
9. Reports of signals 20 to 60 kc on either side of carrier - Crystal operation. These spurious signals originate in the crystal. Some crystals will show some excitation near the fundamental mode of oscillation. Best solution to this problem is to replace the crystal.
10. RF on chassis or microphone. Poor ground system or a very low impedance termination at the antenna connection at the transmitter may cause chassis and microphone to be hot. Read the discussion on providing a good ground. Check for high standing wave ratio on the antenna feed line. Check that antenna is favorable to band used instead of to harmonically related band.
11. High "PLATE" current indication on meter CW-operation with key open. Check 6AQ5 clamper tube, and associated wiring.
12. Squeal or high modulator current indication on "PHONE" position.
- a. Check for acoustical feed back from receiver speaker or headphones.
  - b. Microphonic tube in the audio system.
  - c. Poor or intermittent ground connection to microphone or at the cable connector.
13. Adjustments
- a. Static Modulator Current  
Turn the meter to "MOD.". The reading should be between 55 and 70 ma. If it is out of these limits, turn the "OPERATE" to "OFF", pull out the AC plug, discharge the rear terminal of the high voltage bleeder R35 to the chassis with an insulated screw driver and adjust the tap of R35 carefully (loosening the tap screw adequately to prevent breaking the resistance wire) toward the rear to increase the modulator current or toward the front to decrease it. Turn "OPERATE" to "TUNE" for warmup and again to "OPERATE" to check the mod current.
  - b. Grid Drive Adjustment  
The grid drive on 10 and 11 meters may be adjusted by peaking L5 in the vicinity of 28 mc.



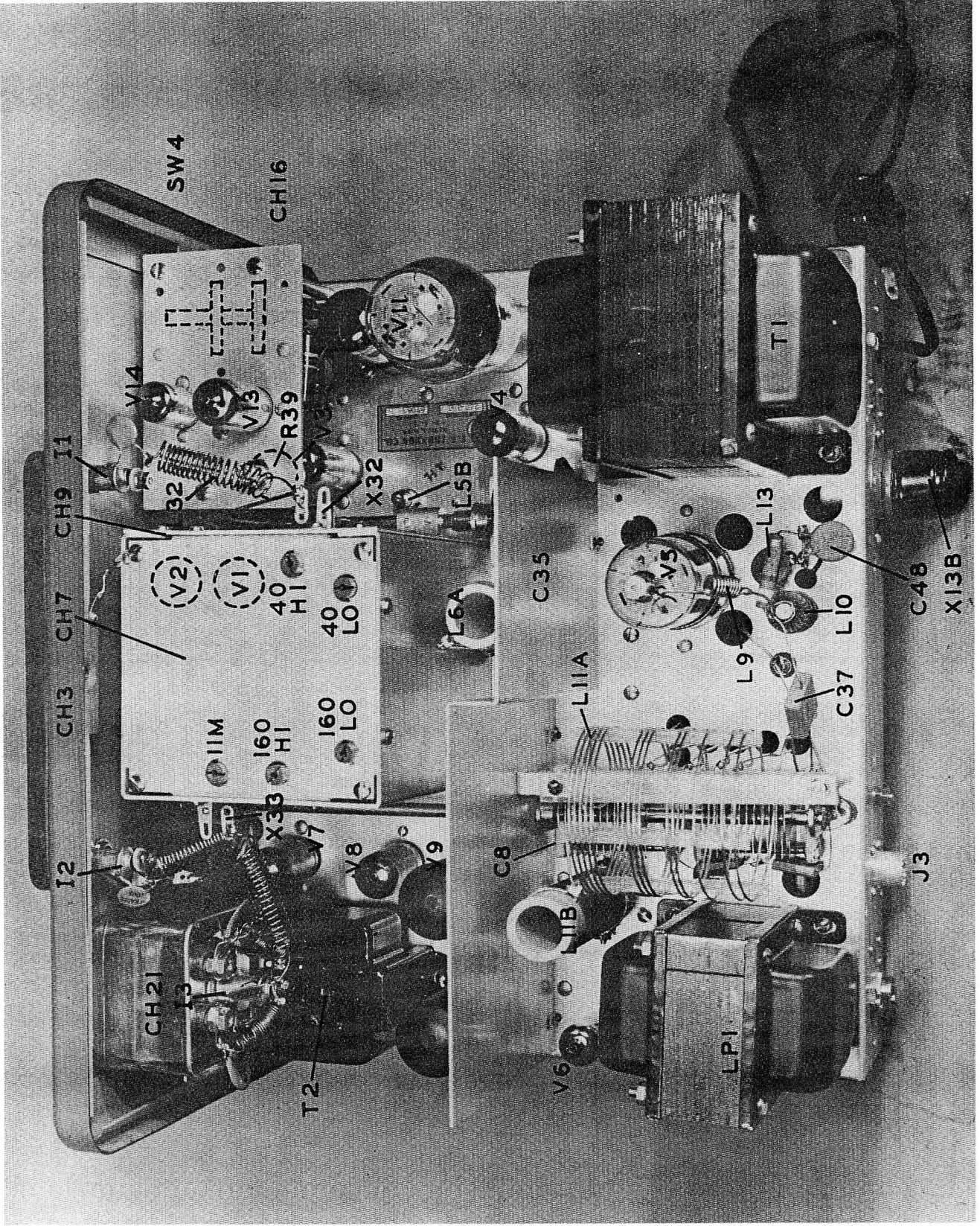

FIGURE 1 COMPLETED CHASSIS TOP VIEW.

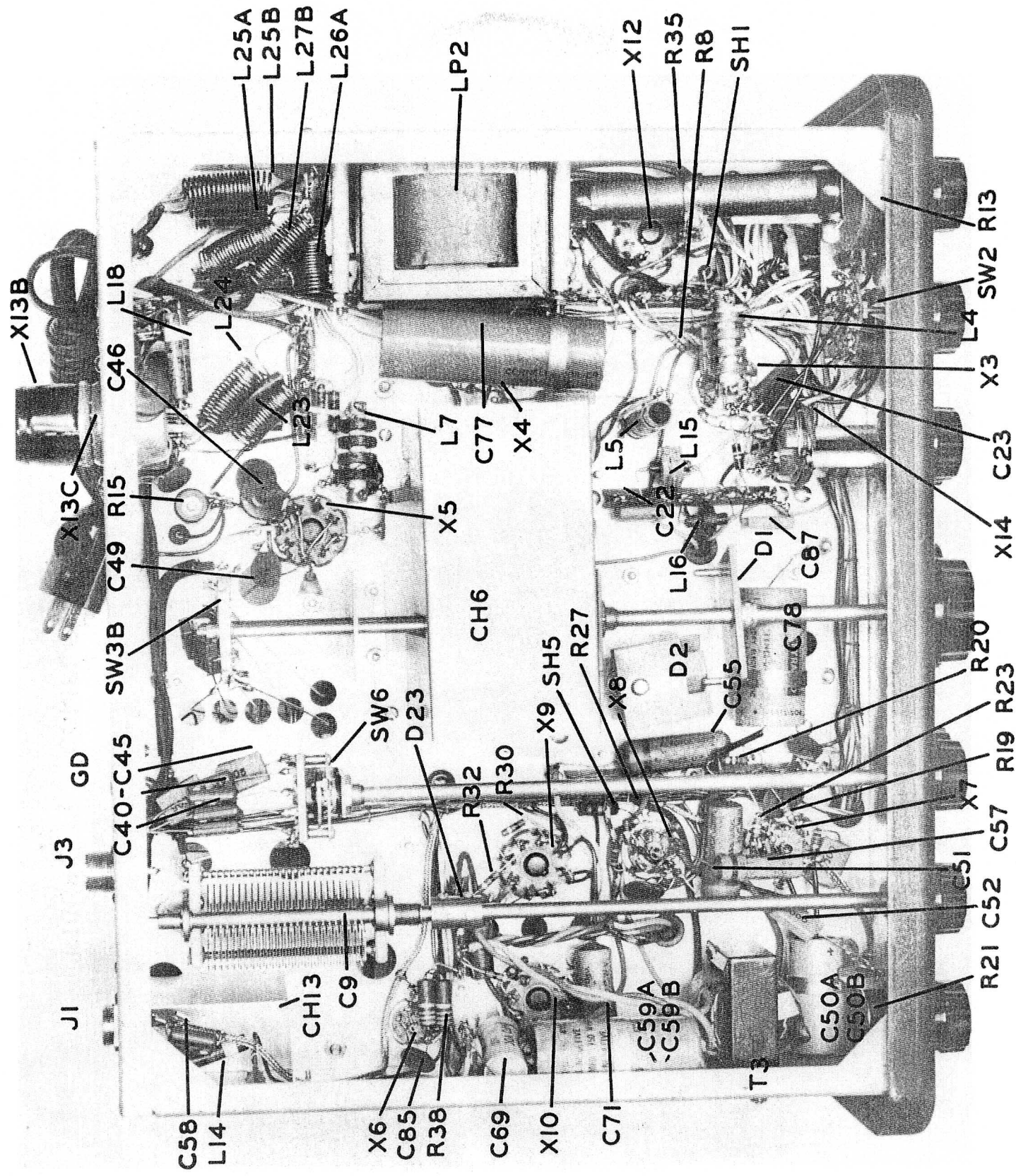

FIGURE 2 COMPLETED CHASSIS BOTTOM VIEW.

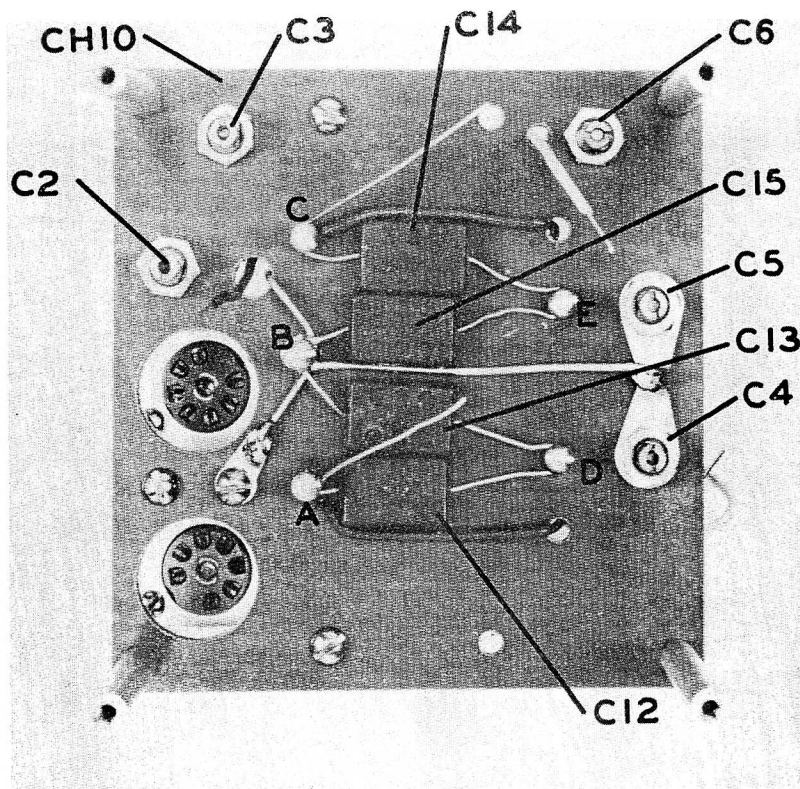

FIGURE 3A. V.F.O. CHASSIS TOP VIEW.

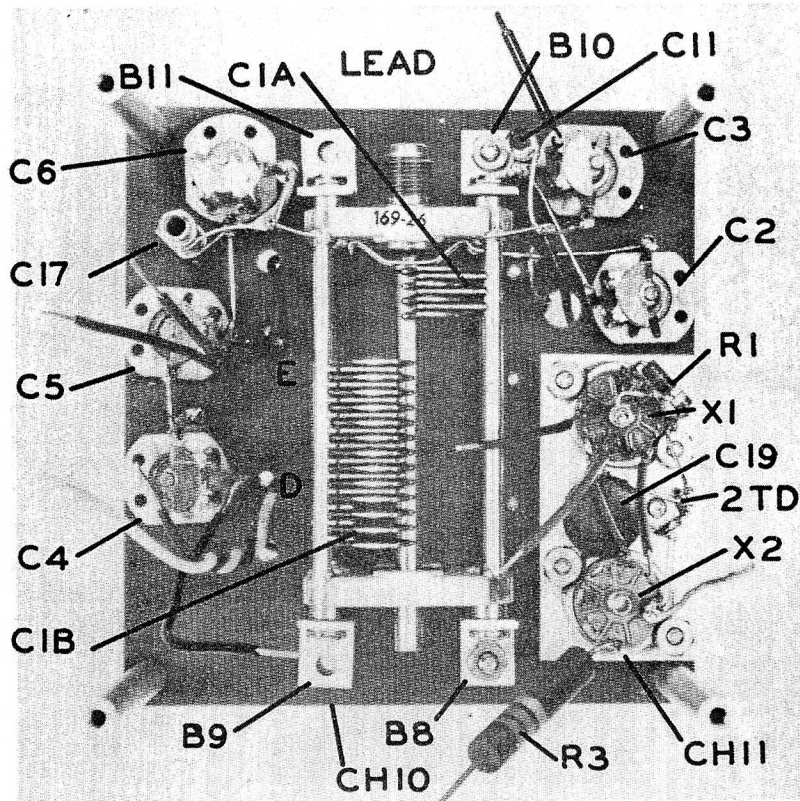
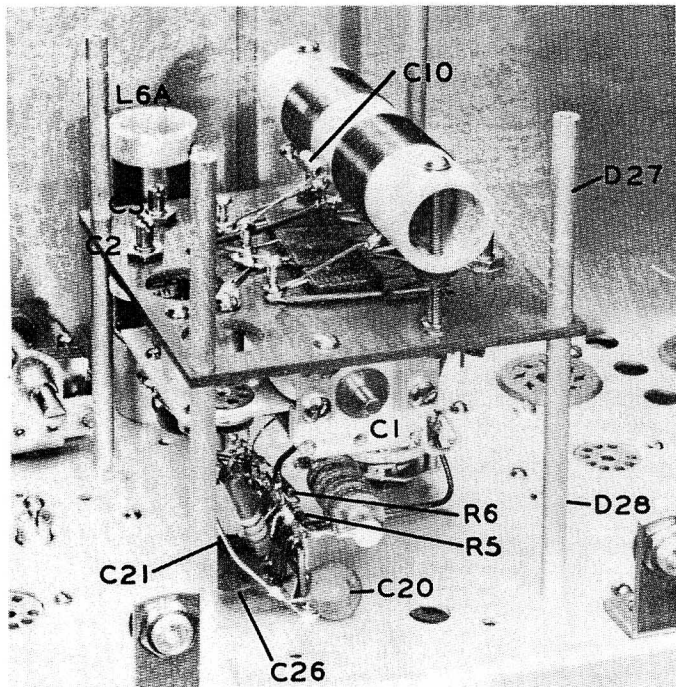
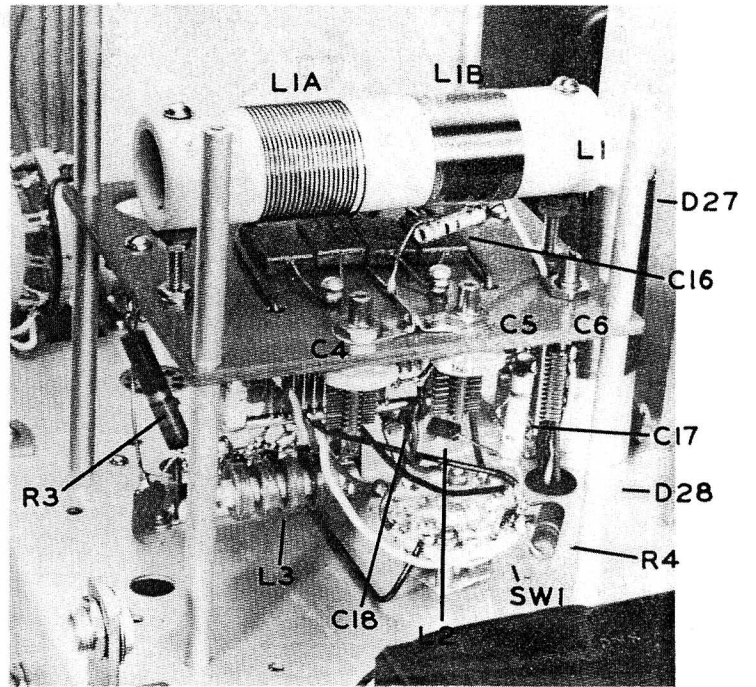

FIGURE 3B. V.F.O. CHASSIS BOTTOM VIEW.





LEFT VIEW



RIGHT VIEW.

FIGURE 4A. V.F.O. MOUNTED

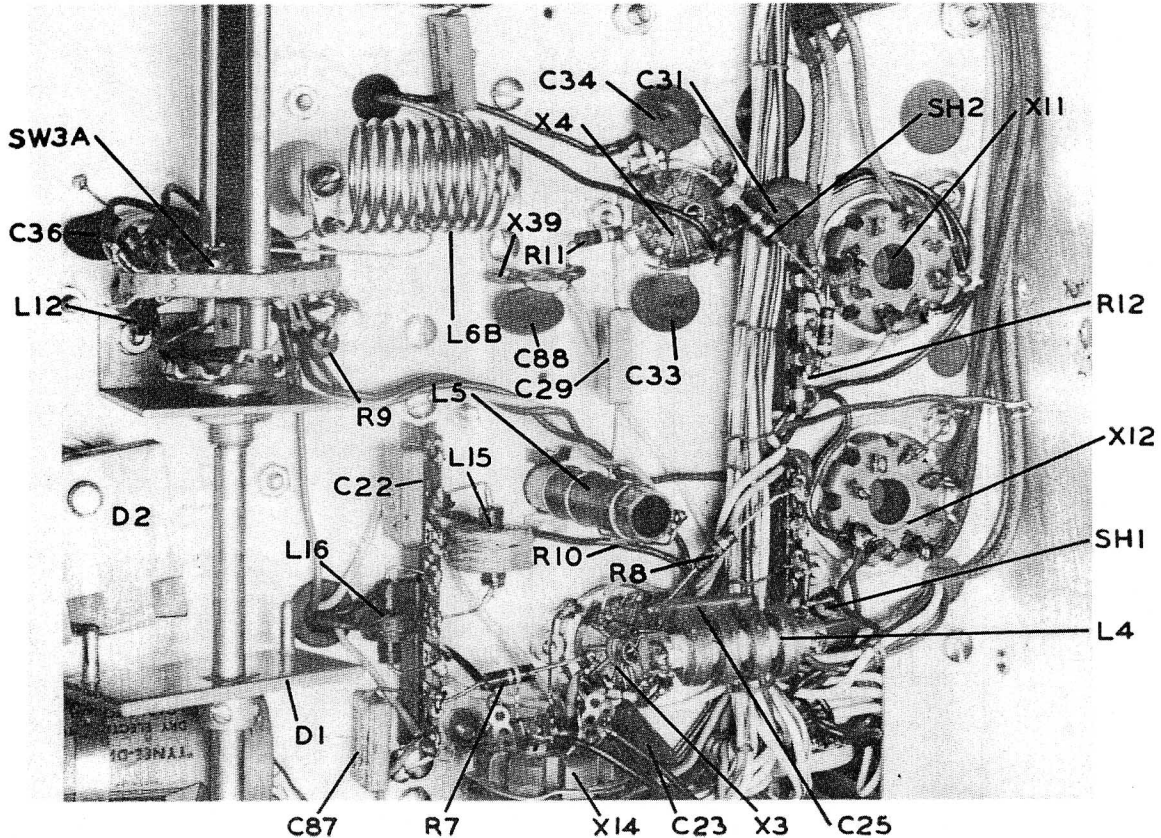

FIGURE 4B. R.F. EXCITER SECTION BOTTOM VIEW.

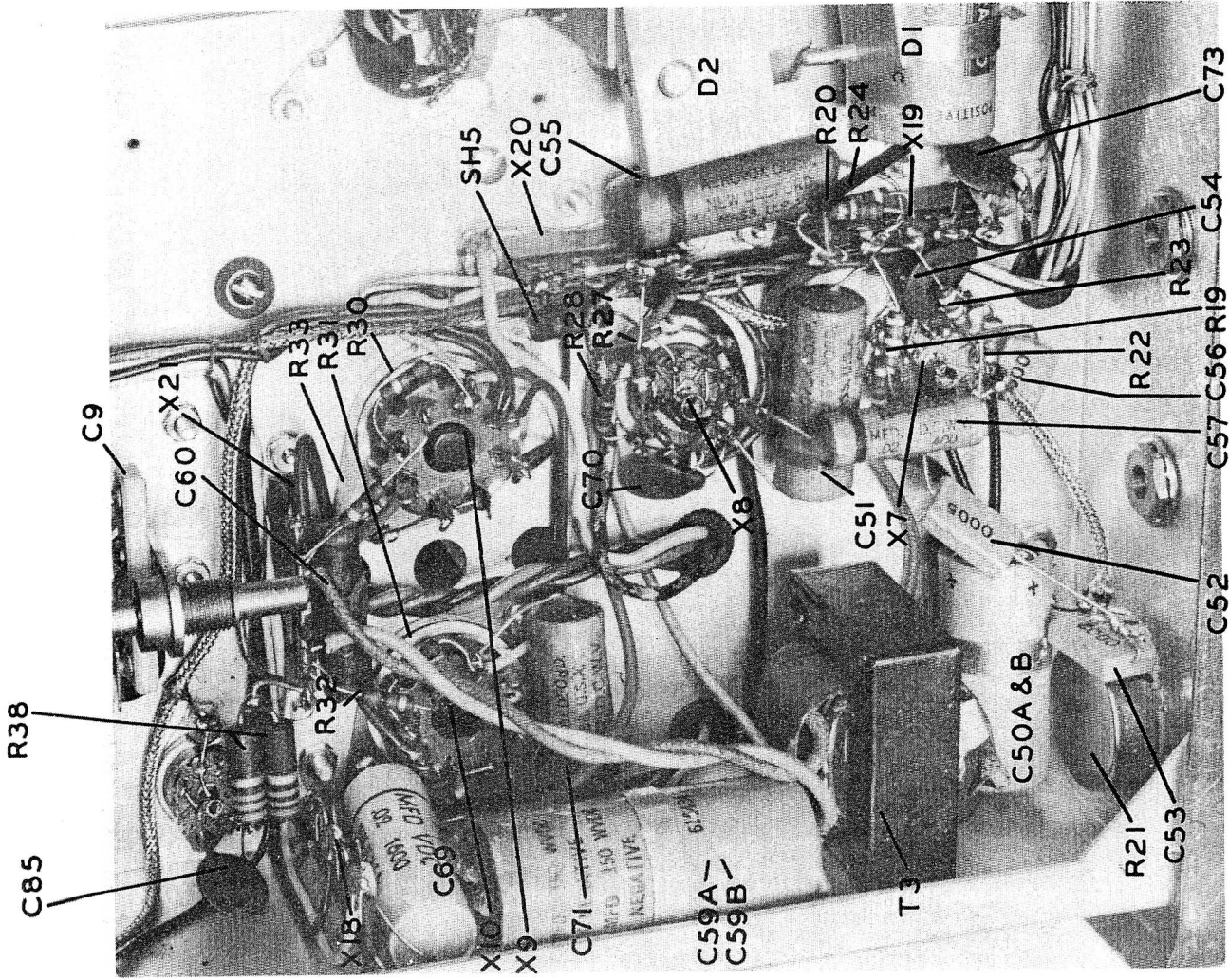

FIGURE 5A. AUDIO SECTION BOTTOM VIEW.

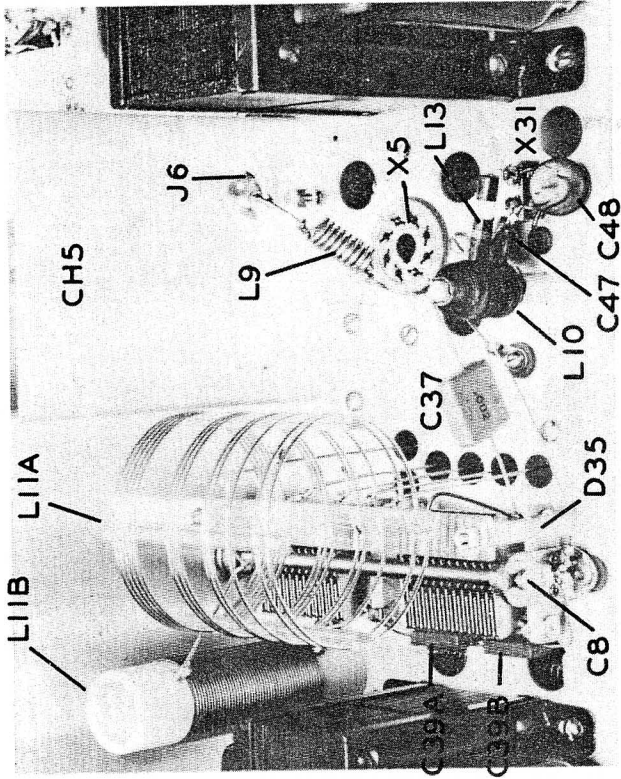

FIGURE 5B. R.F. FINAL TOP VIEW.

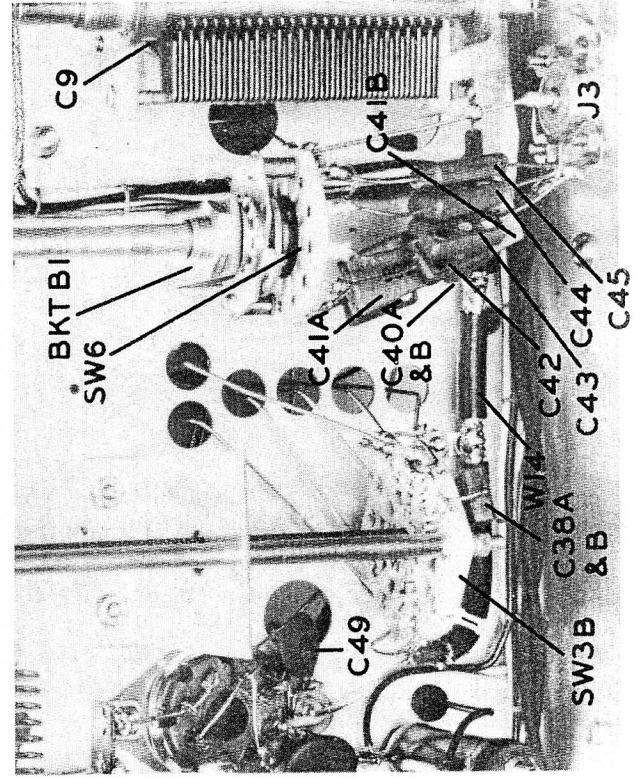

FIGURE 5C. R.F. FINAL BOTTOM VIEW.

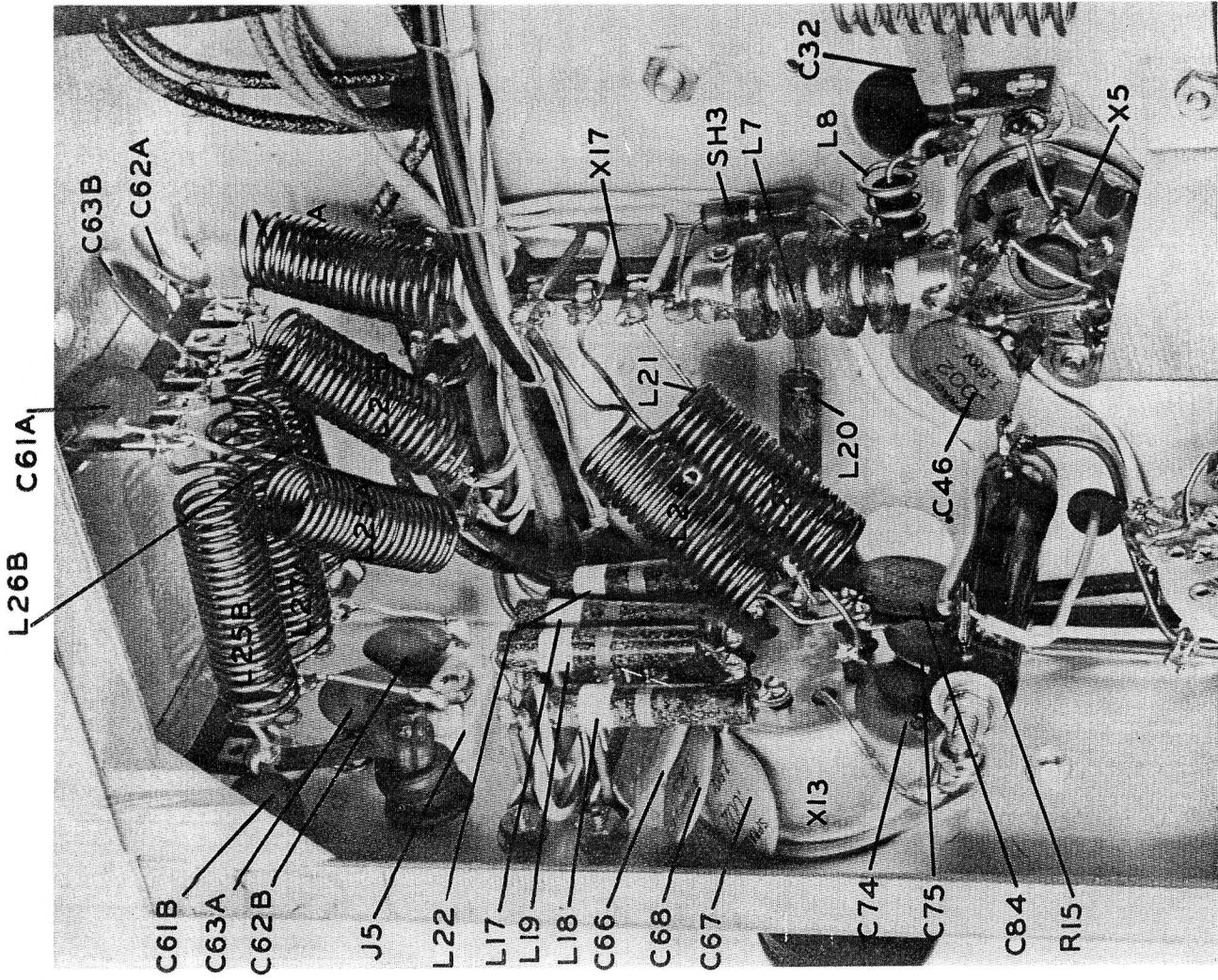

FIGURE 6A. LINE FILTER AND AUXILIARY SOCKET.

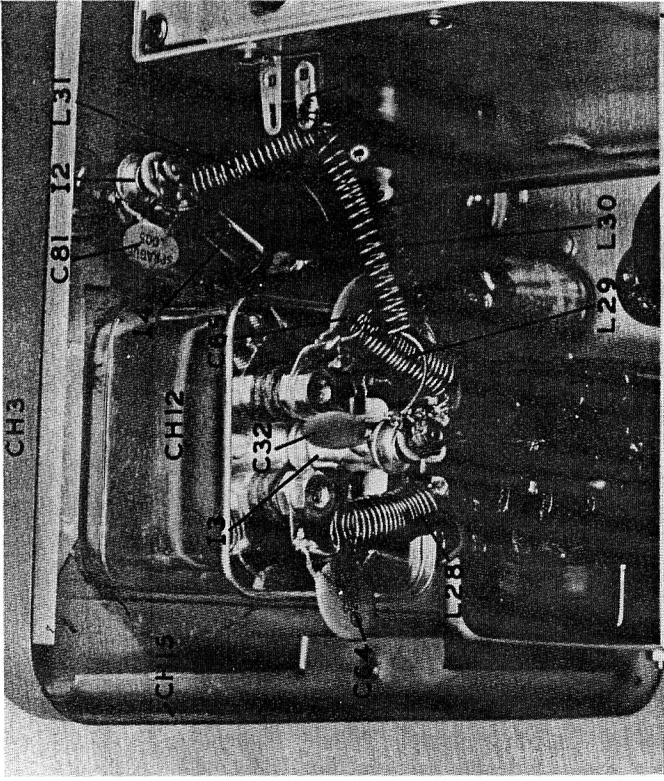

FIGURE 6B. METER SHIELD

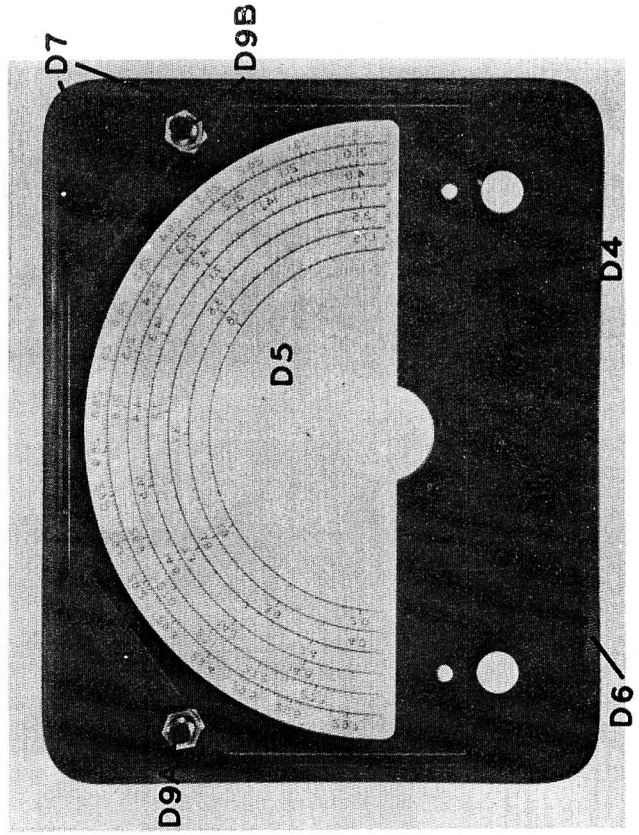

FIGURE 6C. ESCUTCHEON AND DIAL.

TUBE SOCKET CONNECTIONS BOTTOM VIEW

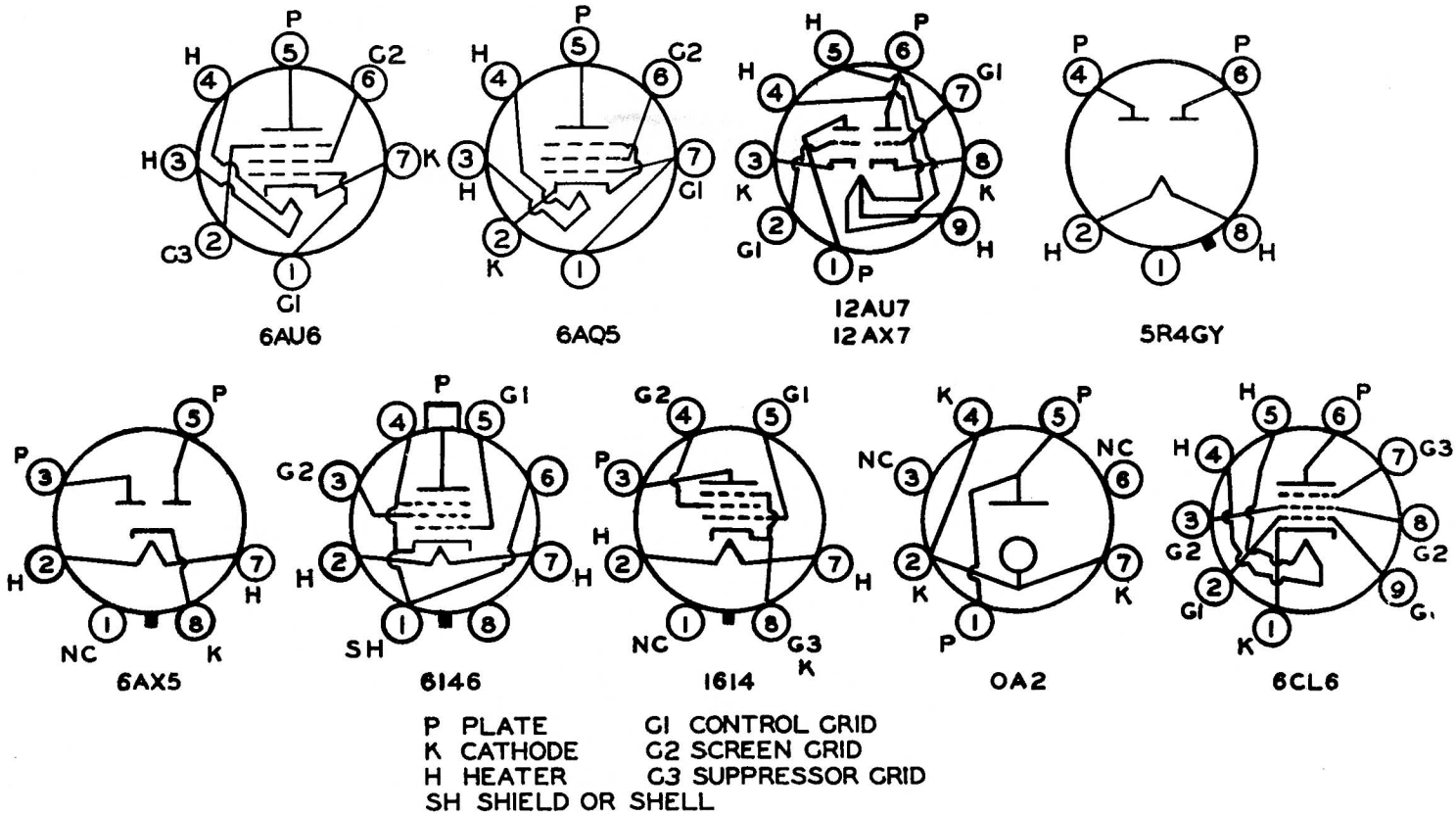

FIGURE 7A

CONDENSER-RESISTOR COLOR CODE

COLOR	SIGNIFICANT FIGURE	DECIMAL MULTIPLIER	TOLERANCE (%)	VOLTAGE RATING*
BLACK	0	1	1	100
BROWN	1	10	2	200
RED	2	100	3	300
ORANGE	3	1,000	4	400
YELLOW	4	10,000	5	500
GREEN	5	100,000	6	600
BLUE	6	1,000,000	7	700
VIOLET	7	10,000,000	8	800
GRAY	8	100,000,000	9	900
WHITE	9	1,000,000,000	5	1,000
COLD	-	0.1	10	2,000
SILVER	-	0.01	20	500
NO COLOR	-	-	-	-

\* APPLIES TO CONDENSERS ONLY



COLOR CODING OF FIXED RESISTORS  
A-FIRST SIGNIFICANT FIGURE OF RESISTANCE IN OHMS  
B-SECOND SIGNIFICANT FIGURE  
C-DECIMAL MULTIPLIER  
D-RESISTANCE TOLERANCE IN PERCENT IF NO COLOR SHOWN TOLERANCE IS  $\pm 20\%$ .

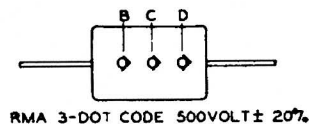
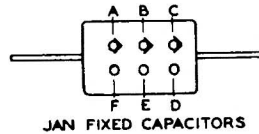

COLOR CODING OF FIXED CONDENSERS  
A-TYPE: MICA BLACK, PAPER SILVER  
B-FIRST SIGNIFICANT FIGURE OF CAPACITY  
C-SECOND SIGNIFICANT FIGURE  
D-DECIMAL MULTIPLIER  
E-TOLERANCE  
F-CHARACTERISTIC  
G-THIRD SIGNIFICANT FIGURE  
H-VOLTAGE RATING

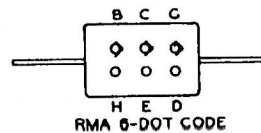
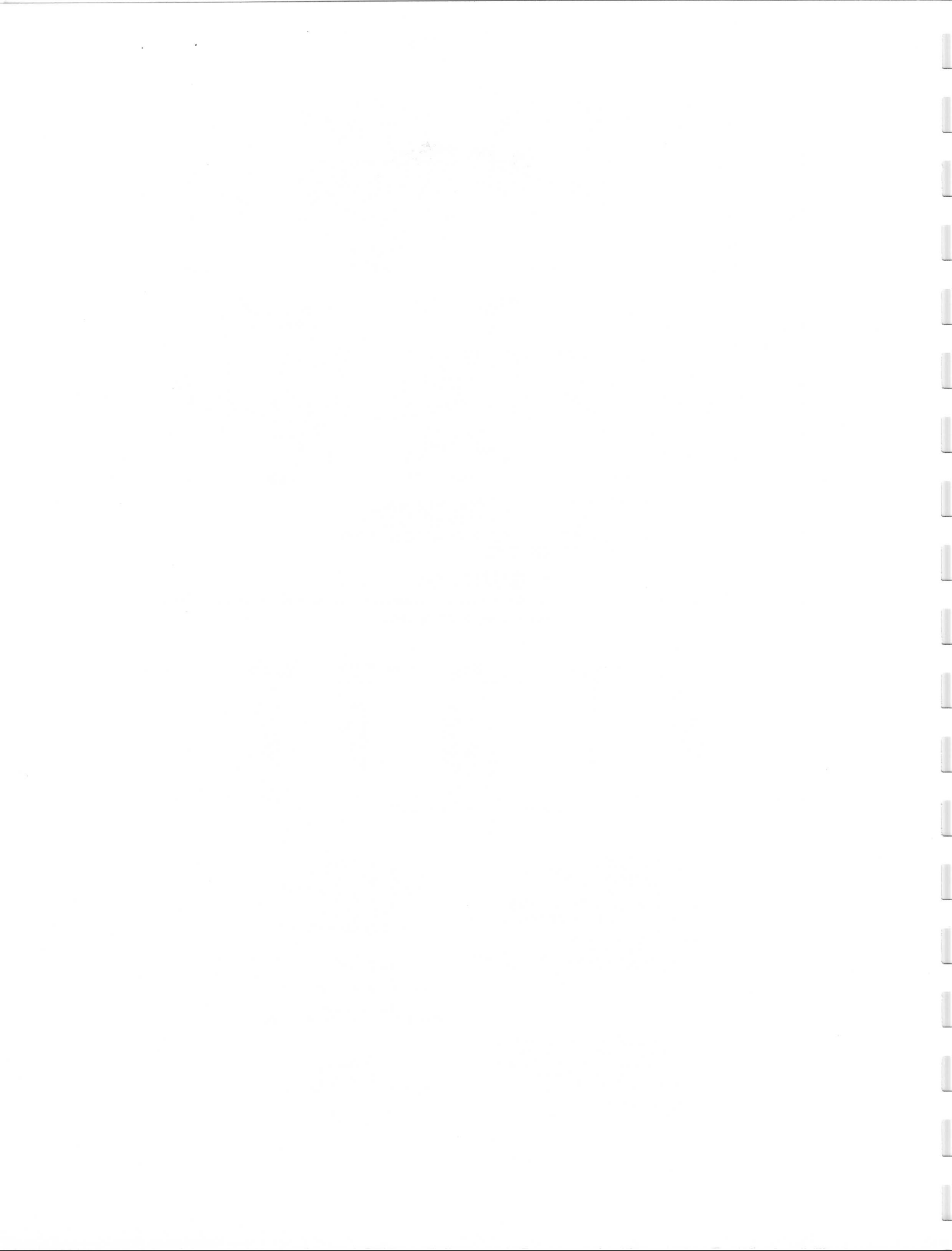

FIGURE 7B



# Viking Ranger

## Parts List

<u>Part No. or Drawing No.</u>	<u>Item No.</u>	<u>Qty.</u>	<u>Description</u>
17.848	CH1	1	Chassis
23.1055-2	CH2	1	Cabinet
23.1056-3	CH3	1	Panel
17.853	CH4	2	Chassis rails
17.847	CH5	1	Final shield
17.857	CH6	1	Buffer shield
17.846	CH7	1	VFO shield
17.820	CH8	1	VFO top
17.819	CH9	1	VFO side plate
18.699	CH10	1	VFO phenolic plate
17.855	CH11	1	VFO subchassis
22.1154-2	CH12	1	Meter shield
17.856	CH13	1	Mic. and key shield
22.825	CH14	4	Bumper feet
22.1001	CH15	50"	3/16 Rd Metaltex gasket
22.1155-2	CH16	1	Meter shield bracket
16.1001-1	B1	1	Underchassis coupling switch bracket
16.1165-1	B2	1	Underchassis bandswitch bracket
16.1001-4	B3-6	4	Top chassis component bracket
16.1167	D8-12	5	VFO condenser bracket
23.1059	D1	1	Drive arm for VFO switch
14.504	D2	1	Drive cam for VFO switch
23.1062	D3	1	Planetary drive assembly
17.858-2	D4	1	Dial escutcheon
22.993-2	D5	1	Dial plate
22.994	D6	26"	Rubber gasket
22.995	D7	4"	Rubber light blocks
23.1064	D8	1	Dial pointer
23.564-56	D9A,B	2	Red jewels
23.907-22	D10-11	2	100-0 dial
23.1007-5	D12-18	7	Phenolic knobs
23.980-11	D19	1	1 5/8 band knob
23.1060	D20	1	Crystal knob cover
32.46-13	D21	1	2 3/8 maroon knob
13.123-12	D22	5	3/8-32 panel bearing
13.760-2	D23	2	Couplings (less set screws)
18.666-4	D34	1	Insulated coupling (less set screws)
13.155-4	D24	2	VFO sub-chassis spacer
14.31-62	D25	2	1 3/8 crystal socket spacer
13.49-28	D26	2	Condenser spacer
14.31-64	D27	4	2 1/8 VFO chassis rods
14.31-65	D28-36,37,38	7	2 15/16 VFO chassis rods
14.139-3	D29	1	7 1/4 extension shaft
14.139-2	D30	1	6 7/16 extension shaft
14.139-1	D31	1	5 5/16 extension shaft
18.638-2	D32	5	VFO trimmer shafts
104-264-3	D33	1	Insulated shaft coupler
13.51-4r	D35	3	Final and H.V. condenser spacer (2.070")

# Viking Ranger

## Parts List

<u>Part No. or Drawing No.</u>	<u>Item No.</u>	<u>Qty.</u>	<u>Description</u>
22.975	X1,2,6,35	4	7 pin mica filled min. socket
22.976	X3,4,7,8,36	5	9 pin mica filled min. socket
22.849-2	X 5,9,10-12,14	6	8 pin octal mica filled socket
22.977	X13A	1	9 pin octal mica filled socket
22.978	X13B	1	9 pin octal mica filled plug
22.948-2	X13C	1	Socket support shell
22.740-7	X22	1	7 point terminal strip
22.740-4	X15,16,20	3	4 point terminal strip
22.740-6	X17,37	2	6 point terminal strip
22.740-5	X18,19,21,23, 28,29	6	5 point terminal strip
22.740-3	X24-27	4	3 point terminal strip
22.837	X30-33,39	5	2 point terminal strip
22.740-8	X34	1	8 point terminal strip
22.979	J1	1	Microphone jack
22.980	J2	1	Key jack
22.746	J3	1	83-1R coax receptacle
22.981	J4	1	Fused power plug
126-105	J5A	1	Relay jack
23.1031	J5B	1	Relay plug
16.35-1	J6	1	Tube cap
22.982	F1	1	3A, 125V MDL Fusetron
22.742	F2	1	5A, 250V MTH Fuse
22.377	I1A-4A	4	#51 pilot lamp
23.1047	I1-3	3	Lamp socket assembly
23.566-3	I4B	1	Socket assembly
26.236	H1	1	Harness - right sect.
26.237	H2	1	Harness - left sect.
71.91-100	W1	15 1/4 ft.	#20 black plastic covered tinned copper
71.91-105	W2	9 ft.	#20 green plastic covered tinned copper
71.91-104	W3	4 3/4 ft.	#20 yellow plastic covered tinned copper
71.91-102	W4	4 1/4 ft.	#20 red plastic covered tinned copper
71.91-106	W5	2 ft.	#20 blue plastic covered tinned copper
71.27-115	W6	6 ft.	#16 bare tinned copper wire
71.49-114	W7	7 ft.	Black line cord 18-2 POSJ 1/64 type
71.13-125	W8	31 1/2 ft.	#18 Formex or Nyclad copper wire
71.91-103	W9	1 1/2 ft.	#20 orange plastic covered tinned wire
71.91-108	W17	1 1/2 ft.	#20 gray plastic covered tinned wire
71.91-109	W18	1 1/4 ft.	#20 white plastic covered tinned wire
22.113-1	W10	6	9/16 OD grommet
22.113-5	W11	1	11/32 OD grommet
42.24-050	W12	1 ft.	.053 ID varnished tubing
42.24-107	W13	1/2 ft.	.133 ID tubing
71.32-178	W14	1/2 ft.	RG 59/U coaxial cable
22.997	W15	1/2 ft.	3/8" round wood doweling
42.24-113	W16	1"	.208 ID black vinylite tubing

## Viking Ranger

## Parts List

<u>Part No. or Drawing No.</u>	<u>Item No.</u>	<u>Qty.</u>	<u>Description</u>
22.985	T1	1	Power transformer
22.986	T2	1	Modulation transformer
22.753	T3	1	Driver transformer
22.987	LP1	1	10H H.V. choke
22.749	LP2	1	15H L.V. choke
22.988	SW1	1	VFO bandswitch 3 pos., 1 steat. wafer
22.989	SW2	1	VFO-crystal switch, 4 pos., 1 phen. wafer
22.990	SW3	1	Band switch, 7 pos., 2 steat. wafers
22.991	SW4	1	Operate switch, 5 pos., 2 steat wafers
22.847-2	SW5	1	Meter switch, 6 pos., 1 phen. wafer
22.992	SW6	1	Coupling switch, 7 pos., 1 steat. wafer
22.939-2	M1	1	0-5 ma. 100 MV D.C. milliammeter
23.968-2	L1	1	Dual VFO coil
22.844-2	L2	1	VFO output coil (single pi) 52 uh
22.951	L3,4,7	3	RFC
22.949	L5A	1	Oscillator coil
22.950	L5B	1	Coil fastner
23.902-5	L6A	1	LF buffer coil
23.913-2	L6B	1	HF buffer coil
23.912-2	L8	1	Parasitic suppressor
23.912-3	L9	1	Parasitic suppressor
22.952	L10	1	RFC
22.844	L12,16	2	RFC (single pi) 200 uh
23.1061	L11A	1	Main final coil
23.902-4	L11B	1	160M final coil
23.1000	L13,14,17-22	8	4.7 uh RFC
22.844-3	L15	1	RFC (single pi) 125 uh
169-26	C1	1	Special LA type dual var. condenser
160-107-51	C2,5	2	15M11 variable condenser
160-130-50	C3,6	2	30M8 variable condenser
160-107-50	C4	1	15M11 variable condenser
149-3-3	C7	1	50R12 variable condenser
149-530-3	C8AB	1	120RD18 variable condenser
149-13-3	C9	1	360R12 variable condenser
22.1014	C10	1	47 + 2 1/2% mmf ceramic N150, 500VW tubular condenser
22.954	C11	1	62 + 2 1/2% mmf ceramic NPO, 500VW tubular condenser
22.804	C12,13	2	500 + 2% mmf mica cond., D char. 500VW type CM20 case
22.805	C14,15	2	1000 + 2% mmf mica cond., D char., 500 VW, type CM20 case
22.809	C16	1	91 + 2 1/2% mmf NO80 500VW tubular ceramic condenser
22.823	C17	1	140 + 2 1/2% mmf NPO 500VW tubular ceramic condenser



# Viking Ranger

## Parts List

<u>Part No. or Drawing No.</u>	<u>Item No.</u>	<u>Qty.</u>	<u>Description</u>
22.807	C18	1	43 + 2 1/2% mmf NPO 500VW tubular ceramic condenser
22.827	C19-21,25-28, 30,31,33,34,36, 49,54,61A-B,62A- B,70, 63A-B,72-75, 79-82,85,87,88	32	.005 mfd GMV, 600VW, disc ceramic condenser
22.774	C22,40A-B,42-45, 58	8	300 + 20% mmf, 500VW, molded mica condenser
22.777	C23	1	25 + 5% mmf, 500VW, silvered mica condenser
22.862	C24,53	2	200 + 20% mmf, 500VW, molded mica condenser
22.773	C29,32	2	50 + 20% mmf, 500VW, molded mica condenser
22.856	C35	1	10 + 5% mmf, 500VW, silvered mica condenser
22.956	C46-48,64-68, 83,84	10	.002 GMV mfd, 1500VW, ceramic disc condenser
22.955	C37	1	.002 + 20% mfd, 1500VW, molded mica condenser
22.957	C38A,38B	2	150 + 5% mmf, 500VW, silvered mica condenser
22.859	C39A,39B	2	300 + 5% mmf, 500VW, silvered mica condenser
22.958	C41A-B,52,56, 86	5	500 + 20% mmf, 500VW, molded mica condenser
22.768	C51,55,71	3	.1 mfd, 400VW, paper tubular condenser
22.1111	C89	1	.05 mf + 20% 200V paper tubular condenser
22.767	C57	1	.02 mfd, 400VW, paper tubular condenser
22.765	C59A-B,90A-B	2	15-15 mf 150V electrolytic condenser
22.960	C50A,50B	1	10-10 mfd, common neg., dual 50VW electro- lytic condenser
22.963	C60	1	.005 + 20% mfd, 400VW, paper tubular con- denser
22.964	C69	1	.02 + 20% mfd, 1600VW, paper tubular con- denser
22.961	C77	1	10 mfd, 700VW, cardboard tubular electrolytic condenser
22.962	C78	1	30 mfd, 450VW, cardboard tubular electrolytic condenser
22.5097-10	R1,7,11,42,45	5	100,000 + 10% ohm 1/2 W carbon resistor
22.5019-10	R2	1	56 + 10% ohm 1/2 W carbon resistor
22.7079-10	R3	1	18,000 + 10% ohm 2 W carbon resistor
22.5041-10	R5,12	2	470 + 10% ohm 1/2 W carbon resistor
22.5081-10	R6,38	2	22,000 + 10% ohm 1/2 W carbon resistor
22.5093-10	R8	1	68,000 + 10% ohm 1/2 W carbon resistor
22.6065-10	R9	1	4,700 + 10% 1 W carbon resistor
22.5065-10	R16,18,22,53,52	5	4,700 + 10% ohm 1/2 W carbon resistor
22.5085-10	R10	1	33,000 + 10% ohm 1/2 W carbon resistor
22.5079-10	R41	1	18,000 ohm 1/2 W carbon resistor
22.5121-10	R17,40	2	1 + 10% megohm 1/2 W carbon resistor
22.5113-10	R19-23	2	470,000 + 10% ohm 1/2 W carbon resistor
22.5105-10	R20	1	22,000 + 10% ohm 1/2 W carbon resistor
22.5089-10	R24,43	2	47,000 + 10% ohm 1/2 W carbon resistor
22.5101-10	R27	1	150,000 + 10% ohm 1/2 W carbon resistor
22.5047-10	R28	1	820 + 10% ohm 1/2 W carbon resistor
22.6053-10	R4	1	1500 + 10% ohm 1 W carbon resistor

Viking Ranger

Parts List

<u>Part No. or Drawing No.</u>	<u>Item No.</u>	<u>Qty.</u>	<u>Description</u>
22.5025-10	R30-33	4	100 + 10% ohm 1/2 carbon resistor
22.5083-10	R37	1	27,000 + 10% ohm 1/2 W carbon resistor
22.732	R13	1	25K 4W WW potentiometer
22.832	R21	1	1 megohm 1/2 W volume control
22.972	R15	1	30,000 + 10% ohm 20W fixed power resistor
22.973	R35	1	20,000 + 10% ohm 35-50 W adj. power resistor
22.7069-10	R54	1	6,800 + 10% ohm 2 watt carbon resistor
22.5109-10	R44	1	330,000 + 10% ohm 1/2 W carbon resistor
22.1115	R39	1	100K ohm 1/2 W variable resistor
22.6085-10	R38A-C	3	33,000 + 10% ohm 1 W carbon resistor
22.996	SH1,2	2	3.0 + 5% ohm 1/2 WW resistor
22.867	SH3	1	20 + 5% ohm 1/2 watt carbon resistor (IRC)
22.974	SH4,5	2	.51 + 5% ohm 1/2 watt WW resistor
1 envelope			#4 hardware
1 envelope			#6 hardware
1 envelope			#8 hardware
1 envelope			#10 hardware
1 envelope			Miscellaneous hardware
1 envelope			Set screws
1 envelope			Solder lugs, spade lugs grommets
22.780	V1	1	Tube, 6AU6
22.787	V2	1	Tube, 0A2
22.1118	V3,4	2	Tube, 6CL6
22.788	V5	1	Tube, 6146
22.781	V6	1	Tube, 6AQ5
22.915	V7	1	Tube, 12AX7
22.916	V8,13	2	Tube, 12AU7
22.1121	V9,10	2	Tube, 1614
22.784	V11	1	Tube, 5R4GY
22.1123	V12	1	Tube, 6AX5GT
22.786	V14	1	Tube, 6AL5

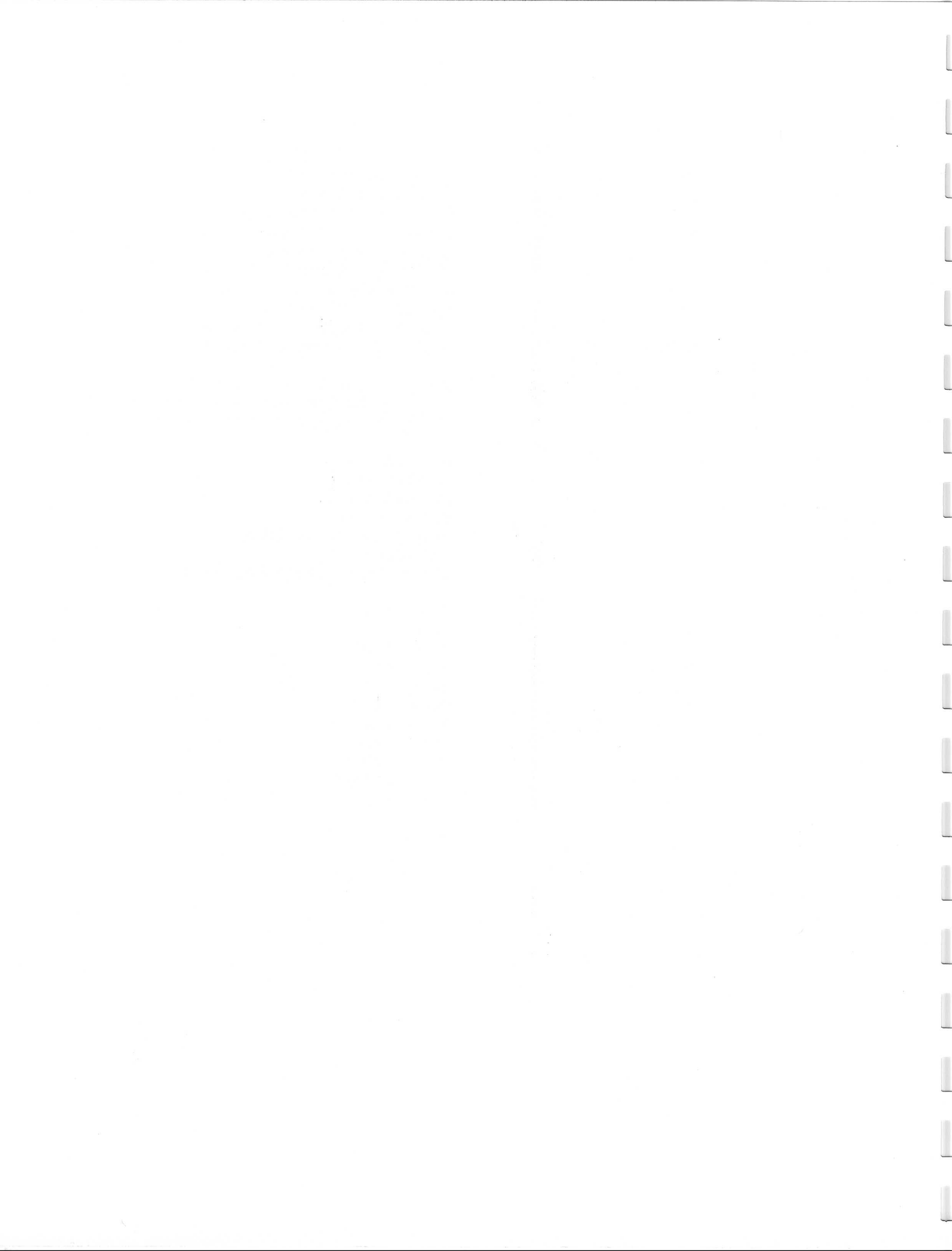

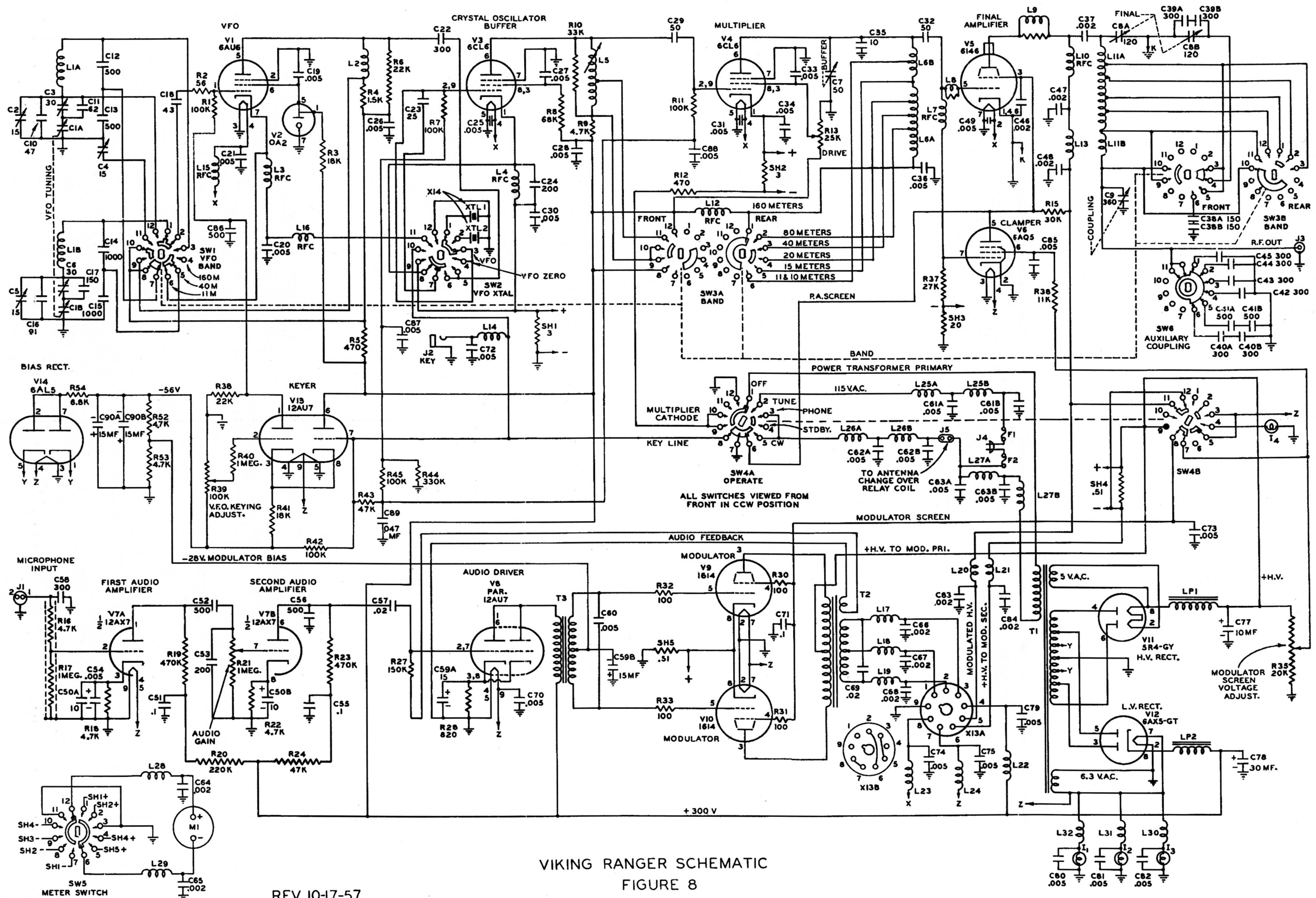

VIKING RANGER SCHEMATIC  
FIGURE 8

REV. 10-17-57

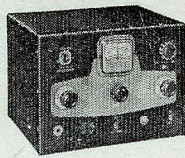

**VIKING "ADVENTURER"**—50 watts CW input. Easy to assemble and operate—used to earn first novice WAC! Bandswitching 80, 40, 20, 15, 11 and 10 meters.

**VIKING "RANGER"**—75 watts CW input, 65 watts phone—a flexible, TVI suppressed transmitter . . . also serves as an RF and audio exciter without modification! Bandswitching 160, 80, 40, 20, 15, 11 and 10 meters.

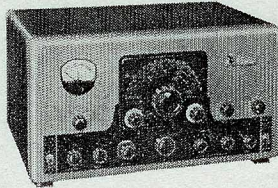
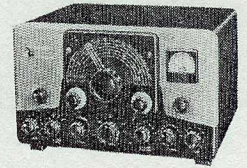

**VIKING "VALIANT"**—275 watts CW and SSB, (P.E.P. input with auxiliary SSB exciter) . . . 200 watts phone. Built-in VFO—a transmitter with power and flexibility! As an exciter will drive any of the popular kilowatt level tubes. Bandswitching 160, 80, 40, 20, 15, 11 and 10 meters.

**VIKING "PACEMAKER"**—For Single Sideband—more than just an exciter. 90 watts CW and SSB (P.E.P.) . . . 35 watts AM. Rugged, stable VFO—"foolproof" voice control! Bandswitching 80, 40, 20, 15 and 10 meters.

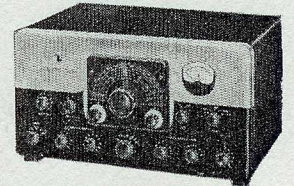

# Johnson

## amateur equipment

**VIKING "FIVE HUNDRED"**—600 watts CW input . . . 500 watts AM and SSB. (P.E.P. input with auxiliary SSB exciter.) VFO and all exciter stages gang-tuned! Bandswitching 80, 40, 20, 15, 11 and 10 meters.

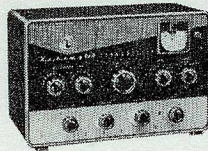
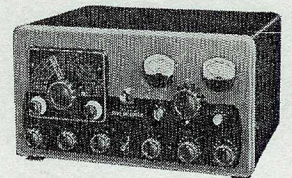

**VIKING "6N2"**—For VHF! 150 watts CW input . . . 100 watts AM. Rugged construction, thorough engineering—the same Johnson quality for 6 and 2 meters!

**AUDIO AMPLIFIER**—Self contained 10 watt speech amplifier complete with power supply. Speech clipping and filtering designed to raise average modulated carrier level . . . improves the performance and effectiveness of your AM transmitter!

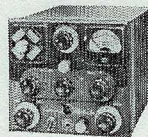
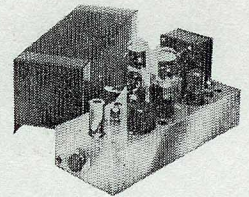

**VIKING "MOBILE"**—Rugged 60 watt mobile transmitter with an enviable DX record—under-dash mounting—convenient to operate! Bandswitching 75, 40, 20, 15, 11 and 10 meters.

**VIKING "KILOWATT"**—Boldly styled kilowatt power amplifier. 1,000 watts CW, AM and SSB—the ultimate in styling and operating convenience. Continuous tuning 3.5 to 30 megacycles.

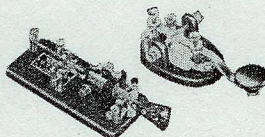
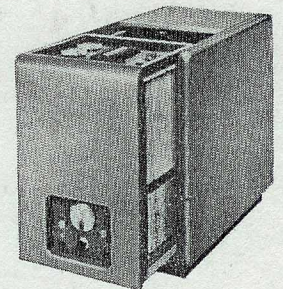

**KEYS AND PRACTICE SETS**—Johnson also makes a complete line of semi-automatic, high speed, standard, heavy duty and practice keys. See your distributor or write for complete information.



**E. F. Johnson Company**

W A S E C A , M I N N E S O T A