

GENERAL PURPOSE COMMUNICATIONS RECEIVER

MODEL AR-88D

INSTRUCTIONS

Manufactured by
RCA VICTOR DIVISION
OF
RADIO CORPORATION OF AMERICA
Camden, N. J., U. S. A.

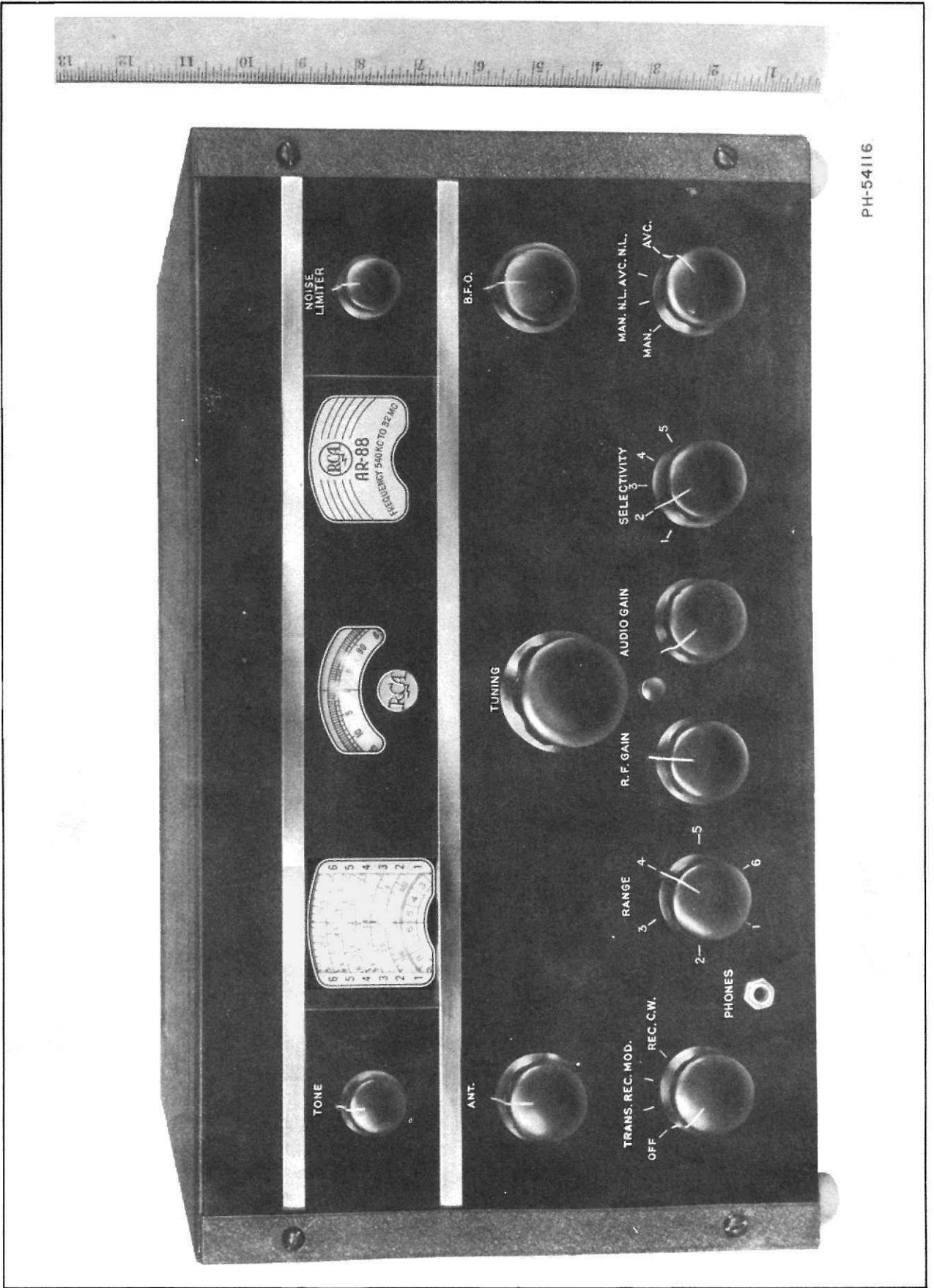

PH-54116

Figure 1—Front View of AR-88 Receiver

TABLE OF CONTENTS

Title	Page
Technical Summary.....	4
I Introduction	5
II Equipment	5
III Description	5
IV Circuit Arrangements	6
V Performance	7
VI Installation	8
VII Operation	8
VIII Maintenance and Alignment Procedure.....	10
IX Mechanical Construction.....	13
X Parts List.....	14
XI Vibrator Power Supply Unit, MI-8319.....	25

ILLUSTRATIONS

Figure 1 Front View of AR-88 Receiver.....	2
Figure 2 Diagram of Rear of Chassis.....	6
Figure 3 Diagram of Front Panel.....	8
Figure 4 Diagram of Top of Chassis.....	11
Figure 5 Loudspeaker	16
Figure 6 AR-88 Chassis	17
Figure 7 Top View of Chassis.....	18
Figure 8 Top View of Chassis — Covers Removed.....	18
Figure 9 Bottom View of Chassis.....	19
Figure 10 R-F Unit.....	20
Figure 11 Schematic Diagram	21
Figure 12 Selectivity Curves	22
Figure 13 Fidelity Curves.....	23
Figure 14 AVC Curves	24
Figure 15 Vibrator Power Supply Unit.....	27

TABLES

Table 1 Performance Data	4
Table 2 Tube Socket Voltages.....	14

GENERAL PURPOSE COMMUNICATIONS RECEIVER

MODEL AR-88D

TECHNICAL SUMMARY

Electrical Characteristics

Frequency Range—total 6 bands.....	535 to 32,000 kc
Band 1.....	535 to 1,600 kc
Band 2.....	1,570 to 4,550 kc
Band 3.....	4,450 to 12,150 kc
Band 4.....	11,900 to 16,600 kc
Band 5.....	16,100 to 22,700 kc
Band 6.....	22,000 to 32,000 kc

Maximum Undistorted Output—approximate—2.5 watts

Output Impedance—2.5 ohms and 600 ohms.

Power Supply Requirements

Line Rating..... 100-117, 117-135, 135-165, 190-230, 200-260 volts, 50/60 cycles.
 or Batteries..... 6 volt "A" battery and 250 to 300 volt "B" battery.
 or Vibrator Power Supply Unit..... MI-8319.
 Power Consumption—100 watts.

Tube Complement

R-F and I-F Amplifiers.....	5 RCA-6SG7
1st Detector (converter).....	1 RCA-6SA7
Oscillator.....	1 RCA-6J5
2nd Detector.....	1 RCA-6H6
Noise Limiter.....	1 RCA-6H6
A-F Amplifier.....	1 RCA-6SJ7
Power Amplifier.....	1 RCA-6K6GT
Beat Frequency Oscillator.....	1 RCA-6J5
Rectifier.....	1 RCA-5Y3GT
Voltage Regulator.....	1 RCA-VR-150

Mechanical Specifications

Overall Dimensions..... 19¼ inches wide x 11 inches high x 19¼ inches deep

TABLE 1—PERFORMANCE DATA

(Approximate Values — Taken on Sample Receiver)

Band No.	Megacycles	Sensitivity in Microvolts for 0.5 watt	Antenna Input in Microvolts for 6 DB Signal-Noise Ratio	Antenna Input in Microvolts for 20 DB Signal-Noise Ratio	Image Ratio
1	.6	.5	.9	4.6	Greater than 1,000,000
	1.0	.9	1.4	8.0	
	1.5	1.0	2.2	12.0	
2	1.7	.6	1.0	5.0	240,000
	3.0	.6	.95	4.8	
	4.3	.6	.9	4.5	
3	4.6	.8	1.3	8.0	60,000
	8.0	.8	1.2	6.8	
	11.5	.7	1.1	6.0	
4	12.1	1.2	1.3	6.6	4,000
	16.4	.7	1.2	7.0	1,500
5	16.4	1.3	1.3	7.0	1,000
	22.5	.8	1.4	8.0	400
6	22.5	2.5	1.5	8.0	400
	28.0	1.2	1.3	7.0	200

I-F rejection at 600 kc is 100,000.

GENERAL PURPOSE COMMUNICATIONS RECEIVER

I INTRODUCTION

In the design of a high frequency radio receiver, there are four important qualities for consideration:

1. Usable sensitivity.
2. Selectivity.
3. Frequency Stability.
4. Reliability.

The **sensitivity** of this receiver is limited only by the tube noise originating in the first tube and its associated circuits. A large part of this noise is due to "shot" effect and thermal agitation in the first tuned circuit. A signal, to be readable, must produce a voltage on the grid, of the same or greater order of magnitude than this inherent noise voltage. Therefore, an efficient coupling system between the antenna and the first R-F tube of the receiver is of great importance. This has been the subject of considerable development, and the system used on this receiver gives optimum coupling with antenna or transmission line impedances of 200 ohms, over the entire frequency range of the receiver, except on the broadcast band. On the broadcast band, a low frequency primary is

used, resonating well below the band with a 200 mmf antenna.

The second quality of a receiver, **selectivity**, is necessarily a compromise with fidelity of the reproduced signal. This receiver is designed to have five degrees of selectivity, three of which include a crystal filter.

To secure good **frequency stability**, rugged construction of parts and wiring in the high frequency heterodyne oscillator circuit has been included in the design. This, together with voltage stabilization of the oscillator plate supply, temperature compensation, and proper oscillator excitation, provides a high degree of stability.

Reliability depends to a large extent on the quality of material and workmanship. Throughout the AR-88 Receiver the best material obtainable is used for each particular purpose and all workmanship is of the best.

The following instructions should be studied before the installation or operation of this equipment is attempted, in order that optimum performance may be obtained.

II EQUIPMENT

The equipment furnished consists of the Receiver Chassis Assembly, including control panel and tubes and cabinet for complete enclosure for table mounting.

Additional equipment required includes headphones

or loudspeakers, an antenna system, and an AC source of power, batteries, or Vibrator Power Supply Unit MI-8319. The Loudspeaker, shown in Figure 5, is not supplied with the equipment, unless specially ordered. It may be obtained separately as MI-8303D. Headphones MI-5803-6 are recommended.

III DESCRIPTION

This receiver covers short wave, standard broadcast, and CW service; its principal use is for short wave communications. It is designed to withstand severe climatic and line voltage variations without appreciable impairment of performance.

Its features include:

- Mechanical Band Spread with Single Control for ease of tuning a previously logged station.
- Automatic Noise Limiter which automatically limits interference to a percentage of modulation determined by the Noise Limiter Control.
- Noise Limiter Control for setting Noise Limiter to operate at any desired percent modulation.
- Noise Limiter Switch for switching Noise Limiter on or off.
- Continuously variable High Frequency Tone Control.

- Antenna trimmer for circuit alignment.
- Crystal filter for ultra-sharp selectivity when required.
- Exceptionally good oscillator stability through normal variations in line voltage.
- Four-gang Condenser giving high image ratio on all bands.
- Twelve Tuned I-F Circuits giving a very high degree of selectivity.
- Temperature compensated oscillator circuits on all bands.
- Ceramic Insulation throughout on gang condenser, sockets, range switch, and selectivity switch.
- Tuning Lock for service under extreme conditions of vibration.

IV CIRCUIT ARRANGEMENTS

The circuit is shown schematically in Figure 11. It consists of two stages of R-F amplification, first detector, first heterodyne oscillator; three stages of I-F amplification, second detector, noise limiter, second heterodyne oscillator; A-F amplifier stage, output power stage and power supply system.

Input Coupling — The antenna coupling system is designed to provide optimum coupling from a 200 ohm transmission line, except in the broadcast band. The first tuned circuit is provided with a trimmer condenser adjustable from the front panel. This insures

with open link is required, this connection on the rear of the antenna terminal board must be removed.

R-F Amplifier — The R-F Amplifier is designed to provide ample selectivity ahead of the first detector for minimizing cross modulation and blocking effects from strong interfering signals and for obtaining a high degree of image signal suppression. The amplification is adjusted to provide optimum signal-to-noise ratio by making noise contributions of circuits following the first tube negligible in comparison with the noise contributed by the first R-F grid circuit; that is, each tuned circuit in the receiver contributes some

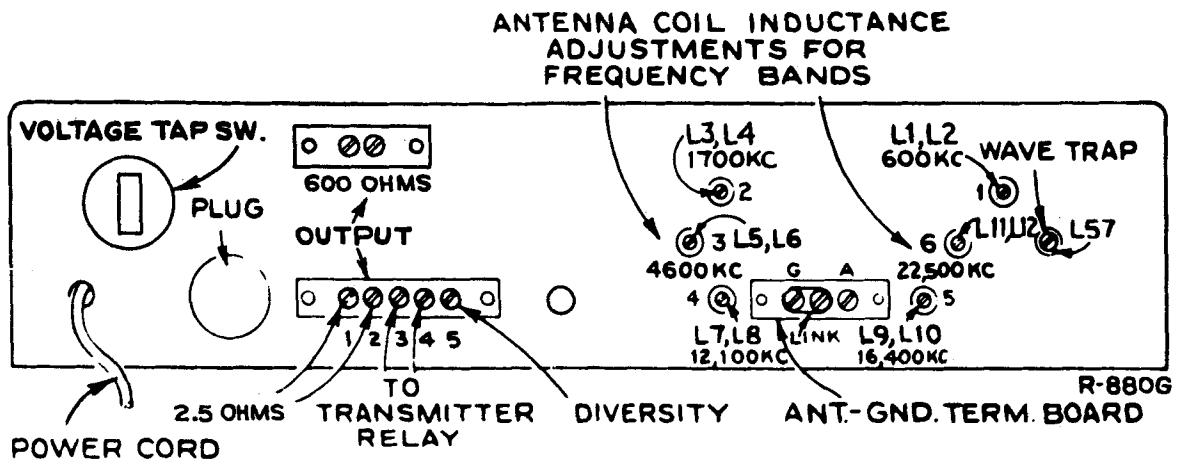

Figure 2—Diagram of Rear of Chassis

the proper tuning of this circuit with any antenna system.

For the standard broadcast band, conventional antenna and ground connections should be used.

The antenna terminal board is provided with three terminals (see Figures 2 and 6), two of which may be joined together with a link. When a single wire antenna is used, the link should be closed and the antenna connected to "A." If a ground is used, it should be connected to "G." If a transmission line or balanced input is used, the link should be opened and the line connected to terminal "A" and the center terminal.

IMPORTANT—Receivers are shipped from the factory with a permanent bus-wire connection on the rear of the antenna terminal board, between the center and ground terminals. If balanced input operation

noise voltage, but by making the gain of the first tube as high as practicable, the noise contributed by succeeding circuits is unimportant.

Band Spread — The mechanical band spread with single control knob enables the operator to quickly tune a previously logged station. The log scale on the main dial and the separate vernier dial provide for exact logging and tuning.

First Heterodyne Oscillator — The first heterodyne oscillator is aligned to track with the R-F Amplifier at 455 kc higher than the signal frequency, thus producing a 455 kc intermediate frequency in the first detector plate circuit which is amplified further in the I-F stages. The oscillator voltage is regulated by the RCA VR-150 regulator tube to provide maximum frequency stability under conditions of variations in power supply voltage.

Intermediate Frequency Crystal Filter — The first detector plate circuit is tuned to the intermediate frequency and a balanced link circuit is used to couple the first detector plate and first I-F grid circuits. A 455 kc crystal is connected in one arm of the link circuit and a neutralizing capacitor is connected in the other. The impedances of the coils in the link circuit are designed so that the crystal selectivity characteristic is not impractically sharp. The band width at two times resonant input may be adjusted to 400 cycles, 1,500 cycles, or 3,000 cycles. For this adjustment see "Operation."

Intermediate Frequency Amplifier — Three stages of I-F amplification are used; RCA-6SG7 tubes are used in all stages and an RCA-6H6 tube is used for AVC and second detector. The first I-F Transformer has its primary and secondary tuned, and is coupled through the crystal filter link. The second and third I-F Transformers are composed of four tuned circuits each. These circuits are varied in coupling by the selectivity switch. The fourth I-F Transformer has two tuned circuits.

The third I-F stage is not connected to the AVC nor to the manual volume control so that a good AVC characteristic with little overload distortion is obtained. This also permits the CW oscillator to be coupled to the grid circuit of this stage, giving a comparatively high detector excitation voltage with small electrical coupling to the oscillator circuit.

Second Heterodyne Oscillator — The second heterodyne (CW) oscillator is a triode RCA-6J5 tube which is electrostatically coupled to the final I-F stage. A panel control is provided by means of which the frequency of the heterodyne oscillator and resultant audio beat note may be varied.

Particular care has been taken in the design of the circuit constants to minimize oscillator harmonics.

Automatic Volume Control — The AVC voltage is obtained from the second detector, an RCA-6H6 tube. A variable delay is obtained depending on the setting of the R-F gain control.

The second heterodyne (CW) oscillator excitation voltage is just lower than the AVC diode bias voltage so that it does not decrease the sensitivity of the receiver.

Manual Volume Control — Two manual volume controls are provided; an audio gain control which is employed when the AVC is in use, to obtain the desired output level, and an R-F gain control.

Noise Limiter — The noise limiter circuit utilizes an RCA-6H6 tube and limits the noise interference to

100% modulation and to continuously lower percentages down to any modulation whatsoever, determined by the setting of the noise limiter control.

A noise limiter switch in conjunction with AVC provides for use of the noise limiter on CW or on modulated reception when interference is present.

Output Tube — The RCA 6K6GT output tube is resistance coupled from the A-F amplifier, an RCA 6SJ7 tube, and operates into an output transformer which has taps for matching into a 2.5 or 600 ohm load, or into headphones. The headphone winding is designed so that a maximum of approximately 10 milliwatts of power may be delivered to 20,000 ohm phones. Terminals are provided on the rear apron for the 2.5 and 600 ohm impedances. The output from the 600 ohm winding is fed directly to the 600 ohm terminals, neither of which is grounded. This winding may be used to feed a balanced 600 ohm line. The output from the 2.5 ohm tap is fed to the 2.5 ohm terminals through a two-position jack mounted on the panel. The headphone winding also connects to the jack. With the phone plug inserted into the jack in the first position, the phones are in parallel with the 2.5 ohm output and both are on. When the plug is pushed into the second position, the phones are connected to the phone winding and the 2.5 ohm output is cut off from the rear terminals. If no load is connected to the 2.5 or 600 ohm output terminals, the phones should always be used in the second position; as under this condition a load resistor is shunted across the 2.5 ohm tap to maintain impedance matching of the system.

Power Pack — The power pack mounted on the receiver chassis consists of a power transformer, rectifier tube RCA-5Y3GT, and filter. A tap switch is provided on the rear apron for changing the power transformer voltage tap. (See Figures 2 and 6.) The voltage for which the switch is set may be read directly on the switch. The instrument may also be operated from 6V. "A" and 250 to 300 V. "B" batteries, or Vibrator Power Supply Unit MI-8319.

Shielding — Interstage shielding is provided to insure stability under all operating conditions and to minimize oscillator radiation. Complete external shielding prevents coupling to any portion of the circuit except through the antenna circuit.

Tuning Meter — The necessary wires for connecting a tuning meter in the cathode circuit of the first I.F. tube have been included in the cable wiring. If and when meters become available, it will be a simple operation to install a tuning meter. A 5 milliamperere meter with zero deflection to the right is required.

V

PERFORMANCE

The performance data under technical summary and the data for the various curves, are approximate values taken on a sample receiver. Variations in these values are to be expected because of practical manufacturing tolerances. The data were taken with an

artificial antenna of 200 mmf. capacity for band 1 and 200 ohms resistance for bands 2 to 6 inclusive. The output was measured across a resistance of 2.5 ohms connected in place of the speaker voice coil. The selectivity switch was placed in position 2.

VI INSTALLATION

Power Supply—The power supply circuit is integral with the receiver. Determine line voltage and frequency and check with the rating of the receiver. The power transformer primary may be connected for any one of five voltage ranges by means of a tap switch. This switch is located in the rear apron of the receiver, and the voltage for which it is set may be read directly on the switch.

For Battery or other Supply Operation—For connections see Schematic Diagram Figure 11. It is only necessary to remove the plug from the socket on the rear of the receiver, and connect the batteries to the proper terminals as indicated by the schematic diagram. A battery cable terminating in an octal male plug is necessary for this purpose. A vibrator power supply MI-8319 is available which will operate the receiver directly from a 6 volt storage battery. For information on this power unit see Section XI.

Tubes—Inspect the chassis before applying power to see that all tubes are firmly seated in their respective sockets.

Antenna—The input impedance at the antenna terminals is designed to match a 200 ohm transmis-

sion line except on the broadcast band where a low frequency primary is used.

For general use it is recommended that a straight wire antenna between 25 and 50 feet long be used.

Speaker—Terminals for connection of a loudspeaker are indicated in Figures 2 and 6. The output transformer is designed to match a speaker having 2.5 ohms impedance.

Headphones—A jack is provided on the left of the front panel for plugging in a pair of headphones. There are two positions of the plug.

1. Half way in—for reception on both speaker and phones.
2. Fully in—for phone reception only.

See "CIRCUIT ARRANGEMENT" "Output Tube."

Mounting—The instrument may be placed on a table or mounted on a rack. For rack mounting loosen the panel mounting screws and remove the panel and chassis complete from the cabinet. The panel is equipped with standard slots for rack mounting.

VII OPERATION

Figure 3 illustrates the dials and control knobs.

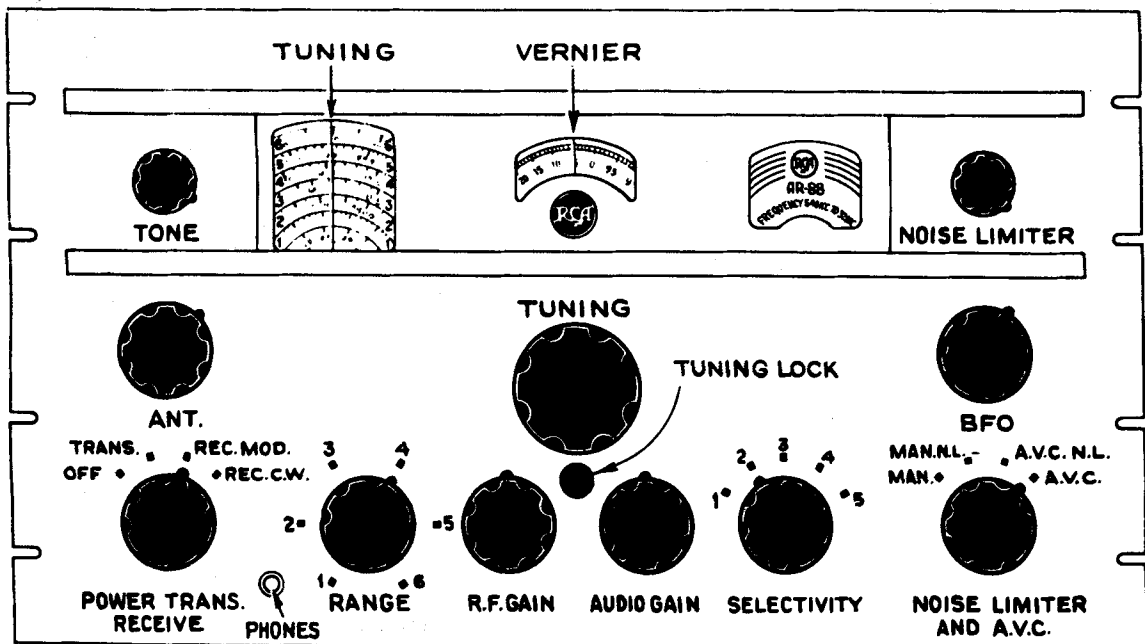

R-879D

Figure 3—Diagram of Front Panel

DIALS

The **Main Tuning Dial** is on the left and consists of a disc with seven scales, one for each of the six bands and a log scale. The Standard Broadcast Band is calibrated in kilocycles and the other five bands in megacycles.

The **Vernier Tuning Dial** is in the center and has a scale with arbitrary calibrations for exact tuning and log records of particular communication stations. It is used in conjunction with the log scale on the main tuning dial to give additional figures for logging.

CONTROLS

Power-Transmit-Receive Switch — This is a four-position switch. Starting from fully counterclockwise these positions are:

1. Power off.
2. Transmit position which gives energized tube filaments, open plate circuits, and shorted terminals for transmitter relay on the speaker terminal board on the back of the chassis. Connect relay to these two terminals for transmitter operation. See Figure 2.
3. Normal reception.
4. CW reception — Beat frequency oscillator switched on.

Selectivity Switch — This is a five-position switch and the band widths and control of selectivity are illustrated in the curves of Figure 12. The five positions are:

1. I-F band width for High Fidelity, modulated reception.
2. I-F band width for normal modulated reception.
3. Crystal Filter in — for CW telegraph or sharp modulated signal reception.
4. Crystal Filter in — for sharper CW telegraph reception.
5. Crystal Filter in — for sharpest CW telegraph reception.

Noise Limiter-AVC Switch — This is a four-position switch and starting from the fully counterclockwise position these are:

1. AVC and NL out — Manual gain only — for CW — no interference.

2. NL on, AVC out — Manual gain — for CW with interference.
3. NL and AVC on — for Modulated Reception with interference.
4. AVC on, NL out — for Modulated Reception — no interference.

R-F Gain Control — This continuously variable sensitivity control is for use in conjunction with the audio gain (Volume) control for all manual gain operation. With AVC on, it should as a rule be set to its fully clockwise position or may be turned to eliminate interference.

Noise Limiter Control — This control sets the instrument for operation at the required percentage value of Noise Limitation. The fully clockwise position limits the noise interference to 100% modulation. As the knob is turned counterclockwise, the noise interference is limited to continuously lower percentages of modulation so that in the fully counterclockwise position the Noise Limiter is operative on any modulation whatsoever. Normally, the fully clockwise position will be used, but under extreme conditions of interference a balance point should be found for maximum intelligibility of signal with best modulation and least noise.

Tone Control — This is a continuously variable control for reducing HF response. In the fully clockwise position the full tone is obtained and as turned counterclockwise, high tones are lessened. Set it to suit the particular tonal conditions for the signal being received.

Beat Frequency Oscillator Control — This control is normally used for CW code signals. It should be adjusted to give the desired audio pitch after the signal has been accurately tuned.

TUNING

For functions of controls see the foregoing paragraphs.

1. Turn receiver on and set the Power-Transmit-Receive Switch for the required type of operation.
2. Set Range Switch for band required.
3. Set Antenna Trimmer for maximum background noise.
4. Set Selectivity Switch for the required operating conditions — See Selectivity Curves — Figure 12.
5. Set Noise Limiter-AVC Switch for the required operating conditions.
6. Set R-F Gain Control fully clockwise.
7. Set Audio Gain Control about halfway.
8. Tune in the station.
9. Reset Audio Gain Control to give desired volume.
10. Reset Selectivity and Sensitivity (R-F Gain) Controls and Noise Limiter Control in accordance with requirements due to interference, station transmission, and other conditions.
11. Set Tone Control for preferred tone.
12. On CW operation set Power-Transmit-Receive Switch to "Rec. CW" (position 4) and set BFO Control to give desired pitch.
13. If the receiver is subject to vibration, the tuning may be locked by turning clockwise the knurled screw directly beneath the tuning knob. Turning the screw moderately tight will lock the tuning.

Diversity Reception — Connect together the terminals marked "diversity," Figure 2, on two or three of these receivers, and equip each receiver with a separate antenna. The "diversity" terminal is connected inside the receiver to the AVC circuits. Tune as explained.

VIII

MAINTENANCE

This receiver should maintain its correct factory adjustments over a reasonably long period of time. Causes of trouble and the probable sequence of their development are outlined in the following paragraphs:

1. **Vacuum Tubes** — A noticeable decrease in the sensitivity of the receiver usually indicates worn out vacuum tubes. If the sensitivity is low, remove and check the tubes in a reliable tube tester or substitute new tubes one at a time. See Technical Summary, and Schematic Diagram Figure 11. Tube socket voltages are given in Table 2 on page 14.
2. **Range Switch** — A switch may operate defectively on certain positions after long periods of inoperation. Usually rotating the switch back and forth several times will clean the contacts and operation will become normal.

A bad range-switch contact is likely to cause a change in the sensitivity of the receiver, or the frequency of a received signal, as the switch is moved back and forth slightly in a certain frequency band position. A further check is to

turn the switch off and on at one particular frequency band several times and note the apparent sensitivity of the receiver each time the switch comes into position. The sensitivity should be the same each time and may be adequately judged for this test by listening to the receiver background noise.

3. Circuit Alignment

Alignment Tools — Special tools for alignment of R-F and I-F circuits are provided. They are mounted in fuse clips on either side of the gang condenser cover, and are available after removing the large R-F unit cover. The shorter one of the two is for adjustment of all R-F and I-F coils, and the longer one is for adjustment of the plunger type trimmers. One end of this tool is for turning the lock nut on the trimmers and the other end has a hook for engaging in the hole in the end of the plungers. After adjustment, the lock nut should be securely tightened.

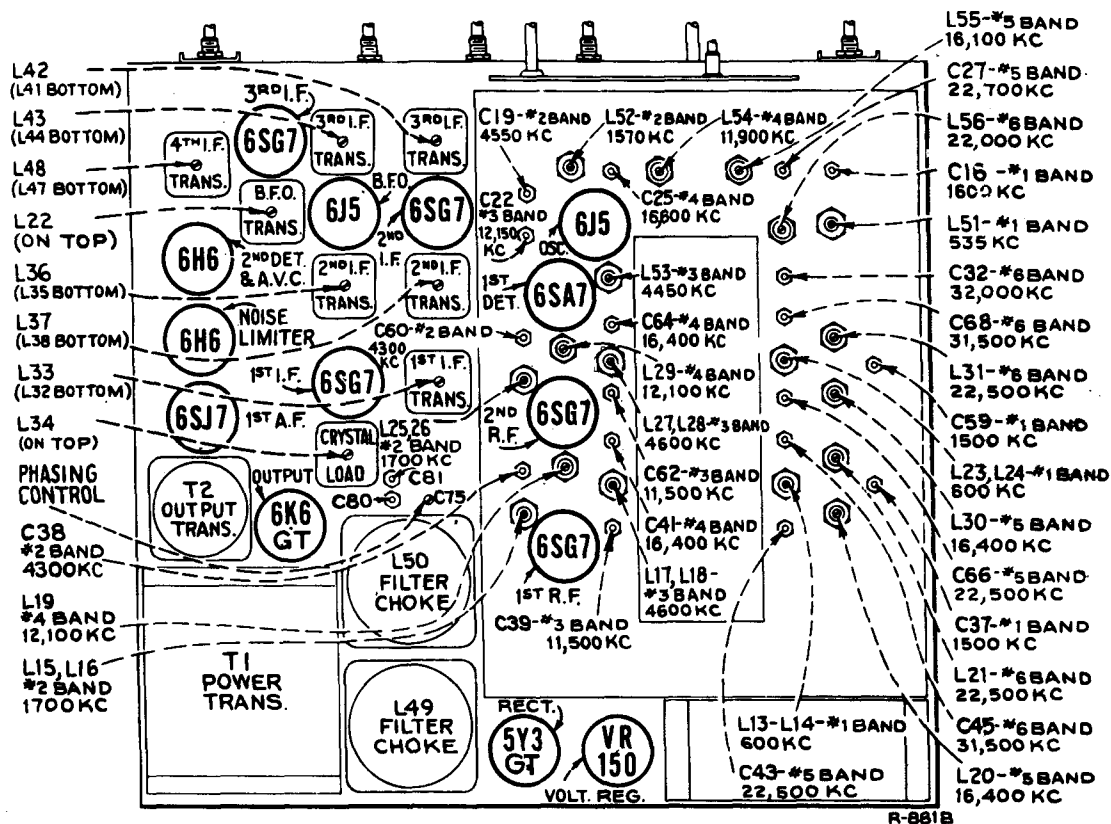

Figure 4—Diagram of Top of Chassis

I-F Alignment — The intermediate frequency is 455 kc. The most satisfactory method of I-F alignment is

by means of a sweep oscillator and cathode ray oscillograph. Follow the sequence as given below.

- Oscillograph Connections Vertical "HI" to Terminal C on last I-F Transformer (L47, L48), Vertical "LO" to chassis
- Dummy Antenna..... Insert in series with generator output, 0.01 mfd.
- Connection of Generator Output Lead..... See chart below
- Connection of Generator Ground Lead..... To chassis
- Position of Power-Transmit-Receive Switch..... Position 3 (Rec. Mod.)
- Position of R-F Gain Control..... Fully clockwise
- Position of Selectivity Switch..... Position 2
- Position of Noise Limiter and AVC Switch..... Position 4 (AVC)

LOCATION OF PARTS AND ALIGNMENT ADJUSTMENTS ON CHASSIS

Steps	Generator Connections	Trimmer Adjustments (See Fig. 5)	Trimmer Function
1	6SG7 — 3rd I-F Grid	L47, L48	4th I-F Transformer
2	6SG7 — 2nd I-F Grid	L41, L42, L43, L44	3rd I-F Transformer
3	6SG7 — 1st I-F Grid	L35, L36, L37, L38	2nd I-F Transformer
4	6SA7 — 1st Det. Grid	L32, L33	1st I-F Transformer

Before performing step 4 above, set crystal phasing control C-75 at approximately one half of its maximum capacity. This is approximately its final setting and changing it appreciably will slightly detune the first I-F transformer.

With Selectivity Switch in Position 2 the I-F band width is normal without over-coupling in the transformers. With Selectivity Switch in Position 1, the second and third I-F Transformers are expanded and

over-coupled. It is well in going through the alignment steps outlined above to check the I-F curves on the oscillograph screen with switch in Position 1 to see that the curves expand symmetrically.

Adjustment of Crystal Phasing Control — This adjustment is best made by means of a signal generator and a high resistance sensitive DC voltmeter such as the RCA Junior Voltomyst. Place Selectivity Switch in Position 3. Connect the generator to the grid of the

6SA7 first det., and the Voltmeter to Terminal C on last I-F transformer (L47, L48). Tune the generator to about 7 k.c. off I-F resonance and adjust the crystal phasing control C75 for minimum response.

Adjustment of Crystal Load Circuit— Make connections as for the preceding adjustment.

- (a) Place Selectivity switch in Position 3. Rock the signal generator frequency back and forth across the I-F resonant frequency and adjust the crystal load circuit trimmer L34 for symmetrical round-top curve.
- (b) Place the Selectivity switch in Position 4. Rock the signal generator frequency and adjust trimmer C81 for symmetrical curve.
- (c) Place the Selectivity switch in Position 5. Adjust trimmer C80 rocking the signal generator as for (a) and (b) above.

Output Meter Connections. Across speaker voice coil
 Dummy Antenna. See chart below
 Generator Modulation. 30% at 400 cycles
 Position of Tone Control. Fully clockwise
 Position of Antenna Trimmer. See chart below
 Position of Power-Transmit-Receive Switch. Position 3 (Rec. Mod.)
 Position of Range Switch. See chart below
 Position of R-F Gain Control. Fully clockwise
 Position of Audio Gain Control. Fully clockwise
 Position of Noise Limiter and AVC Switch. Position 4 (AVC)
 Position of Selectivity Switch. Position 2

LOCATION OF PARTS AND ALIGNMENT ADJUSTMENTS ON CHASSIS

Operation No.	Range Switch Position	Position of Dial	Generator Frequency	Dummy Antenna	Position of Antenna Trimmer	Trimmer Adjustments for Max. Peak Output (See Figures 2 and 4)	Trimmer Function
1	1	Extreme low end	535	200 mmf	—	L51	Low end osc.
2	1	Extreme high end	1,600	200 mmf	—	C16	High end osc.
3	Repeat 1 and 2 until extreme end frequencies are as indicated.						
4	1	1,500 k.c.	1,500	200 mmf	Max. output	C37, C59	1st & 2nd R-F
5	1	600 k.c.	600	200 mmf	Untouched	L2, L14, L24	Ant. & 1st and 2nd R-F
6	Repeat 4 and 5 until circuits remain in alignment over the band.						
7	2	Extreme low end	1,570	200 ohms	—	L52	Low end osc.
8	2	Extreme high end	4,550	200 ohms	—	C19	High end osc.
9	Repeat 7 and 8 until extreme end frequencies are as indicated.						
10	2	4,300 k.c.	4,300	200 ohms	Max. output	C38, C60	1st & 2nd R-F
11	2	1,700 k.c.	1,700	200 ohms	Untouched	L4, L16, L26	Ant. & 1st and 2nd R-F
12	Repeat 10 and 11 until circuits remain in alignment over the band.						
13	3	Extreme low end	4,450	200 ohms	—	L53	Low end osc.
14	3	Extreme high end	12,150	200 ohms	—	C22	High end osc.
15	Repeat 13 and 14 until extreme end frequencies are as indicated.						
16	3	11,500 k.c.	11,500	200 ohms	Max. output	C39, C62	1st & 2nd R-F
17	3	4,600 k.c.	4,600	200 ohms	Untouched	L6, L18, L28	Ant. & 1st and 2nd R-F
18	Repeat 16 and 17 until circuits remain in alignment over the band.						
*19	4	Extreme low end	11,900	200 ohms	—	L54	Low end osc.
20	4	Extreme high end	16,600	200 ohms	—	C25	High end osc.
21	Repeat 19 and 20 until extreme end frequencies are as indicated.						
22	4	16,400 k.c.	16,400	200 ohms	Max. output	C41, C64	1st & 2nd R-F
23	4	12,100 k.c.	12,100	200 ohms	Untouched	L8, L19, L29	Ant. & 1st and 2nd R-F
24	Repeat 22 and 23 until circuits remain in alignment over the band.						

The above three adjustments are very critical and must be made carefully to obtain symmetrical curves.

Adjustment of Wave Trap— A wave trap is connected across the broadcast band antenna primary to increase the rejection of I-F signal frequencies. With the range switch on Position 1, apply a modulated I-F signal to the antenna and ground terminals. Adjust the wave trap trimmer L57 (See Fig. 2) for minimum output. The wave trap should be adjusted before the final R-F alignment on No. 1 band, or the antenna coil alignment may be affected.

R-F Alignment— A signal generator covering a range from 535 k.c. to 32 megacycles, and an output voltmeter, are required. It is desirable to connect a speaker across the output terminals. The output voltmeter should then be connected across the speaker voice coil. The output impedance is 2.5 ohms. Remove the cover from over the R-F unit by loosening the four knurled screws and lifting off.

Operation No.	Range Switch Position	Position of Dial	Generator Frequency	Dummy Antenna	Position of Antenna Trimmer	Trimmer Adjustments for Max. Peak Output (See Figures 2 and 4)	Trimmer Function
*25	5	Extreme low end	16,100	200 ohms	—	L55	Low end osc.
26	5	Extreme high end	22,700	200 ohms	—	C27	High end osc.
27	Repeat 25 and 26 until extreme end frequencies are as indicated.						
28	5	22,500 k.c.	22,500	200 ohms	Max. output	C43, C66	1st & 2nd R-F
29	5	16,400 k.c.	16,400	200 ohms	Untouched	L10, L20, L30	Ant. & 1st and 2nd R-F
30	Repeat 28 and 29 until circuits remain in alignment over the band.						
*31	6	Extreme low end	22,000	200 ohms	—	L56	Low end osc.
32	6	Extreme high end	32,000	200 ohms	—	C32	High end osc.
33	Repeat 31 and 32 until extreme end frequencies are as indicated.						
34	6	31,500 k.c.	31,500	200 ohms	Max. output	C45, C68	1st & 2nd R-F
35	6	22,500 k.c.	22,500	200 ohms	Untouched	L12, L21, L31	Ant. & 1st and 2nd R-F
36	Repeat 34 and 35 until circuits remain in alignment over the band						

On all bands the oscillator tracks above the signal frequency.

If more than one peak is obtainable on oscillator, use the higher frequency peak.

* NOTE: On all coils, except Nos. 4, 5, and 6 band oscillator coils (L54, L55, and L56) turning the core clockwise increases the inductance. On the above three mentioned coils, turning the core clockwise decreases the inductance.

Adjustment of Beat Frequency Oscillator — Tune in a signal either R-F or I-F to exact resonance with Power-Transmit-Receive Switch at "Rec. Mod." (Fig. 3). Turn on beat frequency oscillator by turning

switch to "Rec. CW." If zero beat does not fall within the range of the BFO control, adjust BFO Trimmer L22 (see Fig. 4) until zero beat occurs at the mid-point setting of the BFO control.

IX

MECHANICAL CONSTRUCTION

The receiver has been designed to be very rugged so that it will stand up under severe conditions of use, and yet have all parts available for easy replacement. All component parts such as transformers, chokes, filter and by-pass capacitors, etc., are mounted with screws and nuts rather than with rivets. All wiring other than that involving high frequency circuits is made up in the form of a laced cable so that no loose leads are left floating which might cause damage or change capacity to various portions of the circuit. The tuning condenser is mounted so as to be rigid with respect to the tuning unit, and yet is flexible with respect to the chassis. This prevents distortion of the chassis from having any appreciable effect on the stability of the oscillator.

The R-F unit which consists of the tuning condenser, tuning unit, range switch, and all of the R-F and oscillator coils and trimmers, is mounted on a separate base which bolts to the main base. The various coils and trimmers on this base may be easily replaced by means of a single nut which screws on the individual mounting bushings. However if a major repair is to be made such as replacement of the range switch, it is necessary first to remove the complete R-F unit from the receiver. To do this the following procedure should be observed:

1. Remove the chassis and panel from the cabinet by removing the four panel mounting

screws and sliding the chassis forward out of the cabinet.

2. Remove the knobs by means of the small wrench held in the spring clip on the right hand side of the chassis. This wrench fits the set screws in all knobs except the main tuning knob. For this knob use an ordinary small screw driver.
3. Remove the panel by removing the eight nuts with which it is held to the support brackets.
4. Remove the large cover from the top of the R-F unit, by removing the four knurled nuts with which it is supported.
5. Remove the small cover from the tuning condenser, by removing the eight knurled nuts with which it is supported.
6. Remove the dial light sockets where they are clipped on to the tuning unit.
7. Remove the antenna trimmer shaft extension by loosening set screw in coupling with same wrench as used above for knobs.
8. Remove support bracket from flywheel tuning shaft.
9. Remove main dial, vernier dial, and flywheel by loosening set screws with same wrench as used for knobs.

10. Disconnect the eight leads which connect the R-F unit to the main base. These leads are as follows:

- (a) Two on the antenna terminal board (blue and black).
- (b) One on number 7 pin of the 6K6GT output tube (brown).
- (c) One on terminal E of the crystal load circuit (yellow).
- (d) One on terminal E of the first I-F Transformer (red).
- (e) One on terminal F of the first I-F Transformer (blue).
- (f) One on pin 6 of the second I-F tube (green).
- (g) One on pin 7 of the second I-F tube (brown).

In addition, the by-pass condenser which grounds to the R-F unit near the second I-F tube must be disconnected.

- 11. Remove eleven screws which hold R-F unit to main base. Three of these are on under side of chassis along the front edge. The other eight are removed from the top.
- 12. The R-F unit may now be removed from the bottom by lifting up first the rear of the R-F unit and sliding it back out of the opening. After the unit has been repaired it may be re-assembled by following the above procedure in reverse order.

TABLE 2—TUBE SOCKET VOLTAGES

Tube	Symbol	Plate Volt.	Screen Volt.	Cathode Volt.
RCA-6SG7				
1st R-F Amplifier..	1	235	150	0
RCA-6SG7				
2nd R-F Amplifier	2	235	150	0
RCA-6J5				
Oscillator	3	110	—	0
RCA-6SA7				
1st Detector.....	4	235	50	2
RCA-6SG7.				
1st I-F Amplifier..	5	235	150	7
RCA-6SG7				
2nd I-F Amplifier.	6	235	150	1.3
RCA-6SG7				
3rd I-F Amplifier.	7	235	150	3.1
RCA-6H6				
2nd Det. & AVC.	8	—	—	—
RCA-6H6				
Noise Limiter.....	9	—	—	—
RCA-6SJ7				
1st Audio Amplifier	10	83	34	0
RCA-6K6GT				
Power Output....	11	256	240	0
RCA-6J5				
B.F.O.	12	40	—	0
RCA-VR-150				
Voltage Regulator.	13	150	—	0
RCA-5Y3GT				
Rectifier	14	—	—	300

X

PARTS LIST

Symbol Designations	DESCRIPTION	RCA Drawing and Part No.	Symbol Designations	DESCRIPTION	RCA Drawing and Part No.
	CAPACITORS				
C1, 11, 33, 47, 51, 52, 54, 63, 83, 117, 118, 121, 122	Capacitor, 4,700 mmfd.	M-86079-531	C44, 46	Capacitor, 91 mmfd.....	K-90575-232
C2	Capacitor, antenna trimmer	M-253132-2	C48, 109, 110, 103, 106, 107	Capacitor, by-pass, assembly, 3 sections, 0.05 mfd. each	K-98034-1
C3, 6, 35, 40, 49, 50, 70, 77	Capacitor, variable, assembly, 8 sections.....	P-92444-501	C53	Capacitor, 6.8 mmfd.....	K-90581-305
C4, 5, 14, 34, 57	Capacitor, 220 mmfd....	K-90581-341	C53, 76, 93	Capacitor, by-pass, assembly, 3 sections, 0.01 mfd. each	K-98034-4
C7	Capacitor, 18 mmfd.....	K-90581-315	C61, 120	Capacitor, 15 mmfd.....	K-90581-313
C8	Capacitor, 33 mmfd.....	K-90581-321	C71, 95, 102, 79, 84, 92	Capacitor, by-pass, assembly, 3 sections, 0.1 mfd. each	K-98034-2
C9, 10	Capacitor, 22 mmfd.....	K-90581-317	C75	Capacitor, crystal phasing trimmer.....	M-253132-6
C12	Capacitor, 56 mmfd.....	K-90581-227	C86	Capacitor, BFO Trimmer	M-253132-1
C13, 26, 29, 42, 65, 67, 69	Capacitor, 82 mmfd.....	K-90578-231	C96, 97, 98	Capacitor, filter pack, assembly, 3 sections, 4 mfd. each.....	P-72026-515
C15, 21	Capacitor, 15 mmfd.....	K-90580-213	C99, 112, 113	Capacitor, by-pass, assembly, 3 sections, 0.25 mfd. each.....	K-98034-3
C16, 19, 22, 37, 59	Capacitor, air trimmer..	M-95534-503	C105	Capacitor, 560 mmfd.....	M-86034-502
C17	Capacitor, 525 mmfd.....	M-86079-503	C111, 116	Capacitor, 2,700 mmfd....	M-86034-534
C18	Capacitor, 13 mmfd.....	K-90580-212	C119	Capacitor, 3,000 mmfd....	K-251248-3
C20	Capacitor, 1,550 mmfd....	M-86079-533	C123	Capacitor, 10 mmfd.....	K-90581-309
C23, 28	Capacitor, 3,000 mmfd....	P-721133-9		CONNECTORS	
C24	Capacitor, 2,700 mmfd....	P-721133-8	J1	Socket	M-421395-509
C25, 27, 32, 41, 43, 45, 64, 66, 68	Capacitor, air trimmer...	M-95534-501	J2	Phone Jack.....	K-98965-2
C30	Capacitor, 3,900 mmfd....	P-720538-46		INDUCTORS	
C31	Capacitor, 75 mmfd.....	K-90577-230	L1, 2	Antenna Coil, No. 1 band	M-95520-502
C36, 58	Capacitor, 180 mmfd.....	K-90581-239	L3, 4	Antenna Coil, No. 2 band	M-95521-501
C38, 39, 60, 62, 80, 81	Capacitor, air trimmer...	M-95534-502	L5, 6	Antenna Coil, No. 3 band	M-95521-502
			L7, 8	Antenna Coil, No. 4 band	M-95521-503
			L9, 10	Antenna Coil, No. 5 band	M-95521-504

PARTS LIST (Continued)

Symbol Designations	DESCRIPTION	RCA Drawing and Part No.	Symbol Designations	DESCRIPTION	RCA Drawing and Part No.
L11, 12	Antenna Coil, No. 6 band	M-95519-507	R54	Resistor, 2,700 ohms, 1/2 watt	K-850981-67
L13, 14, 23, 24	R.F. Coil, No. 1 band	M-95520-501	R55	Resistor, 6,800 ohms, 1/2 watt	K-850981-72
L15, 16, 25, 26	R.F. Coil, No. 2 band	M-95520-503	R56	Resistor, 5 ohms, 4 watts	K-90497-4
L17, 18, 27, 28	R.F. Coil, No. 3 band	M-95520-504		SWITCHES	
L19, 29	R.F. Coil, No. 4 band	M-95519-501	S1 to 16	Range Switch	M-253097-1
L20, 30	R.F. Coil, No. 5 band	M-95519-502	S17 to 50	Selectivity Switch	M-253134-1
L21, 31	R.F. Coil, No. 6 band	M-95519-503	S21, 22	A.V.C.—N.L. Switch	M-253099-1
L49, 50	Coil, Filter Choke	K-901433-501	S23, 24	Off-Trans.-Rec. Switch	M-253098-1
L51	Oscillator Coil, No. 1 band	M-95520-505	S25	Voltage Tap Switch	K-99585-1
L52	Oscillator Coil, No. 2 band	M-95520-506		TRANSFORMERS	
L53	Oscillator Coil, No. 3 band	M-95520-507	T1	Transformer, Power, Universal	K-901432-501
L54	Oscillator Coil, No. 4 band	M-95519-504	T2	Transformer, Output	K-901666-501
L55	Oscillator Coil, No. 5 band	M-95519-505	T3	Transformer, 1st I.F.	P-92430-501
L56	Oscillator Coil, No. 6 band	M-95519-506	T4	Transformer, Crystal Load I.F.	P-92430-506
L57	Wave trap, 455 k.c.	M-76299-505	T5, 6	Transformer, 2nd I.F.	P-92430-503
	RESISTORS		T7, 8	Transformer, 3rd I.F.	P-92430-503
R1, 6, 19, 49	Resistor, 33,000 ohms, 1/2 watt	K-850981-80	T9	Transformer, 4th I.F.	P-92430-502
R2, 33, 36, 47	Resistor, 2.2 meg, 1/2 watt	K-850981-33	T10	Transformer, BFO	P-92430-504
R3, 10, 12, 16, 22, 26, 31, 34	Resistor, 1,000 ohms, 1/2 watt	K-82283-62		TERMINAL BOARDS	
R4	Resistor, 56,000 ohms, 1/2 watt	K-82283-83	TB1	Terminal Board, Antenna and Ground	M-253669-2
R5	Resistor, 1 meg, 1/2 watt	K-82283-31	TB2	Terminal Board, Output	M-253669-1
R7, 17	Resistor, 10 ohms, 1/2 watt	K-867970-338	TB4	Terminal Board, Output	M-253669-3
R8, 18	Resistor, 5,600 ohms, 1/2 watt	K-82283-71		TUBE SOCKETS	
R9, 14	Resistor, 100,000 ohms, 1/2 watt	K-82283-86	X1, 2, 7, 8, 11	Tube Socket	M-421395-507
R11	Resistor, 10,000 ohms, 1/2 watt	K-82283-74	X3, 4, 9	Tube Socket	M-421395-508
R13	Resistor, 560 ohms, 1/2 watt	K-850981-59	X5, 6, 10, 13, 14	Tube Socket	M-421395-509
R20, 39	Resistor, 100 ohms, 1/2 watt	K-82283-50	X12	Tube Socket	M-421395-510
R23, 27, 50, 57, 58	Resistor, 560,000 ohms, 1/2 watt	K-82283-95		CRYSTAL	
R25	Resistor, 180 ohms, 1/2 watt	K-82283-53		Crystal (455 KC)	MI-19454-1
R30	Resistor, 2,700 ohms, 4 watts	K-90497-3		MISCELLANEOUS	
R32	Resistor, 390 ohms, 1/2 watt	K-850981-57		Resistor Board	K-98968-1
R35	Resistor, 690,000 ohms, 1/2 watt	K-850981-96		Tuning Unit	P-92417-1
R37	Resistor, 1 meg, 1/2 watt	K-850981-31		Dial Window	29932-2
R38	Resistor, 1.5 meg, 1/2 watt	K-850981-100		Tuning Dial Assembly	K-98947-501
R40	Resistor, 270,000 ohms, 1/2 watt	K-850981-91		Vernier Dial Assembly	K-98947-502
R41	Resistor, 100,000 ohms, 1/2 watt	K-850981-86		Flywheel Bracket Assembly	K-99819-501
R42	Resistor, 390,000 ohms, 1/2 watt	K-82283-93		Flexible Coupling	K-98950-1
R43	Resistor, 100 ohms, 4 watts	K-90497-1		Battery Plug Assembly	K-98985-501
R44	Resistor, 160 ohms, 4 watts	K-90497-2		Pilot Lamp Socket Assembly	K-98983-502
R45	Resistor, 15 ohms, 1/2 watt	K-867970-340		Pilot Lamp Socket Assembly	K-98982-1
R46	Resistor, R.F. Gain Control	K-251402-2		Pilot Lamp	K-61114-15
R48	Resistor, Noise Limiter Control	K-251402-2		Lock Screw	K-99821-1
R51	Resistor, Audio Gain Control	K-251402-3		Wrench (Knob & Coupling Set Screw)	K-828505-12
R52	Resistor, Tone Control	K-251402-1		Knob (Large)	P-712336-503
R53	Resistor, 330,000 ohms, 1/2 watt	K-82283-92		Knob (Medium)	P-712336-505
				Knob (Small)	P-712336-507
				Set Screw (Large Knob)	K-59101-6
				Set Screw (Medium Knob)	K-843365-13
				Set Screw (Small Knob)	K-843365-12
				Power Cord	K-99883-1
				I.F. Transformer Adj. Tool	M-86183-501
				Air Trimmer Adj. Tool	M-81059-501
				Coupling (Ant. Trimmer Shaft)	K-99630-1
				Ant. Trimmer Shaft	K-99631-1

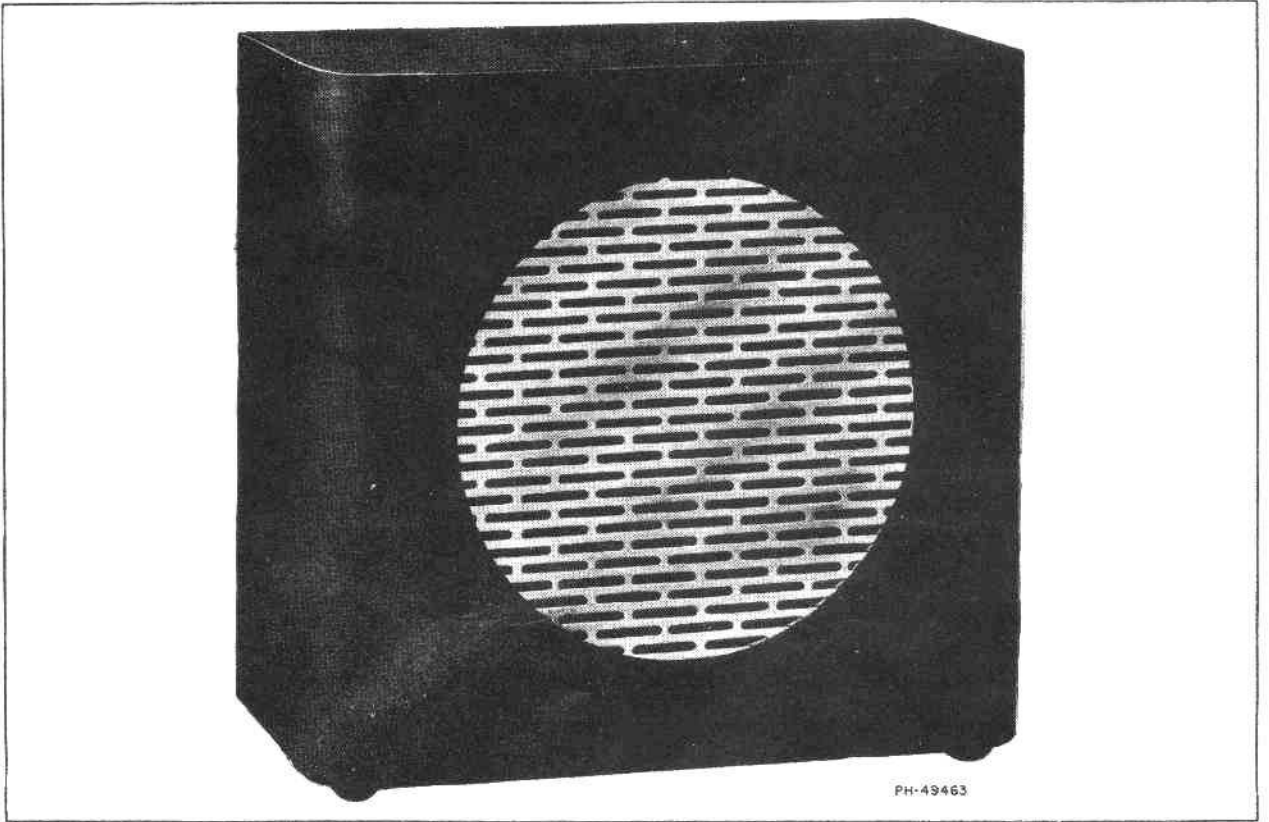

Figure 5—Loudspeaker

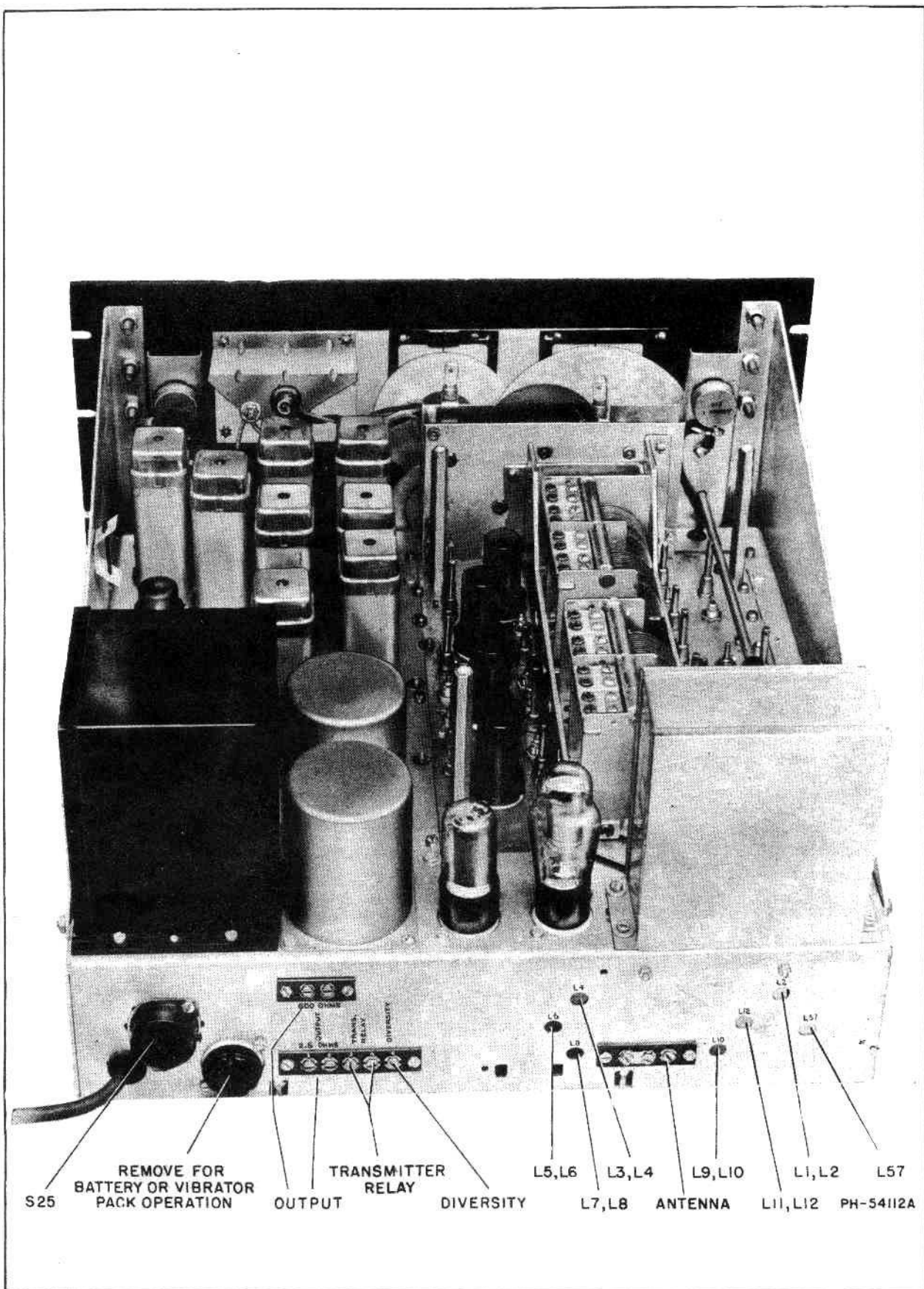

Figure 6—AR-88 Chassis

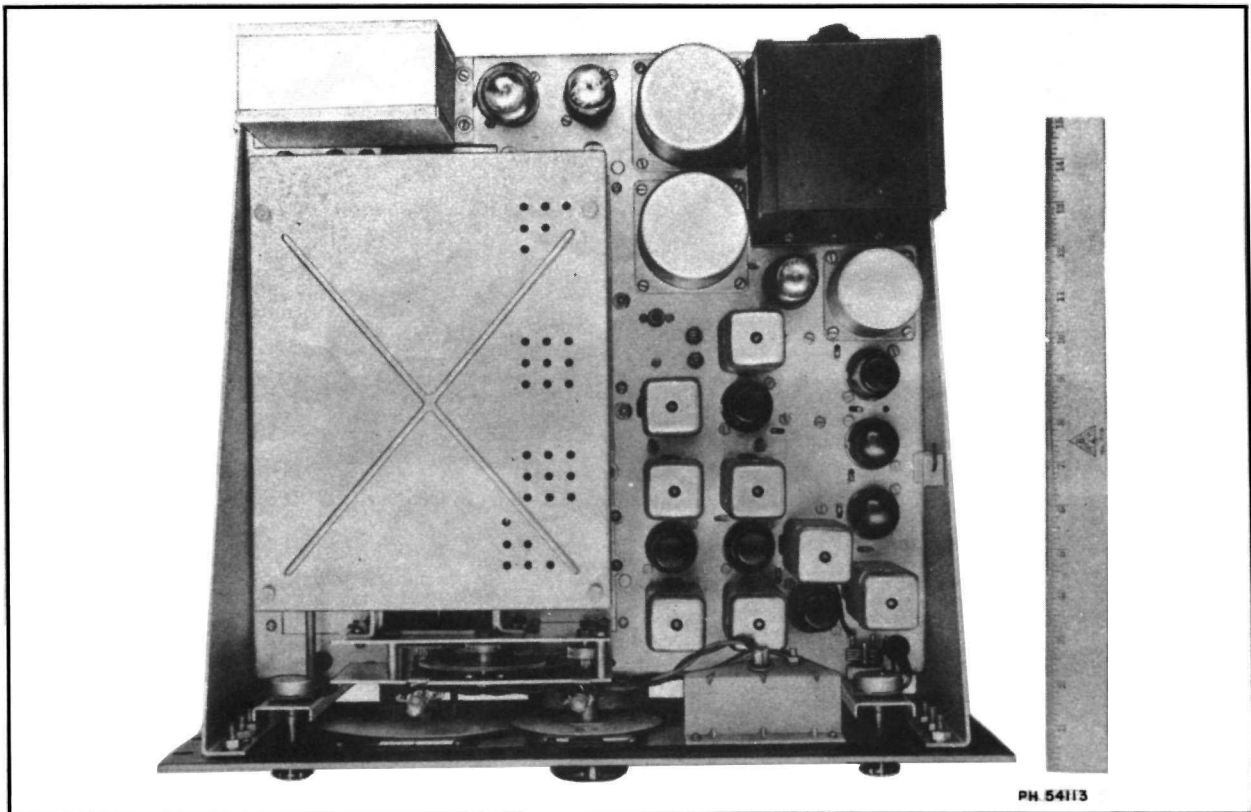

Figure 7—Top View of Chassis

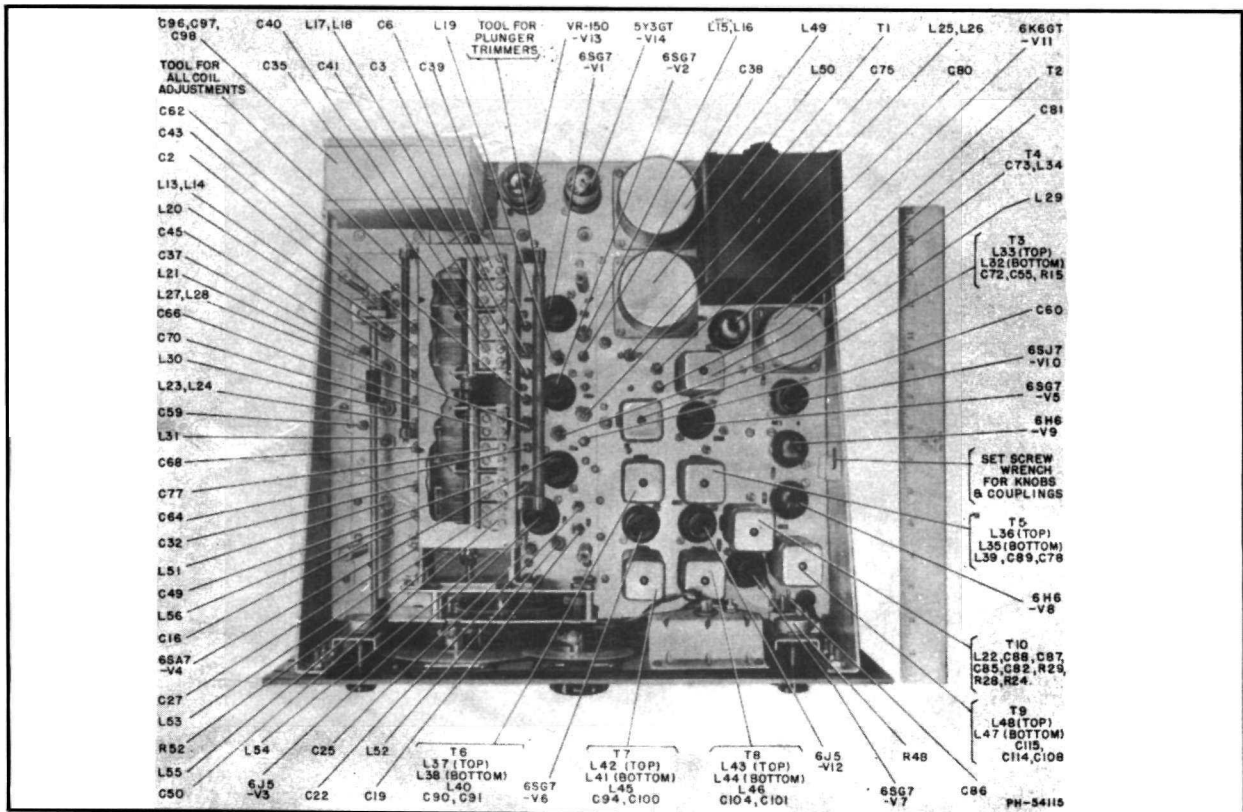

Figure 8—Top View of Chassis—Covers Removed

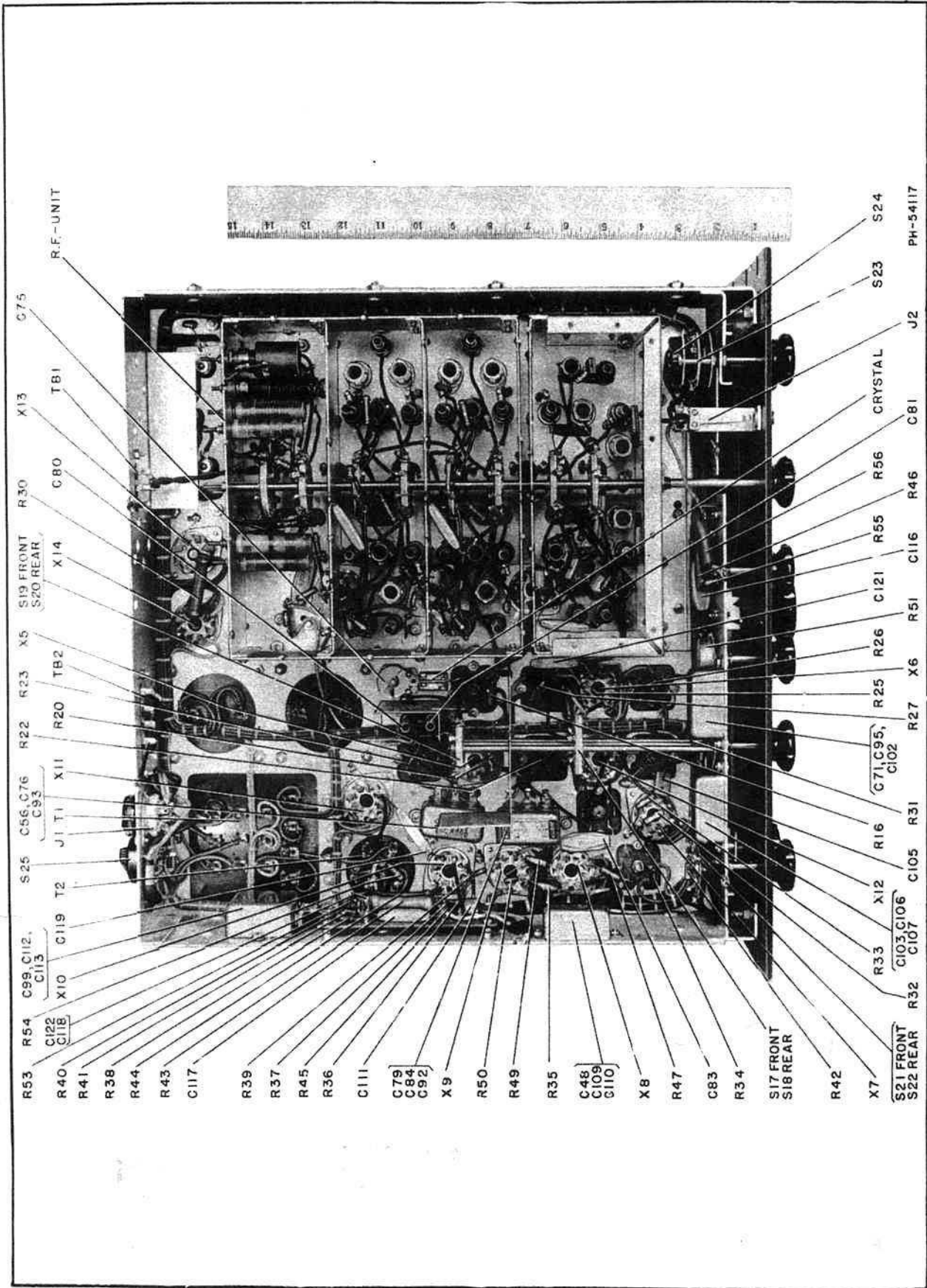

Figure 9—Bottom View of Chassis

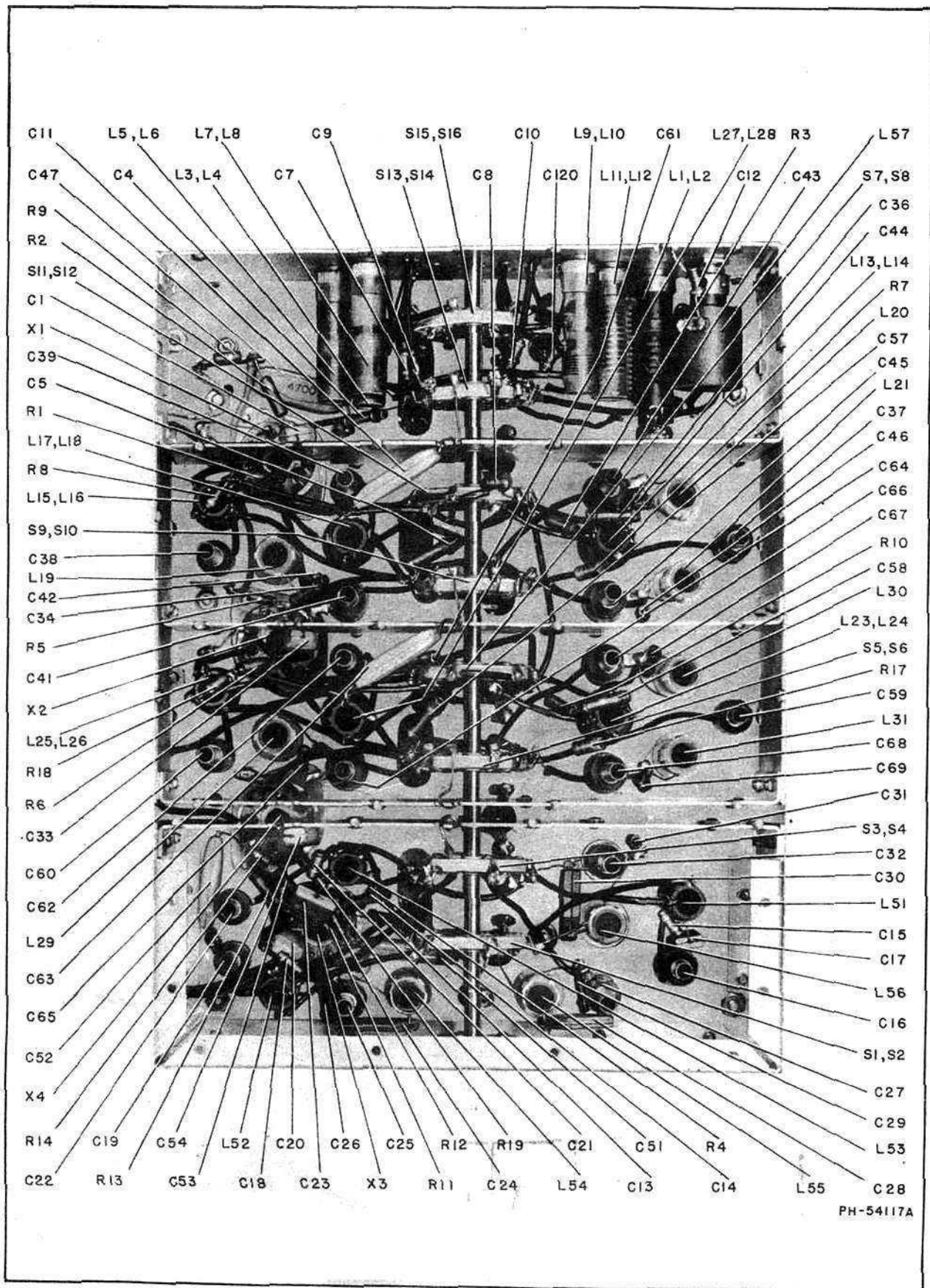
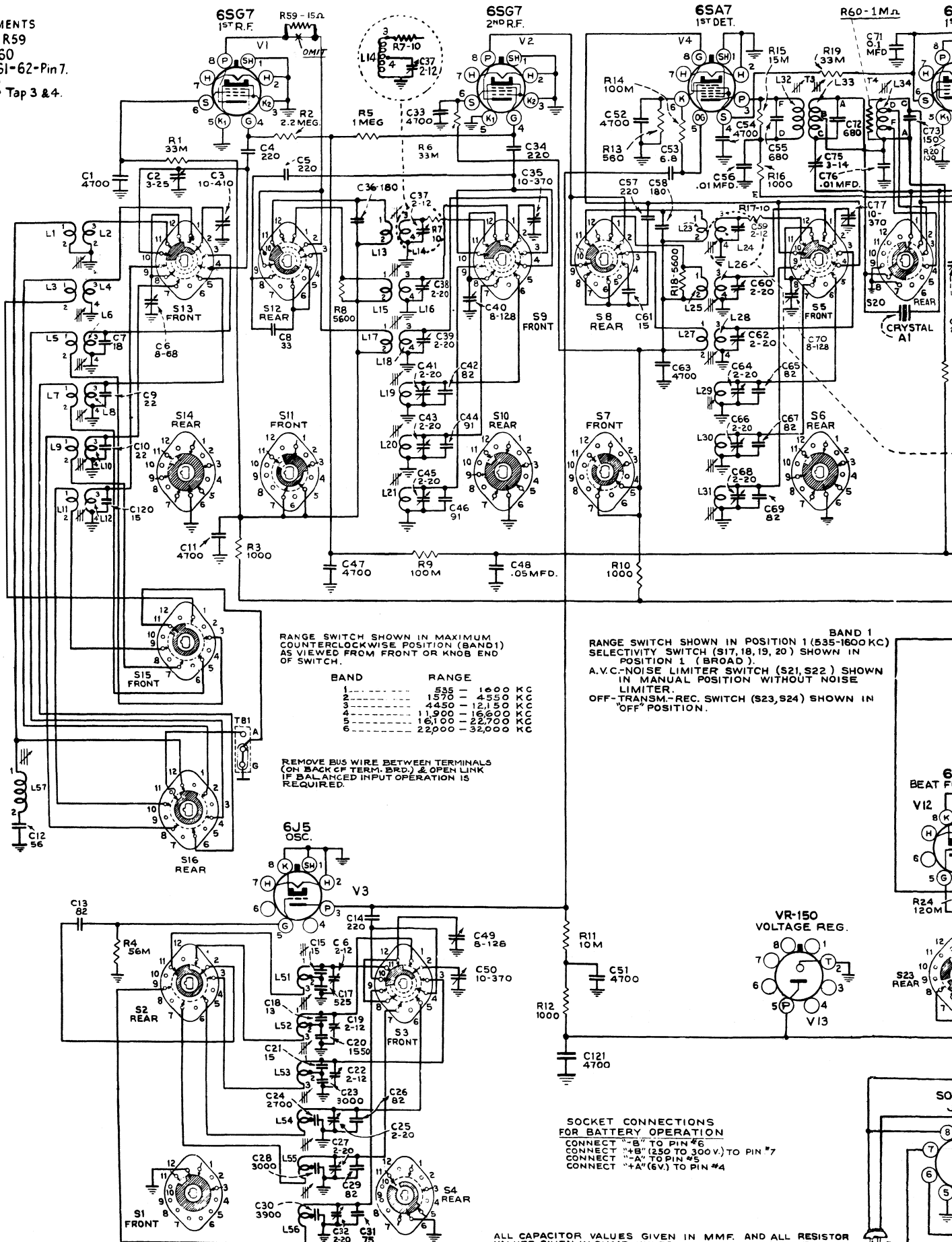

Figure 10—R-F Unit

AMENDMENTS

- 1st RF - R59
- T4 - R60
- N/L - R61 - 62 - Pin 7.
- L 14
- L 24 - Tap 3 & 4.



RANGE SWITCH SHOWN IN MAXIMUM COUNTERCLOCKWISE POSITION (BAND 1) AS VIEWED FROM FRONT OR KNOB END OF SWITCH.

BAND	RANGE
1	535 - 1600 KC
2	1570 - 4550 KC
3	4450 - 12,150 KC
4	11,900 - 16,600 KC
5	16,100 - 22,700 KC
6	22,000 - 32,000 KC

REMOVE BUS WIRE BETWEEN TERMINALS (ON BACK OF TERM. BRD.) & OPEN LINK IF BALANCED INPUT OPERATION IS REQUIRED.

BAND 1 RANGE SWITCH SHOWN IN POSITION 1 (535-1600 KC) SELECTIVITY SWITCH (S17, 18, 19, 20) SHOWN IN POSITION 1 (BROAD). A.V.C.-NOISE LIMITER (S21, S22) SHOWN IN MANUAL POSITION WITHOUT NOISE LIMITER. OFF-TRANSM.-REC. SWITCH (S23, S24) SHOWN IN "OFF" POSITION.

SOCKET CONNECTIONS FOR BATTERY OPERATION
 CONNECT "B" TO PIN #6
 CONNECT "+B" (250 TO 300 V.) TO PIN #7
 CONNECT "A" TO PIN #5
 CONNECT "+A" (6V.) TO PIN #4

ALL CAPACITOR VALUES GIVEN IN MMF. AND ALL RESISTOR VALUES GIVEN IN OHMS UNLESS OTHERWISE SPECIFIED. TUBE SOCKETS ARE DESIGNATED BY SYMBOL "X" FOR CORRESPONDING TUBE "V" NUMBER.

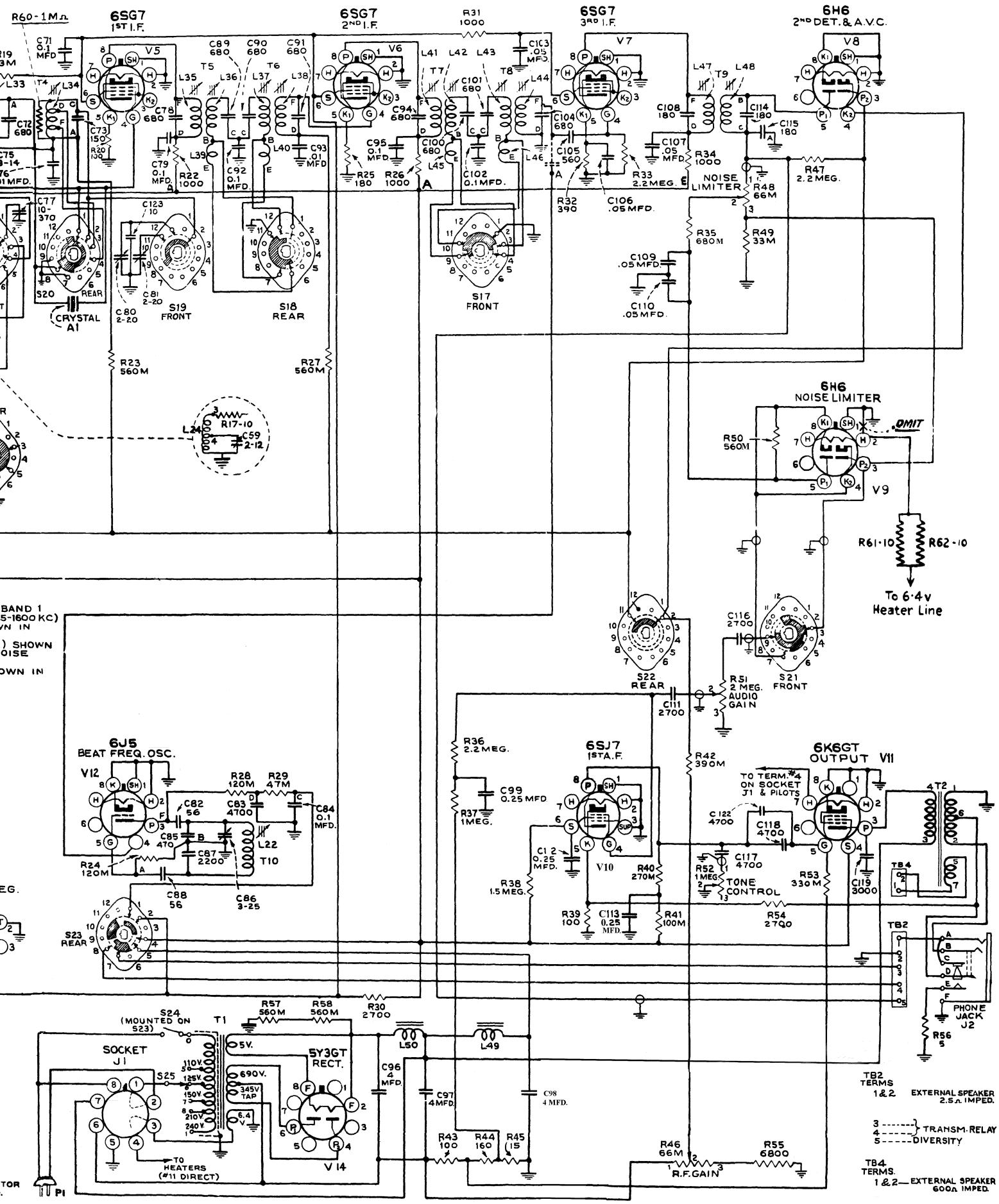

Figure 11— Schematic Diagram

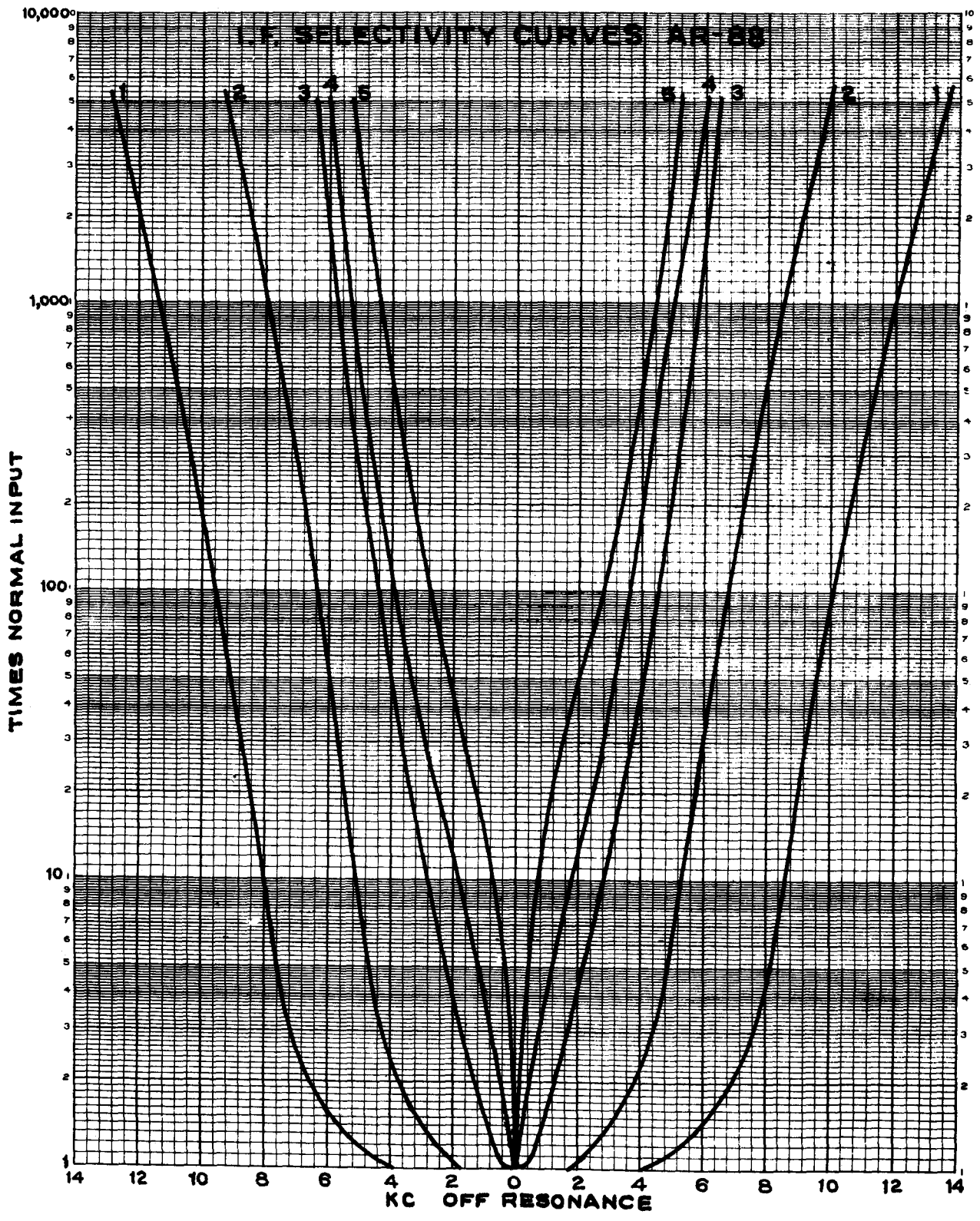

Figure 12—Selectivity Curves

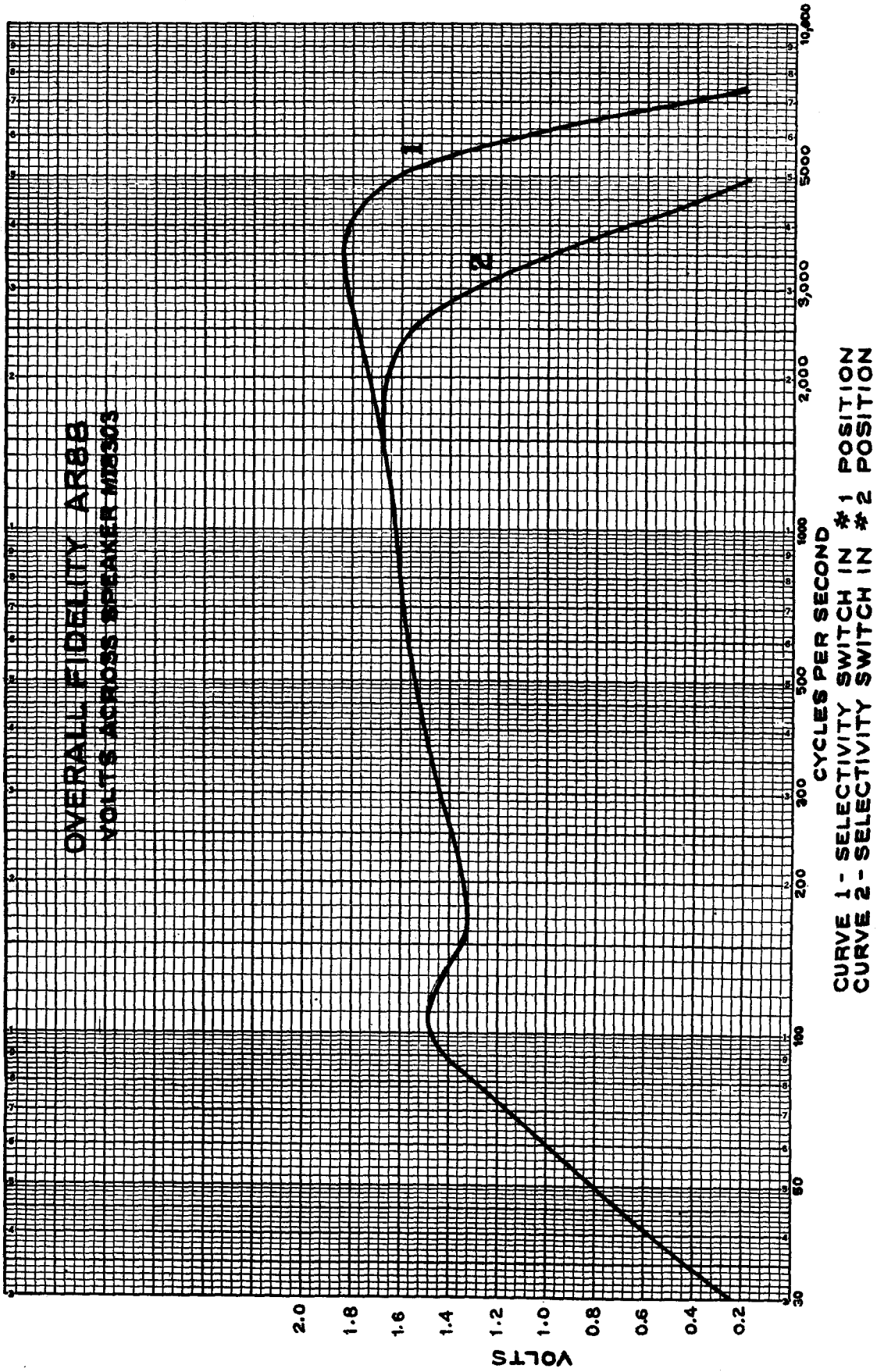

Figure 13—Fidelity Curves

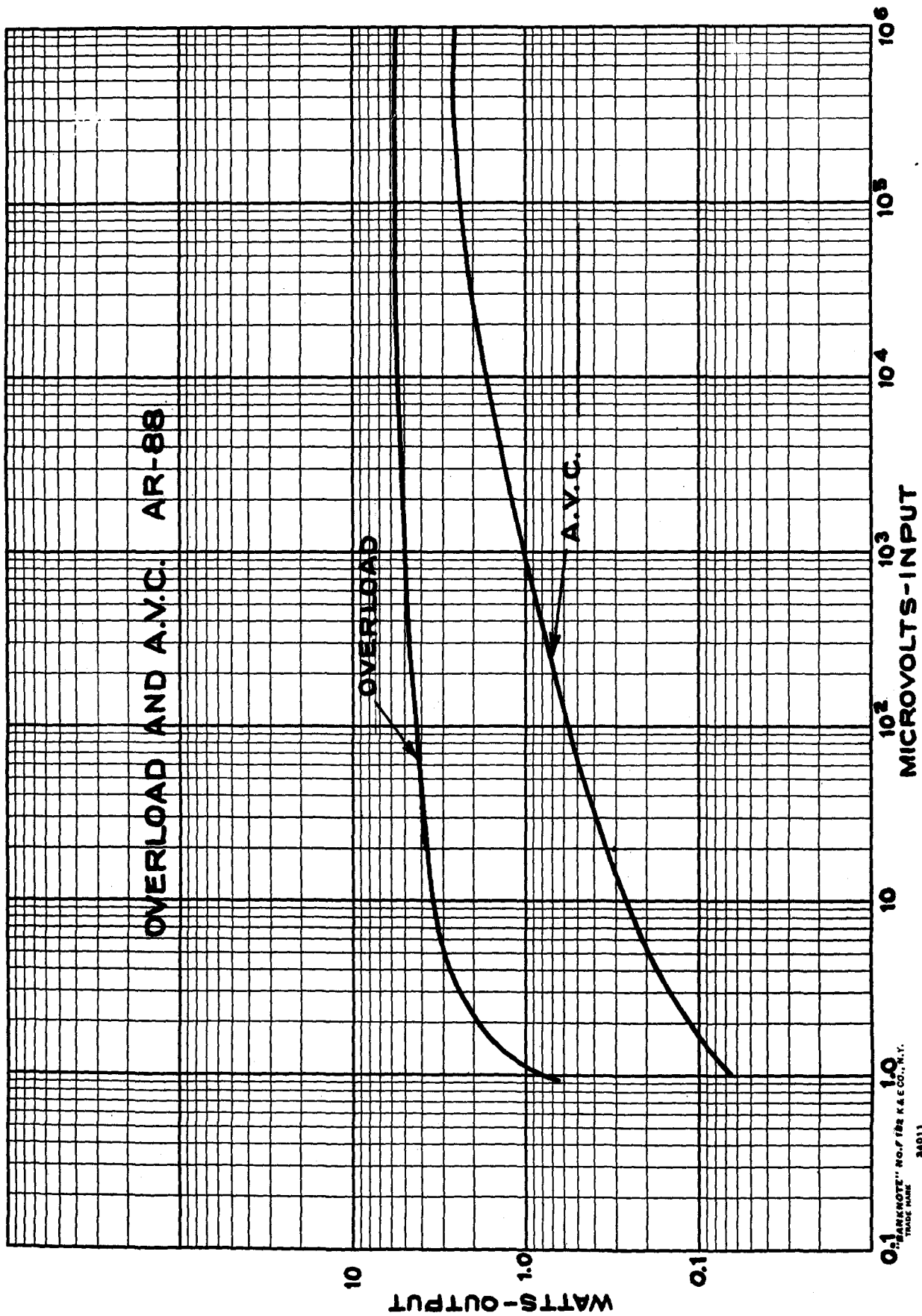

Figure 14—AVC Curves

XI
VIBRATOR POWER SUPPLY UNIT
MI-8319
(6-VOLT STORAGE-BATTERY OPERATION)

TECHNICAL SUMMARY

Electrical Characteristics—

Output	300 volts, 90 ma.
Battery Voltage	6 to 8 volts
Total current drain (operating AR-88 receiver)	12 amperes
Fuse Rating	15 amperes

Tube Complement..... 1 RCA-OZ4

Mechanical Specifications—

Dimensions—

Height	6½ inches
Width	5 inches
Depth	5½ inches
Weight (net)	7 pounds

EQUIPMENT

The MI-8319 identifies the equipment furnished with the power supply unit and consists of the following items:

1—Vibrator Power Supply Unit, complete with vibrator and RCA-OZ4 rectifier tube.

1—Power Cable, approximately 8 feet long, equipped with power switch, fuse holder and fuse, terminals for connecting to the vibrator power supply unit, and terminating in a plug for connecting to the associated receiver.

DESCRIPTION

The MI-8319 vibrator power supply unit is primarily designed for the purpose of adapting the General Purpose Communication Receiver (Model AR-88) to 6-volt battery operation. Four rubber feet are provided for resting the unit on a table or shelf. If preferred, these feet may be removed to expose threaded studs by which the unit may be bolted permanently in position.

NOTE—The power supply unit must be mounted with the vibrator in an approximately vertical position.

Direct current at high potential is obtained by means of a non-synchronous vibrator used in conjunction with a step-up transformer. Rectification is obtained by the use of an RCA-OZ4 rectifier tube. This power unit has been designed and tested to operate under a wide variety of climatic conditions.

INSTALLATION

CONNECTING THE POWER CABLE TO THE VIBRATOR POWER SUPPLY UNIT— In order to connect the power cable to the vibrator power supply unit, first remove the terminal board cover from the power

unit by removing the two self-tapping screws in the cover. About four feet from the end of the cable to which the two large battery clips are attached, a group of four wires, each about four inches long and

equipped with a spade terminal, extends from the cable. These leads should be connected to the power unit terminal board — the *brown* lead to the terminal marked “A — HOT,” the *yellow* lead to “B-” and the *red* lead to “B+.” Replace the terminal board cover with the three leads extending from the open end of the cover, connecting the *black* lead under one of the screws which hold the cover.

MOUNTING THE SWITCH — Fasten the switch to the bracket on the top of the transformer can.

CONNECTING THE POWER CABLE TO THE RECEIVER — Remove the plug from the socket on the rear apron of the receiver. Insert the plug, on the end of the vibrator power supply cable, into this socket.

ADJUSTMENTS — A four-position rotary switch on the rear of the chassis is used to adjust the vibrator output voltage to compensate for variations in the battery voltage. The positions on this switch are numbered from “1” to “4” inclusive. The position in which the switch rotor is placed is indicated by the direction in which the screw-driver slot in the rotor shaft is pointing. For proper selection of the switch position, consult the following table:

Switch Position	Battery Voltage
4	6.0 to 6.5 volts
3	6.5 to 7.0 volts
2	7.0 to 7.5 volts
1	7.5 to 8.5 volts

CONNECTING THE POWER CABLE TO THE STORAGE BATTERY — Turn the power switch in the power cable to the “OFF” position. There are two battery clips connected to one end of the power cable, each clip serving to terminate a pair of wires. On one clip, both wires are *black* while on the other clip one wire is *green* and the second is *brown*. Connect the clip with the two *black* wires securely to the *negative* (–) terminal of the storage battery. Be sure to make good contact at this point. Connect the clip with the *green* and *brown* wires securely to the *positive* (+) terminal of the battery. The receiver is now ready for operation from the power supply unit.

NOTE — Since the power line cord supplied with the receiver is completely out of the circuit when the vibrator power supply is used, this cord should be wound up and placed inside of the receiver case in the space between the chassis and the case wall.

OPERATION

The switch on the power cable must be used for turning the receiver on and off, the power switch on the receiver being automatically cut out of the circuit when the vibrator power supply unit is used. To prevent impairment of normal operation, the following precautionary measures should be observed:

1. Never remove the rectifier tube while the power supply unit is in operation. Serious damage to circuit elements, or even to the vibrator itself, may result under these conditions.

2. Never disconnect any leads on the power cable unless the power switch is turned *off*. Never tighten any terminal screws unless the power is definitely *off*. Should it become necessary to tighten any or all of the screws on the vibrator power unit terminal board, always first remove the battery clips from the battery. ***THIS IS EXTREMELY IMPORTANT, SINCE FAILURE TO FOLLOW THIS RULE WILL INVARIABLY RESULT IN SERIOUS DAMAGE TO THE VIBRATOR POWER UNIT ITSELF.***

MAINTENANCE

A schematic diagram of the vibrator power supply unit is shown in Figure 15. The diagram symbol of each part is repeated in the parts list to facilitate identification by means of cross reference.

Service generally consists of replacing the vibrator which may have deteriorated through prolonged usage. If excessive output hum should occur during operation, the cause may be a filter-circuit breakdown, such as leaky or short-circuited filter capacitors.

When servicing the power supply unit, disconnect it from its source of voltage supply and, using an ohmmeter, check through for continuity.

Capacitors should be tested by first removing one side from the adjacent connections so that the capacitor under test is not connected in the circuit.

The power supply unit is protected by a 15-ampere fuse which in the event of failure should be replaced by one of identical rating.

PARTS LIST

Symbol Designation	Description	Stock No.	Symbol Designation	Description	Stock No.
C1	Capacitor, 0.5 mfd., 50 v.....	18080	P1	Plug, 8-prong, power cable.....	3
C2	Capacitor, 0.005 mfd., 1,600 v.....	63813	R1	Resistor, 5,000 ohms.....	37122
C3	Capacitor, 0.05 mfd., 600 v.....	63814	S1	Included in Cable W1.....	
C4	Capacitor, 0.1 mfd., 600 v.....	63815	S2	Switch-voltage tap.....	37119
C5, C8	Capacitor, 0.0005 mfd., mica.....	63816	T1	Transformer, power.....	63810
C6	Capacitor, 10 mfd., 450 v.....	63817	TB1	Terminal Strip, external.....	63819
C7	Capacitor, 25 mfd., 40 v.....	63818	W1	Cable, power.....	63822
E1	Vibrator.....	63821	TS1	Socket tube octal.....	31251
L1	Choke, "A" line.....	63820	VS1	Socket, vibrator, 4-pin.....	31769
L2	Choke, "B" line.....	63811			

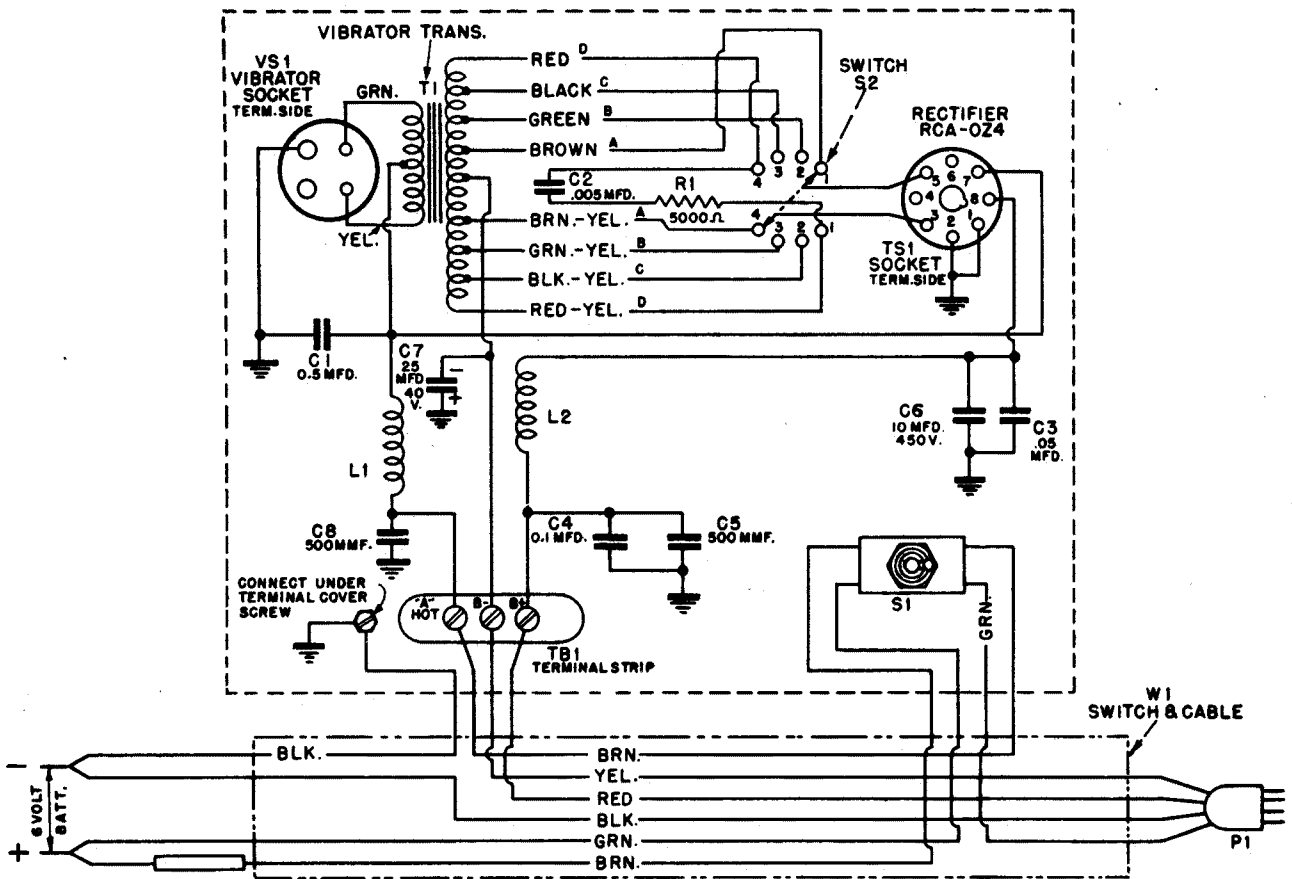

FIGURE 15 — VIBRATOR POWER SUPPLY UNIT
(Schematic Diagram M-253452)

ADDENDA

26 November 1943

MODEL AR-88-D

For IB-25927-3

Page 14 Section X PARTS LIST - CAPACITORS

1st Column

Line 17. Omit C15, 21 Capacitor, 15 mmfd. K-90580-213

Line 21. Change C18 to read C15, 18, 21.

2nd Column

Line 1. Omit "46".

New Line Add C46 Capacitor, 35 mmfd. K-98054-9

Page 15 Section X PARTS LIST - INDUCTORS

1st Column

Line 2. Change Drawing and Part No. from M-95520-501 to M-95520-508.

Page 19 Figure 9. Make lead changes as in Figure 10 on RF Unit.

Page 20 Figure 10. Change lead from C37 to coil assembly L13, 14 to connect to other side of coil assembly L13, 14. Change lead from C59 to coil assembly L23, 24 to connect to other side of coil assembly L23, 24.

Page 21 Figure 11. Change Schematic Diagram at L14, C37 and R7 to:

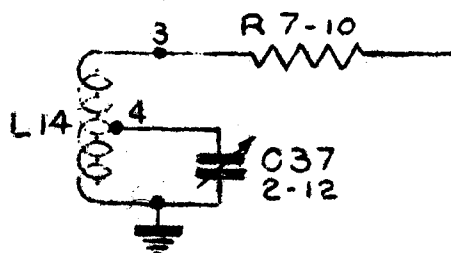

Change Schematic Diagram at L24, C59 and R17 to:

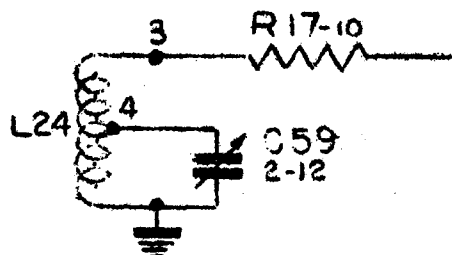

R C A DB TUNING METER KIT

MI-17210

for use with

RCA COMMUNICATIONS RECEIVERS AR-88D, and CR-91

1. Purpose

The DB Tuning Meter when assembled on the front panel of the General Purpose Communications Receiver AR-88D or CR-91 provides for critical tuning of stations and for accurate comparative signal strength measurements.

2. Material

The Tuning Meter Kit consists of the following parts and these should be checked against the parts list MI-17210 included with same.

Symbol	Quantity	Description	RCA Referen
(1)	1	Meter, DB above 1 Microvolt	Dwg.K-98949-1
(2)	1	Gasket	" K-99628-1
(3)	1	Meter Plate	" K-98942-1
(4)	3	Flat Head Screw # 6-32 x 1/2"	" K-57466-113
(5)	5	Round Head Screw - # 4-40 x 5/16"	" K-57454-107
(6)	5	Lockwasher # 4	" K-59049-2
(7)	1	Hex. Nut # 4-40	" K-57435-103
(8)	1	Terminal Board	" K-897192-1
(9)	1	Lead, Black, 2 1/2" long, tinned ends	Pch.Spec. P8-528-
(10)	1	Variable Resistor R21	Dwg.K-251402-4
(11)	1	Hex. Nut 3/8-32	" K-59149-106
(12)	1	Lockwasher 3/8	" K-59049-25
(13)	1	Resistor, R20, 100 ohms + 10%, 1/2 watt	" K-82283-50
(14)	1	Capacitor, C74, 4700 mmf + 10%	" M-86079-531
(15)	3	Hex. Nut 6-32	" K-57435-104
(16)	3	Lockwasher # 6	" K-59049-3

3. Assembly on Receiver

Numbers in brackets refer to parts supplied in kit.

a. Front Panel.

- i. Take out the four holding screws on the front panel and remove receiver chassis with front panel from case.
- ii. Pull out the plug-in pilot light from its location in the bracket on the rear of the front panel.
- iii. Disconnect the brown-black and black-red leads, by means of their spade terminals, from the stud on the pilot light bracket.
- iv. Take out the four screws and remove the pilot-light bracket and title plate from the back of the front panel.
- v. Mount the gasket (2) and meter plate (3) on front of

the DB tuning meter (1), using the three 6-32 flat head screws (4), nuts (15), and lockwashers (16) for this purpose.

- vi. Assemble the meter, with the gasket and meter plate, on back of front panel, in place of the pilot light bracket previously removed, using the four 4-40 screws (5) and lockwashers (6) for this purpose.

Note - Removal of the covers from the third i-f transformers (T7, T8) will facilitate installation of the bottom screws.

- vii. Connect the brown-black lead with spade terminal, previously disconnected (iii), to the positive marked terminal on back of DB meter.
- viii. Connect the black-red lead with spade terminal, previously disconnected (iii), to the negative terminal on back of DB meter.
- ix. Insert the plug-in pilot light, previously removed (ii), in the hole in the back of the DB meter.

b. Chassis

- i. Mount the variable resistor R21 (10), inserting shaft through hole in back apron of chassis and secure with nut (11) and lockwasher (12) as shown in figure 1.
- ii. Unsolder the brown-black lead from grounded terminal 2 on socket X 13 and solder to terminal 1 on R21 variable resistor (10). See figure 2.
- iii. Attach black ground wire (9) in place as shown in figure 1, soldering to terminal 2 on variable resistor (10) and to grounded terminal 2 on socket X 13.
- iv. Mount the single lug stand-off terminal board (8) in place underneath chassis adjacent to socket X 5 as shown in figure 1. Secure with screw (5), lockwasher (6) and hexagon nut (7).
- v. Unsolder and remove resistor R20 (100 ohms). Install new resistor R20 (10) connecting one end to the stand-off terminal board (8) and the other end to terminal 3 on the first i-f tube socket X 5.
- vi. Unsolder the two brown-black leads from grounded terminal 2 on socket X 5 and attach to lug on terminal board (8).
- vii. Assemble capacitor C74 (14) in place, figure 1, attaching one lead to lug on terminal board (8) and the other to grounded terminal 1 on socket X 9.
- viii. Solder the four leads on the lug on terminal board (8) and the capacitor lead on terminal 1, socket X 9.
- ix. Reassemble chassis in case, replacing the four screws taken out, see paragraph 3.a.iii.

Tuning Meter Adjustment

After assembling the tuning meter on the receiver, set up for reception and make the following adjustment.

- a. Disconnect antenna leads from terminal strip.
- b. Short-circuit the antenna binding posts, and make sure that no signal can be heard.
- c. Connect a 0.10 volt a-c rectifier type meter across the loudspeaker voice coil (terminals 1 and 2 on TB2) then, with the receiver's audio gain control set for maximum gain, adjust the r-f gain control to the position at which 0.5 volt of noise is indicated.
- d. Adjust the variable resistor R21 (10), with a screwdriver, turning shaft at slot in back of case to bring the tuning meter pointer to the extreme left of the scale.
- e. Remove short circuit and external meter then replace the antenna leads.

