

# PRO-94 1000-Channel Handheld Trunking Scanner

Please read before using this equipment.

---

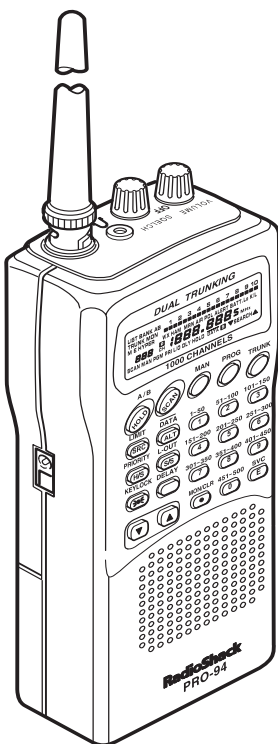

**RadioShack®**

# FEATURES

---

Your RadioShack PRO-94 1000-Channel Handheld Trunking Scanner is one of a new generation of scanners designed to track Motorola Type I, Type II, hybrid analog systems, (such as Smartnet and Privacy Plus) plus GE/Ericsson EDACS. Those systems are extensively used in many 800 MHz, 900 MHz, and UHF communication systems.

Trunking communications systems let a large group of 2-way radio users (or even different groups of 2-way radio users) efficiently use a set of frequencies. Instead of selecting a specific frequency for a transmission, the user simply selects a talk group. The trunking system automatically transmits the call on the first available frequency, and also sends (on a different frequency called a data channel) a code that uniquely identifies that transmission.

Since the trunking system might send a call and its response on different frequencies, it is difficult to listen to trunked communications using a regular scanner. The PRO-94 lets you select and monitor the data channel frequency sent with a 2-way radio transmission, so you can hear the call and response for that user and more easily "follow" the conversation.

The scanner also lets you scan conventional transmissions, and it is preprogrammed with service banks for convenience. By pressing a single button, you can quickly search those frequencies most commonly used by public service and other agencies, without tedious and complicated programming.

This scanner gives you direct access to over 37,000 exciting frequencies, including police and fire departments, ambulance services, and amateur radio services, and you can change your selection at any time.

Your scanner also has these special features:

**Triple-Conversion Circuitry** — virtually eliminates any interference from IF (intermediate frequency) images, so you hear only the selected frequency.

© 1999 Tandy Corporation.  
All Rights Reserved.

RadioShack and Adaptaplug are registered trademarks used by  
Tandy Corporation.

Hypersearch and HyperScan are trademarks used by  
Tandy Corporation.

---

---

**20 Channel-Storage Banks** — you can store up to 50 channels in each of 10 different banks, in two separate groups, for a total of 1000 channels, so you can more easily identify calls.

**Five Scan Lists** — you can store up to 50 trunking talk group IDs in each trunk scanning bank.

**NWR-SAME Circuitry** — lets you listen to coded weather emergency information using Specific Area Message Encoding.

**Two-Second Scan Delay** — delays scanning for about 2 seconds before moving to another channel, so you can hear more replies that are made on the same channel.

**Lock-Out Function** — lets you set your scanner to skip over specified channels or frequencies when scanning or searching, and skip over talk group IDs when tracking trunked systems.

**Priority Channels** — lets you program one channel in each bank (20 in all) and then have the scanner check that channel every 2 seconds while it scans the bank, so you don't miss transmissions on those channels.

**Five Service Banks** — frequencies are preset in separate police (fire/emergency), aircraft, ham, marine, and weather banks, to make it easy to locate specific types of calls.

**Hypersearch™** — lets you set the scanner to search at up to 300 steps per second in frequency bands with 5 kHz steps, compared to the normal search speed of 100 steps per second.

**Hyperscan™** — the scanner automatically scans up to 50 channels per second to help you quickly find interesting broadcasts.

**Key Lock** — lets you lock the scanner's keys to help prevent accidental changes to the scanner's programming.

**Data Signal Skip** — lets you set the scanner to skip non-modulated or data signals (such as fax or modem transmissions) during searches. This lets the scanner avoid non-voice signals, making a search faster.

---

---

**Disconnect Tone Detect** — the scanner automatically tunes to the trunking data channel when it receives a disconnect transmission. You can turn this off, so you can continuously monitor a channel with a weak transmission where conversations are often disconnected.

**Manual Access** — lets you directly access any channel.

**Liquid-Crystal Display** — makes it easy to view and change programming information.

**Display Backlight** — makes the scanner easy to read in low-light situations.

**Flexible Antenna with BNC Connector** — provides adequate reception in strong signal areas and is designed to help prevent antenna breakage. Or, you can connect an external antenna for better reception.

**Monitor Memories** — let you temporarily store up to 10 frequencies or talk group IDs.

**Memory Backup** — keeps the frequencies stored in memory for an extended time if the PRO-94 loses power.

**Three Power Options** — let you power the scanner using internal batteries, external AC power using an optional AC adapter/charger, or DC power using an optional DC cigarette-lighter power cable.

**Key Confirmation Tones** — the scanner sounds a tone when you perform an operation correctly, and an error tone if you make an error.

**Battery Save** — saves battery power when the scanner does not detect any transmissions for more than 5 seconds when a channel is manually selected.

**Battery Low Alert** — warns you when battery power gets low.

**Weather Alert Indicator** — your scanner also functions as a severe weather alert monitor.

---

---

Your scanner can receive these bands:

<b>Frequency Range (MHz)</b>	<b>Step (kHz)</b>	<b>Transmission</b>
29–29.7	5	10-Meter Ham Band
29.7–50	5	VHF Lo Band
50–54	5	6-Meter Ham Band
108–136.9750	12.5	Aircraft Band
137–144	5	Military Land Mobile
144–148	5	2-Meter Ham Band
148–174	5	VHF Hi Band
216–224.9950	5	1-Meter Ham Band
406–420	12.5	Federal Government
420–450	12.5	70-cm Ham Band
450–470	12.5	UHF Standard Band
470–512	12.5	UHF “T” Band
806–956	12.5	Public Service “800” Band, except cellular band
1240–1300	12.5	25-cm Ham Band

---

---

## FCC NOTICE

Your scanner might cause radio or TV interference even when it is operating properly. To determine whether your scanner is causing the interference, turn off your scanner. If the interference goes away, your scanner is causing it. Try the following methods to eliminate the interference:

- move your scanner away from the receiver
- connect your scanner to an outlet that is on a different electrical circuit from the receiver
- contact your local RadioShack store for help

**Note:** Mobile use of this scanner is unlawful or requires a permit in some areas. Check the laws in your area.

## SCANNING LEGALLY

Your scanner covers frequencies used by many different groups including police and fire departments, ambulance services, government agencies, private companies, amateur radio services, military operations, pager services, and wireline (telephone and telegraph) service providers. It is legal to listen to almost every transmission your scanner can receive. However, there are some transmissions you should never intentionally listen to. These include:

- telephone conversations (cellular, cordless, or other private means of telephone signal transmission)
- pager transmissions
- any scrambled or encrypted transmissions

According to the Electronic Communications Privacy Act (ECPA), as amended, you are subject to fines and possible imprisonment for intentionally listening to, using, or divulging the contents of such a transmission unless you have the consent of a party to the communication (unless such activity is otherwise illegal).

---

This scanner is designed to prevent reception of illegal transmissions, in compliance with the law which requires that scanners be manufactured in such a way as to not be easily modifiable to pick up those transmissions. Do not open your scanner's case to make any modifications that could allow it to pick up transmissions that it is not legal to listen to. Doing so could subject you to legal penalties.

We encourage responsible, legal scanner use.

# CONTENTS

---

---

<b>Preparation .....</b>	<b>10</b>
Using Internal Batteries .....	10
Using Non-Rechargeable Batteries .....	10
Using Rechargeable Batteries .....	12
Using AC Power .....	13
Using Vehicle Battery Power .....	14
Connecting the Antenna .....	16
Connecting an Optional Antenna .....	16
Connecting an Earphone/Headphone .....	17
Listening Safely .....	17
Traffic Safety .....	17
Connecting an Extension Speaker .....	18
Attaching the Belt Clip .....	18
<b>About Your Scanner .....</b>	<b>19</b>
A Look at the Keypad .....	20
A Look at the Display .....	22
Understanding Banks .....	24
Service Banks .....	24
Channel Storage Banks .....	24
Monitor Memories .....	24
<b>Operation .....</b>	<b>25</b>
Turning on the Scanner and Setting Squelch .....	25
Storing Known Frequencies into Channels .....	26
Searching For and Temporarily Storing Active Frequencies .....	27
Limit Search .....	27
Direct Search .....	28
Service Bank Search .....	29
Search Skip Memory .....	29
Listening to the Monitor Memories .....	30
Moving a Frequency From a Monitor Memory to a Channel .....	31
Scanning the Stored Channels .....	31
Manually Selecting a Channel .....	31
<b>Special Features .....</b>	<b>33</b>
Delay .....	33
Turning Channel-Storage Banks On and Off .....	33
Locking Out Channels .....	34
Priority .....	34
Using the Keylock .....	36
Using the Display Backlight .....	36
Changing Search Speeds .....	36
Turning the Keytone Off/On .....	37
Turning the Battery Save Function Off/On .....	37
Skipping Data Signals .....	38
Receiving NWR-SAME and Weather Alert Signals .....	38
Turning On the SAME Weather Alert Feature .....	38
SAME Signal Detection Updating .....	39
NWR-SAME Alert Tone Test .....	40
NWR-SAME Code Detection Tests .....	40



<b>Trunking Operation .....</b>	<b>41</b>
Types of Trunking Systems .....	41
Setting the Scanner to the Trunking Mode .....	42
Setting Squelch for the Trunking Mode .....	43
Storing Trunked Frequencies .....	43
<b>Scanning a Trunked Bank .....</b>	<b>46</b>
Turning a Trunked Bank On or Off .....	47
Skipping a Trunked Bank .....	47
Turning the Status Bit Ignore (S-bit) On or Off .....	47
Identifying a Trunked Frequency .....	48
Selecting the EDACS Talk Group ID Format .....	48
EDACS Talk Group ID Range Search .....	48
Using HOLD to Monitor an Active Talk Group ID .....	49
Temporarily Storing a Talk Group ID into the Monitor ID Memory .....	49
Locking Out Talk Group IDs .....	50
Unlocking a Single Talk Group ID .....	50
Unlocking All Talk Group IDs .....	50
Using Trunk Scanning Scan Delay .....	51
Monitoring Talk Group IDs .....	51
Channel Activity Bars .....	52
Using Talk Group ID Lists .....	52
Manually Storing Talk Group IDs in Talk Group ID Lists .....	53
Moving Talk Group IDs to Talk Group ID Lists .....	54
Scanning the Talk Group ID Lists .....	54
Deleting a Stored Talk Group ID List .....	54
Priority Talk Group ID Scanning .....	55
Scanning Type I and Hybrid Trunked Systems .....	55
Selecting a Preset Fleet Map .....	59
Programming a Fleet Map .....	60
Programming the Base and Offset Frequencies .....	61
Programming a Hybrid System .....	61
Turning On/Off the Motorola Disconnect Tone Detect Function .....	62
<b>A General Guide to Scanning .....</b>	<b>63</b>
Guide to Frequencies .....	63
National Weather Frequencies .....	63
Birdie Frequencies .....	63
Guide to the Action Bands .....	64
Typical Band Usage .....	64
Primary Usage .....	64
Band Allocation .....	65
Frequency Conversion .....	68
<b>Troubleshooting .....</b>	<b>69</b>
Resetting the Scanner .....	72
<b>Care and Maintenance .....</b>	<b>73</b>
<b>Specifications .....</b>	<b>74</b>

# PREPARATION

---

You can power your scanner from any of three sources:

- internal batteries (not supplied)
- standard AC power (using an optional AC adapter)
- vehicle battery power (using an optional DC adapter)

## USING INTERNAL BATTERIES

You can power your scanner using four alkaline, lithium, or rechargeable (Ni-Cd, or Ni-MH) AA batteries (not supplied). For the longest operation and best performance, we recommend the selected batteries available from your local RadioShack store.

### Using Non-Rechargeable Batteries

Follow these steps to install non-rechargeable batteries.

1. Turn **VOLUME/OFF** counterclockwise until it clicks to make sure the power is turned off.

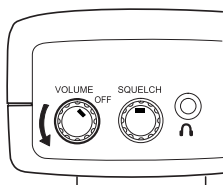

2. Slide up and hold the tab on the back of the scanner, then pull up the battery compartment cover from the top edge.

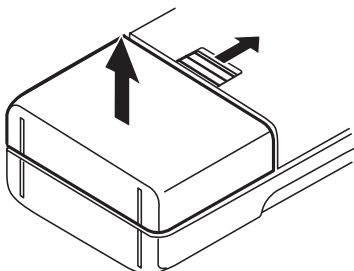

3. Before you install alkaline or any other non-rechargeable batteries, use a pointed object such as a ballpoint pen to set **ALKALINE ◀ JACK ▶ NI-CD** inside the compartment to **ALKALINE**.

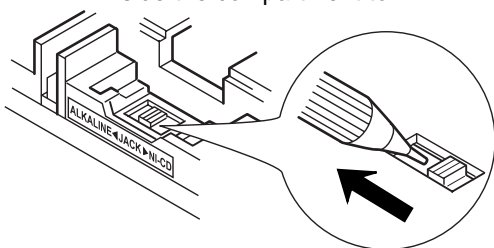

**Warning:** Set **ALKALINE ◀ JACK ▶ NI-CD** to **NI-CD** for use only with nickel cadmium (Ni-Cd) or nickel metal hydride (Ni-MH) rechargeable batteries. Never attempt to recharge non-rechargeable batteries. Non-rechargeable batteries can get hot or explode if you try to recharge them.

4. Install two batteries in the compartment and two in the cover as indicated by the polarity symbols (+ and -) marked inside those locations.

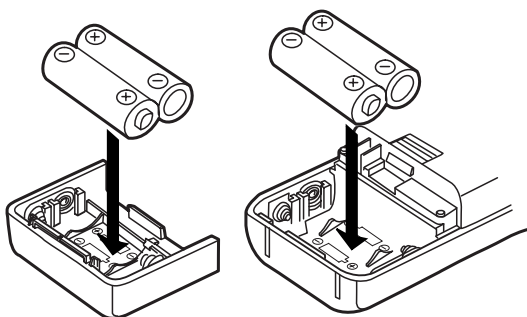

#### **Cautions:**

- Use only fresh batteries of the required size and recommended type.
  - Always remove old or weak batteries. Batteries can leak chemicals that destroy electronic circuits.
  - Do not mix old and new batteries, different types of batteries (standard, alkaline, or rechargeable), or rechargeable batteries of different capacities.
5. Replace the cover, inserting the lower tabs first.

---

---

When **BATT. Lo** flashes and the scanner beeps every 15 seconds, replace all four batteries.

**Caution:** Always dispose of old batteries promptly and properly. Do not bury or burn them.

## Using Rechargeable Batteries

You can also use four rechargeable batteries. Before you use nickel-cadmium or nickel-metal hydride batteries, you must charge them .

The scanner has a built-in circuit that lets you recharge Ni-Cd and Ni-MH batteries while they are in the scanner. To charge the batteries, set **ALKALINE ◀ JACK ▶ NI-CD** to **NI-CD**, install the batteries in the scanner, and connect an external AC or DC adapter to the scanner's **POWER** jack (see "Using AC Power" on Page 13 or "Using Vehicle Battery Power" on Page 14).

**Warning:** Do not connect either adapter to the scanner if non-rechargeable batteries (such as alkaline batteries) are installed in the scanner and **ALKALINE ◀ JACK ▶ NI-CD** is set to **NI-CD**, or if you are unsure of the switch's position. Non-rechargeable batteries will get hot and can even explode if you try to recharge them.

Before you use Ni-Cd or Ni-MH batteries for the first time, charge them at least 24 hours to bring them to a full charge.

Discharged batteries take about 10 to 18 hours to fully recharge. If you use the scanner while the batteries are charging, charging takes longer.

### Notes:

- Nickel-cadmium batteries last longer and deliver more power if you occasionally let them fully discharge. To do this, simply use the scanner until it beeps every 15 seconds and **BATT. Lo** flashes.
- To prevent damage to nickel-cadmium batteries, never charge them in an area where the temperature is above 113°F (40°C) or below 40°F (4°C).

---

**Important:** This scanner can use nickel-cadmium rechargeable batteries. At the end of a nickel-cadmium battery's useful life, it must be recycled or disposed of properly. Contact your local, county, or state hazardous waste management authorities for information on recycling or disposal programs in your area or call 1-800-843-7422. Some options that might be available are: municipal curbside collection, drop-off boxes at retailers such as your local RadioShack store, recycling collection centers, and mail-back programs.



## USING AC POWER

You can power the PRO-94 using an 9V, 300 mA AC adapter and a size H Adaptaplug® (neither supplied). Both are available at your local RadioShack store.

### Cautions:



You must use a Class 2 power source that supplies 9V DC and delivers at least 300 mA. Its center tip must be set to negative and its plug must fit the PRO-94's **POWER 9V 300MA** jack. Using an adapter that does not meet these specifications could damage the PRO-94 or the adapter.

- Always connect the AC adapter to the PRO-94 before you connect it to AC power. When you finish, disconnect the adapter from AC power before you disconnect it from the PRO-94.

---

Follow these steps to use the PRO-94 on AC power.

1. Turn **VOLUME/OFF** counterclockwise until it clicks to make sure the power is turned off.

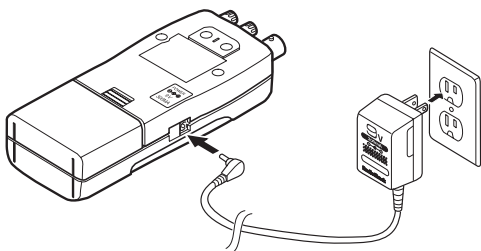

2. Insert the Adaptaplug into the adapter's cord so it reads **TIP -**. Insert the Adaptaplug into the PRO-94's **POWER 9V 300MA** jack.
3. Plug the adapter into a standard AC outlet.

If rechargeable batteries are installed and **ALKALINE** ◀ **JACK** ▶ **NI-CD** is set to **NI-CD**, the adapter powers the scanner and recharges the installed batteries at the same time.

## USING VEHICLE BATTERY POWER

You can power the PRO-94 from a vehicle's 12V power source (such as cigarette-lighter socket) using a 9V, 300-mA DC adapter and a size H Adaptaplug® (neither supplied). Both are available at your local RadioShack store.

### Cautions:



You must use a power source that supplies 9V DC and delivers at least 300 mA. Its center tip must be set to negative and its plug must fit the PRO-94's **POWER 9V 300MA** jack. Using an adapter that does not meet these specifications could damage the PRO-94 or the adapter.

- Always connect the DC adapter to the PRO-94 before you connect it to the power source. When you finish, disconnect the adapter from the power source before you disconnect it from the PRO-94.

- 
- If batteries are installed, make sure the battery switch inside the battery compartment is set to the correct position (see “Using Internal Batteries” on Page 10).
1. Turn **VOLUME/OFF** counterclockwise until it clicks to make sure the power is turned off.
  2. If the adapter has a voltage switch, set the switch to 9V.
  3. Insert the Adaptaplug into the adapter’s cord so it reads TIP –. Insert the Adaptaplug into the PRO-94’s **POWER 9V 300MA** jack.
  4. Plug the adapter’s barrel plug into your scanner’s **POWER 9V 300MA** jack.

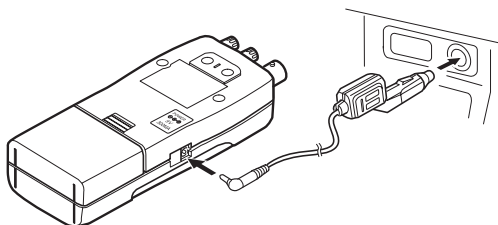

5. Plug the other end of the adapter into your vehicle’s cigarette-lighter socket.

If rechargeable batteries are installed and **ALKALINE ◀ JACK ▶ NI-CD** is set to **NI-CD**, the adapter powers the scanner and recharges the installed batteries at the same time.

**Note:** If the scanner does not operate properly when you use a DC adapter, unplug the adapter from the cigarette-lighter socket and clean the socket to remove ashes and debris.

---

## CONNECTING THE ANTENNA

To attach the supplied flexible antenna to the connector on the top of your scanner, align the slots around the antenna's connector with the tabs on the scanner's BNC connector. Then slide the antenna's connector down over the scanner's connector and rotate the antenna connector's outer ring clockwise until it locks into place.

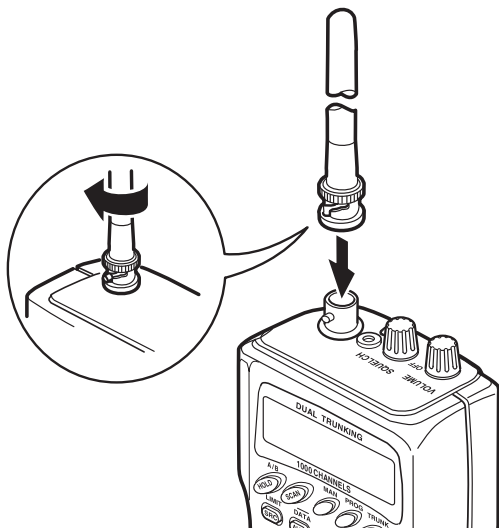

### Connecting an Optional Antenna

The scanner's BNC connector makes it easy to connect a variety of optional antennas, including an external mobile antenna or outdoor base station antenna. Your local RadioShack store sells a wide selection of antennas.

**Note:** Always use 50-ohm, RG-58, or RG-8, coaxial cable to connect an outdoor antenna. If the antenna is over 50 feet from the scanner, use RG-8 low-loss dielectric coaxial cable. If your antenna's cable does not have a BNC connector, your local RadioShack store carries a variety of BNC adapters.



---

---

## CONNECTING AN EARPHONE/ HEADPHONE

For private listening, you can plug an optional earphone or mono headphones into the  jack on top of your scanner. This automatically disconnects the internal speaker.

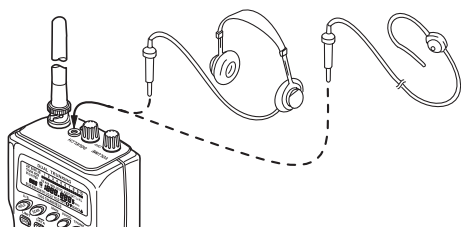

### Listening Safely

To protect your hearing, follow these guidelines when you use an earphone or headphones.

- Do not listen at extremely high volume levels. Extended high-volume listening can lead to permanent hearing loss.
- Set the volume to the lowest setting before you begin listening. After you begin listening, adjust the volume to a comfortable level.
- Once you set the volume, do not increase it. Over time, your ears adapt to the volume level, so a volume level that does not cause discomfort might still damage your hearing.

### Traffic Safety

Do not use an earphone or headphones with your scanner when operating a motor vehicle in or near traffic. Doing so can create a traffic hazard and could be illegal in some areas.

If you use an earphone or headphones with your scanner, be very careful. Do not listen to a continuous broadcast. Even though some earphones/headphones let you hear some outside sounds when listening at normal volume levels, they still can present a traffic hazard.

---

---

## CONNECTING AN EXTENSION SPEAKER

In a noisy area, an optional extension speaker, positioned in the right place, might provide more comfortable listening. Plug the speaker cable's  $\frac{1}{8}$ -inch (3.5-mm) mini-plug into your scanner's  jack. Your local RadioShack store carries a selection of suitable speakers.

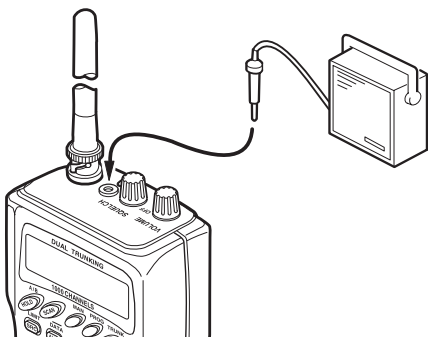

## ATTACHING THE BELT CLIP

To make your scanner easier to carry when you are on the go, use the supplied belt clip. Use a Phillips screwdriver and the supplied screws to attach the clip to the scanner.

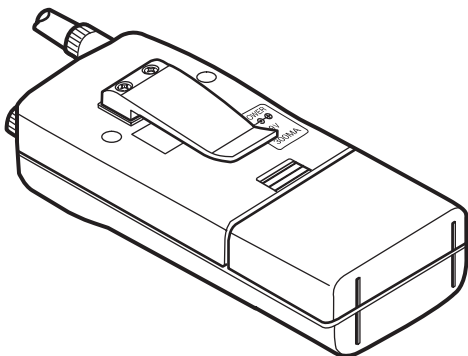

# ABOUT YOUR SCANNER

---

We use a few simple terms in this manual to explain the features of the PRO-94. Familiarize yourself with these terms and the scanner's features and you can put the scanner to work for you right away. Simply determine the type of communications you want to receive, then set the scanner to scan those communications.

The PRO-94 scans conventional frequencies and **trunked systems**. For more information about trunked transmissions see "Trunking Operation" on Page 41.

A **frequency**, expressed in kHz or MHz, is the tuning location of a station. To find active frequencies, you use the **search** function or refer to a frequency reference such as the included *Trunking Frequency Guide*.

Besides searching within a selected frequency range, you can also search your scanner's **service banks**. Service banks are preset groups of frequencies categorized by the type of services that use those frequencies. For example, many amateur radio frequencies are located in the **HAM** service bank.

When you search and find a desired frequency, you can store it into a programmable memory location called a **channel**. Channels are grouped into **channel-storage banks**. The PRO-94 has 500 channels in channel-storage bank A and another 500 in channel-storage bank B. Each bank of 500 is divided into ten 50-channel sets. You can **scan** the channel-storage banks to see if there is activity on the frequencies stored there.

Or, when you find a frequency, you can store it into a **temporary** memory location called a **monitor memory** until you decide whether or not to move it to a channel.

Just keep in mind — you *search* frequencies and *scan* channels.

## A LOOK AT THE KEYPAD

Your scanner's keys might seem confusing at first, but this information should help you understand each key's function and the pages where you will find additional information about those functions.

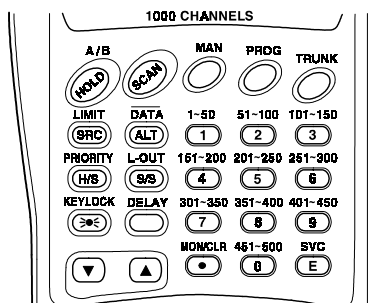

Key	Function(s)	See Page(s)
<b>A/B HOLD</b>	Switches the bank groups; holds the frequency search; holds the current ID in the trunking mode	26, 28, 49
<b>SCAN</b>	Scans the stored channels, and scan lists	22, 31, 54
<b>MAN</b>	Stops scanning and lets you directly enter a channel number or frequency; manually stores talk group IDs in scan lists	26, 28, 53, 54
<b>PROG</b>	Stores frequencies into channels; programs the trunking frequency, fleet map, and ID memories	26, 44, 47, 53, 60
<b>TRUNK</b>	Switches between conventional and trunking operation	42, 43, 45
<b>LIMIT/SRC</b>	Starts a limit search; searches a specified frequency range for frequencies; searches for another active ID during trunking operation	27, 45
<b>DATA/ALT</b>	Turns on or off the data signal skip feature; moves through menu settings while trunking; turns on or off the NWR-SAME weather alert	28, 38, 41, 63
<b>PRIORITY/H/S</b>	Sets and turns on and off the priority & priority scanning feature; turns on and off Hypersearch	34, 36, 55

Key	Function(s)	See Page(s)
<b>L-OUT/S/S</b>	Lets you lock out selected channels or skip specified frequencies during a search; lets you lock out a selected ID while trunking	30, 34, 50
<b>KEYLOCK/</b> 	Locks the keypad to prevent accidental program changes; turns on the display backlight for 15 seconds	37
<b>DELAY</b>	Programs a 2-second delay for the selected channel, a limit search, or each service scan; programs a 5-second delay while trunking	33, 51
▼	Searches down through a selected frequency range; selects options during programming; changes the ID location number while trunking	28, 29, 53, 54
▲	Searches up through a selected frequency range; selects options during programming; changes the ID location number while trunking	28, 29, 53, 54
<b>Number Keys</b>	Each key has a single-digit label and a range of numbers. Single-digit keys enter a channel, a frequency, or an ID number. The range of numbers (51–100, for example) are used to enter the channels of a memory bank.	25, 26, 29, 44, 48, 53
<b>MON/CLR/</b> •	Stores frequencies into monitor memories during a search; recalls frequencies from the monitor memories when programming a channel; stores IDs into the monitor memories or selects options while trunking; enters a decimal point or clears an incorrect entry	29, 30, 31
<b>SVC /E</b>	Starts a service bank search; enters frequencies into channels; stores the talk group IDs in the scan lists	26, 29, 44, 53

---

---

## A LOOK AT THE DISPLAY

The display has indicators that show the scanner's current operating status. The display information helps you understand how your scanner operates.

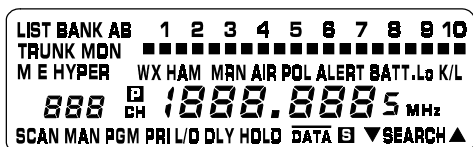

**BANK A** or **B** — appears with numbers (1–10). **A** or **B** indicates the bank group. The numbers show which channel-storage banks are turned on for scanning.

**TRUNK** — appears when you select the trunking operation and while you store a trunking frequency into a channel.

■ (trunking channel activity bars) — each represents a received trunking frequency or a data frequency while trunking; they appear when you select a service search.

**P** — appears when you select a priority channel.

**BATT. Lo** — blinks when the scanner's battery is low.

**DATA** — appears when the data skip function is active; appears when the disconnect tone detect function is off in the trunking mode.

**SCAN** — appears when you scan channels.

**LIST** — appears with numbers (1–5) during trunking. Numbers with a bar under them show which ID scan list banks are turned on for scanning.

**SEARCH** — appears during limit, direct, service, and ID searches, and blinks when you monitor IDs.

**PRI** — appears when the priority feature is turned on.

**HOLD** — appears during limit, direct, service, and ID searches, and ID monitor holds; flashes while the scanner is temporarily monitoring a programmed ID.

---

---

**DLY** — appears when you select a delay.

**L/O** — appears when you manually select a channel you locked out.

**K/L** (keylock) — appears when you lock the keypad.

**Error** — appears when you make an entry error.

**MON** — appears during search modes, ID search monitor, program ID monitor, or when you select a monitor memory. The number to the right of this indicator shows the current monitor memory.

**MAN** — appears when you press **MAN** to directly enter a channel number or frequency.

**PGM** — appears while you store a frequency into a channel, while you enter a frequency range during a limit search, or when you program trunking frequencies, fleet maps, or ID memories while trunking.

**HYPER** — appears while Hyperscan or Hypersearch is active during a direct or limit search.

▼ or ▲ — appears during a limit, direct, or service searches, indicating the search direction.

**S** — appears when the battery save function is active (during conventional scanning only).

**WX HAM MRN AIR POL** — appears along with an indicator which shows the current service bank during a service search.

**ALERT** — appears when the weather alert is turned on, or flashes when the scanner detects an alert coded signal.

**M** or **ME** — indicate either a Motorola (M) trunking system or EDACS (ME) system.

**CH** — appears with a number to its left to indicate to which channel the scanner is tuned to.

---

---

## UNDERSTANDING BANKS

### Service Banks

The scanner is preprogrammed with all the frequencies allocated to the weather, ham, marine, aircraft, and police (fire/emergency) services. This helps you quickly find active frequencies instead of doing a limit search (see “Service Bank Search” on Page 29).

### Channel Storage Banks

To make it easier to identify and select the channels you want to listen to, all the channels are divided into main bank groups A and B. Each main bank group has 10 banks of 50 channels. Use each channel-storage bank to group frequencies, such as those for the police department, fire department, ambulance services, or aircraft (see “Guide to the Action Bands” on Page 64).

For example, the police department might use four frequencies in your town while the fire department uses an additional four. You could program the four police frequencies starting with Channel 1 (the first channel in bank 1), and program the fire department frequencies starting with Channel 51 (the first channel in bank 2).

### Monitor Memories

The scanner also has 10 temporary memory locations called monitor memories. Use these monitor memories to temporarily store frequencies when you search through an entire band (see “Searching For and Temporarily Storing Active Frequencies” on Page 27). You can then move a frequency to a channel for permanent storage. See “Moving a Frequency From a Monitor Memory to a Channel” on Page 31.

While you are searching frequencies, the 10 numbers at the top of the display indicate the 10 monitor memories. **MON** appears and the flashing number beside it indicates the currently active monitor memory.



# OPERATION

## TURNING ON THE SCANNER AND SETTING SQUELCH

**Note:** Make sure the scanner's antenna is connected before you turn it on.

1. Turn **SQUELCH** fully counterclockwise.

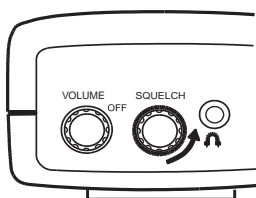

2. Turn **VOLUME/OFF** clockwise until it clicks and you hear a hissing sound.

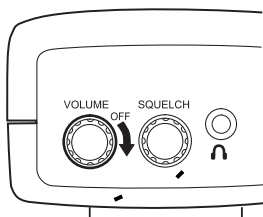

3. If the PRO-94 is scanning, press **MAN** (manual) to stop scanning, then turn **SQUELCH** clockwise until the hissing stops.

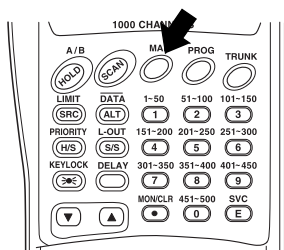

---

---

## STORING KNOWN FREQUENCIES INTO CHANNELS

You can locate and store specific frequencies into channels for later use. To assist you in locating a desired frequency from the scanner's wide range, consider using a frequency guide. Good references for active frequencies are the RadioShack "Police Call Guide including Fire and Emergency Services," and "Official Aeronautical Frequency Directory." We update these directories every year, so be sure to get a current copy.

**Note:** To store trunked system frequencies, see "Storing Trunked Frequencies" on Page 43.

Follow these steps to store frequencies into channels.

1. Press **MAN** and hold down **A/B (HOLD)** for about 2 seconds to select either main bank group. Enter the channel number where you want to store a frequency, then press **PROG**. The channel number appears.
2. Use the number keys and **• (MON/CLR)** to enter the frequency (including the decimal point) you want to store.
3. Press **E (SVC)** to store the frequency into the channel.

### Notes:

- If you entered an invalid frequency in Step 2, **Error** appears and the scanner beeps three times. Enter a valid frequency.
  - The scanner automatically rounds the entered number to the nearest valid frequency. For example, if you enter 151.473 (MHz), your scanner accepts it as 151.475.
  - Press **DELAY** to pause scanning 2 seconds after the end of a transmission before scanning proceeds to the next channel (see "Delay" on Page 33). The scanner stores this setting in the channel.
4. To program the next channel in sequence, press **PROG** and repeat Steps 2 and 3.

---

---

## SEARCHING FOR AND TEMPORARILY STORING ACTIVE FREQUENCIES

If you do not have a reference to frequencies in your area, use a limit, direct, or service search (except weather service search) to find a transmission. Also see “Guide to the Action Bands” on Page 64.

**Notes:** While doing a limit, direct, or service bank search, press:

- **DELAY** if you want the scanner to pause 2 seconds after a transmission ends before it proceeds to the next frequency (see “Delay” on Page 33).
- **DATA** if you want the scanner to skip data signals (such as fax or modem signals) and search only for audio (voice) signals (see “Skipping Data Signals” on Page 38).

### Limit Search

A limit search lets you search within a specific range of frequencies. **-L-** appears during a limit search.

1. Press **PROG**, then **LIMIT (SRC)**. **Lo** and **29.000 MHz** appear. 29.000 MHz is the low end of the scanner’s range.

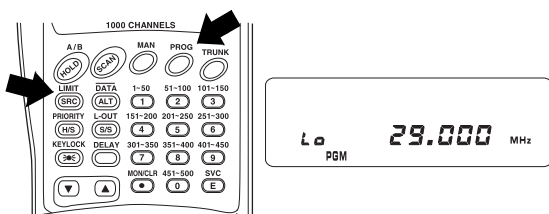

2. Enter the frequency that is the lower limit of the range you want to search (including the decimal point), then press **E**.
3. Press **LIMIT**. **Hi** and **1300.000 MHz** appear. 1300.000 MHz is the upper limit of the scanner’s range.

- 
- 
4. Enter the frequency that is the upper limit of the range you want to search (including the decimal point), then press **E (SVC)** again.
  5. Press **▼** to search from the upper to the lower limit, or **▲** to search from the lower to the upper limit.
  6. When the scanner stops on a transmission, quickly press either:
    - **HOLD (A/B)** to stop searching to listen to the transmission. **HOLD** appears.
    - **MON/CLR (•)** to store the displayed frequency into the current monitor memory.
  7. To release the hold and continue searching, press **HOLD (A/B)** or hold down **▼** or **▲** for at least 1 second. Or, if you did not press **MON/CLR (•)**, simply press **▼** or **▲** to continue searching.

## Direct Search

You can search up or down from the currently displayed frequency using direct search. **-d-** appears during searching until the scanner stops. See Step 4.

1. Press **MAN**.
2. Enter the frequency you want to start from using the number keys. (Press **•** to enter a decimal point).

### Notes:

- To start the search from a frequency already stored in one of your scanner's channels, press **MAN** or **PROG**. Then use the number keys to enter the channel number and then press **MAN** or **PROG** again.
  - If you enter an invalid frequency, the scanner displays **Error**. Press **MON/CLR (•)**.
3. Press **▼** to search downward or **▲** to search upward from the selected frequency. **-d-**, **SEARCH**, and **▼** or **▲** appear.
  4. When the scanner stops on a transmission, quickly press either:
    - **HOLD** to stop searching and listen to the transmission. **HOLD** appears.

- 
- **MON/CLR** to store the displayed frequency into the current monitor memory.
5. To release the hold and continue searching, press **HOLD** or hold down ▼ or ▲ for at least 1 second. Or, if you did not press **HOLD**, simply press ▼ or ▲ to continue searching.

**Note:** To step through the frequencies while **HOLD** appears, press ▼ or ▲.

## Service Bank Search

You can search for weather, ham, marine, aircraft, or police (fire/emergency) transmissions without knowing the specific frequencies used in your area. The scanner is preprogrammed with all the frequencies allocated to these services. To use this feature, press **SVC. SEARCH** appears and the scanner searches starting with the weather service bank. To select a different service bank, repeatedly press **SVC**. A bar appears above the selected bank.

When the scanner stops on a transmission, quickly press either:

- **HOLD** to stop searching and listen to the transmission. **HOLD** appears.
- **MON/CLR** to store the displayed frequency into the current monitor memory.

To release the hold and continue searching, press **HOLD (A/B)** or hold down ▼ or ▲ for at least 1 second. Or, if you did not press **HOLD (A/B)**, simply press ▼ or ▲ to continue searching.

**Note:** Because there are many different frequencies allocated to fire and police departments, it can take several minutes to search all the service frequencies.

## Search Skip Memory

You can skip up to 20 specified frequencies during a limit or direct search and up to 20 specified frequencies during a service bank search. This lets you avoid unwanted frequencies or those already stored in a channel.

To skip a frequency, press **S/S** (**L-OUT**) when the scanner stops on the frequency during a limit, direct, or service search. The scanner stores the frequency in memory and automatically resumes the search.

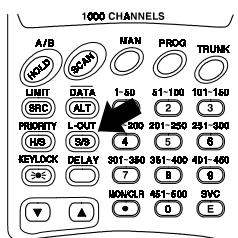

To clear a single frequency from skip memory so the scanner stops on it during a limit, direct, or service bank search:

1. Press **HOLD** to stop the search.
2. Press ▼ or ▲ to select the frequency. **L/O** appears.
3. Press **S/S**. **L/O** disappears.

To clear all the skip frequencies at once while searching, press **HOLD**, then hold down **S/S** until the scanner beeps twice.

#### Notes:

- If you selected all frequencies to be skipped within the search range, the scanner beeps 3 times and does not search.
- If you select more than 20 frequencies to skip, each new frequency replaces a frequency previously stored, beginning with the first stored frequency.
- Press ▼ or ▲ to select a skipped frequency while **HOLD** appears. **L/O** appears when you select a skipped frequency.

---

## LISTENING TO THE MONITOR MEMORIES

To listen to the frequency stored in any one of the ten monitor memories, press **MAN**, **MON/CLR (•)**, then the number of the desired monitor memory (0–9), or repeatedly press **MON/CLR (•)** to step through the monitor memories.

**Note:** To listen to the monitor memories, the priority channel feature must be turned off (see “Priority” on Page 34).

## MOVING A FREQUENCY FROM A MONITOR MEMORY TO A CHANNEL

1. Press **MAN**. **MAN** appears.
2. Enter the number of the desired target channel where you want to move the frequency that is stored in the monitor memory, then press **PROG. PGM** appears.
3. Press **MON/CLR (•)** then enter the number (1–10) of the monitor memory containing the frequency.
4. Press **E**. The frequency transfers from the monitor memory into the selected channel.

---

---

## SCANNING THE STORED CHANNELS

To begin scanning channels, press **SCAN**. The scanner scans through all non-locked channels in the activated banks. (See “Locking Out Channels” on Page 34 and “Turning Channel-Storage Banks On and Off” on Page 33). When the scanner finds a transmission, it stops on it. When the transmission ends, the scanner resumes scanning.

### Notes:

- If you have not stored frequencies into any channels, the scanner does not scan.
- If the scanner picks up unwanted partial, or very weak transmissions, turn **SQUELCH** clockwise to decrease the scanner’s sensitivity to these signals. To listen to a weak or distant station, turn **SQUELCH** counterclockwise.
- To ensure proper scanning, adjust **SQUELCH** until the audio mutes.
- To scan in the trunk scanning mode, see “Trunking Operation” on Page 41.

## MANUALLY SELECTING A CHANNEL

You can continuously monitor a single channel without scanning. This is useful if you hear an emergency broadcast on a channel and do not want to miss any details — even though there might be periods of silence — or if you want to monitor a specific channel.

To manually select a channel, press **MAN**, enter the channel number then press **MAN** again.

Or, if while scanning, the radio stops at a channel you want to listen to, press **MAN** one time. (Repeatedly pressing **MAN** at this time causes the scanner to step through the channels.) Press **SCAN** to resume automatic scanning.



# SPECIAL FEATURES

## DELAY

Sometimes a user might pause before replying to a transmission. To avoid missing a reply on a specific channel, you can program a 2-second delay into any channel or frequency. The scanner continues to monitor the channel frequency for an additional 2 seconds after the transmission stops before resuming scanning or searching.

Depending on how the scanner is operating, follow one of these steps to program a delay.

- If the scanner is scanning and stops on an active channel where you want to store a delay, quickly press **DELAY** before it continues scanning again. **DLY** appears.

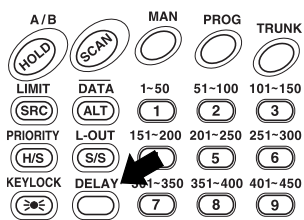

- If the desired channel is not selected, manually select the channel, then press **DELAY**. **DLY** appears.
- If the scanner is searching, press **DELAY** while the scanner is searching. **DLY** appears and the scanner automatically adds a 2-second delay to every frequency it stops on in that band.

To turn off the 2-second delay, press **DELAY** while the scanner is monitoring a channel, scanning, or searching. **DLY** disappears.

## TURNING CHANNEL-STORAGE BANKS ON AND OFF

You can turn each channel-storage bank on and off. When you turn off a bank, the scanner does not scan any of the 50 channels in that bank.

---

---

While scanning, press the number key that corresponds to the bank you want to turn on or off. Numbers appear at the top of the display, showing the currently selected banks.

The scanner scans all the channels within the displayed banks that are not locked out (see “Locking Out Channels”). The bank number flashes when the scanner scans the channel that belongs to the bank.

**Notes:**

- You can manually select any channel within a bank, even if that bank is turned off.
- You cannot turn off all banks. One bank must always be active.

## LOCKING OUT CHANNELS

You can increase the scanning speed by locking out channels that have a continuous transmission, such as a weather channel. To lock out a channel, manually select the channel, then press **L-OUT(S/S)**. **L/O** appears.

**Note:** You can still manually select locked-out channels.

To remove the lockout from a channel, manually select the channel, then press **L-OUT(S/S)**. **L/O** disappears.

To unlock all channels in the banks that are turned on, press **MAN** to stop scanning, then hold down **L-OUT(S/S)** until the scanner beeps twice.

## PRIORITY

The priority feature lets you scan through the channels and still not miss important or interesting calls on specific channels. You can program one stored channel in each bank as a priority channel (10 for the banks in Group A and 10 for the banks in Group B). If the priority feature is turned on, as the scanner scans the bank, it checks that bank’s priority channel for activity every 2 seconds.

---

---

The scanner automatically designates each bank's first channel as its priority channel. Follow these steps to select a different channel in a bank as the priority channel.

1. Press **PROG**.
2. Enter the channel number you want to select as the priority channel, then press **PRIORITY (H/S)**. **P** appears to the right of the selected channel number.
3. Repeat Steps 1 and 2 for the channel in each bank you want to program as a priority channel.

To review all priority channels (in ascending order only), press **PROG**, then repeatedly press **PRIORITY** to see the numbers of the priority channels.

To turn on the priority feature, press **PRIORITY** during scanning. **PRI** appears. Then the scanner checks the designated priority channel every 2 seconds in each bank. The bank number appears at the top of the display.

To turn off the priority feature, press **PRIORITY**. **PRI** disappears.

#### Notes:

- The priority feature must be turned off to listen to the monitor memories or to use the data skip feature.
- If you have locked out all priority channels, **LOC OUT** appears when you activate the priority feature. To unlock any desired priority channels, see "Locking Out Channels" on Page 34.

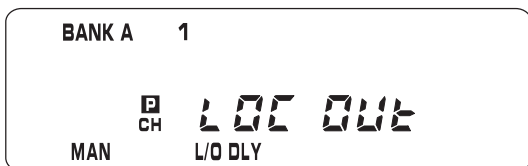

---

---

## USING THE KEYLOCK

To protect the scanner from accidental program changes, turn on the keylock feature. When the scanner is locked, the only controls that operate are **SCAN**, **MAN**, **KEYLOCK**, **VOLUME/OFF**, and **SQUELCH**.

To turn on the keylock, hold down **KEYLOCK** until **K/L** appears. To turn it off, hold down **KEYLOCK** until **K/L** disappears.

**Note:** Using keylock does not prevent the scanner from scanning channels.

## USING THE DISPLAY BACKLIGHT

To turn on the display light for easy viewing at night, press  $\Rightarrow \bullet \Leftarrow$ . The display lights for 15 seconds. To turn off the light sooner, press  $\Rightarrow \bullet \Leftarrow$  again.

## CHANGING SEARCH SPEEDS

The PRO-94 has two search speeds.

Normal Search	Hypersearch
100 steps/second	300 steps/second

To switch between the normal and Hypersearch speeds during limit search or direct search, press **H/S**. **HYPER** appears during Hypersearch.

**Note:** Hypersearch applies only to the 5 kHz step bands (29–54 MHz, 137–174 MHz, and 216–224.9950 MHz).

---

---

## TURNING THE KEYTONE OFF/ON

1. Turn off the scanner.
2. While holding down **L-OUT/S/S**, turn on the scanner. **OFF bEEP** appears.

To turn the key tone back on, repeat these steps. **on bEEP** appears.

## TURNING THE BATTERY SAVE FUNCTION OFF/ON

When the scanner is set to receive (monitor) a manually selected channel, and it is not actively scanning, using the battery save feature conserves energy.

To turn the battery save function off or back on, turn off the scanner, then hold down **PRIORITY** and turn on the scanner.

- **OFF SAVE** briefly appears when battery save has been turned off.
- **on SAVE** briefly appears when battery save has been turned on, and **S** appears.

When the battery save feature is active, the scanner repeatedly turns off the internal power for 1 second, then turns it back on for about  $\frac{1}{2}$  second to check for a transmission.

---

---

## SKIPPING DATA SIGNALS

To prevent the scanner from stopping on channels that consist of nonmodulated or data signals (such as fax or modem transmissions) during a search or scan, turn on the data skip feature. When the radio receives a data signal and data skip is selected, the signal is ignored.

To turn on the data skip feature, turn off the priority feature if it is on (see “Priority” on Page 34), then press **DATA**. **DATA** appears. To turn off the data skip feature, press **DATA** again. **DATA** disappears.

**Note:** This feature does not apply to the air service band as data signals are not generally found in this service.

## RECEIVING NWR-SAME AND WEATHER ALERT SIGNALS

In 1994, the National Oceanic and Aerospace Administration (NOAA) began broadcasting alerts that include digitally encoded data. *Specific Area Message Encoding* (SAME) includes information which identifies the severity of the alert. The PRO-94 displays this data as codes corresponding to the levels of severity (L1, L2, and L3).

### Turning On the SAME Weather Alert Feature

1. Press **SVC (E)** and select the weather search mode. See “Service Bank Search” on Page 29.
2. Press **ALT (DATA)**. This mutes the audio until the scanner receives a SAME coded signal.

When the scanner receives a SAME coded signal, **ALERT** flashes and an associated “L” code (which indicates the severity of the alert) appears, as well. The scanner remains on the weather channel and the audio turns on so you can hear the weather broadcast.

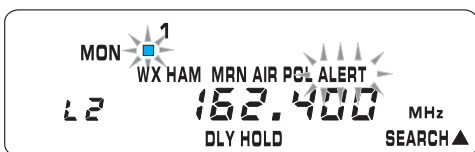

The scanner displays one of the following codes to indicate the alert level.

**L1:** Warning

**L2:** Watch

**L3:** Statement

**-----:** Non-emergency

In addition to weather alerts, the scanner also receives test and other event information. See “NWR-SAME Code Detection Tests” on Page 40.

## SAME Signal Detection Updating

When the scanner receives a SAME-coded signal, it retains information about the most recent alert until you turn off the power. Once the scanner detects an alert code, **ALERT** flashes. To verify the specific alert level (L1, L2, or L3) press **SVC (E)** to select the weather search mode. Press **ALT (DATA)** to clear the alert.



---

---

## NWR-SAME Alert Tone Test

To hear and test the tones for the three alert levels, press **SVC (E)** to select the weather service, then hold down **ALT** for about 1 second. The tones sound in the order L3, L2, then L1, and **TEST** flashes. Each alert code appears as its tone sounds. Press any key to end the test sequence.

## NWR-SAME Code Detection Tests

The National Weather Service sends out daily, weekly, and monthly test (and sometimes demonstration) signals, which let anyone with a receiver (such as the PRO-94) verify that the equipment is working properly.

To find out the specific test schedule in your area, contact your local NOAA or NWS office. Those offices are usually listed in the telephone book under *US Government, Department of Commerce*.

When **ALERT** appears, hold down **ALT (DATA)** for about 1 second. The frequency and **TEST** appear alternately. When the scanner receives the test code, **TST** also appears .

To exit the test mode, press **ALT (DATA)** for about 1 second.

**Note:** If an actual alert is sent, the scanner sounds the appropriate tone and displays the corresponding alert level.



# TRUNKING OPERATION

---

The PRO-94 scanner tracks transmissions that use the Motorola Type I, Type II, hybrid, and, Ericsson EDACS analog trunking systems. Remember these important points when tracking transmissions:

- Your scanner cannot scan trunked system and conventional frequencies at the same time.
- The frequencies for many of the 800 MHz, 900 MHz, and EDACS public safety systems are listed in the separate “National Public Safety Trunked System Frequency Guide” included with your PRO-94.

## TYPES OF TRUNKING SYSTEMS

This trunking scanner monitors two basic types of systems — the Motorola Type I/Type II or hybrid System, and the Ericsson EDACS System. Instead of selecting a specific frequency to transmit on, a trunked system chooses one of several frequencies in a 2-way radio user’s talk group when that user presses their PTT (push to talk) control. Thus, trunking systems, in general, allocate a few frequencies among many different users. Motorola Type I and Type II systems achieve the same thing in a slightly different way. One important distinction between these systems is the amount of data transmitted by each radio when the operator pushes the PTT control. A Type I system, transmits the radio’s ID and its current affiliation or the trunk system to which it belongs. A Type II system only transmits the radio’s ID.

Why the difference? In Type I systems, each radio in the trunk group individually transmits its own affiliation, while the trunk system maintains a database that determines each radio’s affiliation(s) in Type II systems.

Another difference between the systems is that Type I systems are arranged in a fleet-subfleet hierarchy. For example, it is possible for a city using a Type I system to designate four fleets, each with eight subfleets.

---

The police department, fire department, utilities group, and city administration could each be a separate fleet. The police might decide to further divide its fleet into subfleets, such as dispatch, tactical operations, detectives, north, south, east, and west side patrols, and supervisors. All the available police radios would then be assigned to one of the police subfleets, letting the police centralize their communications and control the type of users on a single system. Determining the exact fleet-subfleet hierarchy for a particular area is referred to as *fleet map programming*.

The disadvantage of a Type I system is that the brief burst of data sent when a user transmits must contain the radio's ID, its fleet information, and the subfleet information as well. This is three times the amount of data a Type II system radio sends. Since the data capacity of Type I systems is limited and the total amount of data increases with each user, Type I systems usually accommodate fewer users than Type II systems. Nevertheless, Type I systems are still in use.

There are also *hybrid* systems which are a combination of Type I and Type II. Your scanner is preset to monitor Type II systems, but you can change to Type I or a hybrid of Type I and Type II systems by selecting a pre-programmed fleet map or creating a custom fleet map for your area (see "Scanning Type I and Hybrid Trunked Systems" on Page 55).

## SETTING THE SCANNER TO THE TRUNKING MODE

Press **TRUNK** to switch between conventional scanning and trunking operation.

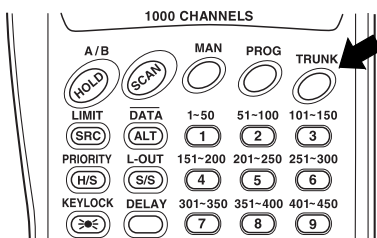

---

---

## SETTING SQUELCH FOR THE TRUNKING MODE

Your scanner's squelch setting is automatically adjusted during trunking, which means it is not necessary to manually adjust squelch while scanning trunked transmissions. However, the squelch setting can affect how fast your scanner acquires the data channel, and, in some instances, can prevent your scanner from acquiring the data channel at all.

We recommend you set **SQUELCH** fully clockwise before selecting a trunked bank.

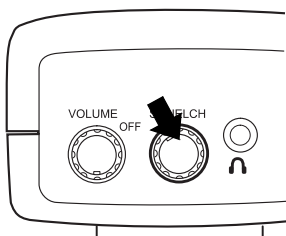

**Note:** Change this setting as needed for the best performance in your area.

## STORING TRUNKED FREQUENCIES

Before you set up your scanner to track a trunked system, consider the following:

- The following frequency ranges are valid for the trunk systems indicated.

*Motorola Type I and Type II system:*

935.0125–939.9875 MHz  
851.0000–899.9875 MHz  
(except cellular frequencies)  
406.0000–512.0000 MHz  
137.0000–174.0000 MHz

*Ericsson EDACS system:*

900.0000–956.0000 MHz  
806.0000–868.9875 MHz  
406.0000–512.0000 MHz  
137.0000–174.0000 MHz

- You can designate any of your scanner's banks as either a trunk scanning bank or conventional scanning bank, but you cannot mix the two modes in one bank.
- The PRO-94 can scan multiple trunking systems. If a system is inactive for 5 seconds, the PRO-94 starts scanning the next selected trunk bank.

Follow these steps to select, program, and store trunked frequencies.

1. Press **PROG** then **TRUNK**. **TRUNK** appears and one or more bank numbers flash.
2. Press the number key (1–10) of the desired target storage bank. Select one of the trunk systems by repeatedly pressing ▼ or ▲ to select a trunking system type, then press **E (SVC)**. The scanner then automatically selects the first channel in the selected bank.

**Note:** You can select from the following six systems :

You See	Trunk System
<b>E1</b>	Motorola Type I, 800 MHz frequencies
<b>Ed</b>	EDACS frequencies
<b>E2 – 800</b>	Motorola Type II, 800 MHz frequencies
<b>E2 – 900</b>	Motorola Type II, 900 MHz frequencies
<b>E2 – Hi</b>	Motorola Type II, VHF frequencies
<b>E2 – UHF</b>	Motorola Type II, UHF frequencies

3. Use the number keys to enter a valid frequency within the trunk system, then press **E (SVC)**. **BANK** and the bank number, the channel number, and **E** (EDACS) or **M** (Motorola) appears depending upon the trunk system selected.

---

---

**Notes:**

- If you enter an invalid frequency (outside the selected range), the scanner beeps, the channel number flashes and **Error** appears. If this happens, press **MON/CLR** (●) to clear the frequency, then repeat the entry.
  - For EDACS systems, you must enter the frequencies in logical channel number (LCN) order.
  - If you try to enter a duplicate frequency in a bank, the scanner beeps and the channel which was previously stored appears.
  - It is very important that you enter all the listed frequencies for the selected agency in Step 3. Otherwise, trunking will not occur when you press **SRC** (see Step 6).
4. Press either **PROG** or ▲ to select the next channel in the bank.
  5. Repeat Steps 3 and 4 until you enter all desired frequencies in that bank.
  6. Press **SRC** to begin searching for the trunk's data channel (the channel that controls the trunk). **SEARCH** flashes as the scanner searches for the data channel.

As the scanner looks through the frequencies, you see them on the display. When the scanner finds the controlling data channel, the scanner begins trunking.

---

---

## SCANNING A TRUNKED BANK

Once you have stored frequencies for a trunked system in one or more of the 20 available banks, and while the PRO-94 scans conventional (non-trunked) frequencies, follow these steps to switch to trunk scanning.

1. Press **TRUNK**. The numbers of the banks which have stored frequencies flash and **BANK** and **TRUNK** appear.

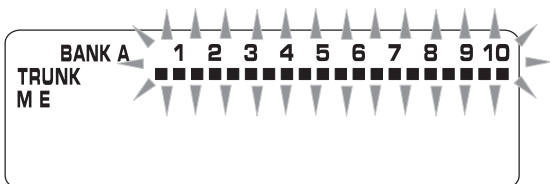

2. Press **▲**. Only the bank numbers you programmed as Motorola (**M**) systems flash. If you want to scan an EDACS (**ME**) system, press **▲** again. Only the bank numbers you programmed as EDACS system flash. Press the number key of the trunked bank you want to scan, then press **SRC**. The scanner searches for a data channel. When the scanner finds it, the scanner begins trunking.!



3. To return to conventional scanning, press **TRUNK**.

**Hint:** While scanning, you may not know exactly to whom the talk group IDs are assigned until you listen awhile. To locate talk group ID lists for your local police, fire, and other agencies, refer to frequency guides available at your local RadioShack store or on internet sites such as [www.trunkscanner.com](http://www.trunkscanner.com). You can also determine the type of agency you are listening to after a short while, be it a police, fire, or emergency medical 2-way radio user. Once you have identified the type of service, note the associated talk group ID of that unit for future programming. See "Identifying a Trunked Frequency" on Page 48. Determining the service associated with an talk group ID might take awhile, but dis-

---

---

covering the ID owner of each signal is half the fun of trunk scanning!

## Turning a Trunked Bank On or Off

Press **DATA (ALT)** during trunk scanning. The selected trunked banks appear. Press the bank number (**0–9**), to turn the desired bank on or off.

## Skipping a Trunked Bank

You can skip to the next trunked bank during scanning by holding down **SRC (LIMIT)** for about 3 seconds.

## Turning the Status Bit Ignore (S-bit) On or Off

You can set how your scanner works with *status bits* (also called S-bits), letting you control how the scanner interprets and displays talkgroup IDs.

The last four bits of a Motorola Type II talkgroup ID (a binary 16-bit code) are the status bits. In some systems, status bits identify special situations (such as an emergency status).

Your scanner is preset to assume that the status bits in a talkgroup ID are set to 0 and ignores them. For example, when the scanner receives the talkgroup ID 010111001110 **0011**, it reads the ID as 010111001110 **0000** and converts the first 12 bits of the ID to 23776 (the talkgroup ID). However, since the status bit value is 3 (0011 converted to decimal equals 3), the ID is actually 23779.

If you are scanning a Motorola Type I system and do not have a fleet map for that system, you might have to turn off status bit ignore in order to determine the proper fleet map.

**Important:** If you are scanning any system other than a Motorola Type I system, be sure status bit ignore is set to **ON** or you will miss some transmissions.

---

---

Follow these steps to turn status bit ignore on or off.

1. Hold down **SCAN** until the current status bit ignore setting (**ON** or **OFF**) appears.
2. Press **▲** to select **ON** or **▼** to select **OFF**, then press **E (SVC)**.

## Identifying a Trunked Frequency

While ID scanning (looking for IDs within a trunked system) or performing an ID search, press **▼** to see the current trunked frequency. (The frequency flashes twice.) Then hold down **▼** until a confirmation tone sounds and the ID and the frequency alternately appear. To return to normal operation, press **▼**.

## Selecting the EDACS Talk Group ID Format

The EDACS system uses two group ID formats: Decimal and Agency-Fleet-Subfleet (AFS). If you use a list of IDs shown in one format (for example AFS) and the ID you want to receive is in the other format (for example, decimal), press **SVC (E)** to switch to the decimal format. The ID appears in decimal format. **E** flashes on the display when the decimal format is selected.

## EDACS Talk Group ID Range Search

To search EDACS IDs faster, set a range for the Agency or Fleet listings. Enter the Agency (or the Agency and the Fleet) listing numbers using the number keys, then press **SRC (LIMIT)**. Note the following examples.

### *Example 1*

Agency = 01

Press **0 1 . SRC (LIMIT)**

**01---** appears during search.

### *Example 2*

Agency = 01 Fleet = 01

Press **0 1 . 0 1 SRC (LIMIT)**

**01-01-** appears during search.

To stop an ID range search, press **SRC (LIMIT)**.



---

## Using HOLD to Monitor an Active Talk Group ID

Follow these steps to stop scanning and keep the scanner tuned to a desired ID.

1. Press **HOLD (A/B)**. **HOLD** appears and the scanner stays on the current ID.
2. If you want to listen to (and hold) a different ID, use the number keys to enter that ID.
3. Press **HOLD (A/B)** again. **HOLD** flashes, then the scanner monitors the ID.
4. Press **SRC** to resume searching for a data channel (trunk scanning).

## Temporarily Storing a Talk Group ID into the Monitor ID Memory

To store a talk group ID into a temporary monitor memory, press **MON/CLR (•)**. This lets you store the ID prior to moving it into a list memory. Press **SRC** to resume searching.

**Note:** To program the ID stored in the monitor ID memory into the ID scan list, see “Moving Talk Group IDs to Talk Group ID Lists” on Page 54.

---

---

## Locking Out Talk Group IDs

Many municipal and commercial services use trunk systems to transmit signals from such devices as water meter transmitters, door alarms, and traffic signals. Some signals are encrypted, as well, and most are not voice signals. Since all these are assigned IDs just like other users, you may want to lock out reception of these ID signals. You can lock out up to 100 IDs at one time.

**Note:** If you lock out an ID while searching, it is also locked out of the scan list(s). See “Using Talk Group ID Lists” on Page 52.

To lock out an ID, press **L-OUT (S/S)** when the ID appears. The ID is locked out, and the next active ID appears.

## Unlocking a Single Talk Group ID

1. Hold down **L-OUT (S/S)** until you hear two short beeps.
2. Repeatedly press ▼ or ▲ to select the ID you want to unlock.
3. Press **L-OUT (S/S)**. The ID is unlocked, and the next locked ID appears.
4. Press **SRC (LIMIT)** to resume the scanner’s previously selected function.

## Unlocking All Talk Group IDs

Hold down **L-OUT (S/S)** while searching until you hear two short beeps, then press **E (SVC)** to unlock all the IDs at once. The scanner beeps twice. Press **L-OUT/SS** to resume the search.

**Note:** When you unlock all the IDs, the scan list appears. Press **SCAN** to scan the IDs stored in your scan lists or press **SRC (LIMIT)** to resume the scanner’s previously selected function. For more information about scan lists, see “Using Talk Group ID Lists” on Page 52.

---

---

## Using Trunk Scanning Scan Delay

Sometimes a user might pause before replying to a transmission. You can set the scanner to hold on an ID for 5 seconds to wait for a reply. That way, the scanner continues to monitor the ID for 5 seconds after the transmission stops before resuming scanning.

Press **DELAY** to turn trunk scanning scan delay on or off. **DLY** appears when the scan delay is set to on.

**Note:** If you consistently miss responses even with scan delay turned on, change the default system type or the fleet map being used. See “Scanning Type I and Hybrid Trunked Systems” on Page 55.

## Monitoring Talk Group IDs

You can use your scanner's display to monitor the frequencies/talk group IDs of a trunked system for activity. While you cannot hear conversations in this mode, it is an excellent way to determine which talk group IDs are the most active. To set the scanner to monitor IDs, hold down **MON/CLR** (•) until **SEARCH** and the channel number flash. All active group IDs appear in quick succession. To stop monitoring IDs, press **SRC** again.

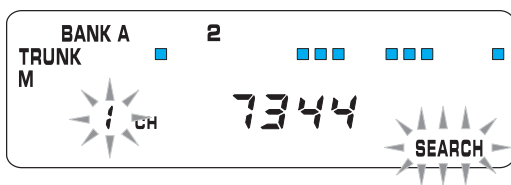

**Note:** When you monitor IDs, any IDs you have locked out also appear.

---

---

## CHANNEL ACTIVITY BARS

Your scanner displays up to 20 channel activity bars for the stored frequencies in a bank. These bars indicate the activity taking place on a trunked system. By observing these bars, you can see how many frequencies are being used and generally monitor how much communication traffic occurs.

Each frequency you store in a trunking bank has a corresponding activity bar. However, there are only 20 bars for a possible maximum of 50 frequencies. If the trunk system contains more than 20 frequencies, some bars will represent more than one frequency.

- If a bar appears steadily without any voice transmission, it represents the frequency in use as the data channel.

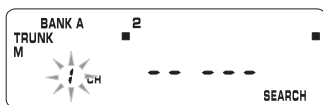

- If a bar appears and flashes when an ID appears, the bar represents the frequency being used by the trunk system transmitter.

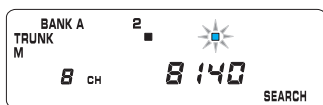

- If a bar appears without any voice transmission, the channel is probably being used for a telephone interconnect call or a private call, or the bar might be a locked-out ID. Your scanner does not monitor these types of calls.
- If the scanner is holding on an ID which is not being used, the other activity bars turn on and off as other groups use the system.

## USING TALK GROUP ID LISTS

When you program trunked frequencies into a bank (see "Storing Trunked Frequencies" on Page 43), your scanner sets up 5 scan lists for that one bank in which you can store your favorite IDs. Each list can contain

---

---

up to 10 IDs, for a total of 50 IDs for each trunk scanning bank. If you use all the banks as trunking banks, you can store 1000 IDs.

Talk group ID lists help you to organize trunking system users into categories. For example, you might use List 1 for police IDs, List 2 for fire department IDs, List 3 for emergency medical service IDs, and so on. Once you store all the IDs in a list, you can scan them just as you scan conventional channels. You can program IDs into talk group ID lists manually, during a search, or automatically.

## Manually Storing Talk Group IDs in Talk Group ID Lists

1. Select the trunking bank you want to use (see “Scanning a Trunked Bank” on Page 46).
2. After the scanner begins trunk scanning, press **MAN**. A number showing the current talk group ID list appears at the top of the display, and bars appear that show activity in other banks.
3. Press **MAN** again, then repeatedly press **▲** or **▼** to select the talk group ID list location (shown at the top of the display) where you want to store an ID. Then press **PROG**.
4. Enter the type of ID you want to store, then press **E**.

*To enter a Type I ID, use the number keys to enter the block number and the fleet number, then press ●. Enter the subfleet number and press E.*

*To enter a EDACS ID, use the number keys to enter the agency number, then press ●. Next, enter the fleet number and the subfleet number, then press E.*

**Note:** To clear a mistake while entering an ID, press **0** then **E**, then start over at Step 1.

5. Repeatedly press **PROG** or **▲** to select the next scan list location you want to program. Then repeat Step 4 to enter another ID.
6. When you finish, press **E** to store the entries.

---

---

## Moving Talk Group IDs to Talk Group ID Lists

1. Press **MAN**. **MAN** appears.
2. Select the ID scan list location where you want to store the IDs, then press **PROG**. **PGM** appears.
3. Press **MON/CLR**. A monitor ID appears.
4. Press **E**. The scanner stores the IDs into the selected ID scan list.

## Scanning the Talk Group ID Lists

Press **SCAN** to begin scanning the lists you have stored.

**Note:** If one or more of the IDs you stored are incorrect, **Error** flashes twice and the scanner beeps several times, then the scan list numbers appear at the top of the display. To correct the entry, delete at least one of the incorrect IDs (see “Deleting a Stored Talk Group ID List”).

To remove a scan list from active scanning, use the number keys to enter the scan list’s number. The scan list number turns off, and the IDs in that list are not scanned.

**Note:** One of the five scan lists must always be active. You cannot remove all of them.

To restore a scan list to active scanning, use the number keys to enter the number of the list again.

Press **SRC** to return to the previously selected function.

## Deleting a Stored Talk Group ID List

1. Press **PROG**. **PGM** appears.
2. Repeatedly press **▲** or **▼** to select the talk group ID list location (shown at the top of the display) you want to delete.
3. Press **0** then **E**.

---

---

## Priority Talk Group ID Scanning

You can assign a priority to a favorite ID so during scanning the scanner checks that ID more frequently than the others in the list. Each of the five memory locations reserved for storing lists (see “Using Talk Group ID Lists” on Page 52) can have only one priority ID, and the ID assigned that priority in List 1 has the highest priority of all.

To assign a priority to an ID, press **PROG**. Enter the desired ID number (list number and location number), then press **PRIORITY (H/S)**. **P** appears.

To turn priority ID scanning on or off, repeatedly press **PRIORITY (H/S)** during ID scanning or manual operation. **PRI** appears when priority scanning is turned on.

**Note:** Priority ID scanning does not operate when priority IDs are locked out. See “Locking Out Talk Group IDs” on Page 50.

## SCANNING TYPE I AND HYBRID TRUNKED SYSTEMS

Your PRO-94 is preset to scan Type II system IDs. When you scan trunked frequencies, each Type II user ID you see appears as an even number without a dash (example 2160). Your PRO-94 can also scan Type I trunked systems. Each Type I ID appears as a three- or four-digit number, followed by a hyphen, followed by a one- or two-digit number (example 200-14).

If you notice a mix of odd- and even-user IDs (examples 6477, 2160, 6481, 6144, and 1167), then you are probably monitoring either a Type I or hybrid (a combination of Type I and Type II user IDs) system with the S-Bit function turned off (see “Types of Trunking Systems” on Page 41 and “Turning the Status Bit Ignore (S-bit) On or Off” on Page 47).

---

---

Subfleet information is included with the frequency list for a Type I system. To enter the provided map, see “Programming a Fleet Map” on Page 60.

**Note:** Review the content of website *www.trunkscanner.com* to locate suitable fleet map information.

If you do not already know the size codes used, you will have to guess. Since you do not have to figure out all the blocks at one time, this is not as hard as it might seem. Select a size code for a block, then press **SRC**. Now listen to the communications. If you decide you are receiving most of the replies to the conversations, then you have probably selected the right size code and can programming the next block of the map.

There are 16 preset fleet maps to choose from, and it is best to start with these when setting up a Type I or hybrid trunk scanning bank. If none of the following preset fleet maps allow you to follow complete conversations, then you probably need to program your own fleet map (see “Programming a Fleet Map” on Page 60).



E1P1		E1P2		E1P3	
Block	Size Code	Block	Size Code	Block	Size Code
0	S11	0	S4	0	S4
1	S11	1	S4	1	S4
2	S11	2	S4	2	S4
3	S11	3	S4	3	S4
4	S11	4	S4	4	S4
5	S11	5	S4	5	S4
6	S11	6	S4	6	S12
7	S11	7	S4	7	(S12)

E1P4		E1P5		E1P6	
Block	Size Code	Block	Size Code	Block	Size Code
0	S12	0	S4	0	S3
1	(S12)	1	S4	1	S10
2	S4	2	S12	2	S4
3	S4	3	(S12)	3	S4
4	S4	4	S4	4	S12
5	S4	5	S4	5	(S12)
6	S4	6	S4	6	S12
7	S4	7	S4	7	(S12)

E1P7		E1P8		E1P9	
Block	Size Code	Block	Size Code	Block	Size Code
0	S10	0	S1	0	S4
1	S10	1	S1	1	S4
2	S11	2	S2	2	S0
3	S4	3	S2	3	S0
4	S4	4	S3	4	S0
5	S4	5	S3	5	S0

6	S4	6	S4	6	S0
7	S4	7	S4	7	S0

E1P10		E1P11		E1P12	
Block	Size Code	Block	Size Code	Block	Size Code
0	S0	0	S4	0	S0
1	S0	1	S0	1	S0
2	S0	2	S0	2	S0
3	S0	3	S0	3	S0
4	S0	4	S0	4	S0
5	S0	5	S0	5	S0
6	S4	6	S0	6	S0
7	S4	7	S0	7	S4

E1P13		E1P14		E1P15	
Block	Size Code	Block	Size Code	Block	Size Code
0	S3	0	S4	0	S4
1	S3	1	S3	1	S4
2	S11	2	S10	2	S4
3	S4	3	S4	3	S11
4	S4	4	S4	4	S11
5	S0	5	S4	5	S0
6	S0	6	S12	6	S12
7	S0	7	(S12)	7	(S12)

E1P16	
Block	Size Code
0	S3
1	S10
2	S10
3	S11
4	S0
5	S10
6	S12
7	(S12)

## Selecting a Preset Fleet Map

1. Set the scanner for conventional scanning and press **PROG** then **TRUNK** to select the bank to store the fleet map. A previously programmed trunked frequency appears.
2. Press a number key to select the bank to store the fleet map.
3. Repeatedly press **▲** or **▼** to select **E1**, then press **E**.
4. Press **DATA (ALT)**.
5. Repeatedly press **▲** or **▼** to select the name of the desired map (example **E1P7**). The preprogrammed fleet map appears.
6. Press **E (SVC)**, then press **SRC (LIMIT)**. The scanner then searches for transmissions using the preset map you chose.

**Note:** When the scanner searches for transmissions, you see Type I fleet and subfleet IDs such as **100-12**, **100-9**, **000-12**, or **400-8**.

How do you know if the preset map you selected is correct? Listen to find out if you are following complete conversations. If not, try another preset map.

---

---

## Programming a Fleet Map

1. Set the scanner for conventional scanning. Press **PROG**, then press **TRUNK**.
2. Press the number key of the bank where you want to store the fleet map.
3. Repeatedly press **▲** or **▼** until **E1** appears, then press **E**. A trunked frequency you previously programmed appears.
4. Press **DATA**. A preprogrammed fleet map appears.
5. Repeatedly press **▲** or **▼** until **USR** appears. Then press **E**.
6. Press **DATA**.
7. Repeatedly press **▲** or **▼** to select the size code for the first block, then press **E**. The next available block appears.

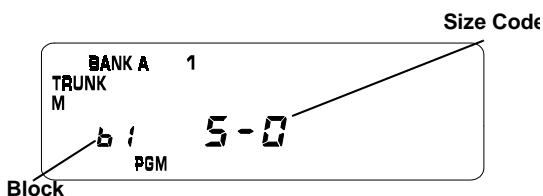

8. Repeat Step 7 until you have selected a size code for each desired block.
9. Press **SRC (LIMIT)**. The scanner exits the trunking programming mode, tunes the data channel, then searches using the map you programmed.

**Note:** If you select size code S-12, S-13, or S-14, these restrictions apply:

- S-12 can only be assigned to Blocks 0, 2, 4, or 6
- S-13 can only be assigned to Blocks 0 and 4
- S-14 can only be assigned to Block 0

Since these size codes require multiple blocks, you will be prompted for the next available block when you program a fleet map. For example, if you assign Block 0 as S-12, the scanner prompts you for **b2**, the next block available, instead of **b1**. If you assign Block 0 as S-14, you would not see another prompt because S-14 uses all available blocks.

---

---

## Programming the Base and Offset Frequencies

To properly track Motorola VHF and UHF trunked systems, you must program the applicable *base* and *offset* frequencies for each system.

A list of these frequencies can be found at [www.trunk-scanner.com](http://www.trunk-scanner.com) and other similar frequency resources.

1. Set the scanner for conventional scanning. Press **PROG** then **TRUNK**.
2. Press the number key of the bank where you want to store the base frequency.
3. Repeatedly press **▲** or **▼** to select **E2-VHi** or **E2-UHF**, then press **E**. A previously programmed trunked frequency appears
4. Press **DATA (ALT)**. The preset base frequency appears.
5. Enter a desired frequency.
6. Press **DATA (ALT)**. The preset offset frequency appears.
7. Enter the frequency using the number keys according to the following guide:
  - For Motorola Type II VHF, (E2-VHF Hi band) use 5kHz steps between 5 kHz – 100 kHz.
  - For Motorola Type II UHF, (E2-UHF band) use 12.5kHz steps between 12.5 kHz – 100 kHz.

## Programming a Hybrid System

A hybrid system is simply a Type I system with some of its blocks designated as Type II blocks. To program a hybrid system, follow the steps listed in “Programming a Fleet Map” on Page 60. However, if you want a block to be Type II, instead of pressing **▲** or **▼** to select the size block (Step 7), enter size code **S-0** instead.

---

---

## Turning On/Off the Motorola Disconnect Tone Detect Function

While trunking a Motorola system, your scanner automatically tunes to the data channel when it detects a disconnect tone (a code that tells the trunking system that the transmitter has finished sending) on the voice channel.

You can manually turn off this function so the scanner does not tune to the data channel under those conditions. You might use this feature to listen to weak transmissions when conversations are generally disconnected.

To turn the disconnect tone detect function on or off, set the scanner to trunk track then press **SVC**. The scanner beeps and **DATA** flashes for about 5 seconds.

### Notes:

- To set the scanner so it remains on the voice channel (even when a disconnect tone is transmitted or there is no signal at all) set **SQUELCH** so you hear a hissing.
- You cannot use the disconnect tone detect function if you are programming a trunking frequency or a fleet map.

To set the scanner to automatically tune to the data channel once again when it detects a disconnect tone, press **SVC (E)**.

# A GENERAL GUIDE TO SCANNING

---

---

Your scanner's reception is mainly "line-of-sight." You usually cannot hear stations that are beyond the horizon.

## GUIDE TO FREQUENCIES

### National Weather Frequencies

162.400	162.475	162.525
162.425	162.500	162.550
162.450		

### Birdie Frequencies

Every scanner has birdie frequencies. Birdies are signals created by the scanner's internal circuits. These stray frequencies might interfere with broadcasts on the same or similar frequencies. If you program one of these frequencies, you hear only noise on that frequency. If the interference is not severe, you might be able to turn **SQUELCH** clockwise to cut out the birdie.

This scanner's known birdie frequencies (in MHz) are:

41.6000	145.6000	165.3000	171.2500
407.7625	407.8125	413.1750	413.2250
415.0000	435.9250	455.7375	465.6500
485.4625	489.2500	823.8000	899.2375
906.4125	906.5875	926.7000	1290.7000

---

---

# GUIDE TO THE ACTION BANDS

## Typical Band Usage

### VHF Band

Low Range	29.00–50.00 MHz
6-Meter Amateur	50.00–54.00 MHz
U.S. Government	137.00–144.00 MHz
2-Meter Amateur	144.00–148.00 MHz
High Range	148.00–174.00 MHz
1-Meter Amateur	216.00–225.00 MHz

### UHF Band

U.S. Government	406.00–420.00 MHz
70-cm Amateur	420.00–450.00 MHz
Low Range	450.00–470.00 MHz
FM-TV Audio Broadcast, Wide Band	470.00–512.00 MHz
Public Service	806.00–823.93 MHz
Conventional Systems	851.00–856.00 MHz
Conventional/Trunked Systems	856.00–861.00 MHz
Trunked Systems	861.00–866.00 MHz
Public Safety	866.00–868.93 MHz
High Range	896.11–902.00 MHz
33-Centimeter Amateur	902.00–928.00 MHz
Private Trunked	935.00–940.00 MHz
General Trunked	940.00–941.00 MHz
Fixed Services	941.00–944.00 MHz
Studio-to-Transmitter Broadcast Links	944.00–952.00 MHz
Private Fixed Services, Paging	952.00–956.00 MHz
25-Centimeter Amateur	1240.00–1300.00MHz

## Primary Usage

As a general rule, most of the radio activity is concentrated on the following frequencies:

### VHF Band

Activities	Frequencies
Government, Police, and Fire	153.785–155.980 MHz
Emergency Services	158.730–159.460 MHz
Railroad	160.000–161.900 MHz



---

---

## UHF Band

Activities	Frequencies
Land-Mobile "Paired" Frequencies	450.000–470.000 MHz
Base Stations	451.025–454.950 MHz
Mobile Units	456.025–459.950 MHz
Repeater Units	460.025–464.975 MHz
Control Stations	465.025–469.975 MHz

**Note:** Remote control stations and mobile units operate at 5 MHz higher than their associated base stations and relay repeater units.

## BAND ALLOCATION

Use the following listing of the typical services within your scanner's frequency coverage to assist you to decide which frequency ranges to scan. These frequencies are subject to change, and might vary from area to area. For a more complete listing, refer to the "Police Call Radio Guide including Fire and Emergency Services," available at your local RadioShack store.

### Abbreviations

### Services

BIFC .....	Boise (ID) Interagency Fire Cache
BUS .....	Business
CAP .....	Civil Air Patrol
CB .....	Citizens Band
CCA .....	Common Carrier
CSB .....	Conventional Systems
CTSB .....	Conventional/Trunked Systems
FIRE .....	Fire Department
HAM .....	Amateur (Ham) Radio
GOVT .....	Federal Government
GMR .....	General Mobile Radio
GTR .....	General Trunked
IND .....	Industrial Services (Manufacturing, Construction, Farming, Forest Products)
MAR .....	Military Amateur Radio
MARI .....	Maritime Limited Coast ..... (Coast Guard, Marine Telephone, ..... Shipboard Radio, Private Stations)
MARS .....	Military Affiliate Radio System
MED .....	Emergency/Medical Services
MIL .....	U.S. Military
MOV .....	Motion Picture/Video Industry
NEW .....	New Mobile Narrow
NEWS .....	Relay Press (Newspaper Reporters)
OIL .....	Oil/Petroleum Industry
POL .....	Police Department
PUB .....	Public Services (Public Safety, Local Government, Forestry Conservation)
PSB .....	Public Safety
PTR .....	Private Trunked

ROAD .....	Road & Highway Maintenance
RTV .....	Radio/TV Remote Broadcast Pickup
TAXI .....	Taxi Services
TELB .....	Mobile Telephone
	(Aircraft, Radio Common Carrier, Landline Companies)
TELC .....	Cordless Phones
TELM .....	Telephone Maintenance
TOW .....	Tow Trucks
TRAN .....	Transportation Services
	Trucks, Tow Trucks, Buses, Railroad, Other)
TSB .....	Trunked Systems
TVn .....	FM-TV Audio Broadcast
USXX .....	Government Classified
UTIL .....	Power & Water Utilities
WTHR .....	Weather

## VERY HIGH FREQUENCY (VHF)

### VHF Low Band—(29–50 MHz—in 5 kHz steps)

29.000–29.700 .....	HAM
29.900–30.550 .....	GOVT, MIL
30.580–31.980 .....	IND, PUB
32.000–32.990 .....	GOVT, MIL
33.020–33.980 .....	BUS, IND, PUB
34.010–34.990 .....	GOVT, MIL
35.020–35.980 .....	BUS, PUB, IND, TELM
36.000–36.230 .....	GOVT, MIL
36.250 .....	Oil Spill Cleanup
36.270–36.990 .....	GOVT, MIL
37.020–37.980 .....	PUB, IND
38.000–39.000 .....	GOVT, MIL
39.020–39.980 .....	PUB
40.000–42.000 .....	GOVT, MIL, MARI
42.020–42.940 .....	POL
42.960–43.180 .....	IND
43.220–43.680 .....	TELM, IND, PUB
43.700–44.600 .....	TRAN
44.620–46.580 .....	POL, PUB
46.600–46.990 .....	GOVT, TELC
47.020–47.400 .....	PUB
47.420 .....	American Red Cross
47.440–49.580 .....	IND, PUB
49.610–49.990 .....	MIL, TELC

### 6-Meter Amateur Band—(50–54 MHz)

50.00–54.00 .....	HAM
-------------------	-----

### Aircraft Band—(108–137 MHz)

108.00–121.490 .....	AIR
121.500 .....	AIR Emergency
121.510–136.000 .....	AIR

### U.S. Government Band (137–144 MHz)

137.000–144.000 .....	GOVT, MIL
-----------------------	-----------

### 2-Meter Amateur Band (144–148 MHz)

144.000–148.000 .....	HAM
-----------------------	-----

### VHF High Band (148–174 MHz)

148.050–150.345 .....	CAP, MAR, MIL
150.775–150.790 .....	MED
150.815–150.980 .....	TOW, Oil Spill Cleanup
150.995–151.475 .....	ROAD, POL
151.490–151.955 .....	IND, BUS
151.985 .....	TELM

152.0075	.....	MED
152.030-152.240	.....	TELB
152.270-152.480	.....	IND, TAXI, BUS
152.510-152.840	.....	TELB
152.870-153.020	.....	IND, MOV
153.035-153.725	.....	IND, OIL, UTIL
153.740-154.445	.....	PUB, FIRE
154.490-154.570	.....	IND, BUS
154.585	.....	Oil Spill Cleanup
154.600-154.625	.....	BUS
154.655-156.240	.....	MED, ROAD, POL, PUB
156.255-157.425	.....	OIL, MARI
157.450	.....	MED
157.470-157.515	.....	TOW
157.530-157.725	.....	IND, TAXI
157.740	.....	BUS
157.770-158.100	.....	TELB
158.130-158.460	.....	BUS, IND, OIL, TELM, UTIL
158.490-158.700	.....	TELB
158.730-159.465	.....	POL, PUB, ROAD
159.480	.....	OIL
159.495-161.565	.....	TRAN
161.580-162.000	.....	OIL, MARI, RTV
162.0125-162.35	.....	GOVT, MIL, USXX
162.400-162.550	.....	WTHR
162.5625-162.6375	.....	GOVT, MIL, USXX
162.6625	.....	MED
162.6875-163.225	.....	GOVT, MIL, USXX
163.250	.....	MED
163.275-166.225	.....	GOVT, MIL, USXX
166.250	.....	GOVT, RTV, FIRE
166.275-169.400	.....	GOVT, BIFC
169.445-169.505	.....	Wireless Mikes, GOVT
169.55-169.9875	.....	GOVT, MIL, USXX
170.000-170.150	.....	BIFC, GOVT, RTV, FIRE
170.175-170.225	.....	GOVT
170.245-170.305	.....	Wireless Mikes
170.350-170.400	.....	GOVT, MIL
170.425-170.450	.....	BIFC
170.475	.....	PUB
170.4875-173.175	.....	GOVT, PUB, Wireless Mikes
173.225-173.5375	.....	MOV, NEWS, UTIL, MIL
173.5625-173.5875	.....	MIL Medical/Crash Crews
173.60-173.9875	.....	GOVT
216.00-224.9950	.....	HAM

## ULTRA HIGH FREQUENCY (UHF)

### U. S. Government Band (406-420 MHz)

406.125-419.975 ..... GOVT, USXX

### 70-cm Amateur Band (420-450 MHz)

420.000-450.000 ..... HAM

### Low Band (450-470 MHz)

450.050-450.925	.....	RTV
451.025-452.025	.....	IND, OIL, TELM, UTIL
452.0375-453.00	.....	IND, TAXI, TRAN TOW, NEWS
453.0125-454.000	.....	PUB, OIL
454.025-454.975	.....	TELB
455.050-455.925	.....	RTV
457.525-457.600	.....	BUS
458.025-458.175	.....	MED
460.0125-460.6375	.....	FIRE, POL, PUB
460.650-462.175	.....	BUS
462.1875-462.450	.....	BUS, IND
462.4625-462.525	.....	IND, OIL, TELM, UTIL
462.550-462.925	.....	GMR, BUS

---



---

462.9375–463.1875 .....	MED
463.200–467.925 .....	BUS

**FM-TV Audio Broadcast, UHF Wide Band (470–512 MHz)  
(Channels 14 through 69 in 6 MHz steps)**

475.750 .....	Channel 14
481.750 .....	Channel 15
487.750 .....	Channel 16
511.750 .....	Channel 20

**Note:** Some cities use the 470–512 MHz band for land/mobile service.

**Conventional Systems Band – Locally Assigned**

851.0125–855.9875 .....	CSB
-------------------------	-----

**Conventional/Trunked Systems Band – Locally Assigned**

856.0125–860.9875 .....	CTSB
-------------------------	------

**Trunked Systems Band – Locally Assigned**

861.0125–865.9875 .....	TSB
-------------------------	-----

**Public Safety Band – Locally Assigned**

866.0125–868.9875 .....	PSB
-------------------------	-----

**33-Centimeter Amateur Band (902–928 MHz)**

902.0000–928.0000 .....	HAM
-------------------------	-----

**Private Trunked**

935.0125–939.9875 .....	PTR
-------------------------	-----

**General Trunked**

940.0125–940.9875 .....	GTR
-------------------------	-----

**25-Centimeter Amateur Band**

1240.0000–1300.0000 .....	GTR
---------------------------	-----

## FREQUENCY CONVERSION

The tuning location of a station can be expressed in frequency (kHz or MHz) or in wavelength (meters). The following information can help you make the necessary conversions.

$$1 \text{ MHz (million)} = 1,000 \text{ kHz (thousand)}$$

To convert MHz to kHz, multiply the number of megahertz by 1,000:

$$9.62 \text{ (MHz)} \times 1000 = 9620 \text{ kHz}$$

To convert from kHz to MHz, divide the number of kilohertz by 1,000:

$$2780 \text{ (kHz)} \div 1000 = 2.780 \text{ MHz}$$

To convert MHz to meters, divide 300 by the number of megahertz:

$$300 \div 7.1 \text{ MHz} = 42.25 \text{ meters}$$

# TROUBLESHOOTING

If your PRO-94 is not working as it should, these suggestions might help you eliminate the problem. If the scanner still does not operate properly, take it to your local RadioShack store for assistance.

Problem	Possible Cause	Remedy
Scanner is on but will not scan.	<b>SQUELCH</b> is not adjusted correctly.	Turn <b>SQUELCH</b> clockwise.
	Only one channel or no channels are stored.	Store frequencies into more than one channel.
Scanner is totally inoperative.	No power.	Check the batteries or make sure the AC adapter or DC adapter is connected properly.
		Recharge the rechargeable batteries or replace the non-rechargeable batteries.
	The AC adapter or DC adapter is not connected.	Be sure the adapter's barrel plug is fully plugged into the <b>POWER</b> jack.
The scanner's display dims or the scanner sounds a tone every 15–30 seconds.	Batteries are not correctly installed.	Make sure the batteries are installed properly.
	The batteries are weak.	Recharge the rechargeable batteries or replace the non-rechargeable batteries.
The keypad does not work.	The keylock function is activated.	To turn off the keylock, press <b>KEYLOCK</b> until <b>K/L</b> disappears.

<b>Problem</b>	<b>Possible Cause</b>	<b>Remedy</b>
<b>BATT . Lo</b> flashes.	The batteries are weak.	Recharge the rechargeable batteries or replace the non-rechargeable batteries.
Poor or no reception.	Batteries are weak or completely discharged.	Check the batteries or make sure the AC adapter or DC adapter is connected properly.
	An antenna is not connected or is connected incorrectly.	Make sure an antenna is connected to the scanner.
<b>Error</b> appears.	Programming error.	Re-enter the frequency correctly, including the decimal point.
The scanner locks on frequencies that have an unclear transmission.	Stored frequencies are the same as "birdie" frequencies.	Avoid storing frequencies listed under "Birdie Frequencies" on Page 63, or only listen to them manually.
The scanner does not track a trunked system.	The transmission might not use a system that can be tracked by your scanner.	Scan another transmission.
	The data frequency is missing.	Find the data frequency (see "Storing Trunked Frequencies" on Page 43).
	The system you are trying to track is a Type I system, and the scanner is set to scan Type II systems.	Set the scanner to receive Type I trunked frequencies. See "Scanning Type I and Hybrid Trunked Systems" on Page 55.

Problem	Possible Cause	Remedy
Scanner is set to receive Type I trunked frequencies, but does not scan them.	The fleet map you have selected or entered might be incorrect.	Check the fleet map and correct it if necessary (see “Scanning Type I and Hybrid Trunked Systems” on Page 55 and “Programming a Fleet Map” on Page 60).
Scanner does not acquire a data channel.	<b>SQUELCH</b> is not correctly adjusted for trunk scanning.	Adjust squelch for trunk scanning. See “Setting Squelch for the Trunking Mode” on Page 43.
	The frequency used for the data channel is missing.	Press <b>SRC</b> to search for the data channel (see “Storing Trunked Frequencies” on Page 43).
Missing replies to conversations.	The system you are trying to track is a Type I system, and the scanner is set to scan Type II systems.	Set the scanner to receive Type I trunked frequencies. See “Scanning Type I and Hybrid Trunked Systems” on Page 55.
	The selected fleet map is incorrect.	Try another preset fleet map or program your own fleet map (see “Scanning Type I and Hybrid Trunked Systems” on Page 55).
	Not all of the trunk’s frequencies have been entered.	Enter all of the trunk’s frequencies (see “Storing Trunked Frequencies” on Page 43).

Problem	Possible Cause	Remedy
Channel activity bars are flashing but no sound is heard.	The transmission might be a private or telephone interconnect call. The scanner does not scan these types of transmissions.	Scan for another transmission.
	The ID shown is not active.	Wait for the ID to become active, or scan another transmission.

## RESETTING THE SCANNER

If the scanner's display locks up or stops operating properly, you might need to reset the scanner.

**Caution:** This procedure clears all the information you have stored in the scanner. Before you reset the scanner, try turning it off and on to see if it begins working properly. Reset the scanner only when you are sure it is not working properly.

1. Turn off the scanner.
2. While holding down the **2** and **9** keys, turn on the scanner. **CLEAR** flashes for about 5 seconds as the scanner clears its memory.

**Note:** Do not turn off the scanner again until **CLEAR** stops flashing. Otherwise, the scanner might not clear its memory properly.



# CARE AND MAINTENANCE

---

Your RadioShack PRO-94 1000-Channel Handheld Trunking Scanner is an example of superior design and craftsmanship. The following suggestions will help you care for your scanner so you can enjoy it for years.



Keep the scanner dry. If it gets wet, wipe it dry immediately. Liquids might contain minerals that can corrode the electronic circuits.



Use and store the scanner only in normal temperature environments. Temperature extremes can shorten the life of electronic devices, damage batteries, and distort or melt plastic parts.



Keep the scanner away from dust and dirt, which can cause premature wear of parts.



Handle the scanner gently and carefully. Dropping it can damage circuit boards and cases and can cause the scanner to work improperly.



Use only fresh batteries of the required size and recommended type. Batteries can leak chemicals that damage your scanner's electronic parts.



Wipe the scanner with a damp cloth occasionally to keep it looking new. Do not use harsh chemicals, cleaning solvents, or strong detergents to clean the scanner.

Modifying or tampering with the scanner's internal components can cause a malfunction, invalidate your scanner's warranty and void your FCC authorization to operate it. If your scanner is not operating as it should, take it to your local RadioShack store for assistance.

# SPECIFICATIONS

---

---

Frequency Coverage: .....	29–54 MHz (in 5 kHz steps)
	108–136.975 MHz (in 12.5 kHz steps)
	137–174 MHz (in 5 kHz steps)
	216–224.995 MHz (in 5 kHz steps)
	406–512 MHz (in 12.5 kHz steps)
	806.0000–823.9375 MHz (in 12.5 kHz steps)
	851.0000–868.9875 MHz (in 12.5 kHz steps)
	896.1125–956.0000 MHz (in 12.5 kHz steps)
	1240.0000–1300.0000 MHz (in 12.5 kHz steps)
Monitor Channels .....	10
Number of Banks .....	20
Sensitivity (AM/FM):	
FM .....	20 dB S/N at 3 kHz deviation)
29–54 MHz .....	0.5 $\mu$ V
137–174 MHz .....	0.5 $\mu$ V
216–225 MHz .....	0.6 $\mu$ V
406–512 MHz .....	0.5 $\mu$ V
806–956 MHz .....	0.6 $\mu$ V
1240–1300 MHz .....	4.0 $\mu$ V
AM .....	20 dB S/N at 60% modulation)
108–136.9875 MHz .....	1.5 $\mu$ V
Spurious Rejection (at 40.84 MHz) .....	50 dB
Selectivity:	
10 kHz .....	–6 dB
15 kHz .....	–50 dB
IF Rejection (at 162.4 MHz) .....	80 dB
Channels .....	1000
Operating Temperature ....	–4 to 140° F (–20 to 60° C)
Scan Speed .....	50 Channels/Second
Search Speed:	
Normal .....	100 Steps/Second
Hypersearch .....	300 Steps/Second
Service .....	50 Frequencies/Second
Priority Sampling .....	2 Seconds
Delay Time .....	2 Seconds
IF Frequencies .....	380.7 MHz, 10.85 MHz, 450 kHz
Antenna Impedance .....	50 Ohms
Audio Output .....	350 mW maximum

---

---

Built-in Speaker .....  $1\frac{7}{16}$  Inches (36 mm)  
8 Ohm Dynamic Type

Maximum Current Drain ..... 180 mA

Power Requirements:

4 AA Alkaline Batteries (6.0 VDC),  
or 4 AA Rechargeable Ni-Cd Batteries (4.8 VDC)  
or Optional AC Adapter  
or Optional DC Adapter

Current Drain:

Squelched..... 70 mA

Full Output ..... 180 mA

Dimensions (HWD) .....  $6 \times 2\frac{3}{5} \times 1\frac{3}{4}$  Inches  
(153 × 66 × 44 mm)

Weight (without antenna, batteries, belt clip) ..... 8.2 oz  
(232 g)

Specifications are typical; individual units might vary.  
Specifications are subject to change and improvement  
without notice.

## Limited One-Year Warranty

This product is warranted by RadioShack against manufacturing defects in material and workmanship under normal use for one (1) year from the date of purchase from RadioShack company-owned stores and authorized RadioShack franchisees and dealers. EXCEPT AS PROVIDED HEREIN, RadioShack MAKES NO EXPRESS WARRANTIES AND ANY IMPLIED WARRANTIES, INCLUDING THOSE OF MERCHANTABILITY AND FITNESS FOR A PARTICULAR PURPOSE, ARE LIMITED IN DURATION TO THE DURATION OF THE WRITTEN LIMITED WARRANTIES CONTAINED HEREIN. EXCEPT AS PROVIDED HEREIN, RadioShack SHALL HAVE NO LIABILITY OR RESPONSIBILITY TO CUSTOMER OR ANY OTHER PERSON OR ENTITY WITH RESPECT TO ANY LIABILITY, LOSS OR DAMAGE CAUSED DIRECTLY OR INDIRECTLY BY USE OR PERFORMANCE OF THE PRODUCT OR ARISING OUT OF ANY BREACH OF THIS WARRANTY, INCLUDING, BUT NOT LIMITED TO, ANY DAMAGES RESULTING FROM INCONVENIENCE, LOSS OF TIME, DATA, PROPERTY, REVENUE, OR PROFIT OR ANY INDIRECT, SPECIAL, INCIDENTAL, OR CONSEQUENTIAL DAMAGES, EVEN IF RadioShack HAS BEEN ADVISED OF THE POSSIBILITY OF SUCH DAMAGES.

Some states do not allow the limitations on how long an implied warranty lasts or the exclusion of incidental or consequential damages, so the above limitations or exclusions may not apply to you.

In the event of a product defect during the warranty period, take the product and the RadioShack sales receipt as proof of purchase date to any RadioShack store. RadioShack will, at its option, unless otherwise provided by law: (a) correct the defect by product repair without charge for parts and labor; (b) replace the product with one of the same or similar design; or (c) refund the purchase price. All replaced parts and products, and products on which a refund is made, become the property of RadioShack. New or reconditioned parts and products may be used in the performance of warranty service. Repaired or replaced parts and products are warranted for the remainder of the original warranty period. You will be charged for repair or replacement of the product made after the expiration of the warranty period.

This warranty does not cover: (a) damage or failure caused by or attributable to acts of God, abuse, accident, misuse, improper or abnormal usage, failure to follow instructions, improper installation or maintenance, alteration, lightning or other incidence of excess voltage or current; (b) any repairs other than those provided by a RadioShack Authorized Service Facility; (c) consumables such as fuses or batteries; (d) cosmetic damage; (e) transportation, shipping or insurance costs; or (f) costs of product removal, installation, set-up service adjustment or reinstallation.

This warranty gives you specific legal rights, and you may also have other rights which vary from state to state.

RadioShack Customer Relations, 200 Taylor Street, 6th Floor, Fort Worth, TX 76102

*We Service What We Sell*

04/99

**RadioShack**  
**A Division of Tandy Corporation**  
**Fort Worth, Texas 76102**