

scan by IZ8OLI

scan by IZ8OLI

scan by IZ8OLI

# SOMMERKAMP®

## **TS-220DX** **VHF/UHF FM DUAL BANDER** --- **USER'S MANUAL**



scan by IZ8OLI

scan by IZ8OLI

scan by IZ8OLI

scan by IZ8OLI

scan by IZ8OLI

scan by IZ8OLI

scan by IZ8OLI

scan by IZ8OLI

scan by IZ8OLI

scan by IZ8OLI

scan by IZ8OLI

scan by IZ8OLI

scan by IZ8OLI

scan by IZ8OLI

scan by IZ8OLI

# TABLE OF CONTENTS

<b>1 Preparation</b> .....	1	<b>2-16 Resetting the TS-220DX</b> .....	16
1-1 Features .....	2	<b>3 Memory Function</b> .....	17
1-2 Accessories .....	3	3-1 Storing Frequencies into Memory .....	17
1-3 Getting Acquainted .....	3	3-2 Recalling Memory .....	17
1-4 Manual Conventions .....	8	3-3 Clearing a Memory .....	18
1-5 Using the TS-220DX's Set Menu .....	9	3-4 Changing Stored Memories .....	18
1-6 A Quick Look at The Display .....	11	3-5 Protecting Memory .....	19
<b>2 Basic Operations</b> .....	12	3-6 Storing/Changing Channel ID .....	19
2-1 Turning Power On/Off .....	12	3-7 Call Channel .....	20
2-2 Adjusting Volume and Squelch .....	12	3-8 Changing Call Frequency .....	20
2-3 Using SQL OFF .....	12	3-9 Changing CALL Frequency Temporarily .....	21
2-4 Selecting Main Band .....	12	<b>4 Scanning</b> .....	22
2-5 Selecting Frequency .....	13	4-1 1MHz Scan .....	22
2-6 Transmitting .....	13	4-2 Band Scan .....	22
2-7 Inhibiting Transmissions .....	14	4-3 Program Scan .....	22
2-8 Selecting Output Power .....	14	4-4 Memory Scan .....	23
2-9 Changing Frequency Step .....	14	4-5 Specific Memory Scan .....	23
2-10 Changing Frequency Step in 100KHz, 1MHz or 10MHz .....	14	4-6 Memory Block Scan .....	24
2-11 Using Key Lock .....	15	4-7 Scan Specific Memory Under Memory Block Scan .....	24
2-12 Using Selector Lock and Key Lock .....	15	4-8 Tone Squelch Frequency Scan .....	25
2-13 Single Band Operation .....	15	4-9 Selecting Scan Resume Type .....	25
2-14 Using Display Light .....	16	<b>5 Dual Watch</b> .....	26
2-15 Testing Display Window .....	16	5-1 Memory M00 Dual Watch .....	26

# TABLE OF CONTENTS

5-2 Any Memory Mxx Dual Watch .....	27	7-12 Changing Page Rings .....	37
5-3 Call Channel Dual Watch .....	27	7-13 Using DTMF Code Squelch .....	37
5-4 Memory Sequence Dual Watch .....	27	<b>8 CTCSS Features</b> .....	38
5-5 Changing Dual Watch Speed .....	28	8-1 Using Tone Encode .....	38
<b>6 Operating Through Repeaters</b> .....	29	8-2 Using Tone Squelch .....	38
6-1 Setting Offset Direction .....	29	8-3 Setting CTCSS Tone .....	38
6-2 Changing Offset Frequency .....	30	<b>9 Additional Features</b> .....	40
6-3 Reversing Transmission and Reception Frequency .....	30	9-1 Setting AM Reception Mode .....	40
6-4 Cross-Band Repeater Operations .....	30	9-2 Setting Auto Power Off .....	40
6-5 Setting 2-Second Cross-Band Repeater Delay .....	31	9-3 Setting Reception Attenuation( ATT ) .....	40
<b>7 DTMF Features</b> .....	32	9-4 Setting Auto AM Mode .....	41
7-1 Manually Transmitting DTMF Codes .....	32	9-5 Setting Auto Power On Function .....	41
7-2 Storing DTMF Sequences .....	32	9-6 Turning Entry Beep Tone On/Off .....	42
7-3 Clearing DTMF Memory .....	33	9-7 Cloning .....	42
7-4 Transmit DTMF Sequence from Memory .....	33	9-8 Full Duplex Operation .....	44
7-5 Changing DTMF Transmitting Speed .....	34	9-9 Setting 1KHz Digit Option .....	45
7-6 Using DTMF Decode Function .....	34	9-10 Setting Power On Message .....	45
7-7 DTMF Paging .....	35	9-11 Battery Save .....	46
7-8 Setting Personal or Group Code .....	35	9-12 Selecting Internal/External Speaker .....	47
7-9 Paging from Memory .....	35	9-13 Setting Time-Out Timer ( T.O.T ) .....	48
7-10 Setting Page Squelch .....	36	9-14 Battery Voltage Reading .....	48
7-11 Setting Page Delay .....	36	9-15 1750Hz Tone Burst .....	48
		<b>10 Specifications</b> .....	50

# PREPARATION

## 1 Preparation

### Precautions:

1. To prevent permanent power loss, do not charge the battery pack in an area where the temperature is below about 5°C (40°F).
2. If you install an outdoor antenna, please follow all cautions and warnings that come with the antenna.
3. Do not transmit with high output power for too long periods. The transceiver may be overheated.
4. The supply voltage must be between 5.5V and 16.0V to avoid damaging the transceiver.
5. Never charge the battery pack with a charger other than the one supplied to avoid permanently damaging the battery pack.
6. Rechargeable NiCd battery can be a hazard to the environment. It must be recycled or disposed of safely at the end of the battery's useful life.
7. Do not place the transceiver near the heating appliances or expose it to long periods of direct sunlight.
8. Do not place the transceiver in excessively humid or dusty areas.
9. Do not disassemble the transceiver and modify it. Changes or modifications to this equipment not

expressly approved by ADI could void the user's authorization to operate this equipment.

This equipment complies with part 15 of the FCC rules. Operation is subject to the following two conditions: (1) This equipment may not cause harmful interference, and (2) this equipment must accept any interference received, including interference that may cause undesired operation.

## 1-1 Features

The TS-220DX has the following great features:

- **Dual Band Operation**—Capable of simultaneous transmit and receive on both 2-meter VHF and 70-cm UHF bands and receives in the ranges 130.0-172.0MHz, 350.0- 399.995MHz, 400.0-470.0MHz, and 900.0-985.0MHz.
- **Low battery alert** —To alert the TS-220DXS' user to recharge the battery pack when battery icon appears on the display. If the user continues to use the battery after some time, the TS-220DX will automatically shut down 80 seconds after flashing "Battery Low" appears.
- **Large backlit dot matrix LCD with illuminated keypad** —All operating information for both VHF and UHF bands are clearly displayed, and allows you to turn on the lamp so you can see the display and use the keypad anywhere.
- **120/200 non-volatile memory channels**—Built-in memory allows you to store up to 60/100 channels with frequency in both VHF and UHF bands. When you select "Memory SET 120" in the Set Menu mode, memories can be tagged with a 6-character ID name, which can be displayed instead of the frequency.
- **Under the circumstances, memory capacity is reduced to 110 with 55 memories per band.**
- **Switchable FM and AM reception**— Allows you to switch between FM and AM reception on the VHF band so you can clearly hear both amateur and aircraft transmissions.
- **Power on message display**— Allows you to set a 6-character power on message that appears each time you turn on your TS-220DX.
- **New Set Menu design**— Allows you to access a menu system with full alphanumeric display of functions and settings. You can browse through a summary of current operational status.
- **Clone function**— Both wireless cloning and wire cloning allows you to copy all settings and memory contents from one TS-220DX to the other TS-220DXS'
- **DTMF message paging and decoding**— Allows you to store up to 10-memory, 15-digit DTMF autodialer for autopatch operation and decode DTMF sequences up to 15 digits.

## 1-2 Accessories

Name	Part Number	Quantity
Antenna	MX133A003	1
Belt Clip	MX188A002	1
Hand String	NX002A010	1
NiCd Battery Pack	BA072R167	1
Battery Charger		
General	KM043X128L	1
U.S.A./Canada	KM043X128L	1
Europe(except U. K.)	KM099X006L	1
U. K.	KM099X019L	1
User's Manual	NX168A008	1

## 1-3 Getting Acquainted

### (1) Power Switch

Press and hold this key for longer than 0.8 seconds will turn the unit on or off.

### (2) VHF Band Volume Control Knob

Turning the control clockwise will increase the volume level for VHF band.

### (3) VHF Band Squelch Control Knob

The squelch control is fully counterclockwise by factory default. Rotating this control clockwise and stop immediately when the noise disappears. If the squelch control knob is rotated fully clockwise, the receiving sensitivity will degrade and weak signal will be blocked.

### (4) UHF Band Volume Control Knob

As per (2).

### (5) UHF Band Squelch Control Knob

As per (3).

### (6) Selector Control Knob

This control knob has different functions depending on the mode and programmed personality of the unit. For example, in VFO state, it is used to tune the frequency. In memory mode, it can be used to select the memory channel. Further details on this

# PHYSICAL LAYOUT

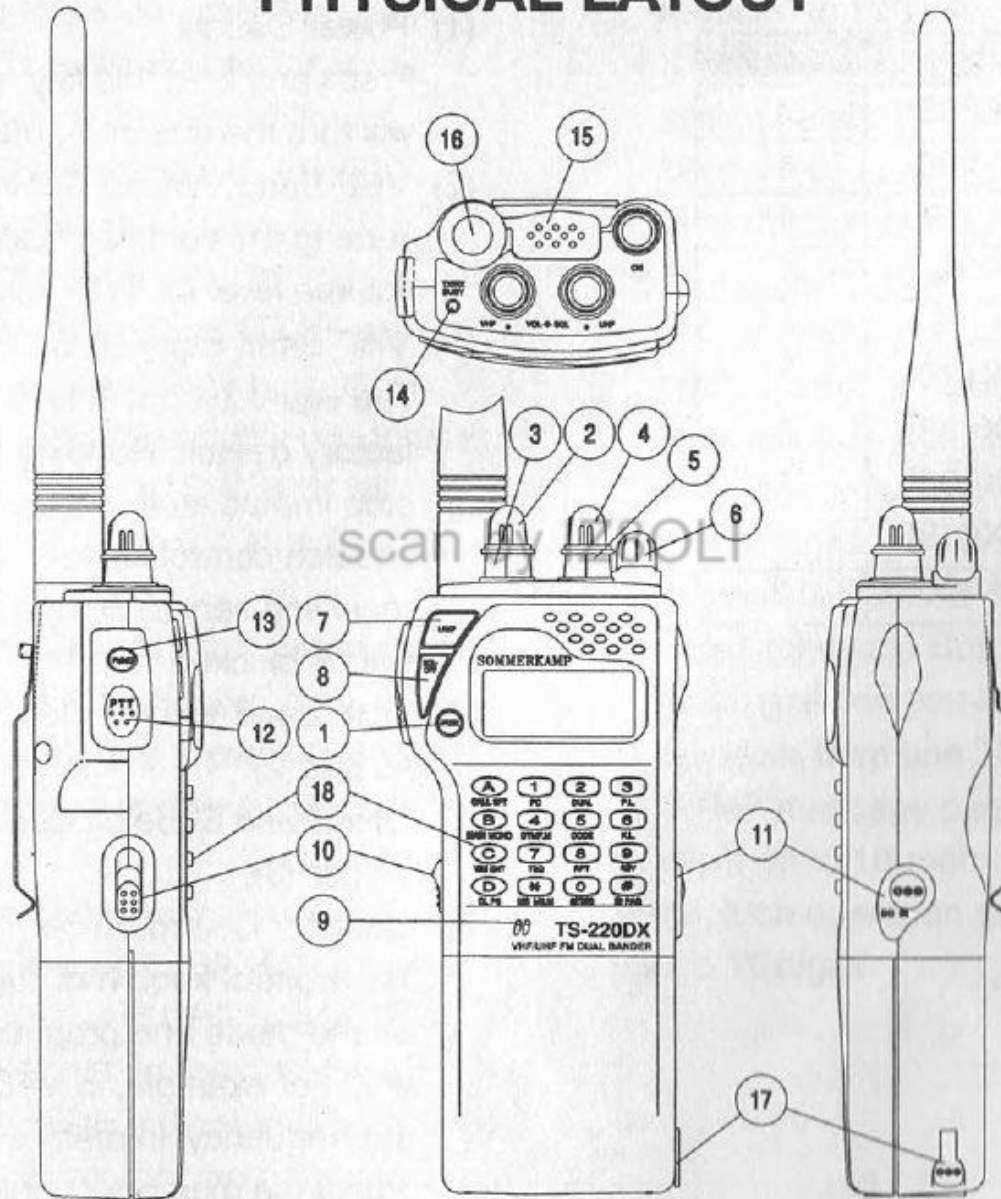



control are given in the relevant sections of this manual.

(7) Lamp

Press the [LAMP] key will turn on the display lamp for 5 seconds. During 5 seconds, press [LAMP] again will switch the display lamp off. Used in conjunction with the [FUNC] key to turn the display lamp on/off steadily.

(8) SQL OFF

Press the [SQL OFF] key will turn off the squelch and the hissing noise will be heard if no signal comes in air.

(9) Microphone

(10) Battery Release

To remove the battery pack, push this clip up towards the top of the unit and then slide the battery pack towards the left of the unit.

To replace the battery pack, slide the battery pack along the battery rail until a click is heard.

(11) External DC Jack

A DC power cord with appropriate polarity and voltage rating (<16V) can be used to operate your unit.

(12) Push To Talk( PTT )

To transmit, press this switch while holding the TS-220DX about 5cm to 7cm from your mouth with the microphone facing you. Speak in a clear voice at normal speech level. The LED(14), should glow red while transmitting.

(13) Function Switch( FUNC )

Used in conjunction with 1, 6, 7, 9 above.

(14) LED

Light red during transmission and light green during reception. Off when no signal comes in air.

(15) External Speaker/Microphone Jack

Provide the TS-220DXS' user with using an external speaker and microphone. If an external speaker is used, the audio from the VHF band and the UHF band can be split between the internal and external speaker.

(16) Antenna Port( BNC type )

The antenna supplied with your TS-220DX is properly tuned to the UHF/VHF amateur band frequencies and is attached to the TS-220DX via a BN connector. The TS-220DX should never be operated without the correct antenna fitted.

(17) Battery Charge Input Jack.

(18). Alphanumeric Keypad

The 16-key alphanumeric keypad is used for various functions, depending on the mode of operation.

The details is as follows:

[KEY]	Press [KEY] to:	Press [KEY] during DTMF memory store to:	Press [FUNC] + [KEY] to:	Press [PTT] + [KEY] to:
[ A CALL SFT ]	Recall the Call frequency	Enter DTMF "A"	Enter text ID or power on message	Transmit DTMF "A"
[ B MAIN MONO ]	Select the main band	Enter DTMF "B"	Turn off the sub-band	Transmit DTMF "B"
[ C V/M ENT ]	Toggle VFO and memory modes	Enter DTMF "C"	Enter a setting	Transmit DTMF "C"
[ D CL PS ]	Clear an entry	Enter DTMF "D"	Start scanning	Transmit DTMF "D"
[ 1 PO ]	Enter a digit in a frequency	Enter DTMF "1"	Change the power of transmission	Transmit DTMF "1"
[ 2 DUAL ]	Enter a digit in a frequency	Enter DTMF "2"	Start the dual watch	Transmit DTMF "2"
[ 3 P.L. ]	Enter a digit in a frequency	Enter DTMF "3"	Lock the [ PTT ] function	Transmit DTMF "3"
[ 4 DTMF M ]	Enter a digit in a frequency	Enter DTMF "4"	Access the DTMF memory	Transmit DTMF "4"
[ 5 CODE ]	Enter a digit in a frequency	Enter DTMF "5"	Access the paging code memory	Transmit DTMF "5"
[ 6 K.L. ]	Enter a digit in a frequency	Enter DTMF "6"	Lock the keypad	Transmit DTMF "6"

[ 7 TSQ ]	Enter a digit in a frequency	Enter DTMF "7"	Set the tone squelch feature	Transmit DTMF "7"
[ 8 RPT ]	Enter a digit in a frequency	Enter DTMF "8"	Set the offset direction	Transmit DTMF "8"
[ 9 REV ]	Enter a digit in a frequency	Enter DTMF "9"	Reverse the offset	Transmit DTMF "9"
[ 0 SET/SB ]	Enter a digit in a frequency	Enter DTMF "0"	Enter the Set Menu mode. If scanning, change the scan resume option.	Transmit DTMF "0"
[ * MS MS.M ]	Start memory scan	Enter DTMF "*"	Toggle the specific memory scan for memories	Transmit DTMF "*"
[ # ID PAG ]	In memory mode, toggle the ID and the frequency	Enter DTMF "#"	Set the DTMF page mode or the DTMF code squelch mode	Transmit DTMF "#"

## 1-4 Manual Conventions

Each of the TS-220DX buttons has multiple functions depending upon which mode the TS-220DXS' is in or on what other buttons you are pressing. To make this manual easier to read and use, we refer to each button by the name appropriate to the function you are performing and use boldface character to highlight the function. For example, when button marked [C V/M ENT] is referred to as:

[C V/M ENT], when transmitting DTMF C.

[C V/M ENT], when switching between the VFO and memory modes.

[C V/M ENT], when completing an entry.

Many functions are accessed by holding down the FUNC key, then pressing another key simultaneously.

In this manual, this is indicated as [FUNC]+[KEY].

For example, to store a memory channel operation, you press [FUNC]+[C V/M ENT], ENT uses boldface character.

## Key entry conventions

Instruction	Description
Press {KEY}	Press and release {KEY}
Press {FUNC} + {KEY}	Hold down {FUNC} key, then press {KEY}
Press {FUNC}+{KEY}+{PWR}	Press and hold both {FUNC} key and {KEY} down, then switch on the power.
Turn CH	Rotate selector control.

## 1-5 Using the TS-220DXS' Set Menu

Many of the functions in the TS-220DX are configured or programmed by means of a set menu system. This system makes it possible to reduce the keys and controls without eliminating any important features. There are 29 different set menus or more which you can choose. To enter the set menu mode, just press [FUNC] + [0 SET/SB]. Once you enter the set menu mode, you can turn **CH** (Selector Control) to select one of the menus you'd like to change.

The configuration structure is designed in alphabetic order to help user quickly find the desired menu.

Each time you want to set the status of one menu, just press [FUNC] switch and then turn CH to choose different selections available. You can also press [# ID PAG] or [0 SET/SB] key to set the status of one menu in the set menu mode.

To stored the selected value and exit the set menu mode, press [FUNC] + [0 SET/SB] again or just press [D CL PS] key.

## SET MENU ITEMS LIST:

AM Mode On/(Off)	Set the AM reception mode.
APO On/(Off)	Set auto power off.
ATT On/(Off)	With or without reception attenuation.
AUTO AM On/(Off)	Auto AM function
AUTO RPT Sft On/(Off)	Automatically set shift frequency in VHF band and UHF band
AUTO PWR ON On/(Off)	Automatically turn on TS-220DX.
BEEP On/(Off)	Set the entry beep sound on/off.
Clone (Off)	DTMF clone mode.
CTCSS (110.9)	Change the tone frequency. 38 CTCSS tones can be selected.
Decode DTMF (Off)	Decode DTMF tones up to 15 digits.
DTMF TX Spd (nor)	Change the sending time interval of the DTMF code.
Dul WtCh Spd (nor)	Change the dual watch speed.
Duplex On/(Off)	Full duplex mode.
Function Stp (0.1)	Change the frequency in 0.1, 1, 10 MHz step while holding down [FUNC] switch.
1K Digit (On)/Off	Entry of 1 KHz digit while using key pad to enter VFO frequency.

Memory SET (120)	Switch 120-set and 200-set of memory
MEM Prot On/(Off)	Set the memory protect flag
Offset (0.600)	Change the offset frequency.
PAGE-DLY (450)	Set the paging mode delay time. 450 or 750 ms can be selected.
PageRing (5)	Change the number of rings in paging. 5, 1, or off can be selected.
PAGE SQL On/(Off)	Wait in the paging mode without voice.
PwrOnMsg	Let the user program his own Power On Message.
RPT-DLY On/(Off)	Set the delay time for cross-band repeater transmission.
SAVE (Off)	Change the battery save time from off, 0.5, 1.0, ..... 10 seconds.
Selector Lock On/(Off)	Set the selector for use in the key lock mode.
Speaker Mode (11)	Select external/internal speaker.
Step (5.0)	Change the frequency step.
TOT (Off)	Set the time-out-timer.
Voltage XX.X	Let the user read the current voltage of battery pack.
XBd-RPTR (Off)	Set the cross-band repeater mode. Both bands must be displayed to access this item.

( ) stands for factory default.

### 1-6 A Quick Look at the Display

The dot matrix LCD with backlit provides the TS-220DXS' user with the following indications:

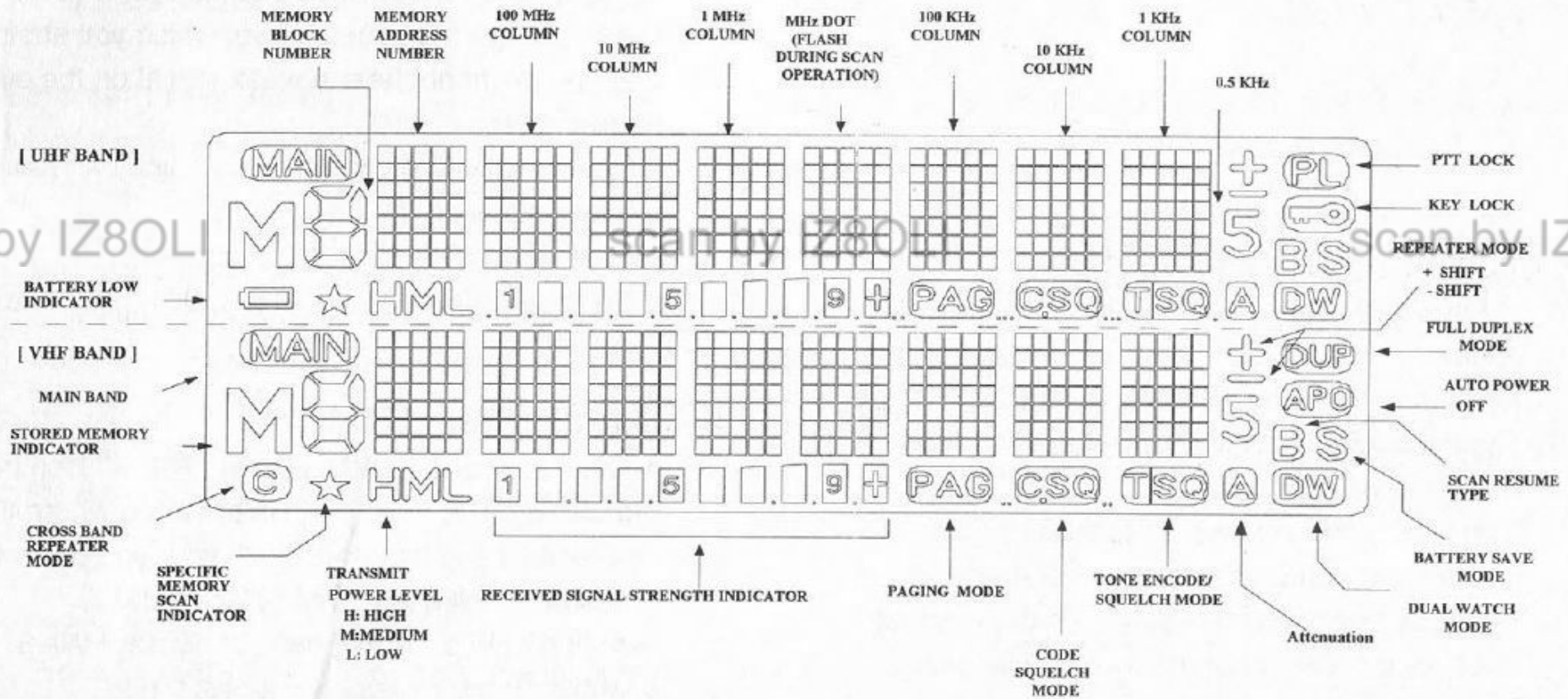

# BASIC OPERATION

## 2 Basic Operations

### 2-1 Turning Power On/Off

1. Press [PWR] for around 1 second to turn **ON** the TS-220DX.
2. Press [PWR] again for around 1 second to turn **OFF** the TS-220DX.

### 2-2 Adjusting Volume and Squelch

1. Volume and squelch are combined on one control for each band. The inner part is volume (VOL) and the outer part is squelch (SQL).
2. The left control is for VHF band and the right control is for UHF band.
3. Turn VOL control clockwise to increase the volume and counterclockwise to decrease it.
4. Turn SQL control clockwise to adjust the squelch level immediately when the noise disappears
5. The factory default setting for volume and squelch control is at its counterclockwise position.

### 2-3 Using SQL OFF

- In two situations you might use the [SQL OFF] key: (1) If you are using paging, code squelch, or tone squelch, you might not hear a transmission on the current frequency even if the squelch control is set at its counterclockwise position. (2) If you'd not like to change the squelch level which you set in 2-2, you might not hear a weak signal on the current frequency.

To temporarily turn off squelch, so you can hear all transmissions on the frequency.

1. Press [SQL OFF] to turn off squelch.
2. Release [SQL OFF], the TS-220DX returns to normal squelch.

### 2-4 Selecting Main Band

- The main band is indicated by "MAIN" icon on the display. The main band is the band where you can receive and transmit. Each time you press the [B MAIN MONO] key, "MAIN" icon shifts between VHF and UHF band in display. When changing frequencies, memories, tones,.....etc, remember "MAIN" should first be set to related band.



1. Press [B MAIN MONO] to select the main band.
2. Press [B MAIN MONO] again to confirm that the main band has been switched.

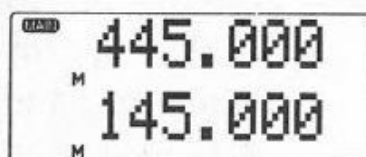
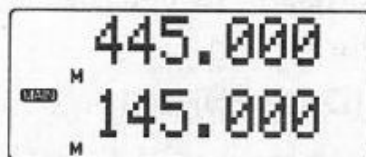

## 2-5 Selecting Frequency

### ■ Using channel selector

1. Press [B MAIN MONO] to select the main band.
2. Press [C V/M ENT] to select VFO mode.
3. Turn the channel selector to select a frequency. Clockwise rotation increases the frequency one frequency step at a time. Counterclockwise rotation decreases the frequency one frequency step at a time.
4. By factory default, the frequency step is 10KHz in VHF band and UHF band.

### ■ Using keypad

1. Press [B MAIN MONO] to select the main band.
2. Press [C V/M ENT] to select VFO mode.
3. Enter the desired frequency using the numeric

keys starting from 100MHz digit to 1KHz digit.

NOTE: Each time you press the [C V/M ENT] key, the TS-220DX shifts between VFO and memory mode.

## 2-6 Transmitting

● Before transmitting, momentarily press [SQL OFF] to listen for activity on your channel. Don't interrupt another user.

1. Press [B MAIN MONO] to select the main band.
2. Press the [C V/M ENT] to select VFO mode.
3. Select the frequency as 2-5.
4. Press [PTT] on the left top side of the radio and speak slowly and clearly into the grille area with the microphone grille about 5cm to 7cm from your mouth.
5. The TX/RX BUSY LED lights red when [PTT] is pressed and remains on during the transmission.
6. Release [PTT] to receive when finished transmitting.

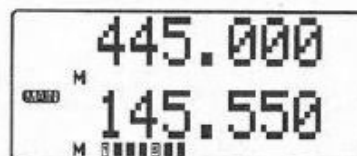

## 2-7 Inhibiting Transmissions

1. Press F+ [3 P.L.]. The PL icon is displayed.
2. Confirm the transmission is inhibited when [PTT] is pressed.
3. Repeat step 1 to exit the power lock function.

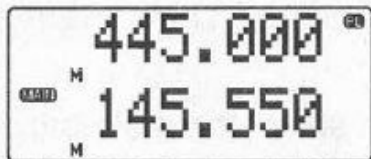

## 2-8 Selecting Output Power

1. Press [B MAIN MONO] to select the main band.
2. Press [FUNC]+[1 PO]. Each time these keys are pressed, the transmit output power changes as M → L → H. The factory default is medium power(M).

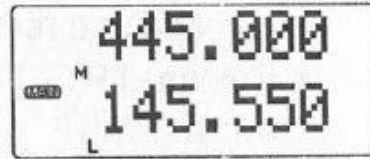
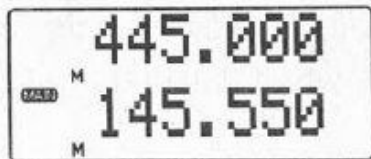

## 2-9 Changing Frequency Step

- The factory default is 10KHz for both VHF band and UHF band.
1. Press [FUNC]+[0 SET/SB] to enter the Set Menu mode.

2. Turn **CH** to the menu " Step 10.0 ".
3. Hold down [FUNC] and turn **CH** to change the frequency step. Eight frequency steps can be selected. You can also press [# ID PAG] or [0 SET/SB] to change the setting.
4. Repeat step 1 or press [D CL PS] to exit the Set Menu mode.

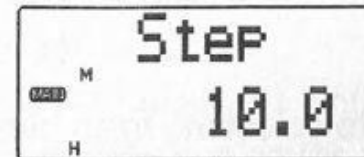

## 2-10 Changing Frequency Step in 100KHz, 1MHz or 10MHz

- Changing frequency in 100KHz step,
1. Hold down [FUNC] and turn **CH**.
- Changing frequency in 1 MHz or 10 MHz,
1. Press [FUNC]+[0 SET/SB] to enter the Set Menu mode.
  2. Turn **CH** to the menu " Function Stp 0.1 ".
  3. Hold down [FUNC] and turn **CH** to change the menu to " Function Stp 1.0 " or " Function Stp 10.0 ". You can also press [# ID PAG] or [0 SET/SB] to change the setting.

- Repeat step 1 or press [D CL PS] to exit the Set Menu mode.
- To change the frequency in 1MHz or 10MHz step, hold down [FUNC] and turn **CH**.



## 2-11 Using Key Lock

- Sometimes you may want to lock the TS-220DXS' keypad so you do not accidentally change settings.

- Press [FUNC]+[6 K.L.].
- The key icon is shown on the right top of the display.
- Repeat step 1 to exit the key lock function.

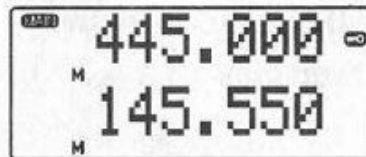

## 2-12 Using Selector Lock and Key Lock

- Sometimes you may want to lock the TS-220DXS' channel selector control and keypad simultaneously, perform the following operation procedures.

- Press [FUNC]+[0 SET/SB] to enter the Set Menu mode.
- Turn **CH** to select the menu "Selector Lock Off".
- Hold down [FUNC] and turn **CH** to change the menu "Selector Lock On". You can also press [# ID PAG] or [0 SET/SB] to change the setting.
- Repeat step 1 or press [D CL PS] to exit the Set Menu mode.
- Press [FUNC]+[6 K.L.].
- Perform the reverse order to unlock the channel selector and keypad.

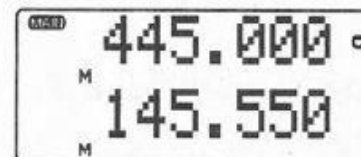
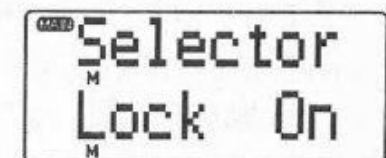
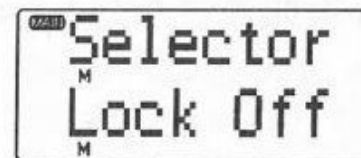

## 2-13 Single Band Operation

- Normally, the TS-220DX monitors both UHF band and VHF band at the same time. To turn off the sub-band,

so the TS-220DX only monitors the main band.

1. Press [B MAIN MONO] to select the main band.
2. Press [FUNC]+[B MAIN MONO].
3. The sub-band is turned off and the display only shows the main band
4. Press [B MAIN MONO] to return the dual band mode.

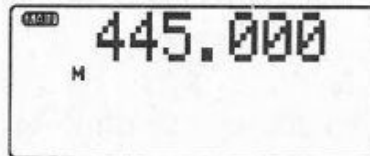

2. Press [PWR]+[3 P.L.].
3. Release [PWR] and press [3 P.L.] only, the whole display keeps on.
4. Release [3 P.L.] and return to the normal operation mode.

NOTE: This is for test purpose only.

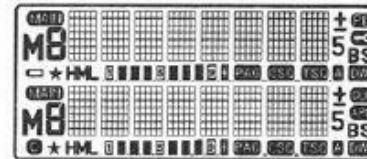

## 2-14 Using Display Light

● You can turn on the display lamp for 5 seconds or turn it on so it stays on .

1. Press [LAMP] to turn on the display lamp for 5 seconds.
2. Press [FUNC]+[LAMP] to turn on the display lamp so it stays on.
3. Press [FUNC]+[LAMP] again to turn off the display lamp.

## 2-15 Testing Display Window

1. Press [PWR] for around 1 second to turn off the TS-220DX.

## 2-16 Resetting the TS-220DX

● If the TS-220DX seems to be malfunctioning, follow these steps to reset it.

1. Press [PWR] for around 1 second to turn off TS-220DX.
2. Press [FUNC]+[D CL PS]+[PWR] to turn on TS-220DX. The TS-220DX displays "RESET? Press C" .
3. Press C to confirm the reset or press any other key to cancel.

CAUTION! This erases all data in memories.

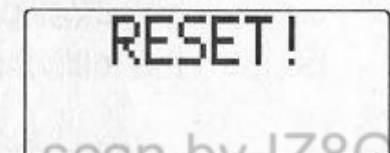
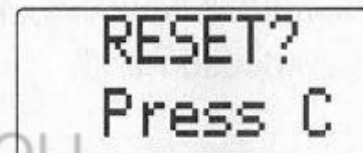

## 3 Memory Function

Besides two Calling channels, the TS-220DX allow you to store up to 120/200 sets of frequency into memory, with 60/100 memory channels in each VHF and UHF band. When you select "Memory SET 120" in the Set Menu mode, memories can be tagged with a 6-character ID name, which can be displayed instead of frequency. Under the circumstances, the memory capacity is reduced to 110 with 55 memories (M00-M54) in each band. In addition to store frequency and ID name, each memory can hold repeater mode, offset frequency, paging mode or code squelch mode, and tone encode mode or tone squelch mode.

### 3-1 Storing Frequencies into Memory

1. Press [B MAIN MONO] to select the main band.
2. Press [C V/M ENT] to select the VFO mode.
3. Set the frequency you want to store and set all other options to your desired settings.
3. Press [FUNC]+[C V/M ENT]. Two dashes should appear to the left of the frequency.
4. Use the keypad to enter a two-digit number (from 00 to 55).

5. Confirm "M" and the memory number appear for one second and returns to the VFO.

Note: If you enter an invalid memory number, the TS-220DX sounds a "Bu" tone and memory store is canceled. Repeat steps 3- 4. If you'd like to store frequency only, you can store 60 memories.

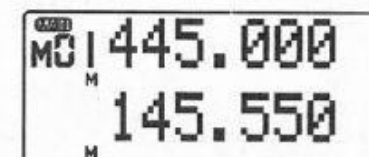
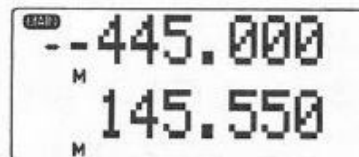

### 3-2 Recalling Memory

- You can use the selector control or the keypad to recall stored memory. If you select a memory which has information stored in it, "M" appears to the left of the memory number and the TS-220DX recalls all stored settings. If you select a memory which has no information stored in it, "M" doesn't appear.
1. Press [B MAIN MONO] to select the main band.
  2. Press [C V/M ENT] to select the memory mode.
  3. Turn **CH** to select a memory address or use the keypad to enter a two-digit memory number.
  4. Turn **CH** while holding down the [FUNC] key will change memories 10 at a time.

5. Press [C V/M ENT] or [D CL PS] to return to the VFO mode.
6. Press [D CL PS] sets the current memory frequency to the VFO frequency.

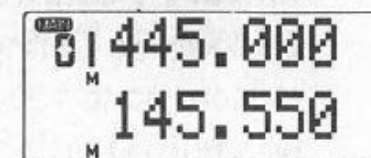
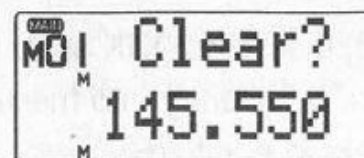
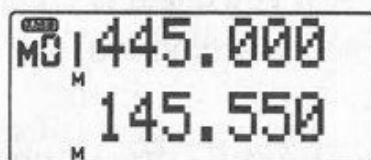

### 3-3 Clearing a Memory

- Stored memory can be erased.
1. Press [B MAIN MONO] to select the main band.
  2. Press [C V/M ENT] to select the memory mode.
  3. Select a memory to be erased. (See 3-2)
  4. Press [FUNC]+[C V/M ENT]. The TS-220DX displays the memory number and "Clear?". (If a protected memory channel is selected, the TS-220DX sounds a warning tone and "MEM Prot" appears for 1 second on the display.)
  5. Press [FUNC]+[C V/M ENT] again, M disappears and the TS-220DX sounds a long beep to signal that the frequency is erased.
  6. To erase another memory, repeat steps 3-5.
  7. Press [C V/M ENT] to return to the VFO mode.

- To clear all memory channels.
1. Press [PWR] key again for around 1 second to turn OFF the TS-220DX.
  2. Press [FUNC]+ [C V/M ENT]+[PWR] to turn on the TS-220DX.
  3. Confirm all 120 or 200 memories are erased.

### 3-4 Changing Stored Memories

- The memory frequency can be changed temporarily and stored when necessary.
1. Press [B MAIN MONO] to select the main band.
  2. Press [C V/M ENT] to select the memory mode.
  3. Select a memory to be changed.
  4. Press [FUNC]+[A CALL SFT], "M" mark should be flashing.
  5. Turn CH or use the keypad to select a frequency.
  6. Press [FUNC]+ [C V/M ENT] to store the new frequency, or press [D CL PS] to return to the previous state.

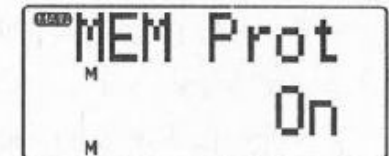
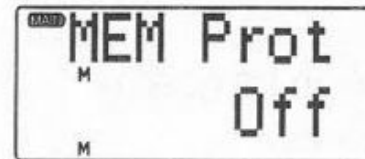
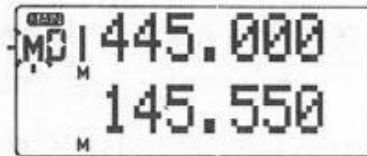
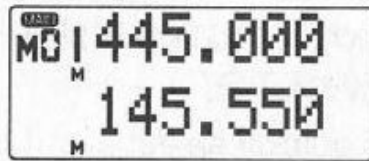

### 3-5 Protecting Memory

- This function protects the settings in a memory so you do not change or erase them unintentionally.
1. Press [B MAIN MONO] to select the main band.
  2. Press [C V/M ENT] to select the memory mode.
  3. Select a memory to be protected.
  4. Press [FUNC]+[0 SET/SB] to enter the Set Menu mode.
  5. Turn **CH** to the menu "MEM Prot Off".
  6. Hold down [FUNC] and turn **CH** to change the menu to "MEM Prot On". You can also press [# ID PAG] or [0 SET/SB] to change the setting.
  7. Repeat step 4 or press [D CL PS] to exit the Set Menu mode.
  8. Try to erase this protected memory to confirm that the memory protection has been activated.

### 3-6 Storing/Changing Channel ID

- To help you remember each memory channel easily, the TS-220DX has the ability to store an identification name ( ID ) for each channel. This ID name can be a call sign, repeater name, city, person's name, etc. The ID name can be formed from the ASCII code table. You can store up to 55 memories(M00-M54) with ID name, each ID name can be 6-characters.
1. Press [B MAIN MONO] to select the main band.
  2. Press [C V/M ENT] to select the memory mode.
  3. Select a memory which you want to assign an ID name.
  4. Press [# ID PAG] to display the current ID. "No Name" should appear if no ID name is stored.
  5. Press [FUNC] + [A CALL SFT]. The ID's first character flashes.
- Note: If no ID name has been stored, the default ID name is "CH-0xx" where xx is the current memory number.

6. Turn **CH** to select the first character.
7. Hold down [FUNC] and turn **CH** to move the cursor. You can also press [0 SET/SB] or [# ID PAG] to move the cursor.
8. Repeat steps 6-7 until you have entered the desired ID name.
9. Press [FUNC] + [C V/M ENT] to store the ID name.
10. Press [FUNC] + [A CALL SFT] or press [D CL PS] to quit without saving the ID name.

### 3-7 Call Channel

- The default CALL frequency is 145.0MHz for VHF band and 435.0MHz for UHF band.
- This feature allows you to quickly select a commonly used frequency for instant access.
1. Press [B MAIN MONO] to select the main band.
  2. Press [A CALL SFT]. The TS-220DX displays C and the default call frequency.
  3. Press [A CALL SFT] or [C V/M ENT] or [D CL PS] to exit the call channel mode.
  4. Press [D CL PS] will set the calling frequency to the VFO frequency.

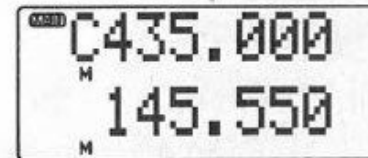
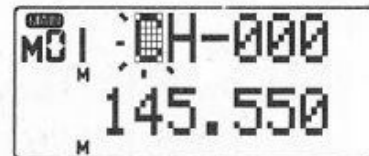
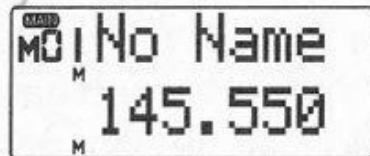

ASCII code table:

	!	"	#	\$	%	&	'	(	)	*	+	,	-	.	/
0	1	2	3	4	5	6	7	8	9	:	;	<	=	>	?
@	A	B	C	D	E	F	G	H	I	J	K	L	M	N	O
P	Q	R	S	T	U	V	W	X	Y	Z	[	\	]	^	_
`	a	b	c	d	e	f	g	h	i	j	k	l	m	n	o
p	q	r	s	t	u	v	w	x	y	z	{		}	~	

### 3-8 Changing Call Frequency

1. Press [B MAIN MONO] to select the main band.
2. Press [C V/M ENT] to select the VFO mode.
3. Set a new CALL frequency. (See 2-4)
4. Press [FUNC] + [C V/M ENT]. The TS-220DX displays "--" to the left of the frequency.



5. Press [A CALL SFT] to store the new call frequency. "C" should appear for about one second and the TS-220DX return to the VFO mode.

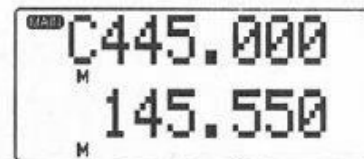
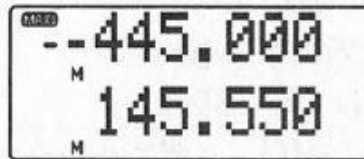

### 3-9 Changing CALL Frequency Temporarily

- CALL frequency can be changed temporarily.
1. Press [B MAIN MONO] to select the main band.
  2. Press [A CALL SFT] to access the CALL frequency.
  3. Press [FUNC]+ [A CALL SFT]. "C" blinks.
  4. Use keypad to enter a new CALL frequency.
  5. Press [FUNC] + [C V/M ENT] to store the new CALL frequency or press [A CALL SFT] to recall the original CALL frequency.

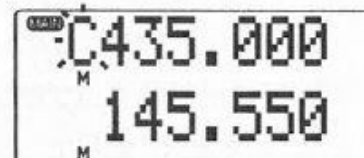
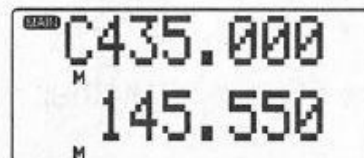

## 4 Scanning

- The TS-220DX's scan features allow you to monitor several frequencies or memories. The receiver checks each frequency or memory in a preprogrammed list for activity. If the TS-220DX detects a transmission, it stops scanning so that you can hear the transmission. The TS-220DX has seven different scanning modes that control which frequencies or memories the TS-220DX scans and three scan resume options that control how long the TS-220DX pauses on a busy channel. The direction of scan can be changed by turning CH clockwise or counterclockwise during scanning operation.

### 4-1 1MHz Scan

1. Press [B MAIN MONO] to select main band.
2. Press [C V/M ENT] to select the VFO mode and set the starting frequency.
3. To start scanning, press [FUNC]+ [D CL PS].
4. To stop scanning, press [D CL PS].

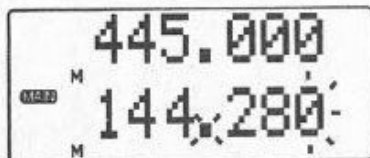

### 4-2 Band Scan

- Band scan function scans the entire band.
1. Press [B MAIN MONO] to select the main band.
  2. Press [A CALL SFT], the CALL frequency appears.
  3. To start scanning, press [FUNC]+[D CL PS].
  4. To stop scanning, press [D CL PS].

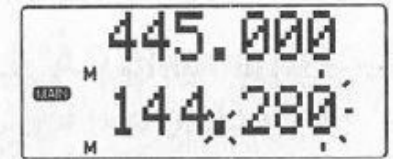
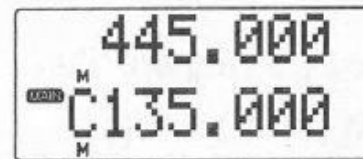

### 4-3 Program Scan

- Program scan function scans a specific range of frequencies ranged by two frequencies in memory.
1. Press [B MAIN MONO] to select the main band.
  2. Press [C V/M ENT] to select the VFO mode and set the starting frequency.
  3. Press [FUNC]+[C V/M ENT] to store the starting frequency in one memory. For example, M10.
  4. Set the stop frequency and store it in another memory. For example, M11.
  5. Press [C V/M ENT] to enter the memory mode, then use the keypad to recall the starting frequency. In the above example, key in 1,0.

6. Press [FUNC]+[D CL PS]. PS:10- appears.
7. Using the keypad to enter the memory that has the frequency you want to scan to. In the above example, key in 1,1.
8. To stop scanning, press [D CL PS].

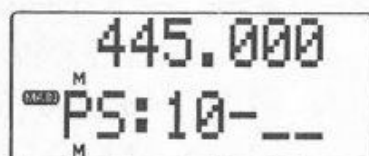
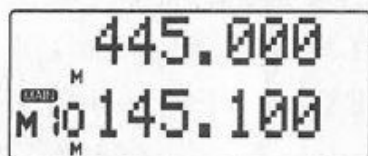

#### 4-4 Memory Scan

● Memory scan function scans all the memorized channels. The TS-220DX will skip empty memories. If all the memories are empty, the TS-220DX beeps and does not scan.

1. Press [B MAIN MONO] to select the main band.
2. To start the memory scan, press [\* MS MS.M].
3. To stop scanning, press [D CL PS].

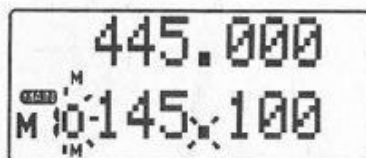

#### 4-5 Specific Memory Scan

● Specific memory scan function scans the specific memorized frequency.

1. Press [B MAIN MONO] to select the main band.
2. Press [C V/M ENT] to select the memory mode.
3. Using CH or keypad to select the desired memory.
4. Press [FUNC]+[\* MS MS.M], ★ should appear below the memory number.
5. Repeat steps 3-4 to make more memories with ★.
6. Press [C V/M ENT] to select the VFO mode.
7. Press [FUNC]+[\* MS MS.M], ★ should appear.
8. Press [\* MS MS.M]. The TS-220DX scans the memories with the ★ mark.
9. To stop scanning, press [D CL PS].
10. To cancel the specified memory with ★ mark, press [FUNC]+ [\* MS MS.M] in the memory mode

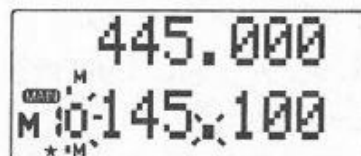
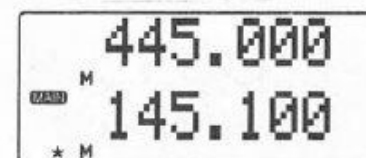
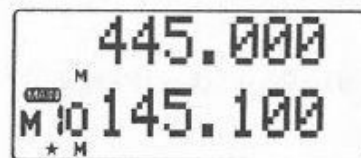

#### 4-6 Memory Block Scan

- Memory block scan function scans a group of memory channels. The TS-220DX has six memory blocks of 10 memories each. The block numbers and the scanning ranges are as follows:

Block Number	Memory Number
0	M00-M09
1	M10-M19
2	M20-M29
3	M30-M39
4	M40-M49
5	M50-M59

1. Press [B MAIN MONO] to select the main band.
2. To start the memory scan, press [\* MS MS.M].
3. Enter a block number from 0 to 5, the TS-220DX will limit the scan to the memory block you select.

4. To start the memory scan, press [\* MS MS.M].
5. Key in the block number to start the block memory scan.
6. To stop scanning, press [D CL PS] .

#### 4-7 Scan Specific Memory under Mmemory Block Scan

1. Press [B MAIN MONO] to select the main band.
2. Press [C V/M ENT] to select the VFO mode.
3. Press [FUNC] + [\* MS MS.M]. ★ should appear at the bottom of the memory number.

### 4-8 Tone Squelch Frequency Scan

- Scans through the CTCSS tones for the selected frequency to help you determine which sub-audible tone is being used. Only the busy scan is provided.
1. Press [B MAIN MONO] to select the main band.
  2. Press [FUNC]+[7 TSQ] until TSQ icon appears.
  3. Press [FUNC]+[0 SET/SB] to enter the Set Menu mode.
  4. Turn CH to select the menu "CTCSS".
  5. Press [FUNC]+[D CL PS] to start scanning tone squelch frequencies. TS-220DX stops scanning when it detects a CTCSS tone.
  6. To stop scanning, press [D CL PS].

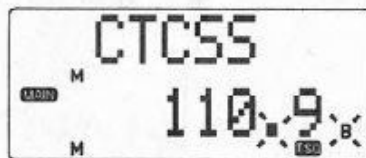
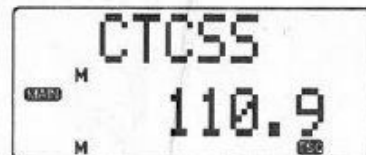
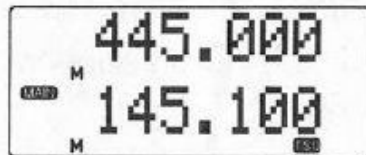

### 4-9 Selecting Scan Resume Type

- To change the scan resume type, start scanning, then press [FUNC] + [0 SET/SB] to switch between the scan resume type.

Scan Resume Type	Description	Indication
Pause	Scanning resumes after 5 seconds.	"B" is not in the display.
Busy	Scanning resumes 2 seconds after transmission ends.	"B" flashes to the right of the frequency.
Stop	Scanning does not automatically resume. Turn CH to resume.	"B" appears to the right of the frequency.

## 5 Dual Watch

- Dual Watch allows you to monitor two different frequencies within the same band. The TS-220DX checks the second frequency for activity every three seconds and stays on the frequency if there is activity. When a VFO signal is received during dual watch, the TS-220DX checks the memory channel every three seconds so the signal is heard intermittently. Rotating the SQL control fully counterclockwise or press [SQL OFF] pauses dual watch in order to listen to the memory channel.

The TS-220DX provides you with dual watch between a VFO frequency and any of the following secondary frequencies:

- (1) Memory M00, (2) Any memory Mxx, (3) The calling frequency. (4) Memory under scanning.

The dual watch timing diagram between a VFO frequency and a memory channel is as below,

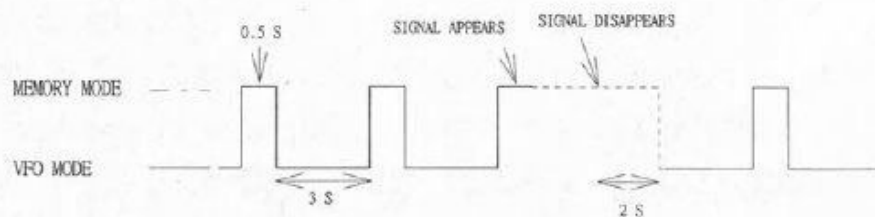

TIMING DIAGRAM FOR VFO DURING THE DUAL WATCH MODE.

### • Note:

- (1) You can only change the VFO frequency during dual watch. Squelch function is not recommended to use.
- (2) Tone Encode and Tone Squelch function can be used during dual watch.
- (3) You can only transmit on the VFO frequency during dual watch. Paging or code squelch operation is not recommended to use. If you want to transmit on the memory frequency, you must first press [D CL PS] to exit the dual watch operation.

### 5-1 Memory M00 Dual Watch

1. Press [B MAIN MONO] to select the main band.
2. Press [C V/M ENT] to select the VFO mode.
3. Press [FUNC] + [2 DUAL]. "DW" icon appears to the lower right of the frequency.
4. Confirm that M00 is checked every three seconds.
5. Press [D CL PS] to exit the M00 dual watch operation.

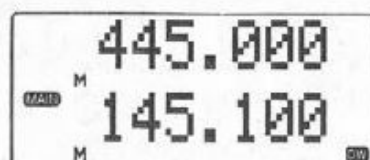
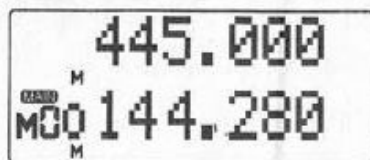

### 5-2 Any Memory Mxx Dual Watch

1. Press [B MAIN MONO] to select the main band.
2. Press [C V/M ENT] to select the memory mode.
3. Select the memory address by turning **CH** or using the keypad.
4. Press [FUNC] + [2 DUAL]. "DW" icon appears to the lower right of the frequency.
5. Confirm that Mxx is checked every three seconds.
6. Press [D CL PS] key to exit the Mxx dual watch operation.

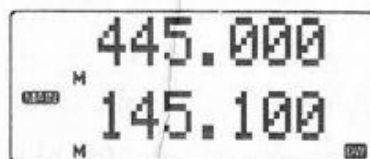
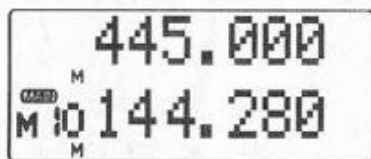

### 5-3 Call Channel Dual Watch

1. Press [B MAIN MONO] to select the main band.
2. Press [A CALL SFT] to recall the call channel.

3. Press [FUNC] + [2 DUAL]. "DW" icon appears to the lower right of the frequency.
4. Confirm that the call channel is checked every three seconds.
5. Press [D CL PS] to exit the Call channel dual watch operation

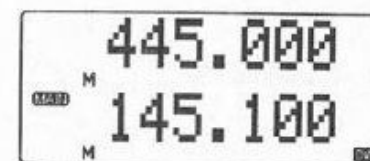
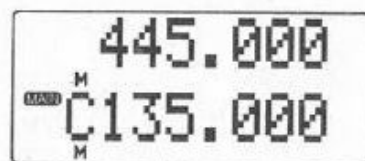

### 5-4 Memory Sequence Dual Watch

1. Press [B MAIN MONO] to select the main band.
2. Press [\* MS MS.M] to start scanning all programmed memories.
3. Press [FUNC] + [2 DUAL]. "DW" icon appears to the lower right of the frequency.
4. Confirm that the next programmed memory is checked every three seconds.  
For example, if memories 1, 5, 11, 15, and 21 are programmed, the TS-220DX stays on the VFO for 3 seconds, then checks M01. It then stays on the VFO for 3 seconds, then checks M05. It continues to sequence through programmed

memories until you exit the dual watch operation.

5. Press [D CL PS] to exit the memory sequence dual watch operation.

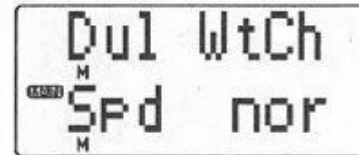
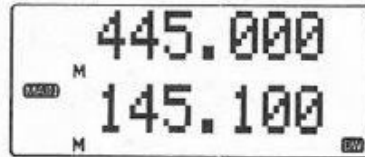
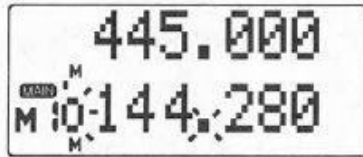

### 5-5 Changing Dual Watch Speed

- Normally, the TS-220DX stays on the VFO frequency for 3 seconds and then checks the memory channel for 0.5 second during dual watch operation. You can set the TS-220DX to monitor each frequency for 0.6 second.

1. Press [FUNC]+[0 SET/SB] to enter the Set Menu mode.
2. Turn **CH** to select the menu "Dul Wtch Spd nor".
3. Hold down [FUNC] and turn **CH** to change "Dul Wtch Spd nor" to "Dul Wtch Spd fst".  
You can also press [# ID PAG] or [0 SET/SB] to change the setting.
4. Repeat step 1 or press [D CL PS] to exit the Set Menu mode.



# OPERATING THROUGH REPEATERS

## 6 Operating Through Repeaters

The repeaters for all Amateur Radio use a different receive and transmit frequency. The difference frequency between the receive and transmit is called its offset. The receive frequency may be higher or lower than the transmit frequency but the difference is a fixed split.

To use a repeater, the TS-220DX must be set to duplex operation—You transmit on one frequency which is the same as the repeater's receive frequency and receive on another frequency which is the same as the repeater's transmit frequency. If the receive frequency is higher than the transmit frequency, the repeater has a positive offset. If the receive frequency is lower than the transmit frequency, the repeater has a negative offset.

The TS-220DX dual bander provide an "Auto Repeater Shift " function which sets the required transmit offset automatically when you select a frequency in the VFO mode on the 144MHz band. Auto Repeater Shift is programmed according to the American Radio Relay Leagues(ARRL) Band Plan for repeater offset direction. For the users outside the

USA, you can turn off the "Auto Repeater Shift " and set your specific applications.

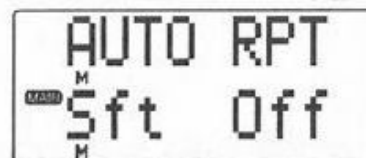

Receive Frequency	Transmit Offset
144.000 to 145.095 MHz	No offset(Simplex)
144.100 to 145.495 MHz	- offset
145.500 to 145.995 MHz	No offset(Simplex)
146.000 to 146.395 MHz	+ offset
146.400 to 146.595 MHz	No offset(Simplex)
146.600 to 146.995 MHz	-offset
147.000 to 147.395 MHz	+ offset
147.400 to 147.595 MHz	No offset(Simplex)
147.600 to 147.995 MHz	-offset

### 6-1 Setting Offset Direction

- + : to the right of the frequency indicates a positive offset. The transmit frequency is higher than the receive frequency by a fixed amount.
- : to the right of the frequency indicates a negative

offset. The transmit frequency is lower than the receive frequency by a fixed amount.

Neither + nor - appears to the right of the frequency indicates simplex operation.

1. Press [B MAIN MONO] to select the main band.
2. Press [FUNC] + [8 RPT] to select the offset direction.

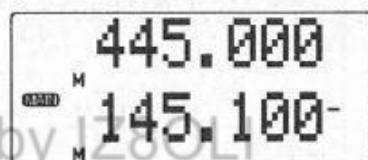

## 6-2 Changing Offset Frequency

● The default offset frequency is 0.6MHz for VHF band and 5MHz for UHF band.

1. Press [FUNC] + [0 SET/SB] to enter the Set Menu mode.
2. Turn **CH** to select the menu "Offset 0.600 " (VHF band) or "Offset 5.000 " (UHF band).
3. Hold down [FUNC] and turn **CH** to select new offset frequency. You can also press [# ID PAG] or [0 SET/SB] to change the setting.
4. Repeat step 1 or press [D CL PS] to exit the Set Menu mode.

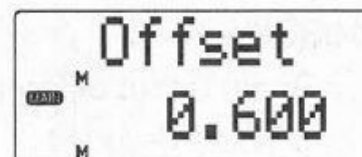

## 6-3 Reversing Transmission and Reception Frequency

Reversing must be set under the repeater mode. This allows you to quickly check the repeater receive frequency to see if you can hear a station directly. (not through the repeater)

1. Press [FUNC] + [9 REV]. The offset direction of the repeater is reversed. (What was the transmit is now the receive and vice versa) The offset direction + and - flashes.

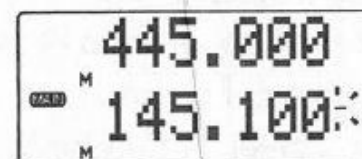

## 6-4 Cross-Band Repeater Operations

- This feature allows you to set the TS-220DX to automatically retransmit on one band a signal it

receives on the other band. This function cannot be used under single band operation.

1. Press [FUNC] + [0 SET/SB] to enter the Set Menu mode.
2. Turn **CH** to select the menu "XBd-RPTR Off".
3. Hold down [FUNC] and turn **CH** to turn on the cross-band repeater function. C icon appears on the lower left side of the display. You can also press [# ID PAG] or [0 SET/SB] to change the setting.
4. Repeat step 1 twice to exit the cross band repeater mode.

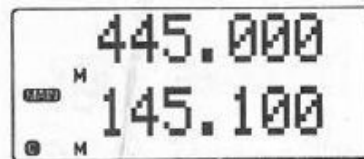
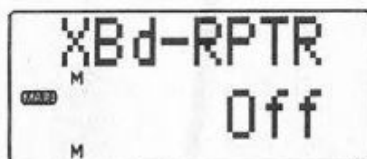

Note:

- (1) If there is a continuous transmission, disconnect the antenna and turn the squelch control clockwise until the transmission stops.
- (2) Always monitor your TS-220DX and the 2m/70cm frequencies you select for crossband repeating.

Continuous transmissions from the TS-220DX may cause unrealized interference to other stations and/or overheating of the TS-220DX. Use the time-out-timer (See 9-13) to limit transmit time. Be careful to avoid using the third harmonic frequencies for cross-band repeating, as the TS-220DX can be deafened by its own signal and lock on transmit. (For example, 145.35MHz and 436.05MHz) If that accidentally happens, turn off the TS-220DX, then hold down [B MAIN MONO] and switch the TS-220DX back on.

## 6-5 Setting 2-Second Cross-Band Repeater Delay

● When this function is activated, the TS-220DX continues to transmit for 2 seconds after the input signal disappears.

1. Press [FUNC] + [0 SET/SB] to enter the Set Menu mode.
2. Turn **CH** to select the menu "RPT-DLY Off".
3. Hold down [FUNC] and turn **CH** to change "RPT-DLY Off" to "RPT-DLY On".  
You can also press [# ID PAG] or [0 SET/SB] to change the setting.
4. Repeat step 1 or press [D CL PS] to exit the Set Menu mode.

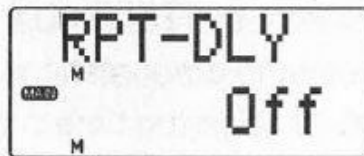

## 7 DTMF Features

DTMF stands for "Dual-Tone Multi-Frequency" and is the common acronym for the touch tones used by telephone. Besides the common tones for 0-9, \* and #, the TS-220DX can generate the tones for DTMF A, B, C, D.

### 7-1 Manually Transmitting DTMF Codes

1. Press and hold down [PTT], TX/RX BUSY indicator should light red.
2. Press 0-9, \*, #, A, B, C, D, you can transmit all 16 different DTMF codes.

Note: To transmit DTMF D, you must press D twice.

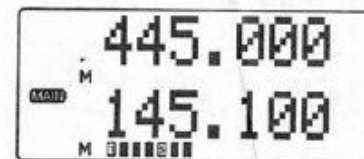

### 7-2 Storing DTMF Sequences

- You can use the DTMF memories to store DTMF sequences in your TS-220DX. This allows you to quickly transmit sequences you use to page other partners, use autopatches, or access repeater

features. The TS-220DX provides 10 DTMF memories (0-9), each memory holds up to 15 digits.

1. Press [FUNC] + [4 **DTMF.M**], "X\_\_\_\_\_" appears on the display. "X" is the DTMF memory number.
2. Turn **CH** to select the memory address number which you want to save a sequence in.
3. Press [FUNC] + [A CALL **SFT**]. The first dash mark flashes.
4. Use the keypad to enter the DTMF sequence you want to store (up to 15 digits).
5. The DTMF sequence is stored automatically when the 15th digit is entered. To store fewer than 15 digits, press [FUNC] + [C V/M **ENT**].
6. To correct the entry, turn **CH** to move the cursor left or right to the digit you want to change, then enter the new digit.
7. Press [FUNC] + [4 **DTMF.M**] again or press [D **CL PS**] to return to the previous mode.

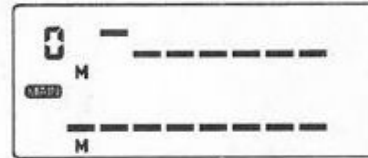
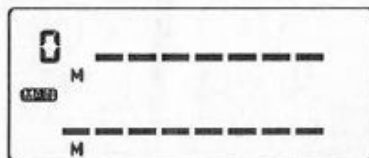

### 7-3 Clearing DTMF Memory

1. Press [FUNC] + [4 **DTMF.M**].
2. Turn **CH** to select the memory location you want to erase.
3. Press [FUNC] + [C V/M **ENT**]. "Clear?" should appear on the display.
5. Press [FUNC] + [C V/M **ENT**] again, the memory is erased.
6. Press [FUNC] + [4 **DTMF.M**] again or press [D **CL PS**] to return to the previous mode.

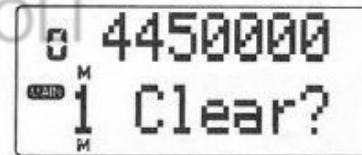

### 7-4 Transmit DTMF Sequence from Memory

1. Press and hold down the [PTT], then press [D **CL PS**]. "D" should appear on the frequency's first digit of the frequency.
2. Continue to hold down the [PTT], and enter the desired DTMF memory number. The TS-220DX transmits the DTMF sequence.

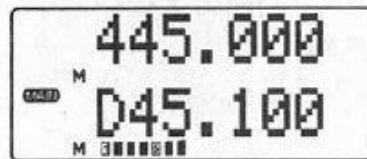

### 7-5 Changing DTMF Transmitting Speed

● Normally, the DTMF sequences is sent with a 50ms pause between digits. To change the speed, you can use the menu to set "DTMF Tx Spd" with a 100ms pause between digits.

1. Press [FUNC] + [0 SET/SB] to enter the Set Menu mode.
2. Turn **CH** to select the menu "DTMF TX Sp nor".
3. Hold down [FUNC] and turn **CH** to change "DTMF TX Spd nor" to "DTMF TX Spd lo". You can also press [# ID PAG] or [0 SET/SB] to change the setting.
4. Repeat step 1 or press [D CL PS] to exit the Set Menu mode.

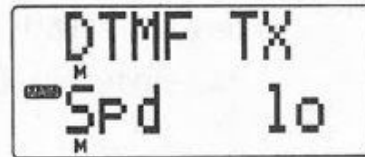
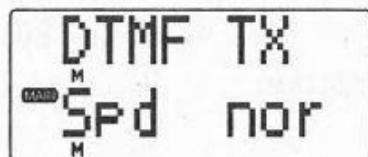

### 7-6 Using DTMF Decode Function

- You can use the DTMF decode function to decode a string of DTMF tones up to 15 digits.
1. Press [FUNC] + [0 SET/SB] to enter the Set Menu mode.
  2. Turn **CH** to select the menu "Decode DTMF Off".
  3. Hold down [FUNC] and turn **CH**. 15 consecutive dash line appears on the display. The TS-220DX is ready to decode the DTMF tone. You can also press [# ID PAG] or [0 SET/SB] to activate the DTMF decode function.
  4. Repeat step 1 or press [D CL PS] to exit the Set Menu mode.

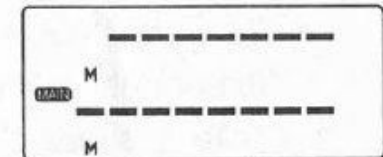
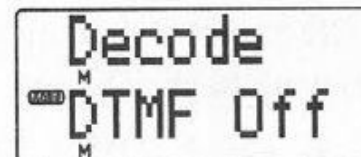

## 7-7 DTMF Paging

- DTMF paging uses a string of 7 DTMF digits, which are specially formatted sequences, as shown below.

1st	2nd	3rd	*	4th	5th	6th
ID of called station			flag	ID of calling station		

There are eight DTMF paging code memories, C0-C6 and CP. Each memory holds a 3-digit code.

C0 holds your personal paging code.

C1-C6 store other partner's paging codes or group codes.

CP is read only. It stores the ID of the calling station.

When you want to page someone, you must first set a personal paging code and one or more group codes, then turn on the paging feature. Once you transmit, their code along with yours is sent as the DTMF paging string. Actually, the paging sequence can be transmitted manually by using keypad.

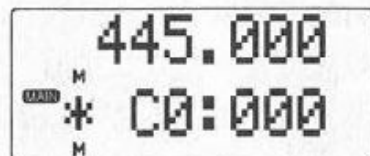

## 7-8 Setting Personal or Group Code

- Press [FUNC] + [5 CODE].
- Turn **CH** to select paging code memory C0.
- Enter 3-digit personal code. When you use the keypad to enter the third digit, the TS-220DX sounds a long tone.
- Repeat steps 2-3 to select the paging code memory you want to set.(C1-C6)
- Press [FUNC] + [5 CODE] or press [D CL PS] to return to the previous mode.

Note: To set a code as a group code, press [FUNC] + [\* MS MS.M], so the \* appears next to the paging code memory number. You can only program the digits 0-9 into a paging code memory.

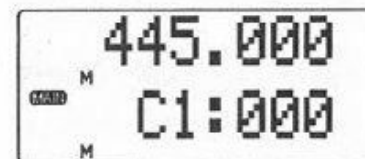

## 7-9 Paging from Memory

- Press [FUNC] + [# ID PAG], "PAG" icon appears at the bottom of the frequency display.
- Press [FUNC] + [5 CODE].

3. Turn **CH** to select the desired individual or group paging code memory you want to page.
  4. Press [PTT], the TS-220DX transmits a string of 7 DTMF code.
  5. The receiving TS-220DX rings and displays "CP: XXX", where XXX is your personal code.
- Note: When "PAG" icon appears, the TS-220DX transmits the above sequence every time you press [PTT] and does not open squelch unless it receives a valid paging code.



### 7-10 Setting Page Squelch

- In paging mode, the TS-220DX normally opens squelch after it receives the paging code stored in C0 or a valid group code. To have the TS-220DX keep squelch closed after it receives a valid code, turn off page squelch.

1. Press [FUNC] + [0 SET/SB] to enter the Set Menu mode.
2. Turn **CH** to select the menu "PAGE SQL Off".

3. Hold down [FUNC] and turn **CH** to change "PAGE SQL Off" to "PAGE SQL On". You can also press [# ID PAG] or [0 SET/SB] to change the setting.
4. Repeat step 1 or press [D CL PS] to exit the Set Menu mode.



### 7-11 Setting Page Delay

- Normally, the TS-220DX waits 450ms after the [PTT] is pressed to send the paging codes. This might not be long enough to allow some repeaters to activate. So it is necessary to change the page delay.

1. Press [FUNC] + [0 SET/SB] to enter the Set Menu mode.
2. Turn **CH** to select the menu "PAGE-DLY 450".
3. Hold down [FUNC] and turn **CH** to change "PAGE-DLY 450" to "PAGE-DLY 750". You can also press [# ID PAG] or [0 SET/SB] to change the setting.



4. Repeat step 1 or press [D CL PS] to exit the Set Menu mode.

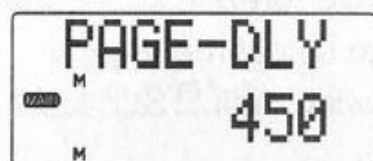

## 7-12 Changing Page Rings

- Normally, the TS-220DX rings 5 times after it receives a page. The number of rings can be changed to 1 ring or no ring.

1. Press [FUNC] + [0 SET/SB] to enter the Set Menu mode.
2. Turn **CH** to select the menu "PageRing 5".
3. Hold down [FUNC] and turn **CH** to change "PageRing 5" to "PageRing 1" or "PageRing Off". You can also press [# ID PAG] or [0 SET/SB] to change the setting.
4. Repeat step 1 or press [D CL PS] to exit the Set Menu mode.

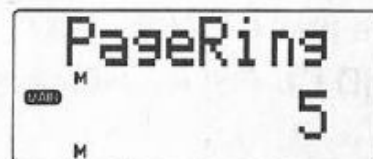

## 7-13 Using DTMF Code Squelch

- With code squelch, all stations use the same 3-digit DTMF code. It allows you to set the TS-220DX to mute all calls that are not preceded by a 3-digit code which you select. Each time you press [PTT], your TS-220DX transmits this same 3-digit DTMF code. This lets you set up a DTMF code squelch group that allows you to avoid hearing transmissions from outside your code squelch group.

1. Store the desired 3-digit DTMF code in one of the paging code memories. (See 7-7)
2. Press [B MAIN MONO] to select main band.
3. Press [FUNC] + [# ID PAG] twice until "CSQ" icon appears at the bottom of the frequency display.
4. Press [FUNC] + [5 CODE]. The TS-220DX displays the current paging code memory.
5. Turn **CH** to select the code to which you want your TS-220DX to respond.
6. Repeat step 4 to return to the previous mode.

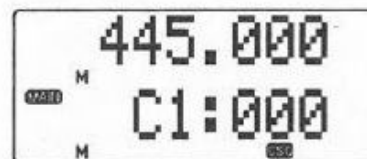

## 8 CTCSS Features

Only when the CTCSS unit is installed, the TS-220DXS' CTCSS(Continuous Tone Coded Squelch System) function can be used. CTCSS functions by using a sub-audible tone which is superimposed on a transmitted carrier to control a receiver's squelch. CTCSS allows you to transmit the sub-audible tone required by some repeaters, and also allows you to set a sub-audible tone that your TS-220DX must receive to open the squelch. To use tone squelch, you must set the sub-audible tone, then turn on the tone encode or tone squelch option.

### 8-1 Using Tone Encode

1. Press [B MAIN MONO] to select main band.
2. Press [FUNC] + [7 TSQ], "T" icon appears on the display. When only T is on the display, reception is not affected.
3. Press [FUNC]+[7 TSQ] twice to exit tone encode mode.

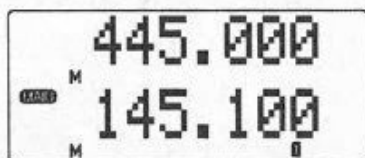

### 8-2 Using Tone Squelch

- You will not hear any transmission that does not include the selected CTCSS tone.
1. Press [B MAIN MONO] to select main band.
  2. Press [FUNC]+[7 TSQ] twice until "TSQ" icon appears on the display.
  3. Press [FUNC]+[7 TSQ] to exit tone squelch.

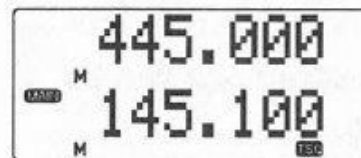

### 8-3 Setting CTCSS Tone

1. Press [B MAIN MONO] to select the main band.
2. Press [FUNC]+[0 SET/SB] to enter the Set Menu mode.
3. Turn **CH** to select the menu " CF 110.9 ".
4. Hold down [FUNC] and turn **CH** to select a new CTCSS tone from the tone frequency chart illustrated below. You can also press [# ID PAG] or [0 SET/SB] to select a new CTCSS tone.
5. Repeat step 2 or press [D CL PS] to exit the Set Menu mode.

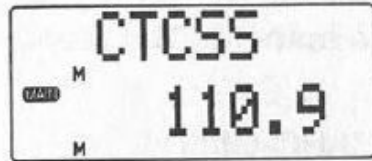

Tone frequency chart ( Unit: Hz )

67.0	71.9	74.4	77.0	79.7	82.5
85.4	88.5	91.5	94.8	97.4	100.0
103.5	107.2	110.9	114.8	118.8	123.0
127.3	131.8	136.5	141.3	146.2	151.4
156.7	162.2	167.9	173.8	179.9	186.2
192.8	203.5	210.7	218.1	225.7	233.6
241.8	250.3				

## 9 Additional Features

### 9-1 Setting AM Reception Mode

- AM reception is available only with the VHF band. Once the menu "AM Mode Off" is turned on, "A" replaces the first digit of the frequency you select.
1. Press [FUNC]+[0 SET/SB] to enter the Set Menu mode.
  2. Turn **CH** to select the menu "AM Mode Off".
  3. Hold down [FUNC] and turn **CH** to change "AM Mode Off" to "AM Mode On". You can also press [# ID PAG] or [0 SET/SB] to change the setting.
  4. Repeat step 1 or press [D CL PS] to exit the Set Menu mode.
  5. Confirm AM reception is activated, the 100MHz digit is replaced by "A".

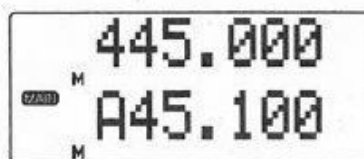
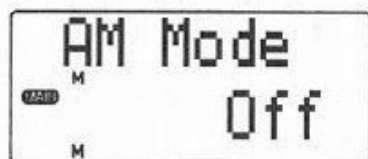

### 9-2 Setting Auto Power Off

- The TS-220DX automatically turns off if it does not receive a signal or keypad entry within 30 minutes.

When the APO is activated, a warning beep sounds 1 minute before the power turns off.

1. Press [FUNC]+[0 SET/SB] to enter the Set Menu mode.
2. Turn **CH** to select the menu "APO Off".
3. Hold down [FUNC] and turn **CH** to change "APO Off" to "APO On". You can also press [# ID PAG] or [0 SET/SB] to change the setting.
4. "APO" icon should appear on the lower right of the display.
5. Repeat step 1 or press [D CL PS] to exit the Set Menu mode.

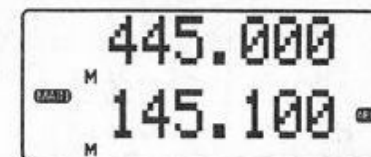
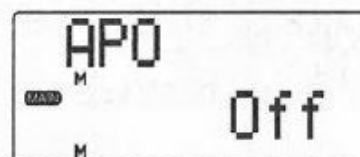

### 9-3 Setting Reception Attenuation( ATT )

The menu "ATT" is designed to change the current band's sensitivity. To improve reception in areas where there are many RF interference sources, you can reduce your TS-220DXS' sensitivity.

1. Press [FUNC]+[0 SET/SB] to enter the Set Menu mode.

2. Turn **CH** to select the menu "ATT Off".
3. Hold down [FUNC] and turn **CH** to change "ATT Off" to "ATT On". You can also press [# ID PAG] or [0 SET/SB] to change the setting.
4. "A" icon should appear at the bottom of the frequency display.
5. Repeat step 1 or press [D CL PS] to exit the Set Menu mode.

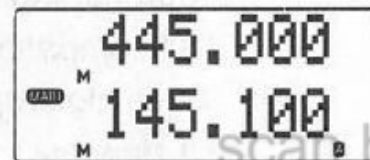
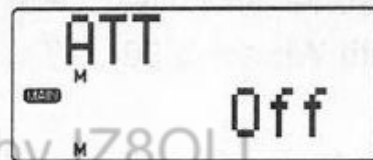

- "AUTO AM Off" to "AUTO AM On". You can also press [#ID PAG] or [0 SET/SB] to change the setting.
4. Repeat step 1 or press [D CL PS] to exit the Set Menu mode.
  5. Confirm that AM reception is activated if you select a frequency between 108.00MHz and 136.995MHz. The 100MHz digit is replaced by "A".

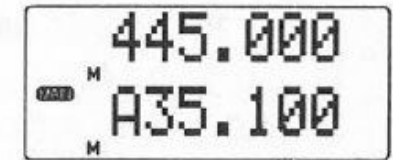

#### 9-4 Setting Auto AM Mode

- If you select a frequency between 108.00MHz and 136.995MHz, the TS-220DX automatically selects AM reception. "A" replaces the 100MHz digit of the frequency when the AM mode is turned on. The menu "AM Mode Off" automatically changes to "AM Mode On".
1. Press [FUNC]+[0 SET/SB] to enter the Set Menu mode.
  2. Turn **CH** to select the menu " AUTO AM Off".
  3. Hold down [FUNC] and turn **CH** to change

#### 9-5 Setting Auto Power On Function

- If you release the battery pack or unplug the DC power input without pressing the [PWR] key, the TS-220DX turns on automatically after the power is recovered.
1. Press [FUNC]+[0 SET/SB] to enter the Set Menu mode.
  2. Turn **CH** to select the menu "AUTO PWR ON Off".
  3. Hold down [FUNC] and turn **CH** to change "AUTO PWR ON Off" to " AUTO PWR ON On". You can also press [# ID PAG] or [0 SET/SB] to change the setting.

4. Repeat step 1 or press [D CL PS] to exit the Set Menu mode.

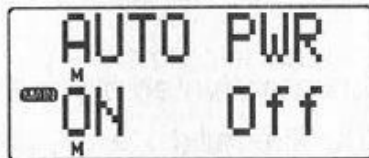

### 9-6 Turning Entry Beep Tone On/Off

- You can turn on or turn off the entry beep sound as you like.
1. Press [FUNC]+[0 SET/SB] to enter the Set Menu mode.
  2. Turn **CH** to select the menu "Beep On".
  3. Hold down [FUNC] and turn **CH** to change "Beep On" to "Beep Off". You can also press [# ID PAG] or [0 SET/SB] to change the setting.
  4. Repeat step 1 or press [D CL PS] to exit the Set Menu mode.

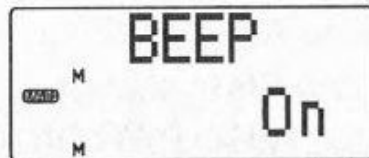

### 9-7 Cloning

- The clone feature allows you to copy all settings and memory contents from one TS-220DX to any others by: (1) Transmitting a sequence of DTMF codes from the source TS-220DX to the target TS-220DX(s), (2) Transmitting all settings and memory contents from one TS-220DX to any others by wire, (3) Programming by a personal computer (IBM compatible PC with Windows 95)
  - Wireless cloning
1. Set a transmit frequency on the source TS-220DX.
  2. Set the target TS-220DX(s) to the same band and frequency as the source TS-220DX.
  3. Press [FUNC]+[0 SET/SB] to enter the Set menu mode on both the source TS-220DX and all the target TS-220DX(s).
  4. Turn **CH** to select the menu "Clone Off" on both the source and the target TS-220DX(s).
  5. Hold down [FUNC] and turn **CH** or press [# ID PAG] or [0 SET/SB] on both the source and the target TS-220DX(s). All the portables should display the frequency you previously selected in step 1 and 2. "PAG" and "CSQ" should also appear on the display.

6. Press [PTT] on the source TS-220DX to start cloning.
7. During Cloning, "PAG" flashes on each target TS-220DXS' display. While "PAG" and "CSQ" should disappear from the display of the source TS-220DX.
8. It takes about 6 minutes to complete the cloning. After cloning is completed, each target TS-220DX turns off automatically. If a cloning error occurs, "CLN Err" appears on the target TS-220DXS' display.
9. If "CLN Err" occurs, repeat steps 1-7 and try again.

4. To start the cloning, press [2 DUAL] on the source TS-220DX.
5. It takes about 40 seconds to complete the cloning. After cloning is completed, each target TS-220DX should display "OK".

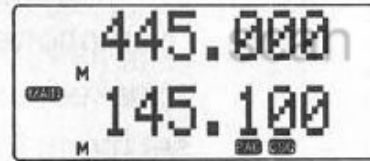
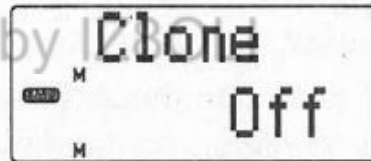
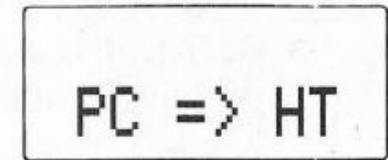
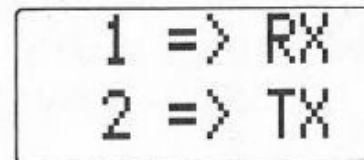

■ Wire cloning

1. Put source and target TS-220DX(s) into programming mode by pressing and holding down [FUNC] + [2 DUAL] while switching on by pressing [PWR]. "1 ⇨ RX 2 ⇨ TX" should appear on the display.
2. Press [1 PO] to select the target TS-220DX(s).
3. Connect the wires with Philips connector to the source TS-220DX and the target TS-220DX(s), as illustrated below.

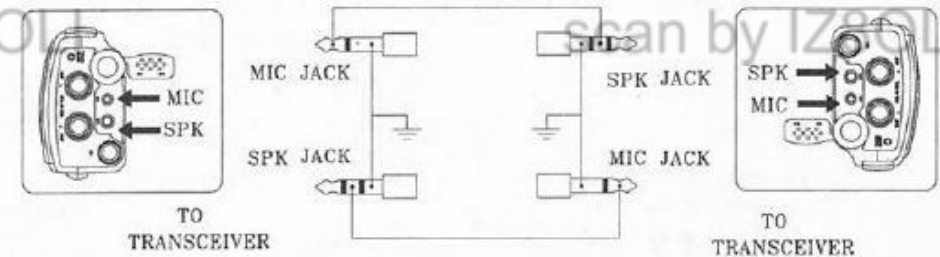

■ Programming by a personal computer

1. Put source and target TS-220DX(s), into programming mode by pressing and holding down [FUNC]+[ 2 DUAL] while switching on by pressing [PWR]. "1 ⇨ RX 2 ⇨ TX" should appear on the display.
2. Press [1 PO] to select the target TS-220DX(s).
3. Connect the wire supplied by ADI to the personal computer and the target TS-220DX, as illustrated below.
4. Follow the programming instructions supplied in the ADI software.

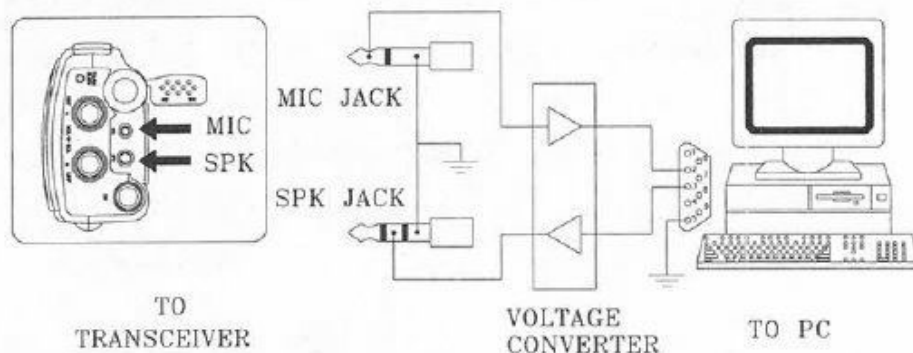

9-8 Full Duplex Operation

- Full duplex operation allows you to transmit on one band while receiving on the other band without muting reception. This operation closely resembles

speaking over a telephone.

1. Press [FUNC]+[0 SET/SB] to enter the Set Menu mode.
2. Turn **CH** to select the menu "Duplex Off".
3. Hold down [FUNC] and turn **CH** to change "Duplex Off" to "Duplex On". You can also press [# ID PAG] or [0 SET/SB] to change the setting.
4. Confirm that the "DUP" icon is displayed.
5. Repeat step 1 or press [D CL PS] to exit the Set Menu mode.

Notes: To avoid an echo between the internal microphone and speaker, use of the external speaker/microphone is recommended. The set menu for speaker configuration(see 9-12) is either "Speaker Mode IE" or "Speaker Mode EI" depending on which band is selected as the main band.

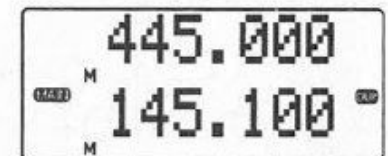
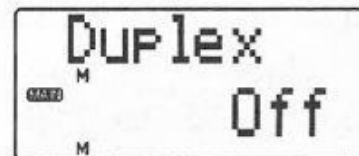



## 9-9 Setting 1KHz Digit Option

- Normally, you have to enter 6 digits(from 100MHz digit to 1KHz digit) to finish the frequency setting.You can set your TS-220DX to either manually or automatically set the 1KHz digit.

1. Press [FUNC]+[0 SET/SB] to enter the Set Menu mode.
2. Turn **CH** to select the menu "1K Digit On".
3. Hold down [FUNC] and turn **CH** to change "1K Digit On" to "1K Digit Off ". You can also press [# ID PAG] or [0 SET/SB] to change the setting.
4. Repeat step 1 or press [D CL PS] to exit the Set Menu mode.
5. With the 1KHz digit switched off, it is only necessary to enter 5 digits of a new frequency entry. However, if the 1 KHz digit is switched on, then all 6 digits of a new frequency must be entered. The TS-220DX will automatically set the last digit to the nearest multiple of either 5 KHz or 6.25KHz. The following table illustrates the final result.

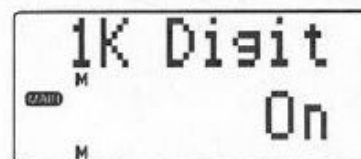

	Last 2 digits entered	Final result	Reference Frequency
1	11,12,13	1 2 5	6.25 KHz
2	37,38,39	3 7 5	6.25 KHz
3	61,62,63	6 2 5	6.25 KHz
4	87,88,89	8 7 5	6.25 KHz
5	Except items 1-4, the last digit determines the final result. 1KHz: 0, 1, 2, 3, → 0 4, 5, 6, 7, 8, 9 → 5	X 0 X 5	5 KHz

For example, enter number 1, 4, 4, 8, 8, 8 will get a frequency of "144.8875" with internal reference frequency 6.25KHz.

## 9-10 Setting Power On Message

- Having a unique power on message is one way to personalize your TS-220DX.The power on message is up to 6 characters. It will be displayed and stay for about 1 sec each time you turn on your TS-220DX.

1. Press [FUNC]+[0 SET/SB] to enter the Set Menu mode.
2. Turn **CH** to select the menu "PwrOnMsg".
3. Press [FUNC]+[A CALL SFT], a flashing cursor should appear under "PwrOnMsg".
4. Turn **CH** to select the character.
5. Hold on [FUNC] and turn **CH** to move the cursor. You can also press [# ID PAG] or [0 SET/SB] to move the cursor.
6. Repeat steps 4-5 until you have entered the desired power on message.
7. Press [FUNC]+[C V/M ENT] to save the message. To quit without saving the message, Press [D CL PS].
8. Repeat step 1 or press [D CL PS] to exit the Set Menu mode.

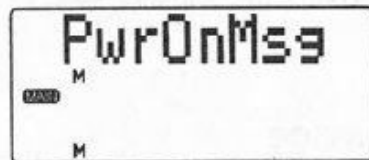

## 9-11 Battery Save

- The battery save option allows you to extend your TS-220DXS' battery life. The battery save function actually turns off one or both of the TS-220DXS' RF section for a period of time you specify and then turns on the TS-220DX to check for a signal. Once it detects a signal, it stays on until 2 seconds after the signal disappears.

1. Press [FUNC]+[0 SET/SB] to enter the Set Menu mode.
2. Turn **CH** to select the menu "Save Off".
3. Hold down [FUNC] and turn **CH** to change "Save Off" to "Save 0.5" or "Save 1.0" --- or "Save 5.0". "S" should appear in the display. You can also press [# ID PAG] or [0 SET/SB] to change the setting.
4. Repeat step 1 or press [D CL PS] to exit the Set Menu mode.

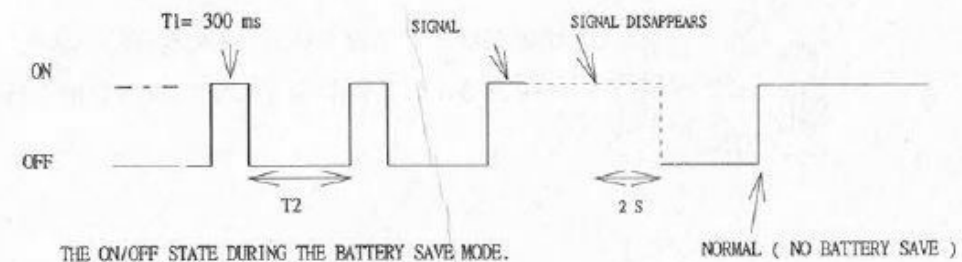

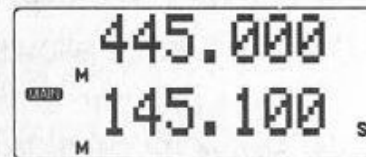
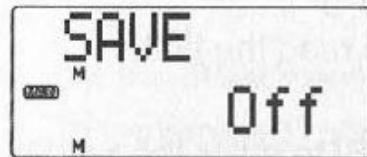

With external speaker connected

Setting	VHF sound	UHF sound
I I	External speaker	External speaker
I E	Internal speaker	External speaker
E I	External speaker	Internal speaker

Without external speaker connected

Setting	VHF sound	UHF sound
I I	Internal speaker	Internal speaker
I E	Internal speaker	No sound
E I	No sound	Internal speaker

## 9-12 Selecting Internal/External Speaker

- This function allows you to select which band uses an external speaker instead of the internal speaker.
1. Press [FUNC]+[0 SET/SB] to enter the Set Menu mode.
  2. Turn **CH** to select the menu "Speaker Mode I I".
  3. Hold down [FUNC] and turn **CH** to change "Speaker Mode I I" to the other configurations. You can also press [# ID PAG] or [0 SET/SB] to change the setting.
  4. Repeat step 1 or press [D CL PS] to exit the Set Menu mode.

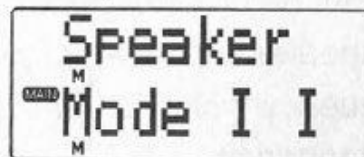

### 9-13 Setting Time-Out Timer ( T.O.T )

● The time-out-timer feature alerts you if you transmit for longer than a specified period of time. This feature prevents channel tie-up and excessive battery drain in case the [PTT] is accidentally pressed. The TS-220DX provides the users with from one to 15 minutes of selection for the time-out timer. When transmit time is limited, the TS-220DX sounds a warning beep before it stops transmitting.

1. Press [FUNC]+[0 SET/SB] to enter the Set Menu mode.
2. Turn **CH** to select the menu "TOT Off".
3. Hold down [FUNC] and turn **CH** to change "TOT Off" to "TOT 1" or "TOT 2" --- or "TOT 15", whichever you may desire. You can also press [# ID PAG] or [0 SET/SB] to change the setting.
4. Repeat step 1 or press [D CL PS] to exit the Set Menu mode.

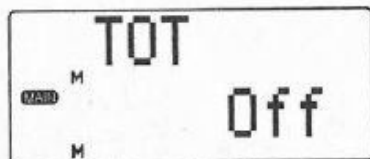

### 9-14 Battery Voltage Reading

● This feature allows you to read the battery voltage anytime anywhere.

1. Press [FUNC]+[0 SET/SB] to enter the Set Menu mode.
2. Turn **CH** to select the menu "Voltage".
3. The battery voltage appears under "Voltage" in the display.
4. Repeat step 1 or press [D CL PS] to exit the Set Menu mode.

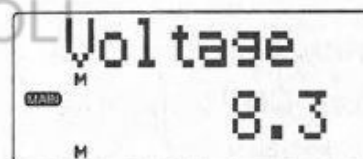

### 9-15 1750Hz Tone Burst

● For European models, this function allows you to transmit a tone burst signal to access repeaters. To use a repeater, the TS-220DX must be set to duplex operation—You transmit on one frequency which is the same as the repeater's receive frequency and receive on another frequency which is the same as the repeater's transmit frequency.

1. Press [B MAIN MONO] to select main band.

2. Press [FUNC] + [8 RPT] to select the offset direction.
3. Set the offset frequency.(See 6-2)
4. To transmit a 1750Hz tone burst, press [ PTT ] +[D CL PS], "D" should appear at the 100MHz digit. Keep holding down the [ PTT ] and press [A CALL SFT] .

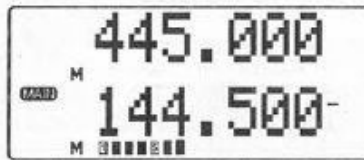
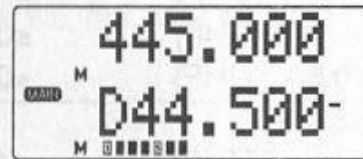
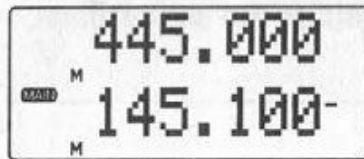

# SPECIFICATIONS

scan by IZ8OLI

scan by IZ8OLI

General Specification				
Frequency Range		VHF : 144.0 - 146.0 MHz UHF : 430.0 - 440.0 MHz	VHF : 144.0 - 148.0 MHz UHF : 438.0 - 450.0 MHz	
Modulation Type		F3		
Microphone Input Impedance		600Ω		
Speaker Impedance		8Ω		
Supply Voltage		6.0 - 16.0 V		
Nominal Voltage		7.2 V		
Current Consumption	Transmitting (13.8 V)	High(5W)	≤1.5A (UHF)	≤1.4A (VHF)
		Medium(2.0W)	≤1.0A (UHF)	≤0.9A (VHF)
		Low(0.35W)	≤0.5A (UHF)	≤0.5A (VHF)
	Receiving	Dual mode	≤85mA	
		Single mode	≤50mA(UHF)	≤40mA(VHF)
Battery Saving		Dual mode	≤50mA	
		Single mode	≤20mA	
Dimension(H x W x D, mm )		189 x 61 x 43 (without power pack & protrusion)		
Weight		380g(without power pack & antenna)		
Receiving				
Reception Type		Dual Conversion Superheterodyne		
Intermediate Frequency		1st IF : 21.80MHz, 2nd IF : 450KHz(VHF) 1st IF : 23.05MHz, 2nd IF : 450KHz(UHF)		
Sensitivity (12dB SINAD)		0.16 μV (VHF), 0.18 μV (UHF)		
S/N Ratio at 1 μV		≥ 33dB(UHF), ≥ 35dB(VHF)		
Threshold Squelch Sensitivity		≤ 0.15 μV		
Audio Output Power		450mW (8 Ω, 10% distortion).		

scan by IZ8OLI

scan by IZ8OLI

scan by IZ8OLI

Transmitting			
Modulation Method	Reactance modulation		
Maximum Frequency Deviation	5KHz		
Suprious Output	≤ -60 dBc		
Built-in Microphone	Condenser microphone		
Output Power(W) (13.8 / 7.2V)	High	5.0/1.8 (UHF)	5.0/2.0 (VHF)
	Medium	1.8/1.8 (UHF)	2.0/2.0 (VHF)
	Low	0.35/0.35 (UHF)	0.35/0.35W (VHF)

The specifications are subject to change without prior notice.

scan by IZ8OLI

scan by IZ8OLI

scan by IZ8OLI

scan by IZ8OLI

scan by IZ8OLI

scan by IZ8OLI

scan by IZ8OLI

scan by IZ8OLI

scan by IZ8OLI





### **ONE YEAR LIMITED WARRANTY**

- ADI Communications Corp. warrants this product against defects in material and workmanship.
- In the unlikely event of any failure due to defect in material or workmanship, occurring within one year of purchase, this product will be repaired or replaced at our discretion at no charge.
- The defective product should be returned in its original packing and with proof of the date of the original retail purchase to your dealer for warranty service.
- The warranty does not cover accident, misuse, fire, flood and other Act of God, unauthorized repair or altered serial numbers.
- Some statutory regulations do not allow for the exclusion or limitation of incidental or consequential damages, nor allow limitations on how long an implied warranty lasts, therefore the above limitations may not apply to you,

The frequency range modification of the Transceiver

TX wide range

1. Hold down the FUNC and press the 0 key.
2. Input the code key 1462311289 (No number appeared in the display)
3. The display shows "KEY OK! Ver 1.00"
4. Hold down the FUNC and press the 0 key.
5. The display shows the frequency mode and your transceiver is now wide range for RX and TX.

(VHF BAND)

RX : 100 ~ 170MHz  
TX : 130 ~ 163MHz

(UHF BAND)

RX : 350 ~ 473MHz  
830 ~ 1000MHz  
TX : 410 ~ 475MHz

TX narrow range

1. Turn the radio OFF.
2. Press FUNC , D together and press POWER.
3. The display shows "RESET? Press C".
4. Press C.
5. The display shows frequency mode and your transceiver is now narrow range for TX.

(VHF BAND)

RX : 100 ~ 170MHz  
TX : 144 ~ 146MHz

(UHF BAND)

RX : 350 ~ 473MHz  
830 ~ 1000MHz

TX : 430 ~ 440MHz

scan by IZ8OLI

scan by IZ8OLI

scan by IZ8OLI

scan by IZ8OLI

scan by IZ8OLI

scan by IZ8OLI

scan by IZ8OLI

scan by IZ8OLI

scan by IZ8OLI

scan by IZ8OLI

scan by IZ8OLI

scan by IZ8OLI

scan by IZ8OLI

scan by IZ8OLI

scan by IZ8OLI

scan by IZ8OLI

scan by IZ8OLI

scan by IZ8OLI

scan by IZ8OLI

scan by IZ8OLI

scan by IZ8OLI

scan by IZ8OLI

scan by IZ8OLI

scan by IZ8OLI

scan by IZ8OLI

scan by IZ8OLI

scan by IZ8OLI

scan by IZ8OLI

scan by IZ8OLI

scan by IZ8OLI

scan by IZ8OLI

scan by IZ8OLI

scan by IZ8OLI

scan by IZ8OLI

scan by IZ8OLI

scan by IZ8OLI

scan by IZ8OLI

scan by IZ8OLI

scan by IZ8OLI

scan by IZ8OLI

scan by IZ8OLI

scan by IZ8OLI

HOTLINE SA

via Magazzini Generali 8

CH-6828 Balerna



NX168A024

scan by IZ8OLI

60  
scan by IZ8OLI

scan by IZ8OLI