

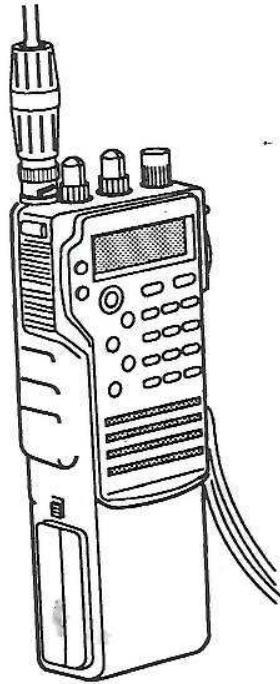

Owner's Manual

DELUXE TWIN-BAND MINI HT Model C228A

Copyright © 1990
Standard Amateur Radio Products, Inc.
All Rights Reserved
Printed in Japan



STANDARD AMATEUR RADIO PRODUCTS, INC.
MANUFACTURED BY MARANTZ JAPAN, INC.

Table of Contents

<p>INTRODUCTION..... IV</p> <p>SPECIFICATIONS VIII</p> <p>GETTING STARTED 1-1</p> <p>OPERATION 2-1</p> <p> General 2-1</p> <p> Operating Characteristics 2-7</p> <p> Changing VFOs 2-7</p> <p> Setting the Operating Frequency 2-8</p> <p> Repeater Operation..... 2-10</p> <p> Enable Repeater Operation 2-11</p> <p> Changing the Offset Frequency 2-12</p> <p> Changing the Tone Frequency..... 2-13</p> <p> Swapping Transmit and Receive Frequencies 2-15</p> <p> Memory Functions 2-16</p> <p> Placing Frequencies in Memory 2-16</p> <p> Recalling a Memory Frequency 2-18</p>	<p> Changing a Memory Frequency 2-19</p> <p> Deleting a Memory Frequency 2-21</p> <p> Storing Repeater Operation in a Memory Location 2-23</p> <p> Canceling Repeater Operation in a Memory Location 2-24</p> <p> Storing Tone Squelch Operation in a Memory Location 2-25</p> <p> Changing the Repeater Tone and Offset Frequencies in Memory 2-26</p> <p> Temporarily Changing Frequency During the Memory Recall Mode 2-28</p> <p> Scanning Functions 2-29</p> <p> VFO-Frequency Scanning 2-30</p> <p> Memory-Frequency Scanning 2-33</p> <p> Tone-Frequency Scanning 2-37</p> <p> Paging and Coded Squelch Function 2-39</p> <p> Preparation for Paging 2-40</p> <p> Paging a Station 2-44</p>
---	--

Receiving a Page	2-46	Cross-Band Repeater Operation	2-65
Miscellaneous Functions	2-48	10 MHz Keyboard Entry	2-67
Turning Off One Receiver	2-48	1 MHz Rotary Channel Selector Steps	2-68
Dual-Watch	2-48	10 MHz ▼/▲ Frequency Steps	2-69
Changing the Transmitter Power	2-51	Transmitting a Single DTMF Tone	2-70
Changing the Frequency Step	2-52	Disabling Voice Paging	2-71
Battery-Saver Function	2-53	Copying Memory Contents to Another	
Frequency Lock Function	2-54	Transceiver	2-72
PTT Lock Function	2-55	Expanding the Memory	2-74
Tone-Squelch Function	2-55	Deleting an Expanded Memory Address	2-75
Auto-Power Off	2-57	Changing the Call frequency	2-76
Muting the Beep Tones	2-58	Storing a DTMF sequence in memory using DTMF	
Changing the Number of Beep Tones During		sequence memory	2-77
Pager Operation	2-59	ABOUT THE BATTERY	3-1
Entering the 1 kHz Frequency Digit	2-60	IN CASE OF DIFFICULTY	4-1
Changing the Pager Code Delay	2-61	WARRANTY	Last page
Changing the Squelch Delay	2-62	SCHEMATIC/BLOCK DIAGRAM	Fold -in
Using the Rotary Channel Selector While			
Frequency is Locked	2-63		
Coded Squelch	2-64		

INTRODUCTION

Your Standard Model C228A is a highly versatile, yet compact Deluxe Twin-Band Mini HT that is built and tested to stringent specifications. It uses the latest surface mount and microcomputer technologies to provide you with many useful functions. The following features are built into your Transceiver:

- Unsurpassed receiver sensitivity of 0.158 μ V for 12 dB SINAD.
- Broad-band reception 130 MHz to 175 MHz on 144 MHz Band and 200 MHz to 245 MHz on 220 MHz Band.
- Transmitter RF output may be set to any one of three power levels: low (350 mW), medium (2.5 W), and high (2.8 W) with the 7.2 V standard battery pack.
- High efficiency for long battery life.
- 20 memory channels are available, ten in each band. Separate repeater offset and tone frequency can be stored along with the operating frequency in each memory channel. The memory can be expanded to 40 channels, with some storage limitations.
- Either Pause or Busy scan functions can be selected. Scanning of the dial frequency provides a 1 MHz scan, all scan, or program (favorite) scan.
- Frequencies can be entered directly from the keyboard or via a unique rotary channel switch.
- A 7.2-volt, 700 mAh rechargeable battery and wall cube charger are included.
- A wide range of acceptable external power supply voltages (6.0 to 16 volts DC) allows you to power the Transceiver directly from an automobile battery.

- A tone squelch function (when the optional Model CTN520 CTCSS Tone Squelch Unit is installed) enables the Transceiver to hear only stations that use the same specific tone frequency. This tone frequency is selected via the rotary channel switch.
- A code squelch function enables the Transceiver to hear only stations that have the same code. This function is especially ideal for use at hamfests when you want to stay in touch with your friends, but prefer not to hear all of the other noise.
- Duplex operation permits full-duplex QSOs using the two bands.
- Built-in crossband repeater function with no or 2-second "tail".
- The DTMF function allows you to control some repeaters and make telephone calls via your Transceiver through certain repeaters.
- Simultaneous operation of the code squelch and tone squelch functions.
- An auto-power off function reduces the current drain if you forget to turn the Transceiver off.
- A single press of a pushbutton opens the squelch so you can easily check the volume setting.
- A Function button allows you to select either 10 kHz or 100 kHz steps when you turn the rotary channel selector.
- A paging function allows you to page one or more specific stations, or all stations in a group by means of a 3-character DTMF (dual tone modulated frequency) signal. When this paging signal is received, the other station(s) sounds a beep and the Transceiver's display indicates that it has been paged. The paging station can be identified by its individual code.

- Selected frequencies and operating mode may be locked to prevent inadvertent changes.
- PTT may be locked to prevent inadvertent transmission.
- A 2-color LED glows green when a signal is being received and red during transmit.
- The dial lamp can be turned on momentarily or locked on.

The lightweight and compact size make this Transceiver a handy addition to any amateur radio operator's equipment.

AVAILABLE ACCESSORIES

CTN520 CTCSS Encode/Decode Tone Squelch Unit.

- CNB150 Compact Rechargeable Battery Pack (7.2 V, 400 mAh).
- CNB151 Standard Rechargeable Battery Pack (7.2 V, 700 mAh).
- CNB152 High-Power Rechargeable Battery Pack (12 V, 600 mAh).
- CNB153 Long-Life Rechargeable Battery Pack (7.2 V, 1000 mAh).
- CWC150A Wall Charger (supplied). For use with 7.2 volt battery packs, Models CNB150, CNB151 or CNB153. Plugs directly into a wall outlet.
- CSA160A Automatic Quick Charger. Desk-top charger quickly charges all of the above rechargeable battery packs.

CLC520 Regular Carrying Case for Transceivers that have a standard Model CNB151 Battery Pack.

CMA111 Mobile Bracket.

CMP111 Speaker/Mic that combines two functions in one hand-held unit.

CLC521 Large Carrying Case for Transceivers that have a Model CNB152 or CNB153 Battery Pack.

CHP111 Headset with microphone and remote push-to-talk button.

SPECIFICATIONS*

GENERAL

Frequency Range	144 MHz band Receive: 130 to 175 MHz. 220 MHz band Receive: 200 to 245 MHz (in 5 kHz steps). 144 MHz band Transmit: 144 to 147.995 MHz 220 MHz band Transmit: 220 to 225 MHz (in 5 kHz steps).
Modulation Type	F3.
Microphone Input Impedance	600 ohms.
Speaker Impedance	8 ohms.
Power Requirements	7.2 volts, nominal. A 7.2-volt, 700 mAh battery pack (Model CNB151) is supplied with the Transceiver.
External Input Voltage	6.0 to 16 volts DC.

*Specifications are guaranteed within the U.S. amateur bands.

Size (excluding knobs and antenna) 6-1/4" H x 2-5/8" W x 1-3/8" D (159 x 67 x 35 mm).

Weight (including antenna and supplied battery pack) 16.9 oz. (479 g).

RECEIVER

Receiver Type Double-conversion superheterodyne.

First Intermediate Frequency 144 MHz band: 21.8 MHz.
220 MHz band: 23.05 MHz.

Second Intermediate Frequency 455 kHz.

Sensitivity (within the amateur bands) 0.158 μ V for 12 dB SINAD*.

Signal-to-noise ratio at 0.5 μ V input 30 dB or better.

Squelch Sensitivity 0.1 μ V

Audio Output 200 mW into 8 Ω (10% distortion).

$$*SINAD = \frac{\text{Signal} + \text{Noise} + \text{Distortion}}{\text{Noise} + \text{Distortion}}$$

Standby Power Consumption (approximate)	Twin-band mode: 70 mA . Mono-band mode: 45 mA 220 MHz band, 36 mA 144 MHz band.
Battery Save (approximate)	Twin-band mode: 32 mA. Mono-band mode: 18 mA 220 MHz band, 17 mA 144 MHz band.
Auto-power Off	1 mA, approximate.

TRANSMITTER

RF Output Power	With 7.2-volt battery packs:		
	<u>Power Level</u>	144 MHz band	220 MHz band
	Low	350 mW	350 mW
	Medium	2.5 W	2.5 W
	High	2.8 W	2.5 W
	With 12-volt battery packs:		
	<u>Power Level</u>	144 MHz band	220 MHz band
	Low	350 mW	350 mW
	Medium	2.5 W	2.5 W
	High	5.0 W	5.0 W

Spurious Signal Ratio	Better than -60 dB.
Maximum Frequency Deviation	±5 kHz.
Frequency Modulation System	Reactance modulation.
Built-in microphone	Electret capacitor type.
Power Consumption (approximate)	
With 13.8 Volts DC.....	1200 mA 220 MHz band, 1200 mA 144 MHz band at 5 watts RF output (high). 850 mA 220 MHz band, 850 mA 144 MHz band at 2.5 watts RF output (medium). 480 mA at 0.35 watts RF output (low).
With 7.2 Volts DC.....	850 mA 220 MHz band, 800 mA 144 MHz band at 2 watts output (high). 850 mA 220 MHz band, 800 mA 144 MHz band at 2 watts output (medium). 480 mA at 0.35 watts RF output (low).

Standard Amateur Radio Products, Inc. reserves the right to discontinue products and to change specifications at any time without incurring any obligation to incorporate a new feature in products previously sold.

GETTING STARTED

When you unpack your Transceiver, you will have to perform the following steps to get it ready for operation:

1. Push the end of the antenna onto the Transceiver's Antenna connector. Be sure to match the locking pin on each side of the connector with the slots in the end of the antenna. Then turn the antenna clockwise to lock it into place. **NOTE:** Your antenna may not look like the one shown in some drawings.

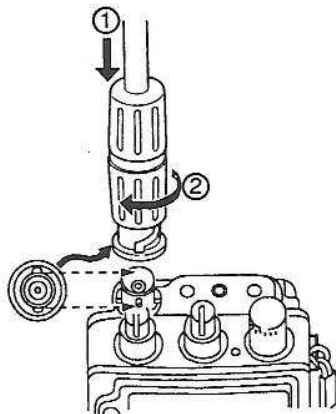

2. If the battery pack is not already installed, hold the Transceiver in one hand and grasp the battery pack with the other hand. Then slide the battery pack onto the bottom of the Transceiver. The battery pack is designed to fit only the correct way.

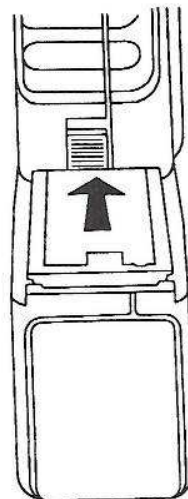

To remove the battery pack, push the battery lock button upward with your thumb and carefully pull the battery pack in the direction shown until it slides completely free.

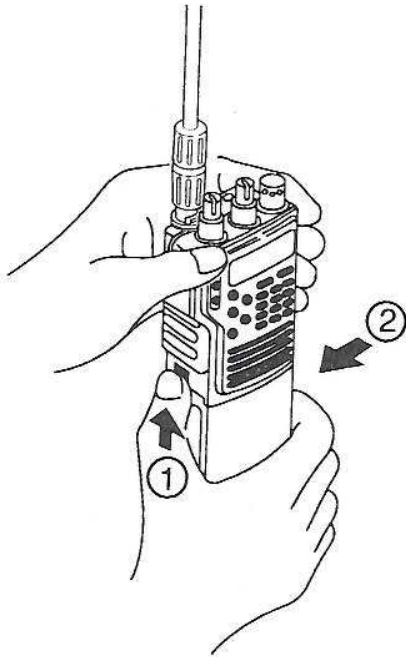

3. Rotate the PWR control in a clockwise direction just enough to turn the Transceiver on. Do not turn this control any further clockwise yet.

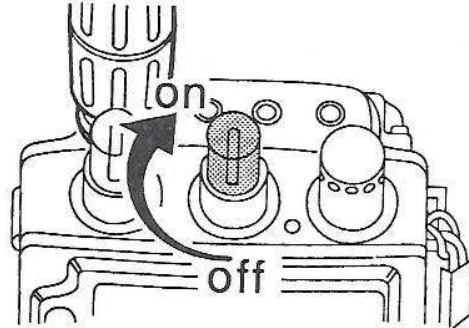

NOTE: Your Transceiver contains two separate receivers, each with its own volume control, squelch control, and display. Many of the keyboard buttons are active on only the band (144 or 220 MHz band), that is currently selected. Even though you can receive on both bands simultaneously, the transmitter is active on the selected band.

4. To select the 144 MHz band, just press the 144 button located just below the displays. The word "Main" will appear above the 144 MHz band display to indicate that it has been selected.

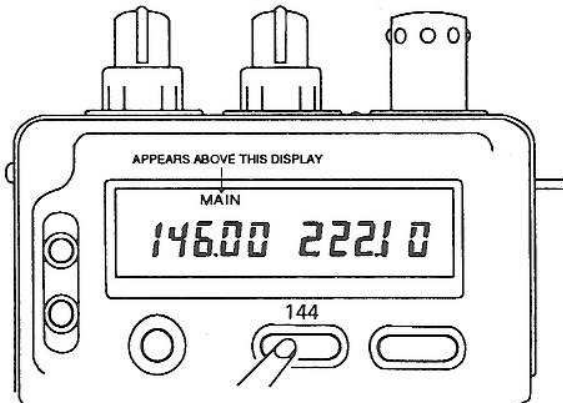

5. To select the 220 MHz band, press the 220 button located just below the displays. The word "Main" will appear above the 220 MHz band display to indicate that it has been selected.

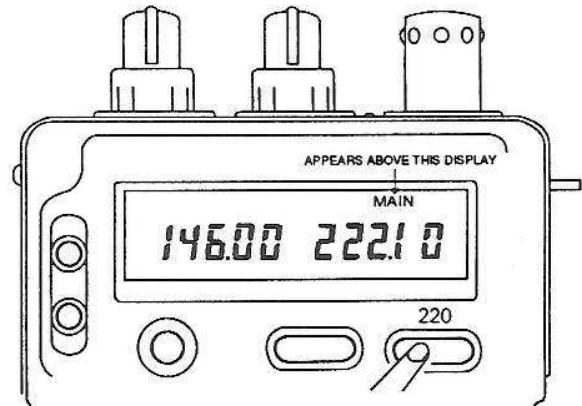

6. Push the 144 button to select the 144 MHz band. Then rotate the 144 VOL (Volume) control in a clockwise direction for the desired 144 MHz band volume. NOTE: If you do not hear noise, hold down the SQL OFF (Squelch Off) button while you adjust the volume.

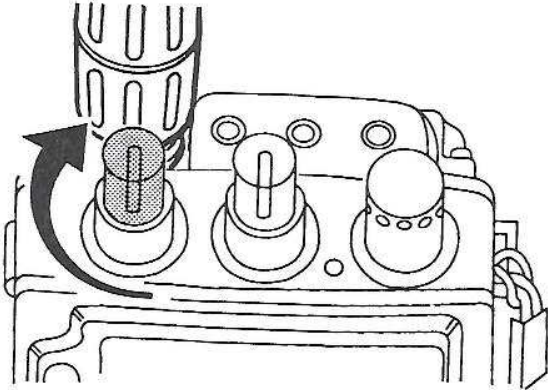

7. Rotate the 144 SQL (Squelch) control counter clockwise until you hear noise, if this has not already been done. Then rotate the control clockwise until the noise just disappears. NOTE: Advancing the control further clockwise from this position will reduce the receiver sensitivity.

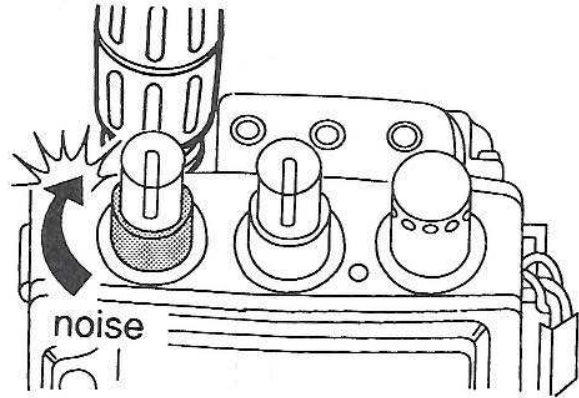

8. Push the 220 button to select the 220 MHz band. Then rotate the 220 VOL control in a clockwise direction for the desired 220 MHz band volume. If necessary, hold down the SQL OFF button to unsquelch the 220 MHz band receiver while you adjust the volume.
9. Rotate the 220 SQL control counterclockwise to hear noise, if this has not already been done. Then rotate the control clockwise until the noise just disappears. **NOTE:** Advancing the control further clockwise from this position will reduce the receiver sensitivity.

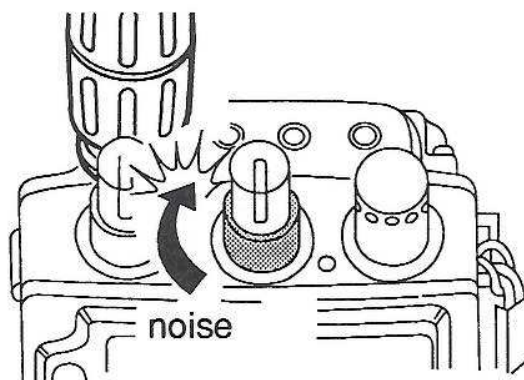
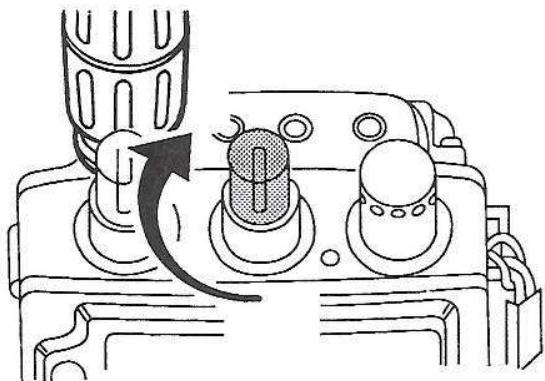

10. To transmit, first press the 144 or 220 button to select the band where you wish to transmit. Then push the PTT (push-to-talk) button on the side of the Transceiver. To receive, release the button. **NOTE:** While you are transmitting on one band, the receiver on the other band is fully operational.



11. Be sure to fully charge the battery pack before you use your Transceiver for the first time. To do this, refer to Figure 1-1 and plug the free end of the cable coming from the wall charger into its corresponding socket near the lower right side of the battery pack. Then plug the wall charger into a standard 120 VAC wall outlet. The LED on the wall charger will light to indicate that the battery is charging. Allow the battery pack to charge for about 14 hours before you use the Transceiver.

NOTE: To charge the Transceiver with the optional Automatic Quick Charger, Model CSA160A, refer to the instructions packed with that accessory.

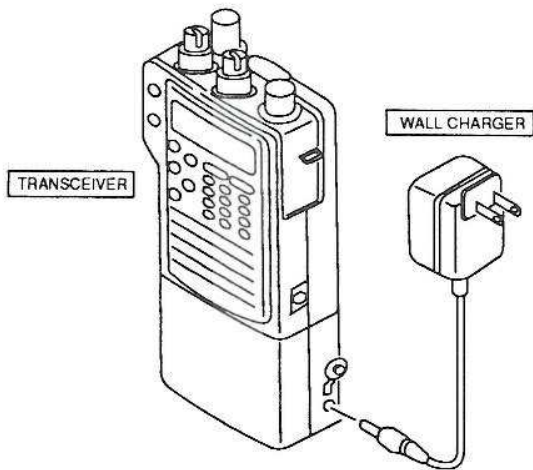

Figure 1-1

CAUTION

Never charge the battery pack with a charger other than those specified, as this could damage the battery pack.

Do not solder leads or connect wires directly to the battery pack's output terminals.

Do not short-circuit the input or output terminals. The resulting current surge could damage the battery pack. The large current could also cause burns.

Do not expose the battery pack to extreme heat or fire. If the battery pack becomes wet, wipe the pack thoroughly dry before using it.

Do not attempt to disassemble or modify the battery pack.

Do not overcharge. Repeated overcharging deteriorates the performance of the battery pack.

12. If you intend to operate your Transceiver from an external power source, you will need a matching power plug that has a 3.8 mm outside diameter. A smaller plug will not operate the battery-disconnect switch that is part of the DC IN socket. **Be sure to wire the plug with the proper polarity as shown.**

NOTE: This Transceiver will operate properly between 6.0 and 16 volts DC. Use caution when you use an automobile battery for external power; some automobile systems produce spikes that exceed this voltage range, and could damage the Transceiver.

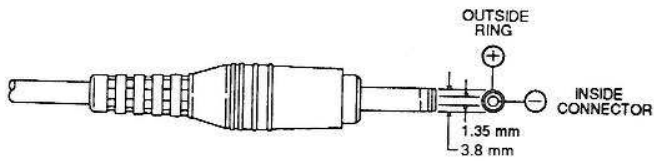

Your Transceiver is now ready for operation.

OPERATION

GENERAL

Refer to Figure 2-1 while you read the following descriptions of the top panel controls.

144 MHz BAND VOLUME — Sets the volume level of 144 MHz band reception. Hold down the SQL OFF button (on the front of the Transceiver) or turn the 144 SQUELCH control fully counterclockwise while you set the receiver volume to the level you desire.

144 MHz BAND SQUELCH — Mutes the 144 MHz band receiver when no signal is being received. Start with this control set fully counterclockwise; then rotate the control clockwise until the background noise just disappears. **NOTE:** Further clockwise rotation of this control reduces the receiver sensitivity.

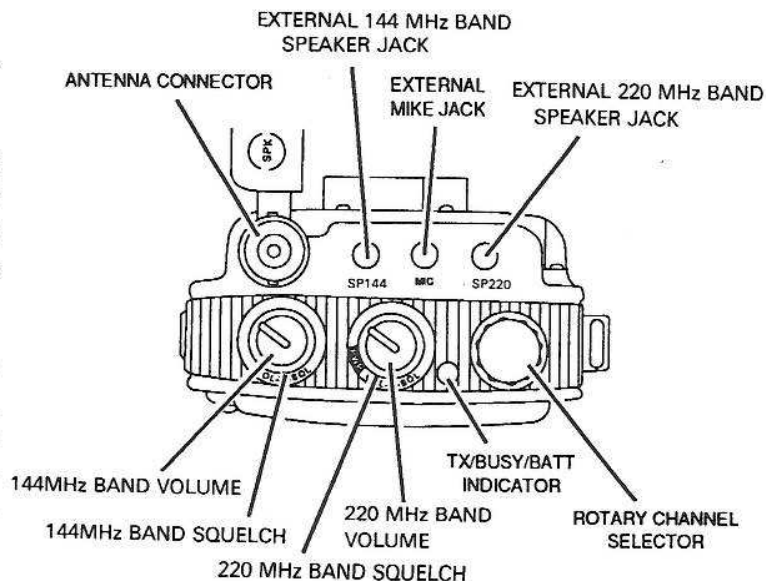

Figure 2-1

220 MHz BAND VOLUME — Turns the Transceiver on and off and sets the volume level of 220 MHz band reception. Hold down the SQL OFF button (on the front of the Transceiver) or turn the 220 SQUELCH control fully counterclockwise while you set the receiver volume to the level you desire.

220 MHz BAND SQUELCH — Mutes the 220 MHz band receiver when no signal is being received. Start with this control set fully counterclockwise; then rotate the control clockwise until the background noise just disappears. NOTE: Further clockwise rotation of this control reduces the receiver sensitivity.

TRANSMIT/BUSY/BATTERY — Glows red in the transmit mode, green when either, or both, receivers become un-squelched (from a received signal, when the Squelch control is set fully counterclockwise, or when you press the SQL OFF button). If a signal is received on the opposite receiver during transmission, this LED glows red and green at the same time. NOTE: If this LED fails to light in the transmit mode or becomes dim, it indicates that the batteries need to be recharged.

ROTARY CHANNEL SELECTOR — Sets the transmitter and receiver frequencies, tone frequency, channel step rate, offset frequency, paging address number during paging, and memory address number. Rotating this control clockwise increases the frequency, while rotating it counterclockwise decreases the frequency. The following channel step rates are available: 5 kHz, 10 kHz, 12.5 kHz, 20 kHz, 25 kHz, and 50 kHz.

ANTENNA — Accepts the flexible antenna or a 50-ohm fixed or mobile antenna. Refer to "Getting Started" for installation.

SP144 (144 MHz Band Speaker Jack) — Accepts the optional Microphone/Speaker (Model CMP111) or Headset with PTT (Model CHP111). Also can be used with external 8-ohm speakers or headphones. NOTE: When you use this jack by itself (nothing is connected to the SP220 jack), both 144 MHz band and 220 MHz band audio is sent to the external speaker, and the internal speaker is disabled. If external speakers are connected to both the SP144 and SP220 jacks, 144 MHz band audio is sent to one external speaker and 220 MHz band audio is sent to the other external

speaker. The following chart shows the various speaker combinations:

Jack Used	External Speaker	Built-in Speaker
SP144	144 & 220	Disabled
SP220 only	220	144
SP144 and SP220	144 & 220	Disabled

MIC (Microphone Jack) — Accepts the optional Microphone/Speaker (Model CMP111) or Headset with PTT (Model CHP111):

SP220 (220 MHz Band Speaker Jack) — Accepts the optional Microphone/Speaker (Model CMP111) or Headset with PTT (Model CHP111). Also can be used with external 8-ohm speakers or headphones. Refer to the chart under “SP144 (144 MHz Band Speaker Jack)”.

Refer to Figure 2-2 on Page 2-4 while you read the following descriptions of the front and side controls.

FUNC (Function) Button — Works together with other buttons to perform special functions.

PTT (Push-To-Talk) Button — Pressing this button places the Transceiver in the transmit mode.

L (Lamp) Switch — Illuminates the display for operation at night. The light will normally extinguish in about 5 seconds, or you can press the button again to turn it off sooner. To make the light stay on, hold down the FUNCTION button while you press this button. You will then have to press these two buttons again to turn it off. **NOTE:** To help conserve the battery, we recommend that you do not leave the lamp on any longer than necessary.

SQL OFF Button — Unsquels the 144 MHz band or 220 MHz band receiver, depending upon which is selected (with the 144 MHz band and 220 MHz band buttons). To unsquelch the opposite (unselected)

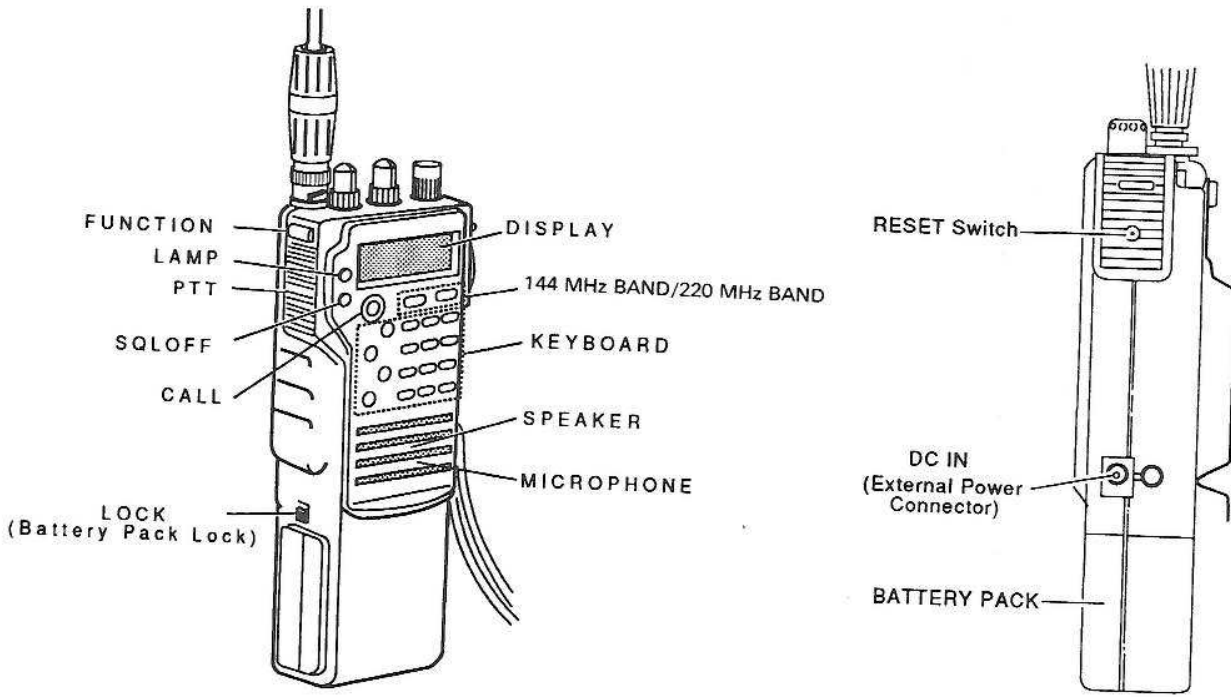

Figure 2-2

receiver, hold down the **FUNCTION** button while you press this button **NOTE:** Turning the 144 MHz band Squelch or 220 MHz band Squelch control fully counterclockwise only disables the noise squelch circuitry (turning one of these squelch controls counterclockwise will not unsquelch the receiver if the tone squelch and/or coded squelch functions for that receiver are turned on). The **SQL OFF** button, however, unsquelches the receiver regardless of the settings of the tone or code squelch functions.

CALL Button — Recalls the priority call frequency.

144 MHz Band Button — Selects the 144 MHz (very high frequency) band. "Main" will appear above the 144 MHz band display. You must press this button before you can transmit on the 144 MHz band and before many of the other keyboard buttons will have any affect on the 144 MHz band.

220 MHz Band Button — Selects the 220 MHz (ultra high frequency) band. "Main" will appear above the 220 MHz band display. You must press this button before you can transmit on the 220 MHz band and before many of the other keyboard buttons will have any affect on the 220 MHz band.

DC IN (External Power Connector) — Provides a connection for external power (not for charging the battery).

NOTES:

1. Make sure the Transceiver is off while you connect or disconnect from this connector.
2. Make sure the external source supplies between 6 and 16 volts DC. Use caution when you use an automobile battery. Some automobile systems produce spikes that could exceed this range, and could damage the Transceiver
3. Be sure to observe the correct polarity.

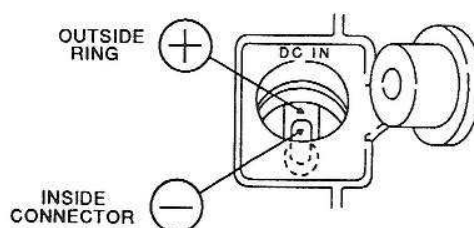

BATTERY PACK — Standard battery pack. Several different battery packs are available for this Transceiver. Refer to "Available Accessories" on Page VI.

BATTERY PACK LOCK BUTTON — Locks or releases the battery pack. Push this button upward while you slide the battery pack free from the Transceiver.

KEYBOARD — Allows you to enter many operating parameters. Labels printed in white indicate a key's operation when it is pressed by itself, while blue labels indicate the key's operation when it is pressed along with the FUNC (Function) button. (Think of this as being like the Shift function on a typewriter or computer keyboard.) The keys labeled in red are active only while the PTT button is pressed and transmit DTMF (dual-tone modulated-frequency) tones.

DISPLAY — Indicates the operating frequency, channel step, special functions (such as paging, coded squelch, tone squelch, frequency lock, PTT lock, and + or - transmitter shift), memory address number, memory mode, scanning,

shift frequency, receiver signal strength, tone frequency, and high, medium, or low transmitter output for each band, and shows which band is currently selected.

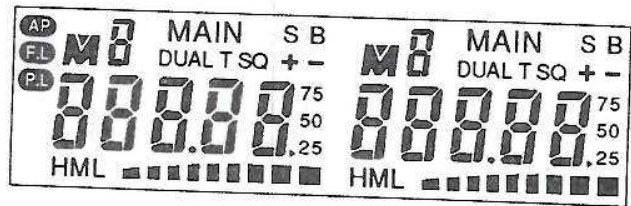

SPEAKER — Location of the built-in speaker.

MICROPHONE — Location of the built-in condenser microphone.

RESET Switch — Resets the Transceiver's internal microprocessor. This switch is normally only used after the internal lithium battery has been replaced. NOTE: Pressing this switch clears the memory and returns all operating parameters to their original default settings.

Operating Characteristics

Occasionally, you may experience interference in the 220 MHz band while you are transmitting in the 144 MHz band. This occurs when 220 MHz frequency is approximately three times the 144 MHz frequency. To avoid this problem, try to avoid using frequencies that are multiples of each other.

Short high-pitched beep . . .	Proper operation.
Long high-pitched beep . . .	A particular operation has been performed properly.
Short low-pitched beep . . .	Improper operation or an incorrect key entry.
Five short beeps	Auto-Power Off is operating, or a signal has been received during pager operation.
Three long beeps	A signal has been transmitted during pager operation.
Short puff sound	A function has been canceled, or the Transceiver has returned to the initial setting.

Changing VFOs

Your Transceiver contains two separate 144 MHz band and 220 MHz band VFOs. The VFO for the 144 MHz band is initially set to 146.00 MHz, while the VFO for the 220 MHz band is initially set to 222.10 MHz. Many key entries only affect the VFO that has been selected by pressing the 144 MHz and 220 MHz button that is located just below the display. In addition, the Transceiver will only transmit on the selected band. "MAIN" will appear above the display for the VFO that has been selected.

To change VFOs, just press the appropriate 144 MHz or 220 MHz button.

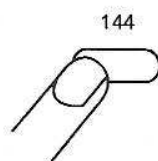

Selects the 144 MHz band

OR

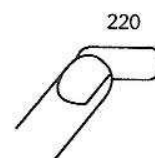

Selects the 220 MHz band

Setting the Operating Frequency

You can use the ROTARY CHANNEL SELECTOR, the keyboard, or the ▼ and ▲ buttons to set the operating frequency. To use any of these methods:

1. Press the 144 MHz band or 220 MHz band button (to select the appropriate band VFO).
2. If there is an "M" on the display above the left-most digit of the frequency display, press V/M to enter the VFO mode (the "M" will extinguish).

To use the keyboard, press the 0 through 9 buttons to select the frequency you desire (beginning with the 1 MHz digit). If you wish to use 146.52 MHz, for example, enter 6 5 2. The corresponding digits of the display will successively indicate your entries.

If you wish to easily change the 10 MHz digit (4-digit entry), press FUNC + SET and then FUNC + FL. Repeat this procedure to return to 3-digit entry. Refer to "10 MHz Keyboard Entry" on Page 2-67 for more information.

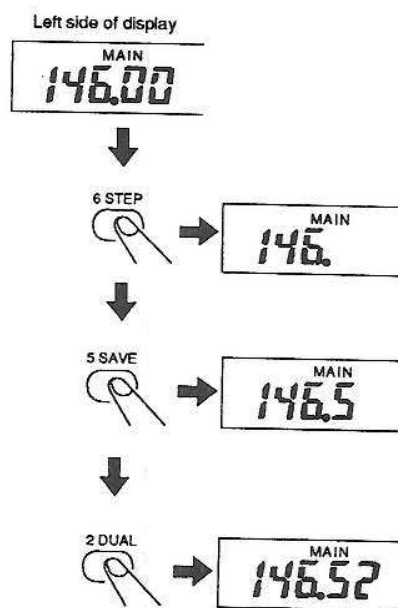

To use the ROTARY CHANNEL SELECTOR, rotate the knob clockwise to increase the frequency or counterclockwise to decrease the frequency, until you obtain the frequency you desire. This knob changes the frequency in 5 kHz steps. Refer to "Changing the Frequency Step" on Page 2-50 for information about changing the frequency step rate to 10 kHz, 12.5 kHz, 20 kHz, 25 kHz, or 50 kHz. For normal operation, set the step to 5 kHz.



To change the frequency in 100 kHz steps, hold down the FUNCTION button while you turn the ROTARY CHANNEL SELECTOR.

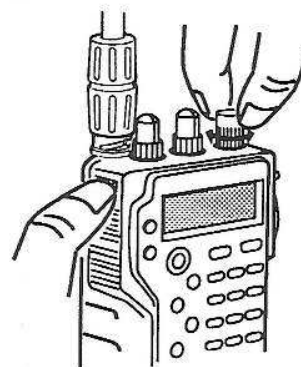

To use the ▼ and ▲ buttons, hold the appropriate button down until you obtain the desired frequency.

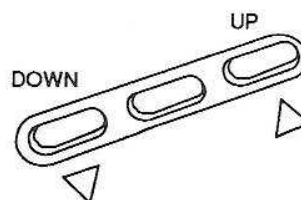

REPEATER OPERATION

In a normal simplex (nonrepeater) communication, your receiver and transmitter are set to the same frequency.

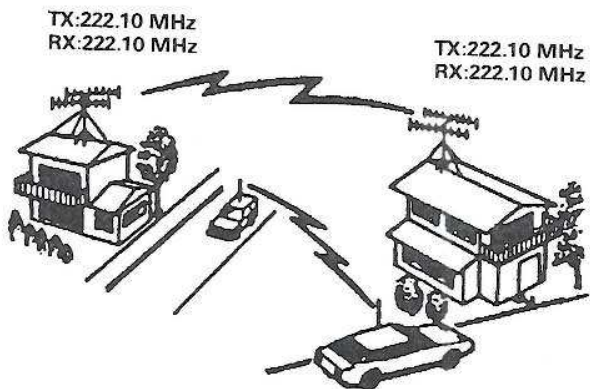

Repeaters (automatic relay stations), which are usually located on a high building or tower, allow you to communicate over longer distances than you can during simplex operation. This is particularly true when either your station or the other station (or both) are mobile stations. One of the major differences from your Transceiver's standpoint is that the transmitter and receiver are set to different frequencies. Normally, your transmitter should operate on the frequency that is 600 kHz (for the 144 MHz band) or 1.6 MHz (for the 220 MHz band) away from the receiver frequency. This transmitter offset may be above or below the receiver frequency, depending upon the particular repeater. Your Transceiver was preset at the factory for -600 kHz and 1.6 MHz.

NOTE: If you attempt to transmit outside of the U.S. amateur bands, the PTT button will be disabled and the display will indicate "OFF".

Enabling Repeater Operation

To setup your Transceiver for repeater operation, perform the following steps:

1. Select the desired band. The accompanying drawing shows the 144 MHz band; use the same procedure for the 220 MHz band.
2. Set the desired (receiver) operating frequency. NOTE: This is the repeater's transmit frequency.
3. Press RPT (FUNC + RPT). A "T" and a "-" will appear above the display. This indicates that the tone encoder is enabled and the transmitter offset is below the receiver frequency. NOTE: The optional tone encoder Model CTN520 must be installed before the tone encoder will actually work.
4. If you want the transmitter to operate above the receiver frequency, press RPT (FUNC + RPT). The "-" will change to "+", and the "T" will still be displayed.

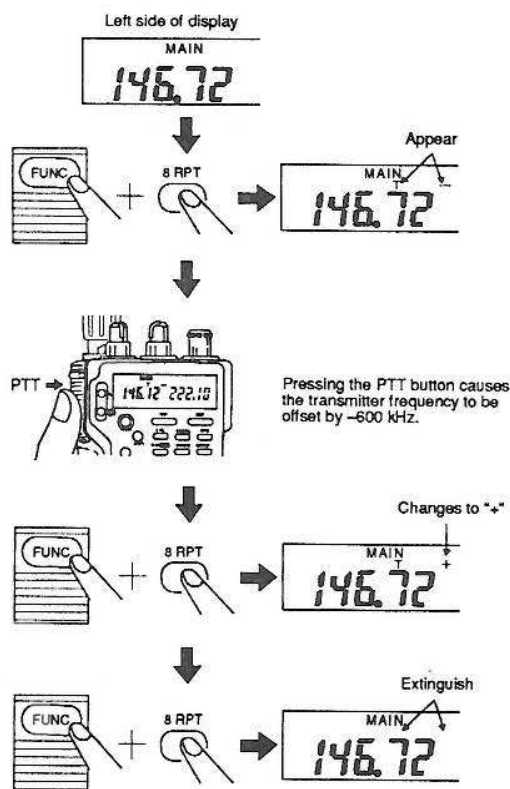

5. To return to simplex operation, press RPT (FUNC + RPT). The "T" and "+" will extinguish. NOTE: If the Transceiver is set for a "-" offset, you will have to press these keys twice to cancel repeater operation.

Changing the Offset Frequency

Your Transceiver was factory preset for a -600 kHz offset on the 144 MHz band and a -1.6 MHz offset on the 220 MHz band. The following steps show you how to change these presets.

NOTE: Offset frequencies must be between 0.000 and 39.995 MHz.

1. Select the desired band. NOTE: This example assumes that you are changing the 144 MHz band. Use the same procedure for the 220 MHz band.
2. Press SET (FUNC + SET). The frequency display will extinguish.

3. Press the RPT button (by itself). The display will indicate the current offset.
4. Use the ROTARY CHANNEL SELECTOR, the numeric buttons, or the ▼ and ▲ buttons to set the desired offset. Disregard any "-" or "+" indicator at this time. NOTE: If you use the numeric buttons to enter the offset, you will have to use the ROTARY CHANNEL SELECTOR or the ▼ and ▲ buttons to set the kHz digit to 5 kHz (such as 605 kHz).
5. Press the V/M button to return to the normal display.
6. If you wish to change the offset direction, press RPT (FUNC + RPT). Each press of this combination of buttons alternates between a negative shift ("-"), positive shift ("+"), and no shift (cancels repeater operation).

NOTE: If you attempt to transmit on 144 MHz band when the transmitter offset is set to a frequency that is outside of the amateur band, the PTT button will not key the transmitter.

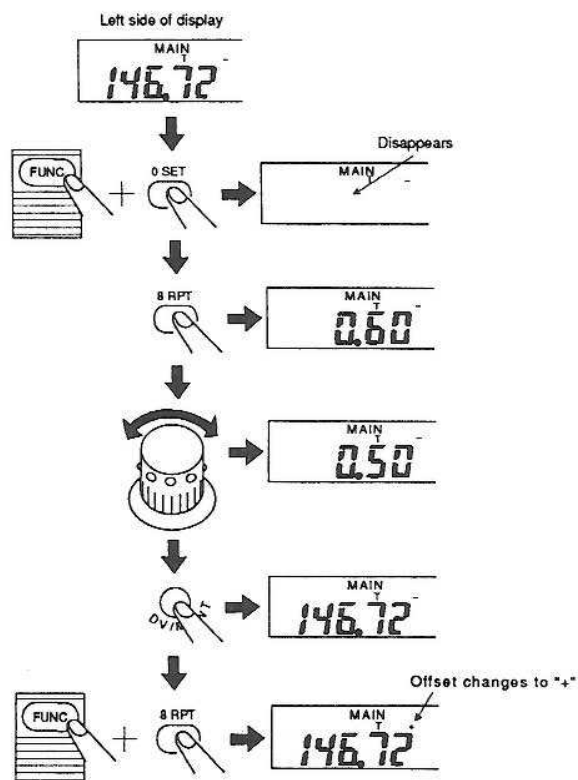

Changing the Tone frequency

Your Transceiver was factory preset for a 88.5 Hz tone on the 144 MHz and 220 MHz bands. The following steps show you how to change these presets.

NOTE: Even though you can change the displayed tone frequency, you must have the optional CTCSS tone squelch unit installed in your Transceiver before the tone squelch function will work.

1. Select the desired band. **NOTE:** This example assumes that you are changing the 144 MHz band. Use the same procedure for the 220 MHz band.
2. Press SET (FUNC + SET). The frequency display will extinguish.
3. Press the T.SQ button (by itself). The display will indicate the current tone frequency.

4. Use the ROTARY CHANNEL SELECTOR or the ▼ and ▲ buttons to select the desired tone. Table 2-1 shows the 38 available tones.
5. Press the V/M button to return to the normal display.

Table 2-1

AVAILABLE TONE FREQUENCIES (in Hz)			
67.0	97.4	136.5	192.8
71.9	100.0	141.3	203.5
74.4	103.5	146.2	210.7
77.0	107.2	151.4	218.1
79.7	110.9	156.7	225.7
82.5	114.8	162.2	233.6
85.4	118.8	167.9	241.8
88.5	123.0	173.8	250.3
91.5	127.3	179.9	
94.8	131.8	186.2	

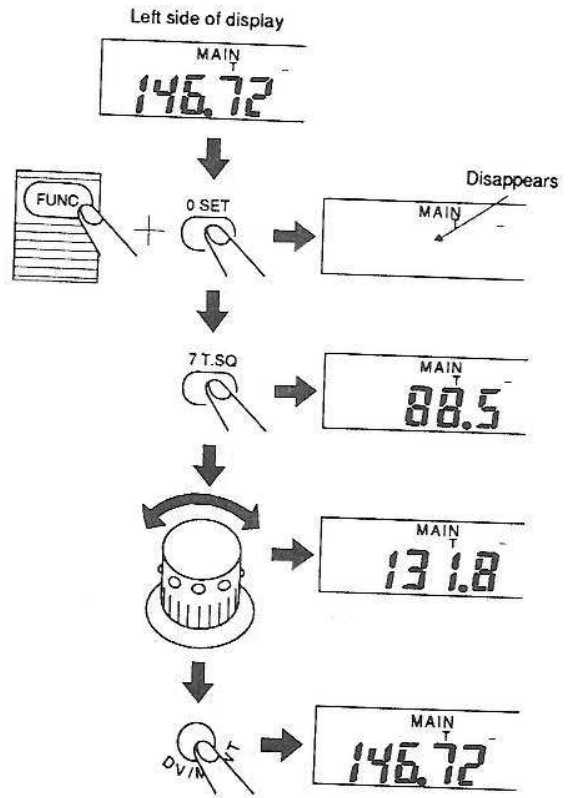

Swapping Transmit and Receive Frequencies

If you wish to interchange your transmitter and receiver frequencies during repeater operation, perform the following steps:

1. Press REV (FUNC + REV). The display will now indicate the former transmitter frequency and, when you press the PTT button, the display will indicate the former receiver frequency. In addition, the “-” or “+” indicator will blink to indicate that the Transceiver is in the reverse mode.
2. To return to normal operation, press REV (FUNC + REV) again.

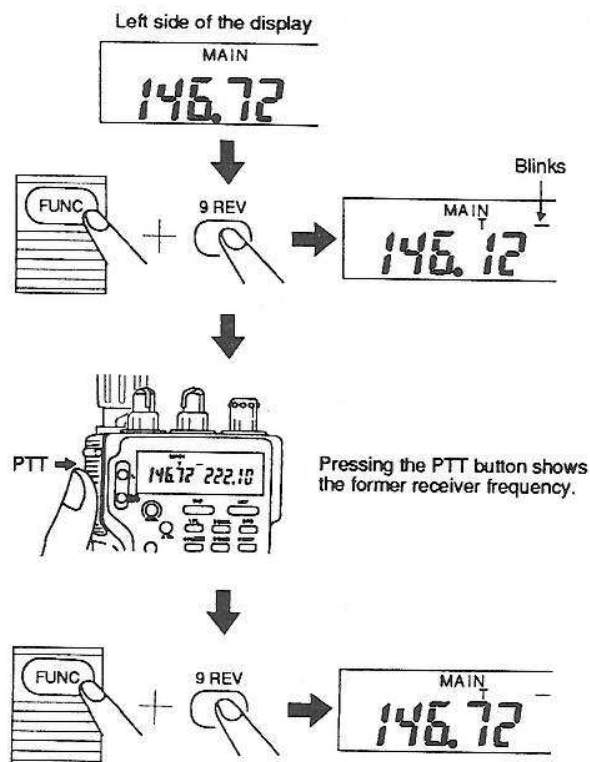

MEMORY FUNCTIONS

Your Transceiver has provisions for twenty memory frequencies, 10 in the 144 MHz band and 10 in the 220 MHz band. You can easily recall, change, and scan these frequencies.

Each memory location is assigned a memory address number. The memory address numbers for each band are M0 through M9. The V/M button allows you to alternate between the VFO and memory modes.

Placing Frequencies in Memory

To place the frequency 146.61 in memory location M1 of the VHF band (assuming memory location M1 is empty at this time), for example, perform the following steps:

1. Press the 144 button.
2. Set the VFO frequency to 146.61.

3. Press ENT (FUNC + ENT). A letter "M" will appear above the frequency display.
4. Press the 1 button to write the frequency into memory location 1. A long beep indicates that the memorization is complete. In addition, a "1" will appear on the display next to the "M" to indicate that the Transceiver is in the memory mode and the frequency is now stored in M1. The stored frequency is referred to as the memory frequency.
5. Press V/M to return to the VFO mode.
6. Use the same procedure to store frequencies in other memory locations. In addition, you can store frequencies in the 220 MHz band locations by first pressing the 220 button.

NOTE: Refer to "Expanding the Memory" (Page 2-74) for information about increasing the memory to 40.

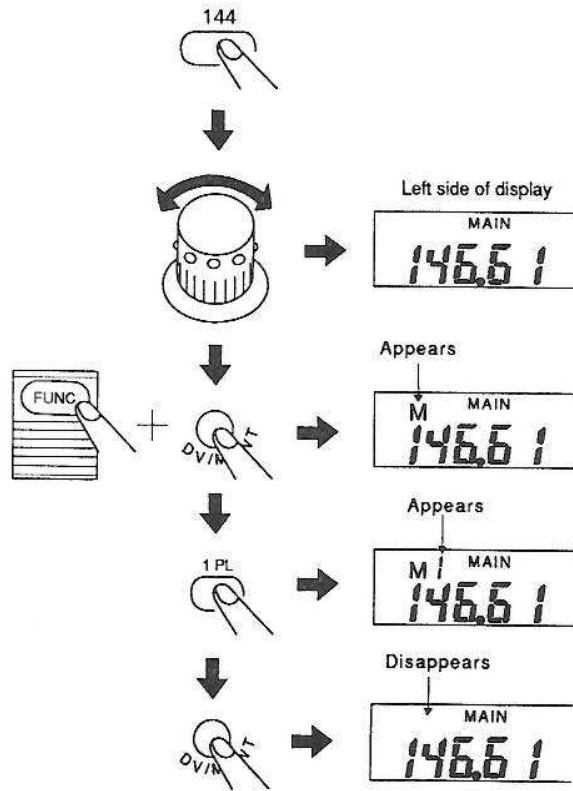

Recalling a Memory Frequency

To recall a frequency that has already been placed in memory M1 of the 144 MHz band, for example, perform the following steps.

1. Press the 144 button to select the 144 MHz band, if this has not already been done.
2. Press the V/M button, if the Transceiver is not already in the memory recall mode. NOTE: An "M" above the frequency display indicates that the Transceiver is in the memory mode. The memory address that you selected last and its corresponding frequency will appear on the display (if the memory address is empty, the "M" will blink).
3. Use the ROTARY CHANNEL SELECTOR, the numeric keyboard buttons, or the ▼ and ▲ buttons to select memory address M1. The frequency that was previously stored in M1 will appear on the display.

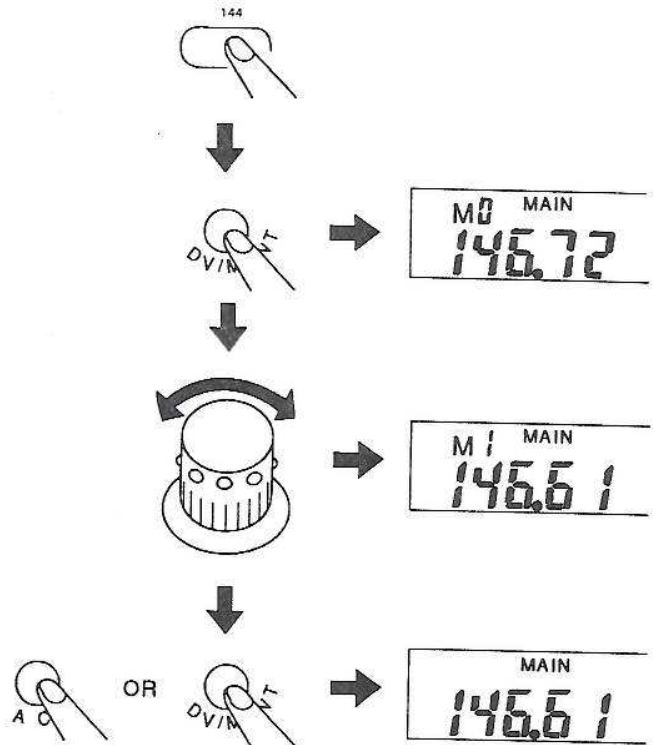

There are now two ways you can return to the VFO mode. Pressing the CL button will re-enter the VFO mode, but the memory frequency will remain on the display. Pressing the V/M button will also re-enter the VFO mode, but the display will return to the previous VFO frequency.

NOTES:

1. If you desire to select a different memory address while the Transceiver is in the memory mode, just turn the ROTARY CHANNEL SELECTOR, press the desired numeric keyboard button, or use the ▼ and ▲ buttons.
2. When you select a memory address that does not yet contain a frequency, the "M" on the display will blink and the VFO frequency will be displayed.

Changing a Memory Frequency

Any time you enter a new frequency into a memory location, the old frequency is deleted.

To change the frequency in 144 MHz band memory address M1 from 146.61 MHz to 145.47 MHz, for example, perform the following steps:

1. Press the 144 button to select the 144 MHz band, if this has not already been done.
2. Press the V/M button, if the Transceiver is not already in the VFO mode (the "M" above the display should not be displayed).
3. Use the ROTARY CHANNEL SELECTOR, the numeric keyboard buttons, or the ▼ and ▲ buttons to set the VFO frequency to 145.47 MHz.

4. Press ENT (FUNC + ENT).
5. Press the 1 button. The long beep indicates that the new frequency is now stored in memory location M1, replacing the previous frequency.
6. Press the CL button if you wish to return to the VFO mode and retain the memory frequency on the display.

NOTE: You can use this same procedure to change memory frequencies in the 220 MHz band memories by selecting the 220 MHz band instead of the 144 MHz band (Step 1).

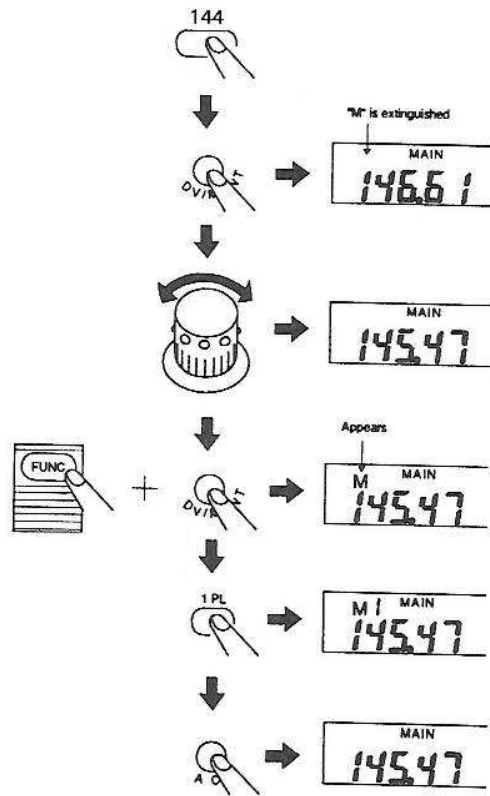

Deleting a Memory Frequency

If you wish to delete the frequency that is stored in VFO memory address M1, for example, perform the following steps:

1. Press the 144 button to select the 144 MHz band, if this has not already been done.
2. Press the V/M button to enter the memory recall mode (the "M" above the display should be showing). The memory you selected last will appear on the display.
3. Press the 1 button to select memory M1.

NOTE: Deleting memory frequencies does not change any other parameters that may have been stored in the particular memory location (such as repeater function, transmitter offset, tone function, and tone frequency). If you wish to return these parameters to their default values, perform steps 3 through 6. If you do not care how these parameters are set, skip steps 3 through 7 and proceed to step 8.

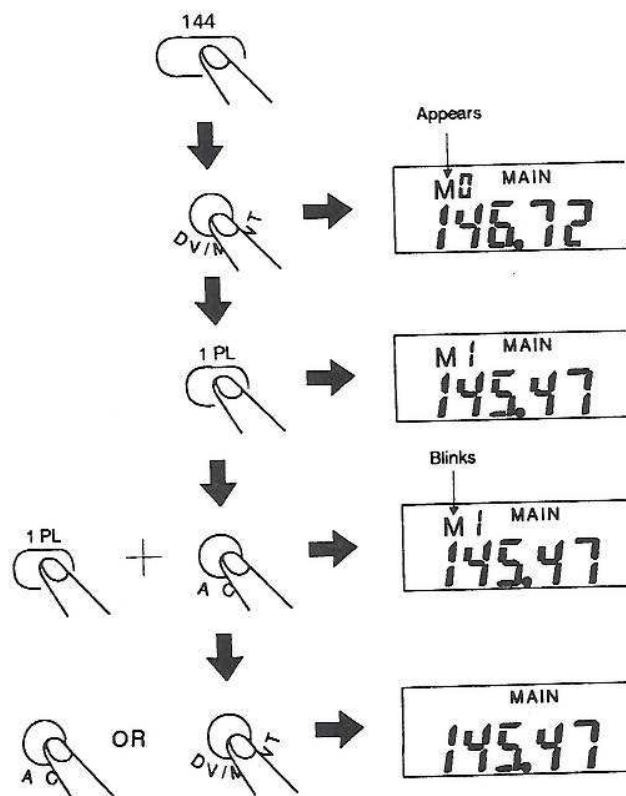

4. If a "+" or "-" appears on the display, the repeater function is enabled. Press RPT (FUNC + RPT) two or three times until the "T", "+", and "-" are all extinguished. This cancels repeater and tone operation.
5. If only a "T" or "T.SQ" appears on the display, the tone function is enabled. Press T.SQ (FUNC + T.SQ) one or two times until the "T" and "T.SQ" are extinguished. This cancels tone operation.
6. To return the offset frequency to its original value, Press SET (FUNC + SET). Then press the RPT button. The current offset frequency will appear on the display. Now use the ROTARY CHANNEL SELECTOR, the numeric keyboard buttons, or the ▼ and ▲ buttons to set the offset frequency to 0.60 MHz 1.6 MHz for the 220 MHz band). Then press the CL button to return to the memory mode.
7. To return the tone frequency to its original value, Press SET (FUNC + SET). Then press the T.SQ button. The current tone frequency will appear on the display. Use the ROTARY CHANNEL SELECTOR or the ▼ and ▲ buttons to set the tone frequency to 88.5 Hz. Then press the CL button.
8. Hold the 1 button down while you press the CL button. You will hear a long beep and the "M" on the display will begin to blink. This indicates that memory address M1 is now empty. The frequency that was on the display now becomes the VFO frequency, but the Transceiver remains in the memory recall mode.
9. Press the CL or V/M button to return to the VFO mode.

Storing Repeater Operation in a Memory Location

All of the previous memory operations stored only simplex (nonrepeater) frequencies in memory. To store the repeater function in a memory location along with a frequency, perform the following steps:

1. Select the desired band and frequency.
2. Press the V/M button to enter the memory recall mode (the "M" above the display should be showing).
3. Select the memory address where you wish to store the repeater mode.
4. Press RPT (FUNC + RPT). "T" and "-" will appear on the display. The tone frequency will be 88.5 Hz and the transmitter offset will be -0.60 MHz (on the 144 MHz band) or -1.6 MHz (on the 220 MHz band). Refer to "Changing the Repeater Mode Tone and Offset Frequencies in Memory" (Page 2-26) if you wish to change these parameters.

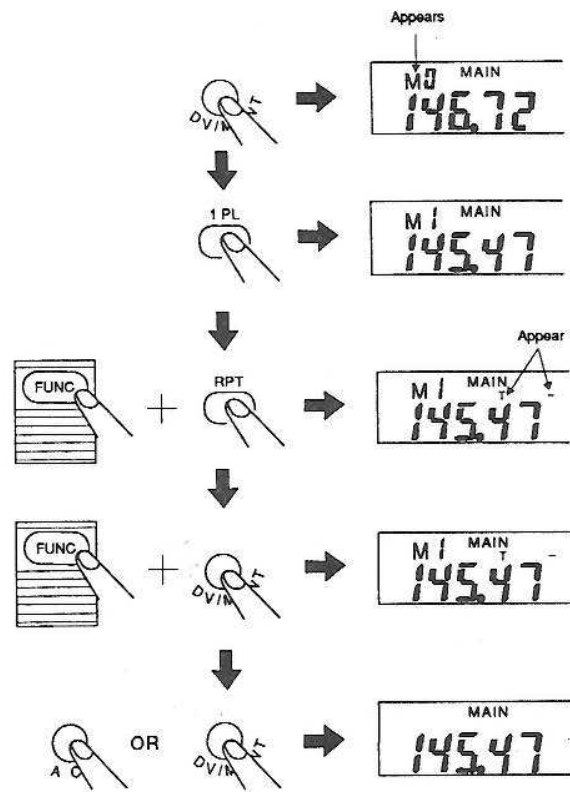

5. Press ENT (FUNC + ENT).
6. Press the CL or V/M button to return to the VFO mode.

Canceling Repeater Operation in a Memory Location

To cancel repeater operation that has been stored in a particular memory location, perform the following steps:

1. Recall the memory address number where you wish to cancel repeater operation.
2. Press RPT (FUNC + RPT) two or three times until the "+", and "-" indicators extinguish. This cancels repeater operation. NOTE: Any "T" or "T.SQ" indicators will also extinguish.
3. Press the CL or V/M button to return to the VFO mode.

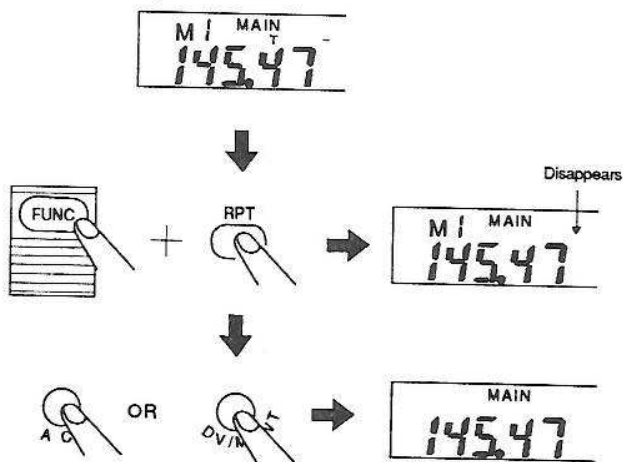

Storing Tone Squelch Operation in a Memory Location

To store the tone squelch function in a memory location along with a frequency, perform the following steps:

1. Recall the memory address number where you wish to store tone squelch operation.
2. Press T.SQ (FUNC + T.SQ) **twice**. "T.SQ" will appear above the display and tone squelch operation will be stored in the present address location. The tone frequency will be 88.5 Hz. Refer to "Changing the Repeater Mode Tone and Offset Frequencies in Memory" (Page 2-26) if you wish to change the tone frequency.
3. Press the CL or V/M button to return to the VFO mode.

NOTE: Even though you can set tone operation, you must have the optional Tone Squelch Accessory, Model CTN520, installed in your Transceiver before tone squelch operation will actually work.

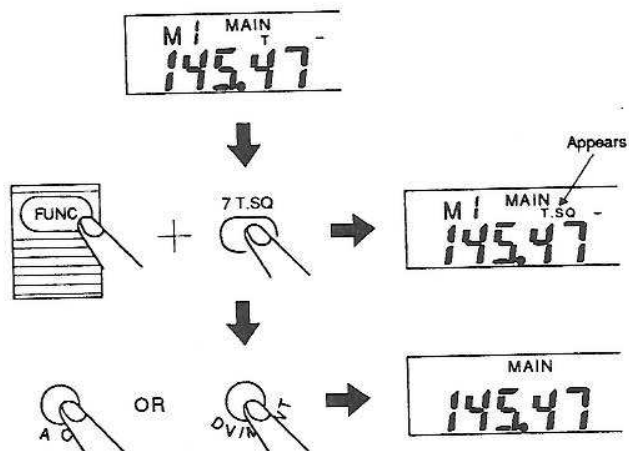

Temporarily Changing Frequency During Memory Recall Mode

This function allows you to change the frequency and initiate a new communication while you are using the memory recall mode, without canceling the memory recall mode.

1. While the Transceiver is in the memory recall mode, press SFT (FUNC + SFT). The memory location number will blink.
2. Turn the ROTARY CHANNEL SELECTOR, use the numeric keyboard buttons, or use the ▼ and ▲ buttons to select the new VFO frequency.

NOTE: You can now use the PTT button to communicate as you normally would.

3. Press the CL button when you wish to return to the previously-recalled memory frequency. NOTE: If you decide to change the frequency in the present

memory location with the new frequency, press ENT (FUNC + ENT) instead of the CL button.

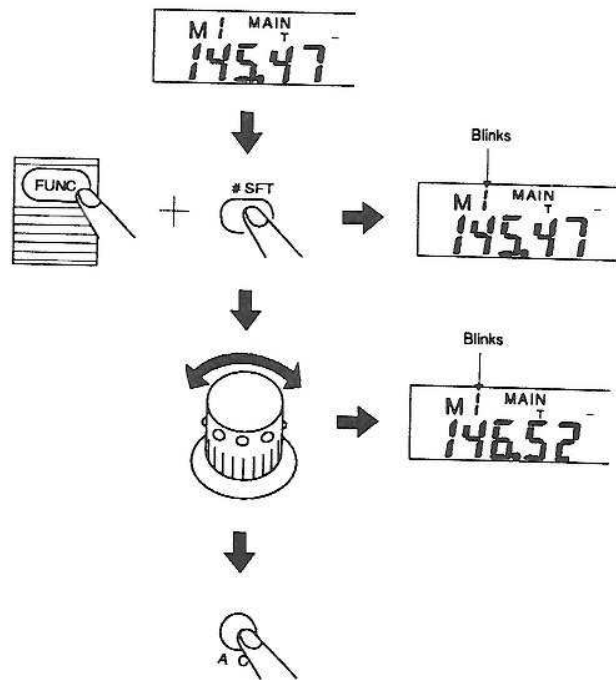

SCANNING FUNCTIONS

You can make your Transceiver scan in the VFO mode or the memory mode, or it can scan tone frequencies. No matter which mode you choose, the Transceiver can perform a pause scan or a busy scan. Your Transceiver is initially set to pause scan.

Pause scan causes scanning to stop when it receives a signal. Scanning will then resume five seconds later or about one second after the signal disappears, whichever occurs first.

Busy scan also causes scanning to stop when it receives a signal, but scanning does not resume until about two seconds after the signal disappears.

While scanning, press the SB button to alternate between pause scan and busy scan. A short high-pitched beep sounds to indicate when busy scan is enabled, and a low-pitched beep indicates when pause scan is enabled. In addition, a "B" appears on the display to indicate when busy scan is enabled.

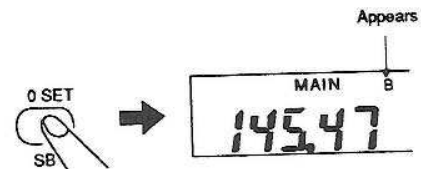

VFO-Frequency Scanning

This scanning mode can perform a 1 MHz scan, all-band scan, or a programmed scan. The 1 MHz scan function causes the Transceiver to scan within a specified 1 MHz range of frequencies. All-band scan causes the Transceiver to scan its entire frequency range. Programmed scan searches all frequencies between two specified frequencies.

NOTES:

1. There are no indicators on the display to distinguish between 1 MHz scan and programmed scan.
2. Pressing the ▼ or ▲ button during scanning temporarily inhibits scanning (pause mode). Pressing the button again resumes scanning.
3. You can use the ▼ and ▲ buttons to change the direction of scanning.

4. You can increase or decrease scanning speed by holding down the ▼ or ▲ button for 1/2 second or longer.

1 MHz Scan — To start the 1 MHz scan function, first select the desired band. Then press PS (FUNC + PS). During scanning, the decimal point on the display will blink. Press the CL button when you wish to cancel scanning.

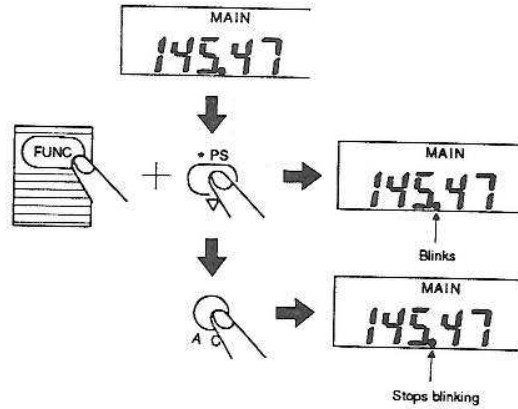

All-Band Scan — To start the all-band scan function, first press the CALL button. Then press PS (FUNC + PS). During scanning, the decimal point on the display will blink. Press the CL button when you wish to cancel scanning.

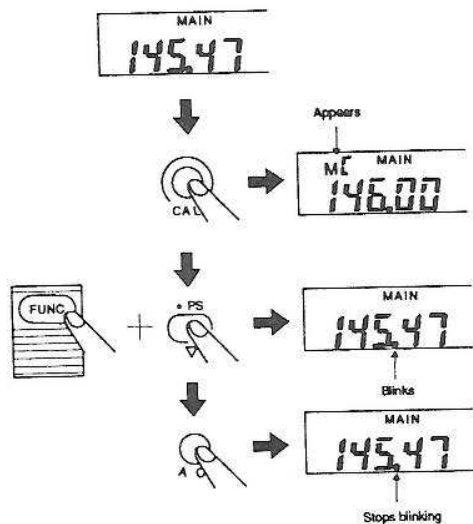

Programmed Scan — This function allows you to scan between two frequencies that you store in memory. To start programmed scan, perform the following steps:

1. Select the desired band.
2. Store the start and stop frequencies in any two memory locations.
3. Press the V/M button to enter the memory recall mode. An "M" will appear above the frequency display.
4. Use the ROTARY CHANNEL SELECTOR, numeric keyboard buttons, or the ▼ and ▲ buttons to select the memory address that contains the frequency where you wish scanning to start.
5. Press PS (FUNC + PS). The memory address number on the display will blink.

6. Use only a numeric keyboard button to select the memory address that contains the frequency where you wish scanning to end. Programmed scan will begin immediately when you press this button.

7. Press the CL button to cancel scanning.

NOTE: If the start frequency is higher than the end frequency, programmed scan will scan in a downward direction. If the start frequency is 146.82 MHz and the end frequency is 145.93 MHz, for example, scanning will occur as follows: 146.82, 146.80, 146.78, etc.

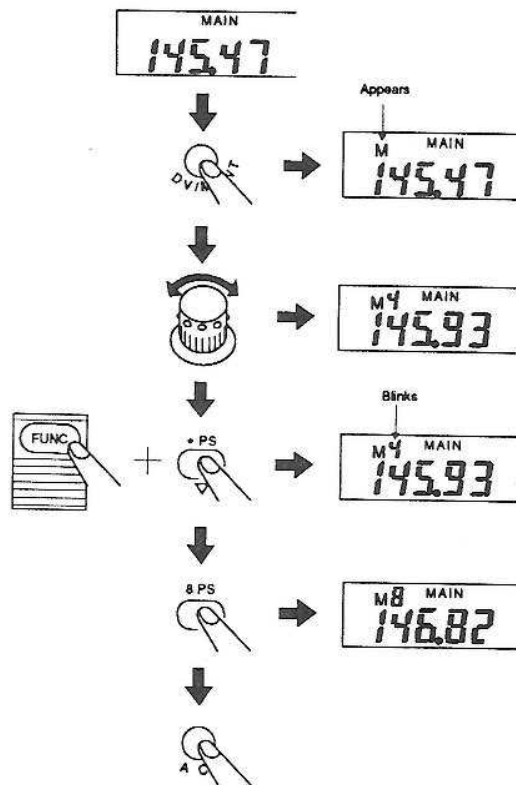

Memory-Frequency Scanning

This scanning mode allows you to scan all memory addresses (that contain frequencies) or only selected memory addresses. These functions are described separately below.

All-Memory Scan — This function allows you to scan memory addresses M0 through M9. Only those memory addresses that contain frequencies will be scanned. Perform the following steps to start an all-memory scan:

1. Select the desired band.
2. Press the MS button to begin memory scanning.
3. Press the MS button again when you wish to cancel memory scan. **NOTE:** If you press the V/M button during memory scanning, the Transceiver will enter the VFO-mode. The frequency that appeared on the display before memory scanning occurred will be displayed.

Memory scanning during the battery-save mode scans one memory frequency per second and receives it only intermittently (200 milliseconds each).

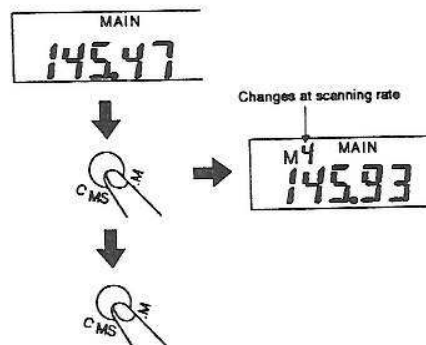

Selected-Memory Scan — The MS.M (memory scan memory) function allows you to scan only specific memory frequencies. To use the selected memory function, perform the following steps:

1. Select the desired band.
2. Press the V/M button to enter the memory recall mode. An "M" will appear above the frequency display.
3. Select one of the memory addresses you wish to scan.
4. Press MS.M (FUNC + MS.M). A "▼" will appear above the "M" to indicate that this memory address will be scanned.
5. Repeat steps 3 and 4 for each memory address you wish to scan.

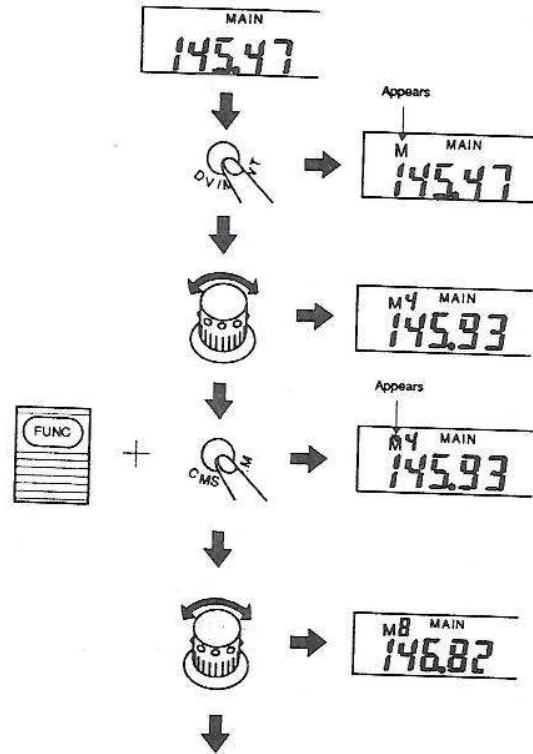

Continued on next page

6. Press the MS button to begin an all-memory scan.
7. Press MS.M (FUNC + MS.M) to begin scanning selected memory frequencies.
8. When you wish to return to all-memory scan, press MS.M (FUNC + MS.M) again.
9. Press the CL button to cancel scanning.

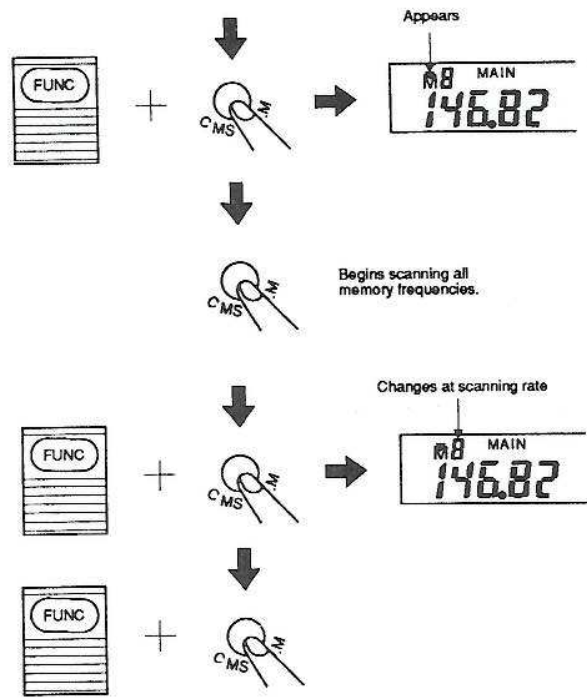

NOTE: Once you have specified certain memories for scanning, you can use the following procedure to quickly jump from the VFO mode to the selected-memory scan function:

1. From the VFO mode, press MS.M (FUNC + MS.M). A "▼" will appear on the display above the location where the "M" would normally appear (the "M" will not appear, however).
2. Press the MS button to begin scanning.

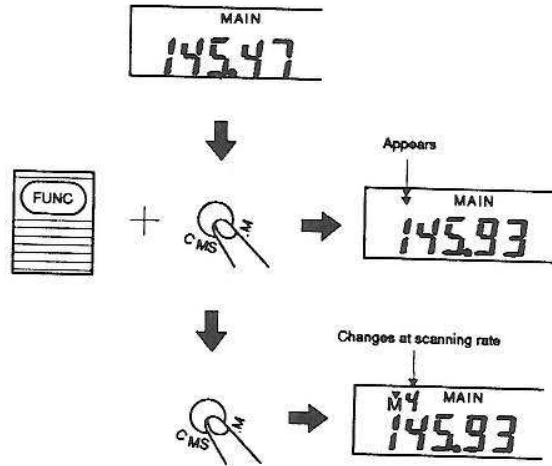

Tone-Frequency Scanning

This function allows you to sequentially scan all 38 tone frequencies during tone squelch operation. This feature allows you to use the tone squelch and scan functions to determine another station's tone squelch frequency. When the Transceiver detects a valid tone frequency, scanning will stop and display the tone frequency. To use this function, perform the following steps.

NOTE: Even though you can set tone operation, you must have the optional Tone Squelch Accessory, Model CTN520, installed in your Transceiver before tone squelch operation will actually work.

1. Select the desired band and frequency.
2. Press T.SQ (FUNC + T.SQ) twice so that "T.SQ" appears on the display.
3. Press SET (FUNC + SET) to enter the set mode.
4. Press the T.SQ button (by itself) to display any tone frequency.
5. Press PS (FUNC + PS). The Transceiver will begin scanning tone frequencies.
6. If you prefer pause scan instead of busy scan, press the SB button.
7. Press the CL button when you wish to cancel tone-frequency scanning.

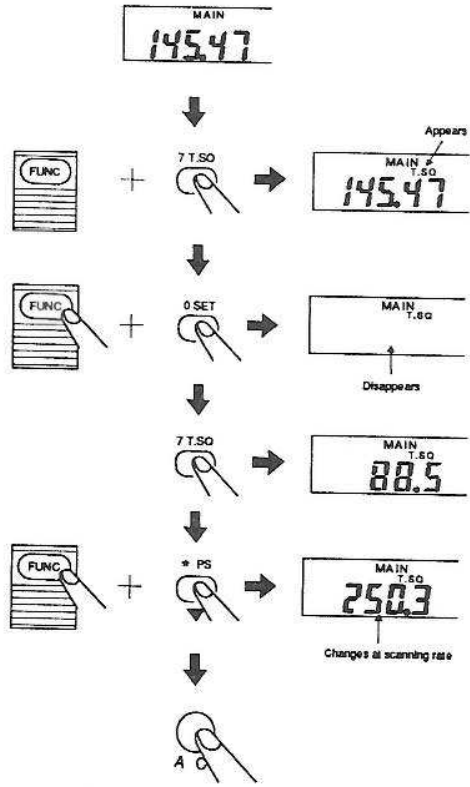

PAGING AND CODED SQUELCH FUNCTION

This feature allows you to use the DTMF tone of your Transceiver to page a specific station (individual paging) or all stations within a group (group paging).

NOTES:

1. The individual and group codes are formed by three digits (0 through 9) of DTMF tones and all three digits are referred to as the "code".
2. Be sure to program each station with an individual code and a group code, as described on the following pages, before you attempt to use this feature. The paging function is available only when the associated stations have been properly programmed.

The following information assumes that stations A through D will be programmed with individual codes and group codes as shown in Figure 2-3.

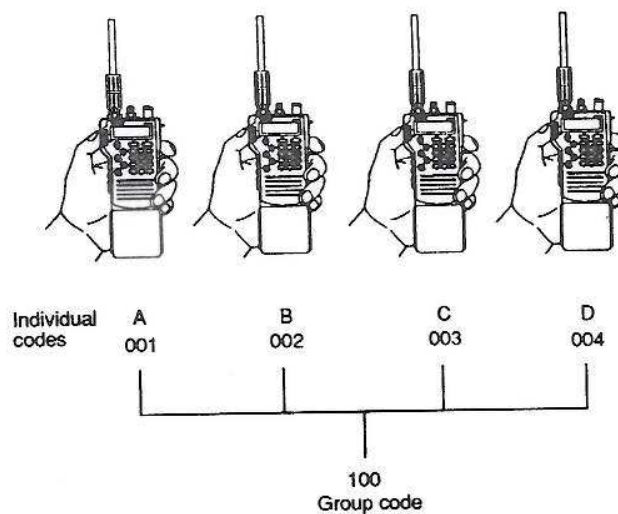

Figure 2-3

Preparation for Paging

This section shows you how to program an individual code and a group code. The individual and group codes must consist of three digits, and the group code must be the same for all members of the group.

To program individual code 001 for code memory address M3 and group code 100 in M2, for example, perform the following steps.

1. Select the desired band.
2. Press CODE (FUNC + CODE). The frequency display will be replaced with "C000". In addition, a "0" will appear above the "C" to indicate memory address 0 (an "M" does not appear on the display for code memory addresses). NOTE: This is referred to as the code-display mode.
3. Turn the ROTARY CHANNEL SELECTOR or press the ▼ or ▲ buttons until 3 appears at the top of the display. This sets the memory address to M3.
4. Press numeric keyboard buttons 0, 0, 1. When you enter the last digit, you will hear a long beep to indicate that programming of the individual code is complete.
5. Turn the ROTARY CHANNEL SELECTOR or press the ▼ or ▲ buttons until 2 appears at the top of the display. This sets the memory address to M2.

Code memory addresses M0 through M6 are used by the paging functions as shown in Table 2-2 (Page 2-42). You can display these in succession by turning the ROTARY CHANNEL SELECTOR (the initial setting is C000).

6. Press numeric keyboard buttons 1, 0, 0. When you enter the last digit, you will hear a long beep to indicate that programming of the group code is complete.
7. Press FL (FUNC + FL). A "▼" will appear to the left of the memory address number to indicate that this is the programmed group code.

NOTE: The individual code must always be programmed in memory address M3. The group code, however, can be programmed in any memory address, except M0 and M3, and the "▼" must be added to the group code address. Group code paging will not work if the "▼" is not added to the group code.

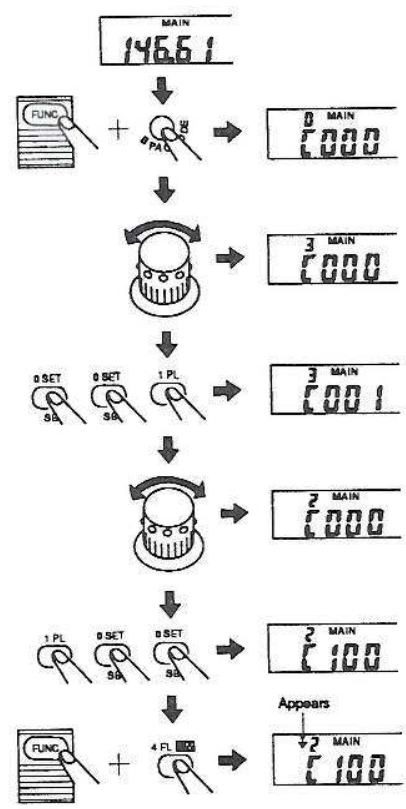

Table 2-2

Memory	Paging Function*
0	Memory address for storing the individual code of the calling paging function when your Transceiver is being paged. During paging, the individual code of the calling station is automatically stored here and appears on the display. Pressing the PTT button during this condition transmits the code that is being displayed.
1	Memory address for storing the group code of your Transceiver. The group code standby mode is enabled when the "▼" mark is displayed.
2	The 1 or 2 or 4 code is transmitted during communication.
4	The "▼" mark indicates the memory address where the group code is programmed. It is possible to set more than one "▼" mark.

* The set code and your station code are transmitted.

To better understand the paging function, assume that the memories in your Transceiver are programmed as shown below:

<u>Memory Number</u>	<u>Code</u>
M0	—
M1	123
▼M2	234
M3	345 (your individual code)
M4	456

In this example, your station can receive the paging signal by any of the codes except 123 and 456. If ▼ marks are added to all of the addresses, except M3, your Transceiver enters the receive standby mode for four codes.

When your Transceiver is paged with code 234, "▼ 2 C234" will appear on your display. This indicates that you have been paged with group code 234.

If your Transceiver is paged with code 345, "0 CXXX" appears to indicate that you have been paged with your individual station code. XXX is the individual code of the calling station.

Paging a Station

Use the following procedure to page an individual station:

1. Program the individual code of the station you wish to page. If the code has already been programmed, select the code from memory.
2. Press CODE (FUNC + CODE).
3. Turn the ROTARY CHANNEL SELECTOR to display memory address Mx (x is a given number).
4. Press the V/M button to return to the VFO frequency.
5. Press the PAG button to enter the paging mode. A "P" will appear on the display. NOTE: Pressing PAG in the VFO mode displays a "P" in the 100 MHz digit of the display, pressing PAG a second time displays a "C" in the 100 MHz digit, and pressing PAG a third time returns the display to the VFO mode.

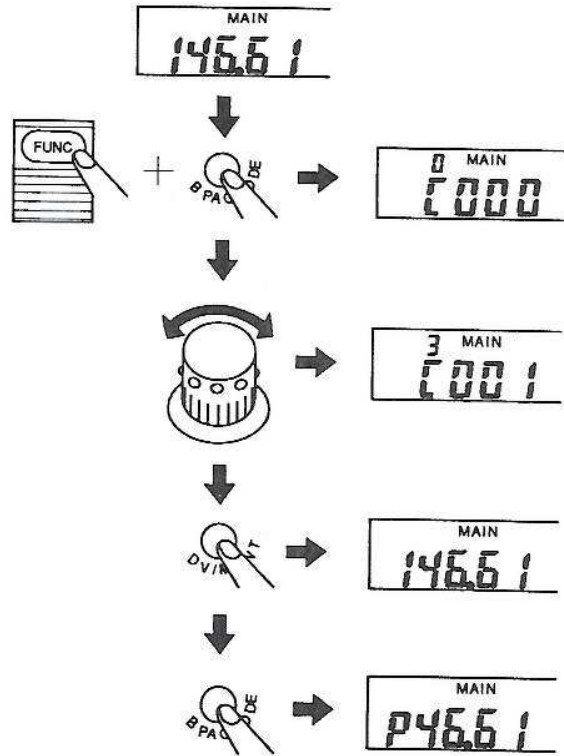

6. Press the PTT button. DTMF signals, consisting of the destination code followed by your own individual code, will be automatically transmitted like this:

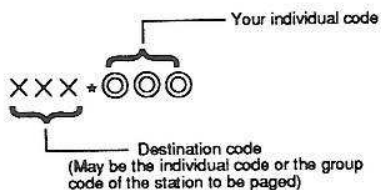

NOTE: Once the Transceiver begins to transmit the DTMF signal, you can release the PTT button; the Transceiver will continue to transmit the remaining part of the signal.

Example 1:

For this example, assume that stations A, B, and C are programmed as shown below:

Memory Address	A	B	C
0	—	—	—
1	234	123	123
2	345	345	234
3	123	234	345
4	▼100	▼100	▼100

Individual codes of the stations.
Group code.

When station A enters the paging mode, it displays memory address 4 and transmits the DTMF signal. Stations B and C will simultaneously receive this signal (group paging).

Assume that station A enters the paging mode, displays memory address 1, and transmits the DTMF signal. Only station B will now receive the signal (individual paging).

Example 2:

For this example, assume that stations A, B, and C are programmed as shown below:

Memory Address	A	B	C	
0	—	—	—	
1	234	123	123	
2	▼345	345	234	
3	123	234	345	Individual codes of the stations.
4	▼100	▼100	▼100	Group code.

When station A enters the paging mode, it displays memory address 4 and transmits the DTMF signal. Stations B and C will simultaneously receive this signal (group paging).

If station A enters the paging mode and begins receive standby, it can receive a page from any station using group codes 100 or 345, or individual code 123. This shows that station A can receive a page from several stations when the “▼” marks are added.

Receiving a Page

Use the following procedure to prepare your station to receive a page. The operating frequency should have already been selected.

1. Press the PAG button to activate the pager feature. A “P” will appear in the 100 MHz digit of the display.
2. When your Transceiver receives a paging code that matches one of its marked codes, it will generate five short beep tones and the “P” indication on the

display will start blinking. In addition, the frequency display will be replaced by the individual code of the calling station. "M0 Cxxx" will appear if your Transceiver was paged with its individual code, or a group code will appear when your Transceiver was paged with a group code. If you press the PTT button while the "P" is blinking, the individual code of your Transceiver will be transmitted to the calling station.

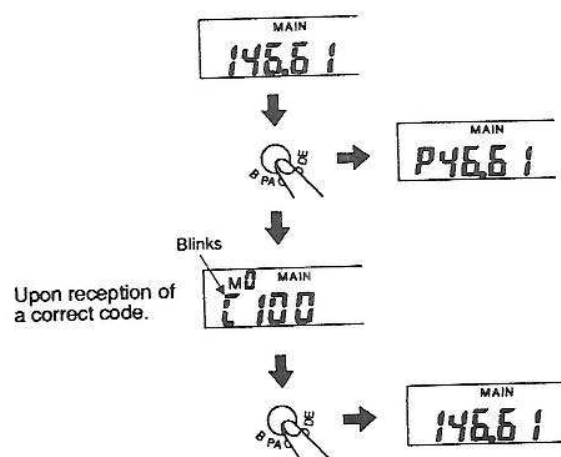

3. Press the PAG button twice to cancel the pager function so you can communicate normally.

NOTES:

1. Pressing the FUNCTION button by itself when you have been paged immediately stops the beeping sounds.
2. If reception is incomplete and the individual code of the paging station is not clear, an "E" and a previous code (from memory address P) will be displayed. When this happens, you cannot identify the paging station.



MISCELLANEOUS FUNCTIONS

Turning Off One Receiver

If you intend to use only one band (144 MHz or 220 MHz), you can use the following procedure to turn off the unused receiver.

1. Hold down the FUNCTION button while you press the band button that you wish to use. To turn off the 220 MHz band receiver, for example, hold down the FUNCTION button while you press the 144 MHz band button. The 220 MHz band display will extinguish and the 220 MHz band receiver will be disabled.

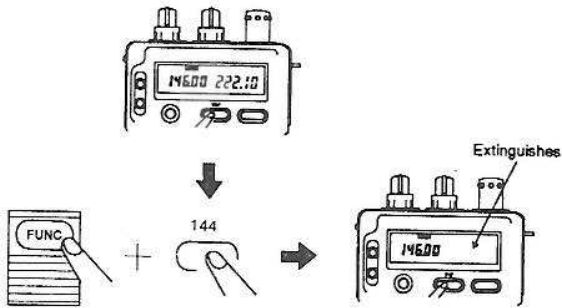

2. To again use the band that is disabled, press the band button that still appears on the display. If you press the other band button, the disabled band will also reappear, but the disabled band will become the new main band.

Dual-Watch

This function allows you to alternately monitor the VFO frequency and a memory frequency (M1 through M9) or the VFO frequency and memory-scan frequencies. NOTE: Dual-watch works only within the same band.

Use the following procedure to actuate the dual-watch function between the VFO frequency and a memory frequency:

1. Select the desired band.

NOTE: The following steps assume that one of the desired frequencies has already been stored in a memory address.

2. Enter the second frequency you wish to watch into the VFO. If you wish, you can press RPT (FUNC + RPT) to initiate repeater operation.
3. Press the V/M button to enter the memory-recall mode. The last-used memory frequency will appear on the display.
4. Turn the ROTARY CHANNEL SELECTOR until the memory address that contains the desired frequency is displayed.
5. Press DUAL (FUNC + DUAL). The two frequencies will now be alternately received. "DUAL" will appear on the display above the frequency indication.
6. If you wish to communicate on the memory frequency, press the V/M button twice to cancel dual-watch operation. Then communicate normally.
7. If you wish to communicate on the VFO frequency, press the CL button to cancel dual-watch operation. Then communicate normally.

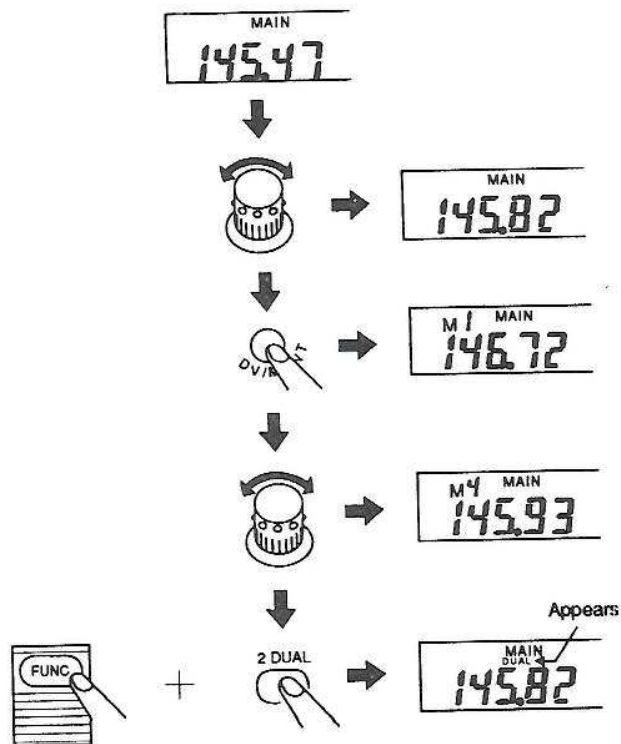

Use the following procedure to actuate the dual-watch function between the VFO frequency and memory scan frequencies:

1. Select the desired band.
2. Start the memory scan (or MS.M) mode.
3. Press DUAL (FUNC + DUAL). The Transceiver will now dual-watch between the VFO frequency and the frequencies that are scanned by memory (or MS.M) scan.
4. Press DUAL (FUNC + DUAL) again to cancel dual-watch operation.

NOTES:

1. When the Transceiver receives a signal on the memory frequency, dual-watch operation is temporarily suspended. When the signal disappears, dual-watch continues.

2. When the Transceiver receives a signal on the VFO frequency, dual-watch operation continues as before, but the memory frequency will still periodically be checked. NOTE: This causes the signal to be received intermittently.
3. Dual-watch checks the memory frequency every 3 seconds and the display will indicate its frequency.
4. Dual-watch will not work if a frequency is not stored in memory.

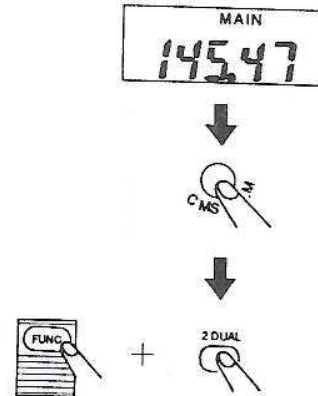

Changing the Transmitter Power

Your Transceiver has three power levels (depending upon the battery pack you are using):

Level	With 12 V Pack		With 7.2 V Pack	
	144 MHz Band	220 MHz Band	144 MHz Band	220 MHz Band
High	5.0 W	5.0 W	2.8 W	2.5 W
Medium	2.5 W	2.5 W	2.5 W	2.5 W
Low	350 mW	350 mW	350 mW	350 mW

To select the power level you desire, press PO (FUNC + PO). Each time you press this combination, the transmitter power alternates between the three available levels. Low power is indicated by an "L" a, medium power by an "M", and High power by an "H" along the bottom of the display. When you select medium power, you will hear a lower-pitched beep than you do with the other two power levels.

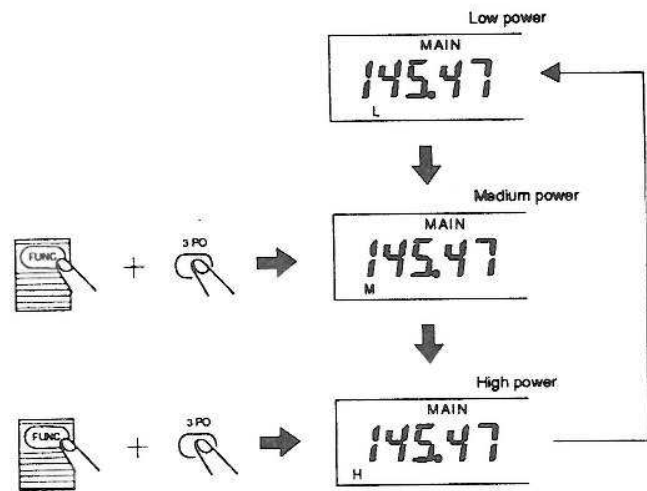

Changing the Frequency Step

You have the option of setting the Transceiver's normal step rate to 5 kHz (factory setting), 10 kHz, 12.5 kHz, 20 kHz, 25 kHz, or 50 kHz. To change the step rate:

1. Press STEP (FUNC + STEP). The frequency display will extinguish and indicate the current step rate.
2. Turn the ROTARY CHANNEL SELECTOR and note that the step rate changes (you will hear a low-pitched beep each time the step rate becomes 5 kHz). Then set the ROTARY CHANNEL SELECTOR to the step rate you desire.
3. Press the CL button to enter the new step rate and return to the previous VFO display.

NOTE: When the step rate is set to 12.5 kHz, a small "50" is displayed just to the right of the "12".

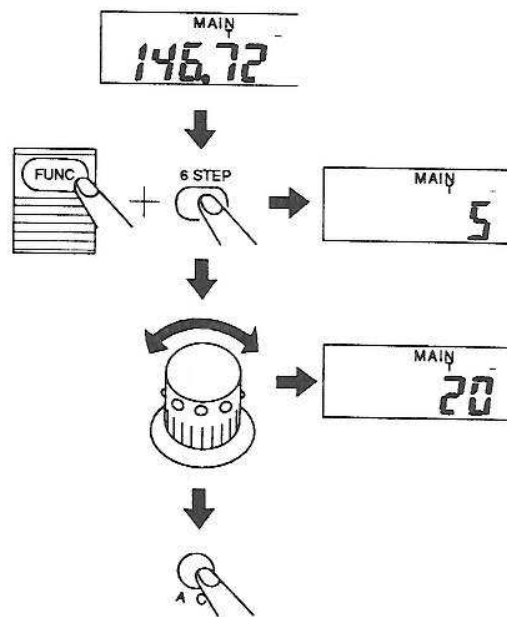

Battery-Saver Function

This feature allows you to conserve the battery during receiver standby, and is especially useful when no signals are received for a long period of time. When this feature is activated, the receiver turns on only once each second and makes it possible to approximately triple usable battery life between charges.

Perform the following steps to set the save timer:

1. Press SAVE (FUNC + SAVE). An "S" will appear above the top right side of the frequency display to indicate that the battery-saver function is enabled.
2. To cancel battery-saver operation, press SAVE (FUNC + SAVE) again.

NOTES:

1. The battery-saver function is disabled during dual-watch or VFO-frequency scan operation.

2. Be sure to cancel the battery-saver function when you use the paging feature.

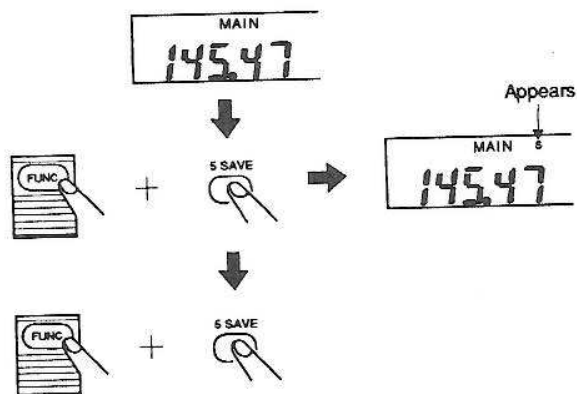

Frequency Lock Function

This feature allows you to lock the frequency and operating mode so they are not accidentally changed. You can also use this feature during scanning and dual-watch to prevent improper operation.

To use this feature:

1. Press FL (FUNC + FL). An "FL" will appear at the left side of the display to indicate that the frequency is locked. The frequency cannot be changed with the numeric buttons or the Rotary Channel Selector. Refer to "Using the Rotary Channel Selector While Frequency is Locked" (Page 2-61) if you want to still be able to use the Rotary Channel Selector.
2. Press FL (FUNC + FL) to again unlock the frequency.

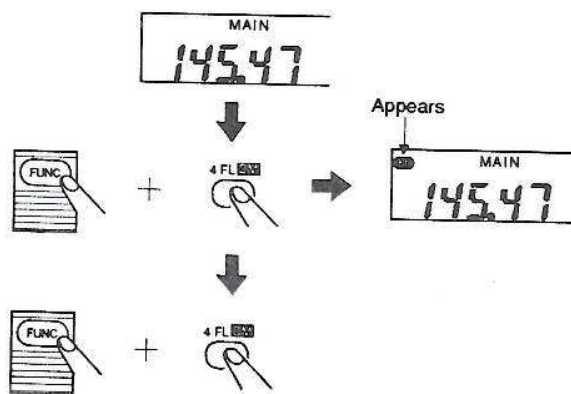

PTT Lock Function

This function allows you to disable the PTT button to help reduce the chance of accidental transmission. To disable the PTT button:

1. Press PL (FUNC + PL). A "PL" will appear at the left side of the display to indicate that the PTT circuitry is disabled.
2. Press PL (FUNC + PL) again to cancel the PTT lock function.

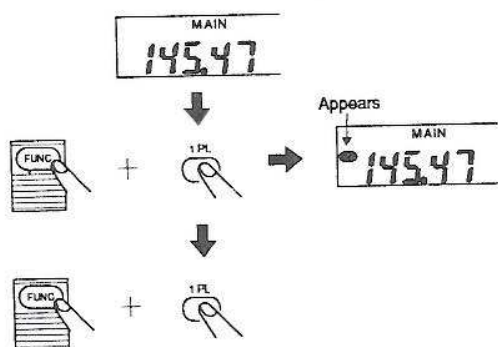

Tone-Squelch Function

The tone squelch (CTCSS) feature allows the receiver in your Transceiver to remain quiet, except when certain stations call you. In addition, some repeaters require a tone to be present before you can access them.

NOTES:

1. When you enable tone squelch operation, you cannot communicate with stations that do not have tone squelch capability, or stations that use different tone frequencies. You must select the required tone before you attempt tone squelch operation.
2. You must have the optional CTCSS Tone Squelch Unit installed in your Transceiver before the tone squelch will work.
3. Full tone-squelch operation (both encode and decode) is available only in the simplex mode, while tone operation (encode only) is available in the repeater mode.

To use the tone squelch during nonrepeater operation:

1. Select the desired band and frequency.
2. Set the necessary tone frequency in memory as described in "Changing the Tone Frequency" on Page 2-13.
3. Press T.SQ (FUNC + T.SQ). A "T" will appear above the display to indicate that the tone encoder (transmit function) is enabled.
4. Press T.SQ (FUNC + T.SQ) again. An "SQ" will appear with the "T" to indicate that full tone squelch operation is enabled (transmit and receive).
5. Press T.SQ (FUNC + T.SQ) again when you wish to cancel tone squelch operation.

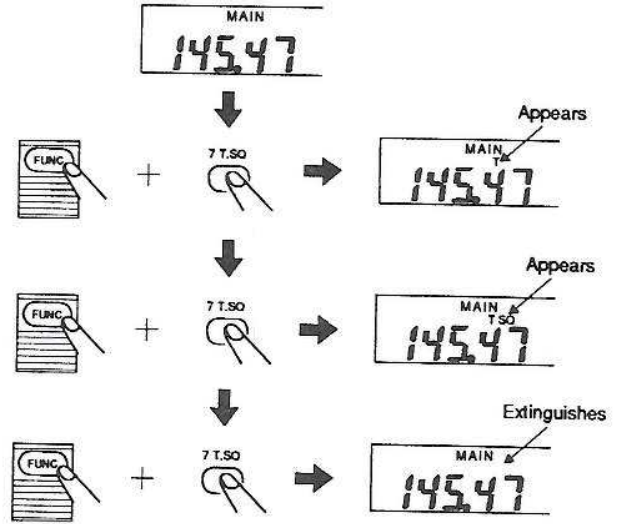

Auto-Power Off

An auto-power off feature is built into your Transceiver to help conserve power in the event you forget to turn the Transceiver off. This action takes effect when 30 minutes expires after no Transceiver buttons have been operated and no signals have been received. The Transceiver will beep about 1 minute before the time period expires to warn you that the Transceiver is about to turn most of its circuitry off. While it is in this condition, the current drain is reduced to less than 1 milliampere.

Perform the following steps to enable the auto-power off feature:

1. Press SET (FUNC + SET) to enter the set mode. The frequency display of the main band will extinguish.
2. Press the SAVE button. An "AP" will appear in the upper left corner of the display to indicate that auto-power-off is enabled.

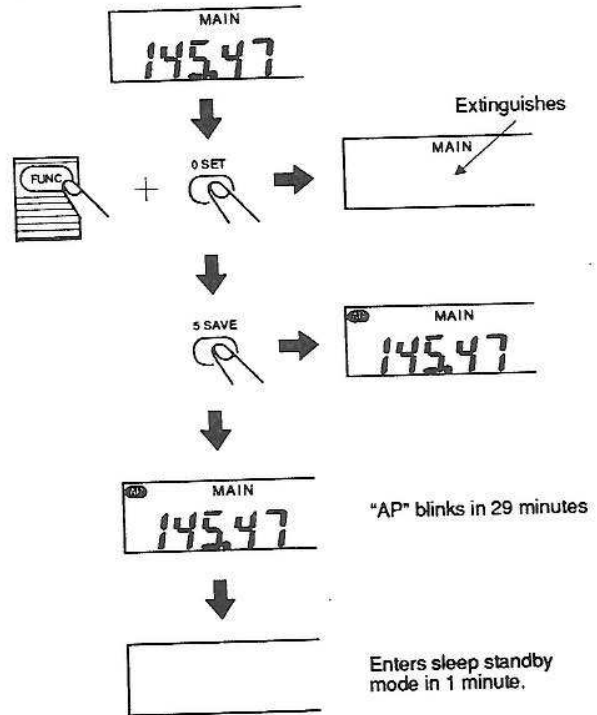

In approximately 29 minutes, you will hear five beeps to indicate that the timer period is about to expire. In addition, the "AP" will start blinking. One minute later most of the display will extinguish and Transceiver will enter a "sleep standby mode".

3. To return the Transceiver to operation, either press the CALL button or turn the Transceiver off and then back on. NOTE: This does not cancel the auto-power-off function and it will again enter the sleep standby mode in 30 minutes.
4. To cancel the auto-power-off feature, Press SET (FUNC + SET). Then press the SAVE button. The "AP" will extinguish and the normal display will return.

Muting the Beep Tones

Perform the following steps if you wish to disable the various beep tones that occur when you operate the Transceiver's buttons:

1. Press SET (FUNC + SET) to enter the set mode. The frequency display will extinguish.
2. Press the SB button. Note that you do not hear a beep when you press this button. Pressing other buttons will also no longer produce beep tones.
3. To re-enable the beep tones, press SET (FUNC + SET) and then press the SB button. You will hear a low-pitched beep.

NOTES:

1. The display does not indicate whether the beep tones are on or off. To check it, simply press one of the buttons and listen for a beep.
2. The auto-power-off alarm will always sound, even if the beep tones are muted.

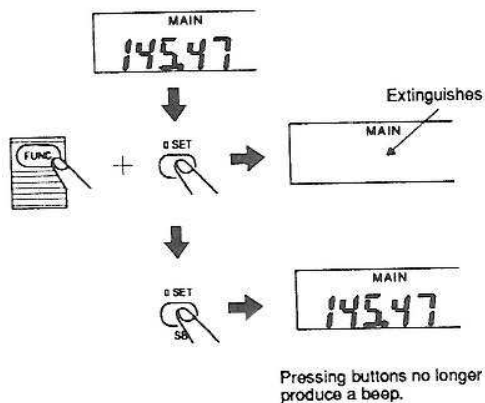

1. Press SET (FUNC + SET) to enter the set mode. The frequency display will extinguish.
2. Press the 1 button. You will hear a short beep tone to indicate that only one beep will be produced when your Transceiver is paged.
3. When you wish to return to five beeps, first press SET (FUNC + SET). Then press the 1 button. You will hear a low-pitched beep to indicate that five beeps will again be produced.

Changing the Number of Beep Tones During Pager Operation

During pager operation, your Transceiver will normally produce five beeps when it has been paged. If you wish to change this so that only one beep is produced, perform the following steps:

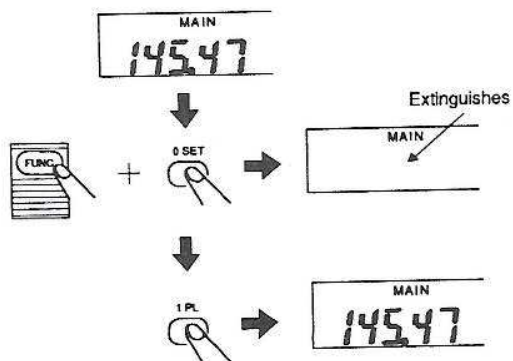

Entering the 1 kHz Frequency Digit

Normally, you have to use the Rotary Channel Selector when you wish to change the kHz position of the display. Perform the following steps if you wish to use the keyboard to enter the kHz digit. NOTE: Pressing the 0 through 9 keys will change the frequency to the nearest step, depending upon your selected step rate.

1. Select the desired band. NOTE: If you wish to be able to access the 1 kHz digit in both bands, you can first perform the following steps on one band and then repeat them for the other band.
2. Press SET (FUNC + SET) to enter the set mode. The frequency display will extinguish.
3. Press the 2 button. You will hear a short beep and a tiny ► will appear near the lower right corner of the frequency display to indicate that 1 kHz entry is enabled.

4. When you wish to cancel 1 kHz entry, first press SET (FUNC + SET). Then press the 2 button. You will hear a low-pitched beep and the ► will disappear from the display to indicate that 1 kHz entry is disabled. NOTE: You can still use the Rotary Channel Selector to make normal 1 kHz entries.

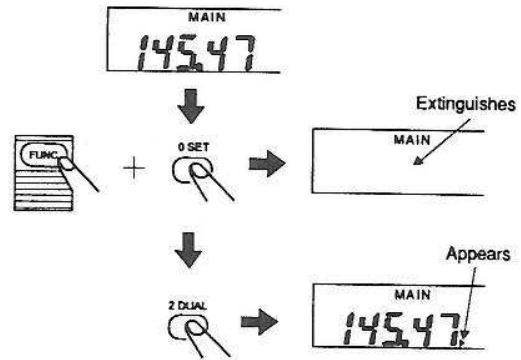

Changing the Pager Code Delay

When you have pager operation enabled, there is normally a 450 millisecond delay between the time you press the PTT button and the time the paging code is transmitted. Occasionally, other stations may require a longer delay to properly decode the code. The following steps increase this delay to 750 milliseconds.

1. Select the desired band.
2. Press SET (FUNC + SET) to enter the set mode. The frequency display will extinguish.
3. Press the 3 button. You will hear a short beep to confirm that the delay has been changed.
4. To return to the normal delay, first press SET (FUNC + SET). Then press the 3 button. You will hear a low-pitched beep to indicate that normal delay is resumed.

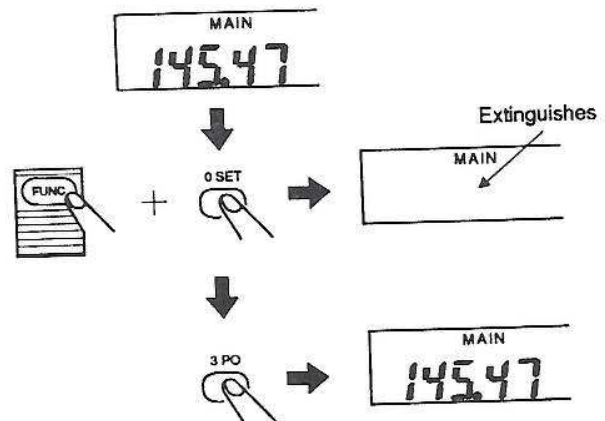

Changing the Squelch Delay

During normal operation, short noise bursts may briefly open the squelch and become annoying. The following steps increase the squelch delay so that these short bursts are ignored.

1. Select the affected band.
2. Press SET (FUNC + SET) to enter the set mode. The frequency display will extinguish.
3. Press the 4 button. You will hear a short beep to confirm that the squelch delay is enabled. NOTE: If you hold the Transceiver near your ear, you may hear a slight noise. This is normal.
4. To return to normal squelch operation, first press SET (FUNC + SET). Then press the 4 button. You will hear a low-pitched beep to indicate that normal squelch is resumed.

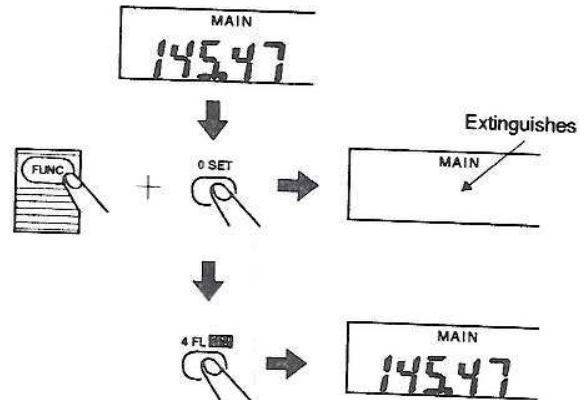

Using the Rotary Channel Selector While Frequency is Locked

The frequency lock function helps prevent you from inadvertently making frequency or operation changes during normal handling. The following steps allow you to use the Rotary Channel Selector to change the frequency, even while the frequency lock function is enabled. **NOTE:** Be sure to temporarily turn off the frequency lock while you perform these steps.

1. Press SET (FUNC + SET) to enter the set mode. The frequency display will extinguish.
2. Press the 6 button. You will hear a short beep to confirm that you can now use the Rotary Channel Selector to change the frequency while frequency lock is enabled.
3. Press FL (FUNC + FL) to again enable the frequency lock feature. You can now use the Rotary Channel Selector to change the frequency without unlocking the frequency.

4. To again lock the Rotary Channel Selector along with the frequency lock function, first turn off the frequency lock. Then press SET (FUNC + SET) and then the 6 button. You will hear a low-pitched beep to indicate that normal frequency lock is resumed.

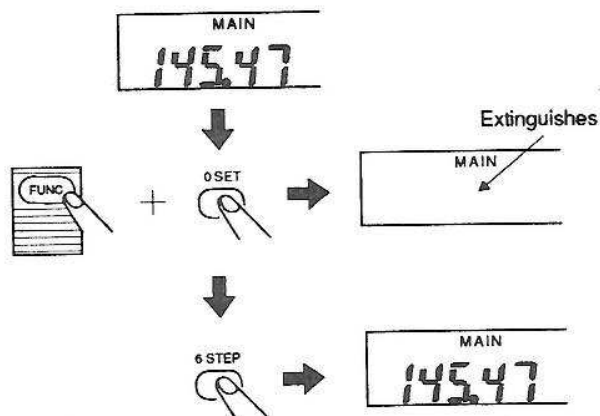

Coded Squelch

The coded-squelch feature is similar to the tone-squelch feature, but a group code is transmitted instead of a continuous tone.

Codes that are stored in memory locations are used for the signals during coded-squelch operation. When you install the optional Tone Squelch Unit in your Transceiver, you can use tone squelch and coded squelch at the same time.

To activate coded-squelch operation, perform the following steps:

1. Select the desired band.
2. Press CODE (FUNC + CODE).
3. Select the memory address (M0 through M6) that contains the code you wish to use.
4. Press the V/M button to enter the VFO-frequency mode.

5. Press the PAG button twice. A "C" will appear in place of of the 100 MHz digit of the display.

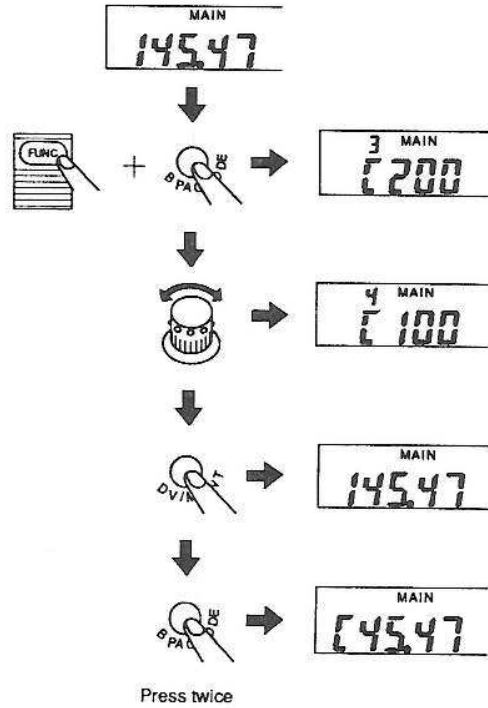

Cross-Band Repeater Operation

This Transceiver is capable of full cross-band repeater operation. When this feature is enabled, a signal that is received on the display frequency in one band is automatically repeated on the display frequency in the other band.

To use this feature, perform the following steps:

1. Set the displays to the two frequencies you wish to use. Also include any repeater offset you may desire.
2. Press SET (FUNC + SET). The frequency display of the main band will extinguish.
3. Press RPT (FUNC + RPT). A small dot will appear above the 10 MHz digit of the display.

NOTE: The Transceiver will now operate as a cross-band receiver. The PTT button, however, will not work.

4. To return the Transceiver to normal operation, first press SET (FUNC + SET). Then press RPT (FUNC + RPT).

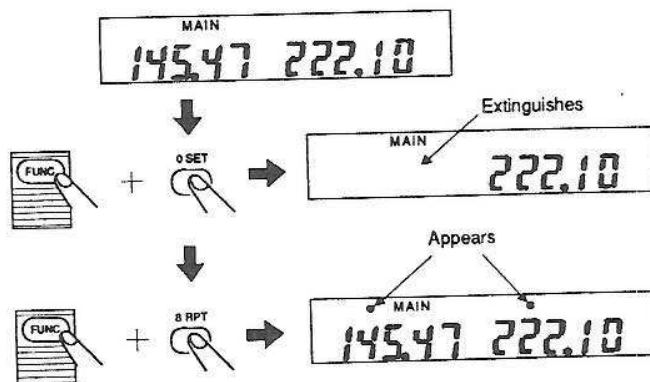

NOTE: If tone-squelch scan is enabled during cross-band repeater operation, received signals will not be repeated unless a valid CTCSS tone is received.

Amateur repeater transmitters typically have a "squelch tail" where the transmitter stays on the air a few seconds after a received signal disappears. The following steps cause your transmitter to stay keyed for about 2 seconds after a received signal ceases transmission.

1. Press SET (FUNC + SET). The frequency display of the main band will extinguish.
2. Press PL (FUNC + PL).
3. To cancel the 2-second delay, first press SET (FUNC + SET). Then press PL (FUNC + PL).

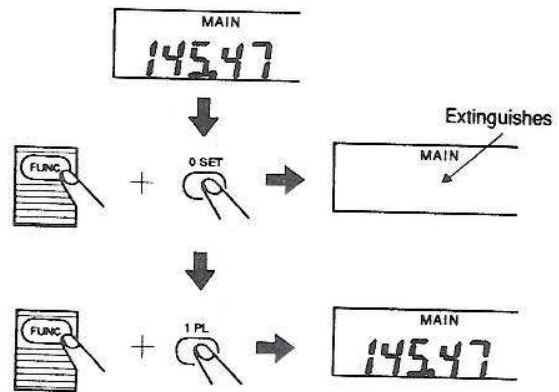

10 MHz Keyboard Entry

Normally, you cannot use the buttons on the keyboard to enter the 10 MHz digit of the display (you have to use the Rotary Channel Selector). If you wish to activate this entry, perform the following steps:

1. Press SET (FUNC + SET). The frequency display of the main band will extinguish.
2. Press FL (FUNC + FL). A small dot will appear between the 10 MHz and 1 MHz digits of the display.
3. To deactivate 10 MHz entry, first press SET (FUNC + SET). Then press FL (FUNC + FL). The small dot located between the 10 MHz and 1 MHz digits will extinguish.

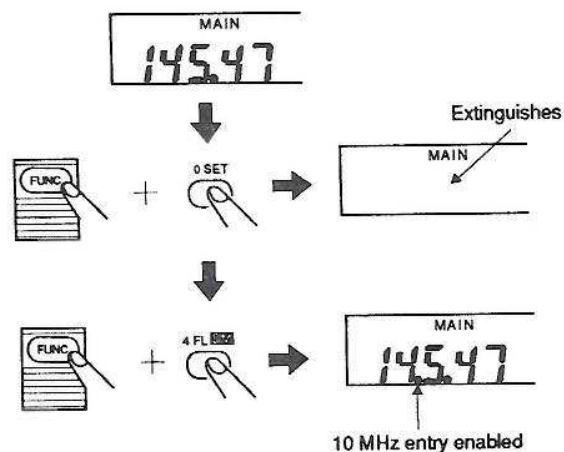

1 MHz Rotary Channel Selector Steps

When you turn the ROTARY CHANNEL SELECTOR by itself, the frequency changes in 10 kHz steps, and turning the ROTARY CHANNEL SELECTOR while you hold down the FUNCTION button changes the frequency in 100 kHz steps. If you wish to change the frequency in 1 MHz steps, while you hold down the FUNCTION button, perform the following steps. NOTE: The ROTARY CHANNEL SELECTOR will still change the frequency in 10 kHz steps when you turn it by itself.

1. Select the desired band.
2. Press SET (FUNC + SET). The frequency display of the selected band will extinguish.
3. Press STEP (FUNC + STEP).
4. To return to 100 kHz steps, first press SET (FUNC + SET). Then press STEP (FUNC + STEP).

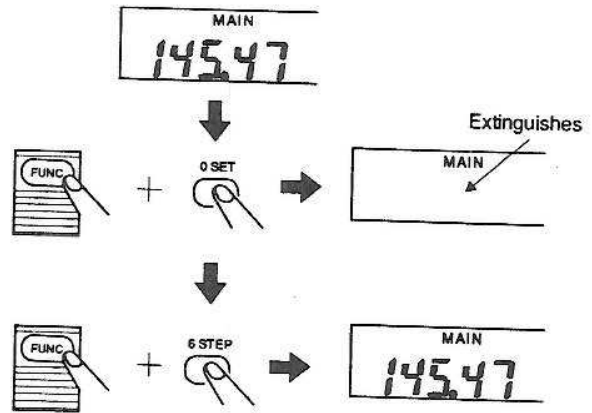

10 MHz ▼ /▲ Frequency Steps

The ▼ and ▲ buttons normally change the frequency in your selected step rate. If you wish to have these buttons change the frequency in 10 MHz steps, perform the following steps:

1. Select the desired band.
2. Press SET (FUNC + SET). The frequency display will extinguish.
3. Press REV (FUNC + REV).
4. To return to your selected step rate, first press SET (FUNC + SET). Then press REV (FUNC + REV).

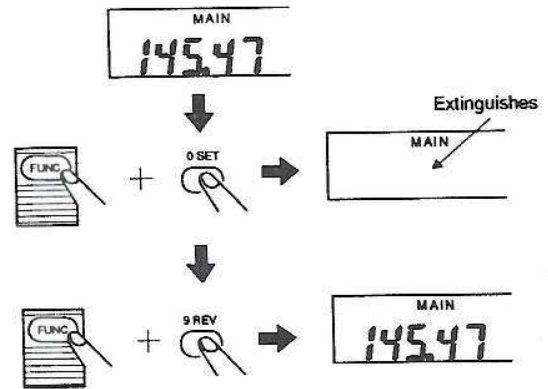

Transmitting a Single DTMF Tone

Normal DTMF signals are made up of two tones; a low tone and a high tone. When you press the 0 through 9, A through D, *, or # button while the Transceiver is transmitting, you generate various combinations of tones that match signals generated by a standard tone-style telephone.

When you perform the following steps, the keyboard buttons will only transmit a single tone as shown in Table 2-3 instead of a combination of two.

1. Select the desired band.
2. Press SET (FUNC + SET). The frequency display will extinguish.
3. Press T.SQ (FUNC + T.SQ).
4. To return to normal two-tone operation, first press SET (FUNC + SET). Then press T.SQ (FUNC + T.SQ).

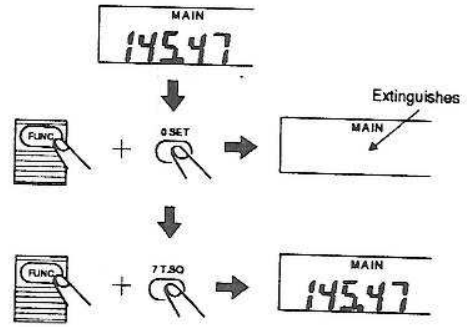

Table 2-3

Button	Tone	Button	Tone
0	1336	8	1336
1	697	9	852
2	1336	*	941
3	697	#	1477
4	1209	A	697
5	770	B	1633
6	1477	C	852
7	852	D	1633

Disabling Voice Paging

During the paging function, another station can transmit the proper code to open your receiver and then page you by voice. This would probably mostly occur when the other station transmits the group code, and then requests only certain stations in the group to answer. If you wish to turn off the voice part of paging, but still receive the normal beeps when you are paged, perform the following steps:

1. Select the desired band.
2. Press SET (FUNC + SET). The frequency will extinguish.
3. Press SAVE (FUNC + SAVE).
4. To re-enable voice paging, first press SET (FUNC + SET). Then press SAVE (FUNC + SAVE).

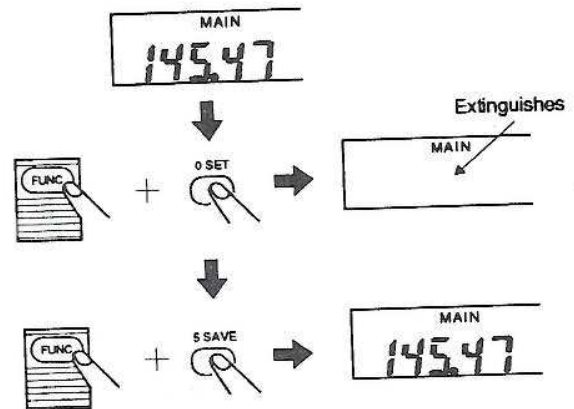

Copying Memory Contents to Another Transceiver

This Transceiver has the capability of quickly transferring the contents of its memory to another transceiver. This allows you to program several transceivers so they are exactly the same, without entering each parameter manually.

NOTES:

1. When you use this procedure, the memory in the receiving transceiver will be completely erased.
2. Make sure both transceivers are programmed to the same frequency.
3. Do not turn either transceiver off while programming is being performed.

4. Make sure the transmitting transceiver is not in the single DTMF mode.

To use this handy feature, perform steps 1 through 3 on both transceivers:

1. Select the desired frequency (can be in either band, as long as both transceivers are the same).
2. Press SET (FUNC + SET). The frequency display of the main band will extinguish.
3. Press PS (FUNC + PS).
4. On the transceiver that contains the memory information you wish to copy to the other transceiver, press the PTT button. You will hear several seconds of tones as the programmed data is being sent to the other station. When the tones stop, you can use the transceiver normally.

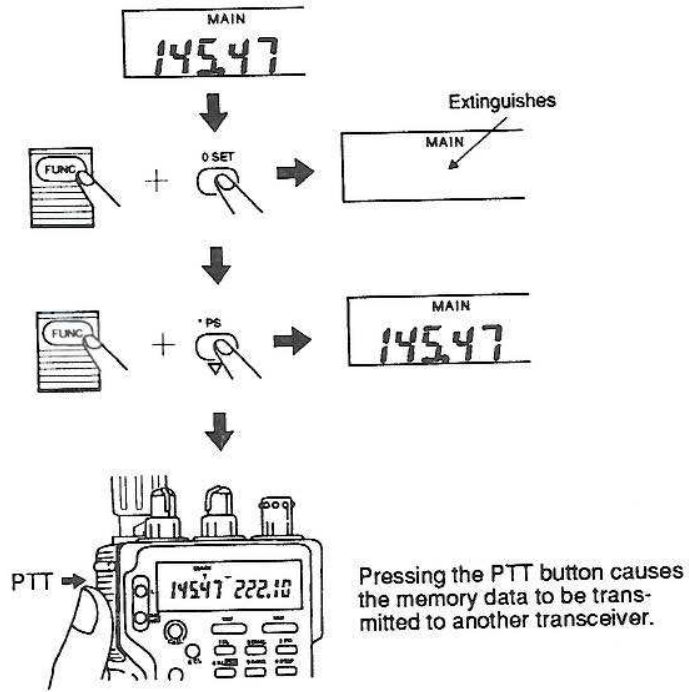

Expanding the Memory

The Transceiver can normally be programmed with up to 10 channels each in the 144 MHz and 220 MHz bands for a total of 20 memories. These are designated as channels M0 through M9 in each band. You can store 10 additional memory channels (M0 through M9) in each band, for a total of 40 memories, with the following limitations:

1. Only the operating frequency can be stored; you cannot store a transmitter offset or a tone frequency.
2. You can store the repeater function in the additional memory channels without a tone frequency, but the transmitter offset will be the same as the VFO offset frequency.

To expand the memory to 40 channels, perform the following steps:

1. Press ENT (FUNC + ENT). An "M" will appear on the display.

2. Hold down the FUNCTION button while you press the CL button. A bar will appear above the "M".
3. Use the numeric buttons to designate memory address numbers.

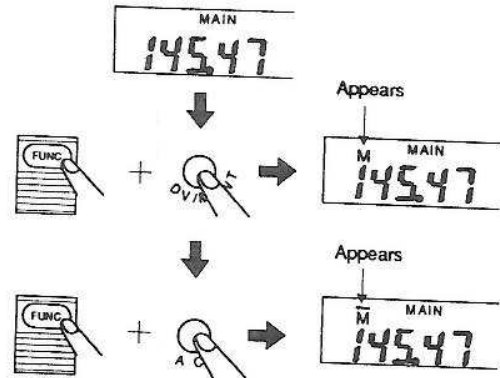

Deleting an Expanded Memory Address

Perform the following steps when you wish to erase an entry in one of the expanded memory channels (M0 through M9):

1. Select the memory address you wish to delete.
2. Hold down the memory address's corresponding numeric button while you press the CL button. You will hear a long, high-pitched beep and the "M" on the display will blink.
3. Press SET (FUNC + SET). The frequency display will extinguish.
4. Press the RPT button by itself. The offset frequency will appear.
5. Press ENT (FUNC + ENT). The bar above the "M" will extinguish and the "M" will stop blinking (the "M" will continue to blink if the corresponding normal memory address is empty).

6. Press the CL button to return to the normal memory mode.

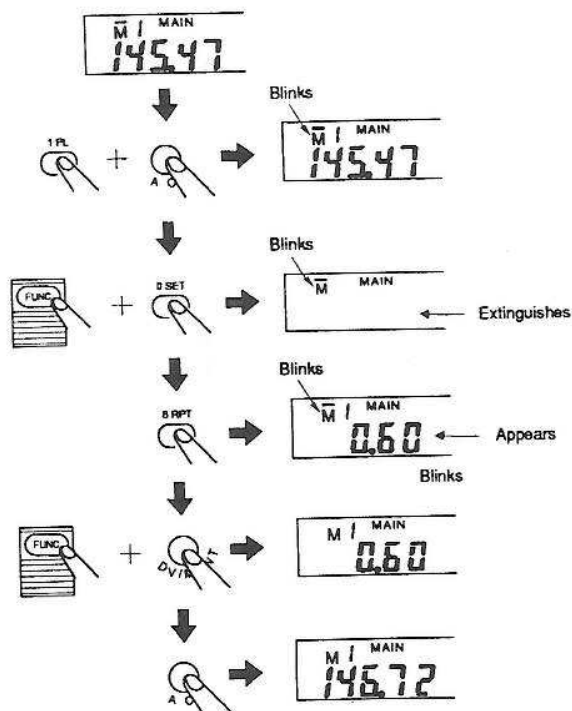

Changing the Call Frequency

Perform the following steps to change the call frequency:

1. Select the desired band and frequency.
2. Press ENT (FUNC + ENT). An "M" will appear on the display.
3. Press the CALL button. A "C" will appear next to the "M".

NOTE: A repeater frequency (with an offset and a CTCSS tone) can also be stored in the call channel.

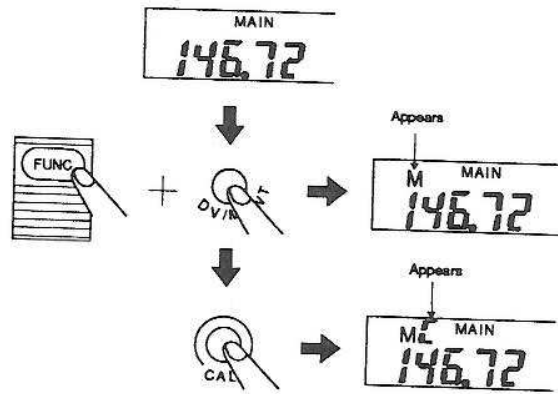

Storing one DTMF sequence in memory

The C228A Twin band HT can store one DTMF sequence of up to 15 DTMF tones. This feature can be used to store your autopatch "up" code and favorite telephone number (or for control applications). Many repeaters have this capability.

To Store the number:

1. Press SET (FUNC + SET).
2. Press SET (FUNC + SET) again. The display will blank.
3. Enter the first 5 digits (include * and # where needed).
4. Turn the rotary selector one notch.
5. Enter the next 5 digits ... (and so on).
6. When you have entered your last number, press D V/M ENT key while pressing FUNC key to store the number.

7. By pressing the 144 or 220 key, the initial display will be appeared.

To send the number while transmitting:

While pressing the PTT, simply press "CALL" to transmit the stored DTMF sequence.

ABOUT THE BATTERY

Your Transceiver contains an internal lithium-type battery (separate from the external battery pack) that preserves the contents of the memory, even when the Transceiver is turned off.

Typically, a new battery will last about five years, depending upon how often you use your Transceiver.

NOTES:

1. If the display does not indicate correctly when you turn the Transceiver on, the battery needs to be replaced.
2. After you replace the battery, turn the Transceiver on and use a sharp, nonmetallic object to press the RESET button.
3. Do not dispose of the battery in fire.

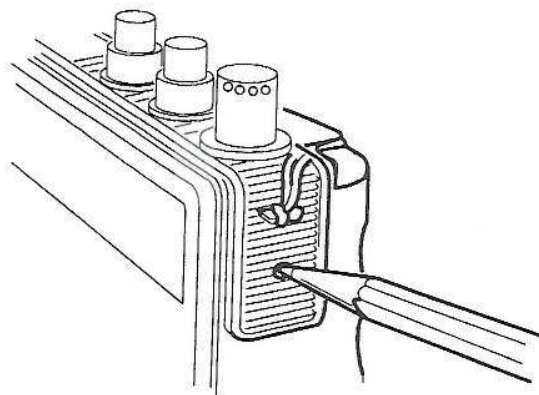

IN CASE OF DIFFICULTY

CONDITION	POSSIBLE CAUSE
Dim frequency display.	1. Low battery voltage. Recharge the battery pack.
Transceiver resets to its initial setup when it is turned off and back on.	1. Weak lithium (internal) battery.
Transceiver cannot be turned on.	1. Low battery voltage. Recharge the battery pack.
Incorrect display.	1. Microprocessor needs to be reset. Turn the Transceiver on. Then use a slender non-metallic object to press the Reset button.
Frequency display flashes.	1. PLL circuit is unlocked. This is usually caused when the frequency is outside of the specified range.
Cannot receive any signals.	<ol style="list-style-type: none"> 1. The receiver circuits are not operating. Press the SQL OFF button to check the receiver circuits. 2. Paging or tone squelch operation is enabled. 3. Corresponding VOLUME control is fully counterclockwise. 4. Corresponding SQUELCH control is fully clockwise.

(cont'd)

CONDITION	POSSIBLE CAUSE
Can receive only strong signals.	<ol style="list-style-type: none"> 1. Antenna is incorrectly installed. 2. Corresponding SQUELCH control is fully counterclockwise.
Cannot transmit.	<ol style="list-style-type: none"> 1. Low battery voltage (check brightness of the TX/BUSY/BATT indicator). Recharge the batteries. 2. PTT switch is locked off ("PL" is present on the display). Press PL (FUNC + PL) to release the PTT lock. 3. Wrong band selected (check position of "MAIN" indication). 4. Transmit frequency is outside of the amateur band.
Cannot communicate with another station.	<ol style="list-style-type: none"> 1. Wrong band selected (check position of the "MAIN" indicator).
Cannot transmit at the displayed frequency.	<ol style="list-style-type: none"> 1. Repeater mode is activated ("+" or "-" appears above the right side of the selected band).
Cannot change the frequency.	<ol style="list-style-type: none"> 1. Frequency lock is enabled ("FL" appears on the display). Press FL (FUNC + FL) to release the frequency lock.

(cont'd)

CONDITION	POSSIBLE CAUSE
No sounds from the internal beeper.	<ol style="list-style-type: none">1. Beep tones have been muted. To reactivate, first press SET (FUNC + SET). Then press the SB button.2. The VOLUME controls are turned fully counterclockwise.
No display when the Transceiver is turned on.	<ol style="list-style-type: none">1. Auto-Power Off is enabled. Press the CALL button or turn the Transceiver off and back on again to cancel auto-power off.2. Low battery voltage. Recharge the battery pack.
Can only change frequency with the ROTARY CHANNEL SELECTOR.	<ol style="list-style-type: none">1. Frequency lock is enabled ("FL" appears on the display). Press FL (FUNC + FL) to release the frequency lock.

ONE YEAR LIMITED WARRANTY

Standard Amateur Radio warrants this product to be free from defects in workmanship and material under normal use and conditions for a period of one year from the date of original purchase.

Should service be required by reason of any defect or malfunction during the warranty period, Standard Amateur Radio will repair or in its discretion replace this product during the one year period provided that the defective unit is returned prepaid to Standard Amateur Radio with a copy of the original sales invoice as proof of purchase.

In-warranty repairs must be done by Standard Amateur Radio or by a service center specifically authorized to repair Standard Amateur Radio products.

Except as set forth above, Standard Amateur Radio disclaims all warranties of any nature whatsoever, including, without limitation, any implied warranty, of merchantability, fitness for a particular purpose, or otherwise and any express warranty. In no event shall Standard Amateur Radio be liable for any loss, inconvenience or damage whether direct, incidental, consequential or otherwise resulting from breach of any express or implied warranty, of merchantability, fitness for a particular purpose, or otherwise, with respect to the product, except as set forth herein. Some states do not allow limitations on how long an implied warranty lasts and some states do not allow the exclusion or limitation of incidental or consequential damages, so the above limitation or exclusions may not apply to you.

In the event the remedy set forth in the first paragraph fails of its essential purpose to remedy a breach of the express warranty set forth in the first paragraph, the sole remedy will be limited to return of the purchase price paid for the product.

This warranty does not cover damage which results from modification, accident, misuse, abuse, fire, flood, lightning or other acts of God or damage resulting from repairs or alterations performed other than by Standard Amateur Radio.

This warranty gives you specific legal rights, and you may also have other rights which vary from state to state.

Standard Amateur Radio Products, Inc.
P.O. Box 48480
Niles, Illinois 60648