

OWNER'S MANUAL

C5608D

UHF/VHF FM TRANSCEIVER

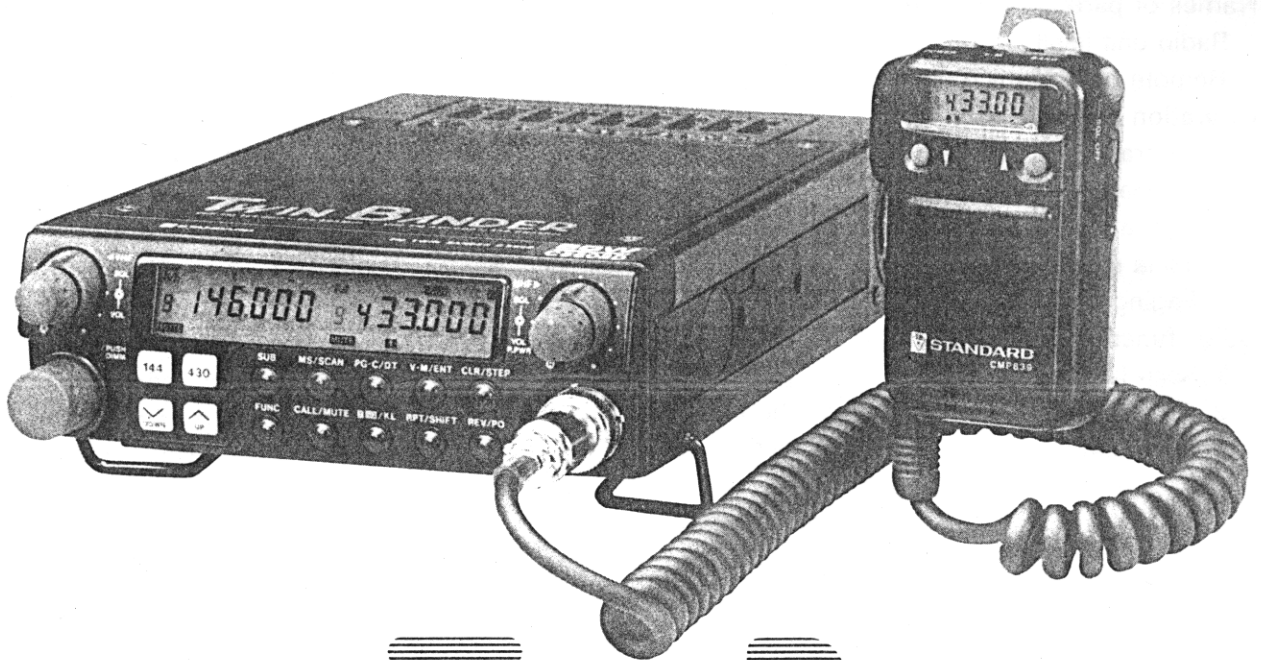

TWIN BANDER

Thank you for purchasing the 144 MHz/430 MHz FM Twin Bander. This unit is produced through our strict quality assurance and inspection and thereupon released to the market. If you have suspicion or suggestion, contact with that dealer from which you have purchased, or our authorized representative or service office as early as possible.

To make the best and long-time use of this product, carefully read this instruction manual well up to the end before use.

Contents

Packing diagram/accessories	2
Precautions for correct use	3
Method of installing to car	4
For operation in fixed station	9
Before use	11
Names of parts and their functions	14
Radio unit itself	14
Remote control microphone	25
Operation method	30
1. Operation on call frequency	31
2. Repeater operation	32
3. Operation on memory frequency	35
4. Tone squelch operation method	42
5. Paging function	43
Other functions	50
1. Scan function	50
2. Auto mute operation to reduce the reception sound volume	52
3. Illumination change of display section	52
4. Key lock function to disable button operation	53
5. Key lock feature of remote control microphone	53
6. Set mode	53
7. Function to let the frequency display disappear	55
8. Transmission output selection	55
9. DTMF function	56
Specifications	59
Accessories	59
Troubleshooting	60
Bracket Mounting hole work pattern	62
List of operation buttons	63

Packing Diagram/Accessories

After unpacking, confirm the accessories.

Accessories

- ① Instruction manual x 1
- ② Circuit diagram (including block diagram) x 1
- ③ Microphone (CMP839) x 1
- ④ Power cord (red/black) 2.0 m x 1
- ⑤ 3.5-mm plug (for external speaker) x 1
- ⑥ Bracket of this unit x 1
- ⑦ Mobile bracket fixing screws and relatives x 1 set
 - Ⓐ Bolt (M5x20 mm) x 4
 - Ⓑ Nut (M5 mm) x 4
 - Ⓒ Washer (M5 mm) x 8
 - Ⓓ Spring washer (M5 mm) x 4
 - Ⓔ Tapping screw (M 5x15 mm) x 4
- ⑧ Microphone hanger x 1
- ⑨ Stand (for radio unit) x 1
- ⑩ Spare fuse 12 A for C5608D x 2

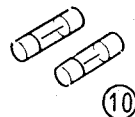
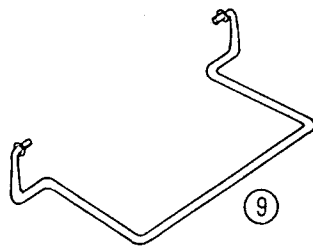
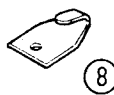
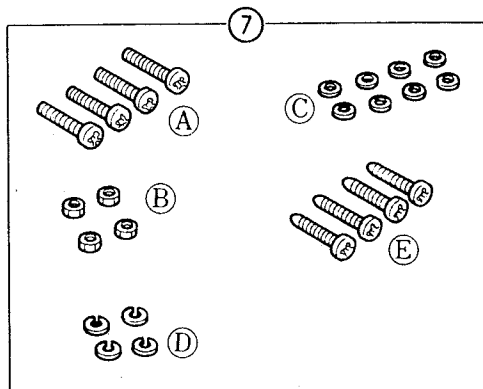
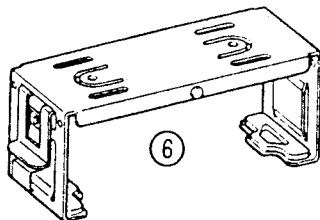
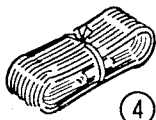
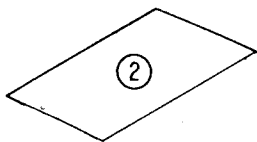
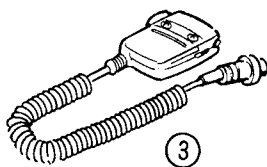
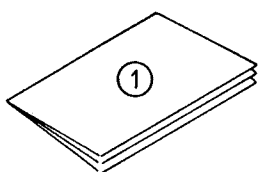
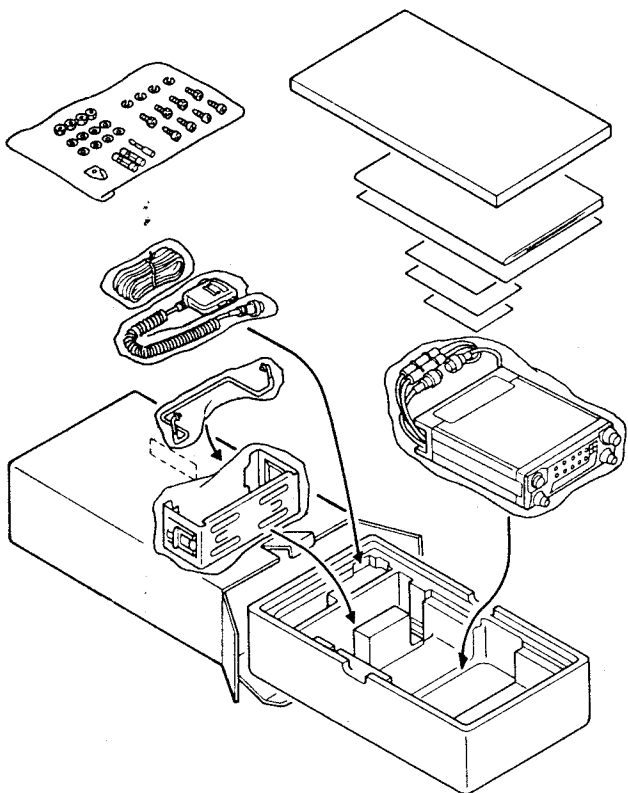

Precautions for Correct Use

Installation location:

For installation location, draw care to the following points:

- 1 Avoid use in excessively humid or dusty locations or in high temperature locations. Especially, avoid use in locations subject to direct sunlights. Select highly ventilated and dry locations.

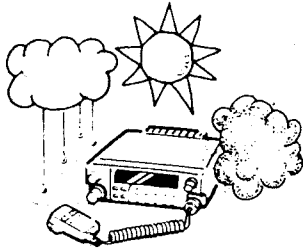

- 2 To ensure the cooling effect of the heat sink, provide enough clearances in the rear side and bottom side.

When the radio unit is used for an extended period of time, the radio unit itself is warmed. However, this does not cause any defect.

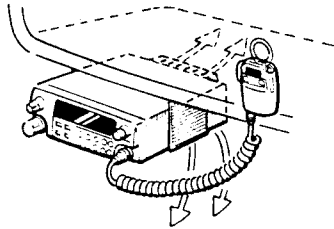

- 3 When installing the radio unit to the car, draw adequate attention not to put the rear side of the radio unit into direct contact with the car sheet and other cares to ensure the cooling effect.

Make use in a location or an installation subject to vibrations as less as possible.

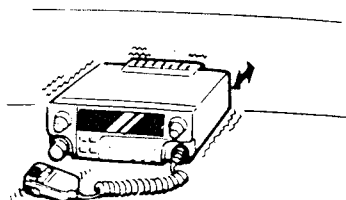

Power supply

- 1 This unit is used with DC 12 V type vehicles. It should be noted that this unit cannot be used with 24 V type vehicles.

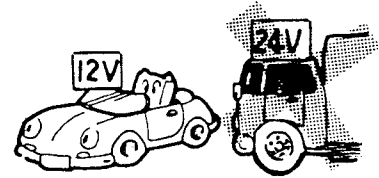

- 2 Never connect the unit to AC.

Method of Installing to Car

1 Installation location

Recommendable locations are: under the dashboard, by the console box, under the gauge panel, etc.

Notes

Avoid use in the following locations:

- Near the blow-off duct of the heater or cooler
- Locations subject to direct sunlight
- Locations subject to much vibration
- Near the electronic circuit of the car itself
- Other locations such as where safety operation is blocked, etc.

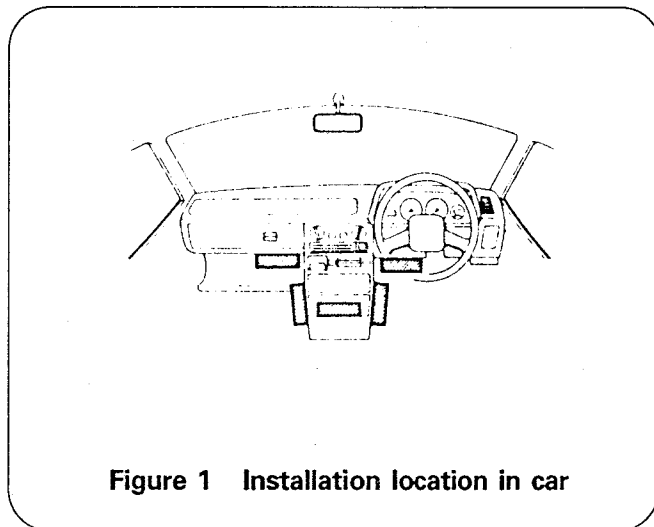

Figure 1 Installation location in car

2 Bracket installation

When attaching the bracket, select a place where the bracket can be fixed securely, and fix it by accessory bolts and screws.

- **Make use of the bracket mounting hole work pattern occurring on page 62.**

① For use of M5 hexagonal head bolts, make holes of 5.2- 5.5 mm diameter by a drill. Or, for use of M5 tapping screws, make holes of 4.0-4.3 mm diameter.

② Attach the bracket to the car body as shown in Figure 2.

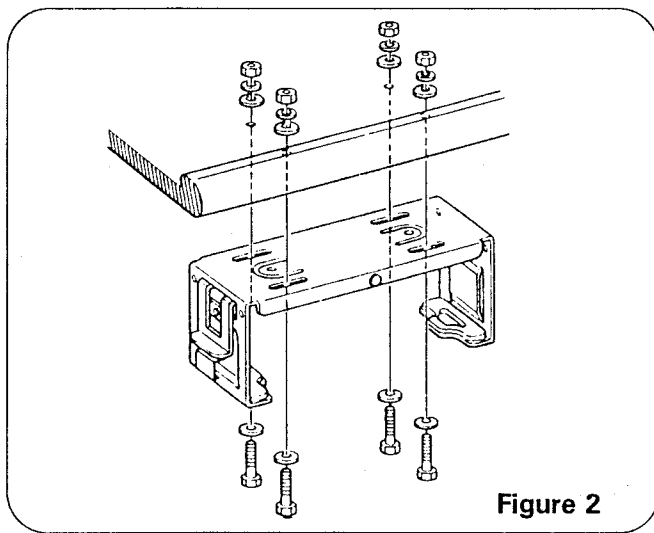
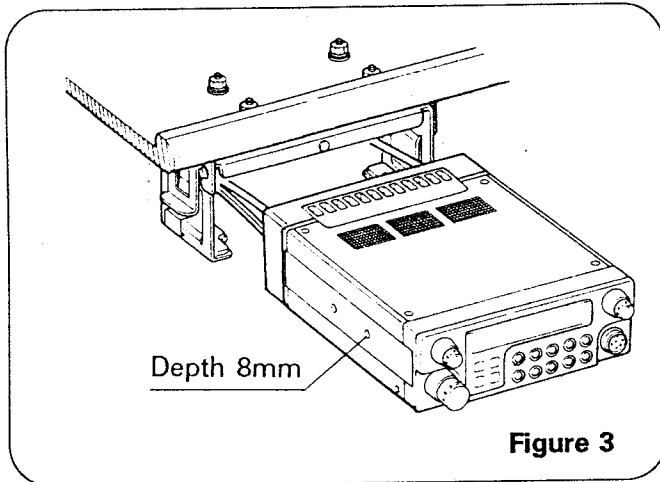

Figure 2

- For use of M5 hexagonal head bolts, put bolts through plain washers, then put through different plain washers and spring washers and, finally secure them by nuts from the inner side.

- For use of M5 tapping screws, put tapping screws through plain washers and screw them in. Thus, they will be automatically threaded and secured.

- ③ Connect the coaxial cable and power cable running from the rear panel of the radio unit with the corresponding coaxial cable running from the antenna and the corresponding power cable running from the power supply, respectively.



- ④ Insert the radio unit to the bracket, and push the left and right levers downwards to secure the radio unit as shown in Figure 4.
 - Before inserting the radio unit to the bracket, confirm that the levers are disengaged from the springs.
 - When detaching the radio unit, push the springs under the levers.

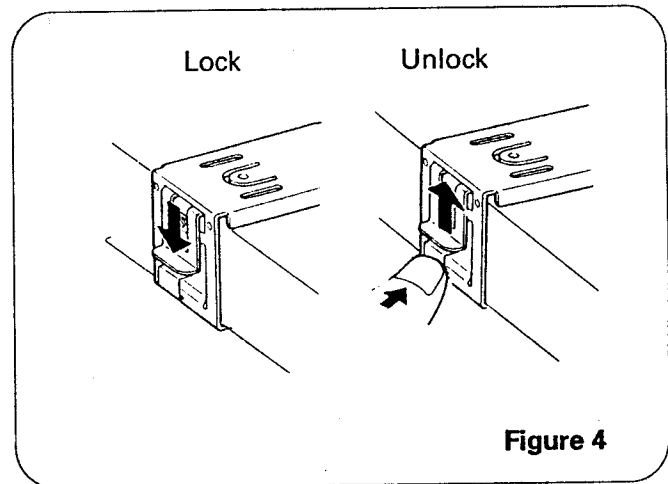

Note

Before inserting the radio unit to the bracket, connect the power cables and the coaxial cables.

3 Routing the power cables

- ① Supply power to the radio unit from the car's battery.
- ② For this, connect the radio unit and the car's battery using an accessory 2.0-m power cord as shown in Figure 5.

Note

This radio unit is only available with a DC 12 V type car. For use with a DC 24 V type car, be sure to use a DC-DC converter which converts DC 24 V to 12 V. When the radio unit is not used for an extended period of time, disconnect the power cord, or the battery power is lowered down.

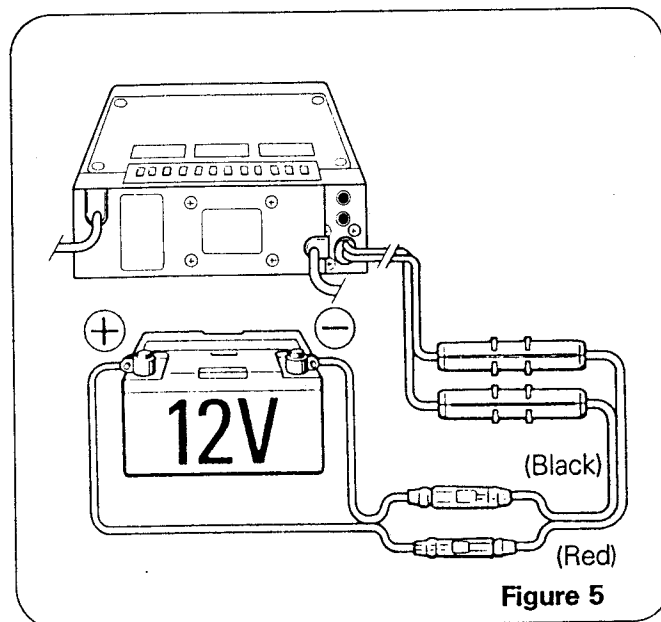

- ③ For power control in response with the ignition switch, perform the routing as shown in Figures 6 and 7.
- Connect the power cord red (positive) to the 12 V positive terminal after passing the car's ignition switch.
 - Connect the power cord black (negative) to the 12 V negative terminal.

Note

As the fuse, be sure to use one rated 12 A for the C5608D. In power cord connecting work, handle the caulked portion of the rubber section.

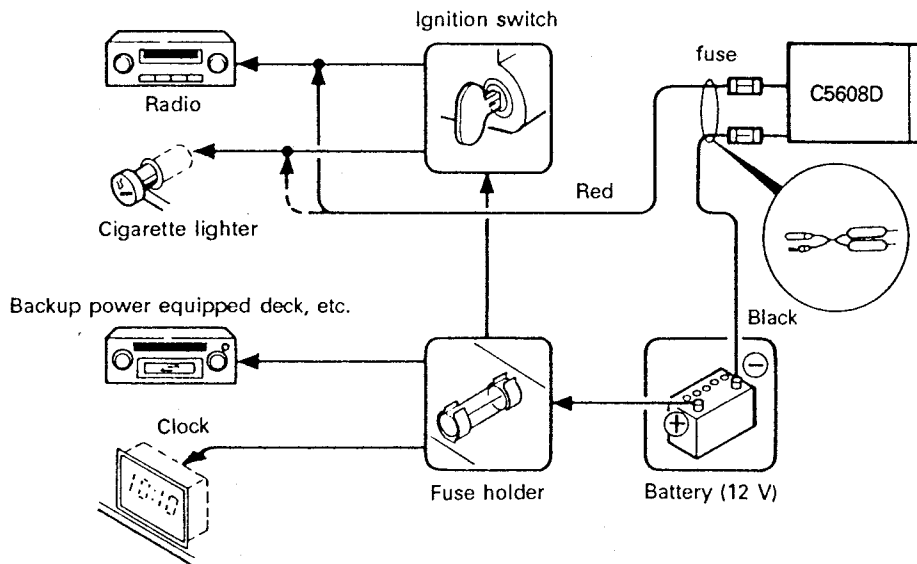
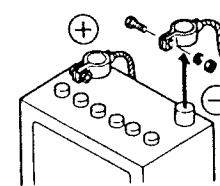
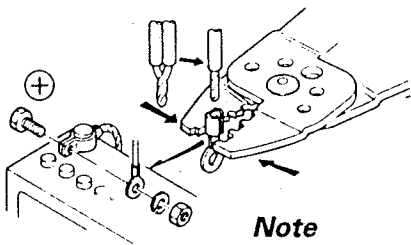

Figure 6



Note
Before work, be sure to disconnect the negative terminal of the battery.



Note
Tighten the battery terminals by a spanner, etc. After completion of work to the positive terminal, retighten the negative cord as before.

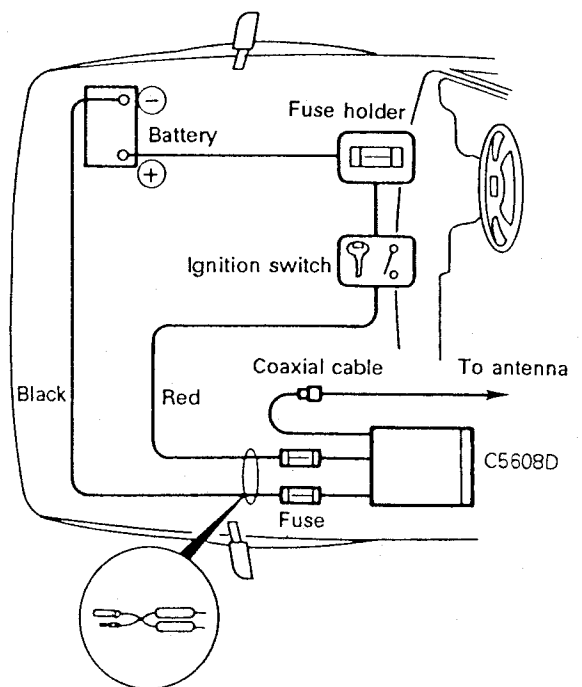
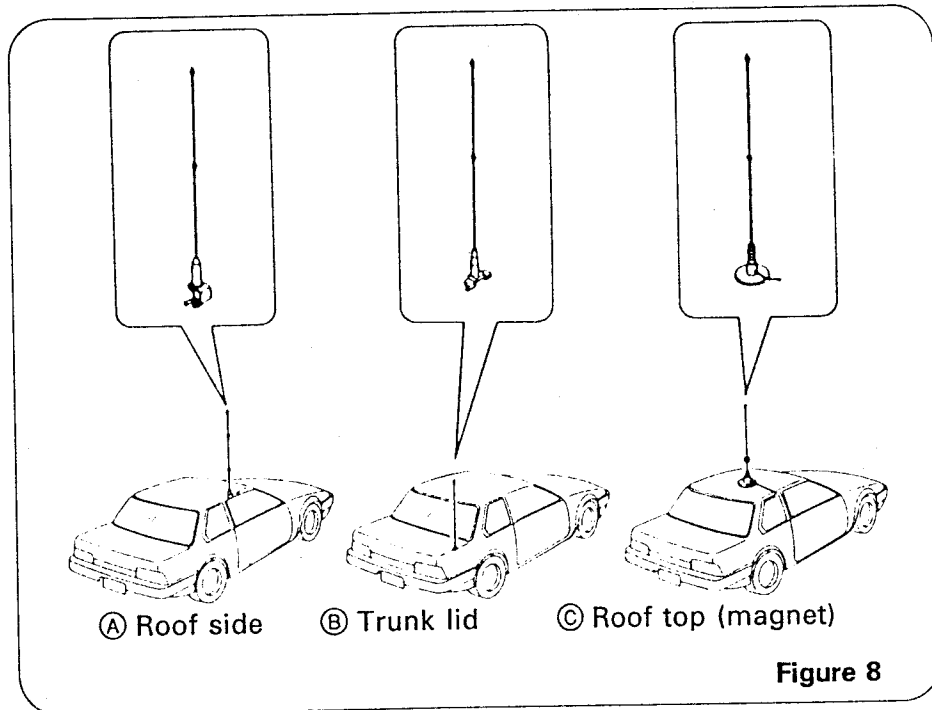

Figure 7

4 Antenna installation

- ① The car antenna is installed in one of three different locations with their corresponding antenna stands as shown in Figure 8. Select an antenna stand suited to the installed antenna and the car type.
- ② The antenna stand is provided with a coaxial cable, through which electromagnetic waves pass. Be sufficiently careful in its handling not to flaw or depress it.
- ③ When drawing in the coaxial cable to the car, follow the illustration of Figure 9.



Notes

- *To make the best of this radio unit, use an antenna with excellent properties. For successful operation, adjust the antenna SWR to less than 1.5. Degraded SWR disables regular transmission power output.*
- *Install the antenna stand in such a way to permit complete grounding between the antenna stand and the car body.*
- *Pay sufficient care to the coaxial cable draw-in section to prevent the entry of rain drops into the car.*
Secure the coaxial cable to prevent any damage to it when a door or window is opened or closed.

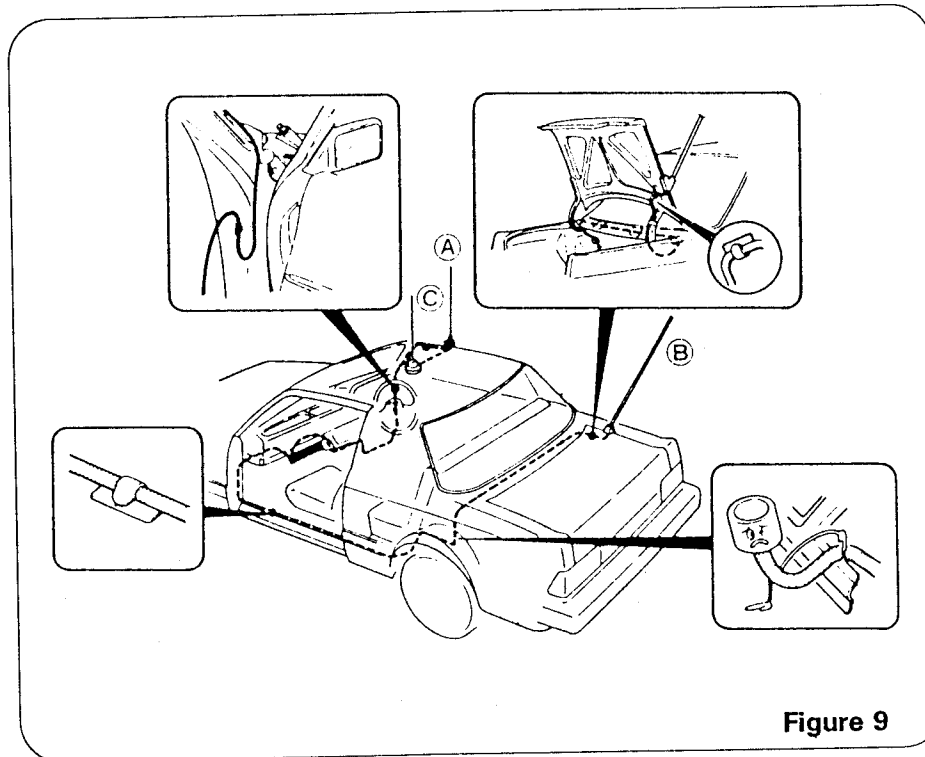

- *Do not cut or remake the antenna, which is suited to the frequency. In addition, a defect in the antenna may disable regular transmission power output or clear reception.*

5 Antenna connection

Of the radio unit, the performance in transmission and reception greatly depends upon the antenna type and property. For antenna selection, take into consideration the 144 MHz/430 MHz band operating purpose, the antenna setting conditions, etc.

① When connecting to independent antenna (Figure 10)

- 1 Connect to the 144 MHz band coaxial cable of this unit its corresponding coaxial cable running from the 144 MHz band antenna.
- 2 Connect to the 430 MHz band coaxial cable of this unit its corresponding coaxial cable running from the 430 MHz band antenna.

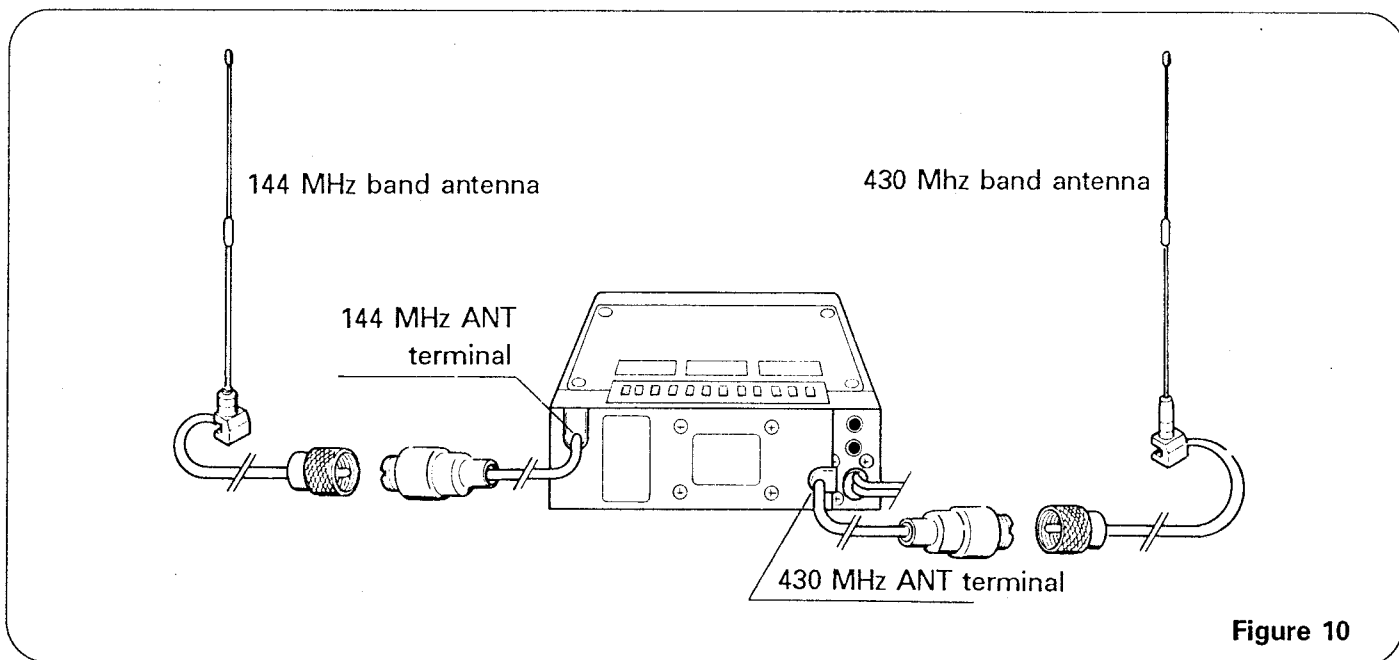

Figure 10

② When connecting to common antenna (Figure 11)

For use of an antenna common to the 144 MHz and 430 MHz bands, a duplexer for 144 MHz and 430 MHz bands is necessary.

Correctly connect to the duplexer the coaxial cables running from the antenna and the radio unit. (For correct use, read the instruction manual of the duplexer.)

Note
The common antenna may have a built-in duplexer.

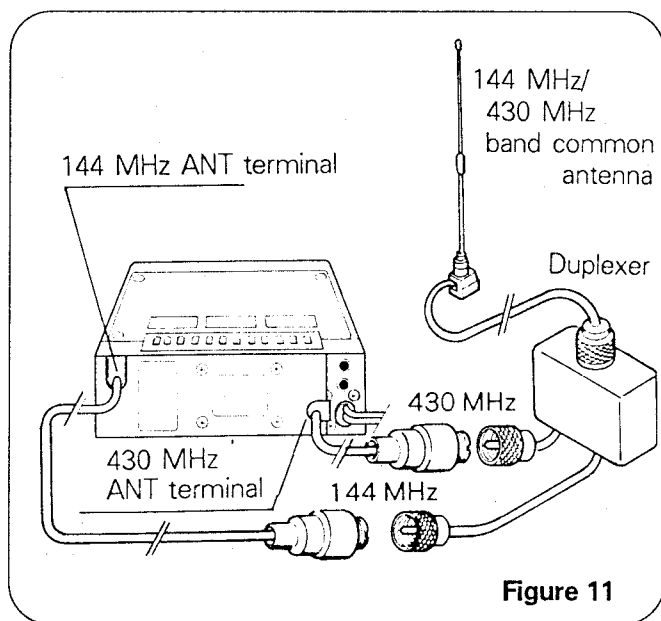

Figure 11

For operation in fixed station

1 Regulated power supply

In the fixed station, when operating the C5608D from the household AC power, the following ratings should be met.

DC output 13.8 V

Output current more than 12 A

For desk-top use:

When operating this radio unit fixed, attach an accessory stand to the radio unit as shown in Figure 12.

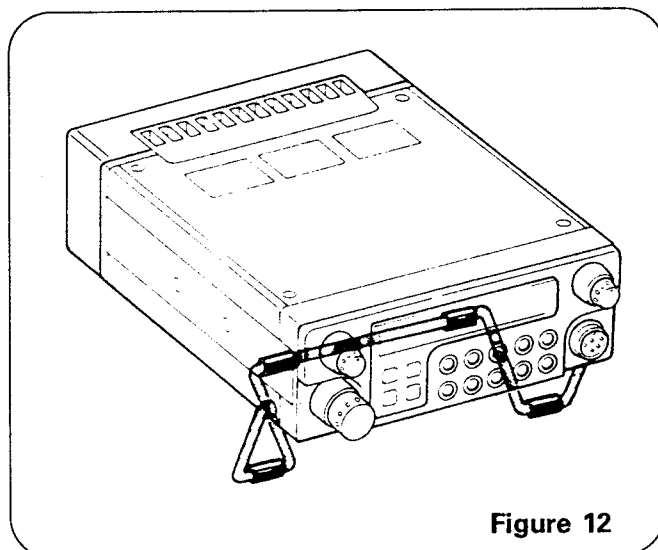

Figure 12

2 Antenna installation

<Ordinary installation of antenna>

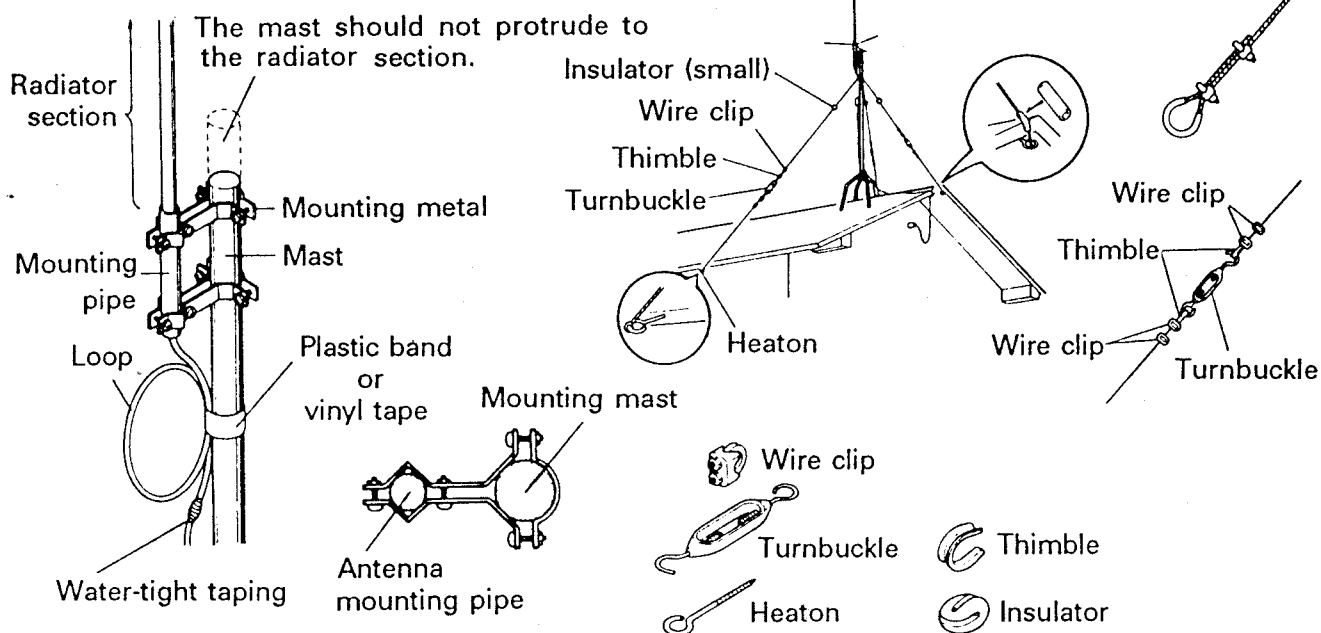

Figure 13

To local QSO, a ground plane antenna (nondirectional) is suited. To remote QSO, a directional antenna (Yagi antenna) is suited. Make an antenna selection according to the purpose and application.

When the coaxial cable running between the antenna and the radio unit is excessively long, the loss in the coaxial cable is problematically great. To avoid this problem, route the coaxial cable at the shortest possible distance.

For up to 10 m of separation between the power supply section of the antenna and the radio unit, use a coaxial cable of 8D2V. For up to 30 m, use a thick coaxial cable of 10D2V or higher.

① Method of installing on roof

Figure 14 represents a standard installation.

For using a vertical antenna, make a loop (loose) of the coaxial cable right under the antenna to avoid the application of the own weight of the coaxial cable to the antenna itself.

In addition, for a shelter of the connector from the rain and for the method of fixing the cable, refer to the instruction manual of the antenna.

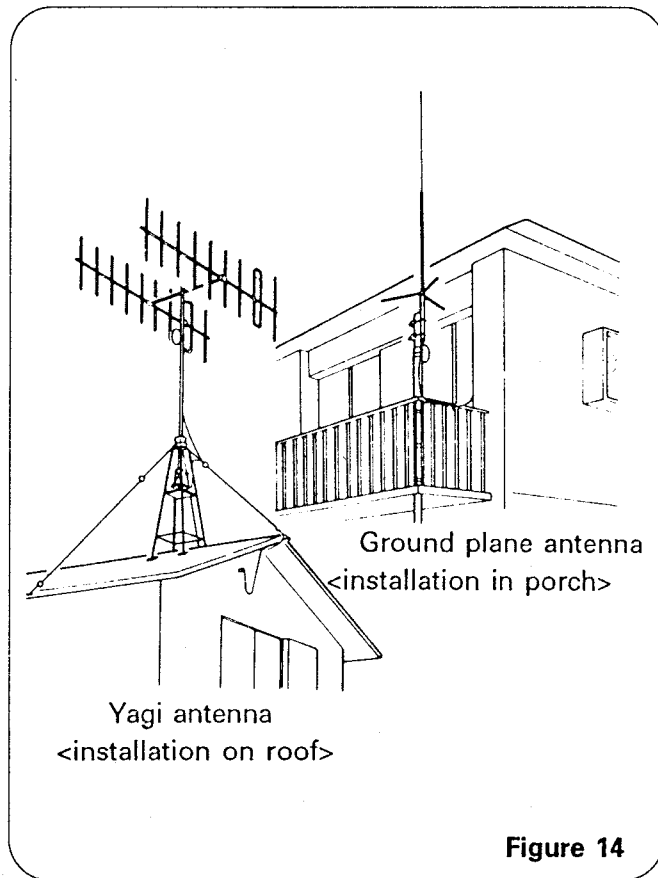

Figure 14

② For watertightness of the connection section, put a self-adhesive tape around it doubly, then further put a vinyl tape, etc.

③ Use an extension coaxial cable in a case where the length of the coaxial cable is not enough from the antenna of the fixed station up to the C5608D. Use a relay connector (M-A-JJ) with jacks at its either end, which is for plug connection.

Notes

1. Take sufficient care to the setting of the antenna holding lines to prevent any hazardous result to the ambient when the antenna is broken down or blown away by strong wind.
2. Route the coaxial cable as short as possible.

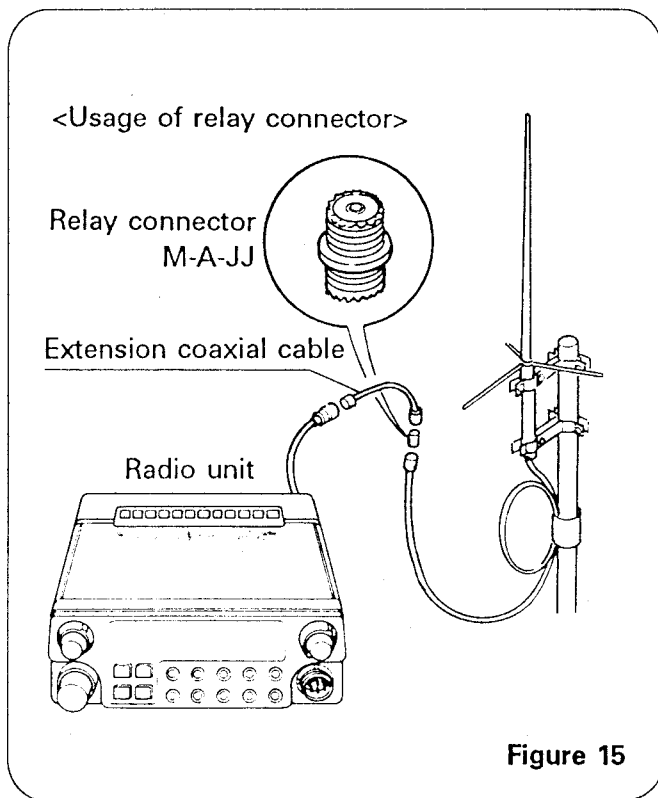
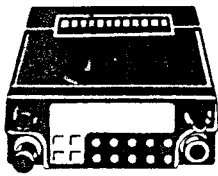

Figure 15

Before use

1. Microphone

The radio unit can be operated on itself or on an accessory remote control microphone (CMP839).



Radio unit itself

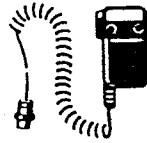

Remote control microphone

Note

When connecting or disconnecting the remote control microphone to or from the radio unit itself, turn OFF the power of the radio unit itself beforehand.

2. Power switch

The power can be turned ON/OFF by the hand pressure of the dial at the right side of the radio unit itself. More, the power can also be turned ON/OFF from on the remote control microphone.

3. Display section

1) Of the display section, the right side is for 430 MHz band and the left side is for 144 MHz band.

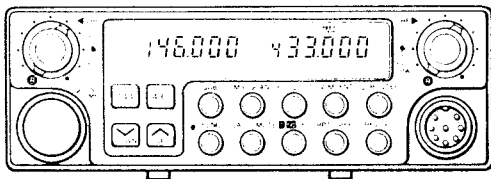

2) Main band and sub band

- 1) The band corresponding to the display side at which "MAIN" is displayed is referred to as the main band.
- 2) Therefore, the other band, for which "MAIN" is not displayed, is referred to as the sub band.

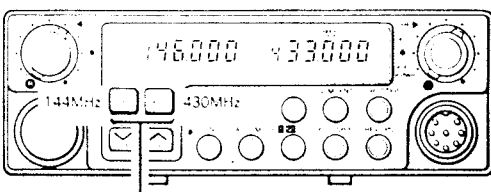

Band selection buttons

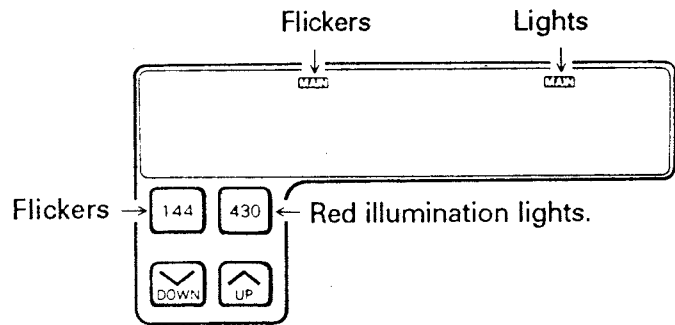

When the sub band mode is engaged, those functions for the sub band side can be operated.

For the main band mode, the band selection buttons are illuminated red, while for the sub band mode, they are illuminated green.

For the sub band mode, the illumination of the band selection button "144" or "430" flickers.

4. Volume control

- Rotate the volume control knob of either band clockwise to optimize the reception sound.
- When the volume control knob of either band is rotated counterclockwise fully (at which time a click sound is heard), the remote control volume control mode in which the volume can be controlled on the remote control microphone is entered. In this mode, when the "▲" or "▼" button on the remote control microphone is pressed after pressing the VOL button on the same microphone, the volume can be controlled.

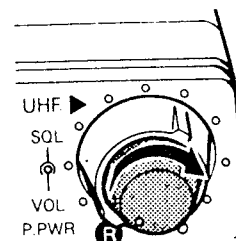

Manual volume control

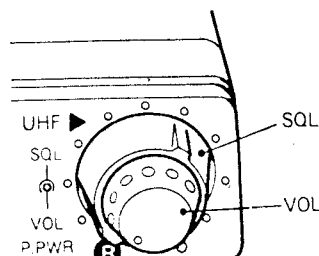

Remote volume control

5. Operation of C5608D

1 Direct operation method



2 Method of operation in function mode (in which state a green LED at the left of the FUNC button is lighting.)

(On the remote control microphone, "FUNC" appears on the display section.)

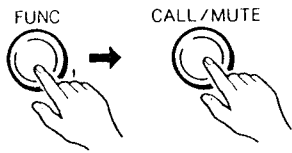

3 Method of operation while pressing the FUNC button

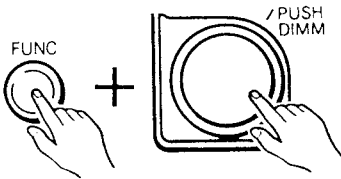

4 Method to obtain the set mode

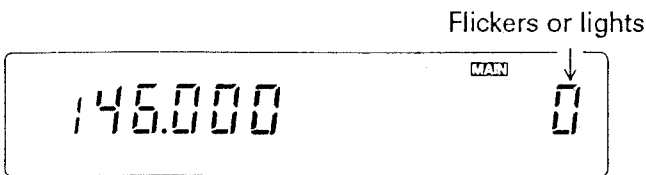
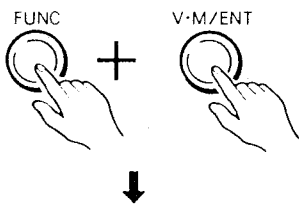

6. Beep tones

Beep tones are produced according to operations to check that a button is correctly operated.



Pip (short beep tone)

Emitted to inform that a control button is operated properly.



Peep (long beep tone)

Emitted to inform that an operation has been completed properly. (e.g. when a frequency has been written in the memory)



Boo (wrong beep tone)

Emitted to inform that a control button is operated improperly.



Pip-pip-pip-pip-pip
(five short beep tones)

Emitted to inform that reception is made using pager function.



Puff (puff tone)

Emitted to inform that VOL mode is canceled or that the auto repeater mode is re-set.





Pip-pop-pap

DTMF monitor sound

7. For easier reading of this book

- In this product, two operations are performed of the radio unit and the accessory remote control microphone CMP839 (hereinafter referred to as the remote control microphone).
- The operation example employs the 430 MHz band.

This manual is prepared basing upon the following rules:	
Mark	Meaning of mark
	Operation only on radio unit
	Operation only on remote control microphone A description in () is for operation on remote control microphone.
	Operation on radio unit and remote control microphone

Let me say a word for pleasant use.

- The C5608D, all controllable on the accessory microphone (CMP839), also permits frequency check (main band only). With an optional extension microphone cable CAW561/562, the C5608D itself can be placed under the car sheet or in the trunk room for use.
- Using an optional CAW560 (dual microphone cable), as shown in the drawing below, the radio unit can be operated by two microphones, one is CMP839 and the other is a mobile safety microphone, etc. connected through a connector.

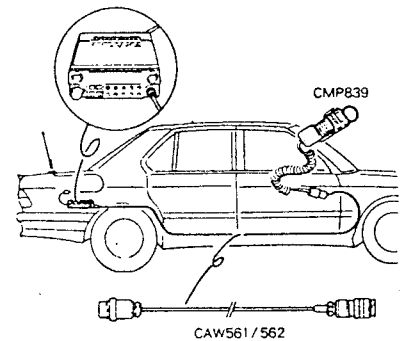

Notes

1. From the mobile microphone side, such micro-processor controls as frequency up/down, etc. are not feasible.
2. The interconnection between extension cables (CAW561 + CAW562) should be made at MAX. 6 m.
3. Separate between the high-frequency cable and the extension cable as much as possible.

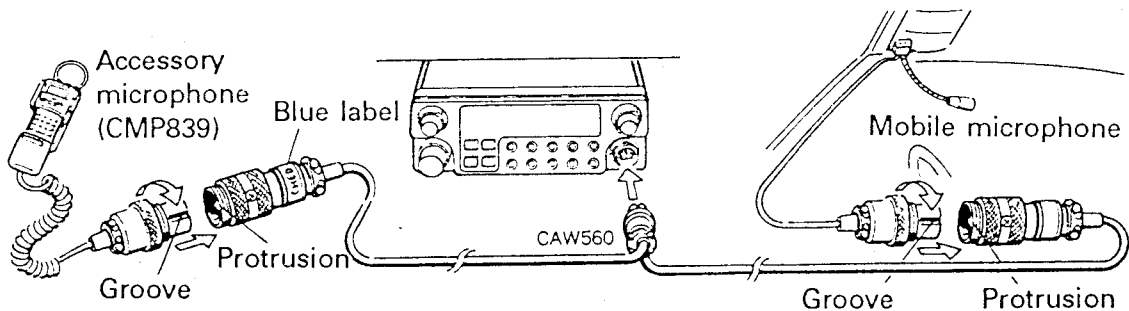

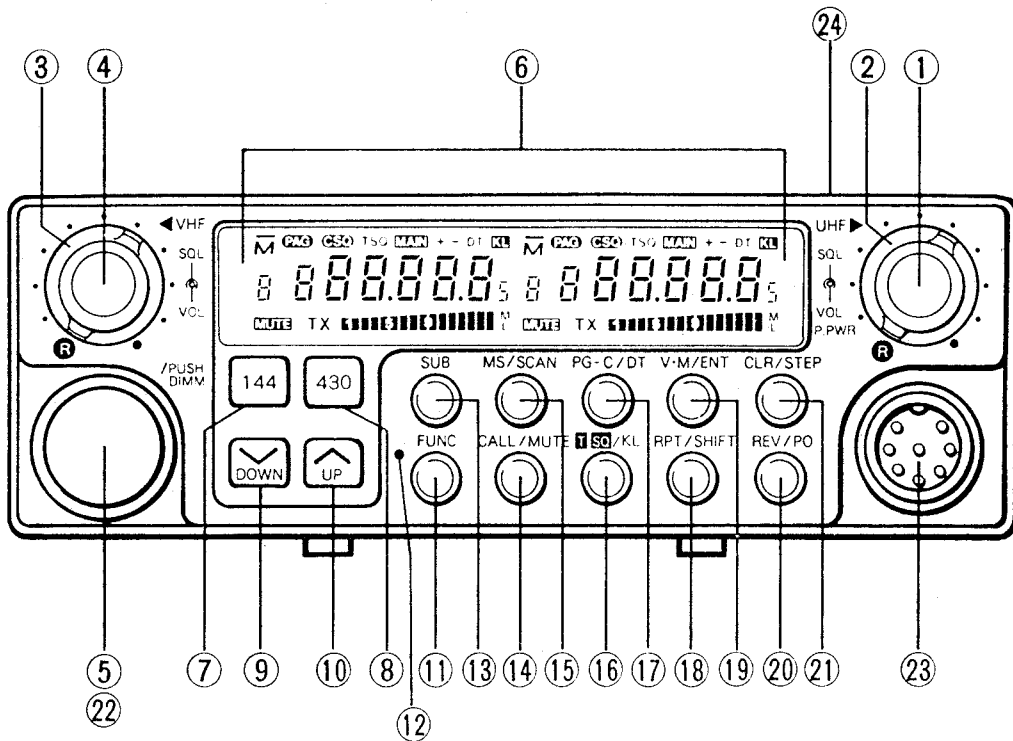

① VOL P.PWR [R] [power switch/volume control knob and remote control volume control switch (for 430 MHz band)]

Handle to turn ON/OFF the power, control the volume for 430 MHz band or turn ON/OFF the volume control made by the remote control microphone.

When this knob is pressed once, the power is turned ON. When it is pressed once again, the power is turned OFF.

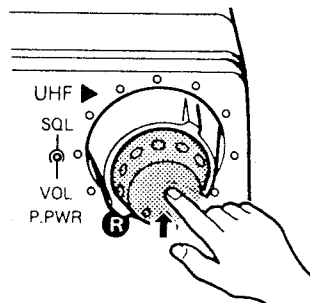

Power is turned ON.

- After unpacking, at first, when the power switch is set to ON, a display appears as shown below.

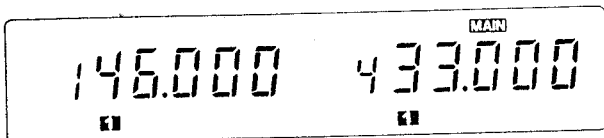

- Rotating the knob clockwise (↻) causes an increase in volume, while rotating the knob counterclockwise (↺) causes a decrease in volume.

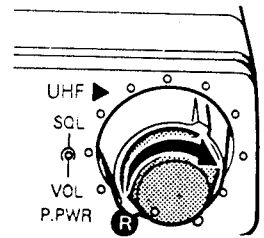

Increase in volume

- When the knob is rotated counterclockwise fully (↺), a click sound is heard and the remote control mode is entered, in which mode the volume control for 430 MHz band can be made from on the accessory remote control microphone CMP839.

② SQL [Squelch knob (for 430 MHz band)]

Squelch knob for 430 MHz band. Rotate to eliminate the noise peculiar to FM.

When the knob is rotated clockwise, the noise is heard from the speaker. Then, rotate slowly clockwise and stop at a point at which the noise disappears. (Initially, this knob has been rotated counterclockwise fully.)

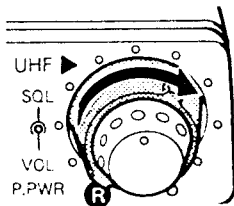

③ SQL [Squelch knob (for 144 MHz band)]

Squelch knob for 144 MHz band, which has the same function as the squelch knob for 430 MHz band.

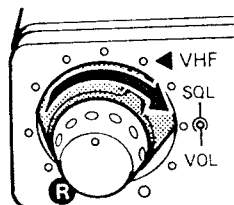

Notes

1. Do not rotate either SQL knob clockwise (↻) excessively, as this disables the reception of weak signals.
2. For scan operation, set the SQL adjustment completed (in which state the noise is not heard).
3. Perform the SQL adjustment with an unused channel.

④ VOL [Volume control knob/remote volume control switch (for 144 MHz band)]

Rotate to set or cancel the manual or remote volume control for 144 MHz band.

- The volume is increased as the knob is rotated clockwise (↻). While as the knob is rotated counterclockwise (↺), the volume is decreased.

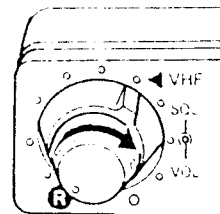

Increase in volume

- When the knob is rotated counterclockwise fully (↺), a click sound is heard, in which state the volume control for 144 MHz band can be made from on the remote control microphone.

⑤ Main dial knob

The main dial knob is provided with two functions: one for change in frequency and the other (DIMM) for change in illumination on the display section.

- Rotating the main dial knob clockwise (↻) causes increase in frequency, while rotating it counterclockwise (↺) causes decrease in frequency.

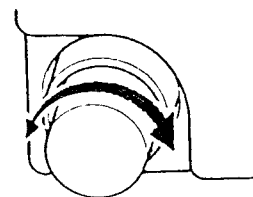

Decrease in frequency Increase in frequency

- While pressing the FUNC button, when the main dial knob is pressed, the illumination of the display section becomes dark. In this way, when it is pressed once again, the original illumination is restored.
- The reception or transmission frequency can be varied for 144 MHz and 430 MHz bands, separately. In addition, while performing transmission and reception on the main band, it is also possible to vary the sub band frequency.

⑥ Display section

As to the design of the display section, a large easy-to-see LCD (liquid crystal display) is employed with independent frequency displays of 144 MHz and 430 MHz bands, thus making the best of the twin bander capable of simultaneous receptions.

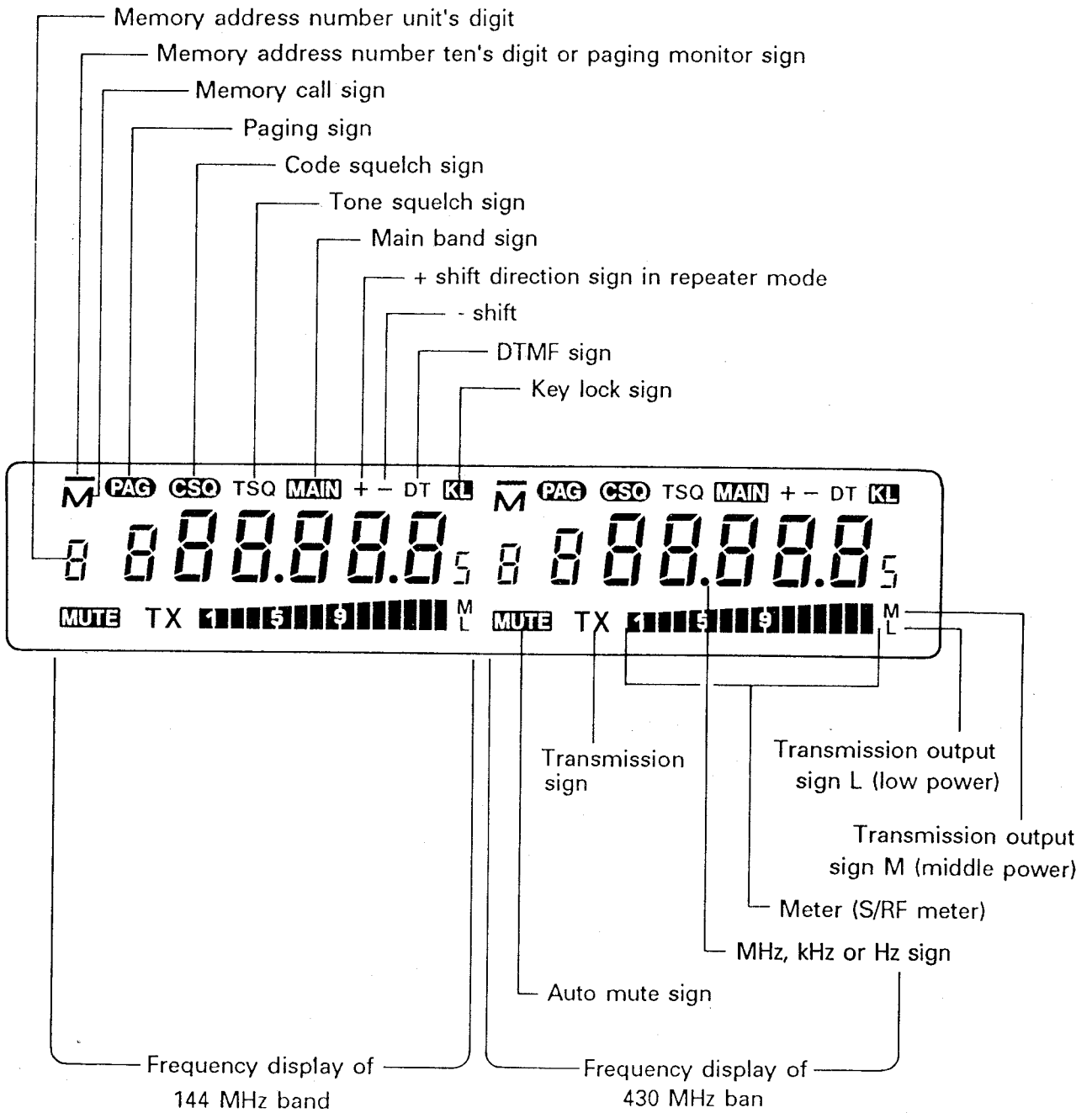

■ On S/RF meter

**Signal strength operation
(S meter)**

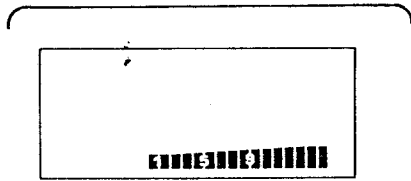

Its lighting proceeds from left to right depending upon the strength of the input signal.

Transmission output operation

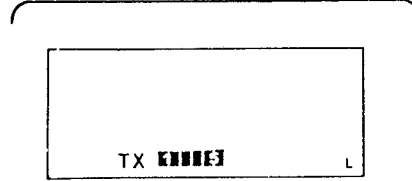

6 points light for transmission in Low power mode.

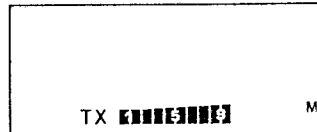

10 points light for transmission in Mid power mode.

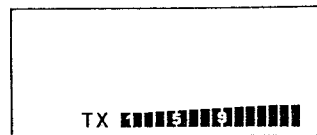

All light for transmission in Hi power mode.

Busy operation

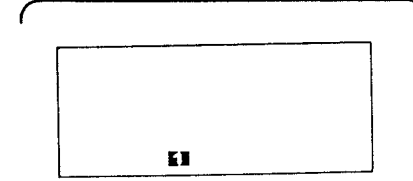

Lights when the squelch circuit is opened in the receive operation. The lighting of the left two points of the S meter indicates that the squelch circuit is open. In addition, the extinguishing indicates that the squelch circuit is closed.

⑦ **144 (main band select button)**

When this button is pressed, "MAIN" appears on the display side of the 144 MHz band, in which state transmission and reception is feasible on 144 MHz band. Its illumination is red for the main band mode, and green for the sub band mode. For the sub band mode, the illumination flickers.

⑧ **430 (main band select button)**

When this button is pressed, "MAIN" appears on the display side of the 430 MHz band, in which state transmission and reception is feasible on 430 MHz band. Its illumination is red for the main band mode, and green for the sub band mode. For the sub band mode, the illumination flickers. As to the initial setting (in factory setting or in resetting), "MAIN" is to appear on the display side of the 430 MHz band.

Notes

When transmission is made on 144 MHz band, interference may occur against the reception on 430 MHz band.

Preferably, do not set 3 times the frequency of 144 MHz band.

<Example> 145.025 MHz (transmission frequency)

435.075 MHz (reception frequency)

145.025 x 3 = 435.075

⑨/⑩ **DOWN [down button]/UP [up button]**

- Press to vary the frequency of the main band. Each time the button is pressed, the frequency varies by 1 MHz.
- Pressing the UP button continuously causes continuous increase in frequency, while pressing the DOWN button continuously causes continuous decrease in frequency. For code setting in paging or code squelch function, these buttons are also used for increase and decrease in code address number.

⑪ **FUNC**

Press to engage the function mode. The state that its associated green LED is lighting shows the function mode. The function mode is automatically canceled unless a valid input is made for about 3 continuous seconds.

⑫ FUNC LED

Lights when the function mode is engaged by pressing the FUNC button.

- When any further button operation is not made, the function mode is automatically canceled about 3 seconds later. Thus, the FUNC LED also goes out. (On the remote control microphone, the FUNC 0 button refers to the said FUNC button.)

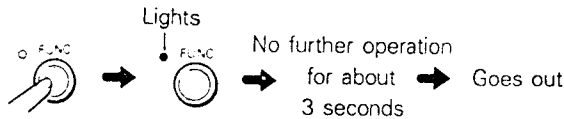

- In the function mode, when the V.M/ENT button is pressed, the frequency direct input mode is engaged, in which state the FUNC LED lights until a frequency is set. (On the remote control microphone, the ENT DIRECT* button refers to the said V.M/ENT button.)



Note

Of the display section of the remote control microphone, "FUNC" has the same operation as does the FUNC LED of the radio unit itself.

⑬ SUB [sub button]

The sub band refers to the band for which "MAIN" is not displayed.

Press to engage the sub band mode, which is used in change in frequency, etc. for the sub band.

- When the SUB button is pressed, "MAIN" flickers on the display side of the sub band, in which state operation is made for the sub band side. When any valid input is not made for about 5 seconds, the sub band mode is automatically canceled. In addition, operation is feasible even while transmission is made on the main band.



Flickers: During flickering (5 seconds), start operation.

Without operation, the previous status is restored.

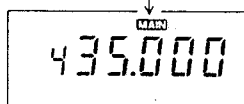

Sub band

⑭ CALL/MUTE

Press to call the call frequency (call channel) or set or cancel the audio auto mute mode. (Setting is possible for 144 and 430 MHz bands, separately.)

- When the FUNC LED on the display section is extinguished, the call frequency is called. Of 144 MHz band, the initial set value is 146.00, and of the 430 MHz band, 433.00.



- The call frequency can be varied arbitrarily. Therefore, this feature can be used for priority call through a club channel, etc. For more details, see page 32. When the FUNC LED is lighting, pressing this button causes the audio auto mute operation to be set or canceled.
- This feature serves automatic decrease in volume to alleviate the undesirable sound of a not often used band and serves listening ease of an often used band.
- When a signal is sensed on the band for which "MUTE" is not displayed, this feature provides automatic decrease in volume of the sound from the speaker of the band for which "MUTE" is displayed so that listening ease is ensured for the band for which "MUTE" is not displayed.

--Perform operation for 430 MHz band in like manner--

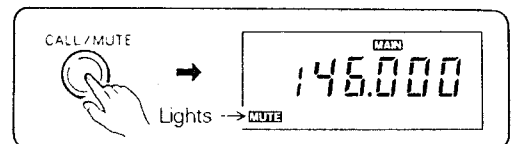
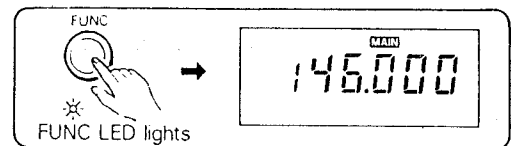

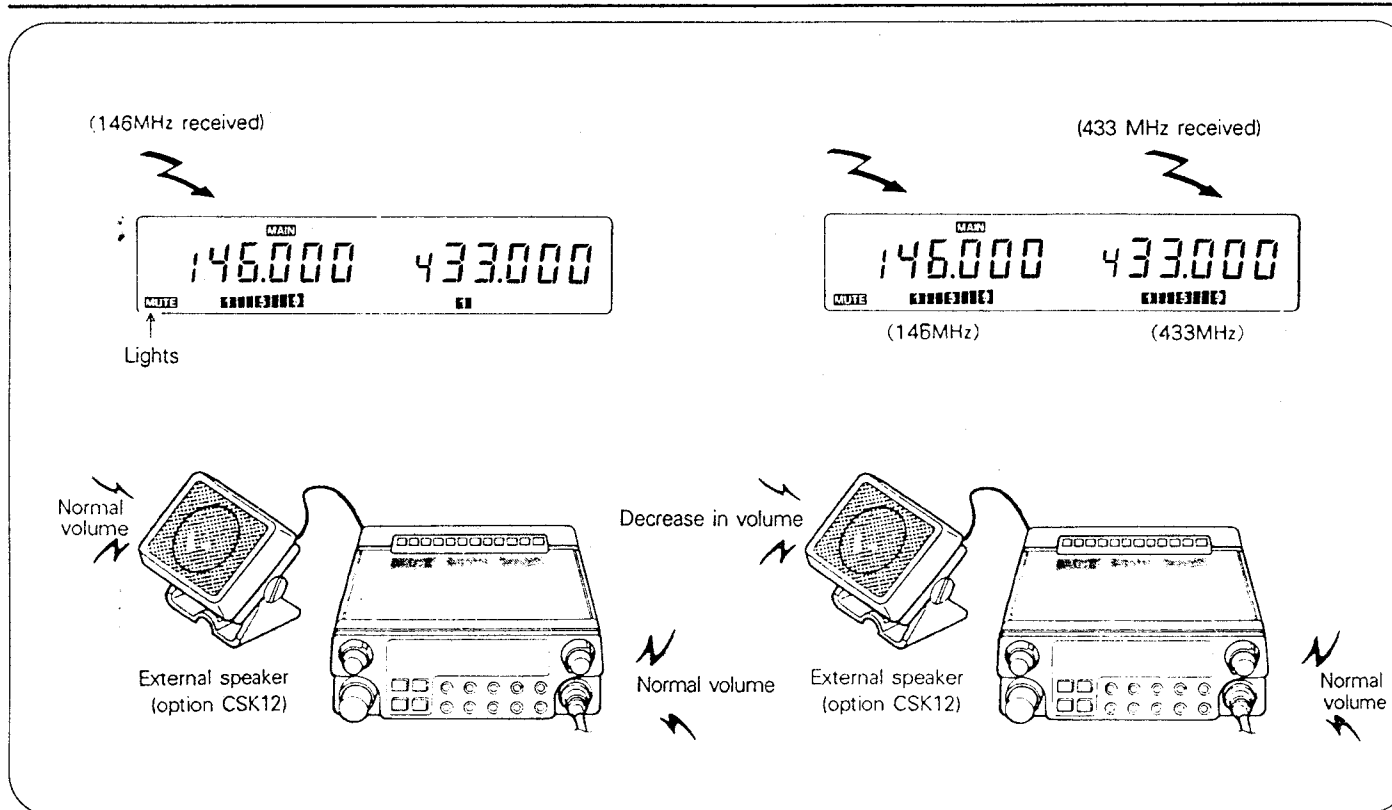

⑮ MS/SCAN

Press to set or cancel the memory scan operation or set or cancel the normal scan operation.

- On the display section, when the FUNC LED is off, pressing this button causes setting or canceling the memory scan operation.
- On the display section, when the FUNC LED lights, pressing this button causes setting or canceling the normal scan operation.

⑯ [T][SQ]/KL

Press to set or cancel the tone encode or tone squelch operation, call the tone frequency or set or cancel the key lock function on the radio unit itself.

- When the FUNC LED is off, when this button is pressed, the tone encode and tone squelch operation is set or canceled. Concretely, when the button is pressed, the tone encode mode is engaged, in which state "T" appears on the display section. Thus, when it is pressed once again, the tone squelch operation mode is engaged, in which state "TSQ" appears on the display section. Further, when it is pressed once more, the normal operation mode is engaged.
- When the FUNC LED is off, when this button is pressed continuously for more than about 0.5 second, the tone frequency display is provided. The tone frequency initial value is 88.5 Hz.

- When the FUNC LED lights, when this button is pressed, the following buttons are locked. (The key lock function can be set for 144 MHz band and 430 MHz band, individually.)

**DOWN, UP, MS, SCAN, CALL, MUTE, T SQ,
RPT, SHIFT, REV, PO, MAIN DIAL**

Notes

1. Without an optional tone squelch unit CTN560 connected, the tone encode and the tone squelch operations are not available. With this optional tone squelch unit CTN560 connected, the tone squelch operation is feasible for the 144 MHz and 430 MHz bands, separately.
2. Communications are feasible between station on the same tone frequency. Communication are not feasible between stations on different tone frequencies or with a radio inoperable on tone frequency.
3. For tone squelch operation, preset the tone frequency mutually.
4. After termination of tone squelch operation cancel the tone squelch operation mode. When the tone squelch operation mode remains engaged, it is impossible to hear the contents of communication with another station running in normal operation.

5. The KL key of the radio unit itself and the key lock switch of the remote control microphone are independent from each other, not in response to each other.

6. The main dial in the key lock mode is enabled due to set mode No. 6. For more information, refer to "6. Set mode" on page 53.

⑰ PG-C/DT

Press to select between paging, code squelch and normal operation, or call the PAG, CSQ code (PG-C code), or set or cancel the DTMF mode or call the DTMF code.

- When the FUNC LED is off, when this button is pressed, the paging operation or code squelch operation is set or canceled.

Concretely, when the button is pressed, the paging mode is engaged, in which state "PAG" appears on the display section. In this way, when it is pressed once again, the code squelch mode is engaged, in which state "CSQ" disappears on the display section and then the status (normal operation) prior to button pressure is restored.

When it is pressed continuously for about 0.5 second, the paging code is called.

- When the FUNC LED is lighting, when this button is pressed, the DTMF mode is set or canceled. In this way, when the button is pressed continuously for about 0.5 second, the DTMF code is called.

Notes

1. Without an optional DTMF unit CTD5600 connected, the paging operation, code squelch operation and DTMF operation are not available.

With the CTD5600 connected, the paging operation or code squelch operation is available for the 144 MHz and 430 MHz bands, independently.

2. In the paging operation or code squelch operation, communications are feasible with a station on the same code. Communications are not feasible with a station on a different code or a radio not having the paging function and code squelch function.

⑱ RPT/SHIFT

Press to set or cancel the repeater operation, set or cancel the shift direction or call the shift frequency.

- When the FUNC LED is off, when this button is pressed, the repeater operation is set or canceled. Concretely, when the button is pressed, the repeater mode is engaged, in which state "T" and "-" appear on the display section. Thus, when the button is pressed once again, the shift direction is changed, at which time "T" and "+" appear. Further, when it is pressed once more, the status (normal operation) prior to button pressure is restored.

- When the FUNC LED is lighting, when the button is pressed, the shift direction is set or canceled. Concretely, when this button is pressed, the shift direction is set to "-", in which state "-" appears on the display section. Thus, when it is pressed once again, the shift direction is changed to "+", at which time "+" appears instead. When it is pressed once more, the status (normal operation) prior to button pressure is restored.

- When the FUNC LED is lighting, when the button is pressed continuously for more than about 0.5 second, the shift frequency display for repeater operation is engaged. (Initial values are 0.6 MHz for VHF and 1.6 MHz for UHF.)

Note

Without an optional CTN5600 connected, the "T" is not displayed.

⑲ V-M/ENT

Press to select between VFO frequency display mode and memory frequency display mode or rewrite memory frequency, call frequency or code.

- When the FUNC LED is off, when this button is pressed, the memory frequency call mode is engaged. Thus, when it is pressed once again, the status prior to button pressure is restored.

- When the FUNC LED is lighting, when this button is pressed, the memory frequency or call frequency rewrite mode is engaged. Thus, when it is pressed once again, those contents are registered.

20 REV/PO

Press to reverse the transmission frequency and reception frequency with each other in the repeater operation or select the transmission output level.

- When the FUNC LED is off, when this button is pressed, the transmission frequency and reception frequency are reversed with each other in the repeater operation, in which reverse mode sign "+" or "-" representing the shift direction flickers.

Note

In the reverse mode, when the frequency is altered, the reverse mode is canceled.

(For shift frequency 1.600 MHz)

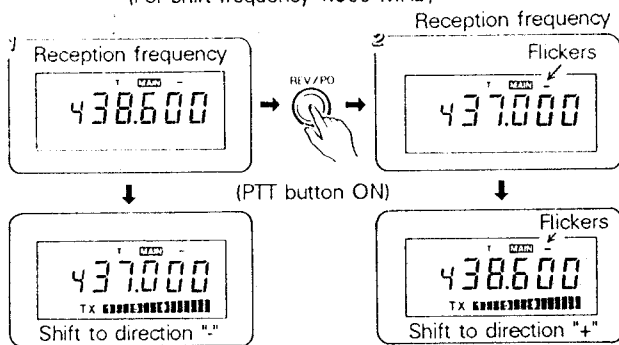

- When the FUNC LED is lighting, when the button is pressed, the transmission output level is changed. Concretely, when it is pressed once, "M" appears on the display section, in which state the transmission is made in the Mid power mode. When it is pressed once again, "L" appears, in which state the transmission is made in the Low power mode. Further, when it is pressed once more, "L" disappears and the original Hi power mode is restored.

Notes

1. Initially, the transmission output is set to the Hi power mode, at which time "L" and "M" do not appear on the display section.
2. Perform the same operation for the 430 MHz band as well.

21 CLR/STEP

Press to return to the VFO frequency display mode from any other mode or call the tuning step display.

- When the FUNC LED is off, when this button is pressed, the previous frequency display mode is restored from any other mode. More, from the call frequency display mode or memory frequency display mode, the call frequency or memory frequency is subject to shift to the VFO frequency display mode as it is.
- When the FUNC LED is lighting, when this button is pressed, the tuning step display is engaged, in which state the tuning step can be varied by the main dial. Six tuning steps are given, 5 kHz, 10 kHz, 12.5 kHz, 20 kHz, 25 kHz and 50 kHz. The tuning step can be set for 144 MHz band and 430 MHz band, individually.
- Selection between tuning steps is made by the CLR/STEP button. Tuning steps are, 5 kHz, 10 kHz, 12.5 kHz, 20 kHz, 25 kHz and 50 kHz.

22 /PUSH DIMM

Press to vary the illumination of the large LCD in two steps. While pressing the FUNC button, when the main dial knob is pressed, it becomes dark. Thus when it is pressed once again, it is restored to original.

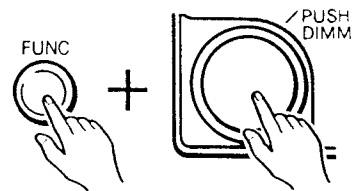

②③ Microphone connector terminal

Terminal to connect the accessory microphone. The pin layout of the microphone connection terminal is as shown in the drawing below.

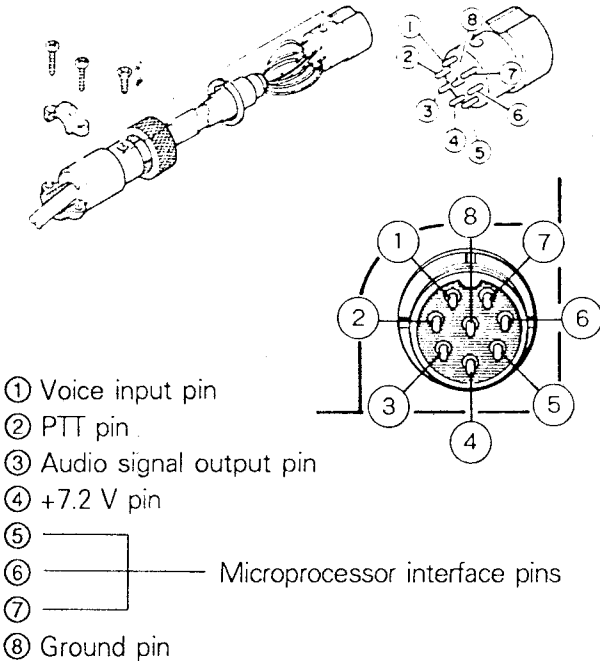

Notes

1. Pins 5, 6 and 7 serve for I/O for the microprocessor of the radio unit itself. When using a microphone other than the accessory microphone CMP839, no connection should be made with any of these pins 5, 6 and 7.

2. For a microphone other than the accessory microphone CMP839, use an electret condenser microphones with impedance of 1.5 kohms to 2.5 kohms. Be sure to add a 5.2 V zener diode to prevent excessive voltage.

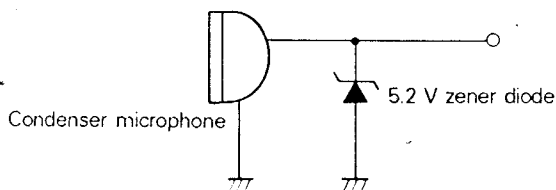

3. When connecting the remote control microphone to the radio unit itself, be sure to turn off the power of the radio unit beforehand.

4. When taking out the audio signal output from the microphone connector's pin 3 for use in packet communications, etc., take care to the following points:

1) From the microphone connector's pin 3, the audio signal whose level corresponds to each position of the VHF/VUF volume control knobs is also output.

2) With an external speaker connected, the audio signal output from the microphone connector's pin 3 depends upon the connection of the external speaker to the EXT SPKR terminal on the rear side of the radio unit itself as shown on the table below.

EXT SPKR		Microphone connector's pin ③ output
VHF	UHF	
X	X	Output for VHF and UHF
X	○	Same as above
○	X	Output for UHF only
○	○	Same as above

○:Connected X:Unconnected

②④ Reset terminal (inside the radio unit)

Terminal to hardware-reset the microprocessor. When the microprocessor backup lithium battery has been replaced, when the microprocessor performs a faulty operation, remove the four screws fixing the upper cover of the radio unit and detach the upper cover. Short the white-colored connector pin shown in the drawing below by a metallic piece, and the display on the large LCD will momentarily disappear and then "146.00" and "433.00" appear.

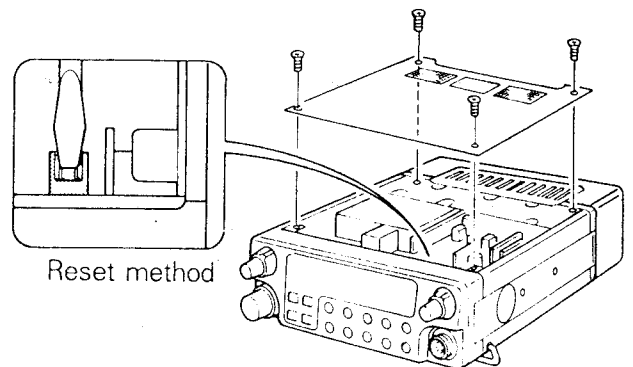

Notes

1. When resetting the microprocessor, keep the power cord of the C5608D connected to the power supply.

2. After hardware-resetting, when the microprocessor performs a faulty operation once the power cord is disconnected from the power supply, replace the lithium battery.

3. Never handle the microprocessor except for its resetting, as this may cause failure.

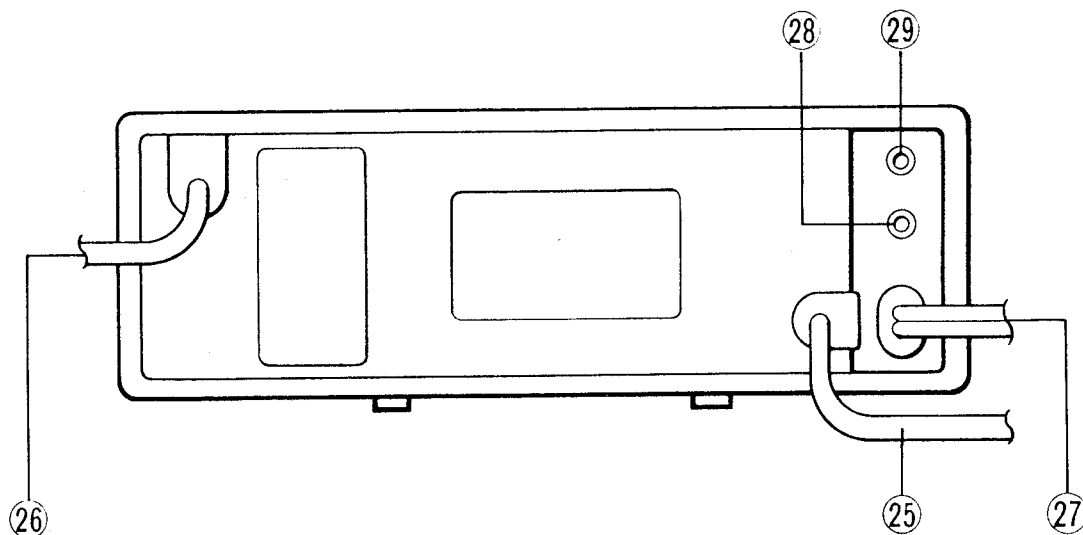

②⑤ 430 MHz band ANT

[coaxial cable for 430 MHz band]

An M type connector equipped coaxial cable to connect the coaxial cable running from the antenna. For the coaxial cable running from the antenna, be sure to use a 50-ohm type.

②⑥ 144 MHz band ANT

[coaxial cable for 144 MHz band]

An M type connector equipped coaxial cable to connect the coaxial cable running from the antenna. For the coaxial cable running from the antenna, be sure to use a 50-ohm type.

②⑦ DC 13.8 V [power cord]

A plug equipped power cord to apply DC 13.8 V. Route the accessory connection cord of 2.0 m to supply power to the radio unit.

Notes

- 1. This product is used exclusively with a 12 V type car.
For use with a 24 V type car like a truck, a DC-DC converter is necessary to use.**
- 2. When replacing the fuse, be sure to use a 12 A for C5608D.
Never use any other fuse than specified.**

⑳ 144 MHz band/EXT SPKR

[144 MHz band speaker terminal]

Terminal to connect the external speaker. The external speaker connected works for 144 MHz band, and the built-in speaker of the radio unit works for 430 MHz band.

㉑ 430 MHz band/EXT SPKR

[430 MHz band speaker terminal]

Terminal to connect the external speaker. The external speaker connected works for 144 MHz band and 430 MHz band, and the built-in speaker of the radio unit does not work.

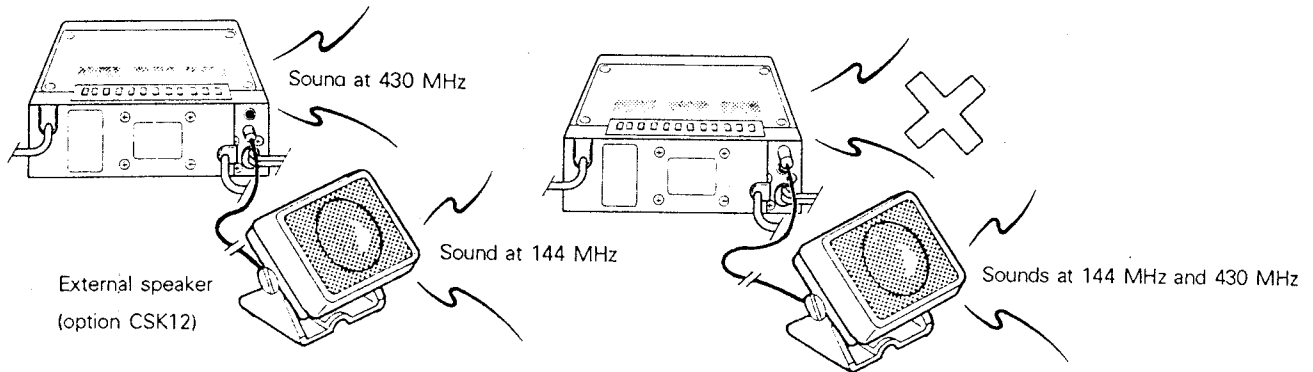

Advice

The external speakers connected for 144 MHz and 430 MHz bands either work for its individual purpose. At this time, the built-in speaker of the radio unit does not run.

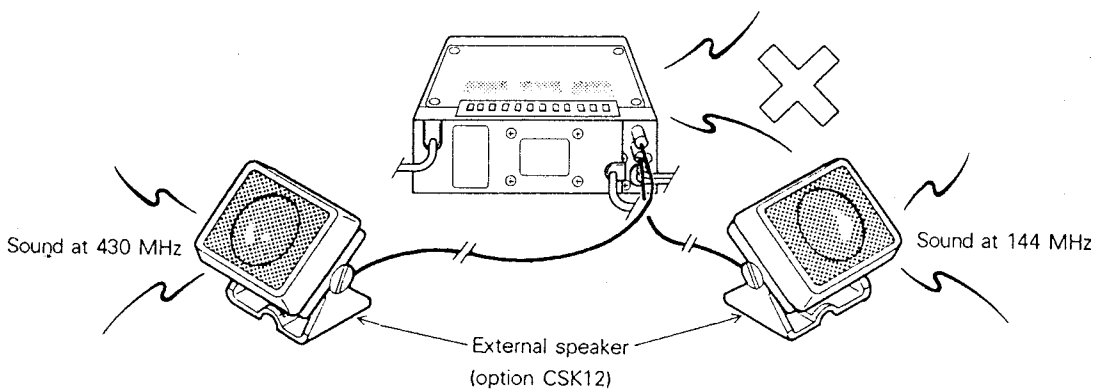

Remote Control Microphone

• Remote control microphone cover slide method

The cover of the remote control microphone can be slid. For button operation, open the cover in a manner as shown below for use. In addition, after termination of button operation, close the cover for use each time.

- By a thumb finger, push the cover lightly and slide it in the direction of an arrow.
- Slide it to a point at which it stops. The cover can be detached by further sliding. Operation is also possible with the cover removed.

Note

Do not slide the cover by a forcible pushing, as this may cause damage to the labeled plate.

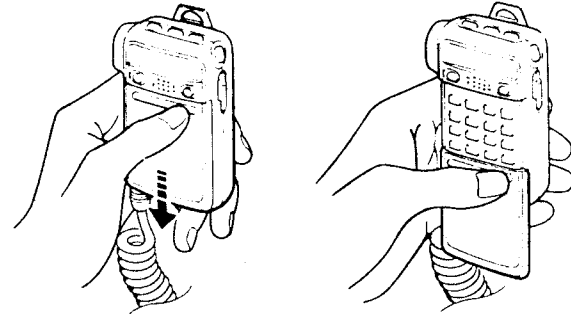

Front view

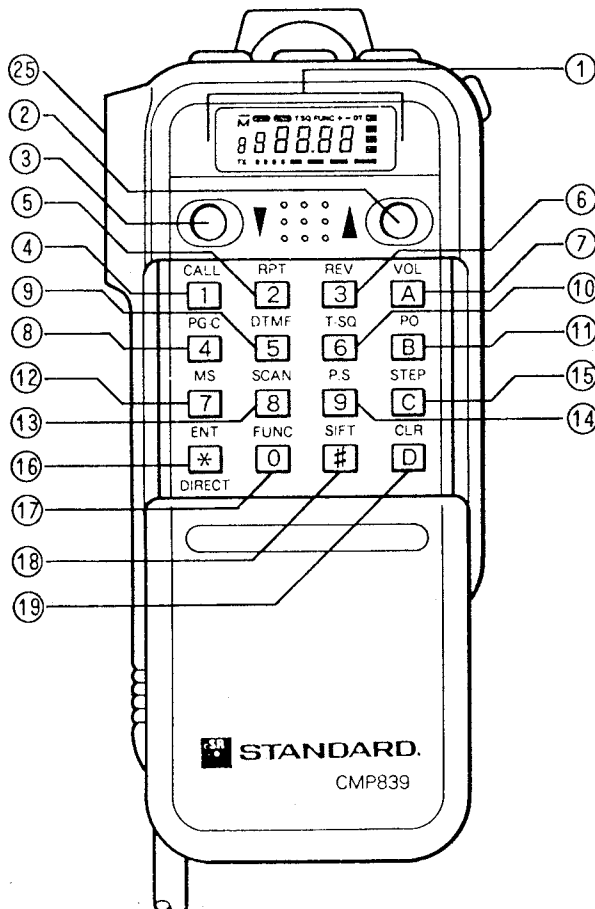

Top view

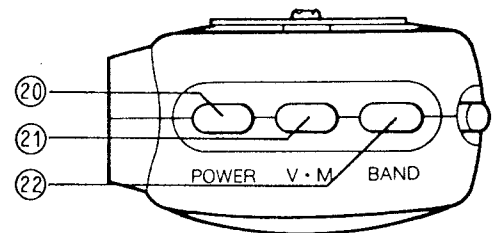

Side view

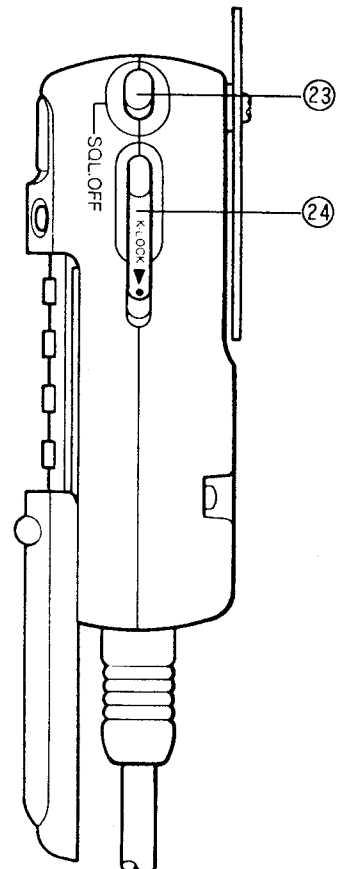

① Display section

For the display, an LCD is adopted, thus permitting ease in checking the operation on the remote control microphone. This LCD makes displays only for the main band of the radio unit itself.

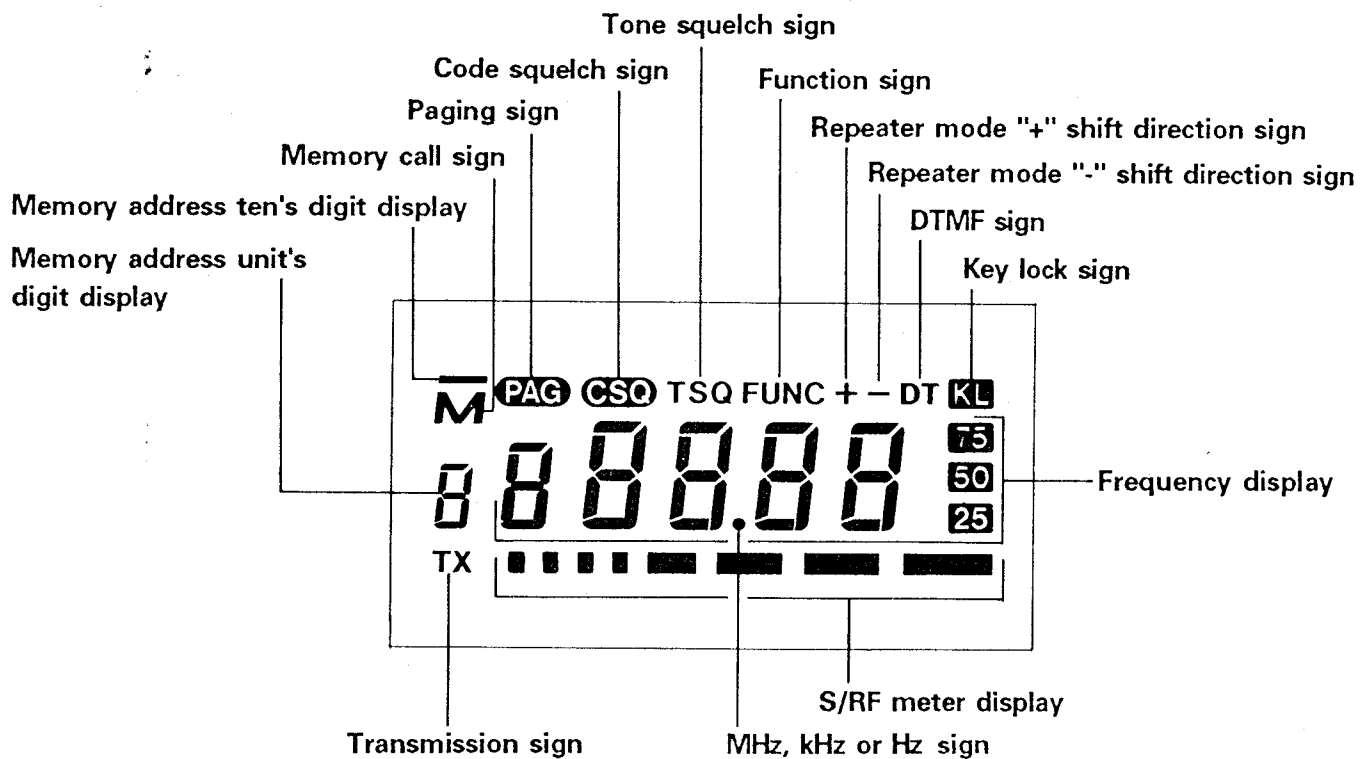

■ S/RF meter display

(For operation, refer to the description about the display section of the radio unit itself on page 17.)

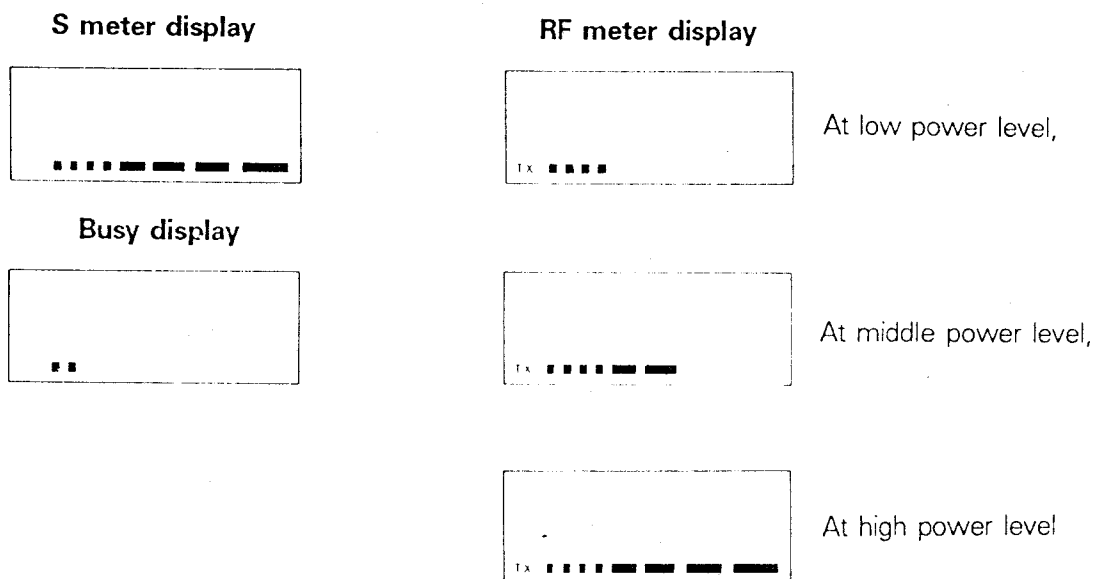

②/③ ▲ [up button]/ ▼ [down button]

Press for frequency alteration, memory address change, code address change, code change for paging or code squelch, or scan direction change or volume control.

④ CALL 1

Press to call the call frequency or enter numeral 1 or transmit DTMF signal 1.

- When this button is directly pressed, the call frequency display is engaged.
- For direct input, when it is pressed, numeral 1 is entered.
- While pressing the PTT button, when it is pressed, DTMF signal 1 is transmitted.

⑤ RPT 2

Press to set or cancel the repeater operation, enter numeral 2 or transmit DTMF signal 2.

- When this button is pressed directly, the repeater mode is engaged, at which time "T" and "-" appear on the display section. When it is pressed once again, the shift direction is changed, at which time "T" and "+" appear. Further, when it is pressed once again, the normal operation mode is restored.
- When this button is pressed in the frequency set mode, numeral 2 is entered.
- While pressing the PTT button, when this button is pressed, DTMF signal 2 is transmitted.

Note

Without an optional CTN5600 connected, the "T" does not light up in the display section.

⑥ REV3

Press to reverse the transmission frequency and the reception frequency with each other in the repeater operation, enter numeral 3 or transmit DTMF signal 3.

- When this button is pressed directly in the repeater operation, reversal is made between the transmission frequency and the reception frequency, at which time sign "+" or "-" indicating the shift direction flickers.
- When this button is pressed in the frequency set mode, numeral 3 is entered.
- While pressing the PTT button, when this button is pressed, DTMF signal 3 is transmitted.

⑦ VOL A

Press to engage the VOL mode in which the volume of the radio unit itself is controlled from the remote control microphone, or transmit DTMF signal A.

- When the radio unit itself is in the remote controller volume control mode, when this button is pressed directly, the volume of radio unit itself can be controlled remotely.
- While pressing the PTT button, when this button is pressed, DTMF signal A is transmitted.

⑧ PG-C 4

Press to select between the PAG (paging) mode CSQ (code squelch) mode and normal operation mode, or enter numeral 4 or transmit DTMF signal 4

- When this button is pressed directly, the paging mode is engaged, at which time "PAG" appears on the display section. Thus, when it is pressed once again, the code squelch mode is engaged, at which time "CSQ" appears on the display
- When this button is directly pressed continuously for about 0.5 second, the paging code is called.
- When this button is pressed in the frequency set mode, numeral 4 is entered.
- While pressing the PTT button, when this button is pressed, DTMF signal 4 is transmitted.

Notes

1. Without an optional CTD5600 connected, the paging operation and code squelch operation are not available.

With the CTD5600 connected, the paging operation or code squelch operation is available for 144 MHz band and 430 MHz band, separately.

2. For the paging operation or code squelch operation, communications are feasible with a station on the same code, and not with a station on a different code or with a radio inoperable on paging or code squelch operation.

⑨ DTMF 5

Press to set or cancel the DTMF mode, set the DTMF code and enter numeral 5, or transmit DTMF signal 5.

- When this button is pressed directly, the DTMF mode is set.
- When this button is directly pressed continuously for about 0.5 second, the DTMF code display is made.
- When this button is pressed in the frequency set mode, numeral 5 is entered.
- While pressing the PTT button, when this button is pressed, DTMF signal 5 is transmitted.

Note

Without an optional DTMF unit CTD5600 connected, the DTMF operation is not available.

⑫ T-SQ 6

Press to set or cancel the tone encode/code squelch operation, call the tone frequency and enter numeral 6, or transmit DTMF signal 6.

- When this button is pressed directly, the tone encode mode is engaged, at which time "T" appears on the display section. Thus, when it is pressed once again, the tone squelch operation mode is engaged, at which time "TSQ" appears on
- When this button is directly pressed continuously for about 0.5 second, the tone frequency display appears.
- When this button is pressed on the frequency set mode, numeral 6 is entered.
- While pressing the PTT button, when this button is pressed, DTMF signal 6 is transmitted.

Notes

1. Without an optional CTN5600 connected, the tone encode and the tone squelch operation is not available.

With this CTN5600 connected, when the T. SQL button is pressed, the tone squelch operation is feasible for 144 MHz band and 430 MHz band, separately.

2. Communications are feasible between stations on the same tone frequency, and not with a station on a different tone frequency or with a radio inoperable on the tone operation.

⑪ PO B

Press to select between transmission output levels or transmit DTMF signal B.

- When this button is pressed directly, selection is performed between transmission output levels. Concretely, when it is pressed once, the Mid power mode is engaged, at which time one central segment of the RF meter flickers on the display section. Thus, when it is pressed once again, the Low power mode is engaged, at which time
- While pressing the PTT button, when this button is pressed, DTMF signal B is transmitted.

⑫ MS7

Press to set or cancel the memory scan operation, enter numeral 7 or transmit DTMF signal 7.

- When this button is pressed directly, the memory scan operation is set or canceled.
- When this button is pressed in the frequency set mode, numeral 7 is entered.
- While pressing the PTT button, when this button is pressed, DTMF signal 7 is transmitted.

⑬ SCAN 8

Press to set or cancel the scan operation, enter numeral 8 or transmit DTMF signal 8.

- When this button is pressed directly, the normal scan operation is set or canceled.
- When this button is pressed in the frequency set mode, numeral 8 is entered.
- While pressing the PTT button, when this button is pressed, DTMF signal 8 is transmitted.

⑭ PS 9

Press to set or cancel the program scan operation, enter numeral 9 or transmit DTMF signal 9.

- When this button is pressed directly, the program scan operation is set or canceled.
- When this button is pressed in the frequency set mode, numeral 9 is entered.
- While pressing the PTT button, when this button is pressed, DTMF signal 9 is transmitted.

⑮ STEP C

Press to call the tuning step display or transmit DTMF signal C.

- When this button is pressed directly, the tuning step display is called.
- While pressing the PTT button, when this button is pressed, DTMF signal C is transmitted.

⑩ ENT DIRECT *

Press to set the frequency set mode (direct input mode). register the memory frequency and call frequency to each mode or transmit DTMF signal * .

- When this button is pressed directly, the frequency set mode is engaged, in which mode frequency or code can be entered directly by numeral keys.
- Registration of memory and call frequencies to each mode.

For this, refer to the method of writing function to the memory frequency on page 40.

- While pressing the PTT button, when this button is pressed, DTMF signal * is transmitted.

⑪ FUNC 0

Press to set or cancel the function mode, enter numeral 0 or transmit DTMF signal 0. For the function mode, "FUNC" appears on the display section.

- When this button is pressed directly, the function mode is set or canceled. In addition, while pressing this button directly, when the ENT DIRECT * button is pressed, the set mode operation is engaged.
- When this button is pressed in the frequency set mode, numeral 0 is entered.
- While pressing the PTT button, when this button is pressed, DTMF signal 0 is transmitted.

⑫ SIFT

Press to set or cancel the shift direction, call the shift frequency or transmit DTMF signal #.

- When this button is pressed directly, the shift direction is set or canceled.
Concretely, when it is pressed, the shift direction is set to "-", at which time "-" appears on the display section. Thus, when it is pressed once again, the shift direction is changed to "+", at which time "+" appears. Further, when it is pressed once more, the status to button pressure is resumed.
- When this button is directly pressed continuously for about 0.5 second, the shift frequency display appears.
- While pressing the PTT button, when this button is pressed, DTMF signal # is transmitted.

⑬ CLR D

Press to return to the VFO frequency display mode from any other mode by clearing, or transmit DTMF signal D.

- When this button is pressed directly, the frequency display mode is returned to from another mode. In addition, in the call frequency display mode or memory frequency display mode, the call frequency or memory frequency is subject to shift to the VFO frequency display mode as it is.
- While pressing the PTT button, when this button is pressed, DTMF signal D is transmitted.

⑭ POWER [power switch]

Press to turn ON/OFF the powers of the radio unit itself and the remote control microphone. Power reset cannot be made simply by the remote control microphone in terms of software.

⑮ V-M [VFO -- MR]

Press to select between the VFO frequency display mode and the memory frequency display mode.

⑯ BAND [band selection]

Press to select between main band and sub band.

⑰ SQL. OFF [squench OFF]

While this button is pressed, sound is heard from speaker. This feature is convenient in reception of weak signal.

While pressing the PTT button, when this button is pressed, the tone burst signal of 1750 Hz is transmitted.

⑱ K. LOCK [key lock]

Of the remote control microphone, the following buttons are disabled from operation.

CALL, RPT, REV, PG-C, DTMF, T-SQ, PO, MS, SCAN, PS, STEP, ENT, SIFT, CLR, V-M, BAND

⑳ PTT [transmission button]

Press to enter the main band to the transmission mode.

Operation Method

1. SQL control

SQL control is operated only in the radio unit itself.

Procedure

- 1 Rotate the SQL knob clockwise and stop at a point at which the noise disappears.

Note

Do not rotate the SQL knob clockwise excessively, as this disables reception of weak signals.

2. Frequency setting

Two methods are available to set your desired frequency: pressing numeral keys on the remote control microphone or handling the main dial knob or the UP/DOWN button on the radio unit.

Method of frequency setting by main dial knob or UP/DOWN button on radio unit

Example: When setting 437.325 MHz

Procedure



- 1 Handle the UP or DOWN button for frequency setting of MHz order.
- 2 Handle the main dial knob for frequency setting of kHz order.

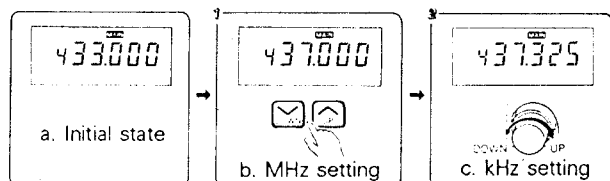

Method of frequency setting by numeral keys on remote control microphone

Procedure



Example: When setting 437.325 MHz

- 1 Press the ENT DIRECT * button to engage the direct input mode.

Note

The state that part of the frequency display disappears is referred to as the direct input mode. However, the frequency display all disappears for set mode No. 5.

Inputtable digits are erased. Accordingly, enter your desired frequency value by numeral keys.

(As frequency is only inputtable by 10 kHz, when your desired frequency has one digit number, input the closer frequency rounded by 10 kHz. In this example, 437.320 MHz.)

- 2 Press the MS 7 button.
- 3 Press the REV 3 button
- 4 Press the RPT 2 button. Therewith, entry is completed.

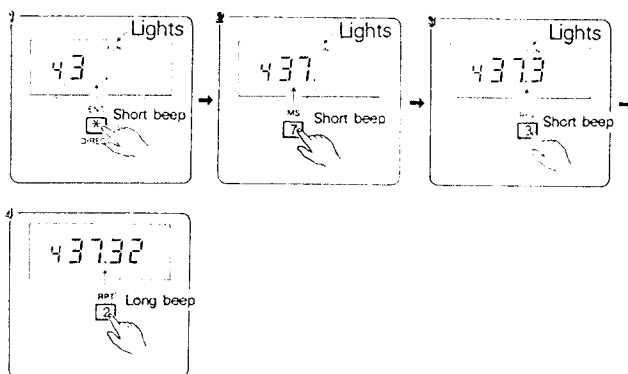

- 5 Handle the UP or DOWN button for frequency setting of MHz order.

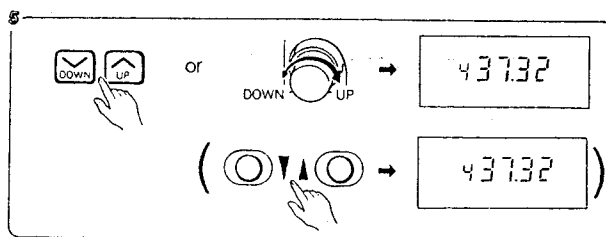

Note

On the way of frequency setting by numeral keys, when the main dial knob is rotated, the frequency setting is possible from that frequency value prior to setting.

Method of frequency setting of sub band

When the SUB button on the radio unit is pressed, the sign "MAIN" of the band which is thereby set as the sub band starts flickering. The frequency can be thus set in the same manner as for the main band. The sub band mode is canceled about 5 seconds later from the stop of operation.

1. Operation on call frequency

- When the CALL button is pressed, the call frequency is displayed on the display section. When it is pressed once again, the frequency display prior to pressing the CALL button is restored.
- The CALL button is to call the call frequency with priority.
- The call frequency, which is set initially, can be rewritten. More, the repeater mode can be set to the call frequency by writing.

Initial settings... 146.00 MHz for 144 MHz band
433.00 MHz for 430 MHz band

Procedure

- 1 On the radio unit, press a main band selection button to set the main band. (Otherwise, on the remote control microphone, press the BAND button.)
- 2 On the radio unit, press the CALL/MUTE button. (Otherwise, on the remote control microphone, press the CALL 1 button.)

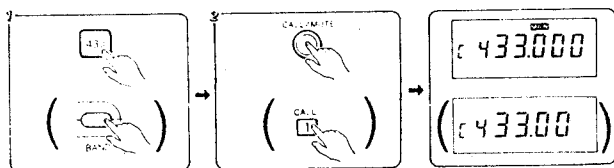

Method of rewriting the call frequency

1) Using main dial knob and UP/DOWN buttons

Procedure

- 1 On the radio unit, press the CALL/MUTE button. (Otherwise, on the remote control microphone, press the CALL 1 button.)

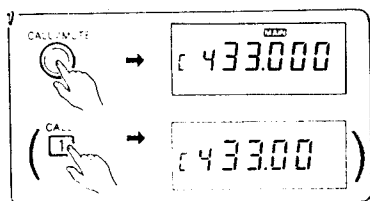

- 2 On the radio unit, press the FUNC button to engage the function mode, and then press the V•M/ENT button. (Otherwise, on the remote control microphone, press the ENT DIRECT * button.)

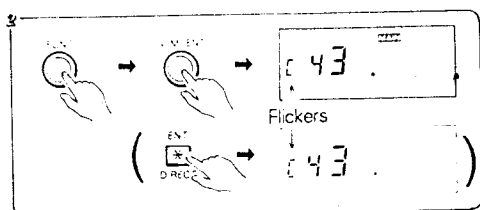

- 3 On the radio unit, set your desired frequency by the UP or DOWN button or the main dial knob. (Otherwise, on the remote control microphone, use the "▲" / "▼" button or numeral keys.)

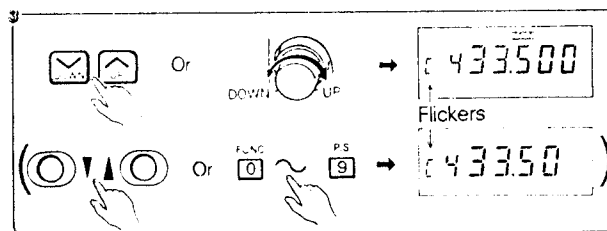

- 4 On the radio unit, press the FUNC button to engage the function mode, and then press the V•M/ENT button. On the display section, "C" will change from flickering to lighting, thus indicating the completion of rewriting. (Otherwise, on the remote control microphone, use the ENT DIRECT * button.)

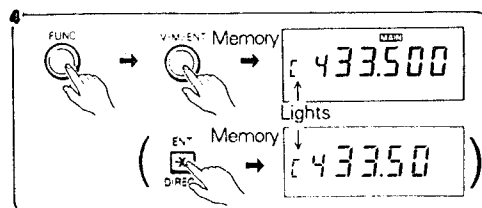

Note

For frequency rewriting, when an inputtable digit is erased, when the main dial knob or UP or DOWN button is handled, the frequency is changed from that frequency value prior to setting.

2) Method of frequency setting by direct input

Procedure

- 1 On the remote control microphone, press the CALL 1 button, then the ENT DIRECT * button.

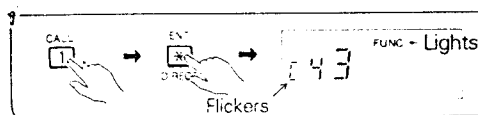

- 2 Enter your desired frequency by numeral keys.

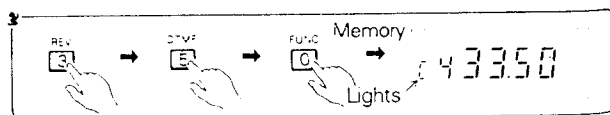

Concurrently with the entry of the final digit, the call frequency rewriting is completed.

2. Repeater operation method

Method of writing each mode to a call frequency

Procedure



- On the radio unit, press the CALL/MUTE button. (Otherwise, on the remote control microphone, press the CALL 1 button.)

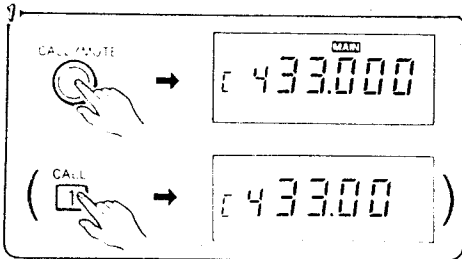

- Enter each mode (RPT, PAG, CSQ, TSQ, DTMF), and those respective modes will be written to the call frequency.

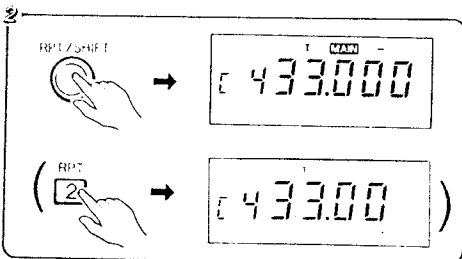

Note

The REV (reverse) operation is not memorized.

- In the function mode, press the V·M/ENT button twice on the radio unit, and the repeater mode will be memorized.

(Otherwise, on the remote control microphone, press the ENT DIRECT * button.)

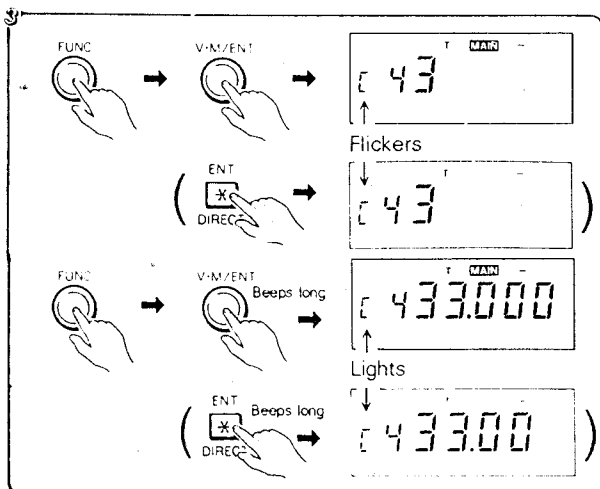

Note

Without an optional CTN5600 connected, the "T" does not light up in the display section.

Repeater Operation

QSO through repeater station (radio relay station) is available in the area where Repeater is built. Confirm its transmission/reception frequency by specialized magazine.

Features

- QSO is performed applying different frequencies for transmission and reception. Transceivers are thus required to have feature which shifts transmission/reception frequency. Internal tone encoder to operate repeater station is also required. 5608D contains 1750 Hz (fixed) tone encoder.
- Long distance QSO by Low Power Transceivers is attained through repeater station. For repeater operation, 5608D power, since further repeater stations applying same frequency with nearer one may be also accessed by high power operation.

Advices

- For repeater operation on memory frequency, the tone frequency set in memory is engaged.
- For repeater operation on VFO frequency, the tone frequency set in VFO is engaged.

Note

Avoid simplex operation on a repeater operating frequency as a band plan.

Ordinary Operation

TX RX: 433.250 MHz TX RX: 433.250 MHz

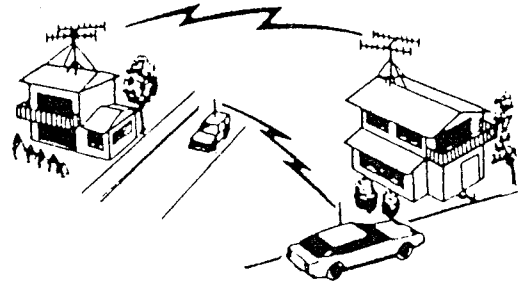

Repeater Operation

TX: 435.600 MHz RX: 434.000 MHz TX: 434.000 MHz RX: 435.600 MHz

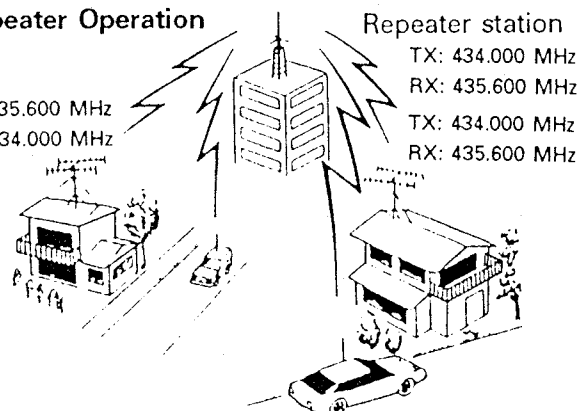

1. Method with frequency set

Procedure  

1 Let the frequency display appear.

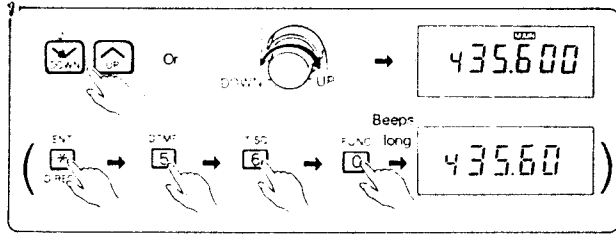

2 Enter the repeater mode.

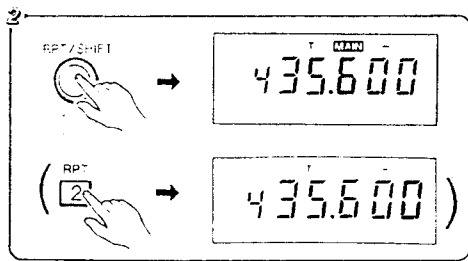

3 While pressing the PTT button on the remote control microphone, press the SQL. OFF button. The tone burst signal of 1750 Hz is transmitted.

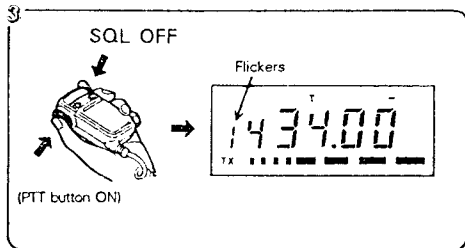

Advices

- In repeater operation, when the REV mode is engaged, the reception frequency is superseded. Sign "-" or "+" indicating the shift direction flickers.

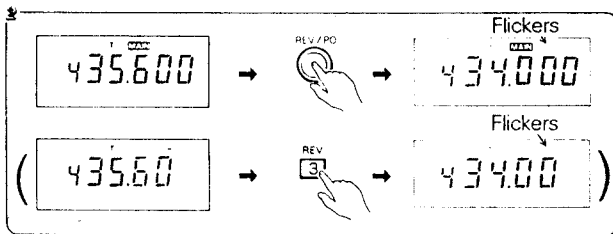

- In repeater operation, when the radio unit is in the function mode, when the RPT/SHIFT button is pressed on the radio unit or when the SIFT # button is pressed on the remote control microphone, the shift direction is reversed.

2. Using memory frequency

Procedure  

1 Set the band.

On the radio unit, press the V-M/ENT button to engage the memory call mode. Then, call the memory frequency.

(Otherwise, on the remote control microphone press the V-M button.)

For example where 435.60 is memorized at location M1:

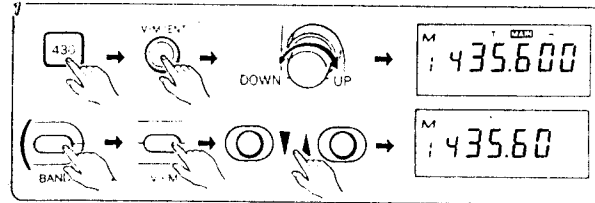

2 Enter the repeater mode.

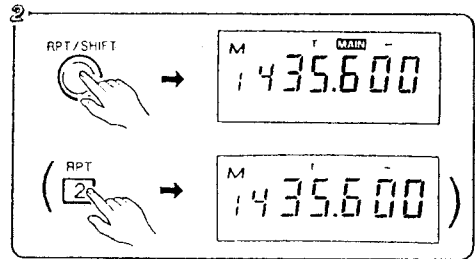

3 While pressing the PTT button on the remote control microphone, press the SQL. OFF button. The tone burst signal of 1750 Hz is transmitted.

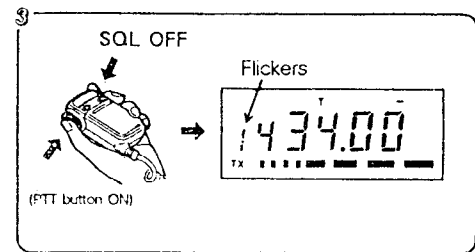

Note

Preset the repeater operating frequency in memory. For details, refer to the method of setting new frequency in memory on page 36.

Note

When the shift frequency comes off the amateur band (off-band), "OFF" appears on the display section, in which state no transmission is made.

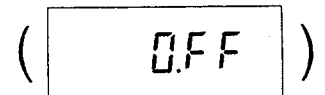
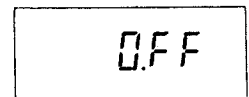

Method of setting the tone frequency in repeater operation

- Only with CTN5600 connected

With an optional tone squelch unit CTN5600 connected, the tone frequency can be altered arbitrarily.

Procedure 

- 1 Set the band.

- 2 On the radio unit, press the T SQ/KL button continuously for about 0.5 second.

(Otherwise, on the remote control microphone, press the T-SQ 6 button.)

Thus, the tone frequency display will appear on the display section.

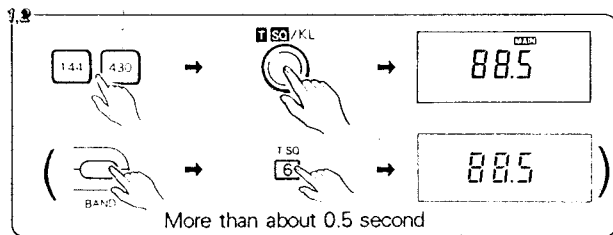

- 3 On the radio unit, set the tone frequency by the main dial knob or the UP or DOWN button.

(Otherwise, on the remote control microphone, press the "▼" or "▲" button.)

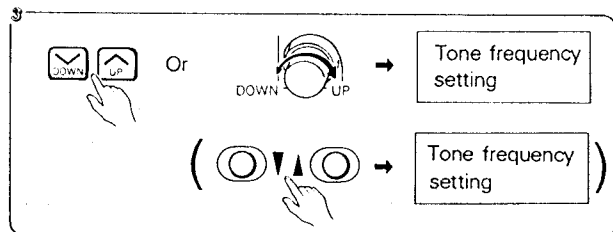

- 4 On the radio unit, when the T SQ/KL button is pressed, the frequency display prior to button pressure is restored.

(On the remote control microphone, press the T SQ 6 button.)

Advices

- Pressing continuously the UP or DOWN button or the "▼" or "▲" button causes continuous change of the tone frequency.

Method of altering the shift frequency in repeater operation

In this unit, a shift frequency of 5 MHz for repeater operation is memorized. This shift frequency can be altered arbitrarily.

The initial settings are as follows:

144 MHz band... 00.600 MHz (600 kHz)

430 MHz band... 01.600 MHz (1.6 MHz)

1) Method of setting by main dial or UP/DOWN button

Procedure 

- 1 Set the band.

- 2 On the radio unit, press the FUNC button to engage the function mode. After that, press the RPT/SHIFT button continuously for about 0.5 second, and the shift frequency display will appear on the display section.

(Otherwise, on the remote control microphone, press the SIFT # button.)

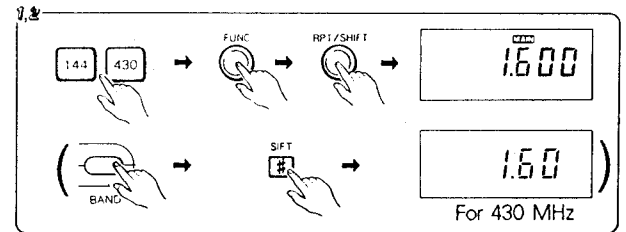

- 3 Set a new shift frequency by the main dial knob or the UP or DOWN button on the radio unit.

(Otherwise, on the remote control microphone, press the "▼" or "▲" button.)

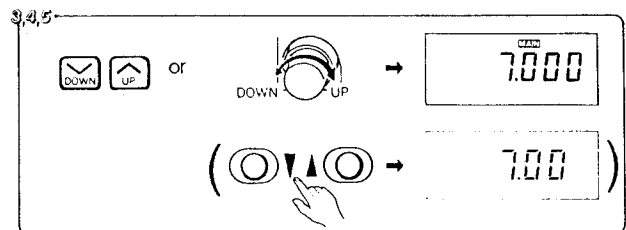

- 4 Press the RPT/SHIFT button on the radio unit in the function mode again, and the frequency display prior to button pressure will be restored.

(Otherwise, on the remote control microphone, press the SIFT # button again.)

- 5 The shift frequency is rewritten completely there-with.

3. Operation on memory frequency

2) Method of setting by numeral keys on remote control microphone

In this method, the shift frequency value is input directly (only on the remote control microphone).

Procedure

- 1 Set the band.
- 2 Press the SIFT # button continuously for about 0.5 second, and the shift frequency display will appear on the display section.

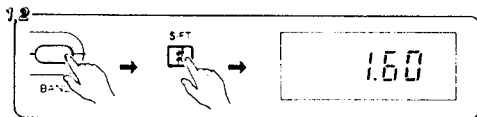

- 3 Press the ENT DIRECT * button, and inputtable digits will be erased from the display.

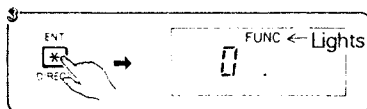

- 4 Enter your desired shift frequency by numeral buttons.

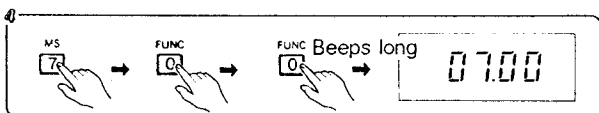

- 5 Press the SIFT # button, and the frequency display prior to button pressure will be restored.

- 6 The shift frequency is rewritten completely there-with.

Each band is provided with a memory capacity of 22 channels, thus eliminating both of frequency setting. Moreover, it is also possible to memorize such factors as repeater mode, shift frequency, tone frequency, tone squelch mode, paging mode, DTMF mode and CSQ mode so that the application range is further widened.

Memory addresses in which frequencies are memorized are represented as M0, M1, M2,.....M9 and M0, M1,.....M9, MA, Mb in this order. Sign "-" above letter M stands for ten's digit.

Note

In locations MA and Mb, the exclusive tone frequency and shift frequency cannot be memorized. In them, the tone frequency and shift frequency identical to the VFO frequency are memorized.

Procedure

- 1 On the radio unit, press the V·M/ENT button, and "M" will light on the display section to indicate the memory frequency call mode. (Otherwise, on the remote control microphone, press the V·M button.)

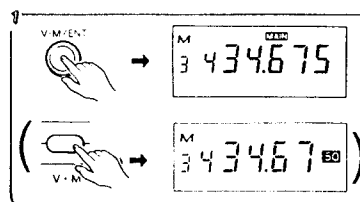

- 2 Call your desired frequency (memory address number) by main dial knob or the UP or DOWN button on the radio unit. (Otherwise, on the remote control microphone, press the "▼" or "▲" button.)

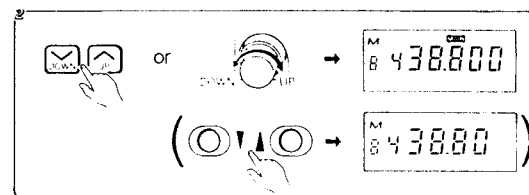

- 3 It is completed herewith. Press the PTT button on the remote control microphone to perform communications.
- 4 After the termination of communications, press the V·M/ENT button or CLR/STEP button on the radio unit to cancel the memory call mode, and the VFO mode will be engaged.

Note

- When the CLR/STEP button on the radio unit or the CLR D button on the remote control microphone is pressed, the memory call mode is canceled and the memory frequency display enters the VFO frequency display mode as it is.
- When the V·M/ENT button on the radio unit or the V·M button on the remote control microphone is pressed, the frequency display prior to memory call is restored.

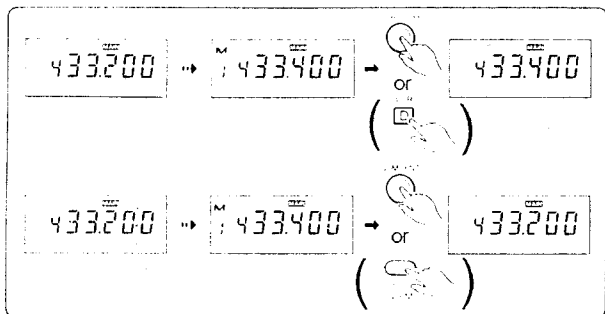

Procedure to memorize new frequency



Procedure

- 1 Display the frequency to be memorized on the display section.

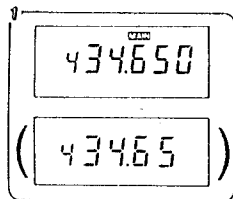

- 2 On the radio unit, press the V·M/ENT button. (Otherwise, on the remote control microphone, press the V·M button.)

Thus, the memory address number (M0) is displayed flickering on the display section. (This lights when that frequency is already memorized.) This is the memory frequency call mode.

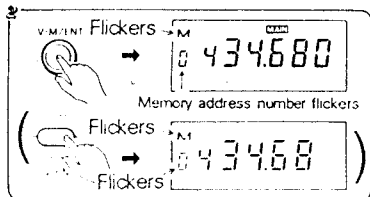

- 3 Set the memory address number by the main dial knob or the UP or DOWN button on the radio unit. (Otherwise, on the remote control microphone, press the "▼" or "▲" button.)

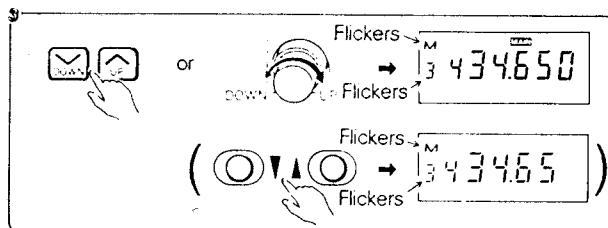

- 4 On the radio unit, press the FUNC button to engage the function mode. After that, press the V·M/ENT button.

(Otherwise, on the remote control microphone, press the ENT DIRECT* button.)

Thus, the frequency set mode will be engaged, in which inputtable digits are erased from the display.

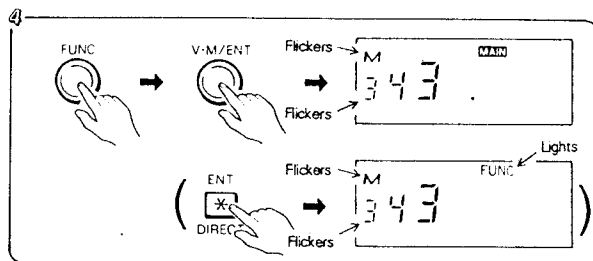

- 5 In the function mode, press the V·M/ENT button on the radio unit.

(Otherwise, on the remote control microphone, press the ENT DIRECT* button.)

Thus, the memory address number "M" and the frequency display will appear to indicate the completion of memory frequency writing.

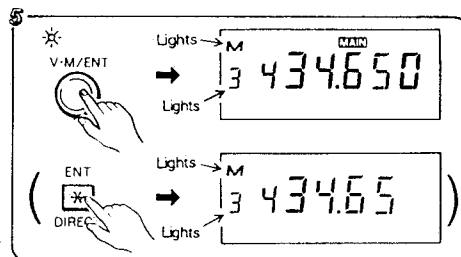

Advice

- In the memory call mode, when the memory address is not occupied, "M" flickers and the VFO frequency is displayed.

Method of altering a memory frequency written

Procedure

- 1 On the radio unit, press the V·M/ENT button.
(Otherwise, on the remote control microphone, press the V·M button.)

Thus, the memory address number "M" will light on the display section to indicate that the memory frequency call mode is engaged.

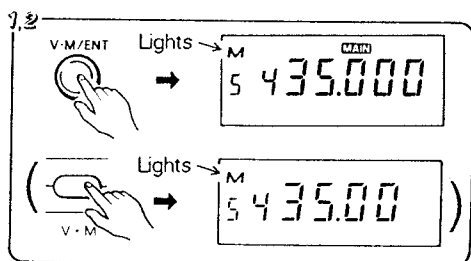

- 2 Set your desired frequency by the main dial knob or the UP or DOWN button on the radio unit.
(Otherwise, on the remote control microphone, press the "▼" or "▲" button.)

- 3 On the radio unit, press the FUNC button to engage the function mode, after which press the V·M/ENT button.

(Otherwise, on the remote control microphone, press the ENT DIRECT * button.)

Only the memory address number "M" on the display section will change from lighting to flickering, and the frequency direct input mode is engaged, in which state inputtable digits are erased from the display.

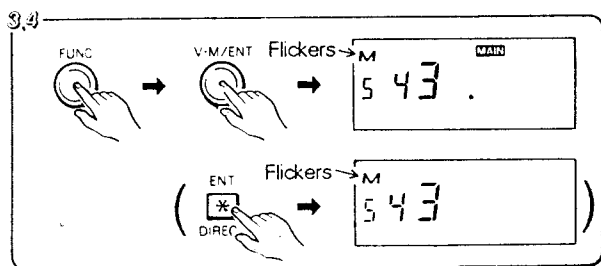

- 4 Set your desired frequency by the main dial knob or the UP or DOWN button on the radio unit.
(Otherwise, on the remote control microphone press numeral keys.)

For direct input from on the remote control microphone, writing is completed with input of the final digit.

In the direct input mode, when input is made from the main dial knob or the UP or DOWN button, the frequency value goes up or down from that prior to erasure.

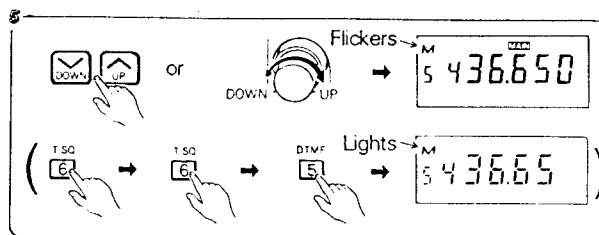

- 5 In the function mode, press the V·M/ENT button on the radio unit, and the memory address number "M" will light to indicate that writing is completed.

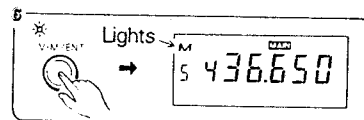

[Method of erasing a memory frequency written]

[Procedure]



- 1 Press the V·M/ENT button on the radio unit, and the memory frequency call mode will be engaged.

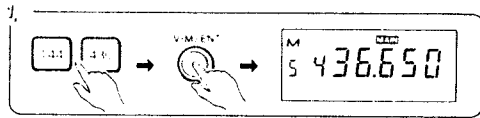

- 2 Call the memory address to be erased by the main dial or the UP or DOWN button on the radio unit.

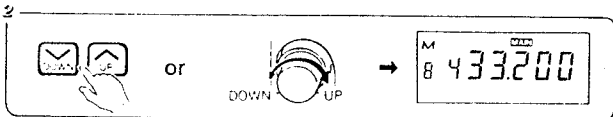

- 3 While pressing the 144 button or 430 button corresponding to the band to which the frequency of the memory address to be erased belongs, press the CLR/STEP button, and the memory frequency will be erased and "M" on the display



[Note]

The memory frequency cannot be erased from on the re-mote control microphone.

[Method of writing a function to memory a frequency]

The following functions can be written or canceled to or from the memory frequency.

- PRT mode ON/OFF, shift frequency, shift direction, tone frequency
- TSQ mode ON/OFF, tone frequency
- PG-C mode ON/OFF
- DTMF mode ON/OFF

To cancel each mode, reperform the method of writing.

[Note]

For use of T. SQL function or PG-C function, an optional CTN5600 or CTD5600 is necessary.

1) Method of writing repeater mode to a memory frequency

[Procedure]



- 1 On the radio unit, press the V·M/ENT button to call the memory frequency.
(Otherwise, on the remote control microphone, press the V·M button.)

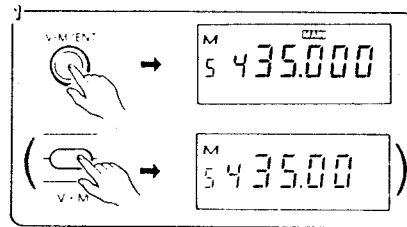

- 2 Press the RPT/SHIFT button on the radio unit to engage the repeater mode, and "T" and "-" will appear on the display section.
(Otherwise, on the remote control microphone, press the RPT 2 button.)

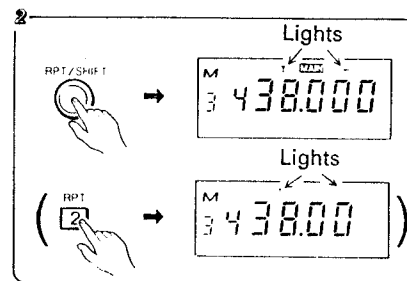

- 3 Press the FUNC button, after which press the V·M/ENT button twice. Therewith, writing will be completed.
(Otherwise, on the remote control microphone, press the ENT DIRECT* button.)

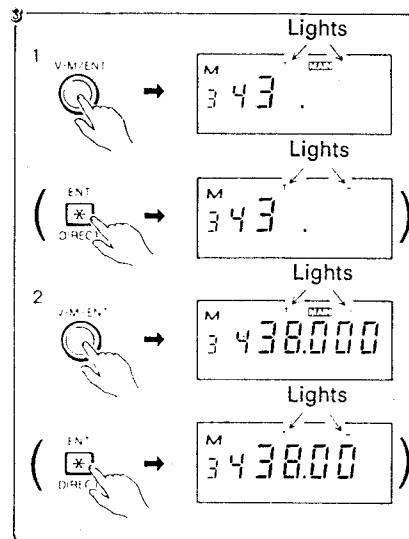

2) Method of writing tone squelch mode to a memory frequency

[Procedure]



- 1 On the radio unit, press the V·M/ENT button to call the memory frequency.
(Otherwise, on the remote control microphone, press the V·M button.)

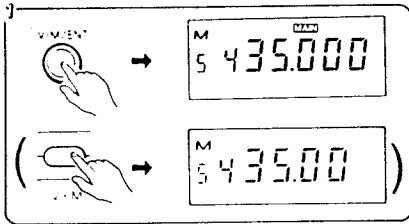

- 2 Press the T SQ/KL button on the radio unit to engage the tone squelch mode, and "T SQ" will be displayed on the display section.
(Otherwise, on the remote control microphone, press the T-SQ 6 button.)

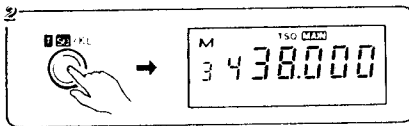

- 3 Press the FUNC button, after which press the V·M/ENT button twice. Therewith, writing will be completed.
(Otherwise, on the remote control microphone, press the ENT DIRECT* button.)

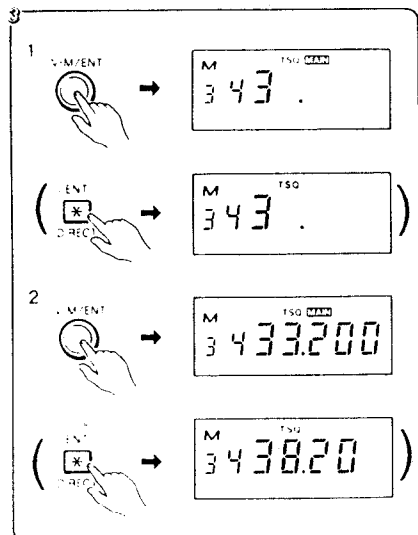

3) Method of writing paging mode to a memory frequency

[Procedure]



- 1 On the radio unit, press the V·M/ENT button to call the memory frequency.
(Otherwise, on the remote control microphone, press the V·M button.)

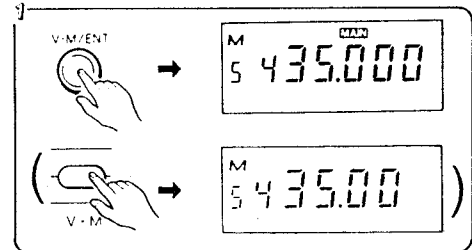

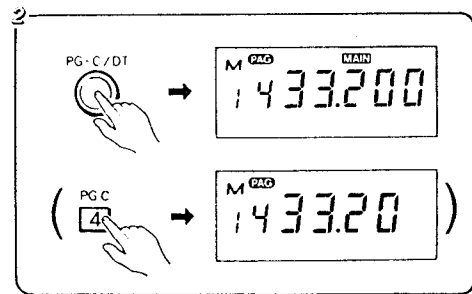

- 2 Press the PG-C/DT button on the radio unit to engage the paging mode, and "PAG" will be displayed on the display section.
(Otherwise, on the remote control microphone, press the PG-C 4 button.)

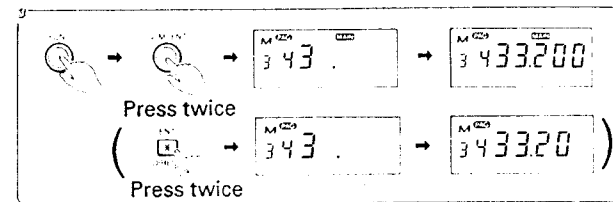

- 3 Press the FUNC button, after which press the V·M/ENT button twice. Therewith, writing will be completed.
(Otherwise, on the remote control microphone, press the ENT DIRECT* button.)



4) Method of writing DTMF mode to a memory frequency

[Procedure]  

- 1 On the radio unit, press the V·M/ENT button to call the memory frequency.
(Otherwise, on the remote control microphone, press the V·M button.)

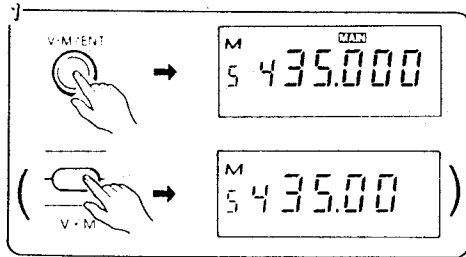

- 2 On the radio unit, press the FUNC button, after which press the PG·C/DT button, and "DT" will be displayed on the display section.
(Otherwise, on the remote control microphone, press the DTMF 5 button.)

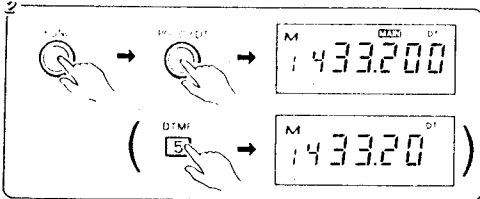

- 3 Press the FUNC button, after which press the V·M/ENT button twice. Therewith, writing will be completed.
(Otherwise, on the remote control microphone, press the ENT DIRECT* button.)

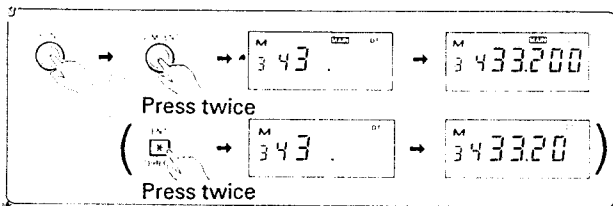

[Method of rewriting exclusive tone frequency for memory frequency]

[Procedure]  

- 1 On the radio unit, press the V·M/ENT button to call a memory frequency.
(Otherwise, on the remote control microphone, press the V·M button.)

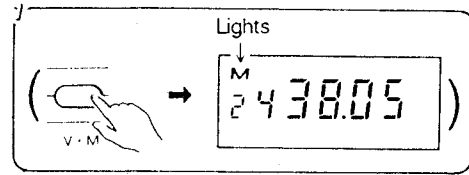

- 2 Press the T SQ/KL button on the radio unit continuously for more than about 0.5 second to call the exclusive tone frequency.
(Otherwise, on the remote control microphone, press the T-SQ 6 button.)

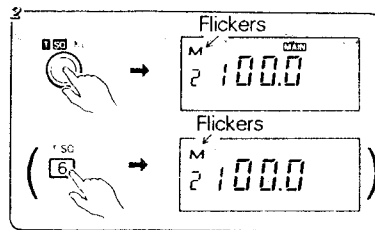

- 3 Set a new tone frequency by the main dial knob or the UP or DOWN button on the radio unit.
(Otherwise, on the remote control microphone, press the "▲" or "▼" button.)

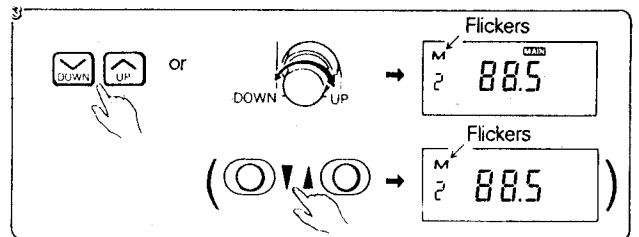

- 4 Press the T SQ/KL button or the CLR/STEP button to restore the previous memory frequency display.
(Otherwise, on the remote control microphone, press the T-SQ 6 button or the CLR D button.)

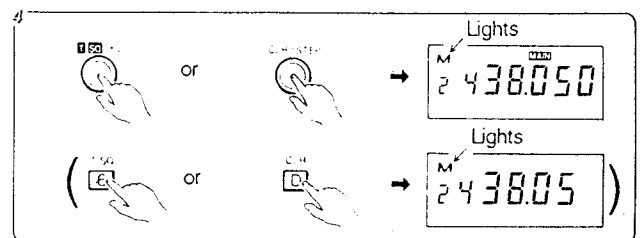

[Method of rewriting exclusive shift frequency for memory frequency]

[Procedure]

- 1 On the radio unit, press the V·M/ENT button to call a memory frequency.

(Otherwise, on the remote control microphone, press the V·M button.)

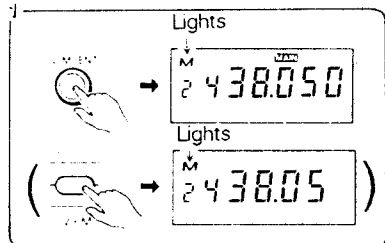

For direct input:

[Procedure]

- 1 On the remote control microphone, press the V·M button to call a memory frequency.

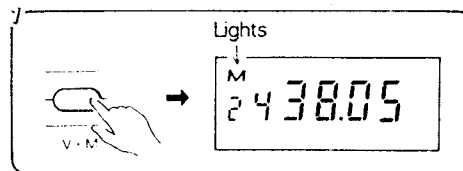

- 2 Press the SIFT # button continuously for more than about 0.5 second to call the exclusive shift frequency.

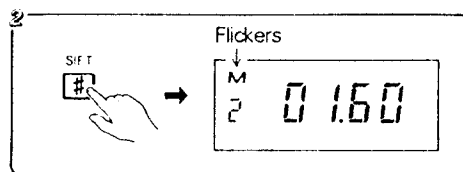

- 3 Press the ENT DIRECT * button, and inputtable digits will be erased from the display.

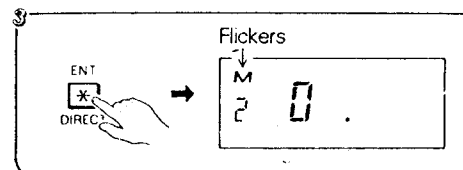

- 4 Enter your desired frequency by numeral buttons.

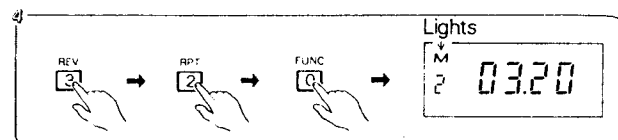

- 5 Press the RPT 2 button or CLR D button to restore the prior memory frequency display.

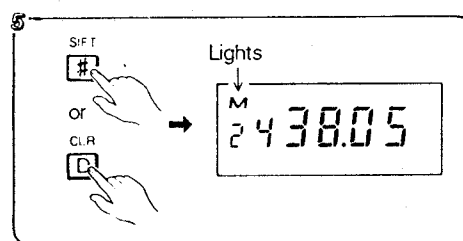

[Note]

As to the exclusive shift frequency, the displayed shift frequency is registered concurrently with the display change in the exclusive shift frequency call mode.

- 2 Press the FUNC button to engage the function mode, then press the RPT/SHIFT button continuously for more than about 0.5 second to call the exclusive shift frequency.

(Otherwise, on the remote control microphone, press the SIFT # button continuously for more than about 0.5 second.)

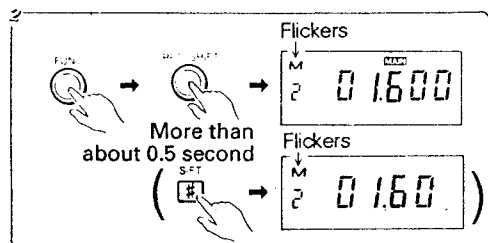

- 3 Set a new shift frequency by the main dial knob or the UP or DOWN button on the radio unit.

(Otherwise, on the remote control microphone, press the "▲" or "▼" button.)

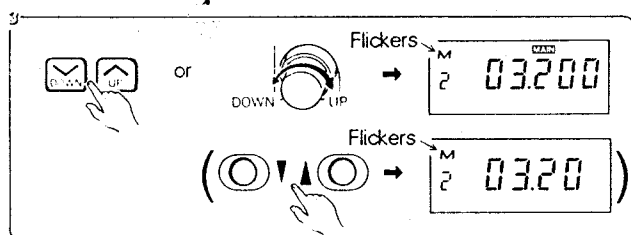

- 4 Press the FUNC button, then the RPT/SHIFT button or CLR/STEP button to restore the prior memory frequency display.

(Otherwise, on the remote control microphone, press the SIFT # button or CLR D button.)

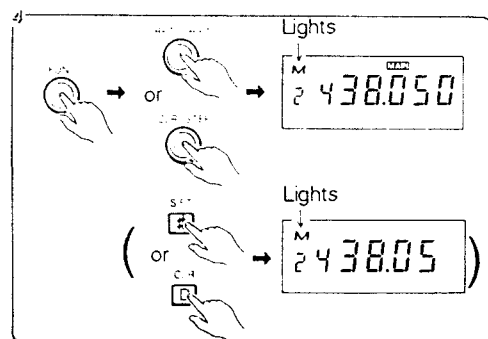

4. Tone squelch operation method

Connect an optional tone squelch unit CTN5600. Without the CTN5600 connected, the tone squelch mode is not available.

[Procedure]



- 1 Set the band on which tone squelch operation is performed.
- 2 On the radio unit, press the T SQ/KL button. (Otherwise, on the remote control microphone, press the T-SQ 6 button.) Thus, on the display section, "T" will be displayed to indicate that the tone encode mode is engaged. In this situation, transmission is made on the preset tone frequency (initial value: 88.5 Hz).

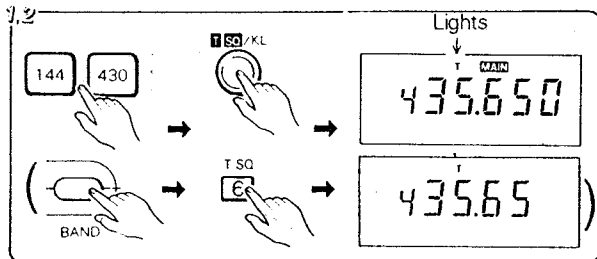

- 3 Press the T SQ/KL button on the radio unit once again. (Otherwise, on the remote control microphone, press the T-SQ 6 button.) On the display section, "TSQ" will be displayed to indicate that the tone squelch operation mode is engaged.

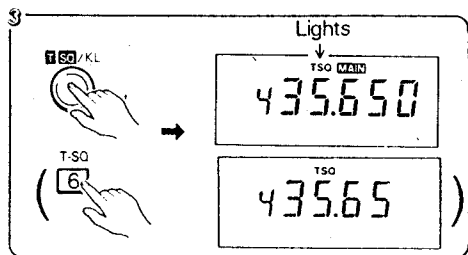

- 4 Press the PTT button on the remote control microphone to perform communications.

[Advices]

- In the tone squelch operation under this situation, the noise squelch also works. For this purpose, adjust the SQL knob to an appropriate position.
- Due to the operation of the T SQ/KL button, mode setting varies between normal, tone encode and tone squelch as shown below.

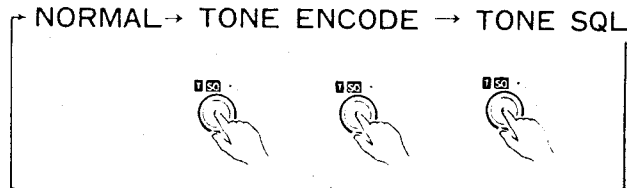

[Notes]

1. For tone squelch operation, without agreement in tone frequency with the opposite station, no reception sound is heard from speaker. Make an agreement in tone frequency between transmission and reception sides.
2. For tone squelch operation, preset the same tone frequency mutually.
3. After termination of tone squelch operation, cancel the tone squelch mode.
4. When the tone squelch mode is kept, it is impossible to monitor the contents of communication with another station operating on normal mode.

38 kinds of tone frequencies (Hz)

67.0	71.9	74.4	77.0	
79.7	82.5	85.4	88.5	Initial value
91.5	94.8	97.4	100.0	
103.5	107.2	110.9	114.8	
118.8	123.0	127.3	131.8	
136.5	141.3	146.2	151.4	
156.7	162.2	167.9	173.8	
179.9	186.2	192.8	203.5	
210.7	218.1	225.7	233.6	
241.8	250.3			

5. Paging function

Paging function and code squelch function

This function is very convenient in calling a specific individual station (which is named an individual call) or calling all members of a specific group simultaneously (which is named a group call).

[Notes]

1. For operation using the paging function and the code squelch function, an optional CTD5600 needs to be installed.
2. The operation should be performed in the state that squelch adjustment has been made (in which state the noise is not heard from the speaker.)
3. For paging operation or code squelch operation, preset the code mutually.
4. After termination of paging operation or code squelch operation, engage the normal operation mode.

When the paging operation or code squelch operation is kept, it is impossible to monitor the contents of communication with another station operating on normal mode.

1. Code setting

For operation using the paging function and the code squelch function, preset individual codes (3-digit) and their group code (3-digit) in memory.

Unless the individual codes and the group code are set, it is not feasible to correctly perform the paging operation or code squelch operation.

Code setting example:

	Individual codes	Group code
Station A	111	050
Station B	222	

[Advices]

- The individual and group codes each consist of 3 digits, which are three DTMF signals representing 0 to 9. Thus, a code is a triple DTMF signal.
- Due to the operation of the PG-C/DT button, mode setting varies between normal, paging and code squelch as shown below.

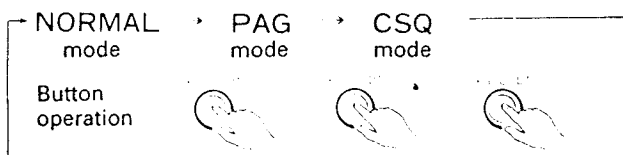

[Note]

The paging operation requires an agreement in advance of individual and group codes for communication.

[Own-station individual code setting method]

Set your own station individual code at M0.

[Procedure]



- 1 On the radio unit, press the PG-C/DT button for about 0.5 second. (Otherwise, on the remote control microphone, press the PG-C 4 button for about 0.5 second.) Thus, on the display section, the frequency display will disappear and instead "C-000" (initial value) be displayed, which is referred to as the code display status.
- 2 In this status, when the main dial knob or the UP or DOWN button is handled on the radio unit, a display of M0, 1, 2, and P is sequentially made on the display section, which are referred to as code address numbers. (Otherwise, on the remote control microphone, press the "▼" or "▲" button for this purpose.) Any code is factory set at "000".

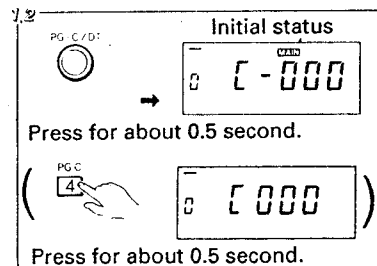

- 3 On the radio unit, press the FUNC button to engage the function mode. Thereupon, press the V·M/ENT button. (Otherwise, on the remote control microphone, press the ENT DIRECT * button.) Thus, the code rewriting mode will be engaged, which state the first digit of the code is only displayed.

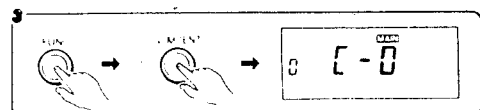

- 4 On the radio unit, handle the main dial knob or the UP or DOWN button to enter the first digit of the code. (Otherwise, on the remote control microphone, press the "▼" or "▲" button.)

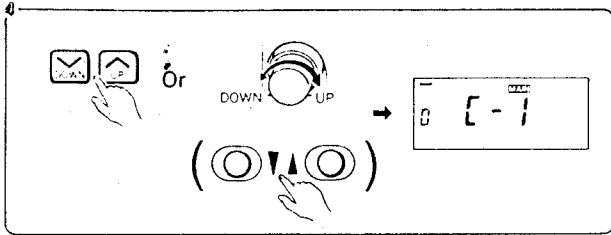

- 5 On the radio unit, in the function mode, press the V·M/ENT button. (Otherwise, on the remote control microphone, press the ENT DIRECT * button.)

Therewith, the first digit will be set. Next, the second digit be displayed.

At the same time that 3 digits are all set completely by performance of steps 3, 4 and 5, a long beep will be sounded. The code entry is completed herewith.

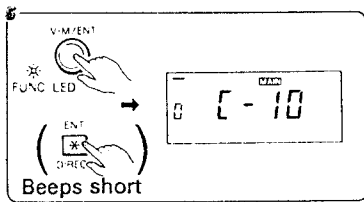

- 6 Press the CLR/STEP button on the radio unit to restore the prior frequency display. (Otherwise, on the remote control microphone, press the CLR D button or PTT button for this end.)

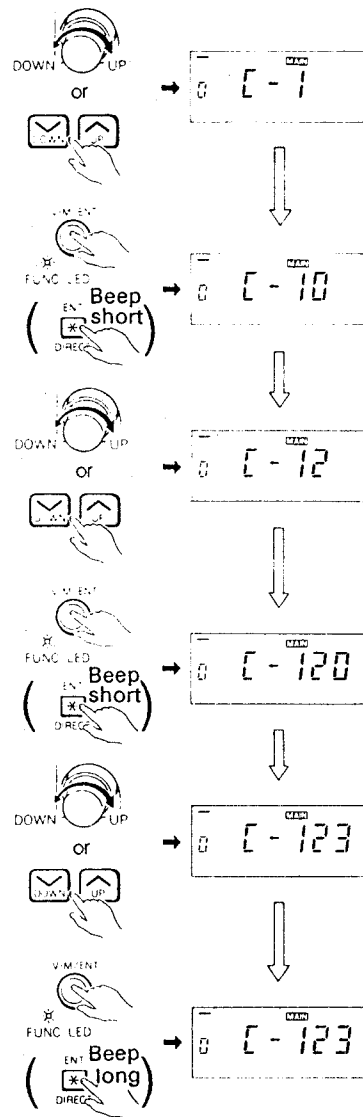

[Code direct input method]

[Procedure] 

- 1 In the code display status, press the ENT DIRECT * button on the remote control microphone. Thus, the code rewriting mode will be engaged, in which state the first digit of the code be only displayed.

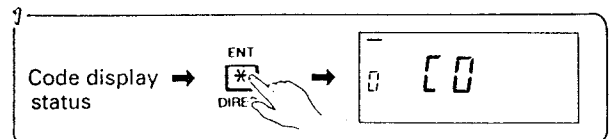

- 2 Enter the 3 digits of the code by numeral keys in order.

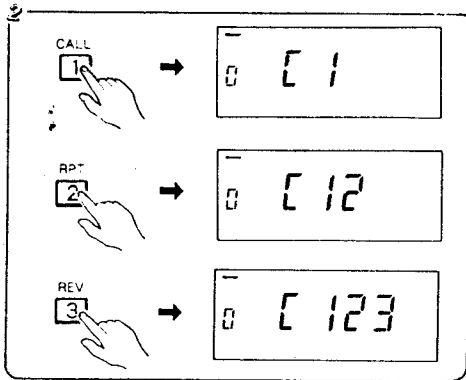

- 3 At the same time that the third digit is entered by a numeral key, a long beep is sounded. The code entry is completed herewith.

[Group code setting method]

Set your group code at code address number 1 or 2. The setting procedure is the same as for own-station individual code. Setting is feasible for UHF and VHF, separately (of the three codes including your own-station individual code.)

[Method of adding monitor function to group code]

With the monitor function added to the group code, when a PAG signal having an agreement in the group code to which the monitor function is added is received, the paging operation is performed.

[Procedure]

- 1 In the code display status, on the radio unit, press the PG-C/DT button, and the monitor function will be set and sign “-” appear above the display of the code address. (Otherwise, on the remote control microphone, press the PG-C 4 button.)

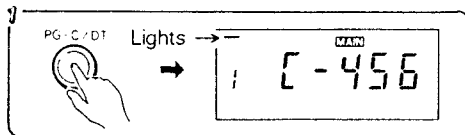

- 2 To cancel the monitor function, press the PG-C button on the radio unit once again, and the mon function will be canceled and sign “-” disapp from above the display of the code address. (Otherwise, on the remote control microphone, pr the PG-C 4 button.)

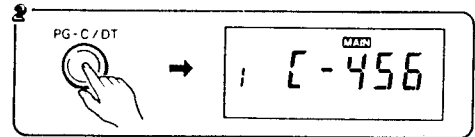

Memory address number	Application	Monitor function	Rewriting
0	Own-station code (automatically transmitted in PAG operation)	All-time monitor	Feasible
1	Group code	Setting or canceling the monitor function is feasible.	Feasible
2			
P	Individual code for opposite station	Unusable	Unfeasible

2. Paging operation method

[When calling a specific station]

1. Transmission side

Determine the operating frequencies with the opposite station beforehand.

[Procedure]



- 1 Set your own-station individual code at code address number 0. (E.g. 111)
- 2 On the radio unit, press the PG-C/DT button continuously for more than about 0.5 second to call code address number 2. Then, set the opposite station individual code by numeral keys. (E.g. 222). (Otherwise, on the remote control microphone, press the PG-C 4 button.)

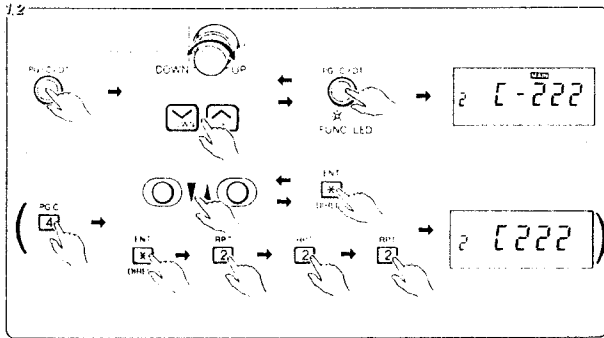

- 3 On the radio unit, press the CLR/STEP button to provide the frequency display. (Otherwise, on the remote control microphone, press the CLR D button.)

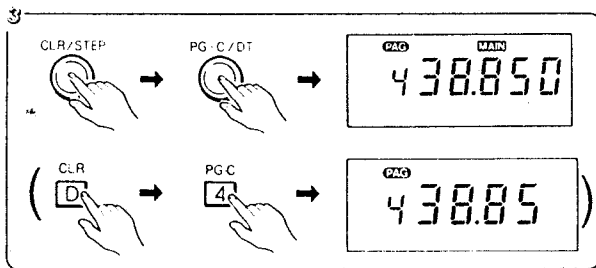

- 4 On the radio unit, press the PG-C/DT button to engage the paging mode. (Otherwise, on the remote control microphone, press the PG-C 4 button.) Thus, "PAG" will be displayed on the display section.

- 5 Press the PTT button on the remote control microphone to perform communications. Thus, a paging signal will be sent out. After the termination of this sending out, perform communications.

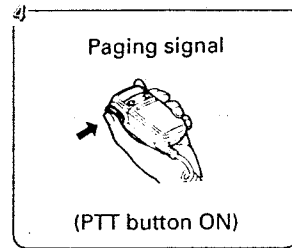

[Advices]

- After contacting with the opposite station, cancel the paging mode for communications. If the paging mode is held, each time the PTT button is pressed, a paging signal is sent out.
- The paging signal sent out has the opposite station set code and your own station code transmitted in succession.
- While the paging signal is sent out, the voice from the microphone is not subject to modulation. When the paging signal is sent out, they are transmitted automatically.

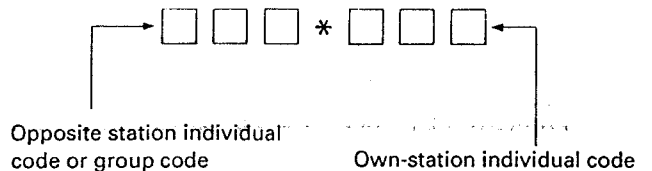

- As to the timing to send out, in the simplex mode, the paging signal is sent out about 250 msec after pressing the PTT button, while in the repeater mode, it is about 450 msec after that.

2. Reception side

Determine the operating frequencies with the opposite station beforehand. Complete the squelch adjustment correctly (by which the noise is not heard from the speaker).

[Procedure]



- 1 On the radio unit, press the PG-C/DT button to engage the paging mode. Thereupon, enter the standby mode.

(Otherwise, on the remote control microphone, press the PG-C 4 button.)

Thus, "PAG" will be displayed on the display section.

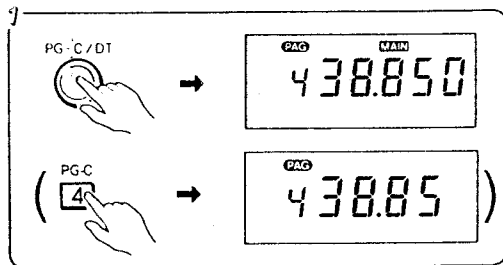

- 2 When your own-station individual code is received, a beep sound, prr, is emitted 7 times, and "PAG" starts flickering at the right upper side of the display. Further, the frequency display disappears and instead the opposite station individual code is displayed.

Example: When the opposite station is called by its individual code, "PAG PC-111" is displayed.

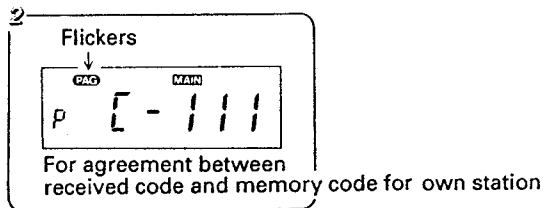

- 3 For communications, on the radio unit, press the PG-C/DT button twice to cancel the paging mode, thereafter perform communications.

(Otherwise, on the remote control microphone, press the PG-C 4 button twice.)

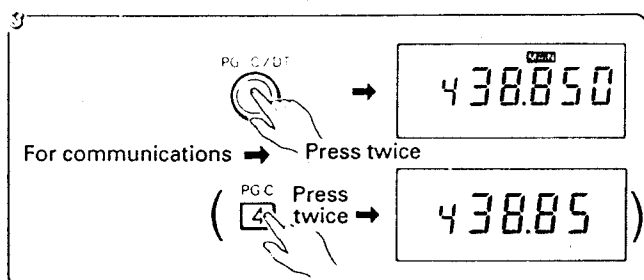

[Advices]

- The beep sound emitted with an agreement in individual code or group code can be eliminated partway. For this elimination, on the remote control, while pressing the FUNC button, press the PG-C/DT button or the CLR/STEP button. (Otherwise, on the remote control microphone, press the PG-C 4 button or the CLR D button.)
- With your own-station individual code set at code address number 1 or 2 (at which the opposite station individual code is to set), when the transmission mode is engaged, the group code is sent out. (This operation is not proper.)
- Due to interference, etc., when the opposite station individual code is not completely received, "E" appears on the display section, and the code displayed prior to reception is redisplayed. In this case, the opposite station individual code is not received.
- With an optional DTMF unit connected to our radio unit not provided with the paging function, it is possible to gain access to the C5608D. For this, perform the following procedure:

Example where access is gained to C5608D from C5200ED:

(Use an optional microphone CMP830D. However, the C5200ED, not provided with the paging function, does not permit the paging operation.)

- 1 Set the C5608D to the paging mode.
- 2 Designate the opposite station individual code and your own-station individual code by numeral keys or an optional microphone CMP830D for C5200ED. (Press them while pressing the PTT button.)

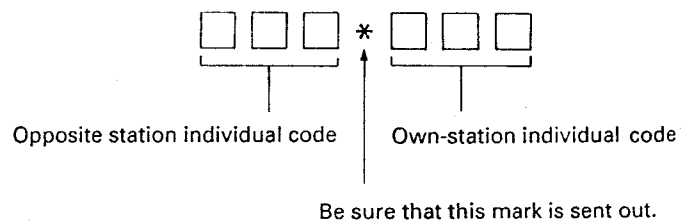

[Note]

Each interval in pressure between numeral key should be within 1.5 sec.

- 3 In the C5608D side, when the paging code is received, "PAG" starts flickering. Accordingly, cancel the paging mode to perform communications.

[Operation example]

Set codes at code addresses.

[Advice]

- In the paging operation, the code displayed on the display section is sent out.

Station A: Example of code address contents
 0: 111... own-station individual code
 1: 222... station B individual code
 2: 050... group code
 (Add the monitor function.)

Station B: Example of code address contents
 0: 222... own-station individual code
 1: 111... station A individual code
 2: 050... group code
 (Add the monitor function.)

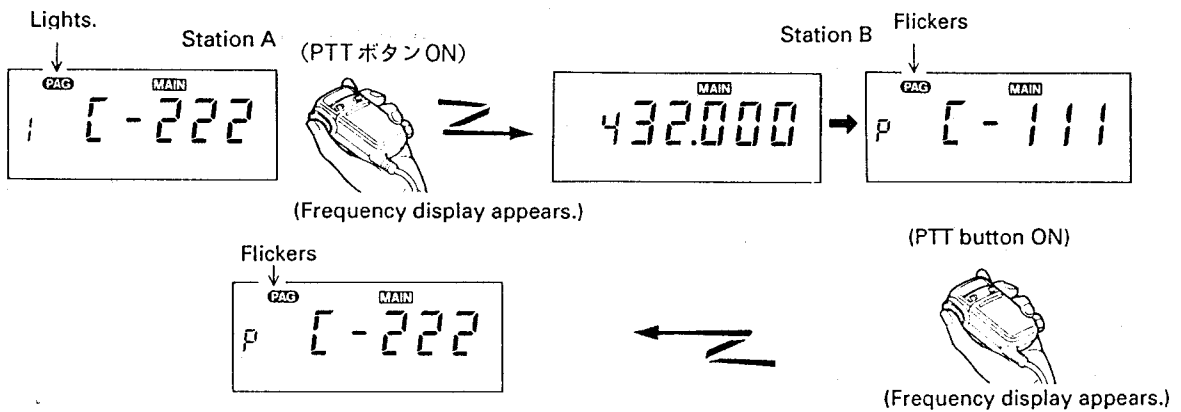
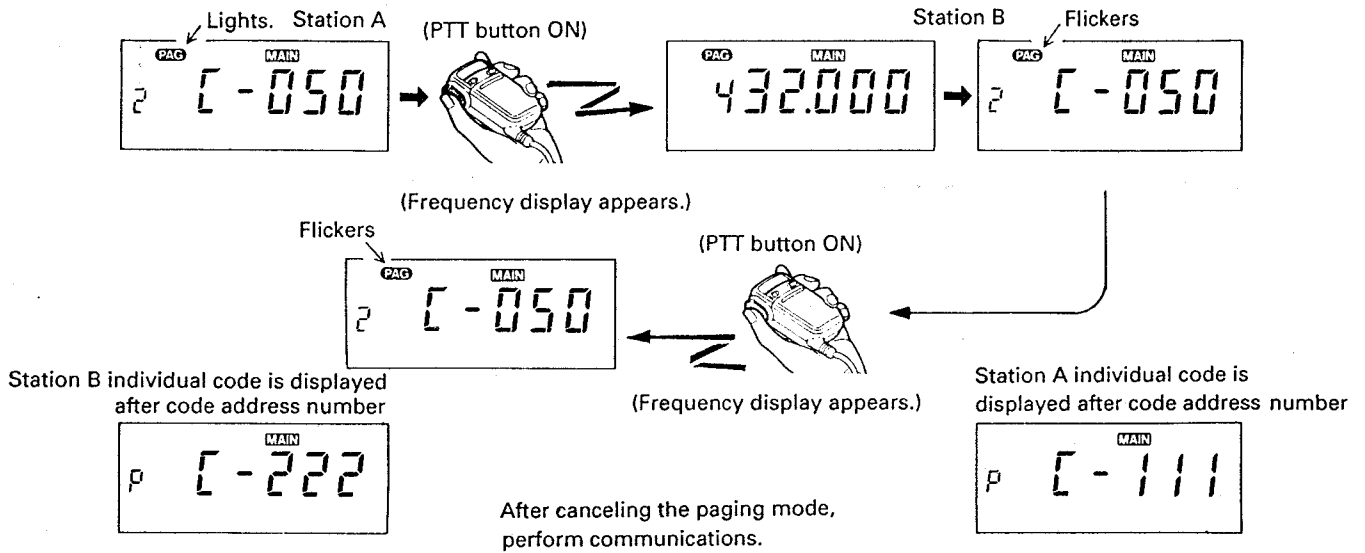

Signal incoming error

Due to interference, etc., when the opposite station individual code is not completely received, the signal incoming error display appear. The lastly received code is displayed.

After canceling the paging mode, perform communications.

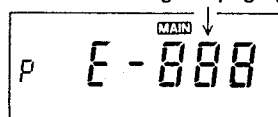

[Selection of beep sound for signal incoming in paging mode]

Normally, at the time of signal incoming in paging mode, a prr beep sound is emitted 7 times. This number of emissions can be made one. Refer to "6. Set mode" on page 55.

[Note]

Upon signal incoming in the paging mode, even when the PTT button is pressed while the said beep sound is emitted, this sound does not disappear.

3. Code squelch operation method

The code squelch operation is feasible with a code set at code address numbers 0 to 2.

[Procedure]

- 1 Set the band on which the code squelch operation performed.
- 2 Display the code to which the code squelch operation is applied.
At this time, add the monitor function.
- 3 On the radio unit, press the PG-C/DT button twice to engage the code squelch mode.
(Otherwise, on the remote control microphone, press the PG-C 4 button twice.)

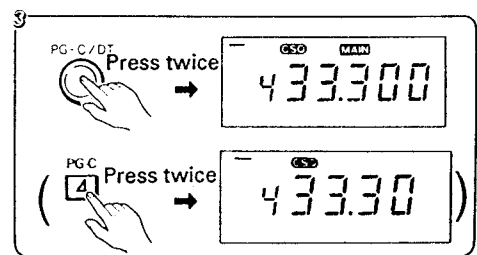

- 4 Restore the frequency display, then press the PTT button on the remote control microphone to perform communications.
Each time the PTT button is pressed, a DTMF signal is sent out.

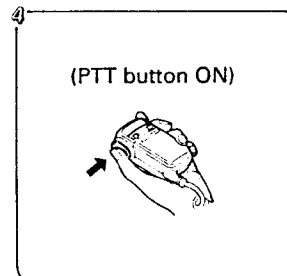

Other Functions

1. Scan function

Two scans are available, pause scan and busy scan. Selection between these two is performed in set mode No. 1, for which refer to page 55. When performing scan, adjust the squelch knob on the radio unit so that noise is not heard.

During scan, when transmission is made by pressing the PTT button, scan is stopped.

[1 MHz width scan]

[Procedure] 

- 1 Set as the main band the band to which scan is to be made.
- 2 On the radio unit, press the FUNC button to engage the function mode, and then press the MS/SCAN button. (Otherwise, on the remote control microphone, press the SCAN 8 button.)

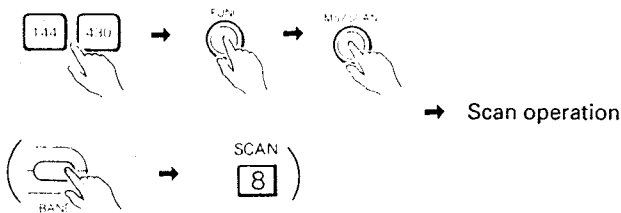

Thus, scan will be performed to the 1 MHz width of band displayed.

- 3 When canceling scan, press the MS/SCAN or CLR/STEP button on the radio unit. (Otherwise, on the remote control microphone, press the SCAN 8, MS 7, PS 9 or CLR D button.)

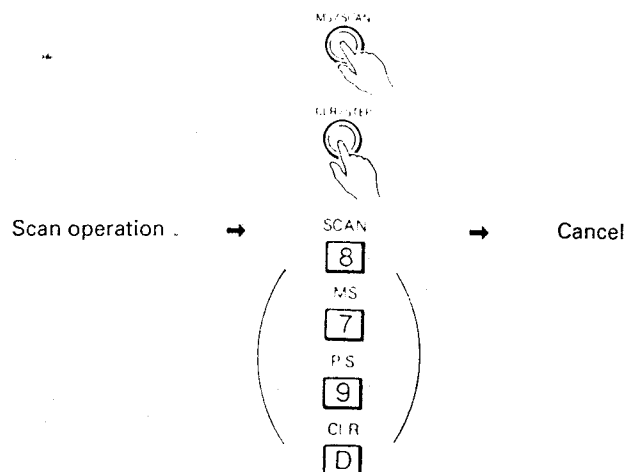

[Memory frequency scan]

[Procedure] 

- 1 Set as the main band the band to which scan is to be made.
- 2 On the radio unit, press the MS/SCAN button. (Otherwise, on the remote control microphone, press the MS 7 button.) Thus, scan will be made to the memory frequencies in order.
- 3 When canceling scan, press the MS/SCAN or CLR/STEP button on the radio unit. (Otherwise, on the remote control microphone, press the SCAN 8, MS 7, PS 9 or CLR D button.)

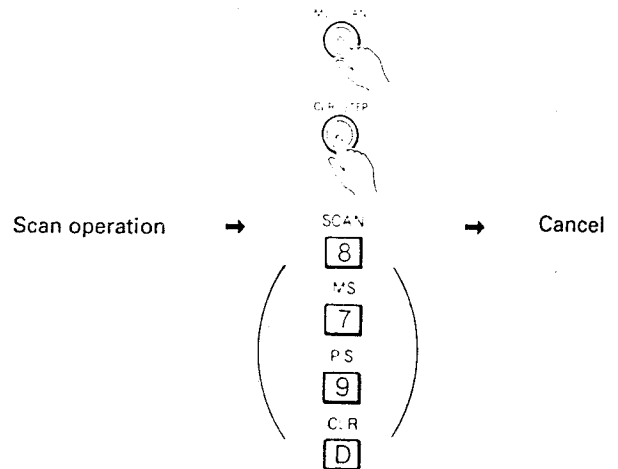

[Advices]

- During the memory scan operation, when the MS/SCAN button on the radio unit or the MS 7 button on the remote control microphone is pressed, this memory scan operation stops in the memory call mode. When repressed, the memories
- When the memory scan operation is performed from the memory call mode, scan is started from the memory address displayed.
- Any no-memory address is skipped over.
- Memory addresses A and b, used for the start and end frequencies for the program scan, are skipped over in memory scan operation.

[All scan operation (all band scan)]

- During the 1 MHz width scan, on radio unit, press the FUNC button to engage the function mode, and then press the CLR/STEP button, and scan will be performed to all the band.
- Once again, press the FUNC button to engage the function mode, and then press the CLR/STEP button, and the 1 MHz width scan will be restored.
(Otherwise, on the remote control microphone, press the STEP C button.)

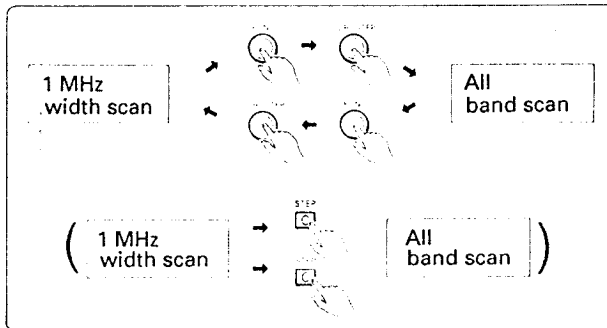

[Scan between arbitrary frequencies]

(PS: Program scan)

Making use of memory frequencies, scan can be made between arbitrary frequencies.

[Procedure]

Concretely, here is performed a program scan that the address numbers of the start and end frequencies are designated to scan between these arbitrary frequencies.

[Procedure]

- Preset the start and end frequencies at memory address numbers A and b.
- Press the PS 9 button on the remote control microphone.
Thus, on the display section, "P" will light and the program scan operation is feasible from the start frequency.

* When the program scan operation is performed with memory address number A displayed, scan is made within the frequency range from A to b.

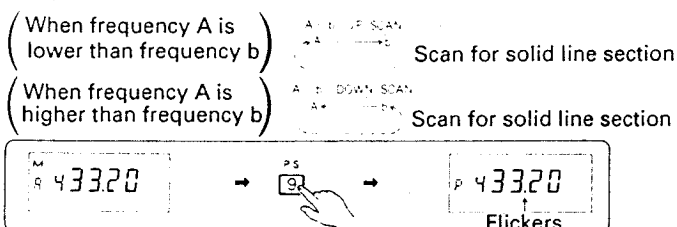

* when the program scan operation is performed with memory address number b displayed, scan is made without the frequency range from b to

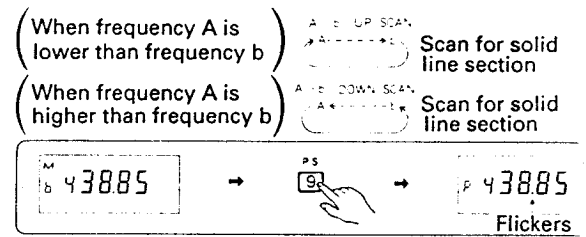

- When canceling scan, press the MS/SCAN or CLR/STEP button on the radio unit.
(Otherwise, on the remote control microphone, press the SCAN 8, MS 7, PS 9 or CLR D button.)

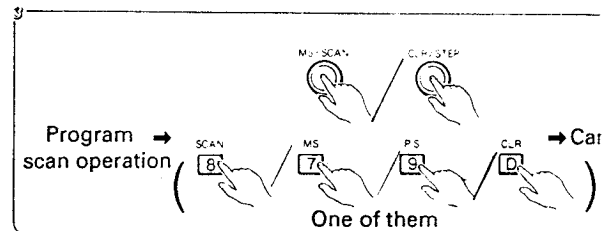

[Advice]

- Unless those frequencies are memorized, program scan is unfeasible.

[Scan direction change]

During scan, the scan direction can be changed by the main dial knob on the radio unit or by the "▼" or "▲" button on the remote control microphone.

When the "▼" or "▲" button is pressed, scan is performed in the direction corresponding to the button pressed.

Otherwise, when the main dial knob on the radio unit is rotated, the scan direction changes corresponding to the direction of rotation.

[Tone squelch scan operation]

Only with an agreement in tone frequency, the squelch is opened.

Unless tone squelch unit CTN5600 is connected, the tone squelch scan is impossible.

[Procedure] 

- 1 Set as the main band the band to which scan is to be made.
- 2 On the radio unit, press the T SQ/KL button to engage the tone squelch operation mode. (Also possible during scan)
(Otherwise, on the remote control microphone, press the T-SQ 6 button.)

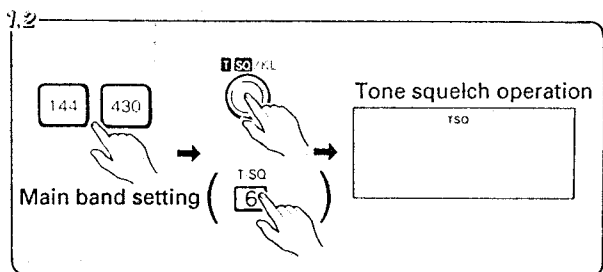

- 3 On the radio unit, press the FUNC button to engage the function mode, and then press the MS/SCAN button.

(Otherwise, on the remote control microphone, press the SCAN 8 button.)

Without agreement in the set tone frequency, the squelch does not open. In addition, because of the relationship with the tone squelch open time, the scan time is set to longer than normal.

- 4 When canceling scan, press the MS/SCAN or CLR/STEP button on the radio unit.

(Otherwise, on the remote control microphone, press the SCAN 8, MS 7, PS 9 or CLR D button.)

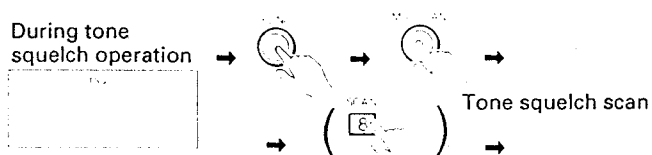

[Note]

The 1 MHz scan and all band scan, and the up scan and down scan can be set independently to each of 144 MHz and 430 MHz bands, and their setting undergoes backup.

The pause scan and busy scan operation is common to 144 MHz and 430 MHz bands, the selection between these two being made by the operation of set mode No. 1.

2. Auto mute operation to lower volume of reception sound

This function reduces the volume of unfavorable sound of another band by a predetermined amount, which is about 12 dB.

[Procedure] 

- 1 Set the band to which mute is to be applied.
- 2 On the radio unit, press the FUNC button to engage the function mode, then press the CALL/MUTE button.

Thus, on the display section, "MUTE" will be displayed and the auto mute operation is set.

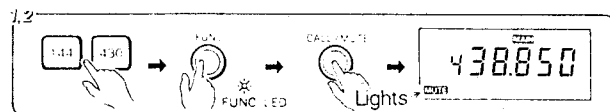

- 3 Once again, during the function mode, press the CALL/MUTE button to cancel the auto mute operation.

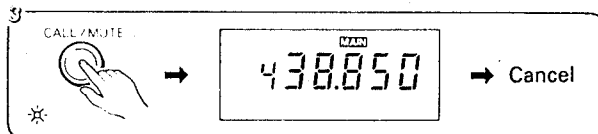

3. Illumination change of display section

This product is provided with a dimmer function to vary the illumination level of the LCD background in two steps. For use in a dark room, etc., the dimmer function is operated for easier view of the display section.

[Procedure] 

On the radio unit, while pressing the FUNC button, press the /PUSH DIMM button, and the illumination will lower.

To restore the illumination, press it once again.

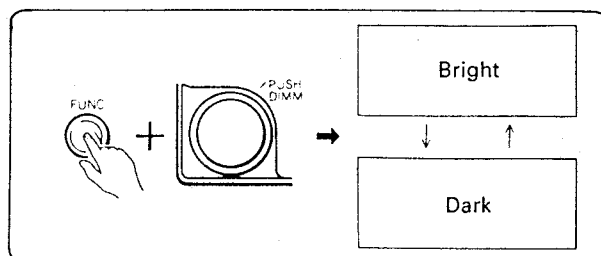

4. Key lock function to disable button operation

A key lock function, which can be set for each individual band, is operated to prevent faulty operation. The key lock function can be set in the remote control microphone and the radio unit itself, separately.

[Procedure]



- 1 Set as the main or sub band the band to which key lock is to be applied.
- 2 On the radio unit, press the FUNC button to engage the function mode, after which press the T SQ/KL button, and "KL" will be displayed on the display section to indicate that keys are locked for that band.

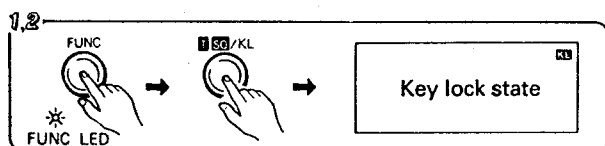

- 3 When unlocking, press the T SQ/KL button once again during the function mode.

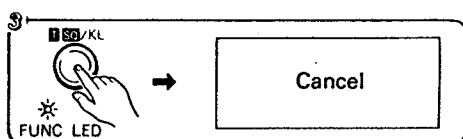

5. Key lock feature of remote control microphone

Set to ON the KL switch on the remote control microphone, and "KL" will be displayed on its display section to indicate that its keys are locked.

6. Set mode

This mode serves each function as shown on the table below. For this function, on the radio unit, when number 0 to 7 is set by the main dial knob after pressing the M ENT button while pressing the FUNC button (the set number display lights), its corresponding function is performed as shown on the table below.

Otherwise, on the remote control microphone, after pressing the ENT DIRECT * button while pressing the FUNC button, press the "▼" or "▲" button for this.

Numeral key	Function
0:	Beep OFF (except for PAG incoming alarm and DTMF monitor sound VOL. beep)
1:	Busy scan (normally, pause scan)
2:	When PG-C or DTMF code is sent out, the delay time is prolonged. 450 msec 750 msec for shift operation or repeater operation
3:	PTT lock
4:	PAG incoming alarm one time (normally, 7 times)
5:	Entry of all digits
6:	Main dial enabled independent of KL
7:	1 MHz up/down when the UP/DOWN button is handled while handling the main dial

[Each function setting of set mode]

[Procedure]

- 1 In the VFO frequency display status, on the radio unit, while pressing the FUNC button, press the V·M/ENT button.

(Otherwise, on the remote control microphone, while pressing the FUNC 0 button, press the ENT DIRECT * button.)

Thus, the set display mode will be entered.

The number display of any address at which no function is set flickers.

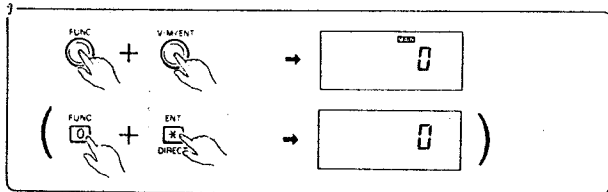

- 2 Select your desired address number by the main dial knob on the radio unit.

(Otherwise, on the remote control microphone, press the "▼" or "▲" button.)

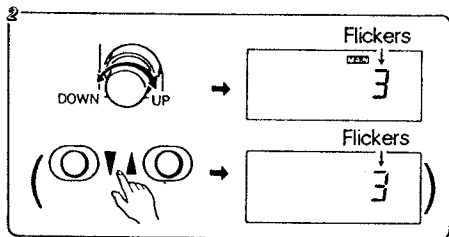

- 3 Engage the function mode, thereupon press the V·M/ENT button.

(Otherwise, on the remote control microphone, press the ENT DIRECT * button.)

The number display of the selected address will light to indicate the a function is set.

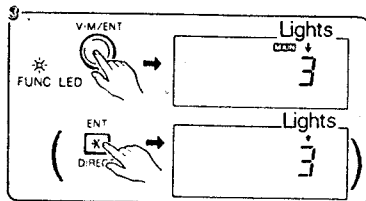

- 4 On the radio unit, while pressing the FUNC button, press the V·M/ENT button.

(Otherwise, on the remote control microphone, while pressing the FUNC 0 button, press the ENT DIRECT * button.)

The VFO frequency display status will be resumed.

[Each function canceling of set mode]

[Procedure]

- 1 Engage the set mode display status, select an address from which the function is to be canceled by the main dial knob.

(Otherwise, on the remote control microphone, press the "▼" or "▲" button.)

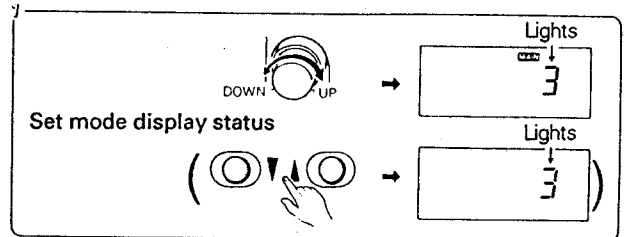

- 2 On the radio unit, press the CLR/STEP button.

(Otherwise, on the remote control microphone, press the CLR D button.)

The number display of the selected address flickers to indicate that the function is canceled.

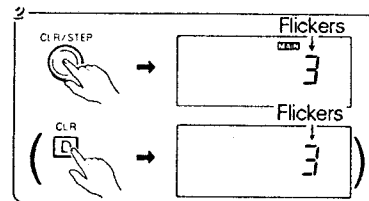

- 3 On the radio unit, while pressing the FUNC button, press the V·M/ENT button.

(Otherwise, on the remote control microphone, while pressing the FUNC 0 button, press the ENT DIRECT * button.)

Thereby, the VFO frequency display status will be restored.

[Notes]

1. The set mode is common to the both bands. If setting or canceling is made for one band, then the same setting or canceling is concurrently made for the other band, too.
2. Only from the VFO frequency display status, the set mode is engaged.

7. Function to let the frequency display disappear

The unnecessary band display can be cleared off.

[Procedure] 

- 1 Set as the main band the band of which the display is to be cleared off.
- 2 On the radio unit, while pressing the FUNC button, press the main band selection button for that band. When the display disappears, another band is automatically set as the main band instead.
- 3 To restore, press the main band selection button for the band of which the frequency display is off, and the frequency display will reappear with a short beep sound.

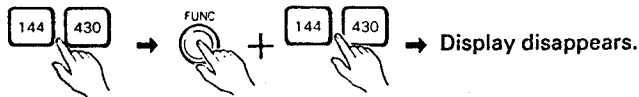

8. Transmission output selection

* Selection is possible between three steps for transmission output.

[Procedure]  

- 1 In the function mode of the radio unit, press the RE PO button.
(Otherwise, on the remote control microphone, press the PO B button.)
- 2 Each time the button is pressed, "M" or "L" appears on the display section, in which state the transmission output level is varied in three steps.

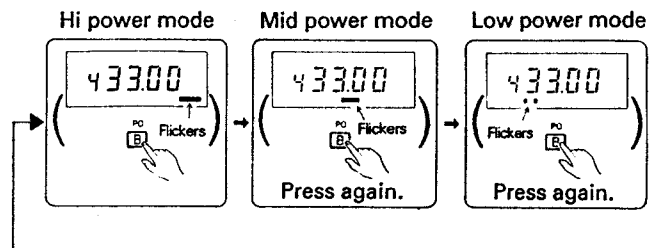

– Perform the same manner for 144 MHz band as well. –

Display on display section	Band	Transmission output
None	144 MHz band, 450 MHz band	50 W 40 W
M	144 MHz/450 MHz band	10 W
L	144 MHz/450 MHz band	3 W

9. DTMF function

Of this product, transmission is feasible in two ways: an ordinary way of DTMF signal and the other way of DTMF code.

For use of DTMF, connect an optional DTMF unit CTD5600.

[Procedure on remote control microphone]

1. Ordinary DTMF signal sending

- With the CTD5600 connected, while pressing the PTT button, when a numeral key, an alphabetical key, A to D or a sign key # or * is pressed, a DTMF signal is sent out only during the button pressure.

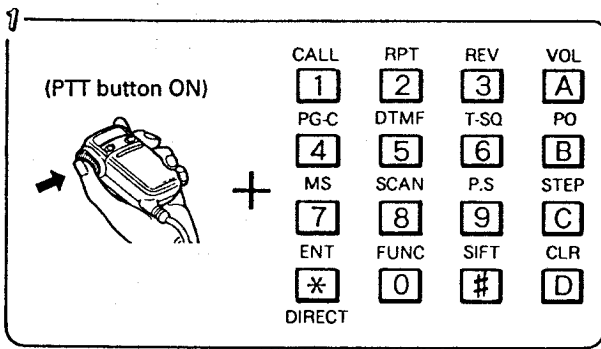

(This description is not concerned to the DTMF code memory sending.)

2. DTMF code sending

[DTMF code memory]

Two DTMF signals, either consisting of max. 15 digits, can be stored in a DTMF exclusive memory. Make use of this advantage in remote control operations, etc. using DTMF signals.

Codes memorizable are 0 to 9, A, B, C, D, * and #. The correspondence between input codes and their accompanying displays is as follows:

0, 1, 2, 3, 4, 5, 6, 7, 8, 9, A, B, C, D, *, #	← Input button
0 1 2 3 4 5 6 7 8 9 A b c d E F	← Display

[DTMF code memorizing method]

[Procedure on remote control microphone]

Input example:

- On the remote control microphone, press the DTMF 5 button continuously for more than about 0.5 second, and the DTMF code display mode will be engaged, at which time sign "M" and a code address number flicker.

When something is already memorized in this code address, its number lights.

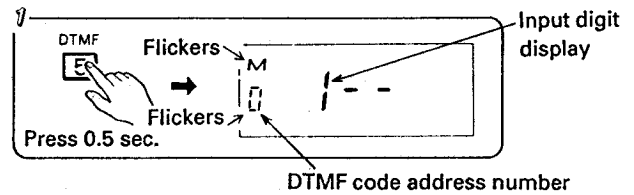

- Set a code address number by the "▼" or "▲" button.

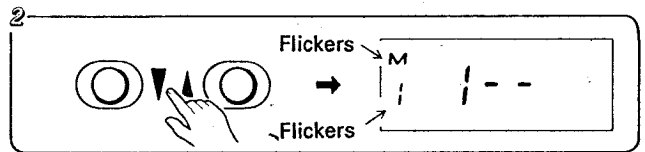

- Press the ENT DIRECT* button to engage the direct input mode.

Next, enter the code to be memorized. When the first digit is input, the code address number lights. At each digit input for the DTMF code, the digit number increases by one.

When input is performed up to the 15th digit, a long beep sound is heard, informing that registration is made.

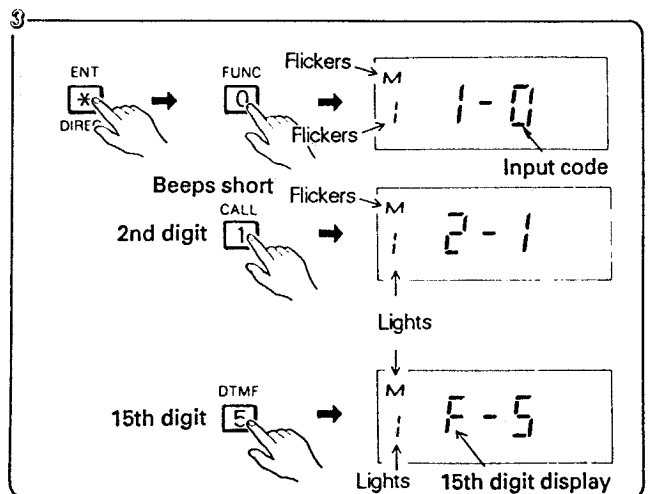

[Advice]

The DTMF code, when consisting of less than 15 digits, is registered by pressing the PTT button on the remote control microphone.

[Note] ;

Digit numbers are arranged in the order of 1, 2, 3, 4, 5, 6, 7, 8, 9, A, b, C, d, E, F.

[DTMF code check method]

[Procedure on remote control microphone]

1 Provide the code address display.

Call your desired code address number using the "▼" or "▲" button.

Then, press the ENT DIRECT* button to engage the direct input mode, and "M" will flicker on the display section.

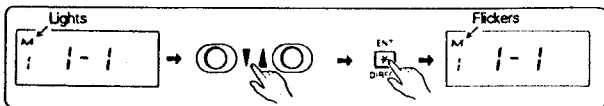

2 Press the "▼" or "▲" button, and you will check the DTMF code corresponding to the digit number.

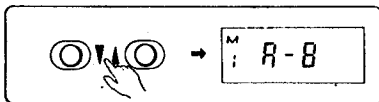

[Note]

In this step, a key input of another DTMF code results in change in memorized code.

3 After check, press the PTT button to cancel.

[DTMF code rewriting method]

[Procedure on remote control microphone]

1 Call the code address number to be subject to DTMF code rewriting.

Press the ENT DIRECT* button to engage the direct input mode.

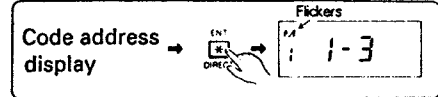

2 Enter the code to be memorized. (Write it over the previous code.)

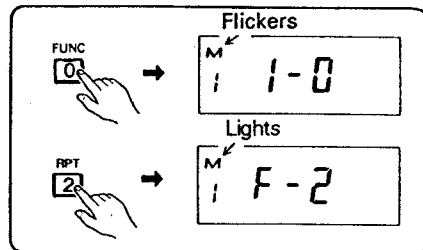

3 When input is performed up to the 15th digit, a long beep sound is heard, informing that registration is made. Then, sign "M" lights.

[Advice]

The DTMF code, when consisting of less than 15 digits is registered by pressing the PTT button on the remote control microphone, at which time the previous code at the 15th digit is cleared. Then, sign "M" lights.

[Halfway DTMF code altering method]

[Procedure on remote control microphone] 

Example:

Code address: 0 → 0
 DTMF code: 01234556 → 0123456

- 1 Call the code address number to be subject to altering.
- 2 Press the ENT DIRECT* button to engage the direct input mode.

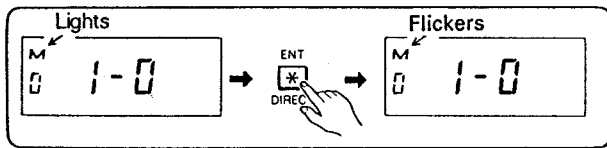

- 3 Display the digit preceding by one the altering digit using the "▲" or "▼" button.

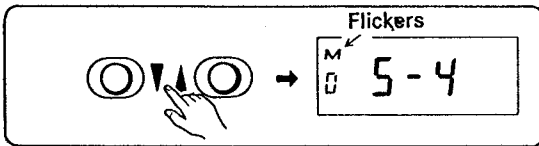

- 4 Start the DTMF code entry from the digit preceding by one the altering digit.

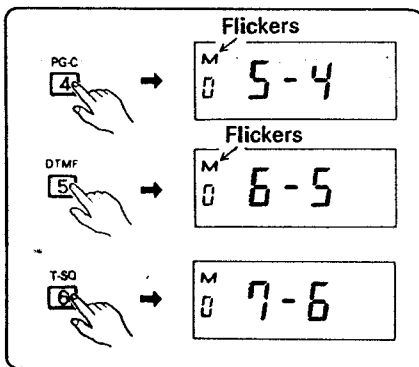

- 5 Press the PTT button to register.

[Note]

For DTMF code erasure, it is needed to perform software resetting. At this time, all memory will be erased at the same time.

[DTMF code sending method]

[Procedure on remote control microphone] 

- 1 Press the DTMF 5 button continuously for more than about 0.5 second to provide the DTMF code display.
- 2 Select your desired code address using the "▼" or "▲" button.



- 3 Press the DTMF 5 button to resume the previous frequency display mode, then press the same DTMF 5 button once again, and the DTMF mode will be set.

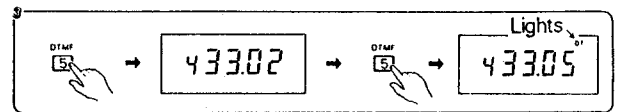

- 4 While pressing the PTT button, when the SQL OFF button is pressed, a DTMF code is automatically sent out.

During this time, the code address number flickers corresponding to the DTMF code being sent.

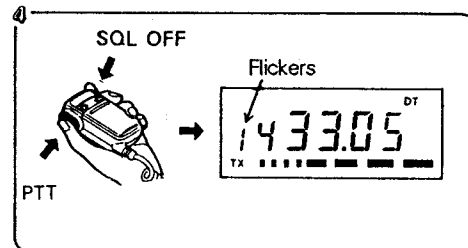

[Advice]

For one-hand operation for DTMF code sending, press the SQL OFF button by a forefinger while pressing the PTT button by a thumb.

Specifications

Any specification item are common to C5600 and C5600D, and 144 MHz and 430 MHz bands, unless otherwise specified.

1. General specifications

Transmission frequency: VHF 144.00 to 145.995 MHz
UHF 430.00 to 439.995 MHz

Wave type: F3

Rated voltage: DC 13.8 V +/-15 %

Current consumption:

For C5608D transmission:

Hi power 10.5 A (144 MHz band)

9.5 A (430 MHz band)

Mid power 5.5 A (144 MHz band)

5.5 A (430 MHz band)

Low power 3.0 A (144 MHz band)

3.0 A (430 MHz band)

Standby reception 700 mA

Microphone input impedance: 600 ohms

Low-frequency output impedance: 4 ohms

Antenna impedance: 50 ohms

Operating temperature range: -20 °C to +60 °C

Antenna connector: M type (with cable)

Grounding type: Negative GND

Dimensions (width x height x depth):

..... 150 x 50 x 210 mm

Weight: Approx. 2.0 kg

2. Reception

Reception type: Double superheterodyne system
Intermediate frequency:

144 MHz band: 1st IF of 21.8 MHz (low)
2nd IF of 455 kHz (low)

430 MHz band: 1st IF of 23.05 MHz (low)
2nd IF of 455 kHz (low)

Reception sensitivity (12 dB SINAd): -16 dBu (0.158 uV)

Selectivity: -6 dB for 12 kHz or high
-60 dB for 24 kHz or high

Squelch open sensitivity: -19 dBu (0.112 uV)

Low-frequency output: 3 watts (at 10 % distortion)

S/N ratio at 0.5 uV input: 30 dB or more

3. Transmission

Transmission output:

C5600D:

144 MHz band 50 watts (Hi power)

10 watts (Mid power)

3 watts (Low power)

430 MHz band 40 watts (Hi power)

10 watts (Mid power)

3 watts (Low power)

Modulation type: Reactance modulation

Spurious emission intensity: -60 dBc

Modulation distortion: 3 % or less (at 70 % modulation)

*Design and specifications subject to change without notice.

Accessories

Abundant accessories are available to ensure full enjoyment with this product. Read the instruction manual for each accessory with care for proper use.

CTD5600: DTMF (touch tone) unit

CTN5600: CTCSS (tone squelch) unit

CAW560: Dual microphone cable

CAW561: Microphone extension cable (length 2 m)

CAW562: Microphone extension cable (length 4 m)

CSK12: External speaker

Troubleshooting

Before asking for service, please check the relative one(s) of the following items. Unless restoration is obtained, contact with the dealer from which you have purchased, or our authorized representative nearest you or our service station.

	Symptom	Main possible cause and action
Power relatives	Power does not turn ON.	<ul style="list-style-type: none"> * Check the fuse. * Due to DC cable disconnected * Due to excessive voltage (more than DC 18 V) applied to DC IN 13.8 V terminal. In this case, unplug the DC IN 13.8 V terminal and check the DC source voltage.
Display relatives	<p>Frequency display of one band remains off.</p> <p>Display section is dark.</p>	<ul style="list-style-type: none"> * Due to function letting the display section off * Due to DIMM function
Reception relatives	<p>Only strong signals are received.</p> <p>Squelch does not close. Noise is heard.</p> <p>No signals are received.</p> <p>Reception sound is not heard.</p> <p>Reception sound is not sufficiently high.</p> <p>Volume cannot be controlled by remote</p>	<ul style="list-style-type: none"> * Due to SQL knob rotated fully clockwise * Due to antenna abnormality * Due to coaxial cable abnormality * Due to squelch OFF set by remote control microphone * Due to antenna disconnected * Due to coaxial cable disconnected * Due to disagreement in tone frequency during tone squelch operation * Check external speaker for connection. * Check volume control for position. * Due to paging mode or code squelch mode engaged * Due to auto mute operation engaged * Due to volume control knob of radio unit not set to remote position control microphone (not rotated fully counterclockwise)
Transmission relatives	Transmission output is not sufficiently high.	<ul style="list-style-type: none"> * Due to poor matching with antenna * Due to Low power mode engaged * Due to antenna disconnected * Due to antenna not connected
Repeater relatives	<p>Access is not gained to repeater station.</p> <p>"OFF" appears on display section.</p>	<ul style="list-style-type: none"> * Due to tone burst signal is not transmitted. * Due to different tone frequency * Due to excessive remoteness from repeater station * Due to different shift frequency * Due to shift direction set to "+" * Due to shifted frequency going off the band

	Symptom	Main possible cause and action
Scan relatives	<p>Scan is not made.</p> <p>Memory scan is not made.</p> <p>Program scan is not made</p>	<ul style="list-style-type: none"> * Due to SQL knob rotated fully counterclockwise Adjust the SQL knob. * Due to memory frequency not memorized * Due to start and end frequencies not memorized
Memory relatives	<p>Memory erasure is unfeasible.</p>	<ul style="list-style-type: none"> * Due to CLR/STEP kept pressed without releasing from hand pressure the button of the band of which memory is to be erased.
Paging relatives	<p>Paging operation is not made.</p> <p>"E" appears on display section.</p> <p>Code setting is unfeasible.</p>	<ul style="list-style-type: none"> * Due to CTD5600 (option) not installed * Paging operation requires code memorizing. * Due to disagreement in code with opposite station * Due to opposite station or own station wave not arriving * Due to opposite station code read error * Due to CTD5600 (option) not installed
DTMF relative	<p>DTMF signal is not transmitted.</p>	<ul style="list-style-type: none"> * Route the cord beforehand.
Other	<p>Beep sound is not heard.</p>	<ul style="list-style-type: none"> * Beep OFF is set in set mode 0.

Bracket Mounting Hole Work Pattern

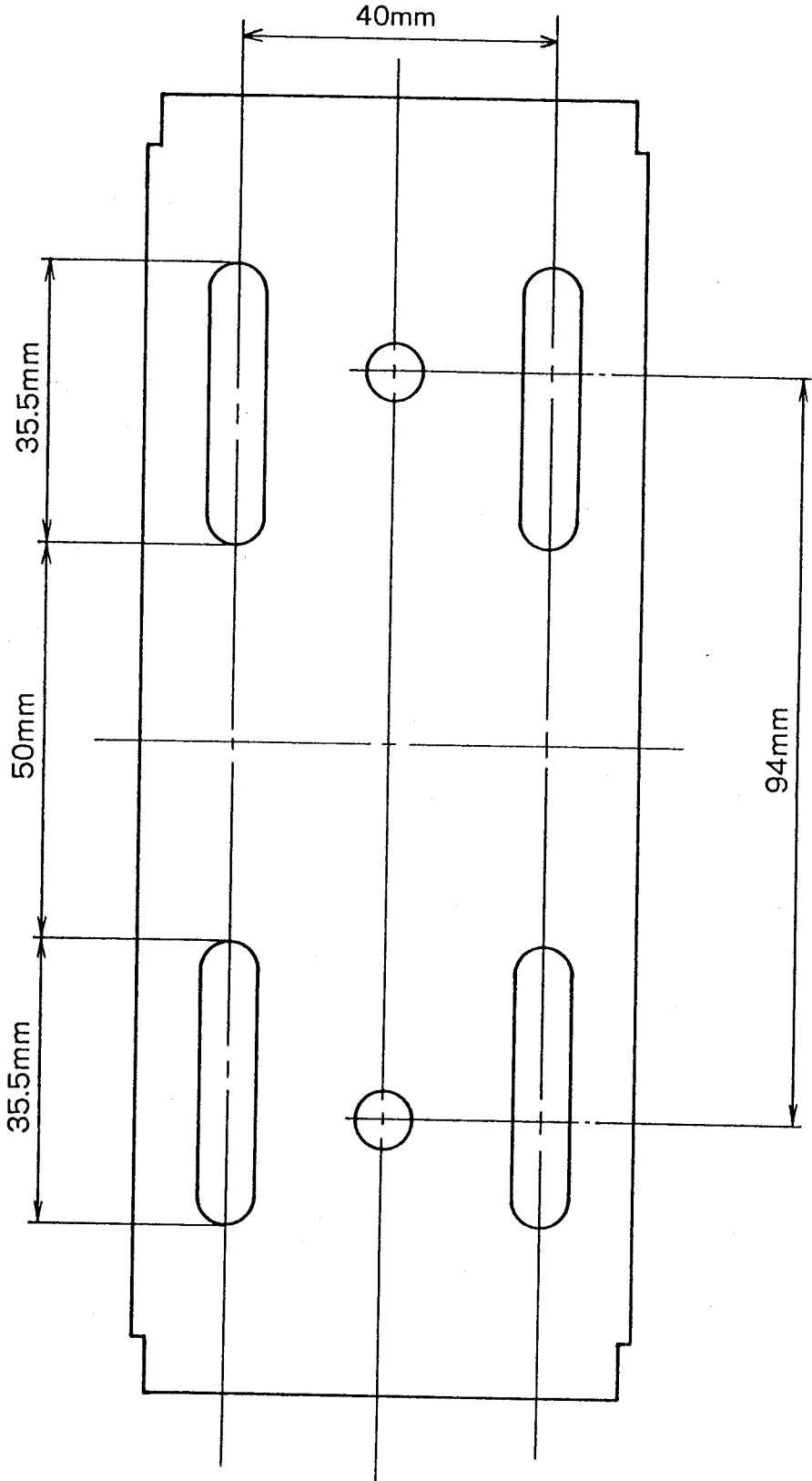

List of Operation Buttons

Radio unit:

Function when directly pressed	Button(s) or knob	Function when pressed after pressure of FUNC button (while FUNC mode LED is lighting)	Function when pressed while pressing FUNC button
Power ON/OFF	VOL P.PWR		Software reset operation (pressed twice)
Band setting	144,430		Function to let the display of 144 MHz band disappear. Function to let the display of 430 MHz band disappear
Frequency up/down, Memory address number up/down	DOWN, UP		
Sub-band setting	SUB		
Memory scan operation	MS/SCAN	Normal scan oper	
Paging operation, Code squelch operation, Code display when pressed continuously	PG-C/DT	DTMF operation	
Memory frequency call	V . M/ENT	Memory write operation	Set mode operation
Clear operation	CLR/STEP	Tuning step	
Call frequency call	CALL/MUTE	Audio signal auto mute operation	
Tone squelch operation, Tone frequency display when pressed continuously	T SQ /KL	Operation button lock operation	
Repeater operation	RPT/SHIFT	Shift direction selection, Shift frequency display when pressed continuously	
Conversion of transmission and reception frequencies during repeater operation	REV/PO	Transmission output selection	
Frequency change	Main dial knob		Function to lower illumination

Remote control microphone:

Function when directly pressed	Key name	Function
Call frequency call	CALL 1	Numeral 1 entry (in frequency setting mode)
Repeater operation	RPT 2	Numeral 2 entry (in frequency setting mode)
Reversal of transmission and reception frequencies	REV 3	Numeral 3 entry (in frequency setting mode)
Volume control mode from remote control microphone	VOL A	DTMF signal A sending (Press while pressing PTT button)
Paging operation, Code squelch operation, Code display when pressed continuously	PG-C 4	Numeral 4 entry (in frequency setting mode)
DTMF operation	DTMF 5	Numeral 5 entry (in frequency setting mode)
Tone squelch operation	T. SQ 6	Numeral 6 entry (in frequency setting mode)
Transmission output selection	PO B	DTMF signal B sending (Press while pressing PTT button)
Memory scan operation	MS 7	Numeral 7 entry (in frequency setting mode)
Normal scan operation	SCAN 8	Numeral 8 entry (in frequency setting mode)
Program scan operation	P. S. 9	Numeral 9 entry (in frequency setting mode)
Tuning step	STEP C	DTMF signal C sending (Press while pressing PTT button)
Memory write operation frequency setting mode	ENT *	DTMF signal * sending (Press while pressing PTT button)
Function mode setting	FUNC 0	Numeral 0 entry (in frequency setting mode)
Shift direction selection	SIFT #	DTMF signal # sending (Press while pressing PTT button)
Clear operation	CLR D	DTMF signal D sending (Press while pressing PTT button)
Frequency up/down, Memory address number up/down, Code address number up/down	▼ ▲	Serves volume control when in volume control mode

MEMO