

TABLE OF CONTENTS

616-429-2334

INTRODUCTION	5
INSTALLATION PRECAUTIONS	6
INSTALLATION INSTRUCTIONS	7
MOUNTING IN A CAR	8
Mounting the Transceiver	8
Removing the Control Head	9
Exchanging the Memory Unit	9
Connecting the Power Supply Cable	10
Attaching the Antenna	10
USING AS A FIXED STATION	12
Installing the Transceiver	12
Attaching the Antenna	12
BASIC OPERATION	13
TURNING ON THE POWER	14
ADJUSTING THE VOLUME	15
ADJUSTING THE SQUELCH	16
BAND SELECTION	17
RECEIVING	18
TRANSMITTING	19
OTHER BASIC OPERATIONS	20
Adjusting the Display Lighting	20
Remote Control Operation with the CMP843A Microphone	20
CONTROL NAMES AND FUNCTIONS	21
ADVANCED OPERATION	29
CHANGING THE FREQUENCY STEP	30
CHANGING THE FREQUENCY STEP BY 1 MHz	31
DISABLING 1 MHz FREQUENCY STEP	31
INPUTTING A FREQUENCY DIRECTLY	32
ACCESSING THE CALLING FREQUENCY	33
Changing the Calling Frequency	34
Storing Associated Data with the Calling Frequency	35
USING THE KEY LOCK	36
USING THE MAIN DIAL KNOB WHILE IN KEY LOCK	37
TURNING OFF THE SQUELCH	38
Controlling the Squelch with RF Level	39
CHANGING TRANSMIT POWER	40

MEMORY FUNCTIONS	41
ABOUT MEMORY	42
STORING OFTEN-USED FREQUENCIES IN MEMORY	42
RECALLING A FREQUENCY FROM MEMORY	43
ERASING DATA AT A SPECIFIC MEMORY ADDRESS	43
CHANGING AN OPERATING FREQUENCY IN MEMORY	43
ASSIGNING PRIORITY TO MEMORY ADDRESSES	44
ASSIGNING TONE SQUELCH MODE TO A FREQUENCY IN MEMORY	44
ASSIGNING TONE ENCODE MODE TO A FREQUENCY IN MEMORY	45
CHANGING THE REPEATER TONE FREQUENCY STORED IN MEMORY	45
ASSIGNING PAGING MODE TO A FREQUENCY IN MEMORY	46
ASSIGNING CODE SQUELCH MODE TO A FREQUENCY IN MEMORY	46
ASSIGNING REPEATER MODE TO A FREQUENCY IN MEMORY	47
ASSIGNING THE SCAN METHOD TO A FREQUENCY IN MEMORY	47
CHANGING THE REPEATER SHIFT FREQUENCY IN MEMORY	48
INHIBITING MEMORY MODIFICATION	48
SCANNING	49
ABOUT SCANNING	50
PREPARING FOR SCAN	51
SCANNING WITHIN 1 MHz (1 MHz SCAN)	52
SCANNING THE ENTIRE BANDWIDTH (ALL SCAN)	52
SCANNING A SPECIFIED RANGE (PROGRAM SCAN)	52
SCANNING FREQUENCIES IN MEMORY (MEMORY SCAN)	53
SCANNING PRIORITIZED MEMORY (PRIORITY SCAN)	53
SCANNING THE MEMORY BY BLOCK (BLOCK MEMORY SCAN)	53
SCANNING IN TONE SQUELCH MODE (TONE SQUELCH SCAN)	54
CHANGING THE SCAN SPEED	54
SELECTING THE SCAN METHOD	54
CHANGING THE HOLD TIME FOR BUSY SCAN	54

OPERATION AS A REPEATER	55
GENERAL INFORMATION	56
SETTING THE REPEATER MODE	57
TRANSMITTING A 1750 Hz TONE BURST	57
SETTING THE TRANSMIT FREQUENCY HIGHER THAN THE RECEIVE FREQUENCY	57
REVERSING THE REPEATER TRANSMIT/RECEIVE FREQUENCIES	58
CHANGING THE REPEATER OFFSET FREQUENCY	58
CHANGING THE REPEATER TONE FREQUENCY	58
ADDITIONAL FEATURES	59
TURNING OFF THE UNUSED BAND	60
DISPLAYING THE SAME BAND ON EACH DISPLAY (V-V, U-U)	60
CHANGING VFO FREQUENCIES SIMULTANEOUSLY (VFO LINK)	60
PREVENTING UNINTENTIONAL TRANSMISSION (PTT LOCK)	60
SETTING AUTOMATIC TRANSMISSION STOP	61
REDUCING SUB-BAND AUDIO OUTPUT (SUB-BAND MUTING)	61
CHANGING THE SUB-BAND AUDIO MUTING LEVEL	61
INHIBITING AUDIO FROM THE MAIN UNIT SPEAKER	61
INHIBITING AUDIO FROM THE MICROPHONE SPEAKER	62
CHANGING THE BEEP VOLUME	62
AM MODE OPERATION	62
OPERATING AS A CROSS BAND REPEATER	63
INITIALIZING (RESETTING)	63
INITIALIZING ALL SETTINGS (ALL RESET)	63
INITIALIZING ALL SETTINGS EXCEPT MEMORY (VFO RESET)	63
CLEARING THE MEMORY (MEMORY RESET)	63
LIST OF SET MODE FUNCTIONS	64

USING TONE SQUELCH UNIT/DTMF UNIT	66
ABOUT THE CTN5700 TONE SQUELCH UNIT	67
USING THE TONE ENCODER	68
USING TONE SQUELCH	68
CHANGING THE TONE FREQUENCY	68
ABOUT THE CTD5700 DTMF UNIT	69
SETTING YOUR OWN INDIVIDUAL CODE	70
INPUTTING ANOTHER PARTY'S PAGING/SQUELCH CODE	70
SETTING A GROUP CODE	71
PAGING METHOD	71
CHANGING THE TIME REQUIRED FOR PAGING SIGNAL OUTPUT	72
CHANGING THE NUMBER OF PAGING ALERTS	72
USING CODE SQUELCH	72
USING THE DTMF	73
STORING THE DTMF CODE	73
STORING THE DTMF CODE IN MEMORY	74
CHANGING THE DTMF CODE IN MEMORY	74
CONFIRMING THE DTMF CODE IN MEMORY	75
ERASING THE STORED DTMF CODE	75
SENDING THE STORED DTMF CODE	76
CHANGING THE DTMF CODE SENDING SPEED	76
CHANGING THE DTMF TO A SINGLE TONE	76
REFERENCES	77
PACKET OPERATION	78
OPERATING AT 9600 BAUD HIGH SPEED PACKET AND PREPARATION FOR PACKET COMMUNICATIONS	78
TIPS FOR PACKET OPERATION	78
CONNECTING TO OTHER MANUFACTURES	79
OPERATING AFSK 1200 BAUD	79
WIRING THE MODEM AND C5718DA	80
USING THE OPTIONAL CAW570~CAW575 CABLE	80
TROUBLESHOOTING	81
OPTIONS	82
AFTER-SALE SERVICE	82
RATINGS	83
INDEX	84
ONE YEAR LIMITED WARRANTY	85

INTRODUCTION

INSTALLATION PRECAUTIONS

Installation Location

The following points must be noted regarding location of the transceiver.

1. Avoid a place with high temperature, high humidity or dust. Avoid a location with direct exposure to sunlight. Install in a dry and well-ventilated area.
2. In order to maintain the cooling effect of the transceiver's radiating fins, provide sufficient space at back of the transceiver and under it. The transceiver main unit may get warm if it is used for a long period of time. This is normal.

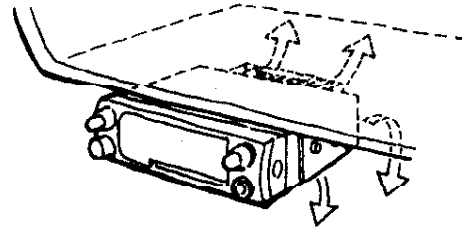
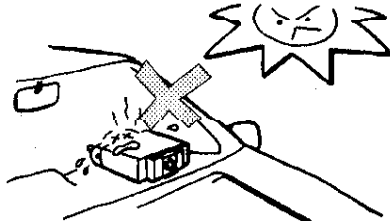

Dashboard Mounting

1. It is recommended that the transceiver be mounted under the dashboard, at the side of the glove box or under the instrument panel.
2. Attach the transceiver so that the back of the transceiver does not touch any material that could melt or be deformed by the heat of the transceiver. Install the transceiver in a place as free of vibration as much as possible.

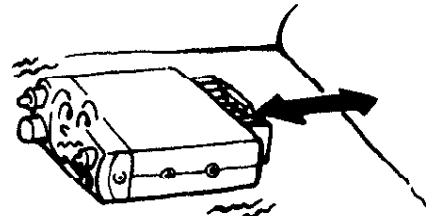
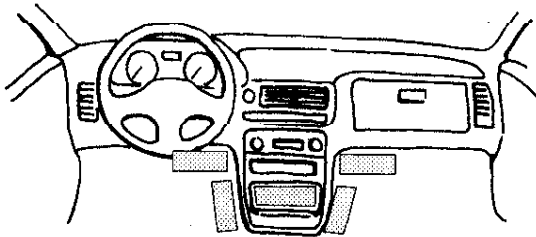

CAUTION: Never install the transceiver in the following places:

- Near air conditioner outlet vents
- Places exposed to direct sunlight
- Places with extensive vibration
- Near electronic circuits
- Places where the transceiver may affect driving safety

Power Supply

1. The transceiver is designed for automobiles with 12VDC electrical systems. It can not be used for trucks and other types of vehicles with 24VDC electrical systems unless a 24VDC-to-12VDC converter is used.
2. NEVER connect the transceiver to Alternating Current (AC). This will cause irreparable damage to the transceiver.

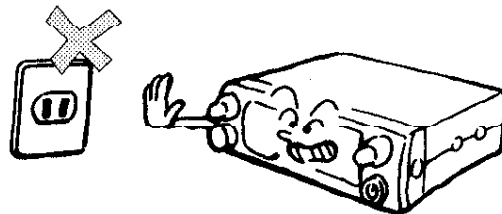
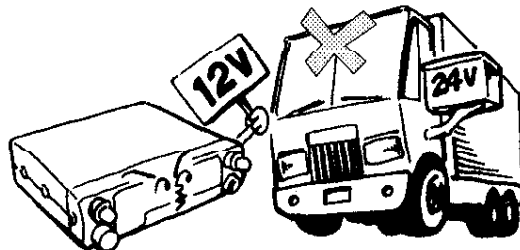

INSTALLATION INSTRUCTIONS

MOUNTING IN A CAR	8
Mounting the Transceiver	8
Removing the Control Head	9
Exchanging the Memory Unit	9
Connecting the Power Supply Cable	10
Attaching the Antenna	10
USING AS A FIXED STATION	12
Installing the Transceiver	12
Attaching the Antenna	12

Mounting the Transceiver

Attaching the Mounting Bracket

Attach the mounting bracket in a place where it can be firmly fixed.
Be sure to use the bolts and the screws included.

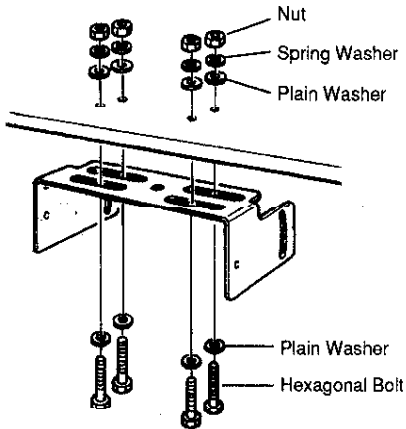

1. Bore holes of $\phi 5.2 \sim 5.5\text{mm}$ or M5mm hex-head bolts.
Bore holes of $\phi 4.0 \sim 4.3\text{mm}$ or M5mm self-tapping screws.

2. Pass the M5mm hex-head bolts through plain washers.
Next, attach the bracket with plain washers, spring washers and nuts from the interior side.
Pass the M5mm self-tapping screws through plain washers and screw in.

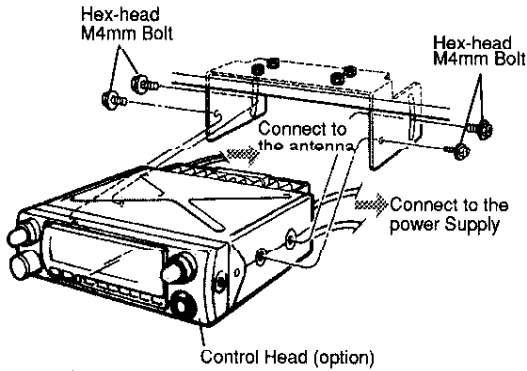

3. Connect the antenna to the coaxial cable connector on the rear panel of the main unit .
Connect the power cable to the 12VDC power supply.

4. Insert the main unit in the mounting bracket and tighten with the M4mm bolts.

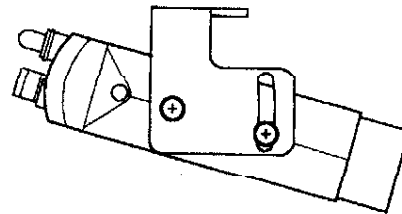
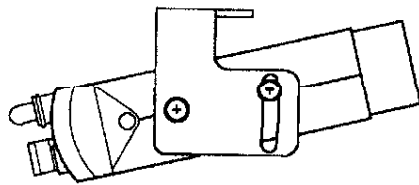

Removing the Control Head (OPTION)

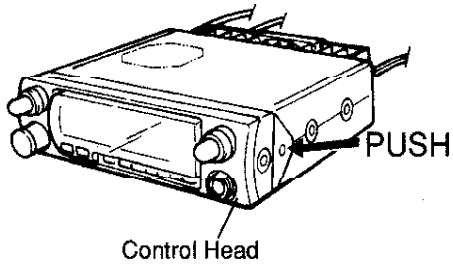

1. Pull the control head toward the front while pressing the release button on the side of the main unit.
2. Open the lid on the back of the control head.
3. Attach the connector for the separate cable by noting polarity in the reverse order and close the lid.

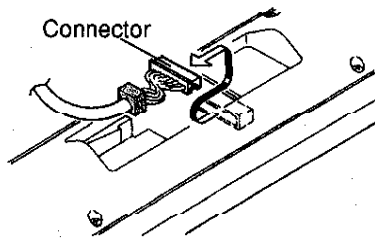
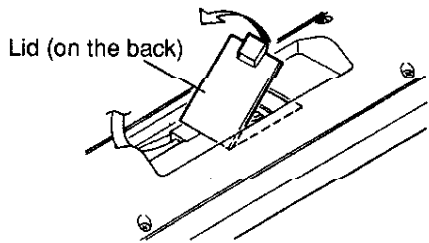

- ◆ C5718DA does not have a control head. When the optional CRC5700A control head is purchased, attach it by following the reverse order stated above.
- ◆ The connector for the separate cable on the main body can be removed by following the same steps.

Exchanging the Memory Unit

The main unit is supplied with the CMU181 memory unit (20 channels per band). This memory unit can be replaced with a CMU182 memory unit (100 channels per band)

The memory unit is located on the front of the main unit as shown in the figure below.

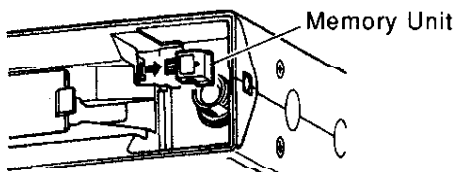

1. Turn off the power.
2. Remove the control head or separate cover.
3. Pull out the memory unit attached to the main unit.
4. Insert the memory unit to be exchanged.



- ◆ CMU181 can store 20 channels each for VHF and UHF bands.
- ◆ CMU182 can store 100 channels each for VHF and UHF bands.

CAUTION

- ◆ Do not pull out or insert the memory unit when power is on.
- ◆ When using the optional memory unit the first time, be sure to perform the all-reset operation (P 62).

Connecting the Power Supply Cable

The transceiver requires power from the automobile's 12VDC battery. Use the power supply cord in the accessory package to connect the battery to the transceiver.

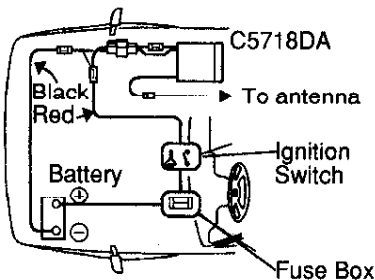
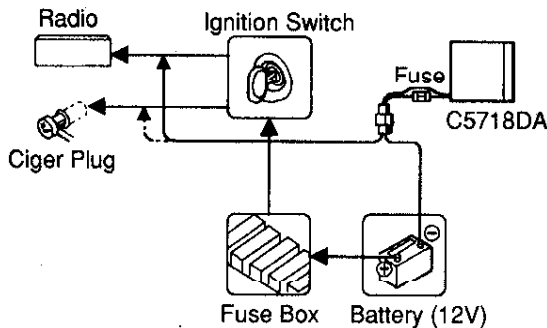
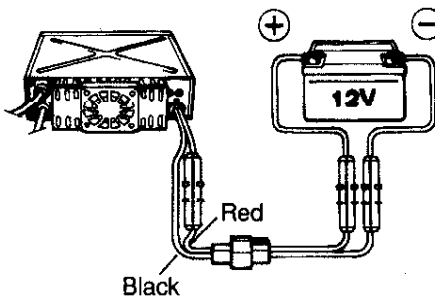
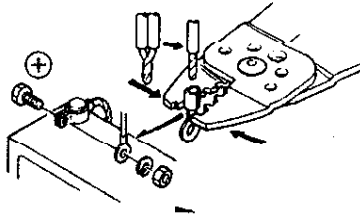

1. Before connection, disconnect the \ominus terminal of the battery. This will prevent a short circuit .
2. Firmly tighten the battery terminals. may not be loosened.
3. After tightening the \oplus terminal, tighten the \ominus terminal.
4. Connect the power-connector on the main unit with the connector on the power supply cable. The red power supply lead is connected to the 12V \oplus terminal after it passes through the automobile ignition key switch . The black lead is connected to the 12V \ominus terminal.

CAUTION

- ◆ When using the transceiver on a vehicle with a 24V electrical system, you must use a DC-DC converter to convert 24V to 12V.
- ◆ If the automobile is not used for a long period of time, disconnect the power supply lead. C5718DA require 12A fuses.

Attaching the Antenna

Performance of the transceiver depends greatly on antenna characteristics. Select an antenna that matches the operating requirements.

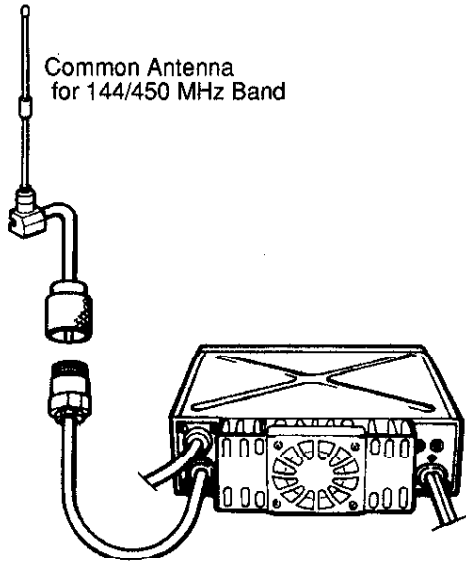

When using a common antenna

The transceiver has a built-in duplexer. Therefore, a common antenna for 144/450 MHz band can be used.

1. Connect the coaxial cable connector on the main unit to an antenna.

When using independent antennas

1. Connect the coaxial cable connector on the main unit to a coaxial switch.
2. Connect a 144 MHz antenna to the coaxial jack for 144 MHz band on the coaxial switch. Next, connect a 450 MHz antenna to the coaxial jack for 450 MHz band on the coaxial switch.

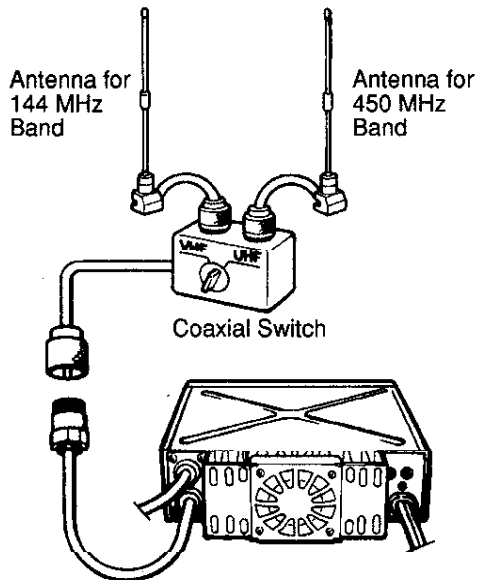

CAUTION

- ◆ Do not scratch or squeeze the coaxial cable.
- ◆ Adjust VSWR of the antenna to 1.5 or less.
- ◆ When mounting an antenna base, connect a ground between the base and the automobile body.

Installing the Transceiver

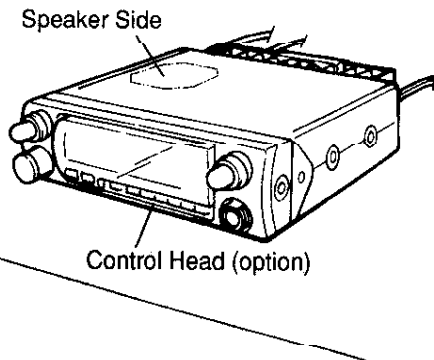

When using the transceiver as a fixed station, use a DC-stabilized power supply, such as the following:

DC Output: 13.8V
Output Current: 15A or more

When using the transceiver as a fixed station, the transceiver may be installed so that the control head is upside down and the built-in speaker faces upward.

Attaching the Antenna

When using a vertical antenna, be sure that the antenna itself is not weighted by the coaxial cable.

For fixing a rain protector on the cable, refer to the antenna installation manual.

The following example is for installation on a building. For details, consult with your dealer, our service office, or service center.

For water-proof treatment of connectors, wrap double-sided self-adhesive tape while pulling it for tension, and then wrap single-sided vinyl tape or equivalent on top of it.

CAUTION

- ◆ Check all support lines to be sure that the antenna does not damage surrounding buildings if it falls or is blown down by strong winds.
- ◆ Make the coaxial cable run as short as possible.

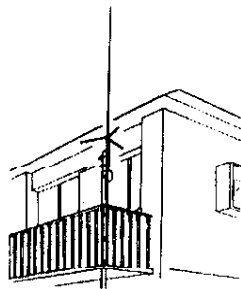

GP (Ground Plane) Antenna
<Attached to a porch>

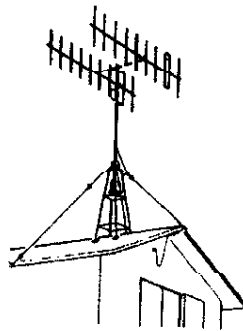

Yagi Antenna
<Attached on a roof>

BASIC OPERATION

TURNING ON THE POWER	14
ADJUSTING THE VOLUME	15
ADJUSTING THE SQUELCH	16
BAND SELECTION	17
RECEIVING	18
TRANSMITTING	19
OTHER BASIC OPERATIONS	20
Adjusting the Display Lighting	20
Remote Control Operation with the CMP843A Microphone	20
CONTROL NAMES AND FUNCTIONS	21

TURNING ON THE POWER

On the CRC5700A Control Head:

1. Press the **P.PWR** switch.

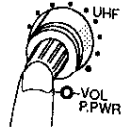

2. Check the display for indication.

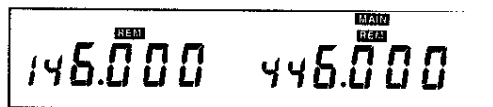

3. To turn power off, press **P.PWR** again.

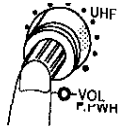

On the CMP843A Microphone:

1. Press the **PWR** switch.



2. Check the display for indication.

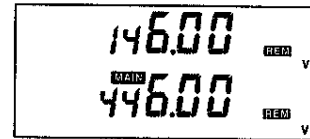

3. To turn power off, press **PWR** again.



ADJUSTING THE VOLUME

On the CRC5700A Control Head:

To turn up the volume, turn the **[VOL]** knob clockwise.

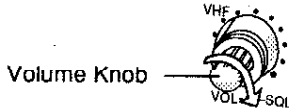

To turn down the volume, turn the **[VOL]** knob counterclockwise.

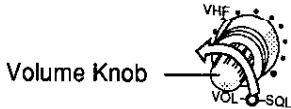

- ◆ When "V" on the display is not blinking on the CMP843A Microphone, press **[AVO-SQ]** key.
- ◆ When using the control head and the CMP843A Microphone at the same time, adjust the volume with the CMP843A Microphone by turning the **[VOL]** knob of the control head counterclockwise to "R" (remote) position. The display on the control head shows **[RFM]** (P 20). At this time, use the CMP843A Microphone for adjusting squelch (P 16).
- ◆ When adjusting the volume, use the squelch off condition. (P 38).

ATTENTION

If the **[VOL]** knob is set to "R" position when the CMP843A Microphone is not connected, squelch control is disabled.

On the CMP843A Microphone:

1. Press the **[AVO-SQ]** key.



2. Check the display for a blinking "V" indication.



To turn up the volume

Press the **[3/UP]** key.
While the key is held down, the volume will increase.

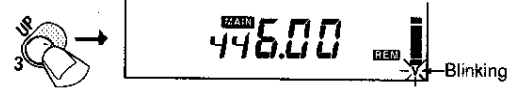

To turn down the volume

Press the **[AVO-SQ]** key.
Check the display for a "V" indication.
Press the **[2/DOWN]** key.
While the key is held down, volume will decrease.



ADJUSTING THE SQUELCH

Squelch On

When the transceiver is not receiving any signal, it makes a noise like static. The squelch function is used to cancel this noise.

On the CRC5700A Control Head:

Turn the **[SQL]** knob slowly clockwise. Stop turning the knob at the position where the noise disappears.

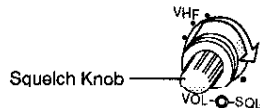

When the knob is turned counterclockwise, the noise will be heard again.

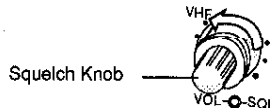

On the CMP843A Microphone:

1. Press the **[A/VO-SQ]** key twice.



2. Check the display for blinking of the "SQ" indicator.

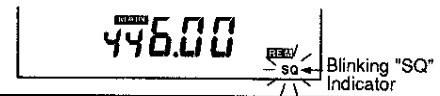

3. Keep pressing the **[3/UP]** key. Release the key at the position where the noise disappears.



4. When the **[2/DOWN]** key is held down, the noise will be heard again.



- ◆ When "SQ" on the display is not blinking on the CMP843A Microphone, press the **[A/VO-SQ]** key.
- ◆ If the squelch level is increased, weak signals may not be received.
- ◆ The condition where noise is heard is called "squelch off". The condition without the noise (squelch operating) is called "squelch on". The transceiver can be set to "squelch off" by key operation (**P** 38).
- ◆ When using the control head and the CMP843A Microphone at the same time, adjust the squelch with the CMP843A Microphone by turning the **[VOL]** knob of the control head counterclockwise and setting to "R" position. The display on the control head will show **[REM]** for "remote" (**P** 20). Then use the microphone for adjusting volume (**P** 15).

BAND SELECTION

One band can be selected as the "Main" band. The band not selected is called the "sub-band."

On the CRC5700A Control Head:

To select VHF band
Press the **[144]** key.



Check the display for the "MAIN" indication.

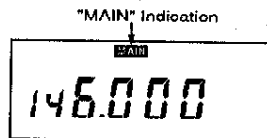

On the CMP843A Microphone:

To select VHF band
Press the **[D/BAND]** key.



Check the display for the "MAIN" indication.

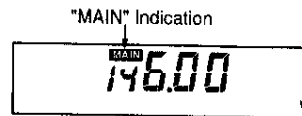

To select UHF band
Press the **[450]** key.



Check the display for the "MAIN" indication.

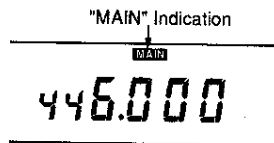

To select UHF band
Press the **[D/BAND]** key.



Check the display for the "MAIN" indication.

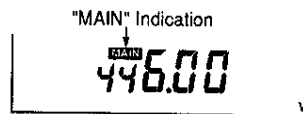

◆ The band selected at this time is called the "main band". The band not selected is called the "sub band".

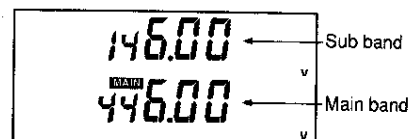
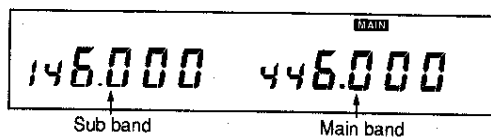

RECEIVING

On the CRC5700A Control Head:

1. Select the band with the **[144]** or **[450]** key.

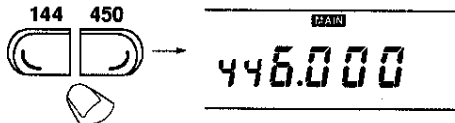

2. Verify VFO mode.

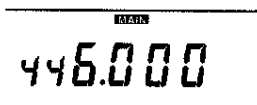

3. Turn the main dial to the desired receive frequency.

Turning the main dial clockwise increases the frequency.

Turning the main dial counterclockwise decreases the frequency.

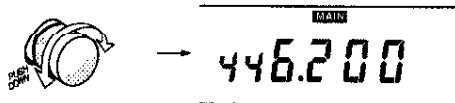

On the CMP843A Microphone:

1. Select the band with the **[D/BAND]** key.

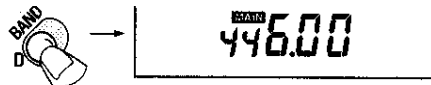

2. Verify VFO mode.



3. Press the **[2/DOWN]** or **[3/UP]** key and tune to the desired receive frequency.

The frequency decreases when the **[2/DOWN]** key is pressed.

The frequency increases when the **[3/UP]** key is pressed.

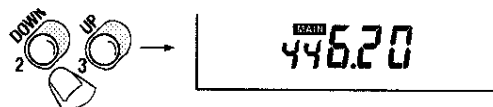

- ◆ VFO mode is the condition in which the frequency can be changed by the main dial, **[2/DOWN]** / **[3/UP]** keys or the keys on the microphone numerical keypad.

- ◆ The frequency can be input on the CMP843A Microphone keypad by 1 MHz or by 100 MHz (direct input; **D** 32).

TRANSMITTING

On the CRC5700A Control Head:

1. Select the band with the [144] or [450] key.

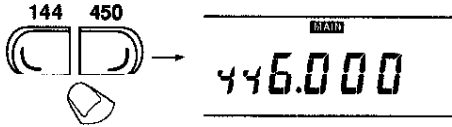

2. Verify VFO mode. (P 18)



3. Turn the main dial to display the desired transmit frequency.

The frequency increases when the main dial is turned clockwise.

The frequency decreases when the main dial is turned counterclockwise.

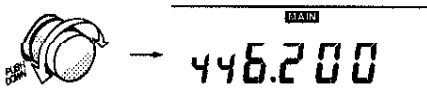

4. To transmit, press the microphone [PTT] switch and talk into the microphone.

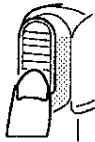

ATTENTION

- ◆ Before transmitting, be sure that the frequency is not in use.

On the CMP843A Microphone:

1. Select the band with the [D/BAND] key.

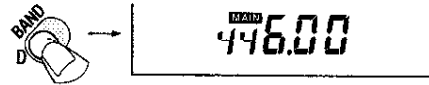

2. Verify VFO mode. (P 18)



3. Press the [2/DOWN] or [3/UP] key to display the desired transmit frequency.

The frequency decreases when [2/DOWN] key is pressed.

The frequency increases when [3/UP] key is pressed.

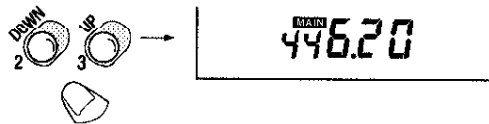

4. To transmit, press the microphone [PTT] switch and talk into the microphone.



- ◆ The frequency can be input on the microphone keypad by 1 MHz or 100 MHz (direct input; P 32).

OTHER BASIC OPERATIONS

Adjusting The Display Lighting

On the CRC5700A Control Head:

1. Simultaneously press the main dial and the **FNC** key.



2. To return to the original state, repeat step 1.



On the CMP843A Microphone:

1. Simultaneously press the **V-V,U-U** and **0/FUNC** keys.



2. To return to the original state, repeat step 1.



When using the control head and the CMP843A Microphone at the same time, the volume and the squelch can be adjusted with the CMP843A Microphone.

Remote Control Operation with the CMP843A Microphone

1. Set the **VOL** knob on the control head to "R" position.

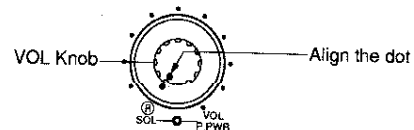

2. Check the display on the display section of the control head for remote **REM** indication.

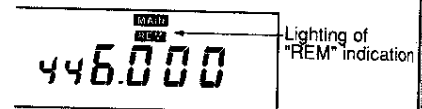

3. To cancel this operation, turn the **VOL** knob on the control head off "R" position.

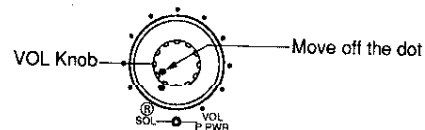

4. Check the control head display and note that the remote indication **REM** has disappeared.

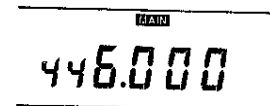

When a CRC5700A is not connected to the transceiver, the transceiver will function automatically in remote mode, and "REM" will light up in the display.

CONTROL NAMES AND FUNCTIONS

The following section describes the major functions of each control on the control head.

Option

C5718DA does not have a control head.

When the optional CRC5700A control head is purchased, attach it by following the reverse order stated above.

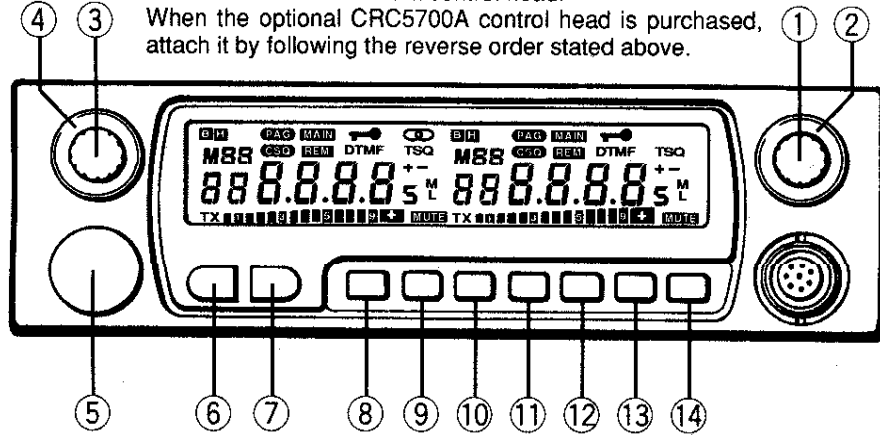

① VOL/P.WR (for 450 MHz Band)

- Pressing this knob turns on the transceiver.
- Turning this knob adjusts the volume on the 450 MHz band.
- When the CMP843A Microphone is connected and this knob is set to "R" (remote) position, the volume and the squelch on the 450 MHz band can be adjusted.

② SQL (for 450 MHz Band)

- Turning this knob adjusts the squelch on the 450 MHz band.
- RF squelch operation is enabled when this knob is turned fully clockwise (↻).

③ VOL (for 144 MHz Band)

- Turning this knob adjusts the volume on the 144 MHz band.
- When the CMP843A Microphone is connected and this knob is set to "R" (remote) position, the volume and the squelch on the 144 MHz band can be adjusted by controls on the microphone.

④ SQL (for 144 MHz Band)

- Turning this knob adjusts the squelch on the 144 MHz band.
- RF squelch operation is enabled when this knob is turned fully clockwise (↻).

⑤ MAIN DIAL KNOB /DIM SWITCH

This control has two functions:

It controls display lighting and it selects symbols and numbers on the display that represent frequency and other parameters such as memory address, set number, etc.

⑥ 144

- When this key is pressed, the 144 MHz band becomes the main band. At this time, "MAIN" is displayed on the 144 MHz band side of the display.
- When this key is pressed while pressing the **FNC** key, the 144 MHz band side is turned OFF.
- When this key is pressed for 2 seconds during main band operation, the 144 MHz band becomes a 450 MHz band (U-U).

⑦ 450

- Pressing this key selects the 450 MHz band as main band. At this time, "MAIN" is displayed on the 450 MHz band side of the display.
- Pressing this key in FNC mode turns the 450 MHz band off.
- When this key is pressed for 2 seconds, the 450 MHz band becomes a 144 MHz band (V-V).

⑧ FNC

- Pressing and releasing this key enables the function mode for about 3 seconds. In the function mode, the characters above each function key light red. After about 3 seconds, the transceiver reverts to normal mode, abandoning the function mode. The function mode lit up in red. In this manual, the function mode is indicated by "FNC".

⑨ MS/PO

- Pressing this key initiates Memory Scan.
- Holding down this key sets the condition for selecting memory scan method.
- In the FNC mode, pressing this key changes transmit power.
- Pressing this key and the **FNC** key simultaneously mutes audio output on the sub-band.

⑩ SCN/TCQ

- When this key is pressed, 1 MHz scan or all-scan is enabled.
- When this key is pressed after pressing the **FNC** key, the transceiver enters the tone encode mode.
- When this key is pressed in the tone encode mode after pressing the **FNC** key, the transceiver enters the tone squelch mode.
- When this key is kept pressed after pressing the **FNC** key, the transceiver enters the condition for changing the tone frequency.
- When this key is pressed while pressing the **FNC** key, program scan is enabled.
- When this key is kept pressed while pressing the **FNC** key during 1 MHz scan or all-scan, it is possible to change over 1 MHz/all scan.

⑪ REV/RPT

- Pressing this key in repeater mode will reverse the transmit/receive frequencies.
- Pressing this key after pressing the **FNC** key initiates the repeater mode.
- When this key is pressed while pressing the **FNC** key, the shift direction can be set.
- When this key is kept pressed while pressing the **FNC** key, the left VFO can be linked to the right VFO (VFO link).

⑫ V.M/ENT

- Pressing this key allows access to frequencies in memory. After memory operation, the transceiver returns to VFO mode.
- When this key is pressed after pressing the **FNC** key, writing to memory can be performed.
- When this key is pressed while pressing the **FNC** key, the transceiver enters the condition for changing the set mode.

⑬ PG.C/DT

- Pressing this key enables the Paging Mode.
- Pressing this key while in Paging Mode enables the code squelch mode.
- When this key is kept pressed, the transceiver enters the condition for changing the paging code.
- Pressing this key after pressing the **FNC** mode enables the DTMF mode.
- When this key is kept pressed after pressing the **FNC** key, the transceiver enters the condition for changing the DTMF code.
- When this key is pressed while pressing the **FNC** key, the transceiver enters the key lock condition.

⑭ CAL/STEP

- Pressing this key puts the Calling Frequency (CAL) on the main band. If the key is pressed while the Calling Frequency is displayed, the transceiver will return to VFO mode.
- When this key is pressed after pressing the **FNC** key, the transceiver enters the condition for changing the step frequency.
- When this key is pressed while pressing the **FNC** key, the transceiver enters the condition for changing the shift frequency.

Display Section of the Control Head (optional)

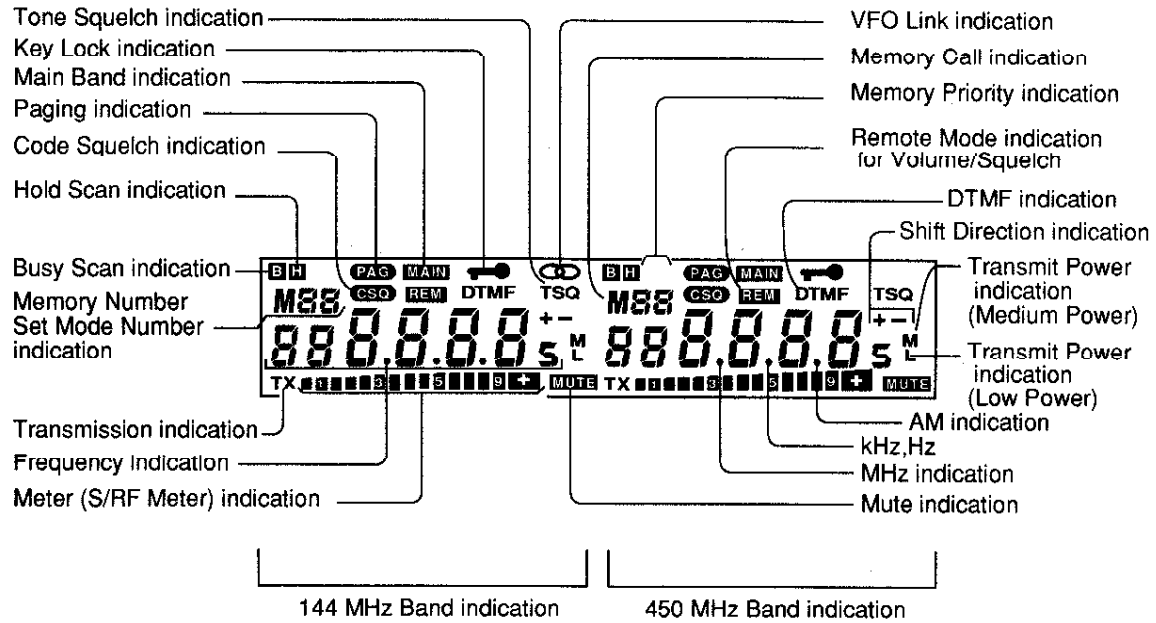

Display Section of the CMP843A Full Remote Controller/Microphone

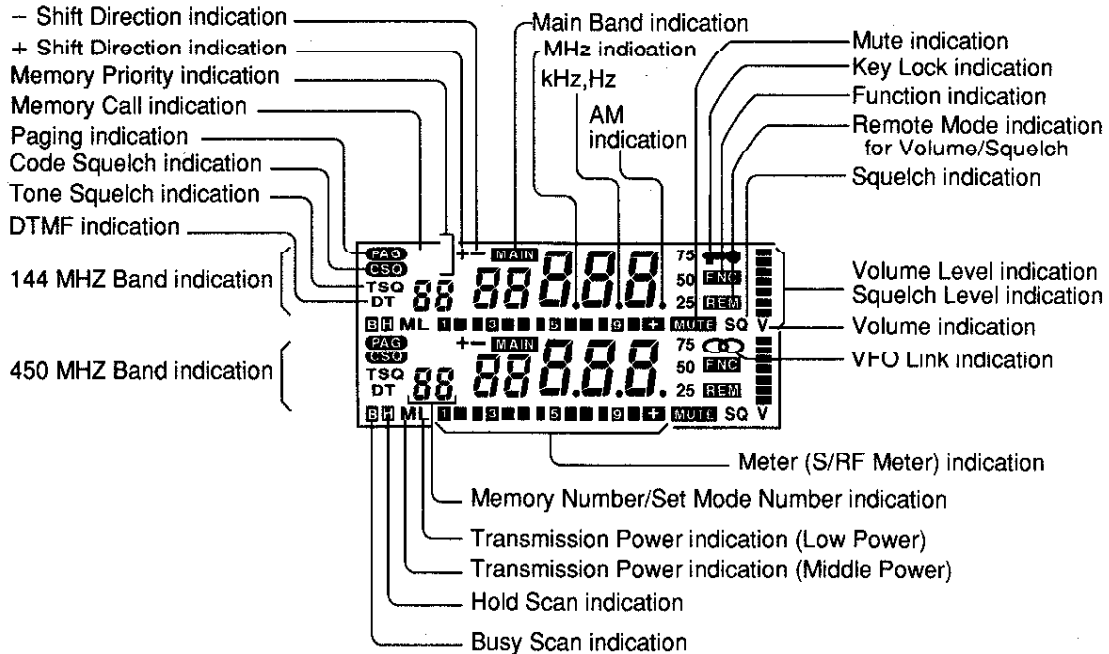

Front/Rear Section of Main Unit

(Front View)



(Rear View)

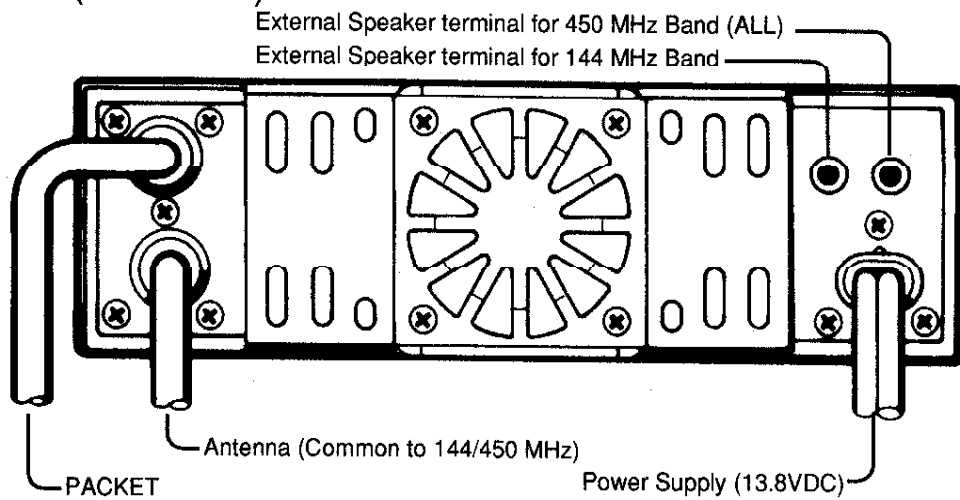

The following section describes major functions of each control on the CMP843A Microphone.

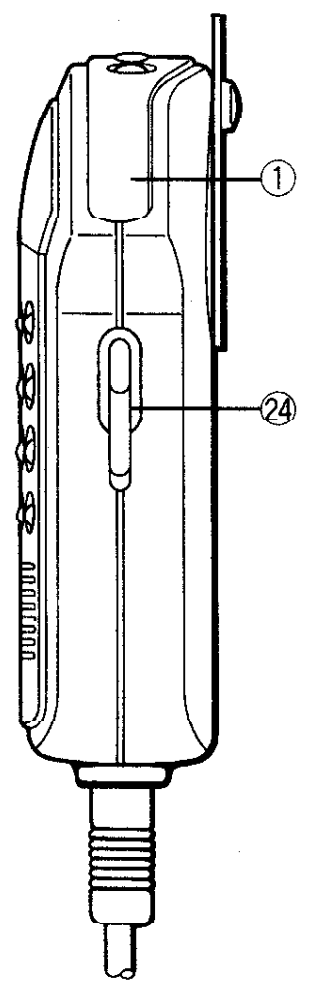
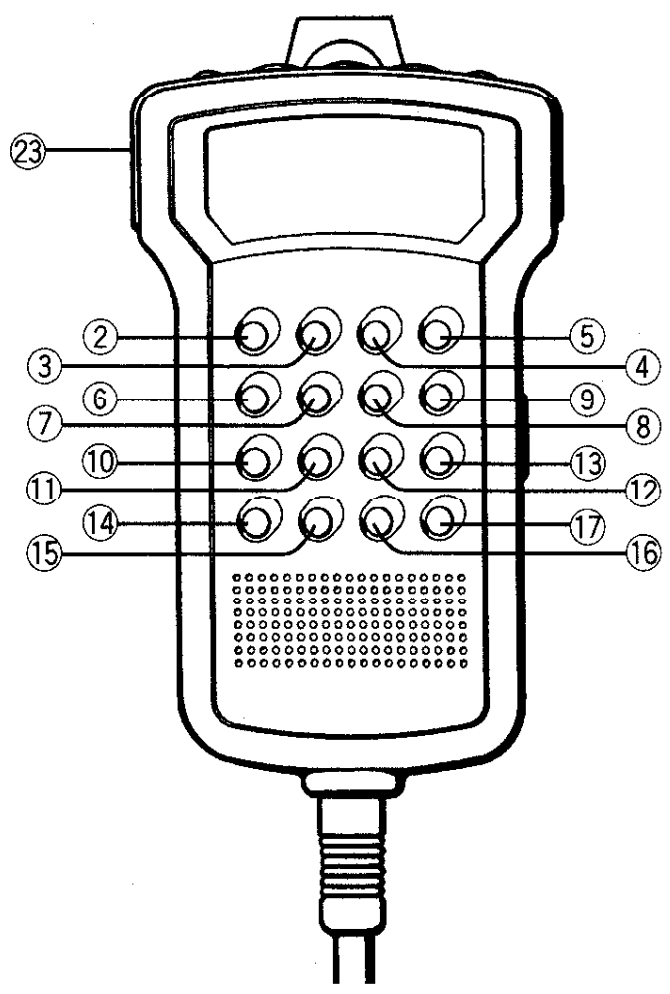
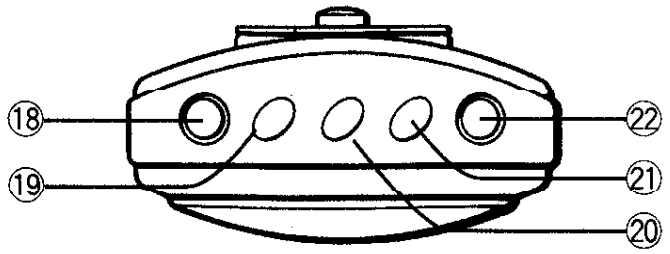

① **PTT**

- Press this switch to transmit on the Main Band.

② **1/CALL**

- Press this key to put the Calling Frequency on the Main Band.
- When pressed in the direct mode, "1" is input.
- When pressed while pressing **[PTT]**, DTMF signal 1 is transmitted.

③ **2/DOWN**

- When this key is pressed, the frequency, memory address number and others are decreased.
- When pressed in the direct mode, "2" is input.
- When pressed while pressing **[PTT]**, DTMF signal 2 is transmitted.

④ **3/UP**

- When this key is pressed, the frequency, memory address number and others are increased.
- When pressed in the direct mode, "3" is input.
- When pressed while pressing **[PTT]**, DTMF signal 3 is transmitted.

⑤ **A/VO-SQ**

- When this key is pressed in remote (REM) mode, the transceiver enters the condition for setting the volume or squelch.
- When pressed while pressing **[PTT]**, DTMF signal A is transmitted.

⑥ **4/PG-C**

- Pressing this key enables the Paging Mode. When pressed in Paging Mode, code squelch mode is enabled.
- When this key is kept pressed, the transceiver enters the condition for changing the paging code.
- When pressed in direct mode, "4" is input.
- When pressed while pressing **[PTT]**, DTMF signal 4 is transmitted.

⑦ **5/DTMF**

- Pressing this key enables the DTMF Mode.
- When this key is kept pressed, the transceiver enters the condition for setting the DTMF code.
- When pressed in direct mode, "5" is input.
- When pressed while pressing **[PTT]**, DTMF signal 5 is transmitted.

⑧ **6/T-SQL**

- Pressing this key enables the Tone Encode Mode. When pressed in tone encode mode, tone squelch mode is enabled.
- When pressed in direct mode, "6" is input.
- When pressed while pressing **[PTT]**, DTMF signal 6 is transmitted.

⑨ **B/SUB MUTE**

- Pressing this key mutes the audio of the sub-band.
- When pressed while pressing **[PTT]**, DTMF signal B is transmitted.

⑩ **7/MS**

- Pressing this key initiates memory scan.
- When this key is kept pressed, the transceiver enters the condition for changing the memory scan method.
- When pressed in direct mode, "7" is input.
- When pressed while pressing **[PTT]**, DTMF signal 7 is transmitted.

⑪ **8/SCAN**

- When this key is pressed, 1 MHz Scan or All-Scan is enabled.
- When pressed after pressing the **[O/FUNC]** key during 1 MHz scan or all-scan, scan toggles between 1 MHz and All-Scan.
- When pressed in direct mode, "8" is input.
- When pressed while pressing **[PTT]**, DTMF signal 8 is transmitted.

- ⑫ **9/P.S**
- Pressing this key enables Program Scan.
 - When pressed in direct mode, "9" is input.
 - When pressed while pressing **[PTT]**, DTMF signal 9 is transmitted.
- ⑬ **C/PO**
- Pressing this key changes transmit power.
 - When pressed while pressing **[PTT]**, DTMF signal C is transmitted.
- ⑭ *** ENT.DIRECT**
- Pressing this key allows numbers to be input directly into the transceiver. (**P** 32).
 - When pressed while pressing **[PTT]**, DTMF signal * is transmitted.
- ⑮ **0/FUNC**
- Pressing this key establishes the Function Mode.
In this manual, the function mode is indicated by "FNC".
 - When this key is pressed in the direct mode, "0" is input.
 - When this key is pressed while pressing **[PTT]**, DTMF signal 0 is transmitted.
- ⑯ **#/V-M**
- Pressing this key causes the transceiver to alternate between VFO mode and operation using frequencies stored in memory
 - When pressed while pressing **[PTT]**, DTMF signal # is transmitted.
- ⑰ **D/BAND**
- Pressing this key switches Main Band and Sub-Band
 - When pressed while pressing **[0/FUNC]**, the sub-band is turned OFF.
 - When pressed while pressing **[PTT]**, DTMF signal D is transmitted.
- ⑱ **PWR**
- Pressing this key turns on the transceiver.
- ⑲ **RPT/SHIFT**
- Pressing this key enables repeater operation.
 - When this key is kept pressed, the transceiver enters the condition for changing the repeater shift frequency .
 - When pressed after pressing **[0/FUNC]** key, the shift direction can be changed.
 - When pressed while pressing **[0/FUNC]** key, the 144 MHz band and the 450 MHz band can be linked.
- ⑳ **REV/STEP**
- Pressing this key reverses the transmit and receive frequencies for repeater operation.
 - When pressed after pressing **[0/FUNC]** key, conditions are set for changing the step frequency.
- ㉑ **SET**
- Pressing this key allows the Set Mode to be selected.
- ㉒ **V-V,U-U**
- When this key is pressed, the display can be set for the 144 MHz band or the 450 MHz band.
- ㉓ **SQL-OFF**
- Pressing this key turns squelch off.
- ㉔ **K-LOCK**
- When this key is pushed down, key operations by the CMP843A Microphone are disabled.

The following section describes major functions of each control on the CMP842 Remote Controller/Microphone.

Option

C5718DA does not have a remote controller/Microphone.

When the optional CMP842 Remote Controller/Microphone is purchased, attach it by following the reverse order stated above.

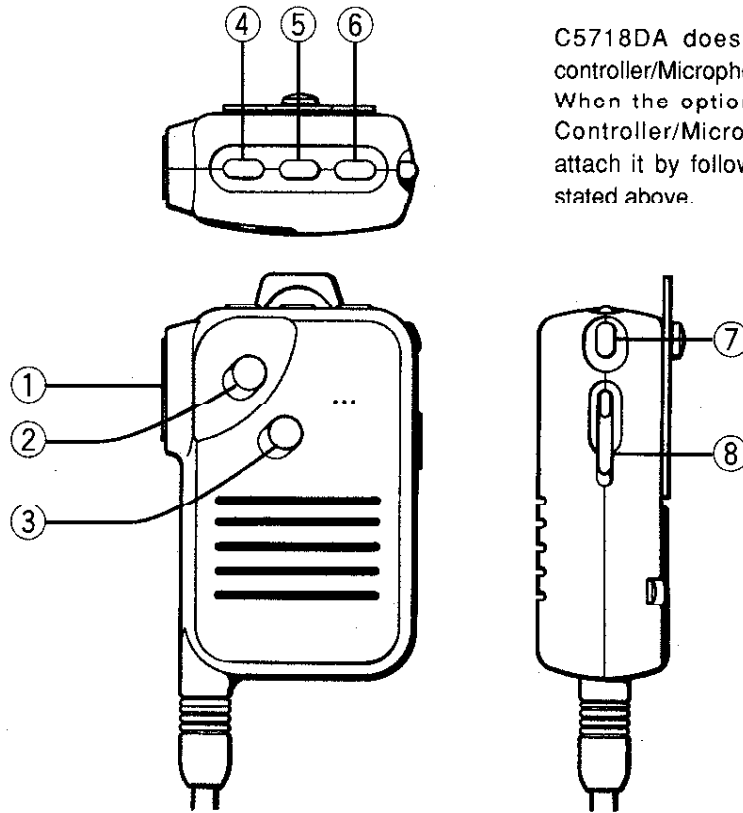

① PTT

- Pressing this key causes the transceiver to transmit on the frequency displayed as main band.

② ▲ UP

- Pressing this key increases frequency.

③ DOWN ▼

- Pressing this key decreases frequency.

④ POWER

- Pressing this key turns on the transceiver.

⑤ V.M

- Pressing this key toggles between VFO mode and the condition that uses frequencies stored in memory.

⑥ BAND

- Pressing this key switches the Main Band and the Sub-Band.

⑦ SQL OFF

- Pressing this key turns squelch off.

⑧ K-LOCK

- When this key is pushed down, CMP842 microphone keys are disabled.

ADVANCED OPERATION

CHANGING THE FREQUENCY STEP	30
CHANGING THE FREQUENCY STEP TO 1 MHz.....	31
DISABLING 1 MHz FREQUENCY STEP	31
INPUTTING A FREQUENCY DIRECTLY	32
ACCESSING THE CALLING FREQUENCY	33
Changing the Calling Frequency	34
Storing Associated Data with the Calling Frequency.....	35
USING THE KEY LOCK.....	36
USING THE MAIN DIAL KNOB WHILE IN KEY LOCK	37
TURNING OFF THE SQUELCH	38
Controlling the Squelch with RF Level (Setting the RF Squelch)	39
CHANGING TRANSMIT POWER	40

CHANGING THE FREQUENCY STEP

With the initial setting, frequency will change by 25 kHz steps when the control head main dial knob is turned, or when the **[2/DOWN]** or **[3/UP]** key on the CMP843A Microphone is pressed. The frequency step can be set to 5/10/12.5/15/20/25/50/100 kHz.

On the CRC5700A Control Head:

1. Select the band with the **[144]** or **[450]** key.



2. Verify VFO mode. (P 18)

3. Press the **[FNC]** key.



4. Press the **[CAL/STEP]** key.



5. Check the display for the frequency step indication.

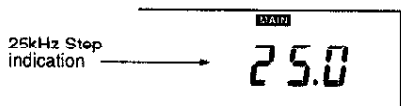

6. Turn the main dial to display the desired frequency step.

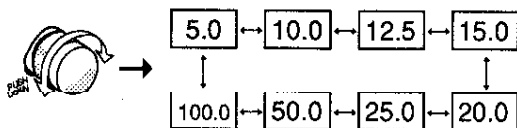

7. To return to VFO mode, press the **[FNC]** key and then **[CAL/STEP]** key.

On the CMP843A Microphone:

1. Select the band with the **[D/BAND]** key.



2. Verify VFO mode. (P 18)

3. Press the **[0/FUNC]** key.



4. Press the **[REV/STEP]** key.



5. Check the display for the frequency step indication.

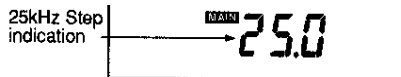

6. Press the **[2/DOWN]** or **[3/UP]** key to display the desired frequency step.

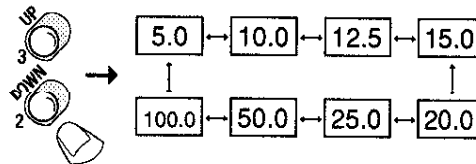

7. To return to VFO mode, press the **[0/FUNC]** key and then the **[REV/STEP]** key.

CHANGING THE FREQUENCY STEP TO 1 MHz

The frequency step can be changed to 1 MHz.

On the CRC5700A Control Head:

1. Verify VFO mode. (P 18)

2. Press the **[FNC]** key.



3. Turn the main dial and check that the frequency changes by 1 MHz.



On the CMP843A Microphone:

1. Verify VFO mode. (P 18)

2. Press the **[0/FUNC]** key.



3. Press the **[2/DOWN]** or **[3/UP]** key and check that the frequency changes by 1 MHz.

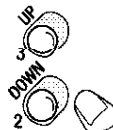

DISABLING 1 MHz FREQUENCY STEP

Disabling the 1 MHz frequency step condition allows other steps to be set: 5, 10, 12.5, 15, 20, 25, 50, and 100 kHz. After disabling the 1 MHz step, the initial setting will be a 25 kHz step, which can be changed.

On the CRC5700A Control Head:

1. Verify VFO mode. (P 18)

2. Hold down the **[FNC]** key and press the **[V.M/ENT]** key.



3. Turn the main dial to display Set Mode 12.

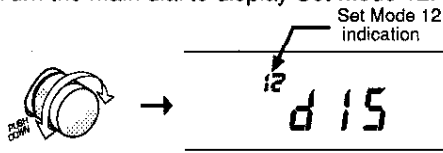

4. Press the **[V.M/ENT]** key and note that "EnA" on the display changes to "dIS".

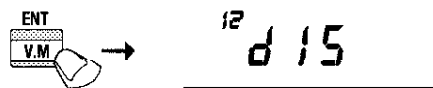

5. Hold down the **[FNC]** key and press the **[V.M/ENT]** key.

6. Verify VFO mode. (P 18)

On the CMP843A Microphone:

1. Check VFO mode. (P 18)

2. Press the **[SET]** key.



3. Press the **[2/DOWN]** or **[3/UP]** key to display Set Mode 12.

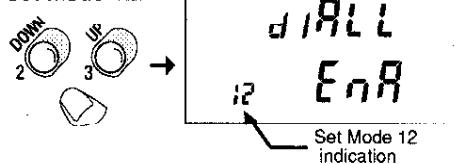

4. Press the **[#/V-M]** key and note that "EnA" on the display changes to "dIS".

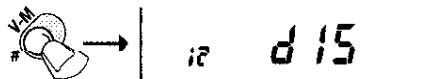

5. Press the **[SET]** key.

6. Verify VFO mode. (P 18)

INPUTTING A FREQUENCY DIRECTLY

The frequency can be input directly from the CMP843A Microphone. This operation is called "direct input".

To Input by 100 MHz

1. Select the band with the **D/BAND** key.

2. Verify VFO mode. (P 18)

3. Press the ***/ENT.DIRECT** key.



4. Press the key of the number to be input.

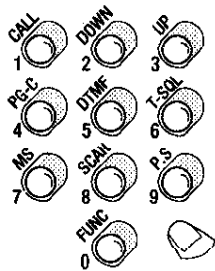

 ◆ To cancel "input from 100 MHz", change the display indication from "EnA" to "dIS" in step 5.

◆ Press the keys only momentarily when performing direct input.

To Input by 1 MHz

1. Select the band with the **D/BAND** key.

2. Verify VFO mode. (P 18)

3. Press the **SET** key.



4. Press the **2/DOWN** or **3/UP** key to display Set Mode 07.

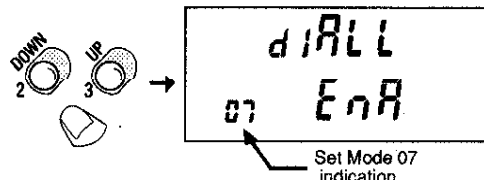

5. Press the **#/V-M** key to change the display indication from "EnA" to "dIS"

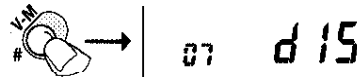

6. Press the **SET** key.

7. Verify VFO mode. (P 18)

8. Press the ***/ENT.DIRECT** key.

9. Press the key of the number to be input.

ACCESSING THE CALLING FREQUENCY

An often-used calling frequency may be stored in the radio's memory for immediate access. When shipped from the factory the calling frequency is set to 146.00 MHz for the 144 MHz band and 446.00 MHz for the 450 MHz band. The calling frequency can be easily retrieved from memory.

On the CRC5700A Control Head:

1. Select the band with the **144** or **450** key.



2. Verify VFO mode. (**P** 18)

3. Press the **CAL/STEP** key.



4. Check the display for a "C" above for the calling frequency.

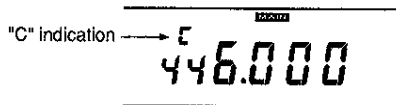

5. To return to VFO mode, press the **CAL/STEP** key.

On the CMP843A Microphone:

1. Select the band with the **D/BAND** key.



2. Verify VFO mode. (**P** 18)

3. Press the **1/CALL** key.



4. Check the display for a "C" to the left of the calling frequency.

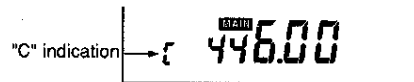

5. To return to VFO mode, press the **1/CALL** key.



- ◆ If the main dial is turned or the **UP** or **DOWN** key on the microphone is pressed when the calling frequency is displayed, the frequency increases or decreases. However, the original calling frequency is still in memory and can be recalled again.

CHANGING THE CALLING FREQUENCY

The calling frequency can be easily changed.

On the CRC5700A Control Head:

1. Select the band with the **144** or **450** key.

2. Verify VFO mode. (P 18)

3. Press the **CAL/STEP** key. 

4. Check the display for a "C" above the calling frequency.

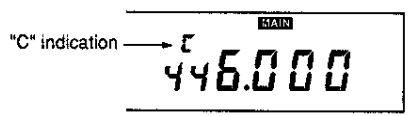

5. Press the **FNC** key. 

6. Press the **V.M/ENT** key. 

7. Turn the main dial and set a new calling frequency. ("C" indication blinks.)

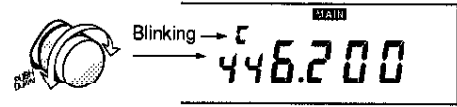

8. Press the **FNC** key. 

9. Check that "C" indication is lit when the **V.M/ENT** key is pressed. 

10. Press the **CAL/STEP** key.

11. Verify VFO mode. (P 18)

On the CMP843A Microphone:

1. Select the band with the **D/BAND** key.

2. Verify VFO mode. (P 18)

3. Press the **1/CALL** key. 

4. Check the display for a "C" next to the calling frequency.

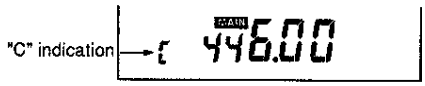

5. Press the ***/ENT.DIRECT** key. 

6. Press the key(s) on the keypad to directly input the new calling frequency. (Rewriting automatically completes when the last digit is input.)

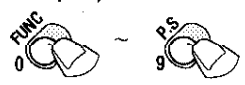

7. Press the **1/CALL** key.

8. Verify VFO mode. (P 18)

Storing Associated Data with the Calling Frequency

Various settings can be stored with the call frequency. These include tones for repeater, paging, code squelch and tone squelch.

On the CRC5700A Control Head:

1. Select the band with the **144** or **450** key.

2. Verify VFO mode. (**D** 18)

3. Press the **CAL/STEP** key.



4. Check the display for a "C" above the calling frequency.

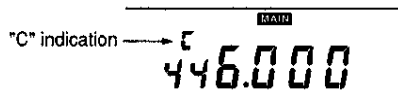

5. Press the appropriate button to associate its function with the frequency at this memory location: **TSQ**, **RPT**, **PG.C**.



6. Press the **CAL/STEP** key.

7. Verify VFO mode. (**D** 18)

On the CMP843A Microphone:

1. Select the band with the **144** or **450** key.

2. Verify VFO mode. (**D** 18)

3. Press the **1/CALL** key.



4. Check the display for the "C" indication for the call frequency.



5. Press the appropriate key to associate its function with the frequency at this memory location: **TSQ**, **RPT**, **PG.C**.



6. Press the **1/CALL** key.

7. Verify VFO mode. (**D** 18)

USING THE KEY LOCK

Key operation can be disabled. This will prevent mistakes in key pressing that could change operation. This operation is called "key lock".

On the CRC5700A Control Head:

1. Select the band for enabling key lock with the **144** or **450** key.

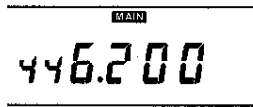

2. Simultaneously press the **FNC** and **PG.C/DT** keys

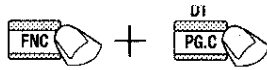

3. Check the display for the key symbol.

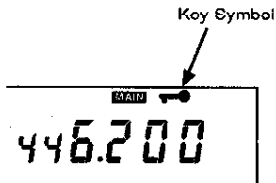

4. To cancel this operation, repeat step 2.



◆ The key lock can be set independently for each band, using the control head.

On the CMP843A Microphone:

1. To enable key lock, slide the **K-LOCK** switch ON.

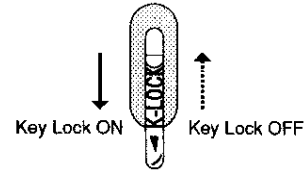

2. Check the display for the key symbol.

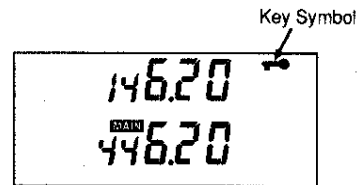

3. To cancel key lock, slide the **K-LOCK** switch OFF.

On the CMP842 Remote Controller/Microphone

1. To enable key lock, slide the **K-LOCK** switch ON.

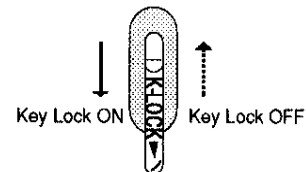

2. To cancel key lock, slide the **K-LOCK** switch OFF.

USING THE MAIN DIAL KNOB WHILE IN KEY LOCK

On the CRC5700A Control Head:

1. Verify VFO mode. (P 18)

2. Simultaneously press the **FNC** and **V.M/ENT** keys

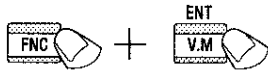

3. Turn the main dial and display Set Mode 13.

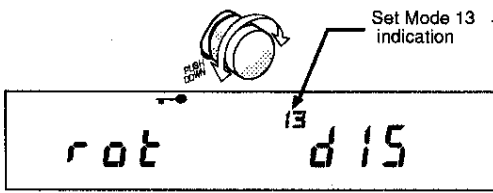

4. Press the **V.M/ENT** key and change the display indication from "dIS" to "EnA"

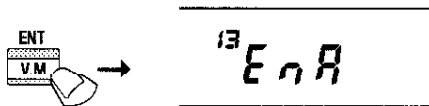

5. Repeat step 2.

6. Verify VFO mode. (P 18)

On the CMP843A Microphone:

1. Verify VFO mode. (P 18)

2. Press the **SET** key.



3. Press the **2/DOWN** or **3/UP** key to display Set Mode 13.

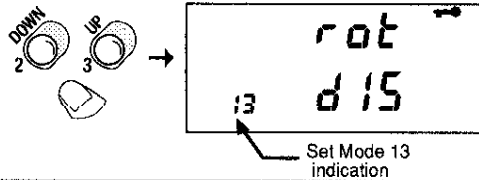

4. Press the **#/V-M** key and change the display indication from "dIS" to "EnA".

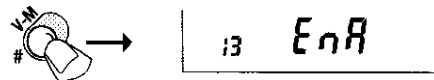

5. Press the **SET** key.

6. Verify VFO mode. (P 18)



◆ To cancel this setting, change the display indication from "EnA" to "dIS" in step 4.

TURNING OFF THE SQUELCH

When squelch is on, only signals that exceed the squelch threshold will "open" the squelch and allow audio output. Signals below this threshold will not "open" the squelch circuit and will therefore not be heard. Squelch can be turned off temporarily to check for weak signals or to see if the operating frequency is in use.

On the CMP842 Microphone:

1. Press the **SQL.OFF** key to turn squelch off.



2. To turn on the squelch again, press the **SQL.OFF** key.

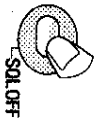

On the CMP843A Microphone:

1. Press the **SQL.OFF** key to turn squelch off.

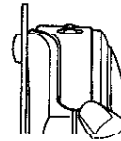

2. To turn on the squelch again, press the **SQL.OFF** key again.

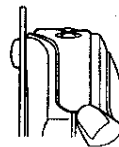

Controlling the Squelch with RF Level (Setting the RF Squelch)

There are two ways of setting the squelch threshold. The first (already described) is to set it based on noise from the speaker. The second is to set it to a point equivalent to an S-Meter indication. This second method allows much higher thresholds that can block stronger signals, and is called RF Squelch in this manual.

On the CRC5700A Control Head:

1. Verify VFO mode. (P 18)
2. Simultaneously press the **[FNC]** and **[V.M/ENT]** keys.
3. Turn the main dial to display Set Mode 17.

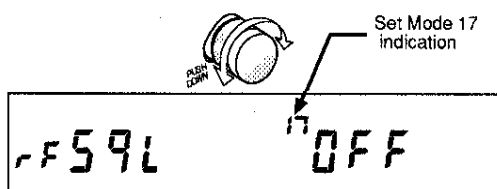

4. Press the **[V.M/ENT]** key to toggle the display indication from "OFF" to the desired value. Pressing the **[V.M/ENT]** key repeatedly will toggle the display between "OFF", "3", "5", and "FUL". The numbers 3 and 5 correspond approximately to S-3 and S-5 on an S-meter. FUL corresponds to maximum threshold level, sometimes called "tight squelch."

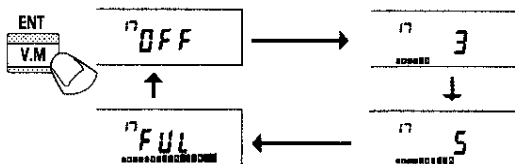

5. While pressing the **[FNC]** key, press the **[V.M/ENT]** key.
6. Verify VFO mode. (P 10)



- ◆ If an RF squelch setting has been made, scanning does not stop when a signal is received in scan mode unless the signal level is equal to or greater than the RF squelch level setting.
- ◆ To cancel RF squelch, set the display to "OFF" in step 4.
- ◆ Separate squelch settings can be made on the VHF and UHF bands. On the band(s) selected, turn the squelch control knob(s) fully clockwise.

On the CMP843A Microphone:

1. Verify VFO mode. (P 18)
2. Press the **[SET]** key.
3. Press the **[2/DOWN]** or **[3/UP]** key to display Set Mode 17.

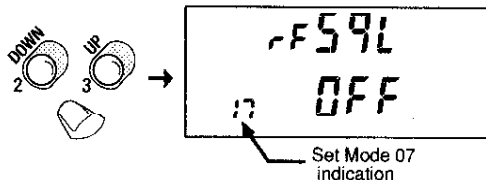

4. Press the **[#/V-M]** key and toggle the display indication from "OFF" to the desired value. Pressing the **[#/V-M]** key repeatedly will toggle the display between "OFF", "3", "5", and "FUL". The numbers 3 and 5 correspond approximately to S-3 and S-5 on an S-meter. FUL corresponds to maximum threshold level, sometimes called "tight squelch."

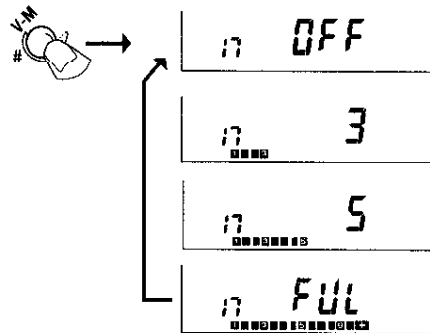

5. Press the **[SET]** key.
6. Verify VFO mode. (P 18)
Separate squelch settings can be made on the VHF and UHF bands.

CHANGING THE TRANSMIT POWER

Transmit power can be set to one of three levels.

In the C5718DA, transmit power can be changed to 50/40W (high power), 10W (medium power) or 3W (low power). The initial setting (as shipped from the factory) is high power.

On the CRC5700A Control Head:

1. Select the band with the **[144]** or **[450]** key.
2. Verify VFO mode. (**[D]** 18)
3. Press the **[FNC]** key.
4. Press the **[MS/PO]** key.
5. Check the display for an "M" indication.
(Medium power is set.)

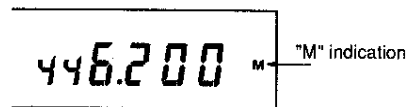

6. Press the **[MS/PO]** key.
7. Check the display to verify that the indication changes from "M" to "L". (Low power is set.)
8. Press the **[MS/PO]** key.
9. Check that the "L" indication disappears from the display. (High power is set.)

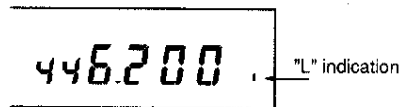

On the CMP843A Microphone:

1. Select the band with the **[D/BAND]** key.
2. Verify VFO mode. (**[D]** 18)
3. Press the **[C/PO]** key.
4. Check the display for an "M" indication.
(Medium power is set.)



5. Press the **[C/PO]** key.
6. Check the display to verify that the indication changes from "M" to "L". (Low power is set.)
7. Press the **[MS/PO]** key.
8. Check that the "L" indication disappears from the display. (High power is set.)



- The display for transmitting with high power:
- The display for transmitting with medium power:
- The display for transmitting with low power:



◆ On the control head, change transmit power using the function mode.

MEMORY FUNCTIONS

ABOUT MEMORY	42
STORING OFTEN-USED FREQUENCIES IN MEMORY	42
RECALLING A FREQUENCY FROM MEMORY	43
ERASING DATA AT A SPECIFIC MEMORY ADDRESS.....	43
CHANGING AN OPERATING FREQUENCY IN MEMORY.....	43
ASSIGNING PRIORITY TO MEMORY ADDRESSES	44
ASSIGNING TONE SQUELCH MODE TO A FREQUENCY IN MEMORY.....	44
ASSIGNING TONE ENCODE MODE TO A FREQUENCY IN MEMORY.....	45
CHANGING THE REPEATER TONE FREQUENCY STORED IN MEMORY	45
ASSIGNING PAGING MODE TO A FREQUENCY IN MEMORY	46
ASSIGNING CODE SQUELCH MODE TO A FREQUENCY MEMORY.....	46
ASSIGNING REPEATER MODE TO A FREQUENCY IN MEMORY.....	47
ASSIGNING THE SCAN METHOD TO A FREQUENCY MEMORY.....	47
CHANGING THE REPEATER SHIFT FREQUENCY IN MEMORY.....	48
INHIBITING MEMORY MODIFICATION	48

ABOUT MEMORY

The transceiver has 20 channels of memory for each band (with the supplied CMU181 memory unit). Therefore, 40 frequencies can be stored. In addition, operating functions can be associated with each stored frequency, such as repeater mode, paging mode, tone frequencies, offset frequency, and scan method. For scanning, memory address can be prioritized.

Memory can be protected against accidental erasure or change.

By replacing the CMU181 with the optional CMU182 memory unit, 100 channels for each band can be stored. The following items can be stored in memory and associated with the operating frequency at that memory address:

- ◇ Tone squelch mode
- ◇ Paging mode
- ◇ Repeater mode
- ◇ Tone encode mode
- ◇ Code squelch mode
- ◇ Scan method (Pause/Busy/Hold)



- ◆ For the tone frequency and the shift frequency, different frequencies can be written at each memory address.
- ◆ Even on the VHF side, frequencies in the 450 MHz band can be written by using V-V,U-U operation. Even on the UHF side, frequencies in the 144 MHz band can be written by using V-V,U-U operation (P 60).

STORING OFTEN-USED FREQUENCIES IN MEMORY

Frequencies which are used often can be stored in memory.

On the Control Head:

1. Select the band with the [144] or [450] key.
2. Verify VFO mode. (P 18)
3. Turn the main dial to display a frequency to be stored in memory.
4. Press the [V.M/ENT] key.
5. Turn the main dial to select a memory address with a blinking "M" (this indicates an available memory address).

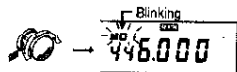

6. Press the [FNC] key.
7. Press the [V.M/ENT] key twice.

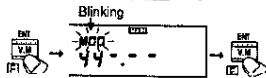

8. Check the display for an unblinking "M" indication. (The frequency has been placed in memory.)
9. Press the [V.M/ENT] key.
10. Verify VFO mode. (P 18)

On the CMP843A Microphone:

1. Select the band with the [D/BAND] key.



2. Verify VFO mode. (P 18)

3. Press the [2/DOWN] or [3/UP] key to display a frequency to be stored in memory.

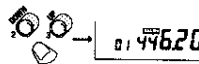

4. Press the [#V-M] key.

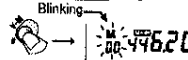

5. Press the [2/DOWN] or [3/UP] key to select a memory address with a blinking "M" (this indicates an available memory address). indication blinks.

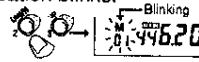

- ◆ A blinking "M" means that nothing is stored at this memory address, and that it is available for use.

6. Press the [*/ENT.DIRECT] key twice.

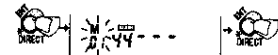

7. Check the display for an unblinking "M" indication. (The frequency has been placed in memory)

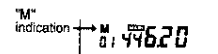

8. Press the [#V-M] key.



9. Verify VFO mode. (P 18)

RECALLING A FREQUENCY FROM MEMORY

A frequency in memory can be recalled after selecting its memory address.

On the Control Head:

1. Select the band with the [144] or [450] key.
2. Verify VFO mode. (P 18)
3. Press the [V.M/ENT] key.
4. Turn the main dial to select the memory address to be recalled. The frequency stored at this address will be displayed and is immediately available for use.
5. Press the [V.M/ENT] key to return to VFO mode.

On the CMP843A Microphone:

1. Select the band with the [D/BAND] key.
2. Verify VFO mode. (P 18)
3. Press the [#V-M] key.
4. Press the [2/DOWN] or [3/UP] key to select the memory address to be recalled. The frequency stored at this address will be displayed and is immediately available for use.
5. Press the [#V-M] key to return to VFO mode.

ERASING DATA AT A SPECIFIC MEMORY ADDRESS

Contents of memory at a specific address can be erased.

On the Control Head:

1. Select the band with the [144] or [450] key.
2. Verify VFO mode. (P 18)
3. Press the [V.M/ENT] key.
4. Turn the main dial to select a memory address. The frequency at that address will be displayed.
5. Press the [FNC] key.
6. Press the [V.M/ENT] key.
7. Check the display to verify that the memory address is empty (the "M" will be blinking).
8. Press the [PTT] on the microphone.
9. Press the [V.M/ENT] key.
10. Verify VFO mode. (P 18)

On the CMP843A Microphone:

1. Select the band with the [D/BAND] key.
2. Verify VFO mode. (P 18)
3. Press the [#V-M] key.
4. Press the [2/DOWN] or [3/UP] key to select the memory address to be erased.
5. Press the [*/ENT.DIRECT] key.
6. Check the display to verify that the memory address is empty (the "M" will be blinking).
7. Press the [PTT] on the microphone.
8. Press the [#V-M] key.
9. Verify VFO mode. (P 18)

CHANGING AN OPERATING FREQUENCY IN MEMORY

An operating frequency stored in memory can be changed.

On the Control Head:

1. Select the band with the [144] or [450] key.
2. Verify VFO mode. (P 18)
3. Press the [V.M/ENT] key.
4. Turn the main dial to select a memory address. The frequency at that address will be displayed.
5. Press the [FNC] key.
6. Press the [V.M/ENT] key.
7. Check that the display still shows the frequency to be changed.
8. Turn the main dial to select the new frequency.
9. Press the [FNC] key.
10. Press the [V.M/ENT] key. Check the display for an unblinking "M" indication. (The new frequency has been stored in memory.)
11. Press the [#V-M] key.
12. Verify VFO mode. (P 18)

On the CMP843A Microphone:

1. Select the band with the [D/BAND] key.
2. Verify VFO mode. (P 18)
3. Press the [#V-M] key.
4. Press the [2/DOWN] or [3/UP] key to select a memory address. The frequency at that address will be displayed.
5. Press the [*/ENT.DIRECT] key.
6. Check the display for the memory change (the "M" will blink).
7. Input the new frequency through the numerical keypad.
8. A beep sounds when the last digit is input. (This stores the frequency to memory.)
9. Press the [#V-M] key.
10. Verify VFO mode. (P 18)

◆ In step 7, the up/down functions of the [2/DOWN]/[3/UP] KEYS are disabled. Only the number functions are enabled.





ASSIGNING PRIORITY TO MEMORY ADDRESSES

You can assign priorities to memory addresses for use during memory scan.

On the Control Head:

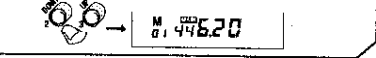
1. Select the band with the **[144]** or **[450]** key.
2. Verify VFO mode. (**D** 18)
3. Press the **[V.M/ENT]** key.
4. Turn the main dial to select a memory address. The frequency at that address will be displayed.
5. Press the **[FNC]** key.
6. Turn the main dial to select a priority number. Press the **[FNC]** key.
7. Press the **[V.M/ENT]** key. Verify VFO mode. (**D** 18)

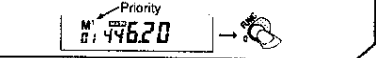
On the CMP843A Microphone:

1. Select the band with the **[D/BAND]** key.
2. Verify VFO mode. (**D** 18)
3. Press the **[/V-M]** key.
4. Press the **[2/DOWN]** or **[3/UP]** key to select the memory address to be assigned a priority.
 

5. Press the **[0/FUNC]** key.
 
6. Press the **[2/DOWN]** or **[3/UP]** key to select a priority number. Press the **[0/FUNC]** key.
 

7. Press the **[/V-M]** key. Verify VFO mode. (**D** 18)
 

- ◆ The priority number changes as the main dial is turned or the **[2/DOWN]** key / **[3/UP]** key is pressed. The order is as follows:
Blank ↔ 1 ↔ 2
- ◆ If priority is set to 1, scan is enabled at scan 1 priority and scan 2 priority.
- ◆ If priority is set to 2, scan is enabled at scan 2 priority.
- ◆ If priority is set to blank, all memory address will be scanned in numerical order.

ASSIGNING TONE SQUELCH MODE TO A FREQUENCY IN MEMORY









Frequencies in memory can be designated for use with tone squelch (TSQ).

At the same time, a default squelch tone is associated with that frequency (this tone can be changed).

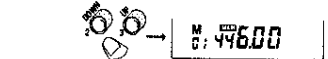
On the Control Head:

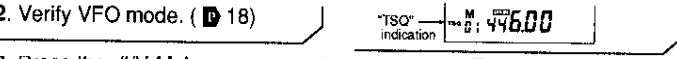
1. Select the band with the **[144]** or **[450]** key.
2. Verify VFO mode. (**D** 18)
3. Press the **[V.M/ENT]** key.
4. Turn the main dial to select the memory address. The frequency stored at that address will be displayed.
5. Press the **[FNC]** key.
6. Press the **[SCN/TSQ]** key twice (rapidly).
7. Check the display for the "TSQ" (tone squelch) indication.
8. Press the **[FNC]** key to engage the FNC mode.
9. Press the **[V.M/ENT]** key twice and then wait for the **[FNC]** mode to disengage (about 3 seconds).
10. Press the **[V.M/ENT]** key.
11. Verify VFO mode. (**D** 18)

On the CMP843A Microphone:

1. Select the band with the **[D/BAND]** key.
2. Verify VFO mode. (**D** 18)
3. Press the **[/V-M]** key.
 
4. Press the **[2/DOWN]** or **[3/UP]** key to select a memory address.
 

5. Press the **[6/T-SQL]** key twice (rapidly).
 
6. Check the display for the "TSQ" (tone squelch) indication.
 

7. Press the **[*/ENT.DIRECT]** key twice.
 

8. Press the **[/V-M]** key.
 
9. Verify VFO mode. (**D** 18)

- ◆ The squelch tone written at this time is a default frequency that can be changed. When tone squelch is used, squelch will open when a signal containing the same squelch tone is received.

ASSIGNING TONE ENCODE MODE TO A FREQUENCY IN MEMORY

Tone encode mode is used for repeater access when the transceiver is operated as a repeater. Frequencies in memory can be designated for use with tone encode mode. At the same time, a default tone is associated with that frequency (this tone can be changed).

On the Control Head:

1. Select the band with the [144] or [450] key.
2. Verify VFO mode. (P 18)
3. Press the [V.M/ENT] key.
4. Turn the main dial to select a memory address. The frequency at that address will be displayed.
5. Press the [FNC] key.
6. Press the [SCN/TSQ] key.
7. Check the display for a "T" indication.
8. If the FNC mode is cancelled, press [FNC] key.
9. Press the [V.M/ENT] key twice.
10. Press the [V.M/ENT] key.
11. Verify VFO mode. (P 18)

On the CMP843A Microphone:

1. Select the band with the [D/BAND] key.
2. Verify VFO mode. (P 18)
3. Press the [#V-M] key.
4. Press the [2/DOWN] or [3/UP] key to select a memory address. The frequency at that address will be displayed.
5. Press the [6/T-SQL] key.
6. Check the display for the "T" indication.
7. Press the [* /ENT DIRECT] key twice.
8. Press the [#V-M] key.
9. Verify VFO mode. (P 18)

T indication
M 0: 446.20

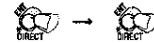

CHANGING THE REPEATER TONE FREQUENCY STORED IN MEMORY

The tone frequency used for repeater access can be changed in memory.

On the Control Head:

1. Select the band with the [144] or [450] key.
2. Verify VFO mode. (P 18)
3. Press the [V.M/ENT] key.
4. Turn the main dial to select a memory address. The frequency at that address will be displayed.
5. Press the [FNC] key.
6. Press the [SCN/TSQ] key until the tone frequency is displayed.
7. Turn the main dial to change the tone frequency.
8. Press the [SCN/TSQ] key until the memory address is displayed.
9. Press the [V.M/ENT] key.
10. Verify VFO mode. (P 18)

On the CMP843A Microphone:

1. Select the band with the [D/BAND] key.
2. Verify VFO mode. (P 18)
3. Press the [#V-M] key.
4. Press the [2/DOWN] or [3/UP] key to select a memory address. The frequency stored at that address will be displayed.
5. Press and hold the [6/T-SQL] key until the tone frequency is displayed.
6. Press the [2/DOWN] or [3/UP] key and change the tone frequency.
7. Press and hold the [6/T-SQL] key until the memory address and the frequency stored at that address are displayed.
8. Press the [#V-M] key.
9. Verify VFO mode. (P 18)

M 0: 770

M 0: 446.20

M 0: 885





ASSIGNING PAGING MODE TO A FREQUENCY IN MEMORY

A frequency in memory can be designated as a paging code.

On the Control Head:

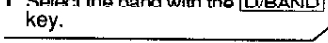
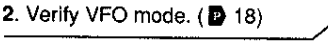
1. Select the band with the **[144]** or **[450]** key.
2. Verify VFO mode. (**D** 18)
3. Press the **[V.M/ENT]** key.
4. Turn the main dial to select a memory address. The frequency at that address will be displayed.
5. Press the **[PG-C/DT]** key.
6. Check the display for the "PAG" indication.
7. Press the **[FNC]** key.
8. Press the **[V.M/ENT]** key twice.
9. Press the **[V.M/ENT]** key.
10. Verify VFO mode. (**D** 18)

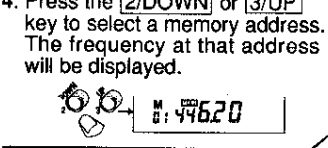
On the CMP843A Microphone:

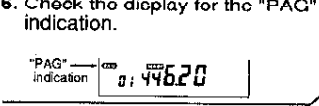
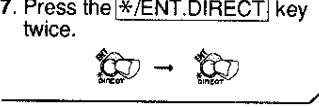
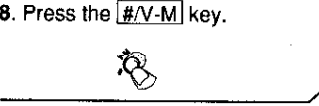
1. Select the band with the **[D/BAND]** key.

2. Verify VFO mode. (**D** 18)

3. Press the **[#/V-M]** key.

4. Press the **[2/DOWN]** or **[3/UP]** key to select a memory address. The frequency at that address will be displayed.

446.20
5. Press the **[4/PG-C]** key.

6. Check the display for the "PAG" indication.

"PAG" indication # 446.20
7. Press the **[*/ENT.DIRECT]** key twice.

DIRECT → DIRECT
8. Press the **[#/V-M]** key.

9. Verify VFO mode. (**D** 18)

ASSIGNING THE CODE SQUELCH MODE TO A FREQUENCY IN MEMORY

The code squelch mode can be assigned to a frequency stored at a specific memory address.

On the Control Head:

1. Select the band with the **[144]** or **[450]** key.
2. Verify VFO mode. (**D** 18)
3. Press the **[V.M/ENT]** key.
4. Turn the main dial to select a memory address. The frequency at that address will be displayed.
5. Press the **[PG-C/DT]** key twice.
6. Check the display for the "CSQ" indication.
7. Press the **[FNC]** key.
8. Press the **[V.M/ENT]** key twice.
9. Press the **[V.M/ENT]** key.
10. Verify VFO mode. (**D** 18)

On the CMP843A Microphone:

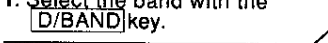
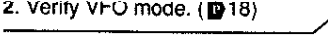
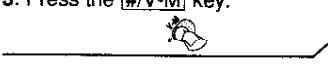
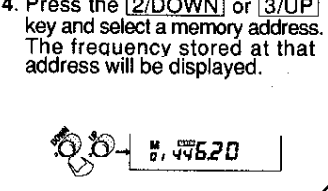
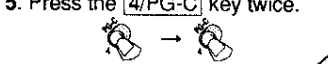
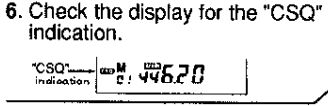
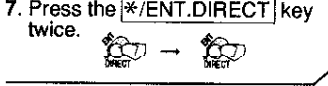
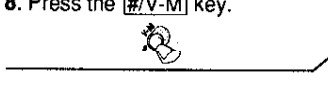
1. Select the band with the **[D/BAND]** key.

2. Verify VFO mode. (**D** 18)

3. Press the **[#/V-M]** key.

4. Press the **[2/DOWN]** or **[3/UP]** key and select a memory address. The frequency stored at that address will be displayed.

446.20
5. Press the **[4/PG-C]** key twice.

→
6. Check the display for the "CSQ" indication.

"CSQ" indication # 446.20
7. Press the **[*/ENT.DIRECT]** key twice.

DIRECT → DIRECT
8. Press the **[#/V-M]** key.

9. Verify VFO mode. (**D** 18)

 ◆ The DTMF mode cannot be written to a memory address.

ASSIGNING REPEATER MODE TO A FREQUENCY IN MEMORY

The repeater mode can be assigned to a frequency stored at a specific memory address. Then when that memory is recalled, its stored frequency will be recognized as a repeater frequency.

On the Control Head:

1. Select the band with the [144] or [450] key.
2. Verify VFO mode. (D 18)
3. Press the [V.M/ENT] key.
4. Turn the main dial to select a memory address. The frequency at that address will be displayed.
5. Press the [FNC] key.
6. Press the [REV/RPT] key.
7. Check the display for the "T-" indication.
8. Press the FNC key.
9. Press the [V.M/ENT] key twice.
10. Press the V.M/ENT key.
11. Verify VFO mode. (D 18)

On the CMP843A Microphone:

1. Select the band with the [D/BAND] key.
 2. Verify VFO mode. (D 18)
 3. Press the [#V-M] key.
 4. Press the [2/DOWN] or [3/UP] key to select a memory address. The frequency stored at that address will be displayed.
 5. Press the [RPT/SFT] key.
 6. Check the display for the "T-" indication.
 7. Press the [*/ENT.DIRECT] key twice.
 8. Press the [#V-M] key.
 9. Verify VFO mode. (D 18)
- ◆ Use the specified frequency for the repeater according to the transmission type allowed for amateur operation.

ASSIGNING THE SCAN METHOD TO A FREQUENCY IN MEMORY

The scan method (pause, busy, or hold) can be assigned to a frequency stored at a specific memory address. This method will then be in effect at this memory address during scan.

On the Control Head:

1. Select the band with the [144] or [450] key.
2. Verify VFO mode. (D 18)
3. Press the [V.M/ENT] key.
4. Turn the main dial to select a memory address. The frequency at that address will be displayed.
5. Press the [FNC] key.
6. Turn the main dial knob.
7. Check the display for the "B" indication.
8. If the FNC mode is not in effect, press [FNC] key.
9. Press the [V.M/ENT] key twice.
10. Press the [V.M/ENT] key.
11. Verify VFO mode. (D 18)

On the CMP843A Microphone:

1. Select the band with the [D/BAND] key.
2. Verify VFO mode. (D 18)
3. Press the [#V-M] key.
4. Press the [2/DOWN] or [3/UP] key to select a memory address. The frequency stored at that address will be displayed.
5. Press the [FUNC] key.
6. Press the [V-V,U-U] key.
7. Check the display for the "B" indication.
8. Press the [FUNC] key to cancel the FNC mode.
9. Press the [*/ENT.DIRECT] key twice.
10. Press the [#V-M] key.
11. Verify VFO mode. (D 18)

- ◆ If the main dial knob is pushed again in FNC mode when the "B" indication is displayed, the "B" indication disappears and the "H" indication appears.
- Blank : Pause
 "B" : Busy
 "H" : Hold

CHANGING THE REPEATER SHIFT FREQUENCY IN MEMORY

The repeater shift frequency stored in memory in can be changed.

On the Control Head:

1. Select the band with **[144]** or **[450]** key
2. Verify VFO mode. (**D** 18)
3. Press the **[V.M/ENT]** key while pressing the **[FNC]** key.
4. Turn the main dial to select a memory address. The frequency at that address will be displayed.
5. Press the **[CAL/STEP]** key while pressing the **[FNC]** key.
6. Turn the main dial knob to display the new frequency.
7. Press the **[CAL/STEP]** key while pressing the **[FNC]** key.
8. Press the **[V.M/ENT]** key.
9. Verify VFO mode. (**D** 18)

On the CMP843A Microphone:

1. Select the band with the **[D/BAND]** key.
2. Verify VFO mode. (**D** 18)
3. Press the **[#/V-M]** key.
4. Press the **[2/DOWN]** or **[3/UP]** key to select a memory address. The frequency at that address will be displayed.
5. Hold down the **[RPT/SFT]** key until the shift frequency is displayed.
6. Check the display for the shift frequency.

7. Press the **[2/DOWN]** or **[3/UP]** key to change the frequency to be memorized.

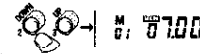

8. Hold down the **[RPT/SFT]** key until the memory address is displayed.



9. Press the **[#/V-M]** key.



10. Verify VFO mode. (**D** 18)

- ◆ In steps 5 and 8 for the CMP843A Microphone, press the **[RPT/SFT]** key for at least 0.5 second.
- ◆ In step 7 for the CMP843A Microphone, direct input through the numerical keypad is possible after pressing the **[*/ENT.DIRECT]** key.

INHIBITING MEMORY MODIFICATION

This function protects data in the memory from being changed or erased by mistake.

On the Control Head:

1. Verify VFO mode. (**D** 18)
2. Press the **[V.M/ENT]** key while pressing the **[FNC]** key.
3. Turn the main dial and display Set Mode 16. (**D** 64-65)
4. Press the **[V.M/ENT]** key to change the display from "OFF" to "on".
5. Press the **[V.M/ENT]** key while pressing the **[FNC]** key. Verify VFO mode. (**D** 18)

On the CMP843A Microphone:

1. Verify VFO mode. (**D** 18)
 2. Press the **[SET]** key.
 3. Press the **[2/DOWN]** or **[3/UP]** key and display Set Mode 16.
 4. Press the **[#/V-M]** key to change the display from "OFF" to "on".
 5. Press the **[SET]** key.
- Verify VFO mode. (**D** 18)

ATTENTION:

- ◆ even with memory protect set, memory contents will be erased by memory reset operations (**D** 62).

SCANNING

ABOUT SCANNING	50
PREPARING FOR SCAN	51
SCANNING WITHIN ± 1 MHz (1 MHz SCAN)	52
SCANNING THE ENTIRE BANDWIDTH (ALL-SCAN)	52
SCANNING A SPECIFIED RANGE (PROGRAM SCAN)	52
SCANNING FREQUENCIES IN MEMORY (MEMORY SCAN)	53
SCANNING PRIORITIZED MEMORY (PRIORITY SCAN)	53
SCANNING THE MEMORY BY BLOCK (BLOCK MEMORY SCAN)	53
SCANNING IN TONE SQUELCH MODE (TONE SQUELCH SCAN)	54
CHANGING THE SCANNING SPEED	54
SELECTING THE SCANNING METHOD	54
CHANGING THE HOLD TIME FOR BUSY SCAN	54

ABOUT SCANNING

The transceiver has six scanning functions and, within these functions, three scanning methods.

- ◇ **1 MHz Scan**
Scans without going beyond ± 1 MHz of the operating frequency.
- ◇ **All-Scan**
Scans the entire bandwidth.
- ◇ **Program Scan**
Scans a specified range.
- ◇ **Memory Scan**
Scans all frequencies in memory.
- ◇ **Block Memory Scan**
Scans the memory by block. A block consists of 10 memory addresses.
- ◇ **Priority Scan**
Scans the memory based on previously set priorities.

The three scanning methods are:

- ◇ **Pause Scan**
Scan stops when a signal is received, resumes in about 5 seconds even if a signal is still being received.
- ◇ **Busy Scan**
Scan stops while a signal is being received, and resumes about 1.5 seconds after the signal ends.
Scan operation halts when a signal is being received. Scan resumes when the duration specified in the set mode (2, 3, 4, or 5 seconds) has elapsed since the signal is lost.
- ◇ **Hold Scan**
If this scan is received even one time, the scan will remain stopped.



When scanning in the tone squelch mode, scan speed will slow down to decode a received signal's tone code. Scan will stop when the tone frequencies match, and the squelch will open.

PREPARING FOR SCAN

On the CRC5700A Control Head:

1. Turn SQL knob to the position where noise disappears.

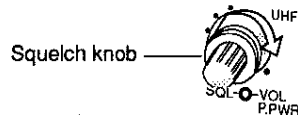

On the CMP843A Microphone:

1. Press the **AVO-SQ** key.



2. Check the display for blinking of the "SQ" indication. When the "V" indication is displayed, press **AVO-SQ** key again.



3. Press the **3/UP** key until noise disappears.

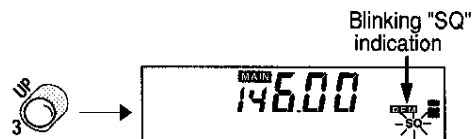

- ◆ Scan will not start while squelch is open (noise is heard) or a signal is being received. Check that SQL works and a signal is not being received.
- ◆ When **PTT** is pushed during scan, scan mode is cancelled and transmission is enabled.
- ◆ To change the scan direction, press the **2/DOWN** or **3/UP** key on the microphone, or turn the main dial to right or left.
- ◆ If the **2/DOWN** or **3/UP** key on the microphone is pressed or the main dial is turned while a signal is received and the scan stops, scan will resume at the next frequency to be scanned.
- ◆ If an RF squelch setting has been made, scanning does not stop when a signal is received in scan mode unless the signal level is equal to or greater than the RF squelch level setting.

SCANNING WITHIN ±1 MHz (1 MHz SCAN)

Scan is done without going beyond ±1 MHz of the operating frequency.

On the Control Head:

1. Select the band with the [144] or [450] key.
2. Turn the main dial to set the scan center frequency.
3. Press the [SCN/TSQ] key.
4. Verify that the display is scanning.
5. To stop scanning, press the [SCN/TSQ] key.

On the CMP843A Microphone:

1. Select the band with the [D/BAND] key.
2. Press the [2/DOWN] or [3/UP] key to set the scan center frequency.
3. Press the [0/SCAN] key.
4. Verify that the display is scanning.
5. To stop scanning, press the [8/SCAN] key.

SCANNING THE ENTIRE BANDWIDTH (ALL-SCAN)

The entire UHF or VHF bandwidth can be scanned. Memory is not scanned.

On the Control Head:

1. Select the band with the [144] or [450] key.
2. Turn the main dial to set the scan start frequency.
3. Press the [SCN/TSQ] key. This will start a 1 MHz scan.
4. Hold down the [SCN/TSQ] key while pressing the [FNC] key.
5. When a beep is heard, release each key.
6. Verify that the display is scanning.

On the CMP843A Microphone:

1. Select the band with the [D/BAND] key.
2. Press the [2/DOWN] or [3/UP] key to set the scan start frequency.
3. Press the [8/SCAN] key. This will start a 1 MHz scan.
4. Press the [0/FUNC] key.
5. Press the [8/SCAN] key.
6. When a beep is heard, check the display for all-scan. To stop scanning, press the [8/SCAN] key.

- ◆ In steps 4 for the control head, be sure to press each key for at least 0.5 second. Once All-Scan is set, it is not necessary to repeat this procedure to initiate it again. Instead, simply press the [SCN/TSQ] or [8/SCAN] key.
- ◆ To change All-Scan to 1 MHz Scan, do steps 4 and 5 during All-Scan. A low beep will be heard when the change is made.

SCANNING A SPECIFIED RANGE (PROGRAM SCAN)

Two frequencies are specified and scan is done between the two if the start frequency is lower than the stop frequency. If the start frequency is higher than the stop frequency, scanning will not be done between the two. Instead, all in-band frequencies except those between the start and stop frequencies will be scanned.

On the Control Head:

- To scan
1. Select the band with the [144] or [450] key.
 2. Press the [V.M/ENT] key. <<Memory Call Status>>
 3. Turn the main dial to the scan start frequency.
 4. Press the [SCN/TSQ] key while pressing the [FNC] key (beep).
 5. Turn the main dial to set the scan stop frequency.
 6. While holding down the [FNC] key, press the [SCAN/TSQ] key momentarily (0.5 second or less).
 7. Check the display for the "P" indication and start of scanning. To stop scanning, press the [SCN/TSQ] key twice or press [SCN/TSQ] key while pressing the [FNC] key.
- To scan again with the same range:
1. Select the band with the [144] or [450] key.
 2. Verify VFO mode. (D 18)
 3. While holding down the [FNC] key, press the [SCAN/TSQ] key momentarily (0.5 second or less).
 4. Check the display for the "P" indication and start of scanning. To stop scanning, press [SCN/TSQ] key twice or press [SCN/TSQ] key while pressing [FNC].
- To change the scan range:
1. Select the band with the [144] or [450] key.
 2. Press the [V.M/ENT] key. <<Memory Call Status>>
 3. Press the [SCN/TSQ] key while pressing the [FNC] key (low tone). <<This operation cancels program scan.>>
 4. Resume from step 3 of "To scan".

On the CMP843A Microphone:

1. Select the band with the [D/BAND] key.
2. Press the [#V-M] key. <<Memory Call Status>>
3. Press the [2/DOWN] or [3/UP] key to set the scan start frequency.
4. Press the [0/FUNC] key.
5. Press the [9/P.S] key (beep).
6. Press the [2/DOWN] or [3/UP] key to set the scan stop frequency.
7. Press the [0/FUNC] key.
8. Press the [9/P.S] key (beep).
9. Press the [9/P.S] key.
10. Check the display for the "P" indication and start of scanning. To stop scanning, press the [9/P.S] key.

To scan again with the same range.

1. Select the band with the [D/BAND] key.
 2. Press the [9/P.S] key.
 3. Check the display for the "P" indication and start of scanning. To stop scanning, press the [9/P.S] key.
- To change the scan range
1. Select the band with the [D/BAND] key.
 2. Press the [#V-M] key. <<Memory Call Status>>
 3. Press the [0/FUNC] key.
 4. Press the [9/P.S] key (low tone). <<This operation cancels program scan.>>
 5. Resume from step 3 of "To scan again with the same range".

SCANNING FREQUENCIES IN MEMORY (MEMORY SCAN)

Memory Scan scans all frequencies stored in memory. Scan method can be different at each memory address (pause, busy, hold).

On the Control Head:

1. Select the band with the [144] or [450] key.
2. Press the [MS/PO] key.
3. Verify that the display is scanning.
4. To stop scanning, press the [MS/PO] key.

On the CMP843A Microphone:

1. Select the band with the [D/BAND] key.
2. Press the [7/MS] key.
3. Verify that the display is scanning.
4. To stop scanning, press the [7/MS] key.



- ◆ The scan method operates according to the scan method stored at each memory address.
- ◆ Remember that scan will not stop on a signal whose level does not exceed the squelch threshold.

SCANNING PRIORITIZED MEMORY (PRIORITY SCAN)

Frequencies at each memory address are scanned in a sequence determined by pre assigned priorities for each address. Scan method can be different at each memory address (pause, busy, hold).

On the Control Head:

1. Select the band with the [144] or [450] key.
2. Press the [MS/PO] key until the display changes to the "Pri" indication.
3. Turn the main dial to select scan priority.
4. Hold down the [MS/PO] key to return to VFO mode. (D 18)
5. Press the [MS/PO] key again. Verify that the display is scanning. To stop scanning, press [MS/PO] key.

On the CMP843A Microphone:

1. Select the band with the [D/BAND] key.
2. Press the [7/MS] key until the display changes to the "Pri" indication.
3. Press the [2/DOWN] or [3/UP] key to select scan priority.
4. Hold down the [7/MS] key to return to VFO mode. (D 18)
5. Press the [7/MS] key again and check the display for scanning.



- ◆ When the display shows "bLo", press [MS/PO] key on the control head, or the [7/MS] key on the CMP843A Microphone.
- ◆ When [MS/PO] is pressed on the control head or [7/MS] on the CMP843A Microphone, scan mode toggles between block scan and priority scan.
- ◆ In priority scan 1, memory with priority 1 will be scanned.
- ◆ In priority scan 2, memories with priority 1 and 2 will be scanned.
- ◆ When memory without any priority (all memory scan) is done, scan starts after setting a blank on the Priority indication.

SCANNING THE MEMORY BY BLOCK (BLOCK MEMORY SCAN)

The memory is scanned by block. A block is identified by a number from 0 to 9. Each block contains 10 memory addresses. The relation between the block numbers and memory addresses is as follows:

Block Number	Memory Address	Block Number	Memory Address
0	M00-M09	5	M50-M59
1	M10-M19	6	M60-M69
2	M20-M29	7	M70-M79
3	M30-M39	8	M80-M89
4	M40-M49	9	M90-M99

On the Control Head:

1. Select the band with the [144] or [450] key.
2. Press the [MS/PO] key until the display shows the "Pri" indication.
3. The display changes to the "bLo" indication when [MS/PO] key is pressed.
4. Turn the main dial to select a block number for scanning.
5. Hold down the [MS/PO] key to return to VFO mode. (D 18) Press the [MS/PO] key again.
6. Verify that the display is scanning.

On the CMP843A Microphone:

1. Select the band with the [D/BAND] key.
2. Press the [7/MS] key until the display shows the "Pri" (priority) indication.
3. The display changes to the "bLo" (block) indication when [7/MS] key is pressed.
4. Press the [2/DOWN] or [3/UP] key to select a block to scan.
5. Hold down the [7/MS] key to return to VFO mode. (D 18) Press the [7/MS] key again.
6. Verify that the display is scanning.



- ◆ Block Scan will not work if a block is selected that has no frequencies stored in any of its memory addresses.
- ◆ Block numbers 2 - 9 can not be selected unless the optional CMU182 unit is installed.
- ◆ When scanning without specifying a block (all memory scan), use the priority scan and start the scan after setting a blank as the Priority indication.
- ◆ The block number can be set by band.





SCANNING IN TONE SQUELCH MODE (Tone Squelch Scan)

Scan is done in the tone squelch mode. Scan speed slows down when a signal is received (in order to decode the tone), and scanning stops when the tone frequencies match.

On the Control Head:

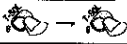
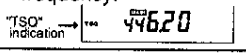
1. Select the band with the [144] or [450] key.
2. Press the [FNC] key.
3. Press the [SCN/TSQ] key twice.
4. Check the display for the "TSQ" indication and the frequency.
5. Press the [SCN/TSQ] key.
6. Verify that the display is scanning.
7. To end scanning, press [SCN/TSQ] key.

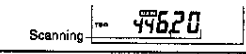
On the CMP843A Microphone:

1. Select the band with the [D/BAND] key.
2. Press the [6/T-SQL] key twice.
 
3. Check the display for the "TSQ" indication and the frequency.
 
4. Press the [8/SCAN] key.
 
5. Verify that the display is scanning.
 
6. To stop scanning, press the [8/SCAN] key.
 



CHANGING THE SCAN SPEED

Scan speed can be changed.

On the Control Head:

1. Press the [V.M/ENT] key while pressing the [FNC] key.
2. Turn the main dial and display Set Mode 01.
3. Press the [V.M/ENT] key to change the display from "Lo" to "Hi".
4. Press the [V.M/ENT] key while pressing the [FNC] key.

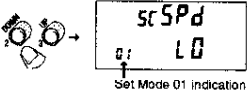
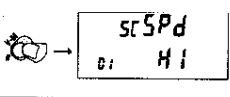
On the CMP843A Microphone:

1. Press the [SET] key.
 
2. Press the [2/DOWN] or [3/UP] key to display set mode "01".
 
3. Press the [#V-M] key to change the display from "Lo" to "Hi".
 
4. Press the [SET] key.
 

Remember that the scan will not stop on a signal that does not exceed the squelch threshold setting.

SELECTING THE SCANNING METHOD

There are three scan methods. In Pause Scan, scan stops when a signal is detected, and resumes about 5 seconds later even if the signal is still being received.

In Busy Scan, Scan operation halts when a signal is being received. Scan resumes when the duration specified in the set mode (2, 3, 4 or 5 seconds) has elapsed since the signal is lost.

In Hold Scan, Scan operation halts when a signal is received. To restart the scan, use the (rotary) up/down control.

On the Control Head:

1. Press the [V.M/ENT] key while pressing the [FNC] key.
2. If using the VHF band, turn the main dial to display set mode "02". (D64-65)
If using the UHF band, turn the main dial to display set mode "03".
3. Press the [V.M/ENT] key and set the scan method:
Every time [V.M/ENT] key is pressed, the display toggles between "PAU" (Pause), "bUS" (Busy) and "HOL" (Hold).
4. Press the [V.M/ENT] key while pressing the [FNC] key.
If Busy Scan is selected, check the display for the "B" indication.
If Hold Scan is selected, check the display for the "H" indication.

On the CMP843A Microphone:

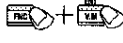
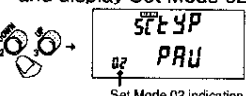
1. Press the [SET] key.
 
2. If using the VHF band, press the [2/DOWN] or [3/UP] key and display Set Mode 02.
 

Set Mode 02 indication

If using the UHF band, press the [2/DOWN] or [3/UP] key and display Set Mode 03.

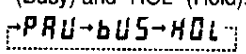

Set Mode 03 indication
3. Press the [#V-M] key and set the scan method.
Every time the [#V-M] key is pressed, the display toggles between "PAU" (Pause), "bUS" (Busy) and "HOL" (Hold).
 
4. Press the [SET] key.
If Busy Scan is selected, check the display for the "B" indication.
If Hold Scan is selected, check the display for the "H" indication.

In the initial condition (as shipped from the factory), Pause Scan is set.



CHANGING THE HOLD TIME FOR BUSY SCAN

In Hold Scan, it is possible to set a time from the end of the signal to the resumption of scan.

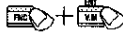
On the Control head:

1. Press the [V.M/ENT] key while pressing the [FNC] key.
 
2. Turn the main dial to select Set Mode 04.
3. Press the [V.M/ENT] key to select the hold time.
Every time the [V.M/ENT] key is pressed, the display toggles between "2", "3", "4", and "5".
"2" for about 2 seconds, "3" for about 3 seconds, "4" for about 4 seconds, and "5" for about 5 seconds.
4. Press the [V.M/ENT] key while pressing the [FNC] key.

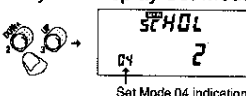
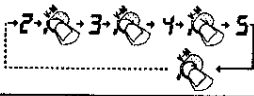
On the CMP843A Microphone:

1. Press the [SET] key.
 
2. Press the [2/DOWN] or [3/UP] key and display Set Mode 04.
 
3. Press the [#V-M] key to select the hold time.
Every time the [#V-M] key is pressed, the display toggles between "2", "3", "4", and "5".
"2" for about 2 seconds, "3" for about 3 seconds, "4" for about 4 seconds, and "5" for about 5 seconds.
 
4. Press the [SET] key.
 

In the initial condition (as shipped from the factory), hold time is set to "2".

OPERATION AS A REPEATER

GENERAL INFORMATION	56
SETTING THE REPEATER MODE.....	57
TRANSMITTING A 1750 Hz TONE BURST.....	57
SETTING THE TRANSMIT FREQUENCY HIGHER THAN THE RECEIVE FREQUENCY.....	57
REVERSING THE REPEATER TRANSMIT/RECEIVE FREQUENCIES	58
CHANGING THE REPEATER OFFSET FREQUENCY	58
CHANGING THE REPEATER TONE FREQUENCY	58

GENERAL INFORMATION

- Communicating by using a repeater station (automatic relay station) is called "repeater operation".
- Communication with a place where signals do not directly reach can be done by using the transceiver as a repeater station.
- In repeater operation, frequencies for transmission and reception are different. This difference is called the "offset frequency".
 Initial: In the 144 MHz band, the offset frequency is 600 kHz. In the 450 MHz band, the offset frequency is 5.00 MHz
- In repeater mode, CTCSS tone is automatically generated and sent when transmitting.
- The figure below shows the example where the offset frequency is set to 600 kHz in the 144 MHz band.

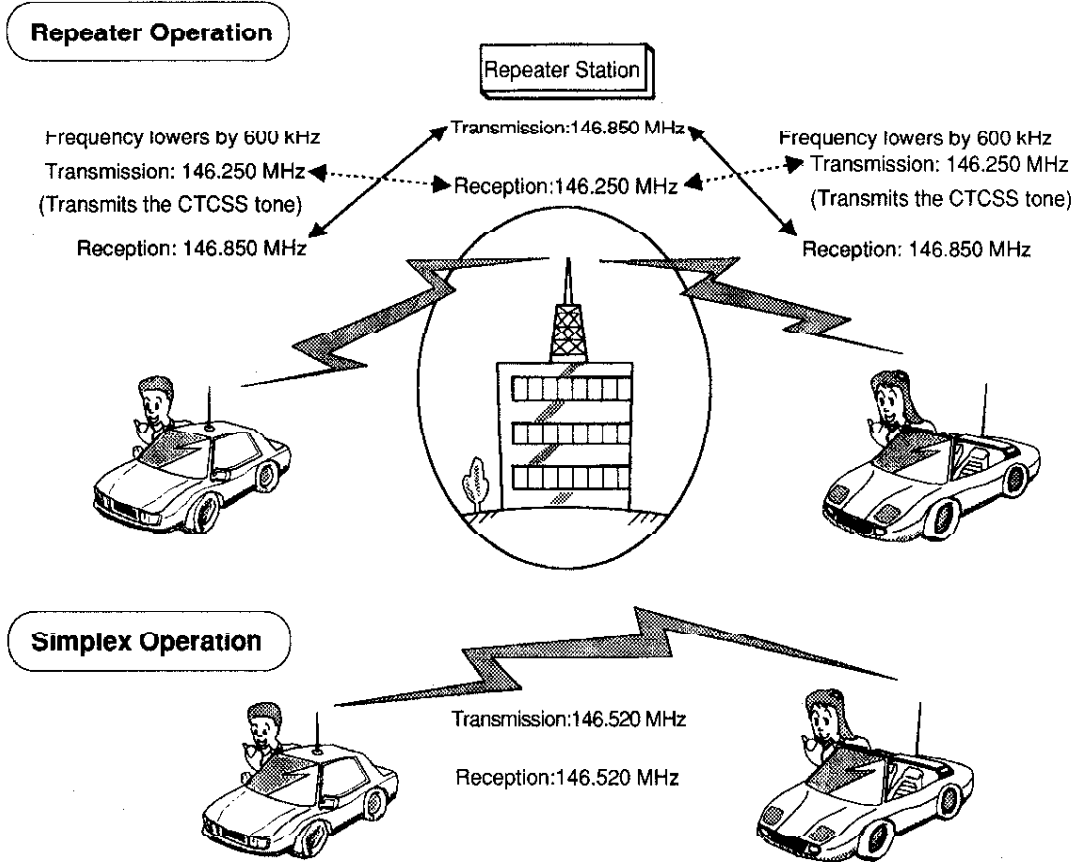





SETTING THE REPEATER MODE

The Repeater Mode can be manually set

On the Control Head:

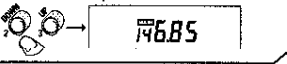
1. Press the **[144]** key.
2. Verify VFO mode. (**D** 18)
3. Turn the main dial and tune to the frequency for the repeater station.
4. Press the **[FNC]** key.
5. Press the **[REV/RPT]** key.
6. Check the display for the "T-" indication.
7. To exit the repeater mode, press **[FNC]** key and then press **[REV/RPT]** key twice.

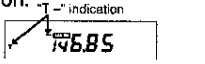
On the CMP843A Microphone:

1. Press the **[D/BAND]** key and select the 144 MHz band.
2. Verify VFO mode. (**D** 18)
3. Press the **[2/DOWN]** or **[3/UP]** key and tune to the frequency for the repeater station.

4. Press the **[RPT/SFT]** key.

5. Check the display for the "T-" indication.

6. To exit the repeater mode, press **[RPT/SFT]** key twice.



TRANSMITTING A 1750 Hz TONE BURST

On the Control Head and CMP842 Microphone:

1. Select the band with the **[144]** or **[450]** key.
2. Verify VFO mode. (**D** 18)
3. Turn the main dial to select the repeater station frequency.
4. Hold down the **[PTT]** and press the **[SQL-OFF]** key.

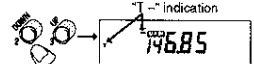

On the CMP843A Microphone

1. Select the band with the **[D/Band]** key.
2. Verify VFO mode. (**D** 18)
3. Press the **[2/DOWN]** or **[3/UP]** key to select the repeater station frequency.

4. Hold down the **[PTT]** and press the **[SQL-OFF]** key.

NOTE: The tone burst is transmitted when the **[SQL-OFF]** key is pressed during this procedure

 In step 3 for the CMP843A Microphone, direct input is possible.





SETTING THE TRANSMIT FREQUENCY HIGHER THAN THE RECEIVE FREQUENCY

Note that this does not change the receive frequency, but only shifts the transmit frequency higher or lower than the receive frequency.

On the Control Head:

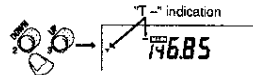
1. Press the **[144]** key.
2. Verify VFO mode. (**D** 18)
3. Turn the main dial to display the repeater station frequency.
4. Press the **[FNC]** key and then press **[REV/RPT]** key.
5. Check the display for the "+" indication.
6. To return to the default offset, press **[FNC]** key and then press the **[REV/RPT]** key twice.

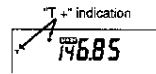
On the CMP843A Microphone:

1. Press the **[D/BAND]** key and select the 144 MHz band.
2. Verify VFO mode. (**D** 18)
3. Press the **[2/DOWN]** or **[3/UP]** key and tune to the frequency for the repeater station.

4. Press the **[RPT/SFT]** key.

5. Check the display for the "+" indication.

6. To return to the default offset, press **[RPT/SFT]** key twice.
 (Press twice)

 Transmission cannot be done if the offset frequency is not in the amateur band. In this condition, the display will show "OFF".

◆ In step 3 for the CMP843A Microphone, direct input is possible.

REVERSING THE REPEATER TRANSMIT/RECEIVE FREQUENCIES

In normal repeater operation, the transmit frequency is lower than the receive frequency. However, it is possible to reverse these frequencies so that the transmit frequency becomes the receive frequency and vice versa. This function is used when receiving a signal directly (a signal without intervening repeater station) from another station. In addition, when direct signals can be received, try communication in simplex mode.

On the Control Head:

1. Press the **[144]** key.
2. Verify VFO mode. (D 18)
3. Turn the main dial to display the repeater station frequency.
4. Press the **[REV/RPT]** key.
5. The indication on the display lowers by 600 kHz. Check the display for blinking of the "-" or "+" indication.
6. To end reversal, press the **[REV/RPT]** key.

On the CMP843A Microphone:

1. Press the **[D/BAND]** key and select the 144 MHz band.
2. Verify VFO mode. (D 18)
3. Press the **[2/DOWN]** or **[3/UP]** key to display the repeater station frequency.

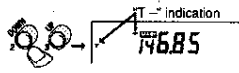

4. Press the **[REV/STEP]** key.
5. The frequency indication on the display lowers by 600 kHz. Check the display for blinking of the "-" or "+" indication.

Blinking "-" indication

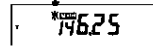

6. To end reversing, press the **[REV/STEP]** key.

In step 3 for the CMP843A Microphone, direct input is possible.

CHANGING THE REPEATER OFFSET FREQUENCY

The offset frequency can be set to a value other than the default value of 600 kHz. This is to make the transceiver compatible with future repeater stations that may use other offset frequencies.

On the Control Head:

1. Press the **[144]** key.
2. Verify VFO mode. (D 18)
3. Press the **[CAL/STEP]** key while pressing the **[FNC]** key.
4. Check the display for the offset frequency.
5. Turn the main dial to set a new offset frequency.
6. Press the **[CAL/STEP]** key while pressing the **[FNC]** key.
7. Verify VFO mode. (D 18)

On the CMP843A Microphone:

1. Press the **[D/BAND]** key and select the 144 MHz band.
2. Verify VFO mode. (D 18)
3. Press the **[RPT/SFT]** key until the display shows the new offset frequency.

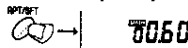

4. Press the **[2/DOWN]** or **[3/UP]** key to set a new offset frequency.

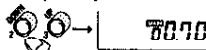

5. Press the **[RPT/SFT]** key until the display returns to the condition before change.

In step 4 for the CMP843A Microphone, direct input is possible.

CHANGING THE REPEATER TONE FREQUENCY

The default tone frequency for repeater operation is 88.5 Hz. This frequency can be changed.

On the Control Head:

1. Press the **[144]** key.
2. Verify VFO mode. (D 18)
3. Press the **[FNC]** key.
4. Press the **[SCN/TSQ]** key until the display shows the tone frequency.
5. Turn the main dial to set a new tone frequency.
6. If the **FNC** mode has reset, press **[FNC]** key.
7. Press the **[SCN/TSQ]** key until the display returns to VFO mode. (D 18)

On the CMP843A Microphone:

1. Press the **[D/BAND]** key and select the 144 MHz band.
2. Verify VFO mode. (D 18)
3. Press the **[6/T-SQL]** key until the display shows the tone frequency.



4. Press the **[2/DOWN]** or **[3/UP]** key to select the new tone frequency.

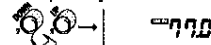

5. Press the **[6/T-SQL]** key until the display returns to VFO mode. (D 18)

ADDITIONAL FEATURES

TURNING OFF THE UNUSED BAND	60
DISPLAYING THE SAME BAND ON EACH DISPLAY (V-V, U-U)	60
CHANGING VFO FREQUENCIES SIMULTANEOUSLY (VFO LINK)	60
PREVENTING UNINTENTIONAL TRANSMISSION (PTT LOCK)	60
SETTING AUTOMATIC TRANSMISSION STOP	61
REDUCING SUB-BAND AUDIO OUTPUT (SUB-BAND MUTING)	61
CHANGING THE SUB-BAND AUDIO MUTING LEVEL	61
INHIBITING AUDIO FROM THE MAIN UNIT SPEAKER	61
INHIBITING AUDIO FROM THE MICROPHONE SPEAKER	62
CHANGING THE BEEP VOLUME	62
AM MODE OPERATION	62
OPERATING AS A CROSS-BAND REPEATER	63
INITIALIZING (RESET)	63
INITIALIZING ALL SETTINGS (ALL RESET)	63
INITIALIZING ALL SETTINGS EXCEPT MEMORY (VFO RESET)	63
CLEARING THE MEMORY (MEMORY RESET)	63
LIST OF SET MODE FUNCTIONS	64

TURNING OFF THE UNUSED BAND

You can turn off the unused band.

On the Control Head:

1. To turn off the **144** MHz band, hold down the **[FNC]** key and press the **[144]** key.
2. To turn off the **450** MHz band, hold down the **[FNC]** key and press the **[450]** key.
3. To cancel this operation, hold down the **[FNC]** key and press the key corresponding to the cleared band.

On the CMP843A Microphone:

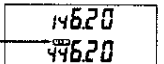
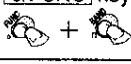
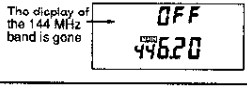
1. Use the **[D/BAND]** key to select the band you do not want to turn off.
 
2. Press the **[D/BAND]** key with the **[0/FUNC]** key held down.
 
3. Confirm that the display of the sub-band has been turned off.
 
4. To cancel this operation, press the **[D/BAND]** key with the **[0/FUNC]** key held down.

Note: When the 450 MHz band has been set on the VHF side and 144 MHz band on the UHF side, turning off the band disables transmission.

DISPLAYING THE SAME BAND ON EACH DISPLAY (V-V, U-U)

Normally, one display block displays the 144 MHz band and the other display block displays the 450 MHz band. This can be changed so that both blocks display the same band.

On the Control Head:

1. To display the **144** MHz band in both display blocks, hold down the **[450]** key until the **144** MHz band is displayed in both blocks.
2. To display the **450** MHz band in both display blocks, hold down the **[144]** key until the **450** MHz band is displayed in both blocks.
3. To cancel this operation, set the undisplayed band as a main band and hold down the key until it is displayed.

On the CMP843A Microphone:

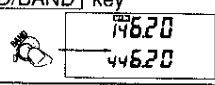
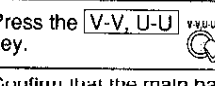
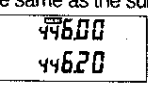
1. Select the band with the **[D/BAND]** key.
 
2. Press the **[V-V, U-U]** key.
 
3. Confirm that the main band is now the same as the sub-band.
 
4. To cancel this operation, set the undisplayed band as a main band and press the **[V-V, U-U]** key.

- You can also set the 450 MHz band on the VHF side and 144 MHz band on the UHF side.
- S-meter readings may differ between bands even though both bands are displaying the same frequency.
- When the band is the same and transmission is done, the other band cannot be also received. At this time, the MUTE indication for the other band blinks. When transmission is done with the VHF side adjusted to UHF and UHF side to VHF, the other band cannot be also received.

Note: Receiver sensitivity and radio interference characteristics on the sub-band side has lower performance than the main band. An unmodulated carrier may be received by combining the left and right frequencies. This is due to the frequency configuration of the receiver and not a fault.

CHANGING VFO FREQUENCIES SIMULTANEOUSLY (VFO LINK)

You can simultaneously change both VFO frequencies displayed on the display block. This operation is referred to as VFO link.

On the Control Head:

1. Hold down the **[FNC]** key and press the **[REV/RPT]**.
2. Confirm that a "∞" symbol is displayed on the display block. Now, turning the main dial alters both frequencies at the same time.
3. To cancel this operation, keep on pressing the **[REV/RPT]** key with the **[FNC]** key held down until the "∞" symbol disappears.

On the CMP843A Microphone:

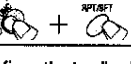
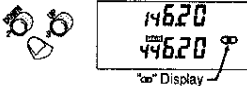
1. Hold down the **[0/FUNC]** key and press the **[RPT/SFT]**.
 
2. Confirm that a "∞" symbol is displayed on the display block. Pressing the **[2/DOWN]** or **[3/UP]** key alters both frequencies at the same time.
 
3. To cancel this operation, press the **[RPT/SFT]** key with the **[0/FUNC]** key held down.

- When this is done, the frequency step set on the main band side is assumed.
- Uplink and downlink can be received as a pair by setting both bands to VHF, and setting the VFO link by assuming either frequency to be the repeater uplink frequency and the other to be the downlink frequency.

VHF (Main Band) 146.250 ← DOWN 146.275 → UP 146.300
 UHF (Sub Band) 146.850 ← 146.875 → 146.900
 3 (Frequency step: 25 kHz)

PREVENTING UNINTENTIONAL TRANSMISSION (PTT LOCK)

To prevent unintentional transmission, the PTT can be disabled.

On the Control Head:

1. Verify VFO mode. (**D** 18)
2. Press the **[V.M/ENT]** key with the **[FNC]** key held down.
3. Turn the main dial to select Set Mode 15. (**D** 64-65)
4. Press the **[V.M/ENT]** key to change OFF on the display block to on.
5. Press the **[V.M/ENT]** key with the **[FNC]** key held down.
6. Verify VFO mode. (**D** 18)

On the CMP843A Microphone:

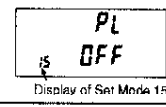
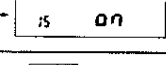
1. Verify VFO mode. (**D** 18)
2. Press the **[SET]** key.
 
3. Press the **[2/DOWN]** or **[3/UP]** key to select Set Mode 15.
 
4. Press the **[#V-M]** key to change OFF on the display block to on.
5. Press the **[SET]** key.
6. Verify VFO mode. (**D** 18)

- To cancel this operation, change on to OFF in step 4. In the PTT lock state, pressing **[PTT]** shows PL in the display block.

SETTING AUTOMATIC END OF TRANSMISSION

Enabling this feature will stop transmission automatically after 15 minutes of transmitting. When transmission stops, a beep sounds. This function is not enabled in the initial condition.

On the Control Head:

1. Verify VFO mode. (P 18)
2. Press the **[V.M/ENT]** key with the **[FNC]** key held down.
3. Turn the main dial to select Set Mode 19. (P 64-65)
4. Press the **[V.M/ENT]** key to change OFF on the display block to on.
5. Press the **[V.M/ENT]** key with the **[FNC]** key held down.
6. Verify VFO mode. (P 18)

On the CMP843A Microphone:

1. Verify VFO mode. (P 18)
2. Press the **[SET]** key.
3. Press the **[2/DOWN]** or **[3/UP]** key to select Set Mode 19.
4. Press the **[/V-M]** key to change OFF on the display block to on.
5. Press the **[SET]** key.
6. Verify VFO mode. (P 18)

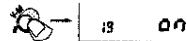
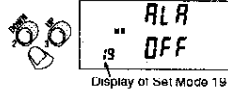

In order to prevent unintentional transmission from a "stuck microphone," it is recommended that you leave this function turned on.

REDUCING SUB-BAND AUDIO OUTPUT (SUB-BAND MUTING)

Sub-band audio output can be reduced to a preset level. This operation is referred to as sub-band muting.

On the Control Head:

1. Press the **[MS/PO]** key with the **[FNC]** key held down.
2. Confirm that "MUTE" is displayed for the sub-band. Also, confirm that sub-band audio has been lowered.
3. To cancel this operation, press the **[MS/PO]** key with the **[FNC]** key held down.

On the CMP843A Microphone:

1. Press the **[B/SUB MUTE]** key.
2. Confirm that "MUTE" is displayed for the sub-band. Also, confirm that the sub-band audio has been lowered.
3. To cancel this operation, press the **[B/SUB MUTE]** key.

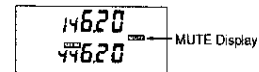

CHANGING THE SUB-BAND AUDIO MUTING LEVEL

The level at which the sound of the sub-band is muted can be changed.

On the Control Head:

1. Verify VFO mode. (P 18)
2. Press the **[V.M/ENT]** key with the **[FNC]** key held down.
3. Turn the main dial to select Set Mode 18. (P 64-65)
4. Press the **[V.M/ENT]** key to determine the level. Every time the **[V.M/ENT]** key is pressed, the display on the display block toggles in the following order: -12, -18, -6. (The initial value is -12. Selecting -18 lowers the audio and selecting -6 raises it.)
5. Press the **[V.M/ENT]** key with the **[FNC]** key held down.
6. Verify VFO mode. (P 18)

On the CMP843A Microphone:

1. Verify VFO mode. (P 18)
2. Press the **[SET]** key.
3. Press the **[2/DOWN]** or **[3/UP]** key to select Set Mode 18.
4. Press the **[/V-M]** key to determine the level. Every time the **[/V-M]** key is pressed, a display on the display block toggles in the following order: -12, -18, -6. (The initial value is -12. Selecting -18 lowers the audio and selecting -6 raises it.)
5. Press the **[SET]** key.
6. Verify VFO mode. (P 18)

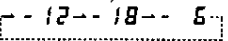
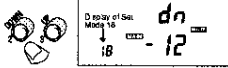

INHIBITING AUDIO FROM THE MAIN UNIT SPEAKER

Audio from the main unit speaker can be inhibited.

On the Control Head:

1. Verify VFO mode. (P 18)
2. Press the **[V.M/ENT]** key with the **[FNC]** key held down.
3. Turn the main dial to select Set Mode 05. (P 64-65)
4. Press the **[V.M/ENT]** key to change "on" on the display block to OFF.
5. Press the **[V.M/ENT]** key with the **[FNC]** key held down.
6. Verify VFO mode. (P 18)

On the CMP843A Microphone:

1. Verify VFO mode. (P 18)
2. Press the **[SET]** key.
3. Press the **[2/DOWN]** or **[3/UP]** key to select Set Mode 05.
4. Press the **[/V-M]** key to change "on" on the display block to OFF.
5. Press the **[SET]** key.
6. Verify VFO mode. (P 18)

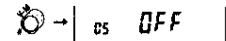
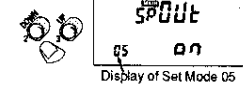

When an external speaker is connected, the internal speaker is disabled.

INHIBITING AUDIO FROM THE MICROPHONE SPEAKER

On the Control Head:

1. Press the **[V.M/ENT]** key with the **[FNC]** key held down.
2. Turn the main dial to select Set Mode 06. (D 64-65)
3. Press the **[V.M/ENT]** key to determine the setting. Every time the **[V.M/ENT]** key is pressed, the setting changes as follows:

144 MHz band output ON, 450 MHz band output ON

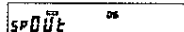

144 MHz band output OFF, 450 MHz band output ON



144 MHz band output ON, 450 MHz band output OFF

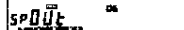

144 MHz band output OFF, 450 MHz band output OFF

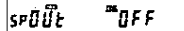

4. Press the **[V.M/ENT]** key with the **[FNC]** key held down.
5. Verify VFO mode. (D 18)

◆ When **[PTT]** is pressed while in the transmit mode, the microphone speaker will be disabled regardless of what has been set in the procedure above.

AM MODE OPERATION

As received from the factory, the transceiver is set to receive amplitude-modulated (AM) signals in the following frequency ranges:

- 118.000 to 141.995 MHz
- 250.000 to 327.500 MHz

This feature can be turned off so that these ranges are FM like the other frequencies of the transceiver.

On the Control Head:

1. Verify VFO mode. (D 18)
2. Hold down the **[FNC]** key and press the **[V.M/ENT]** key.
3. Turn the main dial to select Set Mode 20. (D 64-65)
4. Press the **[V.M/ENT]** key to change the display indication from "on" to "OFF".
5. Hold down the **[FNC]** key and press the **[V.M/ENT]** key. A "decimal" point will appear two characters to the right of the MHz "decimal" point. This is an indicator for the AM mode.
6. Verify VFO mode. (D 18)

On the CMP843A Microphone:

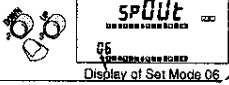
1. Verify VFO mode. (D 18)
 2. Press the **[SET]** key.
 3. Press the **[2/DOWN]** or **[3/UP]** key to select Set Mode 06.
- 
4. Press the **[#/V-M]** key to determine the setting. Every time the **[#/V-M]** key is pressed, the setting changes as follows:
- | | |
|--|--|
| 144 MHz band output ON
450 MHz band output ON | |
| 144 MHz band output OFF
450 MHz band output ON | |
| 144 MHz band output ON
450 MHz band output OFF | |
| 144 MHz band output OFF
450 MHz band output OFF | |
5. Press the **[SET]** key.
 6. Verify VFO mode. (D 18)

CHANGING THE BEEP AUDIO VOLUME

You can change the volume of the beep sound that occurs when an improper operation is attempted.

On the Control Head:

1. Verify VFO mode. (D 18)
2. Press the **[V.M/ENT]** key with the **[FNC]** key held down.
3. Turn the main dial to select Set Mode 00. (D 64-65)
4. Press the **[V.M/ENT]** key to display the beep level.
5. Every time the **[V.M/ENT]** key is pressed, the level on the display block changes in the following order: 2 (Medium), 3 (High), OFF, 1 (Low), and then back to 2.
6. Press the **[V.M/ENT]** key with the **[FNC]** key held down.
7. Verify VFO mode. (D 18)

On the CMP843A Microphone:

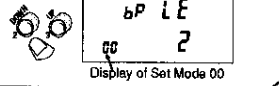
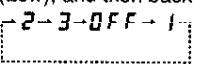
1. Verify VFO mode. (D 18)
 2. Press the **[SET]** key.
 3. Press the **[2/DOWN]** or **[3/UP]** key to select Set Mode 05.
- 
4. Press the **[#/V-M]** key to display the beep level.
 5. Every time the **[#/V-M]** key is pressed, the level on the display block changes in the following order: 2 (Medium), 3 (High), OFF, 1 (Low), and then back to 2.
- 
6. Press the **[SET]** key.
 7. Verify VFO mode. (D 18)





OPERATING AS A CROSS-BAND REPEATER

The transceiver can be configured to operate as a cross-band repeater, receiving on one band and transmitting on the other band.

On the Control Head:

1. Verify VFO mode. (D 18)
2. Hold down the **[FNC]** key and press the **[V.M/ENT]** key.
3. Turn the main dial to display Set Mode 22. (D 64-65)
4. Press the **[V.M/ENT]** key to change the display indication from "OFF" to "on".
5. Hold down the **[FNC]** key and press the **[V.M/ENT]** key.
6. Verify VFO mode (D 18)
7. Verify that the MAIN indicator is flashing.

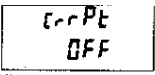
On the CMP843A Microphone:

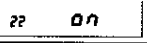
1. Verify VFO mode. (D 18)
2. Press the **[SET]** key. 
3. Press the **[2/DOWN]** or **[3/UP]** key to display Set Mode 22.  
4. Press the **[3/V-M]** key to change the display indication from "OFF" to "on".  
5. Press the **[SET]** key.
6. Verify VFO mode. (D 18)
7. Verify that the MAIN indicator is flashing.

NOTES:

1. On the main unit, left band is VHF and right band is UHF.
2. Each band is in VFO mode.
3. When either band receives a signal, the signal is re-transmitted (repeated) on the frequency of the other band.
4. When shipped from the factory the unit is configured so that if cross band is on when power is turned off, the cross band repeater mode is canceled and the unit turns off. Setting Atrpt to ON under setting mode no.14 causes the cross band mode not to be canceled when the power is switched off.

INITIALIZING (RESET)

Resetting restores the initial conditions set by the factory. Transceiver settings may be reset by the following three methods:

- All reset Initializes all settings such as VFO, memory, etc.
- VFO reset Initializes all settings except the memory setting. It also initializes the settings modified by the Set mode.
- Memory reset Initializes only the memory.



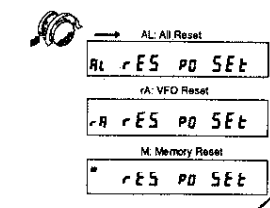

On the Control Head:

1. With the **[FNC]** key held down, press the **[P.PWR]** switch to turn on the power. Confirm that the display block has been reset.
2. Turn the main dial to select the resetting method.



3. Press the **[MS/PO]** key.
4. Press the **[SCN/TSQ]** key. This initiates reset.
5. Press the **[P.PWR]** switch to turn off the power.

On the CMP843A Microphone:

1. With the **[0/FUNC]** key held down, press the **[PWR]** switch to turn on the power. Confirm that the display block has been reset.  + 
2. Press the **[2/DOWN]** or **[3/UP]** key to select the resetting method.  

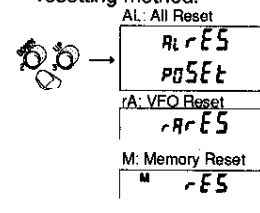

3. Press the **[C/PO]** key. 
4. Press the **[8/SCAN]** key. This initiates reset.
5. Press the **[PWR]** switch to turn off the power.

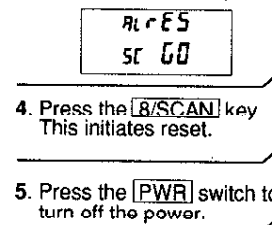

LIST OF SET MODE FUNCTIONS

◆ If you transmit in the Set Mode or no operation occurs for about 1 minute, the Set Mode is canceled automatically.

Set Mode No.	Ref. Page	Function	Control Head (Initial Display)	CMP843A Microphone (Initial Display)
00	62	Sets the beep audio volume		
01	54	Selects the scan speed		
02	54	Selects the scan method (144 MHz band)		
03	54	Selects the scan method (450 MHz band)		
04	54	Selects the hold time for busy scan		
05	61	Enables/disables main unit speaker audio output		
06	62	Enables/disables microphone speaker audio output		
07	32	Enables/disables direct input from the 100 MHz		
08	76	Selects the DTMF code sending speed		
09	72	Selects the delay time required for paging signal output		
10	72	Selects the number of times the alarm sounds on receipt of a page		
11	76	Sets DTMF to a single tone		

LIST OF SET MODE FUNCTIONS

Set Mode No.	Ref. Page	Function	Control Head (Initial Display)	CMP843A Microphone (Initial Display)
12	31	Enables/disables the 1 MHz step operation	F rot ¹² ENR	F rot ¹² ENR
13	37	Enables/disables the main dial during key lock	rot ¹³ DIS	rot ¹³ DIS
14	63	Cross-band repeater backup	At r Pt ¹⁴ OFF	At r Pt ¹⁴ OFF
15	60	Locks/unlocks the PTT switch	PL ¹⁵ OFF	PL ¹⁵ OFF
16	48	Sets/resets memory protect	^M Pro ¹⁶ OFF	Pro ¹⁶ OFF
17	39	Sets the RF squelch	r f S QL ¹⁷ OFF	r f S QL ¹⁷ OFF
18	61	Sets the muting level	dn ¹⁸ - 12	dn ¹⁸ - 12
19	61	Sets/resets automatic transmission stop	ALR ¹⁹ OFF	ALR ¹⁹ OFF
20	62	Sets auto AM/FM function	At RF ²⁰ ON	At RF ²⁰ ON
22	63	Enables Cross-Band Repeater	C r r Pt ²² OFF	C r r Pt OFF

USING TONE SQUELCH UNIT/DTMF UNIT

ABOUT THE CTN5700 TONE SQUELCH UNIT.....	67
USING THE TONE ENCODER.....	68
USING TONE SQUELCH.....	68
CHANGING THE TONE FREQUENCY.....	68
ABOUT THE CTD5700 DTMF UNIT.....	69
PREPARATION FOR PAGING AND CODE SQUELCH.....	69
SETTING YOUR OWN INDIVIDUAL CODE.....	70
INPUTTING ANOTHER PARTY'S PAGING/SQUELCH CODE.....	70
SETTING A GROUP CODE.....	71
PAGING METHOD.....	71
CHANGING THE TIME REQUIRED FOR PAGING SIGNAL OUTPUT.....	72
CHANGING THE NUMBER OF PAGING ALERTS.....	72
USING CODE SQUELCH.....	72
USING THE DTMF.....	73
STORING THE DTMF CODE.....	73
STORING THE DTMF CODE IN MEMORY.....	74
CHANGING THE DTMF CODE IN MEMORY.....	74
CONFIRMING THE STORED DTMF CODE.....	75
ERASING THE STORED DTMF CODE.....	75
SENDING THE STORED DTMF CODE.....	76
CHANGING THE DTMF CODE SENDING SPEED.....	76
CHANGING THE DTMF TO A SINGLE TONE.....	76

ABOUT THE CTN5700 TONE SQUELCH UNIT

As a tone encoder, the CTN5700 unit allows the transceiver to be configured to add (encode) a tone to the carrier when transmitting. Reception is not affected. When permitted by law, this tone encode on the carrier can be used to access certain types of equipment such as a repeater.

As a tone squelch device, the CTN5700 unit generates a tone (sometimes called a code) that is added to the carrier and "looks for" that same tone on received signals. If the generated tone and the received tone match, the transceiver's squelch circuits will open and allow audio output. If the two codes do not match, squelch will not open, and no audio will be output.

- **Tone Encoder** ---- A tone signal is transmitted. Received signals do not require a tone.

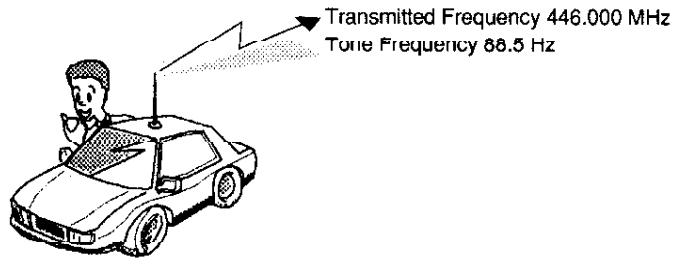

- **Tone Squelch** ---- A tone signal is transmitted. Another transceiver cannot receive the transmission unless its tone squelch code is the same as the one transmitted.

Transmitter Side

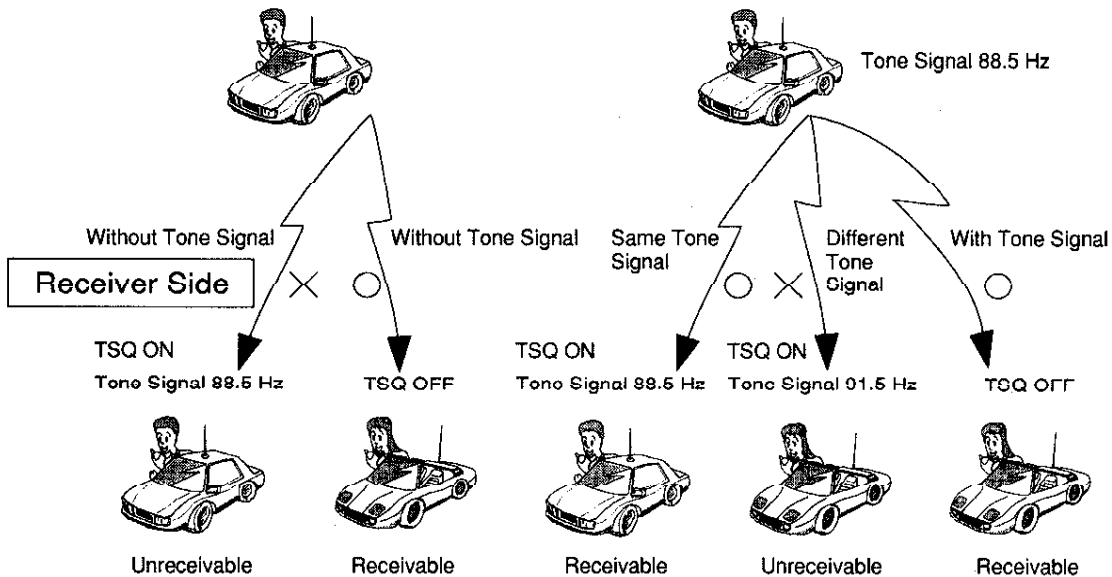



USING THE TONE ENCODER

On the Control Head:

1. Select the band with the [144] key or [450] key.
2. Verify VFO mode. (D 18)
3. Press the [FNC] key.
4. Press the [SCN/TSQ] key.
5. Confirm that "T" is displayed on the display block. On transmission, a tone signal is sent.
6. To turn off the tone encoder, press the [FNC] key, and then press the [SCN/TSQ] key twice.

On the CMP843A Microphone:

1. Select the band with the [D/BAND] key.
2. Verify VFO mode. (D 18)
3. Press the [6/T-SQL] key. 
4. Press the [SCN/TSQ] key.
5. Confirm that "T" is displayed on the display block. On transmission, a tone signal is sent.
6. To turn off the tone encoder, press the [6/TSQ] key twice.

Display of "T" 

On transmission, a tone signal is sent.

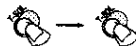



USING TONE SQUELCH

On the Control Head:

1. Select the band with the [144] or [450] key.
2. Verify VFO mode. (D 18)
3. Press the [FNC] key.
4. Press the [SCN/TSQ] key.
5. Confirm that "TSQ" is displayed on the display block. For reception, audio is heard when the tone signals match. On transmission, the tone signal is sent.
7. To turn off the tone squelch, press the [FNC] key, followed by the [SCN/TSQ] key.

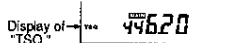
On the CMP843A Microphone:

1. Select the band with the [D/BAND] key.
2. Verify VFO mode. (D 18)
3. Press the [6/T-SQL] key twice. 
4. Confirm that "TSQ" is displayed on the display block. 
5. For reception, audio is heard when the tone signals match. On transmission, the tone signal is sent.
6. To turn off the tone encoder, press the [6/TSQ] key. 



◆ The factory setting for the tone signal is 88.5 Hz.

CHANGING THE TONE FREQUENCY

On the Control Head:

1. Select the band with the [144] or [450] key.
2. Verify VFO mode. (D 18)
3. Press the [FNC] key.
4. Press the [SCN/TSQ] key until the display block displays the tone frequency.
5. With the main dial, adjust to the desired tone frequency.
6. If the FNC mode has reset, press the [FNC] key.
7. Press the [SCN/TSQ] key until VFO mode is restored (this provides a new tone signal).

On the CMP843A Microphone:

1. Select the band with the [D/BAND] key.
2. Verify VFO mode. (D 18)
3. Press the [6/T-SQL] key until the display block displays the tone frequency. 
4. Using the [2/DOWN] or [3/UP] key, set the desired tone frequency. 
5. Press the [6/T-SQL] key until VFO mode is restored (this provides a new tone signal).



- ◆ The tone signal frequency can be set for each band.
- ◆ Initially, the tone frequency has been set to 88.5 Hz (as shipped from the factory).
- ◆ A tone frequency can be set for each band.
- ◆ The tone frequency for another station can be searched for by operating the main dial or [UP]/[DOWN] key.

ABOUT THE CTD5700 DTMF UNIT

The DTMF unit allows conventional operation that requires DTMF tones, such as dialing a telephone through a repeater (where this is permitted).

In addition, the DTMF unit allows a paging function where an audio alert signal is produced in the receiving party's transceiver. At the same time, the calling party's 3-digit code appears on the display of the receiving party's transceiver.

Finally, the DTMF unit allows code squelch operation similar to that performed by the CTN5700 tone encoder. However, the DTMF unit does this with DTMF tones, and codes of up to 15 characters can be used.

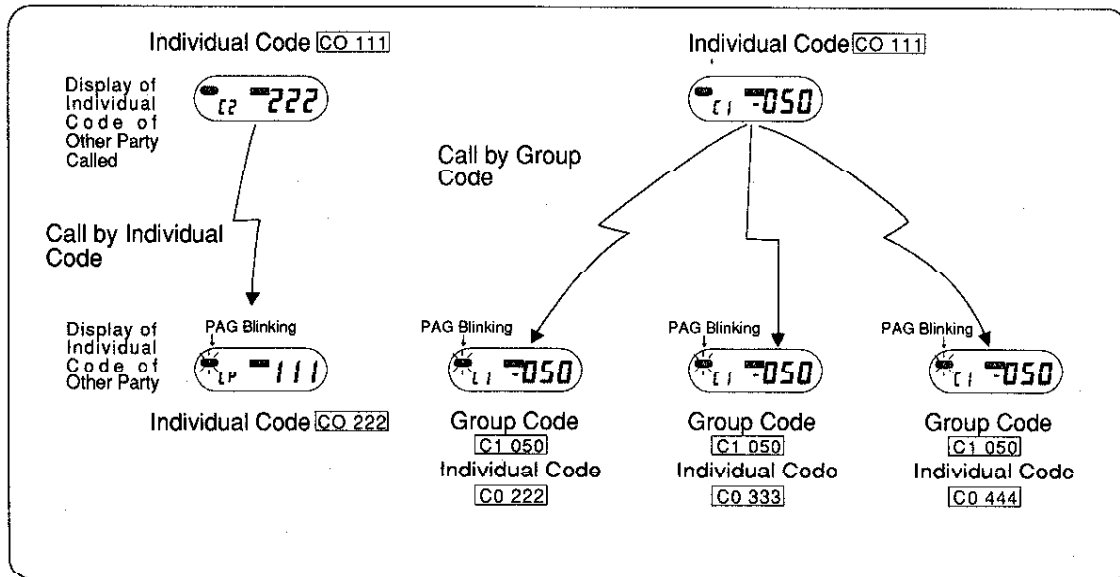

SETTING YOUR OWN INDIVIDUAL CODE

On the Control Head:

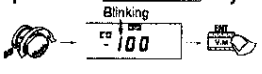
1. Select the band with the **[144]** or **[450]** key.
2. Verify VFO mode. (**D** 18)
3. Press the **[PG.C/DT]** key until the display block is ready to accept the code.
4. Turn the main dial to select the memory address (C0 to C5) for your own individual code.
5. Press the **[FNC]** key.
6. Press the **[V.M/ENT]** key.
7. Turn the main dial to set the 1st digit, and press the **[V.M/ENT]** key.
 
8. Turn the main dial to set the 2nd digit, and press the **[V.M/ENT]** key.
9. Turn the main dial to set the 3rd digit, and press the **[V.M/ENT]** key.
10. Keep pressing the **[PG.C/DT]** key until VFO mode is restored.

On the CMP843A Microphone:

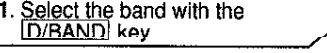
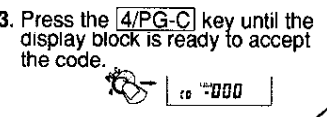
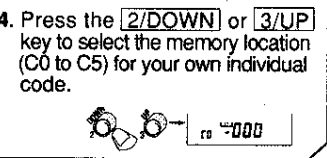
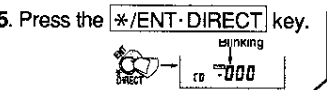
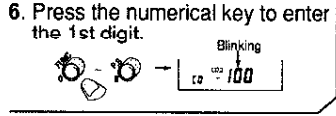
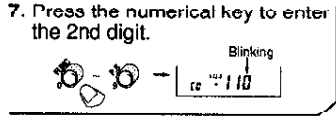
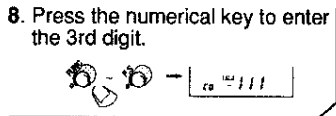
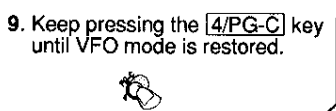
1. Select the band with the **[D/BAND]** key.
 
2. Verify VFO mode. (**D** 18)
3. Press the **[4/PG-C]** key until the display block is ready to accept the code.
 
4. Press the **[2/DOWN]** or **[3/UP]** key to select the memory location (C0 to C5) for your own individual code.
 
5. Press the **[*/ENT·DIRECT]** key.
 
6. Press the numerical key to enter the 1st digit.
 
7. Press the numerical key to enter the 2nd digit.
 
8. Press the numerical key to enter the 3rd digit.
 
9. Keep pressing the **[4/PG-C]** key until VFO mode is restored.
 

INPUTTING ANOTHER PARTY'S PAGING/SQUELCH CODE

After you learn the paging/squelch code of another party, that code can be put in the transceiver.

On the Control Head:

1. Select the band with the **[144]** or **[450]** key.
2. Verify VFO mode. (**D** 18)
3. Press the **[PG.C/DT]** key until the display block is ready to accept the code.
4. Turn the main dial to select the memory location (C0 to C5) for the individual code of the other party.
5. Press the **[FNC]** key.
6. Press the **[V.M/ENT]** key.
7. Turn the main dial to set the 1st digit, and press the **[V.M/ENT]** key.
8. Turn the main dial to set the 2nd digit, and press the **[V.M/ENT]** key.
9. Turn the main dial to determine the 3rd digit, and press the **[V.M/ENT]** key.
10. Keep pressing the **[PG.C/DT]** key until the VFO condition is restored.

On the CMP843A Microphone:

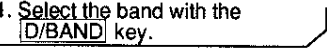
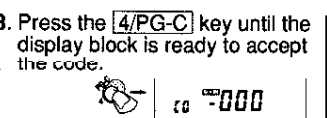
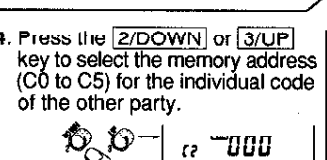
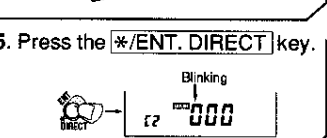
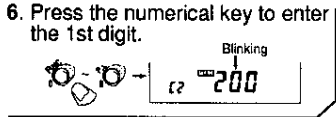
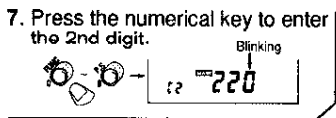
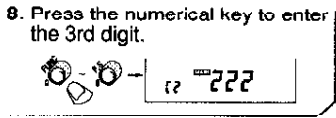
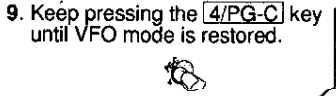
1. Select the band with the **[D/BAND]** key.
 
2. Verify VFO mode. (**D** 18)
3. Press the **[4/PG-C]** key until the display block is ready to accept the code.
 
4. Press the **[2/DOWN]** or **[3/UP]** key to select the memory address (C0 to C5) for the individual code of the other party.
 
5. Press the **[*/ENT·DIRECT]** key.
 
6. Press the numerical key to enter the 1st digit.
 
7. Press the numerical key to enter the 2nd digit.
 
8. Press the numerical key to enter the 3rd digit.
 
9. Keep pressing the **[4/PG-C]** key until VFO mode is restored.
 

SETTING A GROUP CODE

On the Control Head:

1. Select the band with the **[144]** or **[450]** key.
2. Verify VFO mode. (**D** 18)
3. Press the **[PG.C/DT]** key until a display on the display block is ready to determine the code.
4. Turn the main dial to select a memory address (C0 to C5) for the group code.
5. Press the **[PG.C/DT]** key. (The code is prefixed by "-" and has become the group code)
6. Keep pressing the **[PG.C/DT]** key until VFO mode is restored.

On the CMP843A Microphone:

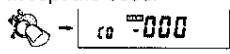
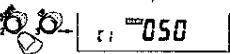
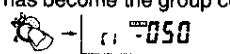
1. Select the band with the **[D/BAND]** key.
2. Verify VFO mode. (**D** 18)
3. Press the **[4/PG-C]** key until the display block is ready to accept the code.

4. Press the **[2/DOWN]** or **[3/UP]** key to set the desired group code. (The group code can be set to C1-C5)

5. Press the **[4/PG-C]** key. (The code is prefixed by "-" and has become the group code)

6. Keep pressing the **[4/PG-C]** key until VFO mode is restored.

-  ◆ To reset the group code, perform the same procedure with the code which has been set as the group code. At this time, confirm that the minus sign prefixing the code has disappeared.

PAGING METHOD

This procedure describes how to set up the paging mode and to receive/answer/initiate paging calls.

On the Control Head:

1. Select the band with the **[144]** or **[450]** key.
2. Verify VFO mode. (**D** 18)
3. Make sure that the squelch condition is correct (no noise heard from the speaker)
4. Press the **[PG.C/DT]** key. The PAG indicator will be displayed. This is the paging mode.
5. When you are paged, PAG will blink, an alert will sound, and the individual or group number of the calling party will appear on the display.
6. Press the **[PTT]** to respond. Release the **[PTT]** to listen.
7. When communications are finished, exit the paging mode by pressing the **[PG.C/DT]** key twice. This returns the receiver to normal operations.

On the CMP843A Microphone:

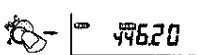
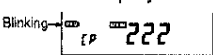
1. Select the band with the **[D/BAND]** key.
2. Verify VFO mode. (**D** 18)
3. Make sure that the squelch condition is correct (no noise heard from the speaker)
4. Press the **[4/PG-C]** key. The PAG indicator will be displayed. This is the paging mode.

5. When you are paged, PAG will blink, an alert will sound, and the individual number or group number of the other party will appear on the display.

6. Press the **[PTT]** to respond.

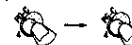

7. When communications are finished, exit the paging mode by pressing the **[4/PG-C]** twice. This returns the receiver to normal operations.





CHANGING THE TIME REQUIRED FOR PAGING SIGNAL OUTPUT

Normally, the paging signal is transmitted about 250 msec after **[PTT]** is pressed. This time period can be altered to either 450 msec or 850 msec.

On the Control Head:

1. Verify VFO mode. (D 18)
2. Hold down the **[FNC]** key and press the **[V.M/ENT]** key.
3. Turn the main dial to display Set Mode 09. (D 64-65)
4. Press the **[V.M/ENT]** key to change the display from 250 to 450 or 850.
5. After the new time period is selected, press the **[V.M/ENT]** key with the **[FNC]** key held down.
6. Verify VFO mode. (D 18)

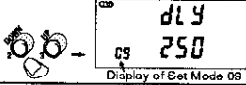
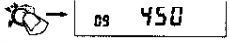
On the CMP843A Microphone:

1. Verify VFO mode. (D 18)
2. Press the **[SET]** key. 
3. Press the **[2/DOWN]** or **[3/UP]** key to display Set Mode 09. 
Display of Set Mode 09
4. Press the **[#/V-M]** key to change the display from 250 to 450 or 850. 
Display of Set Mode 09
5. After the new time period is selected, press the **[SET]** key. 
6. Verify VFO mode. (D 18)



CHANGING THE NUMBER OF PAGING ALERTS

When you are paged, an alert sounds 7 times. This number can be changed so that the alert sounds only once.

On the Control Head:

1. Verify VFO mode. (D 18)
2. Hold down the **[FNC]** key and press the **[V.M/ENT]** key.
3. Turn the main dial to select Set Mode 10. (D 64-65)
4. Press the **[V.M/ENT]** key to change the display from 7 to 1.
5. Hold down the **[FNC]** key and press the **[V.M/ENT]** key.
6. Verify VFO mode. (D 18)

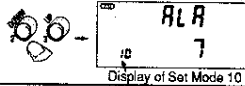
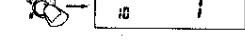
On the CMP843A Microphone:



1. Verify VFO mode. (D 18)
2. Press the **[SET]** key. 
3. Press the **[2/DOWN]** or **[3/UP]** key to select Set Mode 10. 
Display of Set Mode 10
4. Press the **[#/V-M]** key to alter the display from 7 to 1. 
5. Press the **[SET]** key. 
6. Verify VFO mode. (D 18)

USING CODE SQUELCH

On the Control Head:

1. Select the band with the **[44]** or **[45]** key.
2. Verify VFO mode. (D 18)
3. Make sure that the squelch is correct. (No noise is heard from the speaker.)
4. Press the **[PG.C/DT]** key twice.
5. When you are called by the other party and the code matches, the squelch opens.
6. To call the other party, press **[PTT]**.

On the CMP843A Microphone:

1. Select the band with the **[D/BAND]** key.
2. Verify VFO mode. (D 18)
3. Make sure that the squelch is correct. (No noise is heard from the speaker.)
4. Press the **[4/PG-C]** key twice. 
5. When you are called by the other party and the code matches, the squelch opens.
6. To call the other party, press **[PTT]**. 

Paging Application (1)

When Calling a Specific Person

1. Mr. A Mr. B Mr. C
Local Code Local Code Local Code
Mr. B's Code Mr. A's Code No Code Entered



2. Mr. A calls Mr. B.

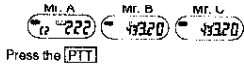

3. Mr. B is called.



4. Mr. B answers.

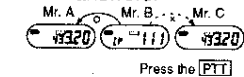

5. Communications start between Mr. A and B.

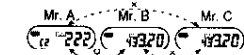

Reset paging.

Paging Application (2)

When Calling a Group

1. Mr. A Mr. B Mr. C Mr. D
Local Code Local Code Local Code No Same Group Code as Mr. A, B, or C Entered



2. Mr. A calls the group.

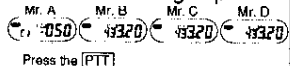

3. Mr. B and C are called.

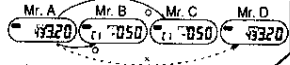

4. Mr. B answers.

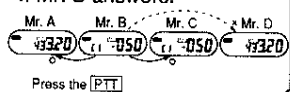

5. Communications start between Mr. A and B.

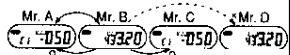

Reset paging. Unless Mr. C resets paging, communications between Mr. A and B cannot continue.

USING THE DTMF

There are two ways of sending the DTMF signal. The first method is to press and hold the [PTT] switch while inputting the signals. The second method is to send a DTMF code that has been stored in memory.

- To send the DTMF signal with [PTT] held down:

1. Press the desired keys (0 through 9, A through D, *, and #) with [PTT] held down.



◆ The DTMF signal is sent only while the key is pressed.



Press the [PTT] switch

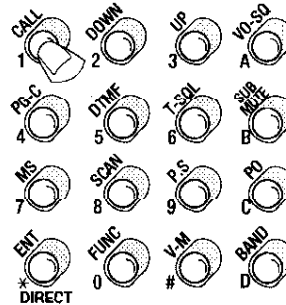

Storing the DTMF Code

- A DTMF signal of up to 15 digits can be stored in the DTMF exclusive memory. The 15-digit DTMF signal is divided into three 5-digit blocks.

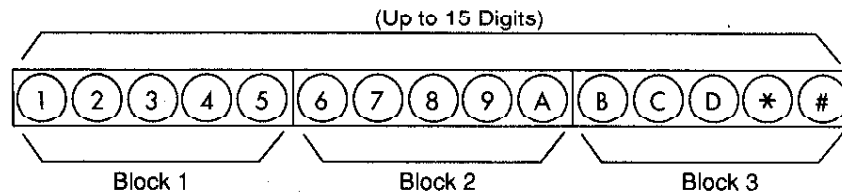

In the following manner, you can confirm which block is being displayed on the display block:

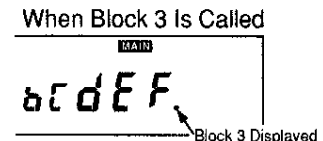
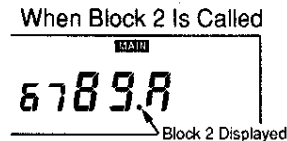
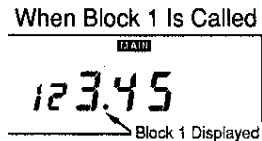

- There are six exclusive memories common to the 144 MHz and 450 MHz bands. Storing the DTMF signal allows you to operate more easily. The storable characters include 0 through 9, A through D, *, and #. The characters appear as follows on the display block.

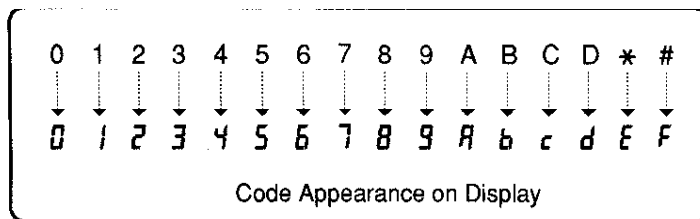

STORING THE DTMF CODE

On the Control Head:

1. Verify VFO mode. (D 18)
2. Press the **[FNC]** key.
3. Press the **[PG.C/DT]** key until the display block is ready to accept the code.
4. Press the **[FNC]** key to reset the FNC mode.
5. Turn the main dial to select the memory address (C0 to C5) to store the DTMF code.
6. Press the **[FNC]** key.
7. Press the **[V.M/ENT]** key.
8. Confirm that the display block is ready to accept an entry of the 1st character.
9. Turn the main dial to select the 1st character to store in memory.

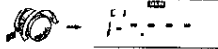

10. Press the **[V.M/ENT]** key.
11. Turn the main dial to store the 2nd character of the code.
12. Repeat the same procedure up to the 15th character.
13. Press the **[FNC]** key.
14. Press the **[PG.C/DT]** key until VFO mode is restored.

For CMP843A Microphone:

1. Verify VFO mode. (D 18)

2. Press the **[5/DTMF]** key until the display block is ready to accept the code.

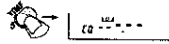

3. Press the **[2/DOWN]** or **[3/UP]** key to select the memory address (C0 to C5) for storage of the code.

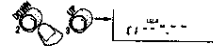

4. Press the **[*/ENT.DIRECT]** key.



- ◆ When the code you enter is shorter than 15 characters, pressing **[PTT]** enters the code so far.

5. Confirm that the display block is ready to accept an entry of the 1st character.

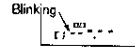

6. Using the keypad, enter the code as characters 1 through 15.

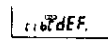
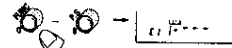

7. Press the **[5/DTMF]** key until VFO mode is restored.



CHANGING THE DTMF CODE IN MEMORY

You can change the DTMF signal stored in the DTMF exclusive memory.

On the Control Head:

1. Verify VFO mode. (D 18)
2. Press the **[FNC]** key.
3. Press the **[PG.C/DT]** key until the code is displayed on the display block.
4. Press the **[FNC]** key to reset the FNC mode.
5. Turn the main dial to select the memory address containing the DTMF code you wish to change.
6. Press the **[FNC]** key.
7. Press the **[V.M/ENT]** key.
8. Confirm that the display block is ready to accept an entry of the 1st character.
9. Turn the main dial to select the 1st character to store in memory.
10. Press the **[V.M/ENT]** key.
11. For a character you do not want to change, press the **[V.M/ENT]** key.
12. Repeat the same procedure up to the 15th character.
13. Press the **[FNC]** key.
14. Press the **[PG.C/DT]** key until VFO mode is restored.

On the CMP843A Microphone:

1. Verify VFO mode. (D 18)

2. Press the **[5/DTMF]** key until the code is displayed on the display block.

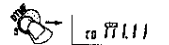

3. Press the **[2/DOWN]** or **[3/UP]** key to select the memory location containing the DTMF code you wish to change.

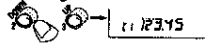

4. Press the **[*/ENT.DIRECT]** key.



5. Confirm that the display block is ready to accept an entry of the 1st character.

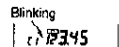

6. Using the keypad, enter the code from its 1st through 15th character.



7. Press the **[5/DTMF]** key until VFO mode is restored.



- ◆ With the CMP843A Microphone, when you alter the code, the full code must be re-entered. For a character you do not want to alter, enter the same character.

CONFIRMING THE STORED DTMF CODE

On the Control Head:

1. Select the band with the [144] key or [450] key.
2. Verify VFO mode. (D 18)
3. Press the [FNC] key.
4. Press the [PG.C/DT] key until the code is displayed on the display block.
5. Press the [FNC] key to reset the FNC mode.
6. Turn the main dial to select the memory address of the code you want to confirm.
7. Press the [FNC] key.
8. Turn the main dial to confirm the memory contents. The display will scroll through the entire code.
9. If the FNC mode has reset, press the [FNC] key.
10. Press the [PG.C/DT] key until VFO mode is restored.

On the CMP843A Microphone:

1. Verify VFO mode. (D 18)
2. Press the [5/DTMF] key until the code is displayed on the display block.
3. Press the [2/DOWN] or [3/UP] key to select the memory address of the code you want to confirm.
4. Press the [0/FUNC] key.

5. Press the [2/DOWN] or [3/UP] key to confirm the memory contents. The display will scroll through the entire code.

6. Press the [0/FUNC] key to reset the FNC mode.

7. Keep on pressing the [5/DTMF] key until the display block restores VFO mode. (D 18)

ERASING THE STORED DTMF CODE

On the Control Head:

1. Verify VFO mode. (D 18)
2. Press the [FNC] key.
3. Press the [PG.C/DT] key until the code is displayed on the display block.
4. Press the [FNC] key to reset the FNC mode.
5. Turn the main dial to select the memory address whose DTMF code you want to erase.
6. Press the [FNC] key.
7. Press the [V.M/ENT] key.
8. Confirm that the display block is ready to accept an entry of the 1st character. However, do not enter any character.
9. Press the microphone [PTT]. This erases the code.
10. Press the [FNC] key.
11. Press the [PG.C/DT] key until VFO mode is restored.

On the CMP843A Microphone:

1. Verify VFO mode. (D 18)
2. Press the [5/DTMF] key until the code is displayed on the display block.
3. Press the [2/DOWN] or [3/UP] key to select the memory address whose contents you want to erase.
4. Press the [*/ENT.DIRECT] key.
5. Confirm that the display block is ready to accept an entry of the 1st digit. However, do not enter any character.

6. Press the microphone [PTT]. This erases the code.

7. Keep pressing the [5/DTMF] key until the display block restores VFO mode.

8. Verify VFO mode. (D 18)

SENDING THE STORED DTMF CODE

On the Control Head and CMP842 Microphone: On the CMP843A Microphone:

1. Verify VFO mode. (D 18)
2. Press the **[FNC]** key.
3. Press the **[PG.C/DI]** key until the code is displayed on the display block.
4. Press the **[FNC]** key to reset the FNC mode.
5. Turn the main dial to select the stored DTMF code you want to send.
6. Press the **[FNC]** key.
7. Press the **[PG.C/DT]** key until VFO mode is restored.
8. Select the band with the **[144]** key or **[450]** key.
9. Press the **[FNC]** key to restore the FNC mode.
10. Press the **[PG.C/DT]** key.
11. Confirm that DTMF is shown on the display block.
12. Press the **[SQL-OFF]** key with **[PTT]** held down.



13. To erase the DTMF display, press the **[FNC]** key, followed by the **[PG.C/DT]** key.

The above operations apply when the CRC5700A control head and CMP842 microphone are connected. Even if step 11 is done with the CMP843A Microphone, the stored DTMF code cannot be sent.

1. Select the band with the **[D/BAND]** key.

2. Verify VFO mode. (D 18)

3. Press the **[5/DTMF]** key.



4. Confirm that DT is shown on the display block.

Display of DT: **476.20**

When DT is displayed, the DTMF tones corresponding to the 16 keys cannot be output.

5. With **[PTT]** held down, press the stored DTMF code you want to send, using the keys "0" through "5." (This operation sends the stored DTMF code)

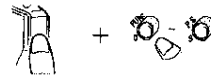

6. To erase the DT display, press the **[5/DTMF]** key.



CHANGING THE DTMF CODE SENDING SPEED

Normally, the DTMF signal is sent at a rate of 50 msec. This rate can be changed to 100 msec.

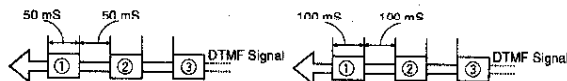

On the Control Head:

1. Select the band with the **[144]** key or **[450]** key.
2. Verify VFO mode. (D 18)
3. Press the **[V.M/ENT]** key with the **[FNC]** key held down.
4. Turn the main dial to select Set Mode 08. (D 64-65)
5. Press the **[V.M/ENT]** key to alter the display from 50 to 100.
6. Press the **[V.M/ENT]** key with the **[FNC]** key held down.
7. Verify VFO mode. (D 18)

On the CMP843A Microphone:

1. Using the **[D/BAND]** key, select the band.
 2. Verify VFO mode. (D 18)
 3. Press the **[SET]** key.
 4. Press the **[2/DOWN]** or **[3/UP]** key to select Set Mode 08.
- SPd**
08 50
Display of Set Mode 08
5. Press the **[#V.M]** key to alter the display from 50 to 100.
- 08 100**
6. Press the **[SET]** key.
 7. Verify VFO mode. (D 18)

CHANGING THE DTMF TO A SINGLE TONE

Normally, two tones are sent as one DTMF signal. This can be changed so that only a single tone is sent.

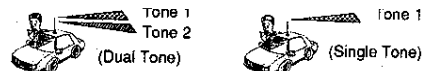

On the Control Head:

1. Select the band with the **[144]** or **[450]** key.
2. Verify VFO mode. (D 18)
3. Press the **[V.M/ENT]** key with the **[FNC]** key held down.
4. Turn the main dial to select Set Mode 11. (D 64-65)
5. Press the **[V.M/ENT]** key to alter the display from OFF to on.
6. Press the **[V.M/ENT]** key with the **[FNC]** key held down.
7. Verify VFO mode. (D 18)

On the CMP843A Microphone:

1. Select the band with the **[D/BAND]** key.
 2. Verify VFO mode. (D 18)
 3. Press the **[SET]** key.
 4. Press the **[2/DOWN]** or **[3/UP]** key to select Set Mode 11.
- 5 11**
11 OFF
Display of Set Mode 11
5. Press the **[#V.M]** key to alter a display from OFF to on.
- 11 00**
6. Press the **[SET]** key.
 7. Verify VFO mode. (D 18)

REFERENCES

PACKET OPERATION	78
Operating at 9600 baud High Speed Packet and preparation for Packet Communications	78
Tips for Packet Operation	78
Connecting to other manufactures	79
Operating AFSK 1200 baud	79
Wiring the Modem and C5718DA	80
USING OPTIONAL CABLES CAW570~CAW575	80
TROUBLESHOOTING	81
OPTIONS	82
AFTER-SALE SERVICE	82
RATINGS	83
INDEX	84
ONE YEAR LIMITED WARRANTY	85

PACKET OPERATION

Operating at 9600 baud High Speed Packet and preparation for Packet Communications.

The C5718DA can be connected without modification to a 9600 baud high-speed packet TNC-modem. An 8 pin DIN connector with cable and mating plug are provided for high speed packet interface. All that is required is the preparation of the connecting cable, normally provided by the TNC manufacturer, between the radio and the TNC-modem and the adjustment of the receive and transmit levels of the TNC-modem. The C5718DA requires no modification.

Connecting the transceiver to a high speed packet modem using the 8 pin DIN connector provided.

Use the supplied mating 8 pin DIN plug with case shield and solder the proper wires as outlined in the manufactures TNC-modem manual.

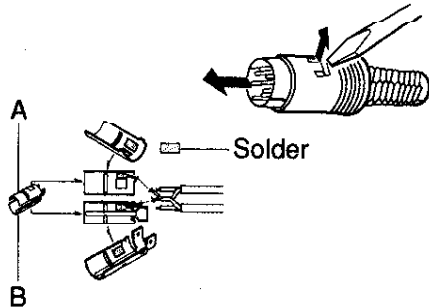

1. As show in the diagram, remove the cover and separate sections A and B of the metal case.

2. Solder the ground shield to the inside of the metal case, sections A and B.

Follow the description below for proper connection to the C5718DA.

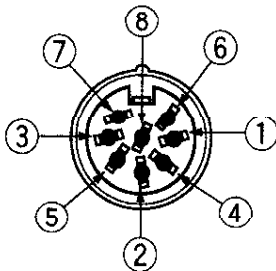

Pin#	Description	Pin#	Description
1	Transmit data	5	NC (No Connection)
2	GND (Ground)	6	NC
3	PTT (Push to talk)	7	NC
4	Receive data	8	NC
Case	GND Wire Shield		

Use shielded cable for the transmit, receive and PTT lines and keep cable lengths as short as possible to keep noise off data lines.

Tips for Packet Operation.

1. The C5718DA can be used for packet operation on either VHF or UHF bands. Consult the repeater for the proper frequency selection. The C5718DA must be used with the main band on the CMP843A microphone selected and not the sub-band. This means VHF main at the top of the display and UHF main at the bottom. Select the proper frequency in either mode VHF or UHF.
2. Receive volume adjustment is not normally needed but if your TNC-modem has a receive volume control, adjust the level for proper receive operation. This can be accomplished by adjusting the TNC's audio level up or down based on a properly transmitted signal.

3. Adjusting the transmit sound level (deviation) is very important for high speed packet operation, so be sure to set the level correctly. If you can monitor activity on your operating frequency with a second radio, set your TNC in the converse mode and press the return key to send out a CQ packet. Compare the audio level with other station's and adjust by ear. When you feel you are close, attempt a connection and if successful adjust for minimum retries.
4. If the TNC transmits data before the transceiver can switch to transmit (TX), the initial portion of the packet signal will not be transmitted. To correct this situation, there is a software command that allows the setting of the transmission delay time to longer value. A transmit delay of 30ms. is the recommended setting.
5. Make sure the power to the TNC-modem is turned off if you wish to make audio transmission with the modem connected.

CONNECTING TO OTHER MANUFACTURES.

When using a Kantronics Data Engine and DE19K2/9K6 connect as follows:

	C5718DA PIN#	Data Engine DB-15 connector PIN#
Transmit data	1	3
GND	2	9,10,11
PTT	3	1
Receive Data	4	2

The RX level does not normally need adjusting. If adjustment becomes necessary, consult the modem and INC manuals. Adjust the TX level for proper deviation with control R18. No adjustment of the C5718DA is required. Only G3RUH type (9600 baud) modems can be used. G3RUH type modems have 20 types of waveforms stored in PROM. The settings are recommended for the C5718DA.
 JMP1 ON, JMP2 OFF, JMP3 ON, JMP4 ON

OPERATING AFSK 1200 baud.

If you wish to operate an AFSK (1200 baud) TNC using the C5718DA, use the optional Dual Extension Cable (CAW570) and Adapter Cable (CAW579).

The pin arrangement of the CAW579 is as follows:

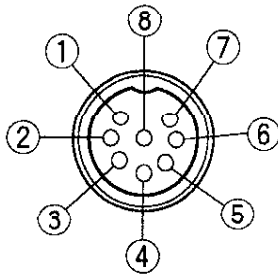

Pin#	Description
1	Audio Input
2	PTT
3	Audio Out
8	GND

All other pins are not used.

Wiring the Modem and C5718DA

Connect the Dual Extension Cable to the C5718DA. Connect the CMP843A microphone on one side and the CAW579 on the opposite side. Make the proper wiring connections from the adapter cable to the modem. The adapter pin number 3 "Audio Output" will be connected in parallel to the CMP843A's speaker. Since the packet cable is wired in parallel with the speaker in the microphone, packet audio will be heard from the speaker of the CMP843A. This can become annoying so another option would be to connect the received audio to the speaker jack on the rear of the C5718DA.

When using a Kantronics Data Engine and DE1200

	C5718DA Pin#	DB-15 connector Pin#
TX Audio	1	3
PTT	2	1
RX Audio	3	2
GND	8	9,10,11

Normally the TX level does not need to be adjusted, but if adjustment become necessary, adjust TX level as described in the users manual. Adjust the RX level with the CMP843A's volume control, starting at a low volume setting and increase until the RCV lamp lights up clearly when receiving AFSK (1200 baud) signals. Check your computer monitor for proper decoding. Note: RCV lamps for the Data Engine are A2 LED for Port1 and A8 for Port2.

USING OPTIONAL CABLES CAW570~CAW575

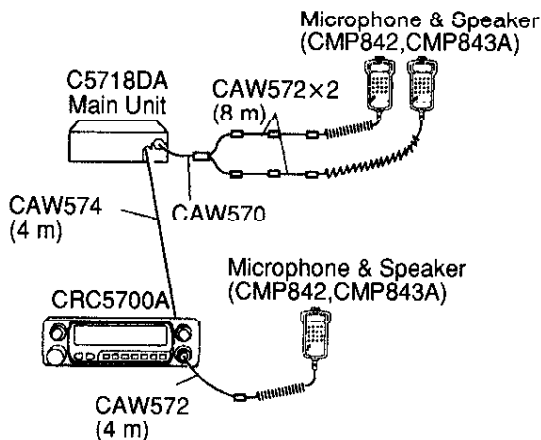

Up to 3 microphones can be connected by using an optional dual microphone cable (CAW570), extension cable (CAW571/CAW572), and remote cable (CAW573/CAW574).

The extension cable can be connected within 8 m. The left figure shows a combination example of those cables.

- Notes:
- ◆ If the extension cable exceeds 8 m. the microphone may not function properly.
 - ◆ The length of the CAW570 dual microphone cable and that of the microphone's curled cord are not included.

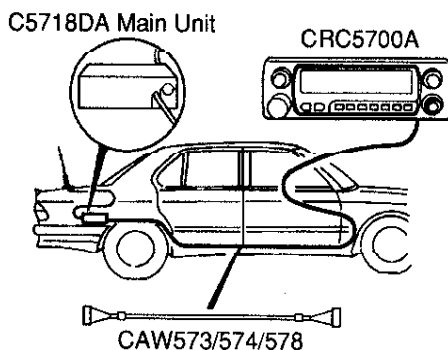

Using the extension cable or remote cable, you can place the main unit in the car trunk, or other location.

- When placing the main unit in the car trunk or other location, it is convenient to use an optional extension power cable (CAW575, 5 m long)

TROUBLESHOOTING

Prior to asking for our service, check the following items. When the trouble still cannot be solved by checking them, consult your dealer or our nearest office/service center.

	Trouble	Major Cause and Remedy
Power System	Power cannot be turned on.	Check the fuse. Disconnected DC cord An overvoltage (DC 18 V or more) has been applied to the DC IN 13.8 V terminal. Pull out the DC IN 13.8 V plug and check the DC power source for correct voltage.
Display System	A frequency for one band remains undisplayed.	The display block has been turned off.
	The display block is dark.	It has been dimmed by the dim control.
Reception System	Only strong signals are received.	Matching of the antenna is poor. The antenna is dislocated or loosened. The SQL knob has been turned to the full clockwise direction. The coaxial cable is dislocated or loosened. RF squelch operation has been set too high.
	The squelch cannot be closed. Noise is heard.	The squelch has been turned off by the microphone The squelch has been opened by the full microphone in Remote mode.
	Signals not received.	The antenna is dislocated or loosened. The coaxial cable is dislocated or loosened.
	No received audio is heard.	While the tone squelch is operating, the received audio cannot be heard unless the identical tone squelch frequency is used. Check the external speaker connections. Check the volume control position. The Paging mode or Code Squelch mode has been set. Check Set modes 05 and 06.
	Received audio is too low	Sub-band muting has been selected
	The volume cannot be adjusted with the microphone.	The control knob on the main body is not at the Remote position. (It has not been turned fully counterclockwise)
Transmission System	Transmitter power output is low.	Mismatch in antenna system. Low Power mode has been selected. The antenna is dislocated or loosened. The antenna is not connected or has loosened.
Repeater System	The repeater station cannot be accessed.	The tone frequency is different. The repeater station is too far. The offset frequency is different. The shift direction is different.
	"OFF" is displayed on the display lock.	The shifted frequency is off-band.
Scan System	The equipment does not scan.	The SQL knob has been turned fully counterclockwise. Adjust the SQL knob.
	Memory is not scanned.	Memory is not scanned unless frequencies have been stored.
	The program is not scanned.	A start frequency and end frequency have not been set.

	Trouble	Major Cause and Remedy
Memory System	All memory cannot be cleared.	The "normal reset" method has been used to reset.
	Specific memory cannot be cleared or rewritten. Memory cannot be written.	Memory protect has been selected
Paging System	Paging does not function	The CTD5700 (DTMF Unit) has not been installed. For paging, it is necessary to store the code. Your code does not match the remote code. A signal from the remote or local station does not arrive.
	"E" is displayed on the display block	Remote code read error indication
	The code has not be set.	The CTD5700 (DTMF Unit) has not been installed.
DTMF System	No DTMF signal is sent.	The code must be set in advance. The CTD5700 (DTMF Unit) has not been installed.
Others	No beep sound is heard.	Beep-off has been selected.

OPTIONS

The following options are provided to allow a wider range of transceiver applications:

- | | |
|---|---|
| CMP843A: Full remote-control microphone & speaker | CMP842: Remote-control microphone & speaker |
| CRC5700A: Control head | CAX5700: Separate cover |
| CSK12: External speaker | CMU181: Memory unit (20 channels each) |
| CMU182: Memory unit (100 channels each) | CAW570: Dual microphone cable |
| CAW571: Microphone extension cable (2 m long) | CAW572: Microphone extension cable (4 m long) |
| CAW573: Remote cable (2 m long) | CAW574: Remote cable (4 m long) |
| CAW575: Extension power cable (5 m long) | CAW578: Remote cable (8 m long) |
| CAW579: Adapter cable | CMR5700: Mobile bracket |
| CMB5710: Mobile bracket | |

※ For proper usage of each option, read its instruction manual thoroughly.

AFTER-SALE SERVICE

<Guarantee>

The guarantee period for this product is one year.
A guarantee card comes with this product.
Read the contents of the guarantee card and keep the card in a safe place.
We may charge you for a repair even during the guarantee period. please understand the guarantee.

<Maintenance>

After the guarantee period expires, we will repair the product for a charge as requested. Please note that the repair may be expensive, depending on the repair.

<In Case of Trouble>

Read the "Troubleshooting" section thoroughly and check the faulty condition again. If the equipment still does not function properly, consult our dealer or our office/service center.

RATINGS

1. General Specifications

Transmission/reception frequency VHF: 144.000 to 147.995 MHz
UHF: 438.000 to 449.995 MHz

Transmission type F2, F3
Rated voltage 13.8 V DC \pm 15%
Current consumption
C5718DA 1 At transmit (Hi) 11.0 A
2 At transmit (Mid) 6.0 A
3 At transmit (Low) 4.5 A
4 At wait and receive 0.9 A

Microphone input impedance 600 Ω
Low-frequency output impedance 4 Ω
Antenna impedance 50 Ω
Working temperature range -20°C to +60°C
Frequency stability \pm 3 ppm
Antenna connector M type (with cable)
Grounding method Negative grounding

Dimensions (W x H x D) 140 x 40 x 135mm
Weight 1.0 kg

2. Reception

Receiving system Double superheterodyne
Intermediate frequency
144 MHz band 1st IF 44.95 MHz (upper)
2nd IF 455 kHz (lower)
450 MHz band 1st IF 23.05 MHz (lower)
2nd IF 455 kHz (lower)

Receiving sensitivity
(12 dB SINAD) -8dB μ (0.201 μ V)
Selectivity 12 kHz or more (-6 dB)
24 kHz or less (-60 dB)
Squeech open sensitivity -11 dB μ (0.141 μ V)
Low-frequency output 3.0 W (at 10 % distortion)
S/N ratio at 0.5 μ V input 30 dB or more

3. Transmission

Transmission output 144 MHz band Hi: 50 W
Mid: 10 W
Low: 3 W
450 MHz band Hi: 40 W
Mid: 10 W
Low: 3 W

Modulation method Reactance modulation
Max. frequency deviation \pm 5 kHz
Spurious radiation strength -60 dB
Modulation distortion 3% or less (at 70% modulation)

*to "Don't Allow an
Any override into
memory write.
No PROG. Scan scans entire
band.
No Hi/Low Scan Speed*

● The specifications and appearance of this equipment are subject to change without prior notice.

INDEX

4557625
16125

956

1 MHz scan	52	Offset Frequency	58
All reset	63	Optional cable	80
All scan	52	Paging	70
Antenna	11,12	Pause scan	50
Band	17	Power cable	10
Band-off	60	Power source	14
Beep sound	62	Priority	53
Block	53	Priority scan	53
Block memory scan	53	PTT lock	60
Bracket	8	Receiving	18
Busy scan	50	Remote-control microphone	28
Call frequency	33	Repeater	56
Code squelch	72	Reset	63
Control hood	9	Reverse	57
Dimmer	20	RF meter	23
Direct input	32	RF squelch	39
Display block	23	S meter	23
Frequency band	17	Scan	50
Frequency step	30	Scan speed	54
Full remote-control microphone	25	Set mode	64
Group code	69	Simplex application	56
High power	40	Squelch	16
Hold scan	50	Squelch-off	38
Individual code	69,70	Sub band	17
Key lock	36	Tone encoder	68
Low power	40	Tone squelch	68
Main band	17	Transmission output	40
Main dial	21	Transmitting	19
Medium power	40	VFO link	60
Memory	42	VFO reset	63
Memory reset	63	Volume	15
Memory scan	53		
Mute	61		