

# TRIPLE BAND

50MHz / 144MHz / 440MHz FM TRANSCEIVER

## **C5900DA** **C5908DE**

### **OWNER'S MANUAL**

---

Thank you for purchasing our transceiver.

For proper use of your transceiver, please read this manual thoroughly.

Keep this manual in a safe place for reference at a later date.

Page 3  
INSTALLATION

Page 9  
BASIC OPERATIONS

Page 19  
ADVANCED OPERATIONS

Page 25  
MEMORY FUNCTIONS

Page 31  
HYPER MEMORY FUNCTIONS

Page 35  
SCAN

Page 43  
REPEATER OPERATIONS

Page 47  
ADDITIONAL FUNCTIONS

Page 53  
USING THE ACCESSORIES

Page 65  
PACKET OPERATIONS

Page 69  
REFERENCES

## ■ How to use this manual.

● This transceiver covers 50 MHz, 144 MHz and 440MHz bands. This manual's descriptions are based on the UHF (440 MHz band) of C5900DA

● This manual uses the following symbols.

**P** Reference to another page

**F** Function mode

**FB** Function Blink mode

## ■ After unpacking, make sure that the following items are included.

1. Owner's manual .....	1	8. Microphone hunger .....	1
2. Block diagram .....	1	9. Spare fuses (12A) .....	2
3. Microphone (CMP883) .....	1	<del>10. DTMF unit CTD5700 .....</del>	<del>1</del>
4. Transceiver.....	1	(Attached to the main body.)	
5. Power supply cable .....	1	12. CTCSS tone squelch unit CTN5700 .....	1
6. Mounting bracket .....	1	(Attached to the main body.)	
7. Mounting screws for mobiles bracket			
Bolts (M4 mm x 8 mm) .....	4		
Bolts (M5 mm x 20 mm) .....	4		
Nuts (M5 mm) .....	4		
Flat washers (M5 mm) .....	8		
Lock washers (M5 mm) .....	4		
Tapping screws (M5 mm x 15 mm) .....	4		
Hexagon Wrench .....	1		

# Table of Contents

---

## **INSTALLATION** **3**

---

Precautions .....	4
Mounting the Transceiver and Bracket .....	5
Installing the mounting bracket .....	5
Installing the transceiver .....	5
Connecting the power supply cable .....	6
Connecting the microphone .....	7
Connecting the external speaker .....	7
Connecting the control head .....	7
About the optional cables .....	7
Attaching the Antenna .....	8

## **BASIC OPERATIONS** **9**

---

Turning the Power On .....	10
Adjusting the Volume .....	10
Adjusting the Squelch .....	10
Selecting the Main Band .....	11
Changing the band .....	11
VFO mode .....	12
Receiving .....	12
Transmitting .....	13
Reset Modes .....	13
Operation and Function of Parts .....	14

## **ADVANCED OPERATIONS** **19**

---

Using the CALL Frequency .....	20
Changing the CALL Frequency .....	20
Storing Associated Settings with the CALL Frequency .....	21
Improving Performance during Poor Reception (Squelch OFF) .....	21
Setting the Transmitting Power .....	21
Deleting Unused Bands (Band OFF) .....	21
Using the Key Lock .....	22
Using the Selector in Key Lock Mode .....	22
Changing the Frequency Step .....	22
Changing the Frequency in 1MHz Steps .....	23
Changing the Set Mode Function (MY key) .....	23

## **MEMORY FUNCTIONS** **25**

---

The Memory Mode .....	26
Storing Memory .....	26
Displaying Memory Contents .....	27
Changing the Memory Contents .....	27
Erasing the Memory .....	28
Copying a Memory from one to another .....	28
Saving Settings in a Memory .....	28
Protecting Memory (Memory Protect) .....	29
Saving the Memory (Memory Backup) .....	29
Storing the Scan Type in a Memory .....	29
Inserting or Removing a Memory Unit .....	30

## **HYPER MEMORY FUNCTIONS** **31**

---

The Hyper Memory Function .....	32
Displaying a Hyper Memory .....	32
Saving Hyper Memory in Manual Mode .....	33
Switching between Auto and Manual Mode .....	33
Saving Hyper Memory in Auto Mode .....	33

## **SCAN** **35**

---

The Scan Function .....	36
Changing the Scan Type .....	36
Changing the Scan Speed .....	36
Scanning within 1MHz (1MHz Scan) .....	37
Scanning the Entire Bandwidth (All Scan) .....	37
Changing the Resume Time of Busy Scan .....	37
Scan a Specific Range (Program Scan) .....	38
Scanning Frequencies in Memory (Memory Scan) .....	39
Scanning a Block of Memory Address (Block Memory Scan) .....	39
Scanning a Specific Memory Address (Program Memory Scan) .....	40
Scanning Specific Memory Frequencies (Memory Scan Memory) .....	41
Scanning the CTCSS Tone Frequency (Tone Squelch Scan) .....	41

# Table of Contents

---

## **REPEATER OPERATIONS 43**

---

The Repeater Function .....	44
Using Repeater Mode (Auto Repeater Mode) .....	44
Cancelling Auto Repeater Mode .....	44
Setting Repeater Mode Manually .....	44
Receiving a Station Directly in Repeater Mode (Reverse) .....	45
Changing the Offset Frequency and CTCSS Tone Frequency for Repeater Mode .....	45
Using a Repeater which requires a 1750 Hz Tone Burst Signal .....	46

## **ADDITIONAL FUNCTIONS 47**

---

Removing the Band Limit .....	48
Preventing Unintentional Transmission (PTT Lock) .....	48
RF Squelch .....	48
Changing the Frequencies on Both Sides of the Display Simultaneously (VFO Link) .....	49
Changing the Display Brightness (Dimmer) .....	49
Changing the Volume of the Beep .....	49
Setting the PTT Beep Transmission (Stand-by Beep) .....	50
Stopping the Transmission Automatically (Time-Out Timer) .....	50
Muting the Opposite Band Automatically (Auto Mute) .....	50
Muting the Sub-band (Sub-band Mute) .....	50
Turning the Power off Automatically (Auto Power Off) .....	51
Setting the Cross-band Repeater .....	51
Setting the Auto AM Reception Mode .....	51
Setting the AM Reception Mode Manually .....	51

## **USING THE ACCESSORIES 53**

---

Enter the Frequency Directly with the Microphone .....	54
Code-Squelch and Paging .....	54
Setting the Code-squelch code .....	55
Using the Code-squelch .....	55
Setting Individual Code for Paging .....	55
Setting Paging Codes for Other Stations .....	56
Setting a Group Code .....	56
Transmitting a Paging Signal .....	57
Receiving a Paging Signal .....	57

Delayed Code-squelch/Paging Send Time .....	58
Changing the Beeps in the Paging mode .....	58
Using DTMF Code .....	58
Transmitting a DTMF Code from the Microphone .....	58
Storing the DTMF Code in Memory .....	59
Changing a DTMF Code Stored in Memory .....	59
Sending a DTMF Code from a Memory .....	60
Erasing the DTMF code .....	60
Changing the Interval Sending Time of the DTMF Code ..	60
Setting the DTMF Control .....	61
Receiving the DTMF Control code .....	61
Changing the Frequency by DTMF Control .....	61
Using Tone Squelch (CTCSS) .....	62
Using the Tone Encoder and Tone Squelch .....	62
Changing the Frequency of the Tone Signal .....	62
Using the CAW590 Series Optional Cable .....	63

## **PACKET OPERATIONS 65**

---

Data Packet Transmission .....	66
1200 bps Data Packet Transmission .....	66
High Speed 9600 bps Data Packet Communication .....	67
Switching between 1200 and 9600 bps .....	67
Selecting the Band to Receive Packet Data .....	67

## **REFERENCES 69**

---

Troubleshooting .....	70
List of the Set Mode functions .....	71
Options .....	72
Specifications .....	73
Index .....	74

# INSTALLATION

Precautions .....	4
Mounting the Transceiver and Bracket .....	5
Installing the mounting bracket .....	5
Installing the transceiver .....	5
Connecting the power supply cable .....	6
Connecting the microphone .....	7
Connecting the external speaker .....	7
Connecting the control head .....	7
About the optional cables .....	7
Attaching the Antenna .....	8

# Precautions

## Installation location

For proper operation of your transceiver, please follow the guidelines listed below.

- Avoid exposing the transceiver to high temperature, humidity or dust. Avoid a location with direct exposure to sunlight. Install the transceiver in a dry well-ventilated area.

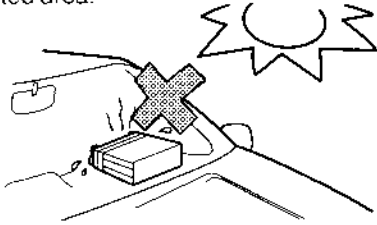

- In order to keep the transceiver cool, provide sufficient space in back and underneath the transceiver to permit the radiating fins to operate properly. It is normal for the transceiver's main unit may get warm if used for a long period of time.

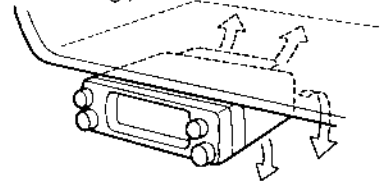

## Dashboard mounting

- It is recommended that the transceiver be mounted under the dashboard, on the side of the glove box or under the instrument panel.

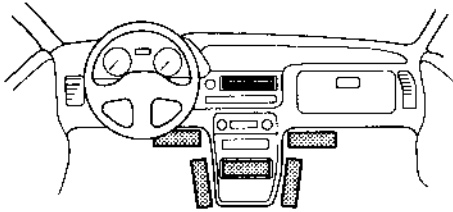

- Mount the transceiver so the back of the transceiver does not touch any material that could be damaged by heat. Install the transceiver in a place free of excessive vibrations.

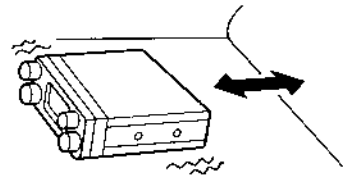

**CAUTION:** Never install the transceiver in the following places;

- Near air conditioner outlet vents
- Exposed to direct sunlight
- Places with excessive
- Near electronic circuits
- Places where the transceiver may affect safety driving

## Power supply

- The transceiver is designed for vehicles with 12 VDC electrical systems. It cannot be used in vehicles with 24 VDC electrical systems.
- Never connect the transceiver to Alternating Current (AC). This will damage to the transceiver.

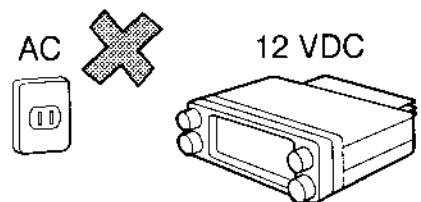
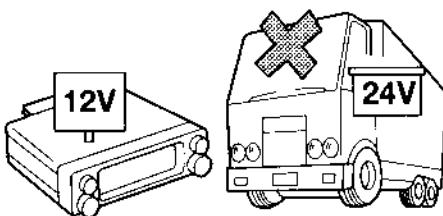

# Mounting the Transceiver and Bracket

## Installing the mounting bracket

Install the mounting bracket where it can be firmly attached. Use the hardware included

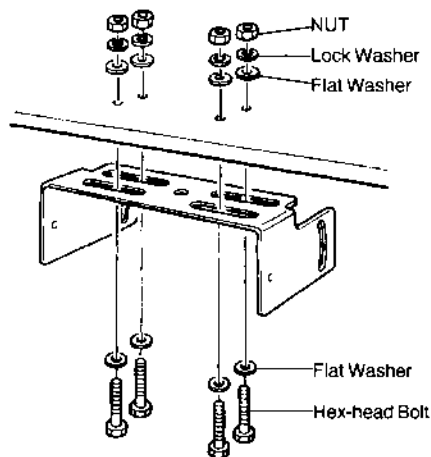

- 1 Drill holes of  $\varnothing 5.2$  to 5.5 mm for M5 mm hex-head bolts.

Drill holes of  $\varnothing 4.0$  to 4.3 mm for M5 mm self-tapping screws.

- 2 Pass the M5 mm hex-head bolts through the flat washers. Next, install the bracket with flat washers, lock washers and nuts or pass the M5 mm self-tapping screws through the flat washers and tighten.

## Installing the transceiver

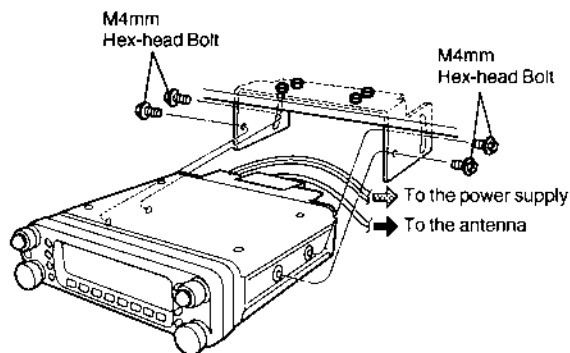

- 1 Connect the antenna to the coaxial cable connector on the rear panel of the main body.

- 2 Insert the main body in the mounting bracket and tighten the M4 mm bolts.

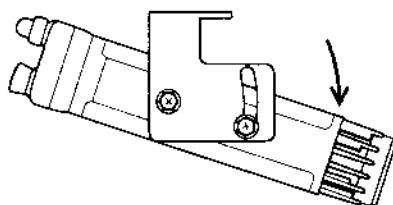
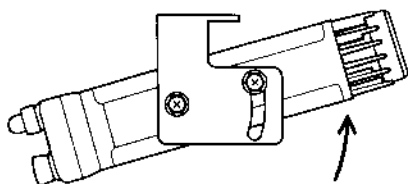

Connecting the power supply cable

For Vehicle

The transceiver requires power from the vehicle's 12 VDC battery.

Use the power supply cord in the accessory package to connect the battery to the transceiver.

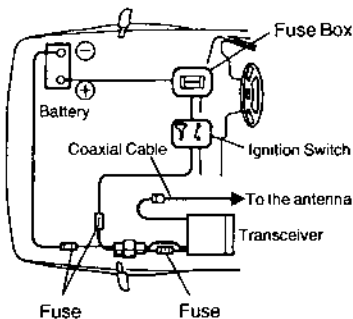
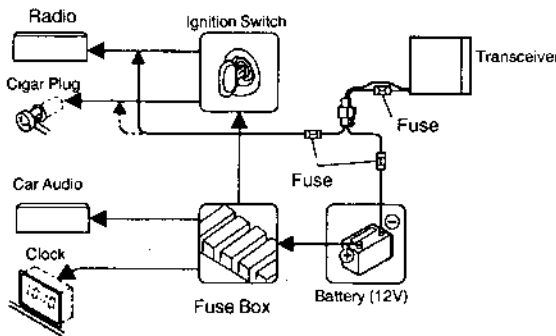
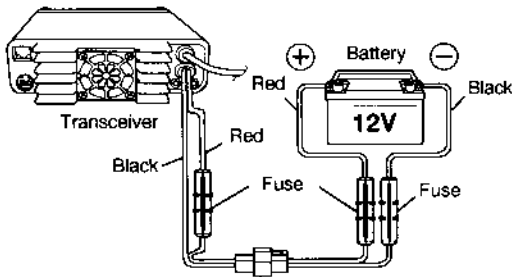
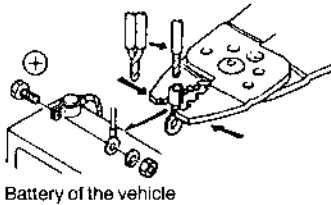

- 1** Before connection, disconnect the negative "-" terminal of the battery.  
This prevents a short circuit.
- 2** Connect the red wire of the transceiver to the positive terminal of the battery. Firmly tighten the battery terminal.
- 3** Connect the black wire of the transceiver to the negative terminal of the battery. Firmly tighten the battery terminal.
- 4** Connect the power connector on the main body to the connector on the power supply cable.

Advice

- If the supplied cable is not long enough, use the CAW575 or CAW576 optional power cable.

CAUTION

- When using the transceiver in vehicle with a 24 VDC electrical system, a DC-DC converter to convert 24 VDC to 12 VDC must be used.
- If the vehicle is not used for a long period of time, disconnect the power supply cable.
- The transceiver requires 12 A fuses.



## For a Fixed Station

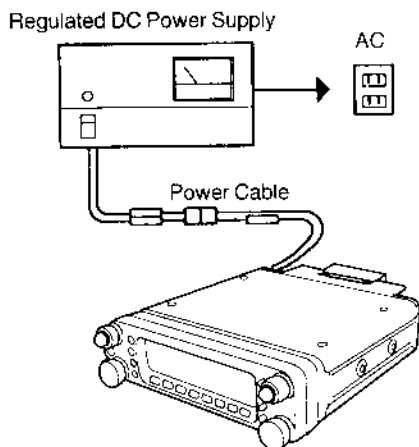

When using the transceiver as a fixed station, use a regulated DC power supply, such as:

DC output: 13.8 V  
Output Current: 12.0 A or more

### Connecting the microphone

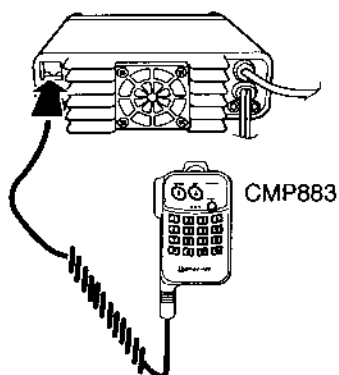

- Turn the transceiver off before connecting the microphone.

### Connecting the external speaker

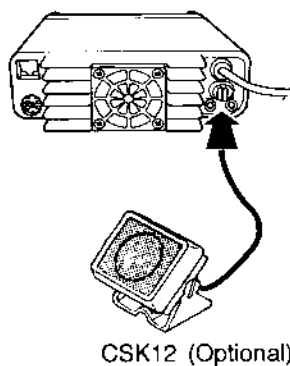

- The external speaker terminal is only used for the external speaker. Do not connect an earphone or other equipment.
- Refer to "Operation and Function of Parts". (P 16)

### Connecting the control head

Refer to "Inserting or Removing the Memory Unit". (P 30)

### About the optional cables

Refer to "Using the Optional Cables". (P 63)

**Attaching the Antenna**

**For Vehicle**

The performance of the transceiver depends on the type of antenna used. Select an antenna that matches your operating requirements.

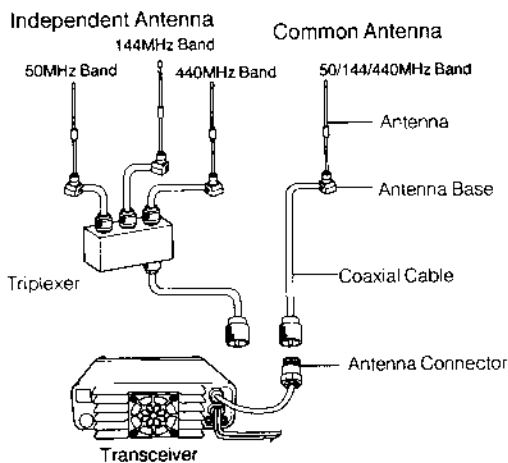

When using a common antenna:

The transceiver has a built-in triplexer. Therefore, a common antenna for 50/144/440MHz band can be used.

When using a independent antenna:

When independent antennas are used, a duplexer, triplexer or coaxial switch must be used to select the antenna.

**CAUTION**

- The antenna must match the band used. Do not transmit on bands that do not match the antenna. If unmatching bands are used, the transceiver may be damaged.
- Adjust VSWR of the antenna to 1.5 or less. Never use the transceiver when VSWR is over 1.5 in succession. This will cause the transceiver is protection circuit to reduce transmission power and may damage the transceiver.
- Never use damaged or broken cables.
- When mounting an antenna base, connect a ground between the base and the automobile body. This is not needed for antennas that do not require a ground place.

**Attaching a Fixed Antenna**

To properly install the antenna, refer to the antenna installation manual supplied with the antenna.

The following example is for home installation. For more detail, consult your dealer.

To water-proof the connectors, first tightly wrap the connector with double-sided adhesive tape, then wrap single-sided vinyl tape over it.

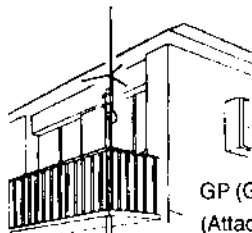

GP (Ground Plane) Antenna  
(Attached to a porch)

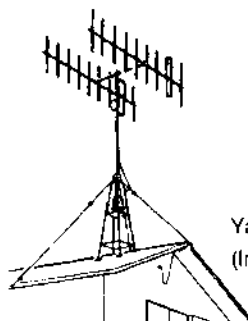

Yagi Antenna  
(Installed on a roof)

**CAUTION**

- Check all support lines to make sure the antenna does not damage surrounding buildings or people if it falls or is blown down by strong winds.
- KEEP the coaxial cable length to the antenna.

# BASIC OPERATIONS

Turning the Power On .....	10
Adjusting the Volume .....	10
Adjusting the Squelch .....	10
Selecting the Main Band .....	11
Changing the band .....	11
VFO mode .....	12
Receiving .....	12
Transmitting .....	13
Reset Modes .....	13
Operation and Function of Parts .....	14

## Turning the Power On

On the control head

- 1 Press the **[PWR]** key.



- 2 Confirm the display is illuminated.

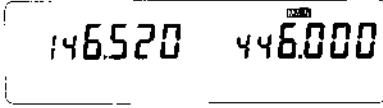

- 3 To turn the power off, press the **[PWR]** key.



- 4 Confirm the display extinguishes.

On the microphone

- 1 Press the **[POWER]** key.



- 2 Confirm the display is illuminated.

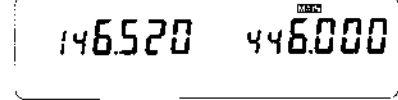

- 3 To turn the power off, press the **[POWER]** key.



- 4 Confirm the display extinguishes.

## Adjusting the Volume

- 1 Turn the VOL knob clockwise to increase the volume.

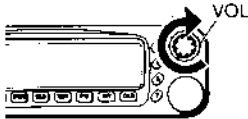

- 2 Turn the VOL knob counterclockwise to decrease the volume.



### Advice

- When the receiving station is heard, adjust the volume accordingly.
- Or, press the **[SQL.OFF]** key on the microphone to adjust the volume. When noise is emitted adjust the volume accordingly. Press the **[SQL.OFF]** key after adjusting.

## Adjusting the Squelch

- When the transceiver is not receiving a signal, it makes a static like noise. The squelch function is used to eliminate this noise.

- 1 Fully turn the SQL knob counterclockwise. (noise is emitted)

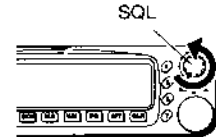

- 2 Slowly turn the SQL knob clockwise.

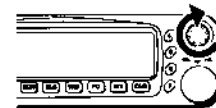

- 3 Stop turning the knob when the noise disappears.

### Advice

- The condition where noise is emitted is called "squelch off". When using the SQL knob to eliminate noise it is called "squelch on".
- If the squelch level is increased, weak signals may not be received.
- The squelch off function prevents the squelch from interrupting weak signals.
- The transceiver has the RF-squelch function. The squelch is opened when the signal strength exceeds the level set by this function.

## Selecting the Main Band

One band can be selected as the "MAIN" band. Changing the frequency, transmitting and other basic functions are done in the main band. The main band can be switched from the Left band to the Right band.

### On the control head

- 1 Press the SQL knob to select the band.

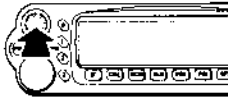

- 2 Confirm "MAIN" display is switched.

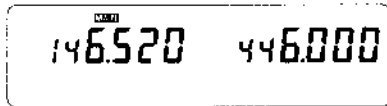

### On the microphone

- 1 Press the [BAND] key.



- 2 Confirm "MAIN" display is switched.

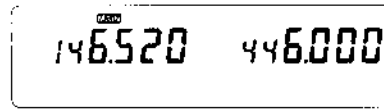

### Advice

- The band not selected is called the sub-band.
- Three high-pitched beeps are emitted when the Left band is set as the main band. One high-pitched beep is emitted when Right band is set as the main band.
- Each band can be set as follows;
  - Left band
    - 50 MHz band: 50.000 to 53.995 MHz
    - 144 MHz band: 144.000 to 147.995 MHz
    - 440 MHz band: 420.000 to 449.995 MHz (C5900DA)
  - Right band
    - 144 MHz band: 144.000 to 147.995 MHz
    - 440 MHz band: 420.000 to 449.995 MHz (C5900DA)

## Changing the band

The Left band can be changed to 50 MHz, 144 MHz or 440 MHz. The Right band can be changed to 144 MHz or 440 MHz. Both bands can be set to 144 MHz or 440 MHz.

- 1 Press the SQL knob to select the main band.



- 2 Confirm "MAIN" is displayed.

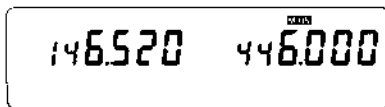

- 3 Press and hold the SQL knob for 0.6 second or more to change the band.

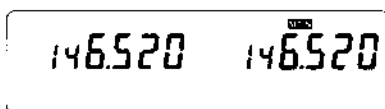

### Advice

- The sub-band cannot receive while main band is transmitting in following states. The left side and right side are set on the same band. The Left band is set to 440 MHz and Right band is set to 144 MHz. If this occurs "MUTE" is displayed in the sub-band.
- When the same signal is received on both bands at same time, the signal meter level may differ.
- A combination signal between the Left and Right band may be received but not indicated on the display.
- The CMP883 microphone can be used to directly input the frequency.
- The transceiver has a function that goes beyond the band. When this function is activated, the band can be changed to the next band by turning the selector or pressing the [UP] / [DOWN] key.

## VFO mode

The VFO (Variable Frequency Oscillator) is the mode in which frequencies can be changed using the selector or pressing the **[UP]**/**[DOWN]** keys. This is the mode of the transceiver when shipped and immediately after resetting.

- 1 Press the SQL knob to select the main band.



- 2 Confirm the main band indicator.

- 3 If "M" is displayed (memory mode), press the **[V/M ENT]** key. If "CAL" is displayed (call mode), press the **[V/M ENT]** key. If " " is blinking (scan mode), press the **[V/M ENT]** key. If set mode is displayed, press the **[CLR SET]** key to cancel set mode. Then, press the **[CLR SET]** key to return the VFO mode

- 4 Confirm the VFO mode.

### Advice

- Reset the VFO if there is difficulty returning to the VFO mode. The VFO reset, returns all state to the initial state except the memory.
- Press the **[CLR SET]** key to return to the VFO mode as the displayed frequency in memory or call mode.
- Turn the selector to return to the VFO mode as the displayed call frequency.

## Receiving

Receiving is the process of setting a desired frequency and receiving transmissions. This transceiver has a selector on each side. Therefore, the frequency can be changed without selecting a main band.

### On control head

- 1 Set to the VFO mode.

- 2 Turn the selector clockwise to increase the frequency.



- 3 Turn the selector counterclockwise to decrease the frequency.



### On the microphone

- 1 Press the **[BAND]** key to select the band.



- 2 Set to the VFO mode.

- 3 Press the **[UP]** key to increase the frequency.



- 4 Press the **[DOWN]** key to decrease the frequency.



### Advice

- The CMP883 microphone can be used to enter the frequency directly.
- The frequency can be rapidly changed in succession by holding down the **[UP]** or **[DOWN]** keys.

## Transmitting

By setting the transceiver to a desired frequency and pressing the **[PTT]** switch, you can communicate directly with other stations.

- 1 Press the SQL knob to select the main band.



- 2 Set to the VFO mode.

- 3 Set the desired frequency.

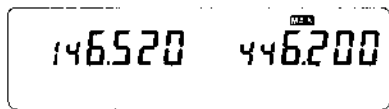

- 4 Before transmitting, confirm the frequency is not being used by other stations.

- 5 Hold down the **[PTT]** switch and speak into the microphone.



## Reset Modes

Use one of the following four methods to reset settings to the original factory (default) state.

### All Reset

All settings are reset to the original factory state.

Display: **rES ALL**

### VFO Reset

The VFO, CALL Frequency, Set Mode and other settings are reset to the original factory state. (Memory and Hyper Memory settings are not reset.)

Display: **rES nor**

### Memory Reset

Only the Memory settings are reset to the original factory state. When the CMU161 unit is mounted, the CMU161 is initialized. (The VFO and Hyper Memory settings are not reset.)

Display: **rES MR**

### Hyper Memory + VFO Reset

The Hyper Memory and VFO settings are reset to the original factory state. (Memory settings are not reset.)

Display: **rES H.M. n**

### Resetting the Memory Unit

The CMU161 memory unit (address 080 to 199) only is reset. (The internal memory (address 000 to 079) is not reset.)

Display: **EE For MRt**

- 1 Turn the power off.

- 2 Hold down the **[F]** key and press the **[PWR]** key to turn the power on.



- 3 Turn the selector to choose a reset mode.

- 4 Press the **[V/M ENT]** key.



- 5 Confirm that the display is in its original state.

### Advice

- If a mistake has been made with the settings, reset the VFO settings first.
- Memory cannot be reset if the Protect Memory function (P.26) is on.
- After purchasing, the optional CMU161 memory unit, reset it before programming.
- It is not necessary to turn the power to the transceiver off and on again after performing a reset.
- If a reset operation is interrupted while it is being done, turn the power to the transceiver off and on again to return to the original settings.

# Operation and Function of Parts

The operation and function of the parts of the control head are as follows:

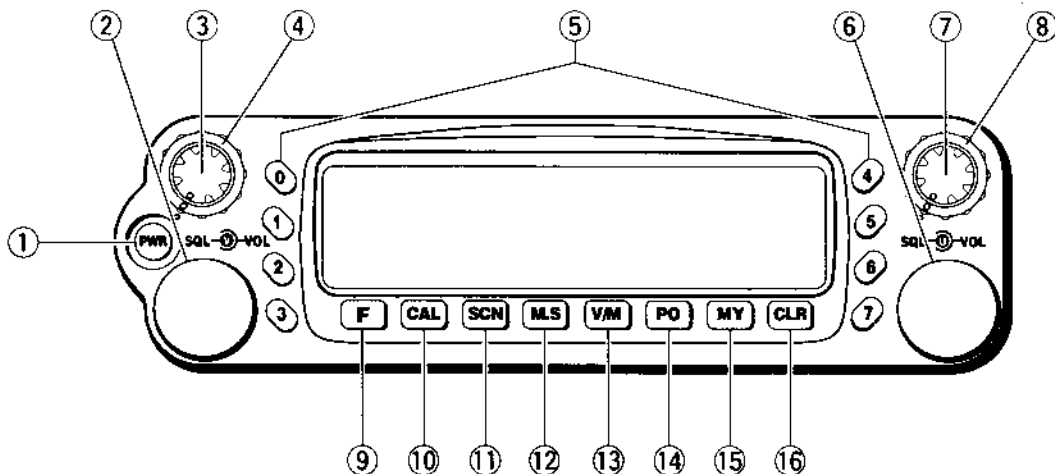

## ① PWR

- To turn the power on and off.
- When the power is off, hold down the function key while pressing this key to enter the Reset mode.

## ② Rotary Channel Selector (Left band)

- To change the frequency of the Left band.
- To turn on and off or select various settings.
- Press this knob once to change the frequency in 1 MHz steps. Press the knob again to return to the original frequency.
- This knob is referred to as the "Selector" in this manual.
- **[FB]**: Press this knob to set and cancel the DTMF control.

## ③ SQL Knob (Left band)

- To adjust squelch of the Left band.
- If this knob is pressed, the main band is set to the Left band.
- If this knob is held down for 0.6 second or more, the frequency band can be switched.

## ④ VOL Knob (Left band)

- To adjust the volume of the Left band.

## ⑤ 0 to 7

- These keys call the contents of Hyper Memory (HM).
- These keys are referred to as the "HM Keys" in this manual.

## ⑥ Rotary Channel Selector (Right band)

- To change the frequency of the Right band.
- It is also used to turn on and off or select various settings.
- Press this knob once to change the frequency in 1 MHz steps. Press the knob again to return to the original frequency.
- This knob is referred to as the "Selector" in this manual.
- **[FB]**: Press this knob to set and cancel the DTMF control.

## ⑦ SQL Knob (Right band)

- To adjust squelch of the UHF band.
- If this knob is pressed, the main band is set to the UHF band.
- If this knob is held down for 0.6 second or more, the frequency band is changed.

## ⑧ VOL Knob (Right band)

- To adjust the volume of the Right band.

## ⑨ F

- Press this key to enter function mode. This causes the red characters on the top part of each key to light. If no key is pressed within 3 seconds, function mode is canceled.
- Function mode is indicated by **F** in this manual.
- Hold this key down for more than 1 second to enter function blink mode. This causes the red characters on the top part of each key to blink. If no key is pressed within 10 seconds, function blink mode is cancelled.
- Function Blink mode is indicated by **[FB]** in this manual.



⑩ CAL C.SQ

- displays/cancels the CALL Frequency function.
- **F**: Sets and cancels Code Squelch mode.
- **[FB]**: Sets the Code Squelch code.

⑪ SCN P.S

- Starts and stops 1MHz scan and the program scan function.
- **F**: Sets and cancels the frequency range for the program scan.

⑫ MS MS.M

- Starts and stops memory scan.
- **F**: Sets and cancels the memory for memory scan.
- **[FB]**: Sets the memory to be used for memory scan.

⑬ V/M ENT

- Switches between VFO and Memory mode.
- **F**: Write to memory. (VFO)
- **F**: Change the contents of memory. (Memory Mode)
- **F**: Change to call frequency. (CALL Frequency)
- **F**: Change the set mode. (Set Mode)
- **[FB]**: Copy the contents of memory to a different address. (Memory Mode)

⑭ PO T.SQ

- Changes the transmitting power.
- **F**: Sets and cancels the CTCSS encoder/decoder.
- **[FB]**: Sets the CTCSS frequency for tone squelch.

⑮ MY RPT

- Selects to the set mode stored in MY key. (The original settings is Key Lock)
- Stores the setting for MY key. (Press the key for 1 second in set mode to record the setting.)
- **F**: Sets and cancel repeat mode.
- **[FB]**: Sets the tone frequency and offset frequency for repeat mode.

⑯ CLR SET

- Cancels the various functions or operations.
- **F**: Selects to Set Mode.
- **[FB]**: Clears the contents of a memory. (Memory Mode)

Control Head Display Indications

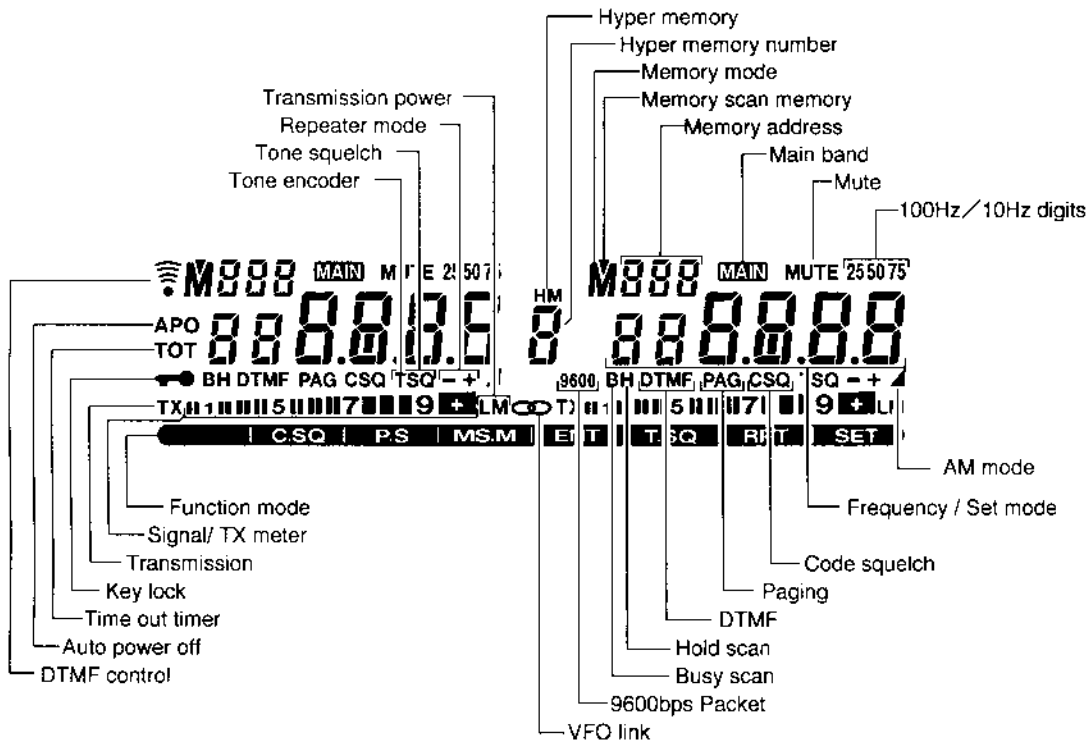

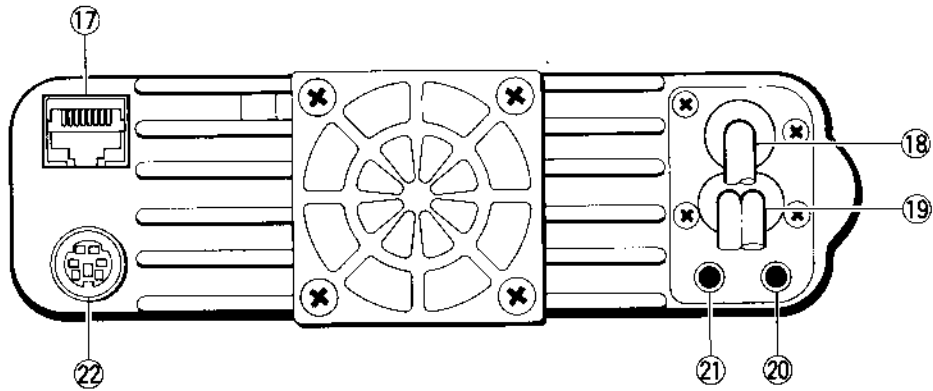

**17 Microphone Jack**

The wiring diagram is below.

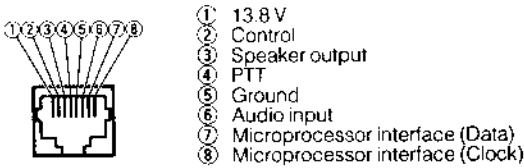

**CAUTION**

- 13.8 VDC is present at pin-1 of the microphone.
- If a microphone other than the CMP883, are to be used, pin-1, pin-7 and pin-8 must not be connected. Connecting these pins could result in damage to the transceiver.
- Only the CMP883 microphone should be used with C5900D series transceiver. Incorrect connections could result in damage to the transceiver and microphones.

**18 Antenna Connection**

(For 50/144/440MHz antennas)

**19 Power Supply Connection (13.8V DC)**

**20 External Speaker Jack (Right band)**

- When an external speaker is connected to the Right band jack only, the output from both the Left and Right bands can be heard on the external speaker. The internal speaker cannot be used when an external speaker is connected.
- If external speakers are connected to both the Left and Right bands jacks, the Left band is heard on the speaker connected to the Left band and the Right band is heard on the speaker connected to the Right band.

**21 External Speaker Jack (Left band)**

- When an external speaker is connected to the Left band terminal only, the output from the Left band can be heard on the external speaker. The Right band can be heard on the internal speaker.
- If external speakers are connected to both the Left band and Right band terminals, the Left band is heard on the speaker connected to the Left and the Right band is heard on the speaker connected to the Right band.

**22 Packet Connection Jack**

## Operation and Function of Parts on the Microphone

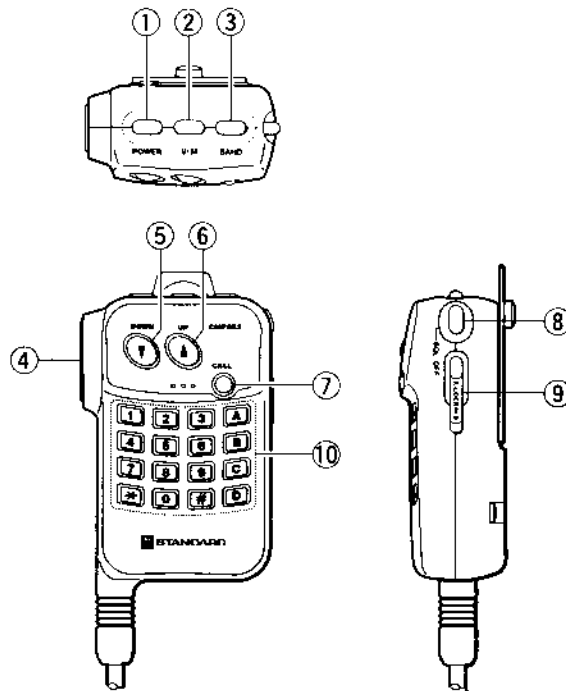

CMP883

**① POWER**

- When pressed, turns the power on and off.

**② V/M**

- Switches between VFO mode and Memory mode.

**③ BAND**

- Switches the main band.

**④ PTT**

- While pressed, transmits on the main band.

**⑤ DOWN**

- Moves the frequency or memory address number down.
- Pauses the scan then restarts the scan in the downward direction.

**⑥ UP**

- Moves the frequency or memory address number up.
- Pauses the scan then restarts the scan in the upward direction.

**⑦ CALL**

- Displays and cancels the call frequency

**⑧ SQL OFF**

- When pressed, the main band squelch function is turned off.

**⑨ K - LOCK**

- When in the lower position, the key lock is set. When the key lock is set only the **PTT** and **POWER** keys on the remote control microphone can be used. (The keys on the control head are not locked.)

**⑩ Keypad**

- If pressed during reception, the frequency can be entered directly.
- If pressed during transmission, the DTMF signal can be transmitted directly.
- If the keys 0 - 7 are pressed within 3 second after pressing the # key during reception, the Hyper memory is displayed. If no key is pressed within 3 second after pressing the # key, this function is canceled and a middle-pitched beep is emitted. (When the Hyper memory mode is set manually, the new Hyper memory is not stored using the CMP883 microphone)



# ADVANCED OPERATIONS

Using the CALL Frequency .....	20
Changing the CALL Frequency .....	20
Storing Associated Settings with the CALL Frequency .....	21
Improving Performance during Poor Reception (Squelch OFF) .....	21
Setting the Transmitting Power .....	21
Deleting Unused Bands (Band OFF) .....	21
Using the Key Lock .....	22
Using the Selector in Key Lock Mode .....	22
Changing the Frequency Step .....	22
Changing the Frequency in 1MHz Steps .....	23
Changing the Set Mode Function (MY key) .....	23

## Using the CALL Frequency

CALL frequency is used to display the frequency stored in the Call channel.

### Using the control head

- 1 Select the main band.  
(The Left band should be selected.)
- 2 Press the **[CALCSQ]** key.  
(CAL appears on the display and the call frequency is displayed.)

The digital display shows 'CAL' on the left, 'MAIN' in a small box above the second digit, and the frequency '446.000'.

- 3 To return to the original display, press the **[CALCSQ]** key.  
To return to the VFO mode from call frequency, press the **[CLRSET]** key.

### Using the microphone

- 1 Press the **[BAND]** key to select the main band.  
(The Left band should be selected.)
- 2 Press the **[CALL]** key.  
(CAL appears on the display and the call frequency is displayed.)

The digital display shows 'CAL' on the left, 'MAIN' in a small box above the second digit, and the frequency '446.000'.

- 3 To return to the original display, press the **[CALL]** key.  
To return to the VFO from call frequency, press the **[CLRSET]** key on the control head.

Band	Initial call frequency (MHz)	
	C5900DA	C5908DE
50MHz	52.525	51.000
144MHz	146.520	145.000
440MHz	446.000	433.000

### Advice

- In step 3, the call frequency becomes the VFO frequency when the Selector is turned, or the **[UP]** and **[DOWN]** keys are pressed.
- For the Left band, call frequency displays the frequencies in the 50MHz band when the 50MHz band is displayed and 144MHz band when either the 144MHz or 440MHz band is displayed. For the Right band, call frequency displays the 440MHz band regardless of the band being displayed.

## Changing the CALL Frequency

Used to change the call frequency to a different frequency.

- 1 Select the main band.  
(The Left band should be selected.)
- 2 Press the **[CALCSQ]** key or the **[CALL]** key on the microphone.  
(CAL appears on the display and the call frequency is displayed.)

The digital display shows 'CAL' on the left, 'MAIN' in a small box above the second digit, and the frequency '446.000'.

- 3 Press the **[F]** key, then press the **[V/M ENT]** key.  
(CAL blinks on the display.)

The digital display shows 'CAL' on the left, 'MAIN' in a small box above the second digit, and the frequency '446.000'. The 'CAL' text is underlined to indicate it is blinking.

- 4 Turn the Selector or press the **[UP]** and **[DOWN]** keys to change the frequency.

The digital display shows 'CAL' on the left, 'MAIN' in a small box above the second digit, and the frequency '446.200'.

- 5 Press the **[V/M ENT]** key in the function key mode.  
(CAL on the display changes from a blinking display to a lit display and the frequency changes.)
- 6 To return to the original display, press the **[CALCSQ]** key or the **[CALL]** key on the microphone. To return to the VFO from call frequency, press the **[CLRSET]** key on the control head.

### Advice

- In step 4, when using the CMP883 microphone, the frequency can be entered directly (P.54). Step 5 is then performed automatically.



### Storing Associated Settings with the CALL Frequency

Various settings can be stored with the CALL frequency. These include the Repeater mode, Offset mode, Tone frequency for Repeater mode, Code Squelch mode, Tone Encoder mode, Tone Squelch and Tone frequency for Tone Squelch.

- 1 Select the main band.
- 2 Press the **[CALC.SQ]** key or the **[CALL]** key on the microphone. (CAL appears on the display and the call frequency is displayed.)
- 3 To set the various settings, refer to the section on the specific setting.
  - Repeater mode (P.44)
  - Offset frequency (P.45)
  - Tone frequency for Repeater mode (P.45)
  - Code Squelch mode (P.55)
  - Tone Encoder mode (P.62)
  - Tone Squelch mode (P.62)
  - Tone frequency for Tone Squelch mode (P.62)
- 4 To return to the original display, press the **[CALC.SQ]** key or the **[CALL]** key on the microphone. To return to the VFO from call frequency, press the **[CLR SET]** key on the control head.

### Improving Performance during Poor Reception (Squelch OFF)

When the squelch function is on, the received signal may cut out or be interrupted when the signal is weak. It is possible to temporarily turn the squelch function off in this case.

- 1 Select the main band.
- 2 Press the **[SQL.OFF]** key to turn the squelch function off.
 
- 3 Press the **[SQL.OFF]** key again to turn the squelch function back on.
 

**Advice**

- This operation can also be used to turn the squelch function off in RF Squelch mode, Code Squelch mode, Paging mode and Tone Squelch mode.

### Setting the Transmitting Power

This is used to change the transmitting power. The original factory setting is High Power.

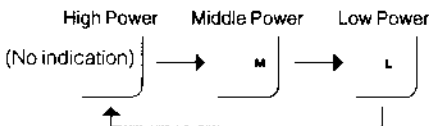
- 1 Select the main band.
- 2 Press the **[P.O.T.SQ]** key to change the transmitting power.
 

**Advice**

- During transmission, the display changes as shown below.

High Power TX ■■■■■5■■■■7■■■9■

Middle Power TX ■■■■5■■■7 M

Low Power TX ■■■■5 L



- The various transmission power is shown below.

High power	Middle power	Low power
45W (50MHz band) 50W (144MHz band) 35W (440MHz band)	10W	3W

- During transmission, the transmitting power can be changed by pressing the **[P.O.T.SQ]** key.

### Deleting Unused Bands (Band OFF)

This is used to delete unused bands, and is referred to as Band OFF.

- 1 Press the **[F]** key for 1 second, or longer. **[FB]**
- 2 Press the SQL knob to select the bands to be deleted.
 
- 3 Confirm that the frequency for the deleted band disappears from the display.
 

**Advice**

- To cancel this function, press the SQL knob for the deleted band.
- Band OFF can not be used simultaneously for both Left and Right bands.

## Using the Key Lock

This function locks the frequency to prevent accidental changes from the keys or the Selector. The setting of Key Lock is different for the control head and the microphone.

### On the control head

- 1 Press the **[F]** key, then press the **[CLR SET]** key. **[F]**

- 2 Turn the Selector and set the Set Mode number to 11.

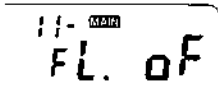

- 3 Press the **[V/M ENT]** key. Change the display from oF to on. (The **oF** mark appears on the display.)



- 4 To complete the setting, press the **[CLR SET]** key.

#### Advice

- To cancel this setting, set the display in step 3 to oF.
- When this setting is on, the **[F]** and **[PWR]** keys can be used, and the **[CLR SET]** key can only be used with the Function mode.
- The factory setting for this function is stored in the MY key. Press the **[MY RPT]** key to switch this function on and off.
- When Key Lock is used with the control head, the Set Mode can only be used to change the Key Lock setting.
- This setting does not apply Key Lock to the microphone.

## Using the Selector in Key Lock Mode

This setting permits the selector to be used in the Key Lock mode.

- 1 Press the **[F]** key, then press the **[CLR SET]** key. **[F]**

- 2 Turn the Selector and set the Set Mode number to 12.

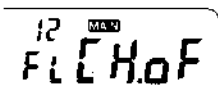

- 3 Press the **[V/M ENT]** key. Change the display from oF to on.

- 4 To complete the setting, press the **[CLR SET]** key.

#### Advice

- To cancel this setting, set the display in step 3 to oF.

### On the microphone

- 1 To set Key Lock, slide the **[K-LOCK]** switch to the down position.



- 2 To cancel Key Lock, slide the **[K-LOCK]** switch to the up position.

#### Advice

- When this function is on, only the **[PTT]** and **[POWER]** functions can be performed.
- This setting does not apply Key Lock to the control head.

## Changing the Frequency Step

The factory frequency step setting changes the frequency by 5kHz when the Selector on the control head is turned or the **[UP]** / **[DOWN]** key on the microphone are pressed. The frequency step can be set to 5, 6.25, 10, 12.5, 15, 20, 25, 30, 50 or 100kHz.

- 1 Select the main band.

- 2 Select the frequency band.

- 3 Press the **[F]** key, then press the **[CLR SET]** key. **[F]**

- 4 Turn the Selector and set the Set Mode number to 01.

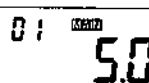

- 5 Press the **[V/M ENT]** key. Change the display from 5.0 as shown below.

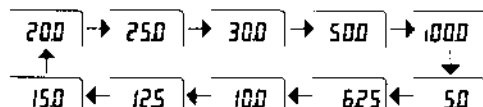

- 6 To complete the setting, press the **[CLR SET]** key.

#### Advice

- The factory default setting is 5kHz.
- A different setting can be programmed for each band.



## Changing the Frequency in 1MHz Steps

The frequency can be changed in 1MHz steps. This step can also be set to change the frequency in 100MHz, 10MHz or 100kHz steps.

### Changing the frequency in 1MHz steps

**1** Press the Selector for the desired band to change in 1MHz steps.

**2** Confirm that the frequency display for less than 100kHz is ---.

445.---

**3** Turn the Selector, or press the **[UP]** or **[DOWN]** keys to change the frequency by 1MHz.

**4** To restore the original step, press the Selector again. The frequency display for less than 100kHz returns to the normal display.

### Changing the frequency in 100kHz steps

**1** Press the **[F]** key, then press the **[CLR/SET]** key.

**[F]**

**2** Turn the Selector and set the Set Mode number to 0?

02 MAIN  
rot 1

**3** Press the **[V/M/ENT]** key. Change the display from 1 as shown below.

1 → 10 → 100 → 0.1

**4** To complete the setting, press the **[CLR/SET]** key.

#### Advice

- In step 3, set the band to the main band when using the **[UP]** or **[DOWN]** keys.

#### Advice

- The factory default setting is 1MHz.

## Changing the Set Mode Function (MY key)

Frequently used Set Mode functions can be stored in the **[MY RPT]** key. The factory default setting stored in this key is Key Lock (D-22).

### Changing the set mode function stored in the MY key

Press the **[MY RPT]** key.  
(The Set Mode changes and the stored function is displayed while the key is held down.)

MY key function display  
11 MAIN  
FL ON

### Storing a set mode in the MY key

**1** Press the **[F]** key, then press the **[CLR/SET]** key.

**[F]**

**2** Turn the Selector and select the Set Mode to be stored.

**3** Press the **[MY RPT]** key for 1 second, or longer.  
(When a Set Mode is stored the transceiver emits a high-pitched tone and "-" appears after the Set Mode number on the display.)

MY key function display  
03 MAIN  
d 10.0F

**4** To complete the setting, press the **[CLR/SET]** key.

#### Advice

- Some Set Modes cannot be stored in MY key. The Set Modes that can be stored in the MY key are listed on page 71. A low-pitched tone is emitted if a Set Mode that cannot be stored is selected in step 3.
- The stored setting returns to the factory setting when an All Reset, VFO Reset or Hyper Memory + VFO Reset is performed. (D-13)
- Set Mode functions that are already assigned to the MY key are marked with "-" after the Set Mode number on the display.



# MEMORY FUNCTIONS

The Memory Mode .....	26
Storing Memory .....	26
Displaying Memory Contents .....	27
Changing the Memory Contents .....	27
Erasing the Memory .....	28
Saving Settings in a Memory .....	28
Copying a Memory from one to another .....	28
Protecting Memory (Memory Protect) .....	29
Saving the Memory (Memory Backup) .....	29
Storing the Scan Type in a Memory .....	29
Inserting or Removing a Memory Unit .....	30

## The Memory Mode

- Often used frequencies can be stored in memory.
- This transceivers memory can store up to 80 frequencies in each band. The memory can be increased with the optional CMU161 memory unit. The increased memory allows an additional 120 frequencies to be stored in each band, making a total of 200 channel frequencies for both the Left and Right bands. (See page 13 for details on resetting the memory unit.)
- The 50, 144 and 440MHz bands for Left, and the 144 and 440MHz bands for Right can be stored in memory.
- The storing and displaying of frequencies from memory is referred to as Memory Mode.
- The number in memory where a frequency is stored is referred to as its memory address. The memory address range is from 000 to 079. If the optional CMU161 memory unit is installed, the memory range will increase to 000 to 199.
- Memory can also store the following settings with each frequency.
  - Repeater mode (P 44)
  - Offset frequency (P 45)
  - Tone frequency for Repeater mode (P 45)
  - Code Squelch mode (P 55)
  - Tone Encoder mode (P 62)
  - Tone Squelch mode (P 62)
  - Tone frequency for Tone Squelch mode (P 62)
  - Memory Scan Memory setting (P 41)
  - Scan type (P 36)
- A memory protect function is used to protect memory settings from accidental change or erasure.
- The contents of the transceiver's internal memory unit, including various settings, memory (memory address 000 to 079) and hyper memory can be saved to the optional CMU161 memory unit. This can be used as memory backup. (P 29)

## Storing Memory

Often used frequencies should be stored in memory.

1 Select the main band and set it to the VFO mode.

2 Select the frequency band

3 Turn the Selector, or press the **[UP]** or **[DOWN]** keys to change the frequency to the frequency to be stored.



446.200 MHz

4 Press the **[F]** key, then press the **[V/M ENT]** key. (The number of an empty memory address is displayed.)

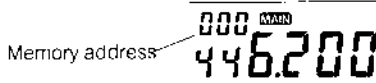

Memory address 000 MHz  
446.200 MHz

5 Turn the Selector, or press the **[UP]** or **[DOWN]** keys to change the number to the memory address you wish to use.



001 MHz  
446.200 MHz

6 Press the **[V/M ENT]** key while in the function mode. (A high-pitched tone is emitted and the frequency is stored in memory.) **[F]**

7 Confirm that the VFO mode is displayed after about 1 second.

### Advice

- In step 3, if there is no empty memory address available a low-pitched tone is emitted (Refer to "Changing the Memory Contents" (P 27) or "Erasing the Memory" (P 28) for details on changing unneeded memory or erasing memory.)
- The memory address numbers displayed in steps 4 and 5 are empty address only.
- In step 5, turning the Selector while pressing it allows the address numbers to be viewed quickly.
- To cancel the setting, confirm that the function mode is not activated in step 6, then press the **[V/M ENT]** or **[CLR SET]** key.

## Displaying Memory Contents

This function is used to display frequency stored in memory.

On the control head

- 1 Select the main band and set it to the VFO
- 2 Press the **[V/M ENT]** key.
- 3 Turn the Selector to select the memory address to be displayed. (The selected memory address is displayed.)

MOD 1 MAIN  
446.200

- 4 To return to the original display, press the **[V/M ENT]** key. To return to the VFO from memory and transfer the contents of the memory to the VFO, press the **[CLR SET]** key.

On the microphone

- 1 Select the main band and set it to the VFO
- 2 Press the **[V/M]** key.
- 3 Press the **[UP]** or **[DOWN]** keys to select the memory address to be displayed. (The selected memory address is displayed.)

MOD 1 MAIN  
446.200

- 4 To return to the original display, press the **[V/M]** key. To return to the VFO from memory and transfer the contents of the memory to the VFO, press the **[CLR SET]** key.

### Advice

- In step 2, if there are no stored memory address a low-pitched tone is emitted.
- The memory address numbers displayed in steps 2 and 3 are memory address' with stored memory only.
- In step 3, pressing the Selector while turning it, allows the address' to be viewed quickly.

### Advice

- In step 2, if there are no stored memory address a low-pitched tone is emitted.
- The memory address numbers displayed in steps 2 and 3 are memory address' with stored memory only.

## Changing the Memory Contents

This function is used to change a stored frequency to a different frequency.

- 1 Select the main band and set it to the VFO mode.
- 2 Press the **[V/M ENT]** key or the **[V/M]** key on the microphone.
- 3 Turn the Selector, or press the **[UP]** or **[DOWN]** keys to select the memory address to be changed.

MOD 1 MAIN  
446.200

- 4 Press the **[F]** key, then press the **[V/M ENT]** key. (The "M" on the display starts to blink )

Blinking MOD 1 MAIN  
446.200

- 5 Turn the Selector, or press the **[UP]** or **[DOWN]** keys to select a new frequency.

MOD 1 MAIN  
446.440

- 6 Press the **[V/M ENT]** key while in the function mode. (The "M" on the display changes from a blinking display to a normal display and the contents of the memory address is changed.)

MOD 1 MAIN  
446.440

- 7 To return to the original display, press the **[V/M ENT]** key or the **[V/M]** key on the microphone. To return to the VFO from changed memory, and transfer the contents of the memory to the VFO, press the **[CLR SET]** key.

### Advice

- In step 5, the CMP883 microphone can be used to directly enter the frequency. (P 54)

## Erasing the Memory

This function is used to erase stored memory.

- 1 Select the main band and set it to the VFO.
- 2 Press the **[V/M ENT]** key or the **[V/M]** key on the microphone.
- 3 Turn the Selector, or press the **[UP]** or **[DOWN]** keys to select the memory address to erase.
 

MOB | MAIN  
446.200
- 4 Press the **[F]** key for 1 second or longer, then press the **[CLR SET]** key. (A high-pitched tone is emitted and the memory is erased.) **[FB]**
- 5 Confirm that the VFO mode is displayed.

### Advice

- In step 4, memory cannot be restored after it has been erased. To cancel the setting, confirm that the transceiver is not in function blink mode, then press the **[V/M ENT]** key or the **[CLR SET]** key.

## Copying a Memory from one to another

The frequency and settings modes stored in a memory address can all be copied to a different memory address.

- 1 Select the main band and set it to the VFO.
- 2 Press the **[V/M ENT]** key or the **[V/M]** key on the microphone.
- 3 Turn the Selector, or press the **[UP]** or **[DOWN]** keys to select a memory address to copy.
 

MOB | MAIN  
446.200
- 4 Press the **[F]** key for 1 second or longer, then press the **[V/M ENT]** key. (Empty memory address numbers are displayed.) **[FB]**
- 5 Turn the Selector, or press the **[UP]** or **[DOWN]** keys to select the memory address to copy to.
 

005 | MAIN  
446.200
- 6 Press the **[F]** key, then press the **[V/M ENT]** key. (A high-pitched tone is emitted and the memory is copied.) **[F]**
- 7 To return to the original frequency, press the **[V/M ENT]** key or the **[V/M]** key on the microphone. To return to the VFO from copied memory frequency, press the **[CLR SET]** key.

### Advice

- Memory cannot be copied between Left and Right bands.
- In step 4, if there are no empty memory address numbers a low-pitched tone is emitted. In this case, follow the steps in 'Erasing the Memory' (P. 28) to erase unneeded memory.
- The memory address numbers displayed in steps 4 and 5 are memory addresses with no stored memory only.
- This function is useful when memory addresses for Block Memory Scan (P. 39) etc., need to be changed.

## Saving Settings in a Memory

Settings can be stored along with the frequency in a memory.

- 1 Select the main band and set it to the VFO.
- 2 Press the **[V/M ENT]** key or the **[V/M]** key on the microphone.
- 3 Turn the Selector, or press the **[UP]** or **[DOWN]** keys to select a memory address.
- 4 The various settings that can be set are.
  - Repeater mode (P. 44)
  - Offset frequency (P. 45)
  - Tone frequency for Repeater mode (P. 45)
  - Code Squelch mode (P. 55)
  - Tone Encoder mode (P. 62)
  - Tone Squelch mode (P. 62)
  - Tone frequency for Tone Squelch mode (P. 62)
- 5 To return to the original frequency, press the **[V/M ENT]** key or the **[V/M]** key on the microphone. To return to the VFO from memory frequency press the **[CLR SET]** key.

## Protecting Memory (Memory Protect)

This function is used to protect memory settings from accidental change or erasure.

- 1 Press the **[F]** key, then press the **[CLR SET]** key.
- 2 Turn the Selector and set the Set Mode number to 10.

- 3 Press the **[V/M ENT]** key. Change the display from oF to on.
- 4 To complete the procedure, press the **[CLR SET]** key.

### Advice

- When this setting is on, all memory is erased when All Reset (P 13) is performed.
- When All Reset, VFO Reset and Hyper Memory + VFO Reset are performed the factory setting of oF is restored (P 13).

## Storing the Scan Type in a Memory

- 1 Select the main band and set it to the VFO.
- 2 Press the **[V/M ENT]** key or the **[VM]** key on the microphone.
- 3 Turn the Selector, or press the **[UP]** or **[DOWN]** keys to select the memory address.

- 4 Press the **[F]** key, then turn the Selector to select the scan type.  
B: Busy scan  
H: Hold scan  
No indication: Pause scan **[F]**
- 5 To return to the original display, press the **[V/M ENT]** key or the **[VM]** key on the microphone. To return to the VFO from changed memory, and transfer the contents of the memory to the VFO, press the **[CLR SET]** key.

### Advice

- This setting is available for memory scan.

## Saving the Memory (Memory Backup)

This function is used to save the contents of internal memory, the various function settings, memory (memory address numbers 000 to 079), hyper memory etc., to the CMU161 memory unit. It can also be used to load the contents of the memory unit into the transceiver. (The contents of additional memory (memory address number 080 to 199) can not be saved.)

This function can also be used to copy all the memory (apart from the contents of additional memory) from one C5900D series to another.

To save the memory contents to the CMU161 memory unit

- 1 Set both the Left band and Right band to the VFO.
- 2 Press the **[F]** key, then press the **[CLR SET]** key. **[F]**
- 3 Turn the Selector and set the Set Mode number to 33.

- 4 Press the **[V/M ENT]** key. Change the display from oF to out.
- 5 Press the **[F]** key, then press the **[V/M ENT]** key.  
(A high-pitched tone is emitted and the save memory operation begins. No operations can be performed while memory is being saved.) **[F]**
- 6 After a few moments, a long high-pitched tone is emitted and the memory backup is completed

To transfer the contents of memory unit to the transceiver.

- 1 Press the **[F]** key, then press the **[CLR SET]** key. **[F]**
- 2 Turn the Selector and set the Set Mode number to 33.
- 3 Press the **[V/M ENT]** key. Change the display from oF to in.
- 4 Press the **[F]** key, then press the **[V/M ENT]** key.  
(A high-pitched tone is emitted and the transfer memory operation begins. No operations can be performed while memory is being transferred.) **[F]**
- 5 After the memory is transferred, a high-pitched tone is emitted, the power is turned off and on again.  
(The transfer memory operation is complete.)

### Advice

- Do not turn the power off while the memory is being saved to, or transferred from, the memory unit. The memory may become damaged and need to be reset.
- A memory unit can only be used to increase memory or to backup memory. To use both functions 2 memory units must be used.
- When a memory unit is used for increased memory, the contents of the additional memory (memory address number 080 to 199) is erased when the memory is saved to a memory unit.
- When the data for a memory unit used as additional memory is transferred from the memory backup, a tone is emitted in step 4.
- A memory unit that is used as a memory backup cannot be used for additional memory. The memory unit must be reset before it can be used as additional memory. The contents of the memory backup will be erased when the memory unit is reset.
- After memory has been saved, it is not possible to return to the last operation. All Reset can be used to quickly return to the previous state.
- When All Reset is performed and a memory unit with memory backup data attached to the transceiver, the contents of the memory backup will be erased.

## Inserting or Removing a Memory Unit

**1** Turn the power off.

**2** Slide the release switch, on the lower panel of the transceiver, in the direction of the arrow and pull the control head forward.

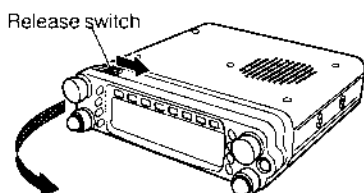

**3** Remove the memory unit cover of the transceiver.

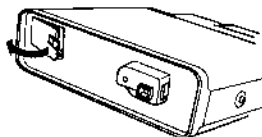

**4** Insert the memory unit with the CMU161 memory unit label facing up.

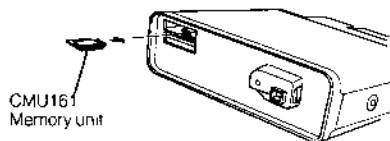

**5** Replace the cover removed in step 3.

**6** Reinstall the control head removed in step 2.

### Advice

- Insert the memory unit straight into the socket until it is properly seated. Do not force the memory unit in to the socket or install it upside-down, damage may result.
- After installing a new Memory Unit to the transceiver, always reset it before using it. (D 13) The Memory Unit cannot be used until it has been initialized.
- The CMU161 Memory Unit can be used immediately after being attached to the Standard's C5900D series transceiver. The Memory Unit must be initialized as described in "Initializing the Memory Unit" before use with this transceiver. Note that all the contents of the data will be erased when the Memory Unit is initialized.
- Be sure not to accidentally perform a "Memory Reset" instead of "Resetting the Memory Unit". If a "Memory Reset" is performed, the contents of the internal memory (000 to 079) will be erased.



# HYPER MEMORY FUNCTIONS

The Hyper Memory Function .....	32
Displaying a Hyper Memory .....	32
Saving Hyper Memory in Manual Mode .....	33
Switching between Auto and Manual Mode .....	33
Saving Hyper Memory in Auto Mode .....	33

## The Hyper Memory Function

- Regardless of the band used, Left or Right, the frequencies and settings displayed on the control head can be stored in a Hyper memory.
- Hyper Memory is referred to as HM in this manual.
- 8 special HM buttons are located on the control head. They can be used to display each Hyper memory.
- Press the HM buttons ① to ⑧ to display each HM number. Press the HM button ⑨ to return to the VFO.
- The factory default setting of C5900DA for each HM setting are listed below. Refer to other model's setting on page 34.

HM number	Left band (MHz)	Right band (MHz)
0	145.520	446.000
1	52.525	146.520
2	52.525	446.000
3	146.520	146.520
4	146.520	446.000
5	446.000	446.000
6	52.525	446.000
7	146.520	446.000

- HM has 2 modes, Manual and Auto. The factory default setting is the Manual mode.
- Manual mode  
The frequency settings etc., can be changed after displaying HM but the changes are not saved. The next time the same HM is displayed, the unchanged settings are displayed. To save changes and settings, the save operation must be performed.
- Auto mode  
Changes to the frequency settings that have been made after a HM has been displayed are saved automatically. The next time the same HM is recalled, the last made to this HM are displayed. The save operation is not required and it can be used as though there are 8 VFOs.

- In addition to the frequency, the following settings can be stored in HM.  
Main Band  
Recall Memory, Scan state etc.  
Transmission Power  
Set Mode address  
Repeater mode  
Offset Frequency  
Tone frequency for Repeater mode  
Code Squelch  
Tone Encoder  
Tone Squelch  
Tone frequency for Tone Squelch mode  
Set mode functions below:

SET mode number	Function
06	Scan mode
14	Auto mute
16	VFO link
20	Paging mode
23	DTMF mode
28	Switching 1200bps/9600bps

- The Hyper memory can be displayed by using the CMP883 microphone. If the keys [0] - [7] are pressed within 3 second after pressing the [#] key during reception, the Hyper memory is displayed. If no key is pressed within 3 second after pressing the [#] key, this function is canceled and middle-pitched tone is emitted.

## Displaying a Hyper Memory

Displaying the data written to HM

- To display HM, press one of the HM buttons ① - ⑧.

On the microphone  
To recall HM, press the [#] key, then press the [1] - [7] key.

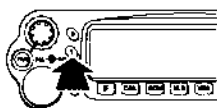

- The HM settings are displayed. Confirm that the HM number on the display is that of the HM that was recalled.

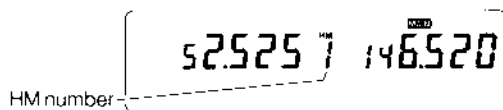

- To return to the VFO, press the HM button ⑨.  
To recall another HM setting, press one of the HM buttons ① - ⑧.

On the CMP883  
To return to the VFO, press the [#] key, then press the [9] key.  
To recall another HM setting, press the [#] key, then press one of the [1] - [7] key.

### Advice



- The frequency and settings can be temporarily changed in step 2. In the manual mode changes are not saved. The next time HM is displayed, the original frequency and settings are displayed.
- In step 2, When HM0 is selected, the HM number (0) is not displayed.
- With HM displayed, if [CALCSQ], [V/M ENT] or [CLR SET] key is selected, the frequency on the display of HM is used. The original VFO, CALL or memory frequency is not restored.
- When HM1 through HM7 are displayed, if the SQL knob is pressed, to switch bands, each band will display the factory default settings and frequency. If HM0 is selected, the last settings and frequency will be displayed. This will also occur if the microphone is used to change bands by entering the frequency of another band.

Band	Initial frequency (MHz)	
	C5900DA	C5908DE
50MHz	52.525	51.000
144MHz	146.520	145.000
440MHz	446.000	433.000



## Saving Hyper Memory in Manual Mode



This function is used to change a stored Hyper memory.

### Making changes in Manual mode

- To display to the VFO, press the HM button .  
To recall a HM setting, press one of the HM buttons .

On the microphone

To display to the original VFO, press the  key, then press the  key.

To recall another HM setting, press the  key, then press one of the  keys.

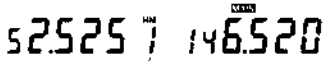



HM number

- Change the contents of HM memory.  
(When HM button  are pressed, the HM number on the display starts to blink if changes are made to the frequency or functions.)







Blinking

- Press the HM button () for about 2 seconds to save the settings to.  
(The contents are displayed, after a high-pitched tone is emitted the memory is saved. The HM number on the display changes from a blinking display to a normal display.)



- To return to the original VFO, press the HM button .  
To display another HM setting, press one of the HM buttons .

On the microphone

To return to the VFO, press the  key, then press the  key.

To display another HM setting, press the  key, then press one of the  key.



### Advice

- The contents of the VFO (HM button ) can be saved to HM 1 to 7, but the contents of HM 1 to 7 cannot be saved to the VFO (HM button ).
- In step 2, the HM number is not displayed when HM 0 is displayed.
- In step 3, if the key is released before the tone is emitted, the settings changes are not saved.
- In step 3, HM cannot be saved by using the CMP883 microphone.

## Switching between Auto and Manual Mode

HM has 2 modes, Manual and Auto. The frequency and setting in HM are set by them.

### To switch to Auto mode

- Press the  key, then press the  key. 
- Turn the Selector and set the Set Mode number to 19.



- Press the  key. Change the display from oF to on.

- To complete the procedure, press the  key.



## Saving Hyper Memory in Auto Mode

In Auto mode, the next time the same HM is displayed, the last settings used are displayed.

### Making changes in Auto mode



- Press the HM buttons  and display the HM setting to change.

On the microphone



Press the  key, then press one of the  key and display the HM setting to change.



- Change the frequency or the various functions.  
(Changes to the frequency and settings are automatically saved.)



- To display to the VFO, press the HM button .  
To display another HM setting, press one of the HM buttons .

On the microphone

To return to the VFO, press the  key, then press the  key.

To display another HM setting, press the  key, then press one of the  keys.

### Advice

- The factory setting is oF (Manual mode).
- To return this function to Manual mode, set the display in step 3 to on.

Reference

- The factory setting of C5908DE for each HM setting are listed below.

HM number	Left band (MHz)	Right band (MHz)
0	145.000	433.000
1	51.000	145.000
2	51.000	433.000
3	145.000	145.000
4	145.000	433.000
5	433.000	433.000
6	51.000	433.000
7	145.000	433.000

# SCAN

The Scan Function .....	36
Changing the Scan Type .....	36
Changing the Scan Speed .....	36
Scanning within 1MHz (1MHz Scan) .....	37
Scanning the Entire Bandwidth (All Scan) .....	37
Changing the Resume Time of Busy Scan .....	37
Scan a Specific Range (Program Scan) .....	38
Scanning Frequencies in Memory (Memory Scan) .....	39
Scanning a Block of Memory Address (Block Memory Scan) .....	39
Scanning a Specific Memory Address (Program Memory Scan) .....	40
Scanning Specific Memory Frequencies (Memory Scan Memory) .....	41
Scanning the CTCSS Tone Frequency (Tone Squelch Scan) .....	41

## The Scan Function

- This function automatically scans frequencies and searches for a signal.
- The transceiver has eight scanning methods. The following eight scan functions are available.

### 1MHz Scan

Scans within 1MHz of the operating frequency.

### All Scan

Scans the entire bandwidth.

### Program Scan

Scans a specific range of frequencies.

### Memory Scan

Scans the memorized frequencies.

### Block Memory Scan

Scans memory in individual blocks.  
A block consists of 10 memory address.

### Program Memory Scan

Scans a specific memory address.

### Memory Scan Memory

Scans specific memorized frequencies.

### Tone Squelch Scan

Scans a frequency for a specific CTCSS the tone frequency. If the tone is matched, the scan is stopped and the Squelch is opened.

- The scan function can be stopped by one of the following three types.

### Pause Scan

The scan stops when a signal is received. It resumes in 1.5 to 5 seconds even if a signal is still present.

### Busy Scan

The scan stops when a signal is received. It resumes after the signal stops.

### Hold Scan

The scan stops when a signal is received. The scan remains unchanged when the signal is no longer received. The scan is restarted by turning the Selector or pressing the **[UP]** or **[DOWN]** keys.

### Advice

- Before starting scan, turn the SQL knob to a position with no noise.
- Press the **[PTT]** switch during a scan to cancel the scan and transmit.
- Turn the Selector, or press the **[UP]** or **[DOWN]** keys to change the direction of scan while it is in progress.
- During scan, press the **[UP]** or **[DOWN]** keys to pause at the current frequency.
- When a scan is stopped, turn the Selector, or press the **[UP]** or **[DOWN]** keys to restart scan.
- The step for setting the frequency for 1MHz Scan, All Scan and Program Scan is the same frequency step. Pressing the Selector during a scan stops the scan and it can be changed to a 1MHz Scan. Press the Selector again to restart the scan. ("Changing the frequency in 1MHz steps" **P** 23.)
- When Tone Squelch (**D** 61) is set, the scan speed is reduced when a signal is received. The scan stops when the tone frequency is matched, and the squelch is opened.
- When the RFSquelch function (**D** 48) is set, the scan speed is reduced when a signal is received. If a signal higher than the RFSquelch setting is received, the scan stops and the squelch is opened.

## Changing the Scan Type

The scan type is changed using the following steps.

- 1 Select the main band.

**[F]**

- 2 Press the **[F]** key, then press the **[CLR SET]** key.

- 3 Turn the Selector and set the Set Mode number to 06.

06 MAIN  
t4PE. P

- 4 Press the **[V/M ENT]** key and select the type of scan.

Pause Scan      Busy Scan      Hold Scan

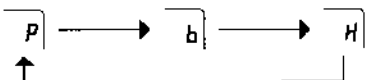

- 5 To complete the procedure, press the **[CLR SET]** key.

### Advice

- The factory default setting is Pause Scan.
- This setting applies to all scan types except Memory Scan. Refer to page 29 when Memory Scan is set the scan type.
- Separate scan types can be set for the Left band and Right band.
- When Busy Scan is selected, "B" is displayed. When Hold Scan is selected, "H" is displayed. When All Scan is selected, nothing is displayed.

## Changing the Scan Speed

This function changes the speed of the scan.

- 1 Press the **[F]** key, then press the **[CLR SET]** key.

**[F]**

- 2 Turn the Selector and set the Set Mode number to 05

05 MAIN  
5CSPH

- 3 Press the **[V/M ENT]** key. Change the display from Hi to Lo.

- 4 To complete the procedure, press the **[CLR SET]** key

### Advice

- The factory default setting is Hi.
- This setting applies to all scan types.
- The setting applies to both the Left and Right band.
- When Hi is selected and a weak signal is received, a scan may not stop if the band is moved as in Memory Scan. In this case, set the scan speed to Lo.

## Scanning within 1MHz (1MHz Scan)

This scans a band of frequencies 1MHz wide. This is useful for scanning for Repeater operation.

- 1 Select the main band and set it to VFO.
- 2 Select the frequency band.
- 3 Turn the Selector, or press the **[UP]** or **[DOWN]** keys to select the start frequency for scan.

446.200

- 4 Press the **[SCN P.S.]** key.  
(The 1MHz Scan is started.)
- 5 Confirm that the band of frequencies scanned are 1 MHz wide.

446.200

Blinking Scanning

- 6 To stop the scan, press the **[SCN P.S.]** key

## Scanning the Entire Bandwidth (All Scan)

This scans the entire bandwidth.

- 1 Select the main band and set it to VFO
- 2 Select the frequency band.
- 3 Press the **[SCN P.S.]** key  
(The 1MHz Scan is started.)

446.200

Blinking Scanning

- 4 Hold down the **[F]** key and press the **[SCN P.S.]** key.  
(The All Scan is started.)

446.200

Blinking Scanning

- 5 To stop the scan, press the **[SCN P.S.]** key.

### Advice

- If step 4 is repeated during an All Scan, the scan mode is changed to 1MHz Scan
- If "Removing the Band Limit" function (P 48) is set to oF, all frequencies will be scanned

## Changing the Resume Time of Busy Scan

The resuming time of the busy scan can be changed

- 1 Press the **[F]** key, then press the **[CLR SET]** key. **[F]**
- 2 Turn the Selector and set the Set Mode number to 36.

36 MAIN  
HOL 1.5

- 3 Press the **[V/M ENT]** key and change the display from "1.5" to the desired time.

1.5 Sec.    3 Sec.    4 Sec.    5 Sec.

1.5 → 3 → 4 → 5

- 4 To complete the procedure, press the **[CLR SET]** key.

### Advice

- The factory default setting is 1.5 seconds.

## Scan a Specific Range (Program Scan)

This scans between the specified scan start and scan end frequencies. Up to 5 program numbers (1- 5) can be set for both the Left and Right band. There are two ways to specify the range. Program numbers 1 to 4 are specified by frequency and program number 5 is specified by a memory address. For each program, there are a pair of settings A and b, and the scan is performed between these points.

### Setting/Changing the Scan Range

1 Select the main band.

2 Press the **[F]** key, then press the **[SCN.PS]** key.



**[F]**

3 Turn the Selector, or press the **[UP]** or **[DOWN]** keys to specify A (or b) for the program number.

4 Press the **[F]** key, then press the **[V.M.ENT]** key.  
(The P on the display blinks.)

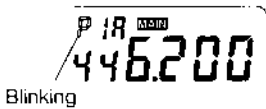

Blinking

**[F]**

5 Set the scan start frequency or memory address.

6 Press the **[V.M.ENT]** key in function mode.  
(The P on the display stops blinking.)

**[F]**

7 Turn the Selector, or press the **[UP]** or **[DOWN]** keys to specify b (or A) for the same program number as in step 3.



8 Press the **[F]** key, then press the **[V.M.ENT]** key.  
(The P on the display blinks.)

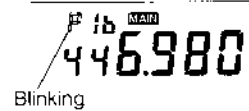

Blinking

**[F]**

9 Set the scan end frequency or memory address.

10 Press the **[V.M.ENT]** key in function mode.  
(The P on the display stops blinking.)

**[F]**

11 To stop the scan, press the **[CLR.SET]** key.

### Advice

- In step 5 and step 9, the frequency or memory can be entered directly from the CMP883 microphone. In this case, when the input is finished, step 6 and step 10 are performed automatically.

### Starting the scan

1 Select the main band.

2 Press the **[F]** key, then press the **[SCN.PS]** key.

**[F]**

3 Turn the Selector, or press the **[UP]** or **[DOWN]** keys to specify A (or b) for the desired program number.

4 Press the **[SCN.PS]** key.  
(The scan is started.)

5 To stop the scan, press the **[SCN.PS]** key.

### Advice

- If both A and b have not been set for the selected program, a low-pitched tone is emitted in step 4.
- The scan is performed from the lowest frequency to the highest.
- In step 3, if the program number is P5A or P5b, the frequency in the memory address can be confirmed by pressing the Selector.
- If the program number is P5A or P5b, the new frequencies will be scanned if the frequencies in the memory address are changed.
- If a scan range with different frequency bands is specified, regardless of "Removing the Band Limit" setting (page 48), the scan searches beyond the band.  
Example: Program specifying 146.20MHz to 446.20MHz.

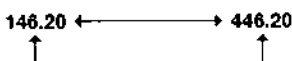

### Erasing a program

1 Select the main band.

2 Press the **[F]** key, then press the **[SCN.PS]** key.

**[F]**

3 Turn the Selector, or press the **[UP]** or **[DOWN]** keys to select A or b for the program number to be erased.

4 Press the **[F]** key for 1 second or longer, then press the **[CLR.SET]** key.  
(A high-pitched tone is emitted and the program is erased.)

**[FB]**

### Advice

- If the memory address specified in P5A or P5b is erased, P5A or P5b are also erased.



## Scanning Frequencies in Memory (Memory Scan)

This scans all frequencies in the memory.

### Preparing for memory scan

- 1 Press the **[F]** key, then press the **[CLR/SET]** key.



- 2 Turn the Selector and set the Set Mode number to 08.

M08 MAIN  
5C00RL

- 3 Press the **[V/M ENT]** key. Change the display to AL.

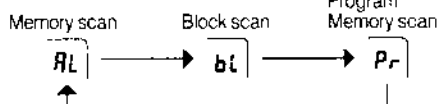

- 4 To complete the procedure, press the **[CLR/SET]** key.

#### Advice

- The factory default setting is AL.
- This operation can be omitted if the factory settings are being used.

### Starting memory scan

- 1 Select the main band.

- 2 Press the **[MS MSM]** key.  
(Memory scan is started.)

M001 MAIN  
445.200

Scanning      Blinking

- 3 To stop the scan, press the **[MS MSM]** key.

#### Advice

- In step 2, a low-pitched tone is emitted if all the memory address are empty.

## Scanning a Block of Memory Address (Block Memory Scan)

This scans memory in individual blocks.

One block consists of 10 memory addresses as shown below.

Internal memory	Optional memory
M000 ~ M009	M080 ~ M089
M010 ~ M019	M090 ~ M099
M020 ~ M029	M100 ~ M109
}	}
M050 ~ M059	M170 ~ M179
M060 ~ M069	M180 ~ M189
M070 ~ M079	M190 ~ M199

### Preparing for the scan

- 1 Press the **[F]** key, then press the **[CLR/SET]** key.



- 2 Turn the Selector and set the Set Mode number to 08.

- 3 Press the **[V/M ENT]** key. Change the display to bl.

M08 MAIN  
5C00bl

- 4 To complete the procedure, press the **[CLR/SET]** key.

### Starting the scan

- 1 Select the main band and set to the VFO.

- 2 Press the **[V/M ENT]** key.

- 3 Turn the Selector, or press the **[UP]** or **[DOWN]** keys to select the memory block to scan.

- 4 Press the **[MS MSM]** key.  
(Block memory scan is started.)

M001 MAIN  
445.200

Scanning      Blinking

- 5 To stop the scan, press the **[MS MSM]** key.

#### Advice

- Press and turn the Selector during a scan to change the memory block.
- If steps 2 and 3 are omitted, the currently displayed memory block is scanned when the **[V/M ENT]** key is pressed.
- In step 2, if the **[MS MSM]** key is pressed after pressing the **[F]** key, a Memory Scan memory can be performed in the Block Memory Scan. In this case, if there is no memory below the specified block, the next block is scanned after the current memory block has been scanned.

## Scanning a Specific Memory Address (Program Memory Scan)

Scans a specific range of memory addresses from the programmed start (Lo) memory address to a programmed stop (Hi) memory address.

### Preparing for Program Scan

1 Press the **[F]** key, then press the **[CLR SET]** key. **[F]**

2 Turn the Selector and set the Set Mode to 08.

3 Press the **[V/M ENT]** key. Change the display to Pr.

4 To complete the procedure, press the **[CLR SET]** key.

4 Turn the Selector to set the memory address for the scan start frequency



5 Press the **[V/M ENT]** key. Change the display to Hi.

6 Turn the Selector to set the memory address for the scan end frequency.

### Setting/Changing the Scan Range

1 Press the **[F]** key, then press the **[CLR SET]** key. **[F]**

2 Turn the Selector and set the Set Mode number to 09. Change the display to Lo.

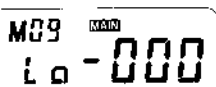

3 Press the **[F]** key, then press the **[V/M ENT]** key. (The — on the display blinks.) **[F]**

7 Press the **[F]** key, then press the **[V/M ENT]** key. (The — on the display stops blinking) **[F]**

8 To complete the procedure, press the **[CLR SET]** key.

#### Advice

- In step 2, press the **[V/M ENT]** key to confirm the memory address for Hi and Lo. (The display toggles between the two with each press of the key.)
- In steps 4 and 6, turn the Selector in function mode to change address setting in steps of 10.
- When setting the memory address range, empty memory address numbers are also displayed. During the scan, only address containing memory within the specified range are scanned.

### Starting the Program Memory Scan

1 Select the main band and set it to the VFO.

2 Press the **[MS MSM]** key. (The scan is started.)



3 To stop the scan, press the **[MS MSM]** key.

#### Advice

- In step 2, if there are no programmed memory addresses settings in the memory range, a low-pitched tone is emitted.
- In step 2, if the **[MS MSM]** key is pressed after pressing the **[F]** key, a Memory Scan Memory can be performed in the Program Memory Scan. In this case, if there is no programmed memory below the specified block, the next block is scanned after the memory block has been scanned.

## Scanning Specific Memory Frequencies (Memory Scan Memory)

This scans specific memory frequencies. Selected memory addresses can be locked out from being scanned.

### Specifying the addresses

- 1 Select the main band and set it to the VFO.
- 2 Press the **[VMENT]** key and set to Memory mode.
- 3 Turn the Selector, or press the **[UP]** or **[DOWN]** keys to select the memory address to scan.

- 4 Press the **[F]** key for 1 second or longer, then press the **[MS MSM]** key.

- 5 Confirm that a DOWN-ARROW appears above the "M" on the display.

- 6 Repeat steps 3 to 5 to set other memory addresses

- 7 To complete the procedure, press the **[VMENT]** key.

#### Advice

- To cancel the setting, clear the DOWN-ARROW from the display in step 4.

## Scanning the CTCSS Tone Frequency (Tone Squelch Scan)

This scans the CTCSS tone frequency. The received frequency is not changed.

- 1 Select the main band.
- 2 Set the receive frequency to be scanned.
- 3 Press the **[F]** key, then press the **[POT.SQ]** key twice. Change the display to T.SQ.

- 4 Press the **[F]** key for 1 second or longer, then press the **[POT.SQ]** key. (The CTCSS tone frequency is displayed.)

- 5 Press the **[SCN.P.S]** key. (The Tone Squelch Scan is started.)

### Starting the Memory Scan Memory

- 1 Select the main band and set it to the VFO
- 2 Press the **[F]** key, then press the **[MS MSM]** key.
- 3 Confirm that the scan starts at the specified memory address

- 4 To stop the scan, press the **[MS MSM]** key.

#### Advice

- In step 2, a low-pitched tone is emitted if there is no memory specified by DOWN-ARROW.
- Memory Scan Memory can be performed for Memory Scan, Block Memory Scan and Program Memory scan.
- During Memory Scan Memory, memory addresses not specified by the DOWN-ARROW are locked out (Not scanned).

- 6 Scan stops when the received the frequency matches the tone and the squelch tone is heard.

- 7 To stop the scan, press the **[SCN.P.S]** or **[CLR.SET]** key.

#### Advice

- Tone Squelch Scan is not performed while "T" is displayed in step 3. Change the display to TSQ to perform the scan.
- The Tone Squelch Scan can be performed on memory frequencies and call frequencies. In step 2, select a memory frequency or a call frequency and proceed to step 3.
- In step 4, turn the Selector or press the **[UP]** or **[DOWN]** keys to manually search for a received CTCSS tone frequency



# REPEATER OPERATIONS

The Repeater Function .....	44
Using Repeater Mode (Auto Repeater Mode) .....	44
Cancelling Auto Repeater Mode .....	44
Setting Repeater Mode Manually .....	44
Receiving a Station Directly in Repeater Mode (Reverse) .....	45
Changing the Offset Frequency and CTCSS Tone Frequency for Repeater Mode .....	45
Using a Repeater which requires a 1750 Hz Tone Burst Signal .....	46

## The Repeater Function

- Communicating through a repeater station is known as Repeater Operation. When the transceiver is using repeater operation it is in Repeater mode.
- Repeater Operation allows a repeater station to be used to reach locations that cannot be reached directly.
- In Repeater Operation, the frequencies for transmission and reception are different. The difference is called the offset frequency.
- When the transceiver is in Repeater mode, the transmission frequency is automatically changed by the offset frequency.
- When the transceiver is in Repeater mode, a tone is automatically transmitted unless manually turned off.

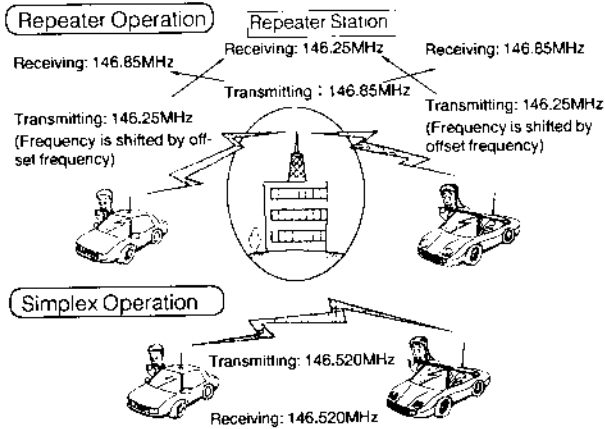

## Using Repeater Mode (Auto Repeater Mode)

In Auto repeater mode, the offset frequency

- 1 Select the main band and set it to the VFO.
- 2 Select the repeater station's output frequency.
- 3 Confirm that "-" or "+" appears on the display.



- 4 To receive, wait for a transmission from a partner.
- 5 To transmit, hold down the **[PTT]** switch and speak in the direction of the microphone.

### Advice

- The relations between frequency and shift direction are as follows:  
 For C5900DA  
 145.100 to 145.495 MHz: - (lower) shift  
 146.000 to 146.395 MHz: + (upper) shift  
 146.600 to 146.995 MHz: - (lower) shift  
 147.000 to 147.395 MHz: + (upper) shift  
 147.600 to 147.995 MHz: - (lower) shift  
 For C5908DE  
 145.600 to 145.795 MHz: - (lower) shift

## Cancelling Auto Repeater Mode

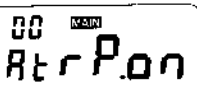
- 1 Press the **[F]** key, then press the **[CLR SET]** key.
- 2 Turn the Selector and set the Set Mode number to 00  

- 3 Press the **[V/M ENT]** key. Change the display from on to off.
- 4 To complete the setting, press the **[CLR SET]** key.

### Advice

- The factory default setting is on.
- This function can only be used with the 144MHz band.

## Setting Repeater Mode Manually

Repeater mode can be selected and cancelled manually. This function can also be used to shift the received frequency by the offset frequency.

- 1 Select the main band and set it to the VFO.
- 2 Turn the Selector, or press the **[UP]** or **[DOWN]** keys to select the repeater station's output frequency.
- 3 Press the **[F]** key, then press the **[MY RPT]** key and set it to the Repeater mode (shift direction).

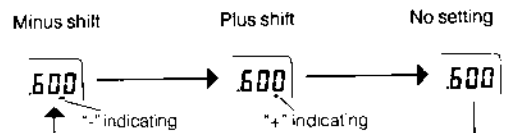

### Advice

- If the offset frequency is not within an amateur band, the transceiver will not transmit a signal. In this case, OFF is displayed when the **[PTT]** switch is pressed.

## Receiving a Station Directly in Repeater Mode (Reverse)

This function temporarily shifts the receive frequency from the repeater's output to input frequency. This function can be used to determine if you can receive the station your communicating with directly (without using a repeater)

### Setting the reverse function

1 Turn the Selector, or press the **[UP]** or **[DOWN]** keys to select the repeater station frequency and select repeater mode.

2 Press the **[SQL OFF]** key on the microphone.  
(The frequency on the display is changed by the direction and amount of the offset frequency.)



3 To complete the procedure (cancel this function), press the **[SQL OFF]** key on the microphone again.

### Canceling the reverse function

1 Press the **[F]** key, then press the **[CLR SET]** key.



2 Turn the Selector and set the Set Mode number to 27.

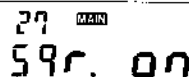

3 Press the **[V/M ENT]** key. Change the display from on to of.

4 To complete the procedure, press the **[CLR SET]** key.

#### Advice

- In step 2, if the reversed frequency is not on an amateur band, a low-pitched tone is emitted and the function is not used.

#### Advice

- The factory default setting is on.
- When this function is set to on, to set squelch to off without using Reverse, turn the Squelch knob in the counterclockwise direction and open the squelch.

## Changing the Offset Frequency and CTCSS Tone Frequency for Repeater Mode

1 Select the main band.

2 Select the frequency band.

3 Press the **[F]** key for 1 second or longer, then press the **[MY RPT]** key.  
(The CTCSS tone frequency for repeater mode is displayed.)



4 Turn the Selector and change the display to the desired CTCSS tone frequency

5 Press the **[MY RPT]** key in function blink mode.  
(The offset frequency is displayed.)



6 Turn the Selector and change the display to the desired offset frequency.

7 To complete the procedure, press the **[MY RPT]** key in function mode.



#### Advice

- The CTCSS tone can be turned off. To do this, set step 4 to OFF.
- In step 2, when a memory or call frequency is displayed, their offset frequency and CTCSS tone frequency can be changed.
- The table of CTCSS tone frequencies that can be selected

67.0	71.9	74.4	77.0	79.7	82.5	85.4
88.5	91.5	94.8	97.4	100.0	103.5	107.2
110.9	114.8	118.8	123.0	127.3	131.8	136.5
141.3	146.2	151.4	156.7	162.2	167.9	173.8
179.9	186.2	192.8	203.5	210.7	218.1	225.7
233.6	241.8	250.3				

(Hz)Total: 38

Band	Initial offset frequency (MHz)	
	C5900DA	C5908DE
50MHz	0.000	0.000
144MHz	0.600	0.600
440MHz	5.000	0.000

## Using a Repeater which requires a 1750 Hz Tone Burst Signal

This function transmits a tone burst signal to access a repeater station

- 1 Select the main band and set it to VFO.
- 2 Set the offset frequency and repeater mode.
- 3 Turn the Selector, or press the **[UP]** or **[DOWN]** keys to select the repeater station frequency.
- 4 Hold down the **[PTT]** switch and the **[SQL.OFF]** key on the microphone at the same time.

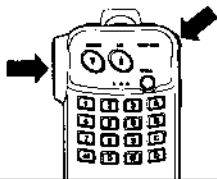

### Advice

- While the **[SQL.OFF]** key is pressed, a 1750 Hz tone burst signal is transmitted.
- A tone burst signal cannot be transmitted when the DTMF function is active.



# ADDITIONAL FUNCTIONS

Removing the Band Limit .....	48
Preventing Unintentional Transmission (PTT Lock) .....	48
RF Squelch .....	48
Changing the Frequencies on Both Sides of the Display Simultaneously (VFO Link) .....	49
Changing the Display Brightness (Dimmer) .....	49
Changing the Volume of the Beep .....	49
Setting the PTT Beep Transmission (Stand-by Beep) .....	50
Stopping the Transmission Automatically (Time-Out Timer) .....	50
Muting the Opposite Band Automatically (Auto Mute) .....	50
Muting the Sub-band (Sub-band Mute) .....	50
Turning the Power off Automatically (Auto Power Off) .....	51
Setting the Cross-band Repeater .....	51
Setting the Auto AM Reception Mode .....	51
Setting the AM Reception Mode Manually .....	51

## Removing the Band Limit

This function is used to remove this band limit when the end of one band is reached the beginning of another band is displayed. For example, if 440MHz is selected for the Right band, when the Selector or the **[UP]** or **[DOWN]** keys are used and the end of the band is reached, frequencies in the 144MHz band are displayed.

**1** Press the **[F]** key, then press the **[CLRSET]** key.



**2** Turn the Selector and set the Set Mode number to 07.



**3** Press the **[V/M ENT]** key. Change the display from on to oF.

**4** To complete the procedure, press the **[CLRSET]** key.

### Advice

- The factory default setting is on.
- To cancel this function, set the display in step 3 to on.

## Preventing Unintentional Transmission (PTT Lock)

To prevent unintentional transmission, the **[PTT]** switch can be locked.

**1** Press the **[F]** key, then press the **[CLRSET]** key.



**2** Turn the Selector and set the Set Mode number to 13.



**3** Press the **[V/M ENT]** key. Change the display from oF to on.

**4** To complete the procedure, press the **[CLRSET]** key.

### Advice

- The factory default setting is oF.
- To cancel this function, set the display in step 3 to oF.
- When this function is set to on, PL is displayed when the **[PTT]** switch is pressed.

## RF Squelch

This function opens the squelch when the received signal exceeds the S-meter level setting.

**1** Press the **[F]** key, then press the **[CLRSET]** key.



**2** Turn the Selector and set the Set Mode number to 32

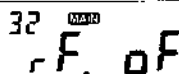

**3** Press the **[V/M ENT]** key. Change the display from oF to on.

**4** Press the **[CLRSET]** key to return to the original display.

**5** Turn the SQL knob fully counterclockwise in the desired band and open squelch.

**6** Gradually turn the knob clockwise until the desired RF squelch setting is reached as displayed on the S-meter

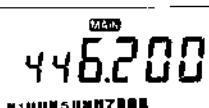

**7** Align the knob with the setting position.

(After about two seconds, the S-Meter display clears.)

**8** When a signal above this setting is received the squelch will open

### Advice

- The factory default setting is oF.
- To cancel this function, set the display in step 3 to oF or turn the SQL knob to its maximum in the counterclockwise direction.
- When this function is set to on, the S-Meter display comes on when the SQL knob is adjusted and lights for about two seconds after adjustment is completed.

## Changing the Frequencies on Both Sides of the Display Simultaneously (VFO Link)

This function changes the VFO frequency for both bands at the same time. This is called VFO Link.

- 1 Set the Left and Right bands to the VFO.
- 2 Select the main band.
- 3 Press the **[F]** key, then press the **[CLR SET]** key. **[F]**
- 4 Turn the Selector and set the Set Mode number to 16
- 5 Press the **[V/M ENT]** key. Change the display from oF to on. ("∞" is displayed)
- 6 To return to the VFO, press the **[CLR SET]** key.
- 7 Turn the Selector, or press the **[UP]** or **[DOWN]** keys at the main band to change both bands simultaneously.

**Advice**

- The factory default setting is oF.
- To cancel this function, set the display in step 3 to oF.
- If one band is set to the repeater uplink frequency (146.0 to 146.4MHz) and the other band is set to the repeater downlink frequency (146.6 to 147.0MHz) when the VFO Link function is set, the uplink and downlink frequencies can be received and changed simultaneously.
- During VFO Link, the sub-band selector will only changed the sub-band frequency.

## Changing the Display Brightness (Dimmer)

This function changes the brightness of the display.

- 1 Press the **[F]** key, then press the **[CLR SET]** key. **[F]**
- 2 Turn the Selector and set the Set Mode number to 03.
- 3 Press the **[V/M ENT]** key. Change the display from oF.  

Light Dark
- 4 To complete the procedure, press the **[CLR SET]** key.

**Advice**

- The factory default setting is oF.
- In step 3, the display lamp goes out when setting 4 is selected.

## Changing the Volume of the Beep

This changes the volume of the beep that is emitted when an operation is completed or an error occurs. The beep can also be turned off.

- 1 Press the **[F]** key, then press the **[CLR SET]** key. **[F]**
- 2 Turn the Selector and set the Set Mode number to 04.
- 3 Press the **[V/M ENT]** key. Change the display from 2.  

Off Min. Max.
- 4 To complete the procedure, press the **[CLR SET]** key.

**Advice**

- The factory default setting is 2.

### Setting the PTT Beep Transmission (Stand-by Beep)

This function sets the transceiver to a beep, emit a tone, when the [PTT] switch is released. The beep can also be heard by the receiving station.

1 Press the [F] key, then press the [CLR SET] key.

F

2 Turn the Selector and set the Set Mode number to 17

17 MAIN  
StbP.oF

3 Press the [V/M ENT] key. Change the display from oF.

Off High Middle Low  
oF → 1 → 2 → 3

4 To complete the procedure, press the [CLR SET] key.

5 Confirm that a beep is emitted when the [PTT] switch is released.

**Advice**

- The factory default setting is oF.
- The sound of the beep varies according to the setting in step 3.

### Muting the Opposite Band Automatically (Auto Mute)

This function is used to automatically reduce the volume (about 20dB) of the opposite band while receiving on both bands

1 Select the main band.

2 Press the [F] key, then press the [CLR SET] key.

F

3 Turn the Selector and set the Set Mode number to 14.

14 MAIN  
Rt - m.oF

4 Press the [V/M ENT] key. Change the display from oF to on. (MUTE appears on the display.)

5 To complete the procedure, press the [CLR SET] key.

**Advice**

- The factory default setting is oF.
- To cancel this function, set the display in step 4 to oF.

### Stopping the Transmission Automatically (Time-Out Timer)

This function stops the transmission of a continuous signal beyond specified a length of time. A warning sound is emitted when the transmission is automatically stopped.

1 Press the [F] key, then press the [CLR SET] key.

F

2 Turn the Selector and set the Set Mode number to 30.

30 MAIN  
t ot. oF

3 Press the [V/M ENT] key. Change the display from oF.

Off 3 min. 5 min. 15 min  
oF → 3 → 5 → 15

4 To complete the procedure, press the [CLR SET] key.

**Advice**

- The factory default setting is oF.
- To prevent very long unwanted transmissions, set the transceiver to 3, 5 or 15 minutes.
- Time out timer of DTMF control is independent of this function. When DTMF control is turned on, time-out timer is set for ten minutes. (P 61)

### Muting the Sub-band (Sub-band Mute)

This function is used to mute the sub-band receiver when transmitting on the main band.

1 Press the [F] key, then press the [CLR SET] key.

F

2 Turn the Selector and set the Set Mode number to 15.

15 MAIN  
Subm.oF

3 Press the [V/M ENT] key. Change the display from oF to on.

4 To complete the procedure, press the [CLR SET] key.

**Advice**

- The factory default setting is oF.
- To cancel this function, set the display in step 3 to oF.
- When this function is set to on, MUTE blinks in the sub-band display when the [PTT] switch is pressed.

### Turning the Power off Automatically (Auto Power Off)

This function is used to turn the power off a after a specified length of time. This function prevents the transceiver from being on during unwanted times. It can also prevent the transceiver from discharging the vehicle battery during long unattached periods.

1 Press the **[F]** key, then press the **[CLR/SET]** key. **[F]**

2 Turn the Selector and set the Set Mode number to 31.

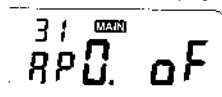

3 Press the **[V/M/ENT]** key. Change the display from oF.

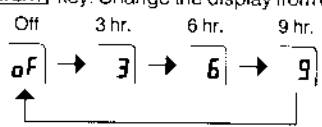

4 To complete the procedure, press the **[CLR/SET]** key.

- Advice
- The factory default setting is oF.
  - If the setting in step 3 is other than oF, APO is displayed.

### Setting the Cross-band Repeater

When this function is activated, the received signal is transmitted on the opposite band.

1 Press and hold both SQL knobs for two seconds or more.

2 Confirm "MAIN" is blinking on both displays.

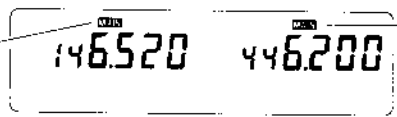

3 To cancel the procedure, press both SQL knobs.

- Advice
- This function can be used in the following transmitting ranges.  
Left band is 144 MHz and Right band is 440 MHz.  
Left band is 50 MHz and Right band is 440 MHz.

### Setting the Auto AM Reception Mode

When a frequency is set in the following range, the transceiver is switched from the FM to AM reception automatically. The frequency is automatically switched to the FM mode if the frequency is outside of the range limits. In the AM mode, the Triangle mark appears on the bottom of the right corner. This function can be disabled as follows:

1 Press the **[F]** key, then press the **[CLR/SET]** key. **[F]**

2 Turn the Selector and set the Set Mode number to 35.

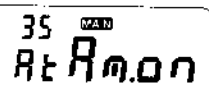

3 Press the **[V/M/ENT]** key. Change the display from on to oF.

4 To complete the procedure, press the **[CLR/SET]** key.

- Advice
- The factory default setting is on.
  - The range of switching from the FM to AM.  
144 MHz band: 108.000 to 141.995 MHz  
440 MHz band: 230.000 to 250.995 MHz, 255.100 to 335.095 MHz
  - To set Auto AM Reception on, change the display in step 3 from oF to on

### Setting the AM Reception Mode Manually

The transceiver can be switched from FM to AM reception mode manually.

1 Select the band.

2 Press the **[F]** key, then select and press the SQL knob to be changed the mode.



- Advice
- To return to FM mode, repeat step 1 and 2.



# USING THE ACCESSORIES

Enter the Frequency Directly with the Microphone .....	54
Code-Squelch and Paging .....	54
Setting the Code-squelch code .....	55
Using the Code-squelch .....	55
Setting Individual Code for Paging .....	55
Setting Paging Codes for Other Stations .....	56
Setting a Group Code .....	56
Transmitting a Paging Signal .....	57
Receiving a Paging Signal .....	57
Delayed Code-squelch/Paging Send Time .....	58
Changing the Beeps in the Paging mode .....	58
Using DTMF Code .....	58
Transmitting a DTMF Code from the Microphone .....	58
Storing the DTMF Code in Memory .....	59
Changing a DTMF Code Stored in Memory .....	59
Sending a DTMF Code from a Memory .....	60
Erasing the DTMF code .....	60
Changing the Interval Sending Time of the DTMF Code .....	60
Setting the DTMF Control .....	61
Receiving the DTMF Control code .....	61
Changing the Frequency by DTMF Control .....	61
Using Tone Squelch (CTCSS) .....	62
Using the Tone Encoder and Tone Squelch .....	62
Changing the Frequency of the Tone Signal .....	62
Using the CAW590 Series Optional Cable .....	63

## Enter the Frequency Directly with the Microphone

A frequency can be directly entered with the numeric keys on the CMP883 microphone.

The following methods can be used.

- 3 digits input: from 1 MHz to 10 kHz.
- 5 digits input: from 100 MHz to 10 kHz.
- 6 digits input: from 100 MHz to 1 kHz.

The initial setting is 6 digits.

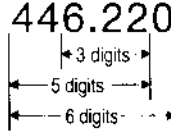

Directly input the frequency

1 Select the main band.

2 Enter the frequency starting with the 100 MHz digit using the numeric keys.

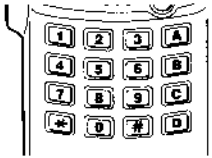

Changing the digits

1 Press the [F] key, then press the [CLR SET] key.



2 Turn the Selector and set the Set Mode number to 34.



3 Press the [V/M ENT] key to select the digits.



4 To complete the procedure, press the [CLR SET] key.

Advice

- The factory default setting is 6 digits.
- The band can easily be change by selecting 5th or 6th digits.
- When using the 50 MHz band on the Left band and entering 5 or 6 digits, enter "0" in the 100 MHz location.
- A low pitch beep is emitted when a wrong key is pressed.
- A DTMF signal can be sent by pressing the keypad during transmit.

## Code-Squelch and Paging

This transceiver can call a specific station or a group of stations. To do this, the code-squelch/paging code must match that of the other transceiver.

Code-squelch

- Code-squelch is the process of sending a coded DTMF signal to another transceiver that has the same code programmed. When received, communications can begin. This function does not have an alarm associated with it.

Paging

- The paging function requires that the sending transceiver and the receiving transceiver use matching personal or group paging codes. The same group code must be used by each member of the group. When the code is matched, the code is displayed and an alarm sounded.

Using your partner's code

Individual code: C0 111

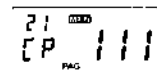

Individual code:  
C0 222

Using group code

Individual code: C0 111

Group code: C2 050

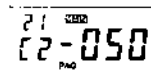
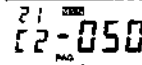

Group code:  
C2 050  
Individual code:  
C0 222

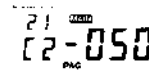

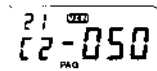

Group code:  
C2 050  
Individual code:  
C0 333



Group code:  
C2 050  
Individual code:  
C0 444





### Setting the Code-squelch code

- 1 Select the main band.
- 2 Press the **[F]** key for 1 second or longer, then press the **[CAL C.SQ]** key.
 
- 3 Turn the Selector to set the code.
 
- 4 To complete the procedure, press the **[CAL C.SQ]** key.

**Advice**



- In Step 3, the 10s digit and above can be changed by pressing and turning the Selector.
- The code-squelch code of Left band is used as the pass-code in the DTMF control function.

### Using the Code-squelch

- 1 Select the main band.
- 2 Select the band.
- 3 Press the **[F]** key, then press the **[CAL C.SQ]** key.
 
- 4 Confirm "CSQ" is displayed.
 
- 5 Press the **[PTT]** switch to send the code.
- 6 The code-squelch is opened when your partner sends the same code.

### Setting Individual Code for Paging

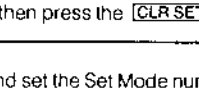
An individual code is necessary to call and receive calls. The individual code is stored in memory address C0.

- 1 Select the main band.
- 2 Press the **[F]** key, then press the **[CLR SET]** key.
 
- 3 Turn the Selector and set the Set Mode number to 21
 
- 4 Press the **[V/M ENT]** key to set the display "C0".  
(The individual code is stored in memory address C0.)
- 5 Press the **[F]** key, then press the **[V/M ENT]** key.  
(The first digit blinks.)
 

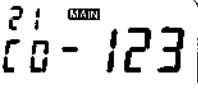
- 6 Turn the Selector to set the first digit and press the **[V/M ENT]** key.
 
- 7 Repeat step 6 to set the second and third digits.  
(The code is stored when the third digit is entered.)
 
- 8 To complete the procedure, press the **[CLR SET]** key.

## Setting Paging Codes for Other Stations

It is necessary to set a paging code for another station before calling. The other station (partner) codes are stored in memory address C1 to C6.

**1** Select the main band and set to the VFO.

**2** Press the **[F]** key, then press the **[CLR SET]** key.

**3** Turn the Selector and set the Set Mode number to 21.

**4** Press the **[V/M ENT]** key to set a partner address code. (Set this code in address C1 to C6.)

**5** Press the **[F]** key, then press the **[V/M ENT]** key. (The first digit blinks.)

**6** Turn the Selector to set the first digit and press **[V/M ENT]** key.

**7** Repeat step 6 to set the second and third digit. (The code is stored when the third digit is entered.)

**8** To complete the procedure, press the **[CLR SET]** key.

## Setting a Group Code

**1** Select the main band.

**2** Press the **[F]** key, then press the **[CLR SET]** key.

**3** Turn the Selector and set the Set Mode number to 21.

**4** Press the **[V/M ENT]** key and select a partner code to set the group code. (Partner codes and group codes are stored in address C1 to C6.)

**5** Press the **[POT SO]** key. (In this step, the group code is set. Group code symbol "-" is displayed between the address number and paging code)

**6** To complete the procedure, press the **[CLR SET]** key.

### Advice

- If a group code is not set, the transceiver is not called if a group code is transmitted.
- Memory address CP cannot be set to a group code.

## Transmitting a Paging Signal

1 Select the main band.

2 Press the **[F]** key, then press the **[CLR SET]** key.

3 Turn the Selector and set the Set Mode number to 20.

4 Press the **[V/M ENT]** key and change the display from "oF" to "on". ("PAG" is displayed)

5 Press the **[CLR SET]** key.

6 Press the **[PTT]** switch to transmit.

7 An alarm is sounded when answered. ("PAG" blinks and the partner code is displayed.)

### Advice

- To cancel this setting, change the display from "on" to "oF" in step 4.
- To stop the alarm, press any key.
- When code-squelch is set, the display can be changed to "on" in step 4 but paging is not activated. Code-squelch has priority to Paging. Paging is activated when the code-squelch is canceled.
- The code displayed in set mode number 21 is sent.
- In step 7, when the code is sent as a group code, the answered code is same as the group code.
- In step 7, "E" replaces "C" when partner codes are not received correctly.
- After step 7, the receiving code is sent when the **[PTT]** key is pressed.

## Receiving a Paging Signal

1 Select the main band.

2 Press the **[F]** key, then press the **[CLR SET]** key.

3 Turn the Selector and set the Set Mode number to 20.

4 Press the **[V/M ENT]** key and change the display from "oF" to "on". ("PAG" is displayed)

5 Press the **[CLR SET]** key.

6 An alarm is sounded when answered.

("PAG" blinks and partner or group codes are displayed.)

### Advice

- To cancel this setting, change the display from "on" to "oF" in step 4.
- To stop the alarm, press any key.
- When code-squelch is set, the display can be changed to "on" in step 4 but paging is not activated. Code-squelch has priority to Paging. If both functions are set to on, only the code squelch is activated. Paging is activated when the code-squelch is canceled.
- In step 6, "E" replaces "C" when partner codes are not received correctly.

### Delayed Code-squelch/Paging Send Time

To prevent the first part of the signal from being omitted when sent by a repeater, the signal can be delayed. The factory default setting is a delay of 250 milliseconds. This time can be set to 450 or 850 milliseconds. Select the "uP" for a delay of 3 seconds, this time is used during in wake-up mode.

1 Press the [F] key, then press the [CLR SET] key.



2 Turn the Selector and set the Set Mode number to 25.



3 Press the [V/M ENT] key and select the delay time.

250 mSec    450 mSec    850 mSec    3Sec for WakeUp function



4 To complete the procedure, press the [CLR SET] key.

### Changing the Beeps in the Paging mode

The number of beeps emitted during paging can be selected. The factory default setting is 7.

1 Press the [F] key, then press the [CLR SET] key.



2 Turn the Selector and set the Set Mode number to 22.

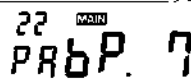

3 Press the [V/M ENT] key and select the number of beeps.

4 To complete the procedure, press the [CLR SET] key

Advice

- The number of beeps can be changed from 7 to 1.

### Using DTMF Code

The following two methods can be used to transmit DTMF codes.  
Method 1: Hold down the PTT switch and use the keypad of the remote control microphone.  
Method 2: Store a DTMF code in memory and transmit the code.

Memory and display of DTMF codes.

- A DTMF code can be stored in a DTMF memory address.
- Up to 15 digits can be stored in one DTMF memory address.
- There are 6 DTMF memories for both left and right sides. There are 12 DTMF memories total.
- 15-digit codes are divided into four blocks and are displayed as follows:

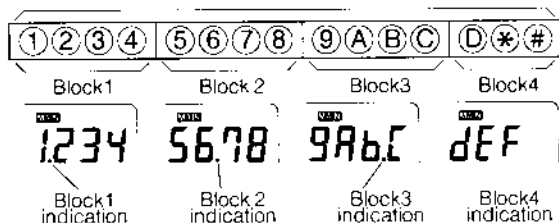

- The codes that can be stored are numbers, letters A to D, and \* and #. On the display, the codes are indicated as follows:

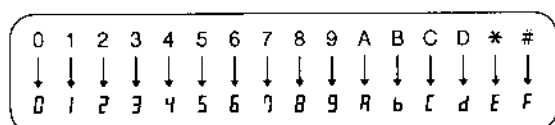

### Transmitting a DTMF Code from the Microphone

DTMF signal can be sent directly using the CMP883 microphone.

- Hold down the [PTT] switch and press the keys on the keypad of the microphone.

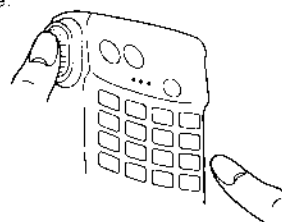

Advice

- The DTMF code is sent while the keys are pressed.

## Storing the DTMF Code in Memory

1 Select the main band.

2 Press the **[F]** key, then press the **[CLR SET]** key.

3 Turn the Selector and set the Set Mode number to 24.



4 Press the **[V/M ENT]** key to set a memory address number (C0 to C5).

5 Press the **[F]** key and the **[V/M ENT]** key.  
(The first digit blinks.)

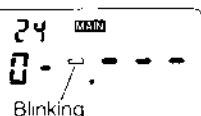

6 Turn the Selector to set the first digit and press **[V/M ENT]** key.

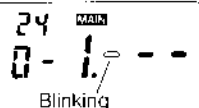

7 Repeat step 6 to set the second to fifteenth digit.  
(The code is stored when the fifteenth digit is entered.)



8 To complete the procedure, press the **[CLR SET]** key.

### Advice

- When codes are shorter than 15 digits. Press the **[CLR SET]** key when the last digit is selected, the code is then entered. Block 1 is displayed. The remaining blinking digits are not stored in step 6.
- To store another DTMF code, repeat steps 1 to 4. Use the **[P.O.T.S.Q]** key to display each block.
- To display the contents of a DTMF memory address, repeat steps 1 to 4 and press the **[P.O.T.S.Q]** key to display each block.

## Changing a DTMF Code Stored in Memory

A DTMF code stored in memory can be changed.

1 Select the main band.

2 Press the **[F]** key, then press the **[CLR SET]** key.

3 Turn the Selector and set the Set Mode number to 24

4 Press the **[V/M ENT]** key to set the memory address number to be changed.

5 Press the **[F]** key, then press the **[V/M ENT]** key  
(The first digit blinks.)



6 Turn the Selector to change the first digit, then press the **[V/M ENT]** key.  
(The second digit blinks.)

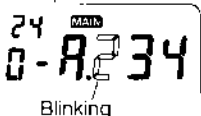

7 Repeat step 6 to change the second to fifteenth digit.  
(The code is stored when the fifteenth digit is changed.)



8 To complete the procedure, press the **[CLR SET]** key.

### Advice

- In step 6, press the **[V/M ENT]** key to skip the digits that should not be changed.
- When the changing codes shorter than 15 digits, Press the **[CLR SET]** key to enter the code. Block 1 is displayed. The blinking digits not stored in step 6.

## Sending a DTMF Code from a Memory

1 Select the main band.

2 Press the **[F]** key, then press the **[CLR SET]** key.

3 Turn the Selector and set the Set Mode number to 24.



4 Press the **[V/M ENT]** key to select the memory address number to be sent.

5 Turn the Selector to set the Set Mode number to 23.



6 Press the **[V/M ENT]** key to change the display from "oF" to "on". ("DTMF" is displayed.)

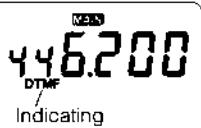

7 Press the **[CLR SET]** key

8 Hold down the **[PTT]** switch and the **[SQL OFF]** to send the DTMF code.

**Advice**

- When using this function, the 1750 Hz burst tone cannot be sent.
- To cancel this setting, change the display from "on" to "oF" in step 5.
- To select another DTMF code, repeat steps 1 to 4.

## Erasing the DTMF code

1 Select the main band.

2 Press the **[F]** key and the **[CLR SET]** key.

3 Turn the Selector and set the Set Mode number to 24.

4 Press the **[V/M ENT]** key to select the memory address number to be erased.

5 Press the **[F]** key, then press the **[V/M ENT]** key. (The first digit blinks)



6 Press the **[CLR SET]** key to erase the DTMF code.

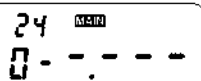

7 To complete the procedure, press the **[CLR SET]** key.

## Changing the Interval Sending Time of the DTMF Code

The DTMF codes are sent every 50 milli seconds. This interval can be changed to 100 milli seconds.

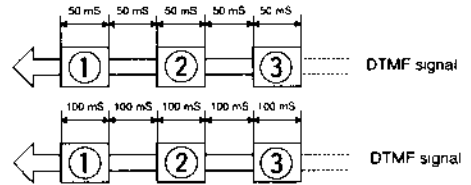

1 Press the **[F]** key, then press the **[CLR SET]** key.

2 Turn the Selector and set the Set Mode number to 26.

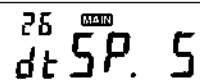

3 Press the **[V/M ENT]** key and change the display from 5 to 10.

4 To complete the procedure, press the **[CLR SET]** key.

**Advice**

- The factory default setting is "5".
- This function sets the same interval sending time for the code-squelch and paging codes.

## Setting the DTMF Control

The transceiver can be controlled by the DTMF code. The sub-band receives the DTMF control code and main band status is controlled.

- 1 Press the **[F]** key for 1 second or longer, then press the Selector of right or left band. **[FB]**

- 2 Confirm the "!" is displayed.  
(The DTMF control mode is set.)

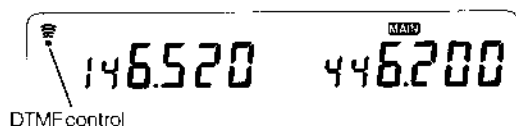

### Advice

- To cancel this function, repeat step 1.
- In this function, paging and code squelch mode are not activated.
- In this function, the code squelch code of Left band is used as a pass-code.
- When main band receives the DTMF control code, main band cannot be controlled. But pass-code can be received on each band.
- In this function, time-out timer is turned on for 10 minutes when the transmission is continued. This timer is independent of the set mode.

## Receiving the DTMF Control code

The transceiver can be controlled by the DTMF code after receiving the pass-code. The sub-band receives the DTMF control code and main band status is controlled.

- 1 Set the code squelch code of left band as the pass-code.

- 2 Receive the pass-code from partner.  
(The transceiver can receive the DTMF code.)

### Advice

- The code and status relations are as follows:
  - 0 set to the VFO.
  - 1 set to the CALL mode.
  - 2 down function
  - 3 up function
  - 4 set to the memory mode.
  - 5 set to the left band to main band.
  - 6 set to the right band to main band.
  - 7 set to the low power.
  - 8 set to the middle power.
  - 9 set to the high power
  - A turn the cross-band repeater on
  - B turn the cross-band repeater off.
  - C (No setting)
  - D be unable to receiving the DTMF control code.
  - \* set to the directly input mode.
  - # clear the function
- 0 to 4, \* and # codes are unavailable when cross-band repeater is turned on. You can use other code when the cross-band repeater turns on.
- After step 2, This function is unable to receiving the DTMF control code with a middle-pitched tone when no DTMF control code is received for 2 minutes. Repeat step 2 to use the DTMF control.
- To active the cross-band repeater, receive the D code after receiving the A code.

## Changing the Frequency by DTMF Control

The frequency of main band can be changed directly by the DTMF control.

- 1 Receive the pass-code from partner.  
(The transceiver can receive the DTMF code.)

- 2 Receive the \* code from partner.  
(The frequency can be changed by the DTMF code.)

- 3 Receive the frequency code from partner.  
(The frequency is changed by the DTMF code.)

- 4 Receive the D code from partner.  
(The transceiver is unable to receiving the DTMF control code.)

### Advice

- Partner sends the code as follows;  
(Example) The frequency is changed 446.000 MHz.
  1. Send the pass-code.
  2. Send the \* code.
  3. Send the frequency code by pressing the 4, 4, 6, 0, 0 and 0 key.
  4. Send the D code.
- In this function, a frequency inputting method is 6 digits input. This is independent of the Set Mode (P.54).

## Using Tone Squelch (CTCSS)

- When selected, CTCSS tone squelch signals can be encoded (transmitted) and decoded (received).

- The tone encoder transmits a sub-audible tone signal.

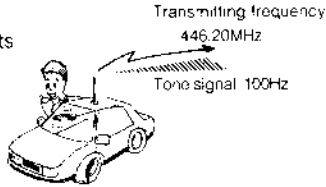

- In order for a receiving station to hear a transmitting station, both the carrier frequencies and tone frequencies must match unless tone squelch (decode) is off.

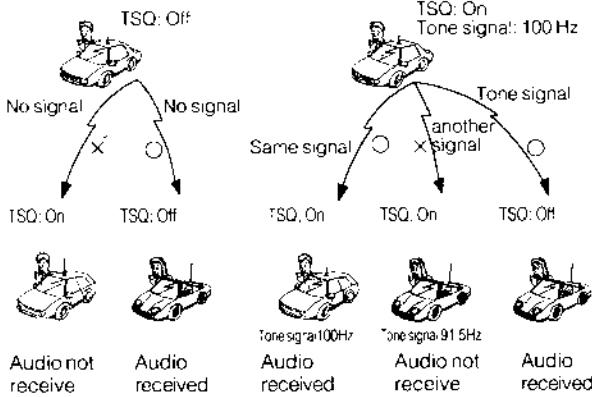

## Using the Tone Encoder and Tone Squelch

- Select the main band.

- Press the **[F]** key and the **[PO T.SQ]** key. Indicate 'T' to use the tone encoder. Indicate 'TSQ' to use tone squelch.

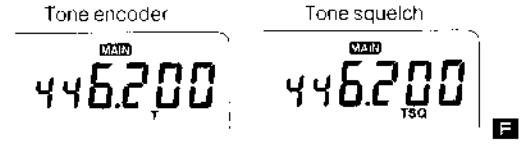

**Advice**

- In repeater mode, the repeater tone is not sent when this function is set. The tone is sent using the tone squelch tone when it is set.

## Changing the Frequency of the Tone Signal

- Select the main band.

- Select the band.

- Press the **[F]** key for 1 second or longer, then press the **[PO T.SQ]** key.



- Turn the Selector to change the frequency of the tone signal.



- To complete the procedure, press the **[PO T.SQ]** key.

**Advice**

- The table of tone frequencies that can be selected.

67.0	71.9	74.4	77.0	79.7	82.5	85.4
88.5	91.5	94.8	97.4	100.0	103.5	107.2
110.9	114.8	118.8	123.0	127.3	131.8	136.5
141.3	146.2	151.4	156.7	162.2	167.9	173.8
179.9	186.2	192.8	203.5	210.7	218.1	225.7
233.6	241.8	250.3	(Hz) Total: 38			

- The factory default setting is 100 Hz.
- In step 2, recall the memory or call frequency to change to the tone signal.



## Using the CAW590 Series Optional Cable

- The CAW590 dual microphone cable, CAW592/CAW593 extension cable and CAW591 separate cable can be combined as shown in the following picture. The extension cable can not exceed 8 m in length.

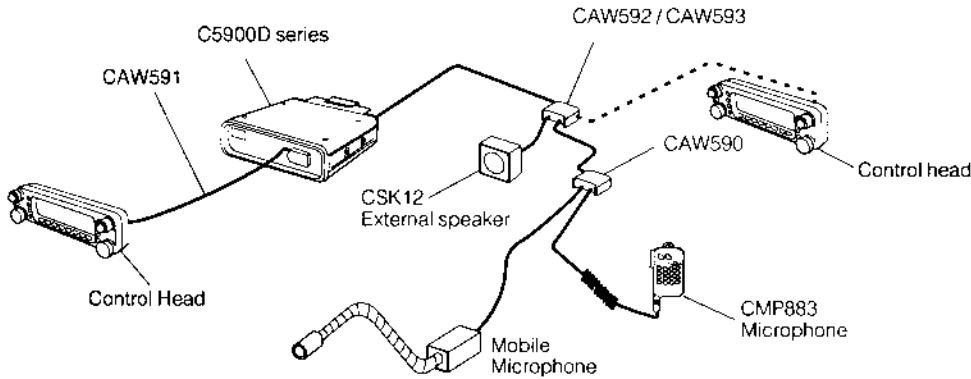

**Note**

- The control head can only be connected to one unit.
- CMP883 must be connected to the MIC1 connector of CAW590. Do not connect it to the MIC2 connector.
- The extension cable must not exceed 8 meters (2.4 feet) in length. If the cables connection is over 8 m, it may cause malfunctions.
- When using the optional external speaker, use the dummy plug included with CAW592/CAW593. When the dummy plug is plugged in the internal speaker is turned off.
- When the external speaker is connected to CAW592/CAW593 extension cable, the transmitting signal may be mixed with the receiving signal of the sub-band. To prevent this, activate the sub-band mute function to prevent the mixed receiving sound.

- The main body can be installed in the trunk or under the seat using the extension cable or separate cables.

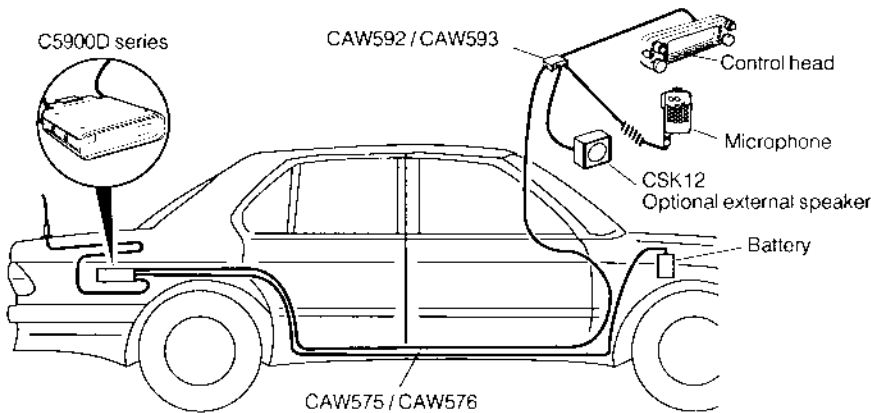

**Advice**

- The CAW575/CAW576 extension power cable should be used to connect to the battery.



# PACKET OPERATIONS

Data Packet Transmission.....	66
1200 bps Data Packet Transmission .....	66
High Speed 9600 bps Data Packet Communication .....	67
Switching between 1200 and 9600 bps.....	67
Selecting the Band to Receive Packet Data .....	67

## Data Packet Transmission

This transceiver can be operated at 1200bps (AFSK) and 9600bps (G3RUH, GMSK) data rates. For transmission of 1200 and 9600 bps signals.

• TNC Connection

A 6-pin mini DIN socket is used for the data terminal. Use the following pin diagram to connect the transceiver to a TNC.

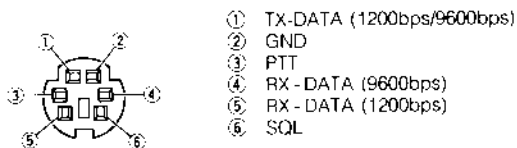

① TX - DATA Input

Transmit data input for both 1200bps and 9600bps. Refer to "Switching between 1200bps and 9600bps" for details (page 67). The standard input levels are: 40mVp-p for 1200bps and 2.0Vp-p for 9600bps.

② GND

Common connection for TX-DATA (pin 1) and RX-DATA (pin 4 or 5).

③ PTT

PTT for data transmission only. This input is connected to GND by the TNC to transmit data.

④ RX - DATA Output (9600bps)

Received data output for 9600bps data. Output signal is approx. 0.7 Vp-p (10kΩ)

⑤ RX - DATA Output (1200bps)

Received data output for 1200bps data. Output signal is approx. 0.7 Vp-p (10kΩ)

⑥ SQL output

Squelch signal output. When a signal is received, this output goes high (+5V). This output can be used by the TNC to prevent transmission while the channel is busy.

## 1200 bps Data Packet Transmission

- 1 Connect the TNC to the transceiver as shown in the diagram below.

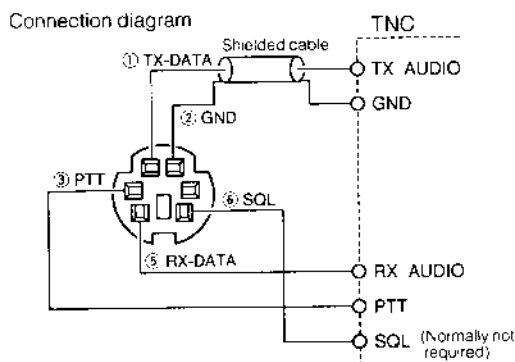

- 2 Adjust the data output level from the TNC using the information provided in the TNC manual. The deviation of transceiver should not exceed  $\pm 3 - 4$  kHz.

- 3 Set the TX DELAY of the TNC to 30 - 50.

Advice

- An audio signal (data) cannot be applied to the microphone connector when the PTT connection to the data connector is used.
- If the transceiver deviation exceeds  $\pm 3 - 4$  kHz data transmission errors may result.
- Refer to manual supplied with your TNC for more information.
- The 5-pin RX-DATA terminal is for the 1200 bps transmissions only. It cannot be used for 9600 bps transmissions.

## High Speed 9600 bps Data Packet Communication

This transceiver can operate at 9600 bps (G3RUH and GMSK protocol) data rates.

- 1 Connect the TNC to the transceiver as shown in the connection diagram below.

Connection diagram

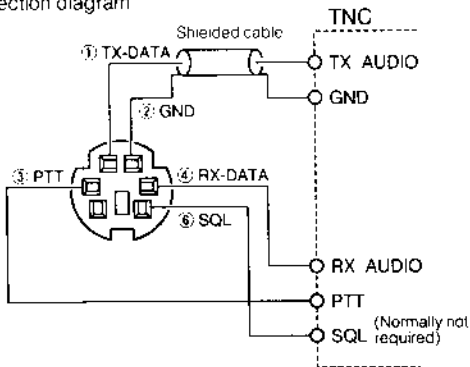

- 2 The G3RUH protocol is used to provide faster and more reliable transmissions and allows for selection from 16 audio waveforms. For this transceiver, we recommend that you set your modem to TR8300 as described in the modem's manual. However, the settings may need to be changed to match the other station you are communicating with.

- 3 When the TX-Audio output from the TNC is being adjusted, modulation is not required. If adjustment is required, follow the steps below.
  - a) Disconnect the modem's mute circuit and use the TX-Audio signals.
  - b) Connect the PTT terminal to GND and start transmission.
  - c) If you can use a deviation meter, adjust the TNC output level control so the deviation is  $\pm 3$  kHz. If you do not have access to a deviation meter, monitor the output from your transceiver and TNC with another receiver. Turn the squelch off on the monitor receiver. Adjust the output level from the TNC so the data signal volume is about half the level of the squelch off noise.

- 4 Set the TX DELAY of the TNC to 30 - 50.

**Advice**

- An audio signal (data) cannot be applied to the microphone connector when the PTT connection to the data connector is used.
- If the transceiver deviation exceeds  $\pm 3-4$  kHz, data transmission errors may result.
- Refer to manual supplied with your TNC for more information.
- The 4-pin RX-DATA terminal is for the 9600 bps transmissions only. It cannot be used for 1200 bps transmissions.

## Switching between 1200 and 9600 bps

The following procedure should be used to switch between 1200 bps and 9600 bps.

- 1 Press the [F] key, then press the [CLR SET] key.
- 2 Turn the Selector and set the Set Mode number to 28.
- 3 Press the [V/M ENT] key. Change the display from 120 to 960. (9600 appears on the display.)
- 4 To complete the procedure, press the [CLR SET] key.

**Advice**

- The factory default setting is 120 (1200 bps)
- When 9600 bps is selected, 9600 appears on the display.

## Selecting the Band to Receive Packet Data

With the factory default setting, packet operation is performed on the main band. This function permits the operator to select the main, Left or Right band to receive packet data. Packet transmission is always on the main band.

- 1 Press the [F] key, then press the [CLR SET] key.
- 2 Turn the Selector and set the Set Mode number to 29.
- 3 Press the [V/M ENT] key. Select the band receive band for packet operation.
- 4 To complete the procedure, press the [CLR SET] key.

**Advice**

- The factory default setting is "n" (main band)
- When "L" (Left band) or "r" (Right band) is selected, packets are received on the specified band regardless of the main band setting. Transmission uses the main band regardless of this setting.



# REFERENCES

Troubleshooting .....	70
List of the Set Mode functions .....	71
Options .....	72
Specifications .....	73
Index .....	74

# Troubleshooting

Please check the following list of symptoms and causes before consulting your dealer.

The power cannot be turned on.

- The fuse is blown.
- The power cord is disconnected.
- The 13.8V DC IN voltage exceeds the 17V limit of the connector. Disconnect the connector and check the DC voltage.

One of the band frequencies is not displayed.

- The Band Off function is on.

The display is dark

- The Dimmer is set to a dark setting. (Set mode 03)

Only strong signals are received

- The antenna is not functioning correctly.
- The antenna is disconnected.
- The SQL knob is turned fully clockwise.
- The coaxial cable is disconnected or damaged.
- The RF squelch function is set to on. (Set mode 32)

The squelch is off. (Noise is heard.)

- The SQL knob is turned fully counterclockwise.
- The Squelch Off key on the microphone was pressed.

The displayed frequency cannot be changed.

- The Key Lock function is on. (Set mode 11)

No signal is received

- The antenna is disconnected or damaged.
- The coaxial cable is disconnected or damaged.

The received signal cannot be heard

- The SQL knob is turned fully clockwise.
- Check the connection to the external speaker.
- Check the position of the volume knob.
- The Sub-band Mute function is set to on. (Set mode 15)
- The transceiver is in Paging or Code Squelch mode.
- No signal can be heard in Tone Squelch mode until the tone frequency is matched.
- The RF squelch function is set to on. (Set mode 32)

The reception volume is low

- Check the position of the volume knob.
- The Auto Mute function is set to on. (Set mode 14)

The transmission power is low.

- The antenna is not functioning correctly.
- The transceiver is set to Low power.
- The antenna is disconnected or damaged.
- The duplex cable is disconnected or damaged.

OFF appears on the display

- The offset frequency is not within the amateur band.

No beep is heard

- The Beep function is set to off. (Set mode 04)

Memory cannot be saved, changed or erased.

- The Memory Protect function is set to on. (Set mode 10)

Memory cannot be saved.

- All the memory addresses are used.

Cannot scan.

- The SQL knob is turned fully counterclockwise.
- The SQL OFF key was pressed.

Memory is not scanned

- There is no stored memory to scan.
- There is no stored memory to scan in the range set for Program Memory Scan.

Program memory is not scanned.

- The start frequency and end frequency have not been selected.

+ or - is displayed automatically

- The Auto Repeater is working automatically in the 144 MHz band.

+ or - are automatically cleared from the display

- These appear automatically if the repeater frequency is not set to 144 MHz band.

Cannot access the repeater station

- The CTCSS tone frequency has not been properly set
- The distance to the repeater station is too great.
- The offset frequency has not been properly set
- The repeater station is not operating

Both bands change when the Selector is turned

- The VFO Link function is set to on. (Set mode 16)

Paging/Code squelch operations do not work

- The code does not match your partner's.
- The group code has not been set.
- Your partner's or your station cannot be reached.

"E" appears on the display

- Your partner's code was not received correctly

Tone squelch operation does not work

- The other station is too far away.
- The other station's and tone frequency is different.



# List of the Set Mode Functions

<b>C5900D series SET MODE</b>			
★: can be stored in MY key.			
Initial indication	Function	Initial indication	Function
00 Rtr P.on ★	Changing the Auto Repeater setting (P44)	19 Rt H.m.oF	Changing the Auto Mode for Hyper memory setting. (P33)
01 S.D ★	Changing the frequency step(P22)	20 PRG. oF ★	Changing the Paging mode setting. (P57)
02 rat 1 ★	Switching the 1MHz,10MHz,100MHz and 100kHz frequency steps.(P23)	21 [0-000	Setting the code for Paging mode. (P55)
03 d im.oF ★	Changing the display brightness.(P49)	22 PRbP. 7 ★	Changing the number of paging beeps. (P58)
04 bPLE. 2 ★	Changing the beep setting. (P49)	23 dt m.oF ★	Changing the DTMF mode setting. (P60)
05 SCSPH. 1 ★	Changing the scan speed. (P36)	24 0- - - -	Setting the DTMF code. (P59)
06 tyPE. P ★	Changing the scan type. (P36)	25 PRdL.25 ★	Setting the time for Code Squelch and Paging transmission.(P58)
07 bRndon ★	Changing the band limit setting.(P48)	26 dt SP. 5 ★	Changing the DTMF code transmission time.(P60)
M08 SCnmRL ★	Changing the Memory Scan setting. (P39)	27 59r. on ★	Changing the reverse setting. (P45)
M09 Lo-000	Setting the range for Program Memory Scan.(P40)	28 bP5.120 ★	Changing the packet transmission speed. (P67)
M10 Pro. oF ★	Changing the Memory Protect setting. (P29)	29 PRCb. n ★	Changing packet reception band. (P67)
11- FL. oF ★	Changing the Key Lock setting. (P22)	30 tot. oF ★	Changing the time-out timer setting. (P50)
12 FLCH.oF ★	Setting for the Selector for use in the key lock.(P22)	31 RPD. oF ★	Changing the auto power off setting. (P51)
13 PL. oF ★	Changing the PTT lock setting. (P48)	32 rF. oF ★	Changing the RF squelch setting. (P48)
14 Rt-m.oF ★	Changing the Auto Mute setting (P50)	33 EE oF	Memory backup operation. (P29)
15 Subm.oF ★	Changing the Sub-band Mute setting (P50)	34 inP. 6 ★	Setting the number of digits for direct input. (P54)
16 L.in. oF ★	Changing the VFO Link setting. (P49)	35 Rt R.m.on ★	Setting the auto AM mode (P51)
17 StbP.oF ★	Changing the Stand-by beep setting (P50)	36 HoL 1.5 ★	Setting the resume time of busy scan (P37)

## Options

---

CMU161	Memory unit (For memory expansion or memory backup.)
CMB5900	Mobile bracket
CSK 12	External speaker
CAW590	Dual microphone cable
CAW591	Separate cable (Control Head Extension cable: 3m)
CAW592	Extension cable with connection box (5 m)
CAW593	Extension cable with connection box (8 m)
CAW575	Power extension cable (5 m)
CAW576	Power relay cable (3 m)

# Specifications

## General

Frequency Range

### For C5900DA

Left band:

50 MHz band	50.000 to 53.995 MHz
144 MHz band	144.000 to 147.995 MHz
440 MHz band	420.000 to 449.995 MHz

Right band:

144 MHz band	144.000 to 147.995 MHz
440 MHz band	420.000 to 449.995 MHz

### For C5908DE

Left band:

50 MHz band	50.000 to 53.995 MHz
144 MHz band	144.000 to 147.995 MHz
440 MHz band	430.000 to 439.995 MHz

Right band:

144 MHz band	144.000 to 147.995 MHz
440 MHz band	430.000 to 439.995 MHz

Transmission Type ..... F2 F3

Rated Voltage ..... DC 13.8 VDC  $\pm$  15 %

Current Consumption

(At transmission) High ..... Less than 12.00 A  
 Middle ..... Less than 5.85 A  
 Low ..... Less than 4.35 A

(In waiting) ..... Less than 0.75 A

Microphone Input Impedance ..... 600  $\Omega$

Speaker Impedance ..... 4  $\Omega$

Antenna Impedance ..... 50  $\Omega$

Working Temperature range ..... - 20 °C to + 60 °C

Frequency Stability .....  $\pm$  4 ppm

Antenna Connector .... M type with cable (C5900DA)

N type with cable (C5908DE)

Grounding Method ..... Negative grounding

Dimensions ..... 140 x 40 x 173 mm  
 (W x H x D)

Weight ..... Approx. 1.2 Kg

## Receiver

Reception System ..... Double super heterodyne

Intermediate frequency

Left band:

50MHz band	1st IF	44.95 MHz (Upper)
	2nd IF	455 kHz (Lower)
144/440MHz band	1st IF	44.95 MHz (Lower)
	2nd IF	455 kHz (Lower)

Right band:

144/440MHz band	1st IF	23.05 MHz (Lower)
	2nd IF	455 kHz (Lower)

Reception Sensitivity

..... Less than 0.251 $\mu$ V (50.000 to 53.995MHz)

Less than 0.224 $\mu$ V (144.000 to 147.995MHz)

Less than 0.251 $\mu$ V (438.000 to 449.995MHz; C5900DA)

Less than 0.251 $\mu$ V (430.000 to 439.995MHz; C5908DE)

Selectivity ..... More than 12 kHz (-6dB)

Less than 24 kHz (-60dB)

Squelch Open Sensitivity ..... Less than 0.158  $\mu$ V

Audio Output ..... 3.0 W (at 10% distortion)

S/N Ratio with Input 0.5  $\mu$ V ..... More than 24 dB

## Transmitter

Transmission Power

High ..... 45 W (50.000 to 53.995 MHz)

50 W (144.000 to 147.995 MHz)

35 W (438.000 to 449.995 MHz; C5900DA)

35 W (430.000 to 439.995 MHz; C5908DE)

Middle ..... 10 W

Low ..... 3 W

Modulation System ..... Reactance modulation

Max. Frequency Deviation .....  $\pm$  5 kHz

Spurious Radiation ..... Less than - 60 dB

Distortion ..... Less than 3 % (at 70 % modulation)

# Index

- 1200bps ..... 66  
 1MHz Scan ..... 37  
 9600bps ..... 66
- Accessory ..... 53  
 AFSK ..... 66  
 All Reset ..... 13  
 All Scan ..... 37  
 AM Reception ..... 51  
 Antenna ..... 8  
 APO ..... 51  
 Auto Mode ..... 50  
 Auto Mute ..... 50  
 Auto Power Off ..... 51  
 Auto Repeater Mode ..... 44
- B (b) ..... 11  
 Band ..... 11  
 Band Limit ..... 48  
 Band Off ..... 21  
 Beep ..... 49  
 Block ..... 39  
 Block Memory Scan ..... 39  
 Busy Scan ..... 36
- Call Frequency ..... 20  
 Code Squelch ..... 54  
 Cross-band Repeater ..... 51  
 CSQ ..... 55
- Dimmer ..... 49  
 Directly Input ..... 54  
 DTMF ..... 58  
 DTMF Control ..... 61
- External Speaker ..... 7
- F ..... 14  
 FB ..... 14  
 Frequency Step ..... 22  
 Function Blink Mode ..... 14  
 Function Mode ..... 14
- G3RUH ..... 66  
 GMSK ..... 66  
 Group Code ..... 56
- High Power ..... 21  
 H ..... 36  
 HM ..... 32  
 Hold Scan ..... 36  
 Hyper Memory ..... 32  
 Hyper Memory + VFO Reset ..... 13
- Individual Code ..... 55
- Key Lock ..... 22
- L ..... 21  
 Low Power ..... 21
- M ..... 21  
 MAIN ..... 11  
 Main Band ..... 11  
 Manual Mode ..... 33  
 Memory ..... 26  
 Memory Address ..... 26  
 Memory Backup ..... 29  
 Memory Protect ..... 29  
 Memory Reset ..... 13  
 Memory Scan ..... 39  
 Memory Scan Memory ..... 41  
 Memory Unit ..... 30  
 Mounting ..... 5  
 MUTE ..... 11,50  
 MY Key ..... 23
- Offset Frequency ..... 44  
 Option ..... 72  
 Option Cables ..... 63
- Packet ..... 66  
 PAG ..... 57  
 Paging ..... 54  
 Pause Scan ..... 36  
 Power Supply ..... 6  
 Power Supply Cable ..... 6  
 Program Scan ..... 38  
 Program Memory ..... 40  
 PTT ..... 17  
 PTT Lock ..... 48
- Receiving ..... 12  
 Repeater ..... 45  
 Reset Mode ..... 13  
 Resting the Memory Unit ..... 13  
 Reverse ..... 45  
 RF Squelch ..... 48
- Scan ..... 36  
 Scan Speed ..... 36  
 Selector ..... 14  
 Set Mode ..... 71  
 Signal/ TX meter ..... 15  
 Simplex ..... 44  
 Squelch ..... 10  
 Squelch Off ..... 19  
 Stand-by Beep ..... 48  
 Sub-band ..... 11  
 Sub-band Mute ..... 50
- T ..... 61  
 Time-Out Timer ..... 50  
 TNC ..... 66  
 Tone Encoder ..... 62  
 Tone Frequency ..... 45  
 Tone Squelch Scan ..... 41  
 Transmitting ..... 13  
 Transmitting Power ..... 19  
 TSQ ..... 61
- VFO Link ..... 49  
 VFO mode ..... 12  
 VFO Reset ..... 13  
 Volume ..... 10

# Memo

---