

C 7900

430MHz BAND FM TRANSCEIVER

INSTRUCTION MANUAL



STANDARD COMMUNICATIONS CORP.

Printed in Japan.

A DIVISION OF MARANTS JAPAN INC.

211C851010



STANDARD®

We are confident that you will be entirely satisfied with your 430 MHz Band FM Transceiver Model C7900.

Our very strict quality control and inspection ensure that each transceiver unit leaves the factory in perfect condition. If the unit is damaged or fails to operate properly, contact your dealer immediately.

To obtain the best performance and longest service life from your transceiver, study these instructions carefully.

ACCESSORIES

1. Instruction manual 1
2. Schematic diagram 1
3. Microphone (MP716) 1
4. Mobile bracket 1
5. DC cord (2 m) 1
6. Plug (3.5 mm in diameter)
(For EXT. SPKR and EXT. METER). . . 1
7. Rubber feet 4
8. Bracket holding screw (1 set)
- Hexagon headed bolt 5 x 20 mm 4
- Nut 5 mm 4
- Flat washer 5 mm 4
- Spring washer 5 mm 4
- Tapping screw 5 x 15 mm 4

FEATURES

- **GaAs FET and high sensitivity design:**
The front-end of the unit uses a gallium arsenic FET 3SK97, which forms an ultra-low noise RF amplifier together with a large helical resonator. Though the unit is very compact, it provides high sensitivity, superior to larger units and excellent reception with high selectivity.
- **Stable transmitter circuit:**
The final block uses a power module. The antenna switching circuit uses a pin diode with the small inter-terminal capacity to minimize loss. The other state-of-the-art technologies include the built-in thermal protector circuit which ensures safe operation even for a long continuous transmission period.
- **Microcomputer permitting repeated operation:**
The C7900 contains a simple and practical microcomputer. It provides the frequency shift function for repeated operation and the offset memory which permits setting of the desired shift width. Software which allow you to enjoy operation using the microcomputer is incorporated. Program scanning using M4 and M5 memories one of these.

- * **5-channel memory:**
Five frequencies can be stored in memory. Any desired memory can be cleared.
- * **Offset memory:**
In addition to five memories, there is another memory designed exclusively for offset. Combined with the shift function (R1-S-R2 switch), this feature permits split operations separately for transmission and reception, such as repeated operation.
- * **All-scan offers various ways to enjoy operation:**
The C7900 has the following three scanning functions.
 - 1 To scan frequencies within the MHz range displayed.
(Scanning within 1 MHz)
 - 2 To scan between desired frequencies.
(Program scanning)
 - 3 To scan all 10 MHz frequencies.
(All frequency scanning)
- * **Built-in MHz key to increase frequency quickly in steps of 1 MHz**

PRECAUTIONS

Installation Place

Note the following before installing the unit.

1. Avoid locations where the unit will be exposed to high temperature and humidity or excessive dust and direct sunlight. Select a well ventilated dry location.

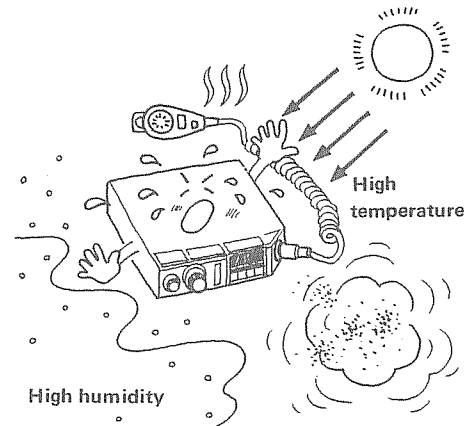

3. When the unit is installed in a car, be careful not to rest the back of the unit against a seat so that heat radiated from the unit can escape. Take care to operate the unit in a location where it is not directly exposed to vibrations.

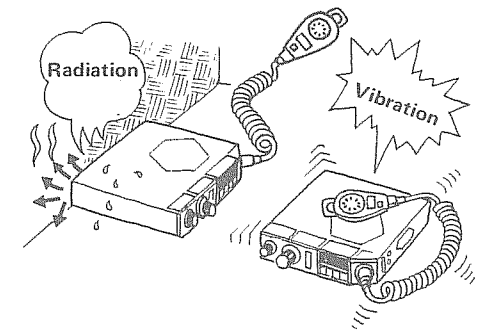

2. Leave enough space behind and under the unit so as not to interfere with cooling effect of the heat sink.

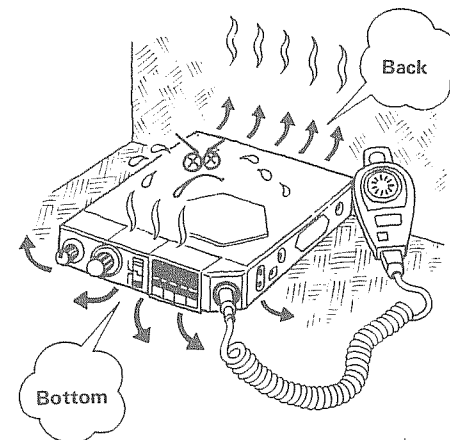

Power Supply

1. The unit operates on 13.8 V DC. The 24 V DC battery in heavy vehicles cannot be used to power the unit.

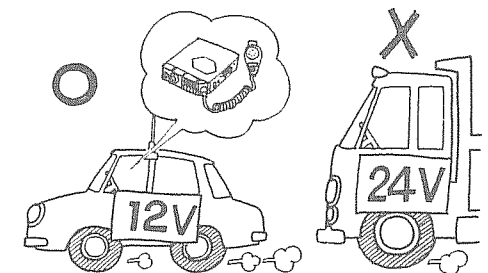

2. When the unit is operated on an AC power supply, use the CPS02 power supply unit (option).

■ PANEL FEATURES

FRONT PANEL FEATURES

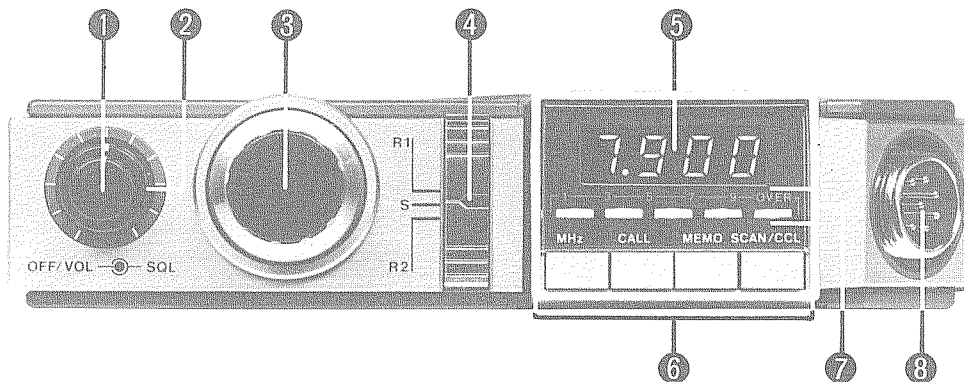

① OFF/VOL (Power Switch/Sound Volume Control)

Turn this knob clockwise (↻) till it clicks to turn on the power. Continue to turn clockwise to increase the sound volume. Turn counterclockwise (↺) to decrease the sound volume. Turn it counterclockwise till it clicks to turn off the power.

② SQL (Squelch Control)

The SQL control is used to suppress annoying FM background noise. If this control is turned fully counterclockwise when there is no input signal, noise can be suppressed. Turn this control slowly clockwise and set it to the point where the noise disappears. Sound can be heard from the speaker only when there is an input signal. If this control is turned too far clockwise, the sound may not be heard with a weak input signal. Take care not to turn too far clockwise. To perform scanning, set this control to the position where the background noise disappears.

③ Tuning control

This control is used to vary transmission and receiving frequencies. Turn it clockwise (↻) to increase the frequency, and turn it counterclockwise (↺) to decrease the frequency. The frequency varies steps of 25 kHz in.

④ PRT (Repeater switch)

This switch is used to change over normal operation and cross-operation. Set it to the S position for normal operation. Set it to the R₁ or R₂ position for cross-operation. In the R₁ position, the receiving frequency is higher than the transmission frequency by the shift width. In the R₂ position, the transmission frequency is higher than the receiving frequency by the shift width.

NOTE:

The shift width is the frequency stored in the offset memory (M6). With an optional unit connected, the C7900 can be used for repeater operation.

⑤ Frequency and mode display LED

- This displays the frequency (4 digits) and the modes: Memory (dot blinks and lights) and Scan (dot blinks). When 433.000 MHz is being received, it displays the lower four digits, "3.000".
- During the scan mode, the dot on the right of the MHz digit blinks.

3.000

Blinks.

- When the MEMO key is operated, the dot on the right of the 10 kHz digit blinks or lights.

3.000

Blinks. or lights.

⑥ Keyboard

These four keys instruct MHz, CALL, MEMO and SCAN/CCL operations.

① MHz:

This key increases the frequency from 430 MHz to 439 MHz in steps of 1 MHz. Each time this key is depressed, the frequency increases by 1 MHz. Continuous depressing for longer than 0.5 seconds will continuously increase the frequency.



② CALL:

Press this key to transmit a tone burst signal for repeater driving (tone frequency: 1750 Hz).

③ MEMO:

This key has two functions calling the memory channel (RCL) and storing the desired frequency (ENTER). The memory circuit has the capacity of storing a total of 6 channels: 5 channels M1 to M5 and a offset memory channel. While the dot on the right of the 10 kHz digit is lit, the next memory channel can be called by the key operation. While it is blinking, store the frequency being displayed by the key operation. While this key is being operated, the dot blinks (calling) and lights (when storing is completed).

After storing the frequency, be sure to press the SCAN/CCL key.

- Store the frequency by the following procedure.

To store in M1:

Turn the OFF/VOL switch clockwise to turn on the power. (3.000 is displayed.)

Example: To store 433.325 MHz

MEMO Press once.

E.E.E.E

Adjust to the desired frequency by operating the tuning control (E.G. a club channel)

3.325

Blinks.

MEMO Press once.

Press once.

3.325

Lights.

The dot turns from blinking to lit, and storing is complete.

To store in M2:

To store in M2 sequentially, press this key twice. This calls M2.

Example: To store 433.350 MHz

MEMO Press once.

3.325

The frequency stores is M1 in displayed.

MEMO Press once.

Press once.

E.E.E.E

Adjust to the desired frequency by operating the tuning control.

3.350

Blinks.

MEMO Press once.

Press once.

3.350

Lights.

The dot turns from blinking to lit, and storing is complete.

To store in M3 to M5:
Use the same procedure for M3 to M5 in sequence.

- To store in the offset memory, use the following procedure.

The PRT switch may be set to any position.
Press the MEMO key 6 times to call the offset memory.

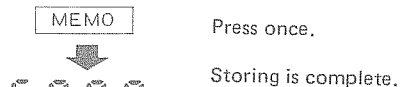
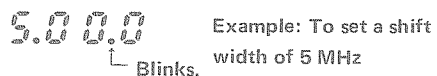
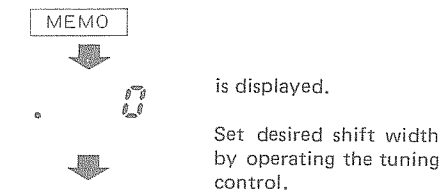

After storing is completed, be sure to press the SCAN/CCL key.

- To change the frequency in memory:

Change the memory frequency to a new frequency by operating the tuning control, and press the MEMO key again to change the frequency.

Example: To change 433.325 MHz to 433.450 MHz

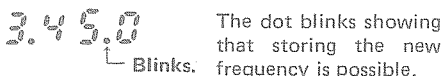
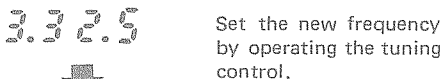
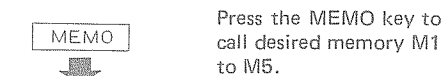

After storing is completed, be sure to press the SCAN/CCL key.

Change offset memory frequency in the same way.

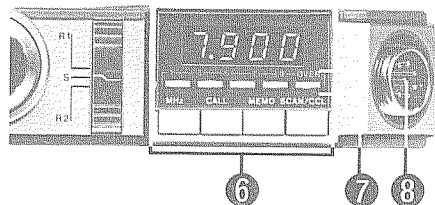

- To clear the stored memory frequency:
Call the memory frequency to be cleared, and press the MEMO and SCAN/CCL keys simultaneously.

Example: To clear the memory frequency

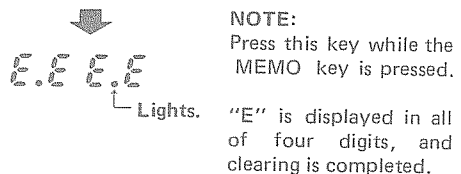
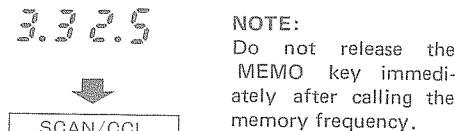
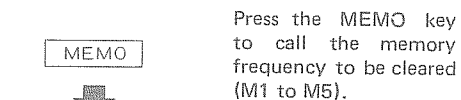

After clearing is completed, be sure to press the SCAN/CCL key.

NOTE: The offset memory frequency cannot be cleared by the above method. Follow the procedure below.

- Turn off the backup switch and power switch. The other memory frequencies are also cleared at the same time when you use this method.

④ SCAN/CCL (Scan/Cancel)

This switch has the following two functions.

1. To cancel each operation.
2. To start or stop scanning.

When an input signal is detected during scanning, scanning is stopped. When no signal is input, scanning is restarted. (BUSY scan system)

To restart scanning when it has stopped, press the microphone UP switch. Scanning is restarted in steps of 25 kHz.

If the SCAN/CCL switch is pressed during scanning, scanning is reset.

Three scanning modes are possible: all-scan, 1 MHz scan and program scan.

During scanning, the dot 4.300 blinks.

- All-scan:

All-scan is performed when a frequency is stored in the 4th memory and no frequency is stored in the 5th memory. All-scan is performed regardless of the status of memories M1 to M3.

- 1 MHz scan:

Scanning is performed within 1 MHz of the frequency being displayed only when no frequency is stored in the 4th memory.

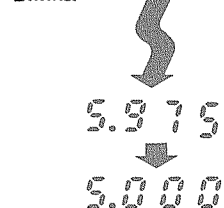
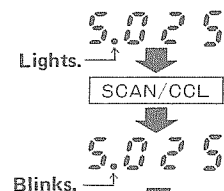

Scanning of the above frequency is repeated.

- Program scan:

When a frequency is stored in M4 and M5, scanning is performed from the 4th memory frequency toward higher frequencies to the 5th memory frequency. When 430.000 MHz is stored in M4 and 433.000 MHz in M5:

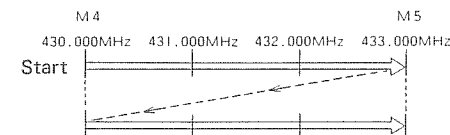

NOTE:

The program scan always starts with the M4 frequency. If the M5 frequency is lower than the M4 frequency, scanning is performed as shown in the following drawing.

When 438.000 MHz is stored in M4 and 430.000 MHz in M5.

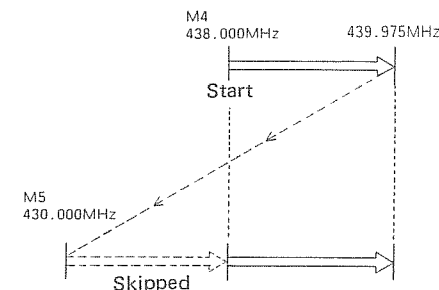

⑦ Meter

The meter consists of 5 LEDs: 3 green LEDs and 2 red LEDs. It checks the input signal strength "S" (including BUSY display) and transmission power "RF".

- S meter:

When it is used as an S meter, the LEDs go on from the left towards the right according to the strength of the input signal.

The leftmost green LED also functions as a BUSY display.

If the SQL control is fully turned counterclockwise beforehand, this LED goes on accompanied by a noise. If the SQL control is set at the point where the noise disappears (threshold point), the LED goes out, it will go on when a very weak signal (including noise) is received and SQL opens. With tight squelch (the SQL control turned fully clockwise), the LEDs go on as an S meter in reception of weak signals even if SQL does not open.

• RF meter:

When the microphone PTT switch is pressed and the unit is set to the transmission mode, all the LEDs go on.

NOTE:

If the LEDs do not go on after the PTT switch is pressed, the microphone or the unit may be defective. Avoid operating in such a case.

SIDE PANEL FEATURES

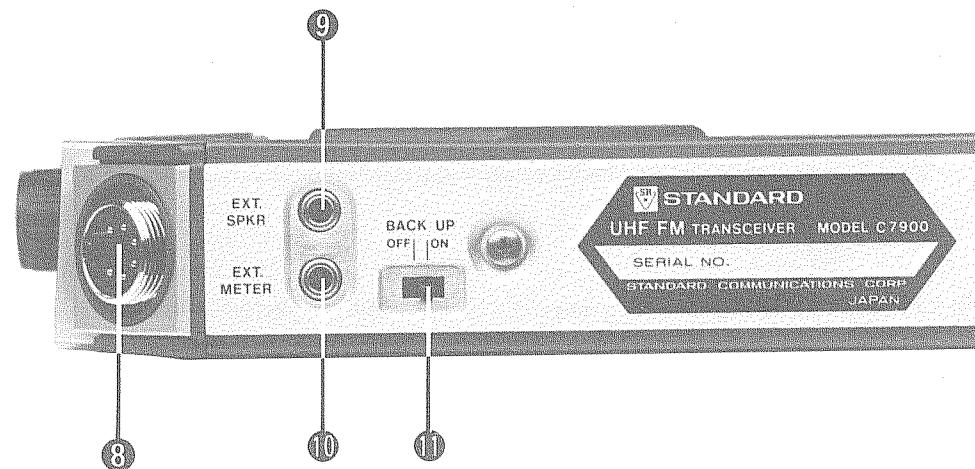

8 MIC (Microphone Connection Terminal)

This terminal is used to connect the provided hand-held microphone MP716 with an UP-DOWN switch.

(Use of the microphone/speaker MP736 (option) is recommended for operation in locations with a high level external noise.)

NOTE:

If microphones of the other brands are used, ensure that the impedance is 600Ω.

The wires are arranged so that an audio signal can be taken out from the pin 3 of the unit.

9 EXT SPKR (External Speaker Connection Terminal)

This terminal is used to connect an external speaker. Use external speaker C207M (option). When an external speaker is connected to this terminal, the built-in speaker is cut off and no sound can be heard from it, and the sound can be heard only from the external speaker. If speakers other than C207M are used, connect using a plug 3.5 mm in diameter as shown below.

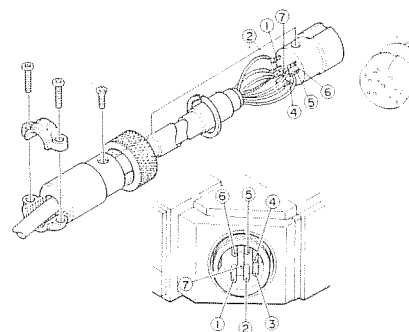

- ① White-MIC
- ② Red-PTT
- ③ Light blue
- ④ Gray-COMMON
- ⑤ Blue-DOWN
- ⑥ Green-UP
- ⑦ Shielding—GND

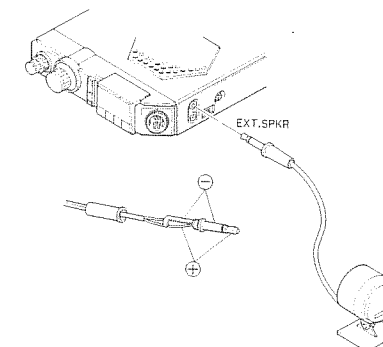

REAR PANEL FEATURES

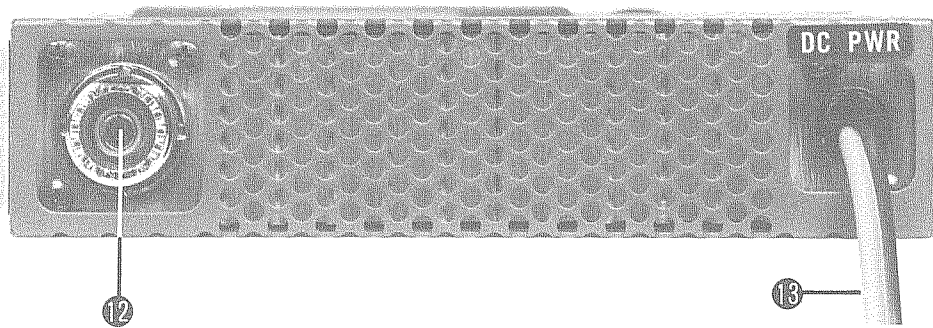

10 EXT METER (External Meter Connection Terminal)

This terminal is used to connect an external analog meter. Connect a 50 to 100 μA DC ammeter to this terminal.

If you wish to minimize the meter pointer deflection, it is recommended to insert a trimmer resistor of about 47 to 100 $\text{k}\Omega$ in series on the positive (+) side of the meter output.

Ammeter of 50 to 100 μA

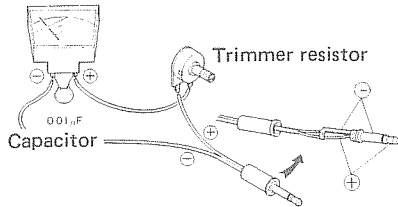

Circuit Example:

- Turn the trimmer resistor to adjust the 3.5 mm dia. plug meter deflection.
- In the above circuit example, the deflection of the unit may be influenced.

11 BACK UP (Backup Switch)

This switch is used to hold the stored frequency by always applying a voltage to the memory circuit independently of the ON and OFF position of the power switch. When the switch is in the OFF position, the stored frequency is not held.

NOTE:

When the unit is used in a car, pay attention to the following.

- When the car is not driven for a long time, be sure to turn off the BACK UP Switch.
- Connect the power supply to the unit directly from the battery as long as there is no special inconvenience. It is different in each car, some have lines which turn off when the start switch is actuated. If the power supply wire is connected to such a line, the power may not be backup even if the BACK UP switch is ON.

12 ANT (Antenna Terminal)

This is an M-type connector terminal used to connect an antenna with 50 Ω impedance. The connector should be fully tightened.

13 Power cord

This is the cord to supply 13.8 V DC. Use this cord together with the connection cable provided to connect between the unit and battery.

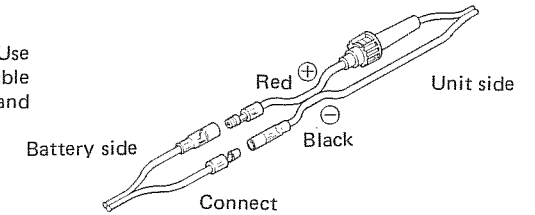

MICROPHONE FEATURES

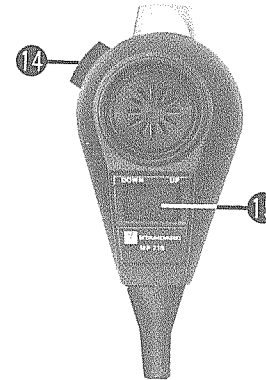

14 PTT

Press-to-talk switch for transmission. Press this switch to set to the transmission mode.

15 UP-DOWN channel switch

Press this switch to step up or down the channel frequency continuously.

■ INSTALLATION

Mobile Operation

For mobile operation, the unit may be installed under the dashboard, on the side of the console box, or under the instruments. Avoid installing the unit near the air output of the cooler or heater.

Fig. 1 Installation locations in a car

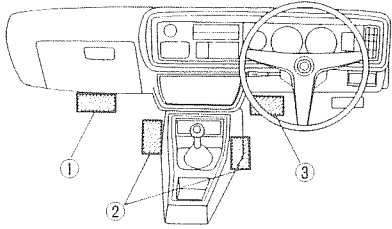

Bracket Installing Procedure

For bracket installation, select a location where the bracket can be fixed securely. The bracket should be firmly fixed with four screws.

- ① Drill holes of 5.2 to 5.5 mm when using 5 mm screws, and 4.0 to 4.3 mm holes when using 5 mm tapping screws.
- ② When using 5 mm screws, insert the screw into the washer, let it pass through the hole in the finished interior from the bracket side (in the car), and put the washer and nut on the screw from the back of the finished interior to fix it as shown in Fig. 2. (Fix four bolts.)

When using 5 mm tapping screws, insert directly into the hole. The thread is automatically cut and fixed. When tightening the screws, use a spanner or a Philips screwdriver.

Fig. 2

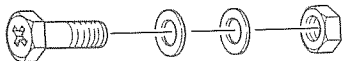
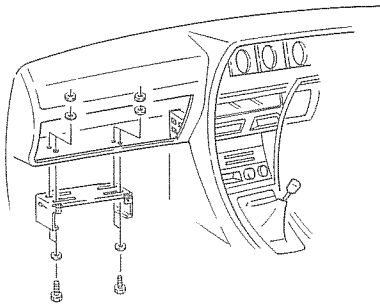

- The pattern of bracket mounting holes is provided on page xx of this manual. Use it when drilling holes.
- ③ Connect the antenna cable and power cord to the rear panel of the unit. (Fig. 3)

Fig. 3 Rear Panel Connection

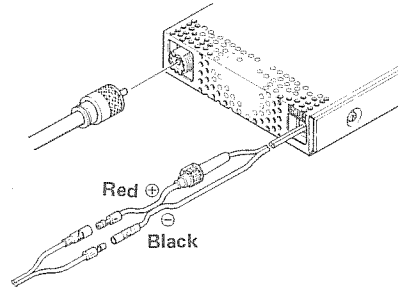

NOTE:
The BACK UP switch on the side should be set beforehand.

- ④ For mobile operation, mount the bracket on the dash-board or another suitable place, and fix the unit. To fix the unit, loosen the screw used at part A in Fig. 4 to insert the unit into the bracket. Then, insert the unit into the bracket, and tighten the screw at part A with a screwdriver.

NOTE:
Before inserting the unit into the bracket, the DC cord and coaxial cable should be connected.

Fig. 4

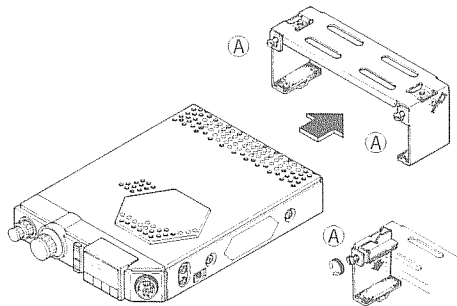

Antenna Mounting Procedure

When mounting an antenna on a car, use an antenna base. Obtain an antenna base matching the type of antenna and car from your dealer. For the antenna mounting position, those shown in Fig. 5 are popular.

NOTE:
When mounting the antenna base, ground it completely.

Use good antenna to display the full performance of the unit. Adjust SWR of the antenna to lower than 1.5 before using the antenna. If the SWR is set incorrectly, it causes the unit to fail to output the rated transmission power. When leading the coaxial cable into the car, take care that rain does not leak into the car.

Fig. 5

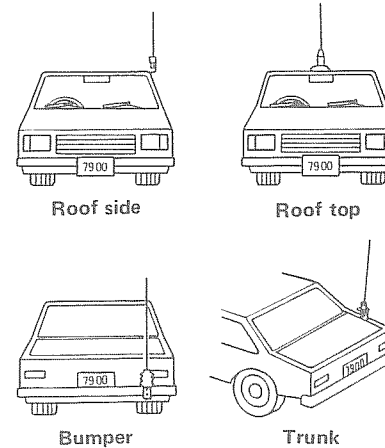

Power Supply Wiring

The unit operates on 13.8 V DC. It cannot be used in a heavy vehicle which uses a 24 V DC battery.

- The unit should be supplied power directly from a car battery. (Fig. 6)
- Connect the power cord provided (parallel red and black wires) to a car battery: the red wire to the positive (+) terminal of the battery and the black wire to the negative (-) terminal. Take care to make the connection secure and free from contact failure or corrosion due to the leakage of battery fluid.
- When leading the power cord into a car, take care that rain does not leak into the car.

NOTE:
If the power cord is connected to a power supply interlocked with the starter key, a cigarette lighter, for example, the memory frequency will not be held even if the BACK UP switch is set to ON.
The unit uses the negative grounding system.

Fig. 6 Connection from Battery

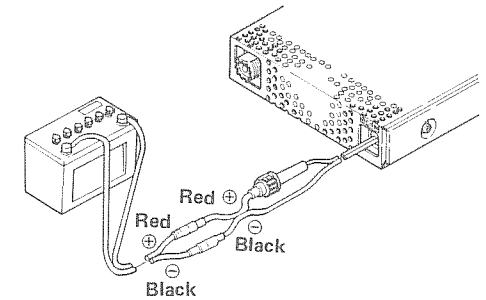

When Used as a Fixed Station

- The unit can also be used as a fixed station. When the unit is installed on a stabilized power supply or a desk, attach the four rubber feet provided to the bottom.

Attaching Rubber Feet

- Each rubber foot has two-sided adhesive paper. First remove the oil and dirt from where the foot is attached, and then peel off the protective paper and attach the foot to the position shown in the following illustration by pushing it firmly.

NOTE:

Leave a margin of 1.5 cm from the both edges of the unit when attaching the rubber foot as shown below. If not, the unit cannot be inserted into the mobile bracket after the four feet have been attached.

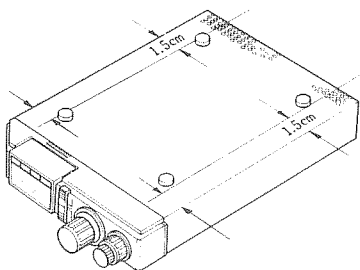

- Use a DC power supply with an output of 13.8 V and current of about 4 A as a stabilized power supply.

Antenna

The antenna type and installation method have a great influence upon transmission and reception.

Select an antenna with a good performance, and adjust carefully after installing the antenna. A ground plane antenna (non-directional) is suitable for local QSO. A Yagi antenna (directional) is suitable for QSO with distant

locations.

Select the optimum antenna according to your purpose and application. If the length of the coaxial cable used for connection between the unit and antenna is too long, there is large loss in the cable.

The coaxial cable should be as short as possible. For a distance up to 10 m, use an 8D2V cable. For a distance of 10 m to 30 m, use a thick cable of more than 10D2V.

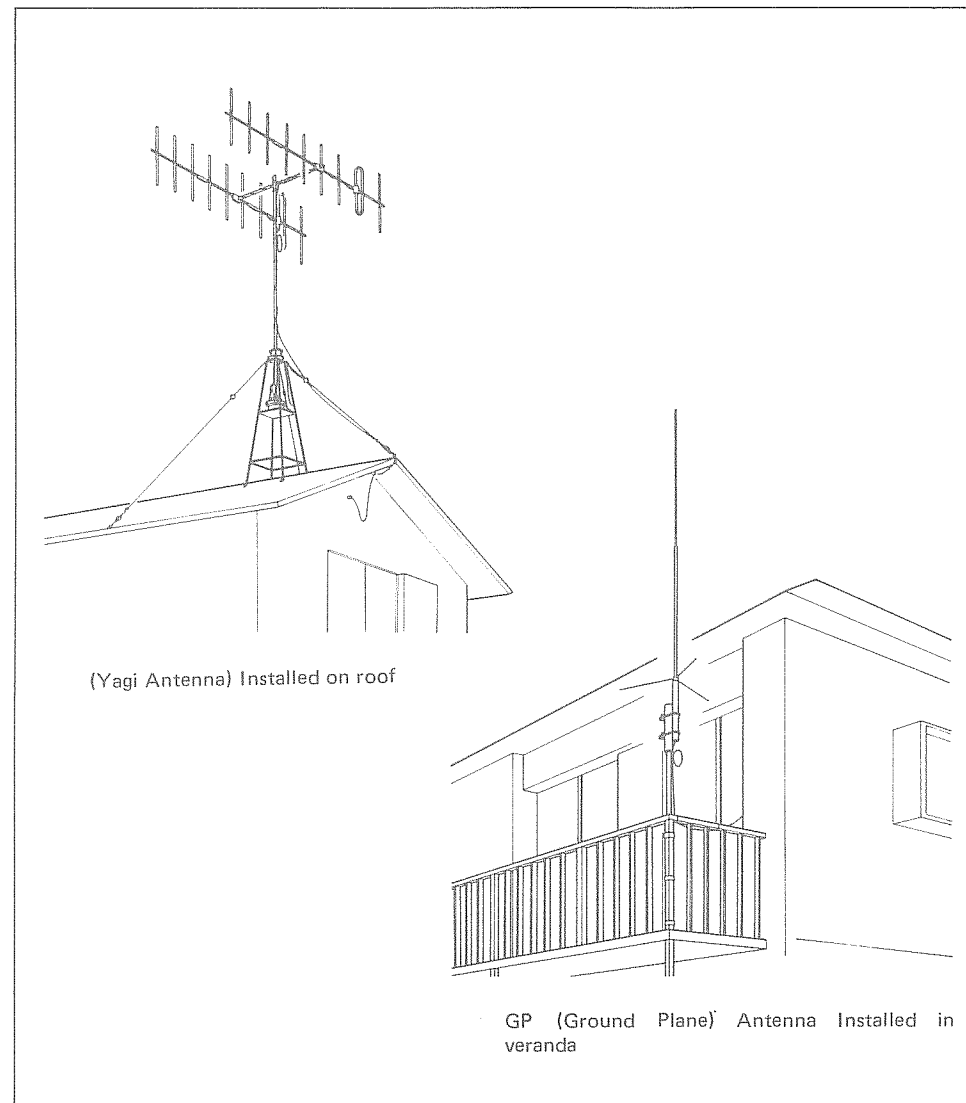

■ OPERATING INSTRUCTIONS

Operation Procedure

After connecting the power cord and antenna, connect the provided microphone to the microphone connector and tighten it securely.

- Turn the OFF/VOL switch to turn on the power. The frequency display LED will indicate 3.000.
- Turn the OFF/VOL switch further clockwise. Noise or sound will be heard.
- Turn the SQL control slowly clockwise, and set it at the position where annoying background noise disappears. (Take care not to turn it too far clockwise. When receiving a weak signal, turn the SQL control counter-clockwise to the position where noise can be heard, and operate in this condition.)
- Preparation have now been completed. Set the desired frequency by operating the tuning control or microphone UP-DOWN switch, and operate the unit.
- When operating in the transmission mode, confirm that the operation frequency does not interfere with other stations.
- When speaking into the microphone, hold the microphone 3 to 5 cm away from your mouth. Where there is too much external noise, move the microphone closer to your mouth.

■ CONVENIENT OPERATION TECHNIQUES

The frequency display section rotation system. The frequency display section is constructed in one block, and this block can rotate 15° upward. To rotate this block, proceed as follows.

NOTE:

To return the display section, always depress the knurled part to release the lock.

(1) To rotate by 15°

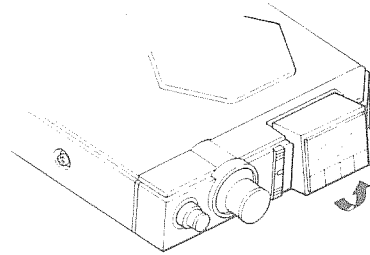

Hold the bottom of the display section and rotate it upward.

(2) To return

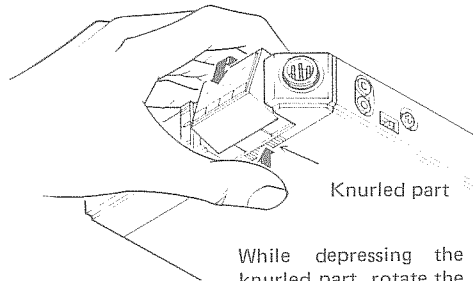

While depressing the knurled part, rotate the frequency section downward.

Cross-Operation

• To shift the reception frequency:

1. Store the shift width beforehand.
2. Set the desired frequency by operating the MHz button and rotary switch or UP-DOWN switch.

2.350

3. Set the RPT switch to the R₁ position. (When the shifting width is 7 MHz.)

9.350

4. Press the press-to-talk switch. Then, the frequency set in step 2 is obtained.

2.350

NOTE:

The reception frequency will be the frequency obtained by adding the shift width to the transmission frequency. If the reception frequency goes out of the amateur band, the frequency display will go OFF.

Example:

Shift width	7 MHz
Transmission frequency	434.000 MHz
Reception frequency	Goes out of the amateur band (1 MHz).
Frequency display	OFF

OFF

When the frequency is shifted into the amateur band by operating the MHz button, rotary switch and UP-DOWN switch, the OFF display disappears and is replaced by the normal frequency display.

• To shift the transmission frequency:

1. Store the shift width beforehand.
2. Set the desired frequency by operating the MHz button and rotary switch or UP-DOWN switch.

2.350

3. Set the RPT switch to the R₂ position.

2.350

4. Press the press-to-talk switch to set the transmission mode, and operate the unit. (When the shift width is 7 MHz.)

9.350

NOTE:

The transmission frequency will be the frequency obtained by adding the shift width to the reception frequency. If the transmission frequency goes out of the amateur band, the frequency display will go OFF.

Example:

Shift width	7 MHz
Reception frequency	434.000 MHz
Transmission frequency	goes out of the amateur band (1 MHz).
Frequency display	OFF

OFF

No signal is transmitted in this condition.

■ SPECIFICATIONS

1. General Specifications

Transmission/Reception frequency	430 — 440 MHz
Type of emission	F3
Power supply	13.8 V DC
Current consumption:	
Transmission	3.4 A
Standby/Reception	0.4 A
Microphone impedance	600 Ω
AF output impedance	8 Ω
Antenna impedance	50 Ω
Grounding system	Negative grounding
Dimensions	138(W) x 31(H) x 178(D)mm
Weight	1.1 kg

2. Reception Specifications

Reception system	Double superheterodyne
Intermediate frequency:	
1st IF	21.4 MHz
2nd IF	455 kHz
Sensitivity	-10 dB (12 dB SINAD)
Pass bandwidth	7.5 kHz (-6 dB)
Selectivity	60 dB min.
Squelch sensitivity	-16 dB
AF output	2 W (10% distortion factor, 8 Ω load)

3. Transmission Specifications

Power output	10 W
Spurious attenuation	60 dB
Maximum deviation	± 5 kHz
Modulation system	Reactance modulation

These specifications are subject to change without prior notice for improvement.

■ OPTIONAL ACCESSORIES

The following optional accessories are available for effective use of the C7900.

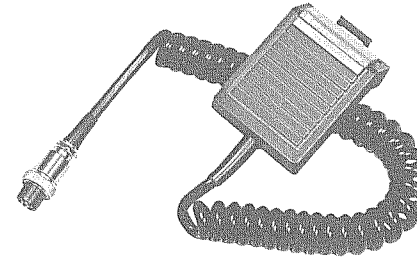

MICROPHONE/SPEAKER MP736



EXTERNAL SPEAKER C207M

SERVICE MANUAL SECTION

■ OPERATING DESCRIPTIONS

RECEIVER SECTION

- The receiver section uses the double super-heterodyne system with 1st and 2nd intermediate frequencies of 21.4 MHz and 455 kHz, respectively.
- The signal input to the antenna terminal (J804) goes through the antenna low-pass filter and antenna selector switch (QT12, QT13), and is applied to the RF band-pass filter LR01.
- After going through LR01 and LR02, the signal is amplified by the RF amplifier QR03 (3SK97 GaAs MES FET), and is applied to the first gate of the 1st mixer QR04 (3SK97) through the band-pass filter LR03.
- In the 1st mixer QR04, the signal is mixed with the local signal (408.6 MHz – 418.575 MHz) from the PLL after the second gate of QR04, and is converted into a signal of 21.4 MHz.
- The signal of 21.4 MHz passes through the 1st IF band-pass filter FR02 (crystal filter 3 dB band ± 7.5 kHz), where the adjacent signal is eliminated, and amplified by the 1st IF amplifier QR05 (2SK241 FET) and applied to pin 16 of QR08 (MC3357).
- QR08 (MC3357) consists of a 2nd mixer, a 2nd local oscillator, a 2nd IF amplifier and limiter, a quadrature detector, a squelch noise amplifier, a squelch mute switch and a BUSY circuit.
- After being applied to the pin 16, the signal is sent to the 2nd mixer, where it is mixed with the 2nd local signal of 20.945 MHz, and converted into a signal of 455 kHz, and applied to pin 3. The adjacent signal is further eliminated by the 2nd IF band-pass filter FR02 (CRW 455E), and is applied to pin 5. The detection output appears at pin 9 through the 2nd IF amplifier, limiter and quadrature detector. The detector output is applied to pin 2 of the AF amplifier PWB (PH60). It is then output to pin 10 through the deemphasis and low-pass filters.

- The sound volume of the AF signal, output to pin 10, is adjusted by the sound volume adjusting control RR26 (20 k Ω -A), and is applied to the AF power amplifier QR09 (HA1366W) to drive the built-in speaker (E801).

Squelch Circuit

- From the detection output generated at pin 9 of QR08 (MC3357), a squelch circuit driving noise (30 – 50 kHz) is amplified by making use of the squelch amplifier located between pin 10 (input) and pin 11 (output) of QR08.
- The selected and amplified noise is output to pin 9 of the squelch amplifier PWB (PH20), rectified by the diodes QR06 and QR07 (OA91), and applied to pin 12 of QR08.
- For the squelch ON-OFF threshold point, the squelch turns on when the voltage applied to pin 12 of QR08 is greater than 0.7 V, and the squelch turns off when the voltage is smaller than 0.7 V.
- By operating the squelch adjusting control RR26 (20 k Ω -B) the noise rectify voltage is divided by RF20 (10 k Ω) and RP26 (squelch control), controlling the voltage applied to pin 12 of QR08.
- When the voltage rises to over 0.7 V at pin 12 of QR08, the internal impedance of pin 14 of QR08 is switched from several ohms to several tens of ohms.
- As the impedance of pin 14 of QR08 rises, bias is applied to the base of the squelch amplifier QH20 to turn on QH20 and QH21, generating a voltage (approx. 3 V) at pin 5 (the collector of QH21) of the squelch PWB PH20.
- The collector voltage of QH21 is applied to the emitter of the AF amplifier QH60 through pin 1 of the AF amplifier PWB. Then, the emitter voltage of QH60 rises higher than the base voltage, and cuts off QH60 thereby cutting off the AF signal.

Meter Circuit

- The signal taken out from pin 5 of QR08 is applied to pin 3 of the S meter amplifier PWB, and amplified by QH40 (2SK210) and QH41 (2SC2714). The amplified signal is

rectified by QR10 and QR11, its level is adjusted by RP22 (47 k Ω), and it is applied to the meter comparator Q801 (TA7654P).

BUSY Circuit

- The BUSY output voltage generated at pin 13 of QR08 is divided by a resistor, its level is adjusted by RP21 (330 k Ω), and it is applied to the meter comparator Q801 (TA8654P).

Features of Meter comparator (TA7654P)

- TA7654P has two independent input circuits. LEDs light in response to the peak voltage of any of the inputs. C7900 takes one input (pin 2) as the input exclusive to the S meter of the receiver, and uses the other input (pin 3) for Busy display and transmitter meter.

TRANSMITTER SECTION

1. Younger Amplifier

When the transmitter section is set for transmission, a current flows in the PLL output switching diode Q108 to turn it on, and a signal of about 1 mW (220 mV at 50 Ω) is applied to the younger amplifier QT01. The younger amplifier consists of two stages, QT01 and QT02. The input signal of 1 mW is amplified here by about 23 dB to form an output of 200 mW, that is large enough to drive a power amplifier in the next stage. Power of the younger amplifier is supplied from the stabilized TX 8 V line.

2. Power Amplifier

The signal amplified by the younger amplifier is applied to the hybrid IC M57704, where it is amplified up to about 15 W. M57704 consists of an amplifier with three internal stages. An APC voltage is applied to control the power to the power supply terminal provided in the first stage.

The power which has gone through a switch is applied to the second stage. The third stage is directly connected to the power cord.

The amplified signal of 15 W goes through three stages of LPF and diode switch, where the higher harmonic components are sufficiently attenuated, and then output from there.

3. APC Circuit

This is an RF detector type APC circuit, and detects parts of the output of QT09. The detected signal is applied to the TX meter circuit and APC amplifier. The base voltage of QT06 is varied by the detected signal, and amplified by QT07, controlling the output voltage of QT08 2SD313 to keep the power constant. A reference voltage of about 1 V is applied from RT05 to the emitter of QT06. When the heat sink temperature rises abnormally, the resistance value of RT11 posistor increases to lower the emitter voltage controlling the power, thereby preventing the set from abnormally high temperatures.

CONTROL SECTION

The control section consists of the following parts.

Microcomputer (QL03)
Keyboard
Rotary switch
RPT switch

Microcomputer (QL03) has the following inputs and outputs to control external circuits.

1. Outputs

1. PLL output (BCD code)

A 13-bit BCD code is output from the terminals 2 to 5, 8 to 11, 30 and 37 to 40 of QL03.

2. Display drive output

The output signals from terminals 12 to 19 of QL03 control the segment. The outputs of the pins 22 to 25 control the digits. The LED is a 7-segment 4-digit display.

3. Buzzer output

Terminal 31 of QL03 is usually at low level. It is changed to high level by key operation.

When the control terminal 6 of QL02 goes to high level, the potential is zero at terminal 8 and the buzzer oscillation circuit QL01 operates.

The output of QL01 goes through the oscillation level adjusting trimmer resistor RL01, and is applied to terminal 6 of the audio amplifier QR09 to drive the speaker. The buzzer oscillation circuit is a CR oscillator.

2. Inputs

1 Reset

When the input voltage of the equipment drops to below 7.5 V, the switching transistor QL11 turns on and a negative pulse is applied to terminal 7 of QL03, clearing QL03.

Since QL12 uses a 1-diode, QL11 turns on when the base voltage of QL11 reaches the preset level (RL35).

2 Microphone UP-DOWN and PTT switches

The signal from the microphone UP-DOWN switch is applied to terminals 5 (DOWN) and 13 (UP) of the analog switch QL02 (to set the level to high). By this operation, the signal is sent from terminal 4 of QL02 to terminal 29 of QL03 (DOWN).

The signal is also sent from terminal 1 of QL02 to terminal 28 of QL03 (UP). Likewise, a PTT signal is sent from terminal 11 of QL02 to terminal 26 of QL03, controlling the microcomputer.

3 Oscillator

As a standard oscillation circuit to operate the microcomputer QL03, a ceramic vibrator XL01 is inserted between terminals 1 and 42 of QL03 to obtain a clock frequency of $2.5 \mu\text{s} \pm 0.1 \mu\text{s}$ in the circuit provided within QL03 (400 kHz).

4 RPT switch (R₁-S-R₂)

The microcomputer is controlled by the RPT switch S801 by shorting terminals 28 and 14 of QL03 when the switch is set at the R₁ position, and terminals 27 and 14 of QL03 at the R₂ position respectively.

5 Rotary switch

The pulse signal from rotary switch S802 is used to control the microcomputer. The UP side of S802 is connected to terminal 33 of QL03, while the DOWN side is connected to terminal 34 of QL03. QL03 detects rising of the pulse.

6 Keyboard

The keyboard consists of 4 keys in total: MHz, CALL, MEMO and SCAN/CCL.

1) MHz key:

The MHz key is actuated by closing terminals 13 and 29 of QL03. When

this key is pressed continuously, the figure increases continuously.

2) CALL key:

Press this key to transmit a tone burst signal for driving the repeater (tone frequency: 1750 Hz).

3) MEMO key:

The MEMO key is actuated by closing terminals 13 and 27 of QL03. This key performs calling and writing of the memory frequency.

4) SCAN/CCL key:

The SCAN/CCL key is actuated by closing the terminals of QL03.

3. Backup Circuit

The backup power supply to QL03 is 5 V supplied from the 3-terminal regulator QR13 via the backup switch SL01.

PLL SECTION

The PLL circuit in C7900 is controlled the frequency by 13-bit BCD codes from the microcomputer.

The circuit directly oscillates a transmitting frequency in the transmission mode, and a frequency which is lower by the first intermediate frequency (21.4 MHz) in the receiving mode.

PLL Basic Block:

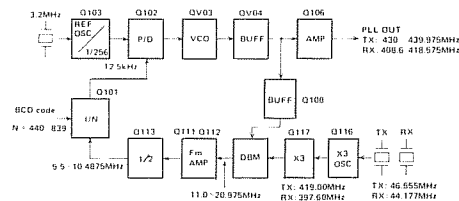

1. Programmable Counter (Q101)

The dividing ratio N is determined by the BCD code from terminals 2 to 5, 8 to 11, 30 and 37 to 40 of μCOM (QL03). The dividing ratio N of C7900 uses 440 to 839. BCD code signals are applied to terminals 3 to 15 of Q101. The signal of 5.5 to 10.4875 MHz from Q113 (Prescaler) is applied to the terminal 2 of Q101. The signal of 5.5 to 10.4875 MHz is divided at the determined dividing ratio, and is applied to the phase detector circuit Q102.

Calculation of Dividing Ratio (N)

$$\text{Desired frequency [(MHz) - 419 MHz] } \div 2 \div 12.5 \text{ kHz} = \text{Dividing frequency}$$

Example:

Formula to calculate the dividing frequency of 433.000 MHz

$$N = [(433.000 - 419) \div 2] \div 0.0125 = 560$$

Frequency Read (MHz)	Dividing Ratio (N)	Q101 (TC9123P) Pin Number													
		15	14	13	12	11	10	9	8	7	6	5	4	3	
430.00	440	0	0	1	0	0	0	1	0	0	0	0	0	0	0
430.025	441			1	0	0	0	1	0	0	0	0	0	1	
↑	↑			1	1	1	1	1	1	1	1	1	1	1	
435.00	640	0	0	1	1	0	0	1	0	0	0	0	0	0	
435.025	641	0	0	1	1	0	0	1	0	0	0	0	0	1	
↑	↑	1	1	1	1	1	1	1	1	1	1	1	1	1	
439.975	839	0	1	0	0	0	0	0	1	1	1	0	0	1	

2. Reference Frequency Oscillator Circuit Q103

Q103 is a PLL frequency synthesizer IC. A signal of 3.2 MHz can be obtained at terminal 1 of Q103. A signal of 12.5 kHz divided by 1/256 can be obtained at terminal 1 of Q103. A signal of 12.5 kHz divided by 1/256 can be obtained at terminal 5 of Q103.

3. Phase Detector Circuit (P/D) Q102

1 The phase detector circuit detects the phase difference the 12.5 kHz frequency obtained by dividing the 3.2 MHz reference frequency by 1/256 and the programmable counter output frequency. The 12.5 kHz signal furnished from terminal 5 of Q103 is applied to terminal 5 of Q102. The signal from terminal 17 of the programmable counter Q101 is applied to terminal 7 of Q102.

2 The detected differential phase signal is obtained at terminal 3 of Q102. This signal is converted into a DC voltage by a C/R integration circuit. The DC voltage is applied to the varicap diode (QV01), which determines the VCO output frequency.

4. VCO Circuit

1 The VCO output frequency is controlled by the varicap diode whose capacity is varied by changes in the DC voltage applied to QV01.

2 The modulation circuit employs the system which varies the voltage between the gate and source of QV03 by applying an audio signal to the source of QV03 (2SK125).

5. Local Oscillator

1 The local oscillator consists of X102, X103 and Q116. It uses two crystals: X102 (44.177 MHz) for RX and X103 (46.5555 MHz) for X103.

2 The oscillator output is multiplied by 3 times by the coils L112 and L113 of the collector of Q116, providing 139.66 MHz and 132.53 MHz.

3 The multiplied signal is further multiplied by 3 times by Q117. L114 functions to eliminate unnecessary spurious components of the multiplied signal. The multiplied 419 MHz and 397.6 MHz go through the toroidal coil and are applied to DBM Q110 (Double Balanced Mixer).

6. DBM (Double Balanced Mixer)

1 Signal from the VCO goes through the buffer amplifiers QV04 and Q109, and is applied to the toroidal coil L105. The signal from the VCO and the local oscillator output are mixed by Q110, L105 and L106, generating a signal of 11.0 to 20.975 MHz.

2 The DBM output goes through LPF (C124, L107 and C125), and is amplified by Q111 and Q112. The amplified signal is applied to terminal 1 of the prescaler IC Q113, where it is divided by 1/2 to become a signal of 5.5 to 10.4875 MHz, and applied to terminal 2 of the PLL IC Q101.

7. Output Amplifier

The VCO output is amplified by QV04 and Q105. The amplified signal is coupled to the output switching circuits Q107 and Q108, where it is switched to the transmitter or receiver mode, and then is supplied to the transmitter or receiver section. Q107 sends the signal to the receiver section, while Q108 sends it to the transmitter section.

8. Unlock Switch Circuit (Q104 and Q105)

- 1 Q106 (AMP) and QT01 are controlled by the unlock switch circuit composed of Q104 and Q105, and stops the PLL output and transmitter younger stage operation.
- 2 When the PLL circuit is unlocked, the DC voltage from terminal 4 of the phase detector circuit Q102 drops. This causes Q104 and Q105 to turn on, dropping the base voltages of Q106 and QT01. As a result, Q106 and QT01 are made to cut off, and an unnecessary wave is not emitted while the PLL circuit is unlocked.

■ DISASSEMBLY

1 Disassembling the case of the unit

- (1) Remove 4 screws (1 through 4) holding both side panels.
- (2) Remove 4 screws (A through D) and E holding the upper panel.
- (3) Loosen 2 screws (F) holding the speaker mounting bracket (do not remove them).
- (4) Slide the case to the rear.

NOTES:

1. Before disassembling or reassembling, be sure to loosen the speaker mounting bracket retaining screws.
2. The loosened speaker mounting bracket must be retightened after disassembling or reassembling.

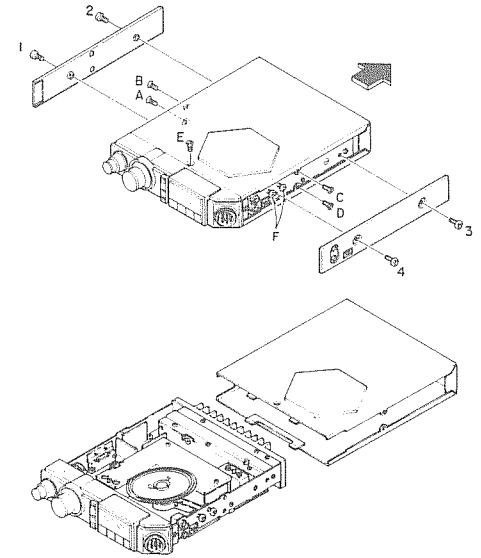

2. Removing the front dracket

- (1) Remove the VOL knob and two squelch knobs, and take off the nut and washer holding the volume control.
- (2) Remove 7 connectros (JM01, JM02, J805, J806, J807 and J809).
- (3) Remove 2 screws (1 and 2) holding the front bracket.
- (4) Disconnect 2 wires, then, the front bracket can be taken off.

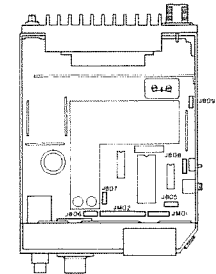
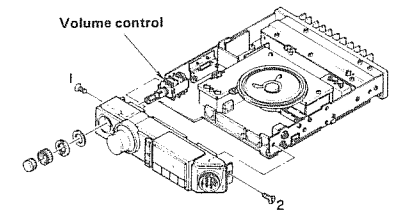

DISASSEMBLY

1 Disassembling the case of the unit

- (1) Remove 4 screws (1 through 4) holding both side panels.
- (2) Remove 4 screws (A through D) and E holding the upper panel.
- (3) Loosen 2 screws (F) holding the speaker mounting bracket (do not remove them).
- (4) Slide the case to the rear.

NOTES:

1. Before disassembling or reassembling, be sure to loosen the speaker mounting bracket retaining screws.
2. The loosened speaker mounting bracket must be retightened after disassembling or reassembling.

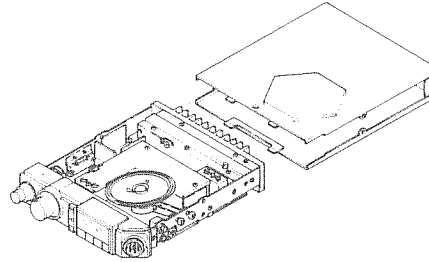
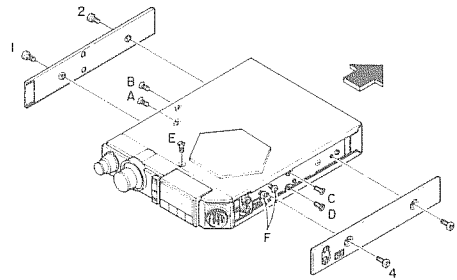

2. Removing the front dracket

- (1) Remove the VOL knob and two squelch knobs, and take off the nut and washer holding the volume control.
- (2) Remove 7 connectros (JM01, JM02, J805, J806, J807 and J809).
- (3) Remove 2 screws (1 and 2) holding the front bracket.
- (4) Disconnect 2 wires, then, the front bracket can be taken off.

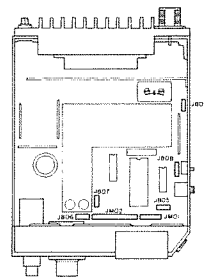
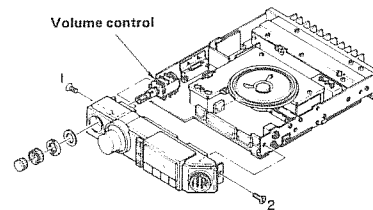

BLOCK DIAGRAM

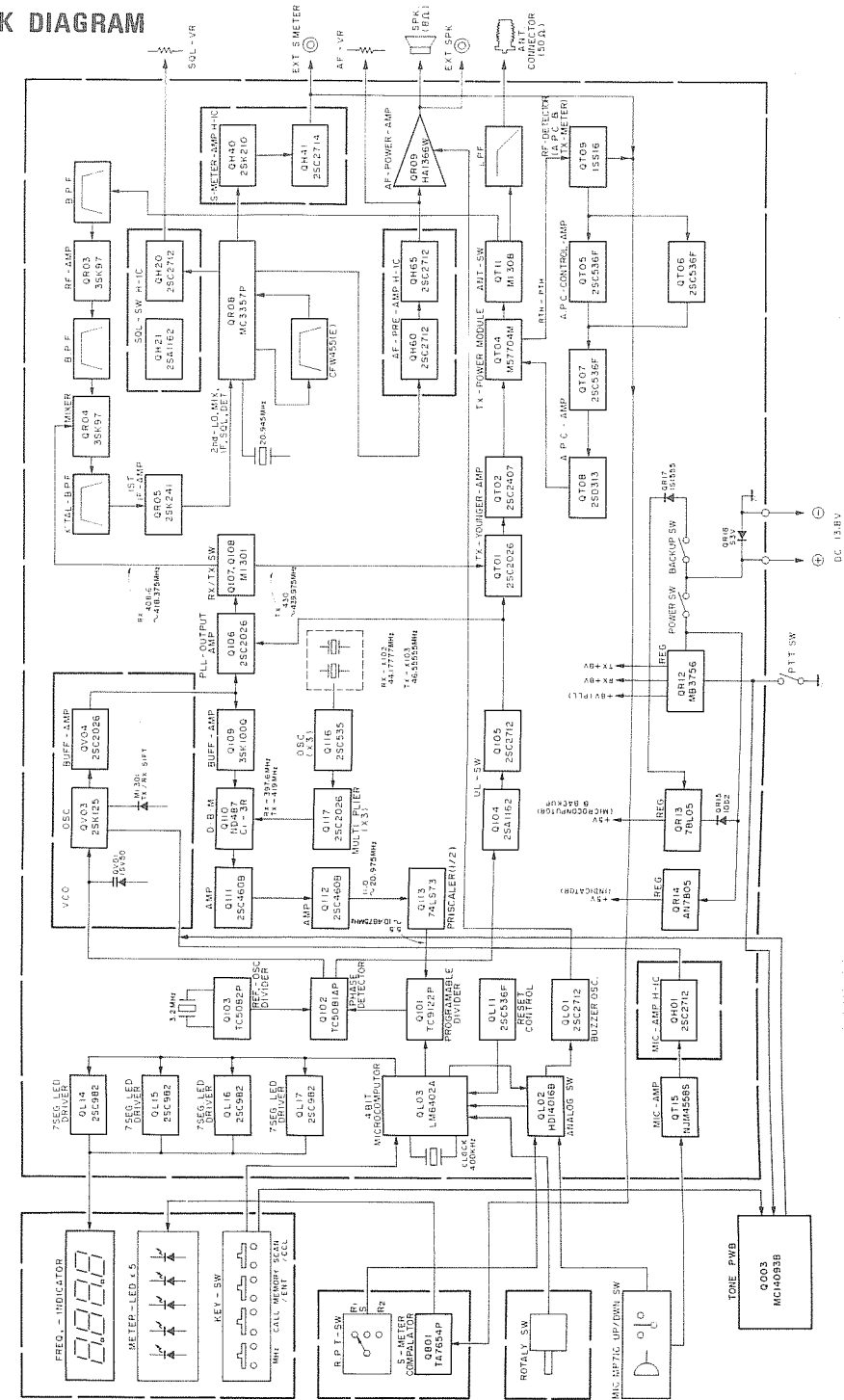

■ ADJUSTMENT POINTS

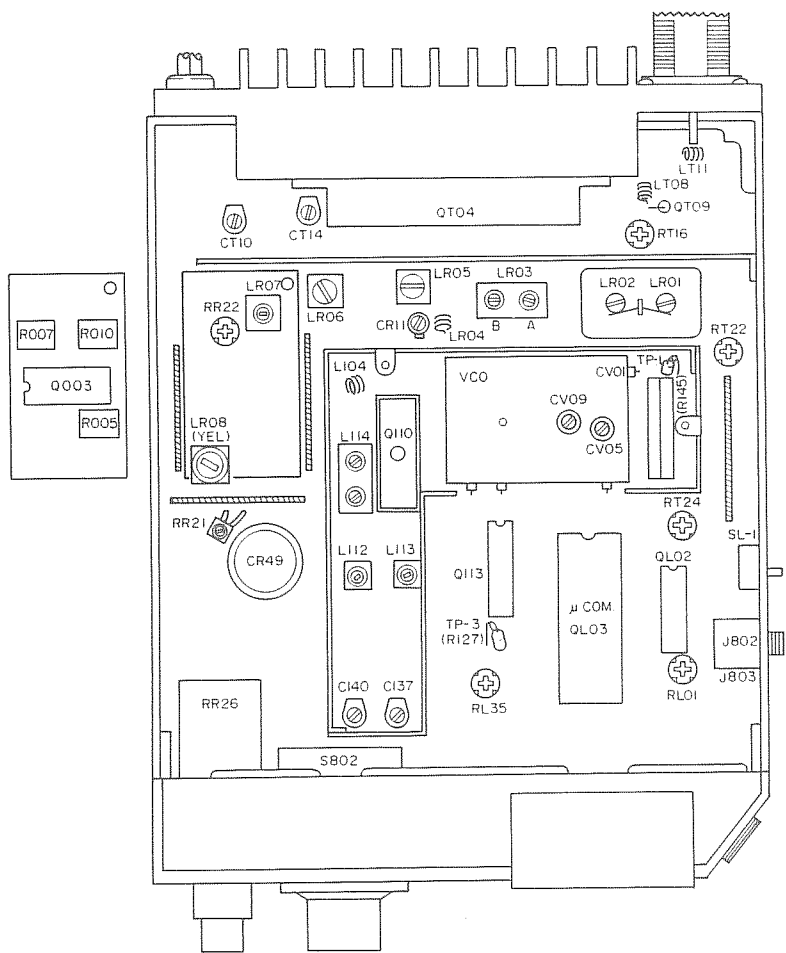

*Leistung
5-10 W*

■ TX ADJUSTMENT SET-UP

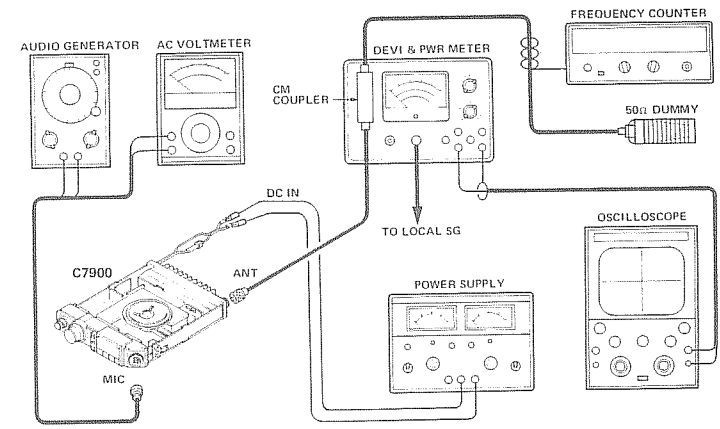

■ RX ADJUSTMENT SET-UP

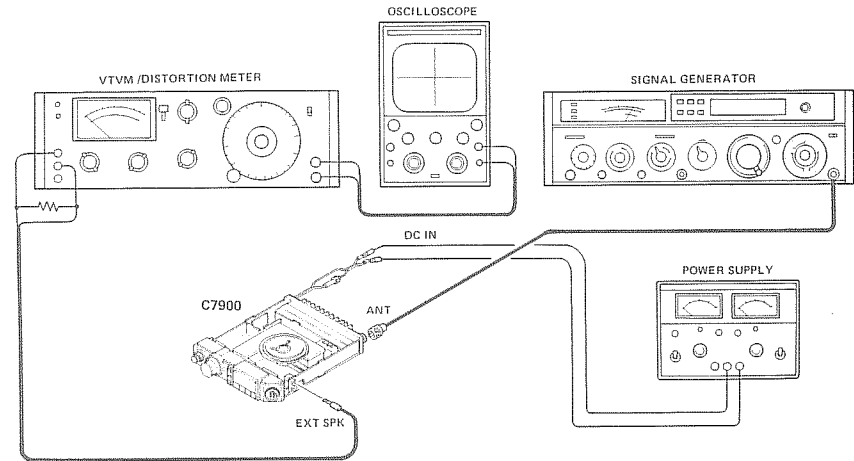

BLOCK DIAGRAM

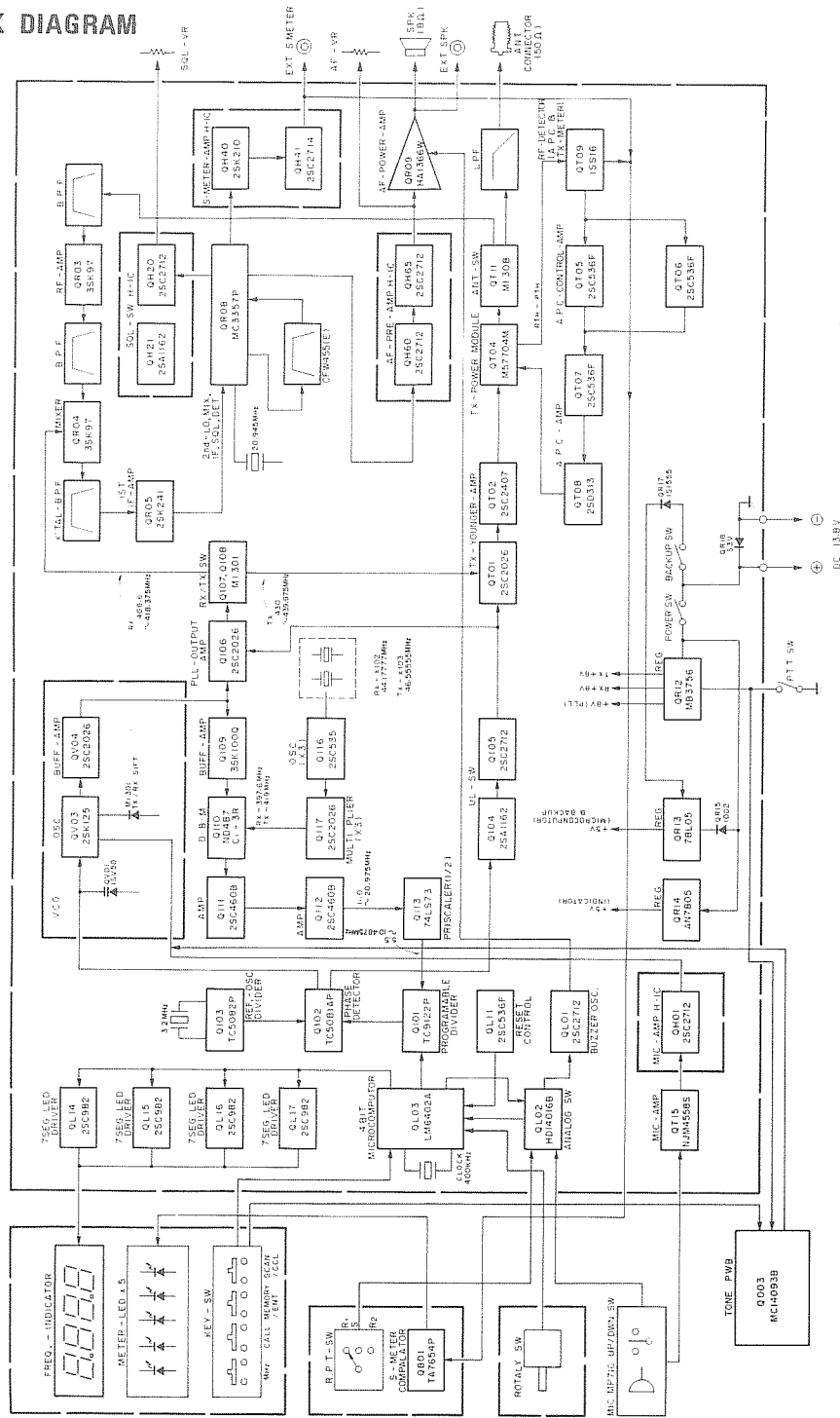

ALIGNMENT PROCEDURE

STANDARD CONDITIONS

Supply voltage	13.8 V DC
Audio output	0.5 W
Audio output loading	8 Ω
Deviation	±3.5 kHz at 1000 Hz
Transmission load	50 Ω
Reception frequency	435.00 MHz
Transmission frequency	435.50 MHz
SQL volume	OFF
RPT switch	S

Unless otherwise specified, adjustments should be made in the above conditions. The asterisked items (*) in the procedure must not be adjusted except when replacing parts.

MICROCOMPUTER SECTION

- **Reset Voltage Adjustment**
Set the constant-voltage power supply output voltage to 7.5 V (accurately). Adjust the voltage with RL35 to the point where the 4-digit LED (QM01) goes out.
- **Buzzer Sound Volume Adjustment**
Set the constant-voltage power supply output voltage to 13.8 V (accurately). Connect an AC voltmeter to the external speaker terminal. (The load resistance should be 8 Ω.) Adjust RL01 so that the voltmeter indicates 0.07 V.

Then, fine adjust L114 so that no level difference of TP3 is detected in both receiving and transmission modes.

- **VCO Frequency Adjustment**
 1. Connect a DC voltmeter to CV01. (Use a high precision voltmeter.)
 2. Set the adjusting frequency to 439.975 MHz. Set the frequency display of C7900 to 439.975 MHz, and set the transmission mode.
 3. Adjust CV05 so that the DC voltmeter connected to CV01 indicates 6 V.
 4. Set the receiving mode, and adjust CV09 so that the DC voltmeter indicates 6 V. CV01 is a through-type condenser.

PLL SECTION

- **Reference Output Frequency Confirmation**
 - * Connect a frequency counter to TP1 (R148).
 - * Confirm that the frequency counter indicates 3.2 MHz ±32 Hz.

- **Transmitter Section Alignment**
 - 1* Turn the trimmer resistor RT16 fully clockwise. Set CT10 and CT14 to their mechanical centers.
 - 2* Compress LT11 (2T coil) as far as possible.
 3. Set the transmission mode, and adjust CT10 and CT14 so that the current consumption becomes maximum. At this time, the output becomes about 15 W and a current of about 4 A flows.
 4. Adjust the trimmer resistor RT16 so that the output of 12 W is obtained. When the output is 12 W, the current will be about 3.2 A. (The current should be lower than 3.5 A.) The transmission output difference should be 2.5 W or smaller (around 1 W).

(1) If the output cannot be lowered to

- **Local Oscillator Circuit Adjustment**
 1. Connect an RF VTVM to TP3.
 - 2* Set trimmer condensers C137 and C140 to their mechanical centers.
 3. Adjust L112 so that the RF VTVM indicates the maximum value in the receiving mode.
 4. Set the transmission mode, and adjust L113 so that the RF VTVM indicates the maximum value.
 5. Repeat steps 3 and 4 by 2 or 3 times.
 6. Set the transmission mode, and adjust L114 so that the RF VTVM connected to TP3 indicates the maximum value.

below 12 W, move QT09 (1SS16) towards LT09. (Take care that they are not too close.)

(2) *If the current is too large with an output of 12 W, vary the pitch of the 2T coil (LT11) slightly. Take care not to vary it too much.

(3) All LEDs go out in the TX mode. No adjustment is needed.

• Transmit/Receive Frequency Adjustment

1. Set the frequency of C7900 to 435.500 MHz.
2. Set the transmission mode, and adjust C140 so that the transmission frequency becomes 435.500 MHz \pm 100 Hz.
3. Set the frequency of C7900 to 435.000 MHz.
Connect a frequency counter to LR04 (3T air core coil). Adjust C137 so that the receiving frequency becomes within 413.600 MHz \pm 100 Hz in the receiving mode.

• Diviation Adjustment

1. Set the frequency of the unit to 435.500 MHz.
- 2.* Turn RT22 fully clockwise.
3. Apply an audio signal of 1000 Hz, 15 mV (open voltage) to the microphone terminal.
4. Set the transmission mode, and adjust RT24 so that a deviation of \pm 5 kHz is obtained.
5. Reduce the audio signal level to 1.5 mV, and adjust RT22 so that a deviation of \pm 3.5 kHz is obtained.

• Tone Frequency and Deviation Adjustment

1. Connect a deviation meter to the antenna connector. Connect a frequency counter and oscilloscope in parallel to the output terminal of the deviation meter.
2. Press the CALL button, and adjust R007 so that a tone frequency of 1750 Hz is obtained.
Adjust R10 so that a tone deviation of \pm 3.5 kHz is obtained.
3. After adjusting the deviation, press the PTT switch twice, and adjust R005 so that the function time of 0.8 to 1.2 seconds of the tone burst circuitry is obtained.

4. After adjusting the tone deviation, be sure to check the deviation of the unit.

NOTE:

The tone burst circuitry should not function when the PTT switch is pressed once. Re-measure after 10 seconds.

NOTE*:

Adjustment should be made with the tone burst circuitry connected.

• Tone Adjustment

1. Press the CALL button, and adjust R007 so that a tone frequency of 1750 Hz is obtained.
2. Press the CALL button, and adjust R010 so that a deviation of 3.5 kHz is obtained.
3. Press the PTT ON switch twice, and adjust R005 so that a tone time of 1 second \pm 0.2 is obtained.
4. After adjusting the tone, be sure to check the deviation of the microphone input.

NOTE:

The tone burst circuitry should not operate when the PTT switch is pressed once. Re-measure after 10 seconds.

RECEIVER SECTION

• Sensitivity Adjustment

1. Connect a VTVM to the SPKR terminal.
2. Deviate the RF SG output to 435.000 MHz, 1000 Hz and 3.5 kHz. The output level should be the minimum necessary.
3. Adjust LR08 (yellow) so that the audio output (SPKR OUT) becomes maximum.
4. Connect a DC voltmeter to the EXT. METER terminal. Adjust LR05, LR06, LR07 and CR11 so that the voltmeter indicates the maximum value.

NOTE:

As the adjustment advances, the DC voltmeter indicates larger values. Adjust while reducing the RF SG output level. The optimum reading of the DC voltmeter is about 0.1 V.

• RX RF Circuit Adjustment

- 1.* Loosen the screws of LR01 and LR02 upward, and insert the core of LR03. Turn the meter adjusting trimmer resistor RR22 fully clockwise.

2. Set RF SG to 435.000 MHz, deviation \pm 3.5 kHz, and the frequency to 1 kHz, about 30 dB. Connect a tester to the external meter terminal. (0.3 V range)
3. Receive a signal, and adjust the coils in the order specified below so that the meter pointer deflection becomes maximum. (Vary the RF SG so that the meter always indicate about 0.1 V.)
 - (1) Adjust the peak LR03-A
 - (2) Adjust the peak by loosening LR03-B.
 - (3) Fine adjust by tightening LR03-A.
 - (4) Repeat (2) and (3) 2 or 3 times to complete fine adjustment.
 - (5) Adjust LR01 completely.
 - (6) Adjust LR02 completely.
Adjustment of LR01 and LR02 should not be repeated.
 - (7) Push in the core of LR02 by 1/2T.
 - (8) Pull out the core of LR03-A by 1/2T.
Then, each core position becomes as follows.
LR01 Core length is about 4 mm.
LR02 Core length is about 4 mm.
LR03-A Inserted by 1T from the surface.
LR03-B Inserted by 1T from the surface.

4. After this adjustment, QS will be about -8 dB and SINAD will be about -10 dB. The QS sensitivity defference in the band should be within 3 dB.

• Busy Lamp Adjustment

Set the condition with no signal, SQL OFF, and adjust the trimmer resistor RR21 so that the green LED goes to the intermediate state between the beginning of the 1st LED's lighting and the beginning of the 2nd LED's lighting. (Set to the middle position in the range of the 1st LED's lighting.)

• S Meter Adjustment

Receive a non-modulated signal of 436.00 MHz, 0 dB, and adjust the trimmer resistor RR22 to set the meter to the position where the 2nd green LED begins to light.

■ PIN LOCATIONS

 2SC536F	 2SC2026	 2SK125	 2SK241(GR)	 2SC982 2SC460(B) 2SC535(B)
 μPC78L05	 AN7805	 2SD313	TOP VIEW 2SC2714(O) 2SA1162(GR) 2SC2712	TOP VIEW 2SK210(GR)
TOP VIEW HD14016B TA7654P	TOP VIEW 74LS73	TOP VIEW MC3357	TOP VIEW TC9122P	TOP VIEW LM6402
 SIDE VIEW MB3756	 SIDE VIEW HA1366W	 SIDE VIEW NJM4558S		
 SIDE VIEW TC5081AP TC5082	 SIDE VIEW M57704M	TOP VIEW 3SK100 3SK97		

■ COMPONENT LOCATIONS FOR PLL

SOLDER SIDE

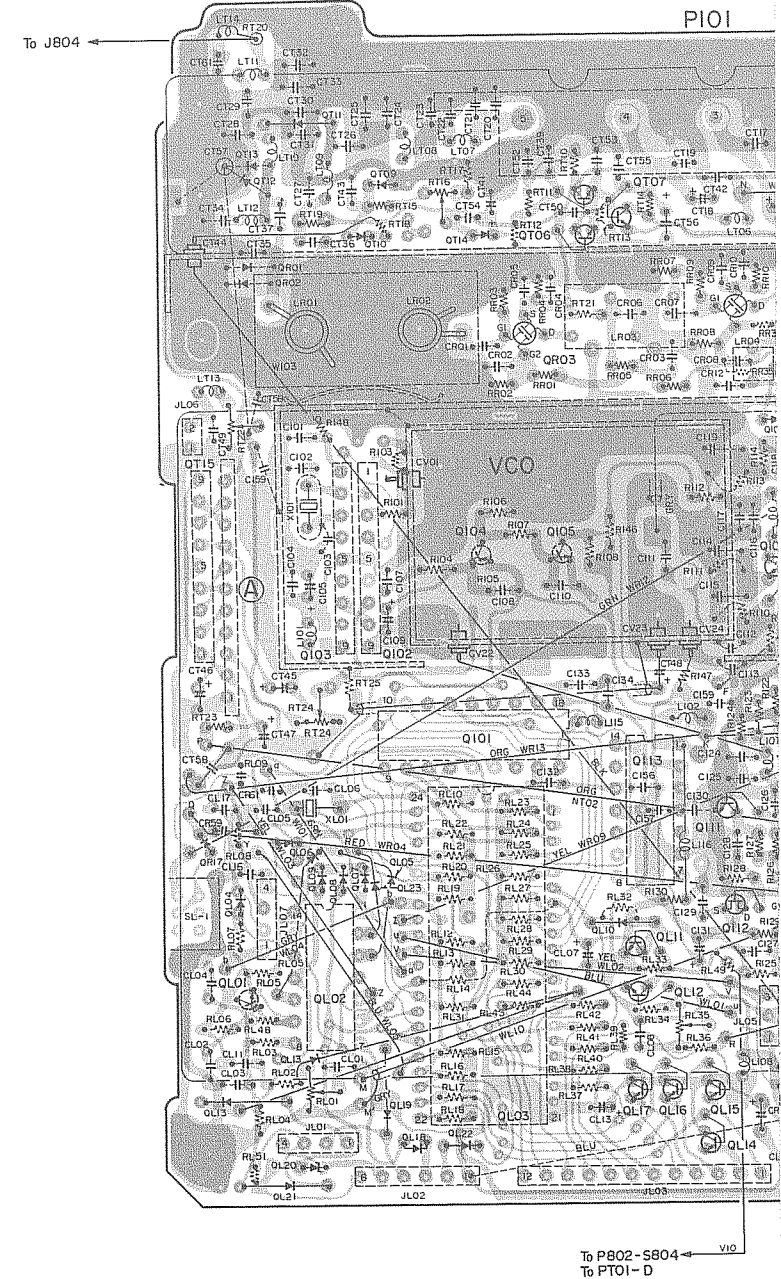

■ COMPONENT LOCATIONS FOR PLL

SOLDER SIDE

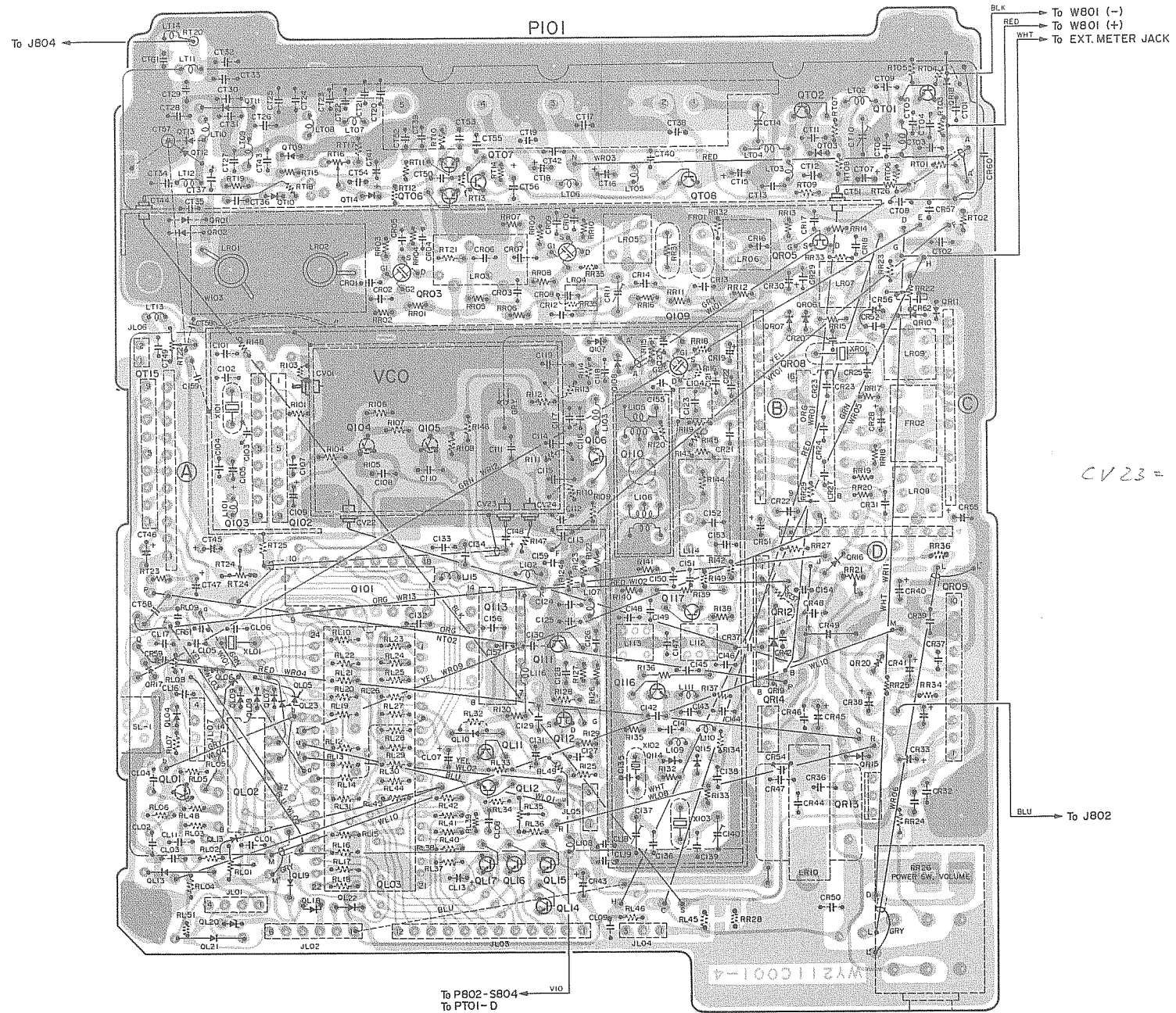

■ COMPONENT LOCATIONS

VCO(PV01)

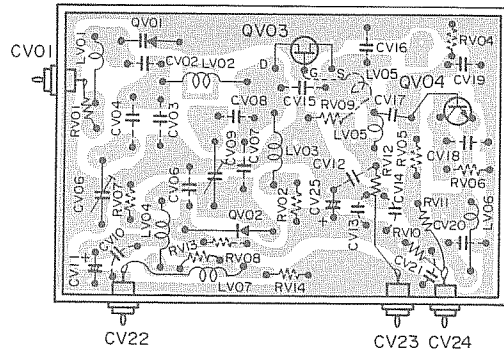

SQL AMP.(PH01)

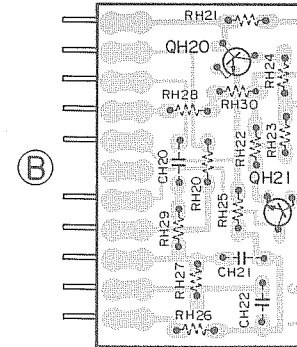

METER AMP.(PH40)

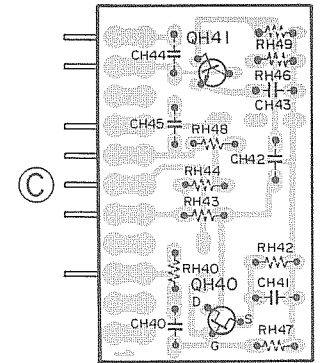

TONE AMP.(PT01)

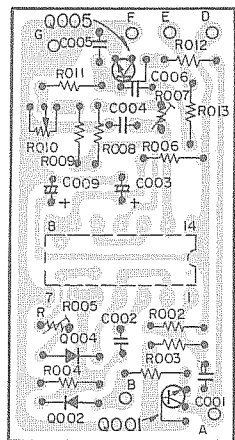

MIC AMP.(PH01)

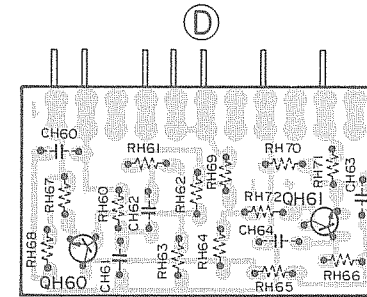
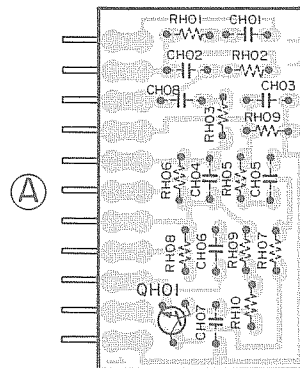

■ EXPLODED VIEWS AND PARTS LISTS

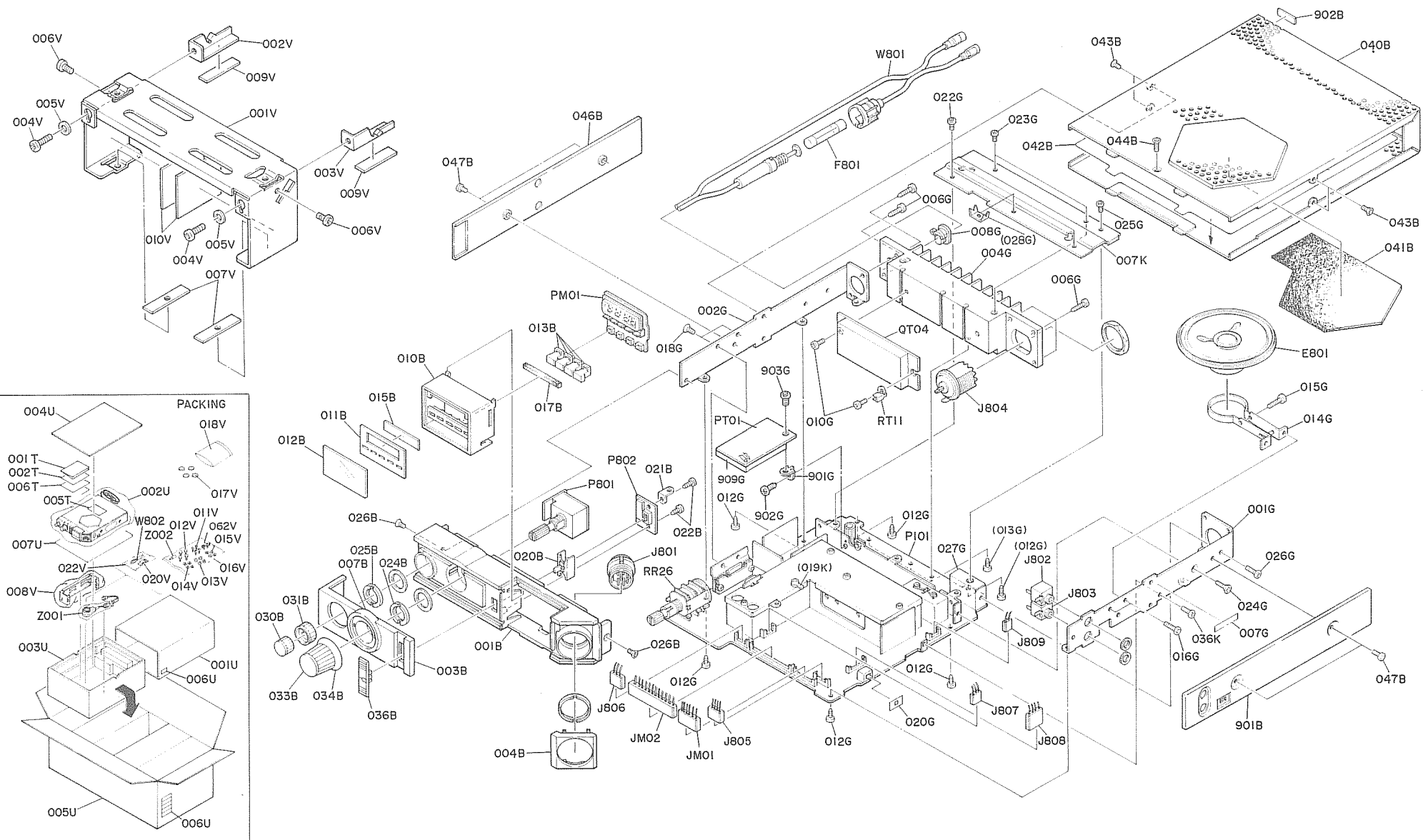

REF. PART NO. QTY. DESCRIPTION

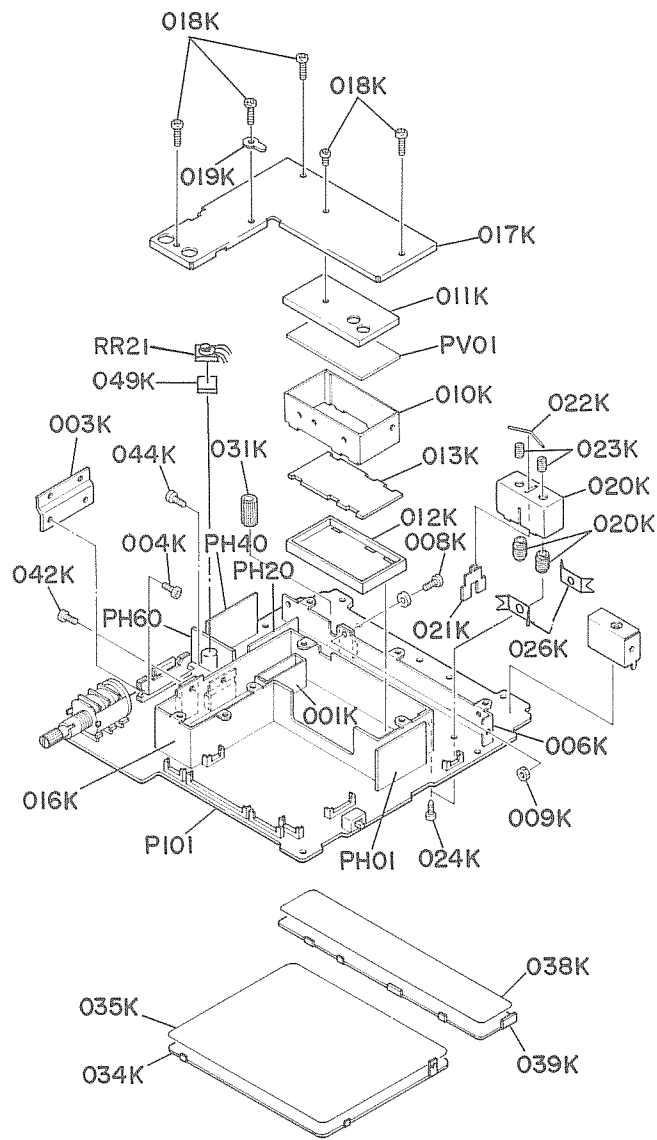

REF. DESIG.	Q'TY	PART NO.	DESCRIPTION
042K	1	51102604A0	B.H.M. Screw B2.6 x 4
044K	1	51102604A0	B.H.M. Screw B2.6 x 4
049K	1	211C122010	Stecker
PH01	1	WZ211C0110	P.W. Board, Mic Amp.
PH20	1	WZ211C0310	P.W. Board, SQL Amp.
PH40	1	WZ211C0210	P.W. Board, Meter Amp.
PH60	1	WZ211C0410	P.W. Board, Audio Pri Amp.
RR21	1	RA03340030	Trimming 330KΩ

REF. DESIG.	Q'TY	PART NO.	DESCRIPTION
P101	1	YF211C0010	P.W. Board, Main
PV01	1	WZ211C0510	P.W. Board, VCO
001K	1	211C109010	Shield (Balanced MIX)
003K	1	211C109020	Shield (Audio IC)
004K	2	51102606A0	B.H.M. Screw B2.6 x 6
006K	1	211C109030	Shield (APC)
007K	1	211C109040	Shield (APC)
008K	1	51100306A9	B.H.M. Screw B3 x 6
009K	1	53110303A9	Hexagon Nut M3
010K	1	211C109040	Shield (VCO)
011K	1	211C109050	Shield (VCO Top)
012K	1	211C109060	Shield (VCO Bottom)
013K	1	211C120020	Insulator (VCO)
016K	1	211C109070	Shield (PLL)
017K	1	211C109080	Shield (PLL Top)
018K	5	51100204E0	B.H.M. Screw B2 x 4
019K	1	62021030W0	Lug
020K	1	4724109120	Shield (Cavity)
021K	1	4724109130	Shield (Cavity)
022K	1	4724115010	Spring
023K	2	4724161020	Ferric Core (Cavity)
024K	2	51282605B0	B.H. Tapped Screw B2.6 x 5
025K	2	4724275010	Bobbin
026K	2	102C115030	Spring
027K	1	211C109140	Shield
028K	1	211C120050	Insulator
031K	1	026C267010	Heatsink
034K	1	211C109090	Shield (TX)
035K	1	211C120060	Insulator (TX)
038K	1	211C109100	Shield (Local)
039K	1	211C120040	Insulator (Local)

REF. DESIG.	Q'TY	PART NO.	DESCRIPTION
P101	1	YF211C0010	P.W. Board, Main
PV01	1	WZ211C0510	P.W. Board, VCO
001K	1	211C109010	Shield (Balanced MIX)
003K	1	211C109020	Shield (Audio IC)
004K	2	51102606A0	B.H.M. Screw B2.6 x 6
006K	1	211C109030	Shield (APC)
007K	1	211C109110	Shield (APC)
008K	1	51100306A9	B.H.M. Screw B3 x 6
009K	1	53110303A9	Hexagon Nut M3
010K	1	211C109040	Shield (VCO)
011K	1	211C109050	Shield (VCO Top)
012K	1	211C109060	Shield (VCO Bottom)
013K	1	211C120020	Insulator (VCO)
016K	1	211C109070	Shield (PLL)
017K	1	211C109080	Shield (PLL Top)
018K	5	51100204E0	B.H.M. Screw B2 x 4
019K	1	62021030W0	Lug
020K	1	4724109120	Shield (Cavity)
021K	1	4724109130	Shield (Cavity)
022K	1	4724115010	Spring (Cavity)
023K	2	4724161020	Ferric Core (Cavity)
024K	2	51282605B0	B.H. Tapped Screw B2.6 x 5
025K	2	4724275010	Bobin
026K	2	102C115030	Spring
027K	1	211C109140	Shield
028K	1	211C120050	Insulator
031K	1	026C257010	Heatsink
034K	1	211C109090	Shield (TX)
035K	1	211C120060	Insulator (TX)
038K	1	211C109100	Shield (Local)
039K	1	211C120040	Insulator (Local)

REF. DESIG.	Q'TY	PART NO.	DESCRIPTION
042K	1	51102604A0	B.H.M. Screw B2.6 x 4
044K	1	51102604A0	B.H.M. Screw B2.6 x 4
049K	1	211C122010	Stecker
PH01	1	WZ211C0110	P.W. Board, Mic Amp.
PH20	1	WZ211C0310	P.W. Board, SQL Amp.
PH40	1	WZ211C0210	P.W. Board, Meter Amp.
PH60	1	WZ211C0410	P.W. Board, Audio Pri Amp.
FR21	1	RA03340030	Trimming 330K Ω

REF. DESIG.	Q'TY	PART NO.	DESCRIPTION
P101	1	WY211C0010 ZZ211C0010	P.W. Board, Main P.W. Board, Main Ass'y
C101	1	DD45300300	P101-CAPACITORS Ceramic 30pF $\pm 5\%$
C102	1	DD45510300	Ceramic 51pF $\pm 5\%$
C103	1	DD45270300	Ceramic 27pF $\pm 5\%$
C104	1	DK46103300	Ceramic 0.01 μ F $\pm 10\%$
C105	1	EA22601630	Elect 22 μ F 16V
C106	1	EV22601060	Elect 22 μ F 10V
C107	1	EV10403560	Elect 0.1 μ F 35V
C108	1	DK46102300	Ceramic 0.001 μ F $\pm 10\%$
C109	1	EA10601630	Elect 10 μ F 16V
C110	1	DK46102300	Ceramic 0.001 μ F $\pm 10\%$
C111	1	DD40020300	Ceramic 2pF $\pm 0.25pF$
C112	1	DD40015300	Ceramic 1.5pF $\pm 0.25pF$
C113	1	DK48473300	Ceramic 0.047 μ F $\pm 10\%$
C114	1	DK46102300	Ceramic 0.001 μ F $\pm 10\%$
C115	1	DD45101300	Ceramic 100pF $\pm 5\%$
C116	1	DD45101300	Ceramic 100pF $\pm 5\%$
C117	1	DK46102300	Ceramic 0.001 μ F $\pm 10\%$
C118	1	DD40050300	Ceramic 5pF $\pm 0.25pF$
C119	1	DK46471300	Ceramic 470pF $\pm 10\%$
C120	1	DK46102300	Ceramic 0.001 μ F $\pm 10\%$
C121	1	DD45101300	Ceramic 100pF $\pm 5\%$
C122	1	DK46102300	Ceramic 0.001 μ F $\pm 10\%$
C123	1	DD40050300	Ceramic 5pF $\pm 0.25pF$
C124	1	DD45131300	Ceramic 130pF $\pm 5\%$
C125	1	DD45560300	Ceramic 56pF $\pm 5\%$
C126	1	DD45101300	Ceramic 100 μ F $\pm 5\%$
C127	1	DK46103300	Ceramic 0.01 μ F $\pm 10\%$
C128	1	DK46103300	Ceramic 0.01 μ F $\pm 10\%$
C129	1	DK46103300	Ceramic 0.01 μ F $\pm 10\%$
C130	1	DK46103300	Ceramic 0.01 μ F $\pm 10\%$

REF. DESIG.	Q'TY	PART NO.	DESCRIPTION
C131	1	EA10601630	Elect 10 μ F 16V
C132	1	DK46103300	Ceramic 0.01 μ F $\pm 10\%$
C133	1	DK46103300	Ceramic 0.01 μ F $\pm 10\%$
C134	1	EV10601660	Elect 10 μ F 16V
C135	1	DK46103300	Ceramic 0.01 μ F $\pm 10\%$
C136	1	DD40050300	Ceramic 5pF $\pm 0.25pF$
C137	1	CT10400010	Trimming 4pF
C138	1	DK46103300	Ceramic 0.01 μ F $\pm 10\%$
C139	1	DD40040300	Ceramic 4pF $\pm 0.25pF$
C140	1	CT10400010	Trimming 4pF
C141	1	DK46103300	Ceramic 0.01 μ F $\pm 10\%$
C142	1	DD15101050	Ceramic 100pF $\pm 5\%$
C143	1	DD15620010	Ceramic 62pF $\pm 5\%$
C144	1	DK46103300	Ceramic 0.01 μ F $\pm 10\%$
C145	1	DD41070300	Ceramic 7pF $\pm 0.5pF$
C146	1	DK46103300	Ceramic 0.01 μ F $\pm 10\%$
C147	1	DD40010300	Ceramic 1pF $\pm 0.25pF$
C148	1	DD41070300	Ceramic 7pF $\pm 0.5pF$
C149	1	DD40040300	Ceramic 4pF $\pm 0.25pF$
C150	1	DD45101300	Ceramic 100pF $\pm 5\%$
C151	1	DK46102300	Ceramic 0.001 μ F $\pm 10\%$
C152	1	DD45101300	Ceramic 100pF $\pm 5\%$
C153	1	DK46102300	Ceramic 0.001 μ F $\pm 10\%$
C154	1	DK46102300	Ceramic 0.001 μ F $\pm 10\%$
C155	1	DD40010300	Ceramic 1pF $\pm 0.25pF$
C156	1	DD45221300	Ceramic 220pF $\pm 5\%$
C157	1	DK46102300	Ceramic 0.01 μ F $\pm 10\%$
C159	1	DK46102300	Ceramic 0.001 μ F $\pm 10\%$

REF. DESIG.	Q'TY	PART NO.	DESCRIPTION
CL01	1	DK46103300	Ceramic 0.01 μ F \pm 10%
CL02	1	DK46103300	Ceramic 0.01 μ F \pm 10%
CL03	1	DK46103300	Ceramic 0.01 μ F \pm 10%
CL04	1	DK46103300	Ceramic 0.01 μ F \pm 10%
CL05	1	DD45101300	Ceramic 100p F \pm 5%
CL06	1	DD45221300	Ceramic 220p F \pm 5%
CL07	1	EA10601630	Elect 10 μ F 16V
CL08	1	EV22601660	Elect 22 μ F 16V
CL09	1	DK46103300	Ceramic 0.001 μ F \pm 10%
CL11	1	DK46103300	Ceramic 0.01 μ F \pm 10%
CL13	1	EA47700630	Elect 470 μ F 6.3V
CL15	1	DK48473300	Ceramic 0.047 μ F
CL16	1	DK48473300	Ceramic 0.047 μ F
CL18	1	DK48473300	Ceramic 0.047 μ F
CL19	1	DK48473300	Ceramic 0.047 μ F
CR01	1	DD45101300	Ceramic 100p F \pm 5%
CR02	1	DK46102300	Ceramic 0.001 μ F \pm 10%
CR03	1	DK46102300	Ceramic 0.001 μ F \pm 10%
CR04	1	DD45101300	Ceramic 100p F \pm 5%
CR05	1	DK46102300	Ceramic 0.001 μ F \pm 10%
CR06	1	DK46102300	Ceramic 0.001 μ F \pm 10%
CR07	1	DD45101300	Ceramic 100p F \pm 5%
CR08	1	DD40050300	Ceramic 5p F \pm 0.25pF
CR09	1	DD45101300	Ceramic 100p F \pm 5%
CR10	1	DK46102300	Ceramic 0.001 μ F \pm 10%
CR11	1	CT11000170	Trimming 10pF
CR12	1	DK46102300	Ceramic 0.001 μ F \pm 10%
CR13	1	DK46102300	Ceramic 0.001 μ F \pm 10%
CR14	1	DK46102300	Ceramic 0.001 μ F \pm 10%
CR16	1	DK46102300	Ceramic 0.001 μ F \pm 10%
CR17	1	DK46103300	Ceramic 0.01 μ F \pm 10%
CR18	1	DK46103300	Ceramic 0.01 μ F \pm 10%

REF. DESIG.	Q'TY	PART NO.	DESCRIPTION
CR19	1	EV10502560	Elect 1 μ F 25V
CR20	1	DK46102300	Ceramic 0.001 μ F \pm 10%
CR21	1	EV10502560	Elect 1 μ F 25V
CR22	1	EV10502560	Elect 1 μ F 25V
CR23	1	DD45430300	Ceramic 43p F \pm 5%
CR24	1	DK46103300	Ceramic 0.01 μ F \pm 10%
CR25	1	DD45620330	Ceramic 62p F \pm 5%
CR26	1	DS17223010	Semicon 0.022 μ F \pm 20%
CR27	1	DD45120300	Ceramic 12p F \pm 5%
CR28	1	EV10502560	Elect 1 μ F 25V
CR29	1	DK46103300	Ceramic 0.01 μ F \pm 10%
CR30	1	EA10701030	Elect 100 μ F 10V
CR31	1	DD45430300	Ceramic 43p F \pm 5%
CR32	1	DS17332010	Semicon 3300p F \pm 20%
CR33	1	EA10701030	Elect 100 μ F 10V
CR34	1	EV10502560	Elect 1 μ F 25V
CR35	1	EA47601030	Elect 47 μ F 10V
CR36	1	DK46102300	Ceramic 0.001 μ F \pm 10%
CR37	1	DD45101300	Ceramic 100p F \pm 5%
CR38	1	EA10505030	Elect 1 μ F 50V
CR39	1	DS17104010	Semicon 0.1 μ F \pm 20%
CR40	1	EA47601030	Elect 47 μ F 10V
CR41	1	EA22701030	Elect 220 μ F 10V

REF. DESIG.	Q'TY	PART NO.	DESCRIPTION
CR42	1	DK46103300	Ceramic 0.01 μ F \pm 10%
CR43	1	EA22700630	Elect 220 μ F 6V
CR44	1	DK46103300	Ceramic 0.01 μ F \pm 10%
CR45	1	EA10702530	Elect 100 μ F 25V
CR46	1	DK46103300	Ceramic 0.01 μ F \pm 10%
CR47	1	DK48473300	Ceramic 0.047 μ F
CR48	1	DK46103300	Ceramic 0.01 μ F \pm 10%
CR49	1	EG10802520	Elect 1000 μ F 25V
CR50	1	DK46103300	Ceramic 0.01 μ F \pm 10%
CR51	1	EA22601630	Elect 22 μ F 16V
CR52	1	DK46103300	Ceramic 0.01 μ F \pm 10%
CR54	1	DK48473300	Ceramic 0.047 μ F
CR55	1	EA47601030	Elect 47 μ F 10V
CR56	1	EA10505030	Elect 1 μ F 50V
CR57	1	DK46103300	Ceramic 0.01 μ F \pm 10%
CR59	1	DS17153010	Ceramic 0.015 μ F \pm 20%
CR60	1	DS17104010	Semicon. 0.1 μ F \pm 20%
CR61	1	DK46102300	Ceramic 0.001 μ F \pm 10%
CR62	1	DK46102300	Ceramic 0.001 μ F \pm 10%
CT01	1	DK46471300	Ceramic 470p F \pm 10%
CT02	1	DK46103300	Ceramic 0.01 μ F \pm 10%
CT03	1	DK46102300	Ceramic 0.001 μ F \pm 10%
CT04	1	DK46102300	Ceramic 0.001 μ F \pm 10%
CT05	1	DD45101300	Ceramic 100p F \pm 5%
CT06	1	DK46102300	Ceramic 0.001 μ F \pm 10%
CT07	1	EA10601630	Elect 10 μ F 16V
CT08	1	DK46102300	Ceramic 0.001 μ F \pm 10%
CT09	1	DD41100300	Ceramic 10p F \pm 0.5pF
CT10	1	CT11000020	Trimming 10p F
CT11	1	DK46102300	Ceramic 0.001 μ F \pm 10%
CT12	1	DK46102300	Ceramic 0.001 μ F \pm 10%
CT13	1	EV10601660	Elect 10 μ F 16V

REF. DESIG.	Q'TY	PART NO.	DESCRIPTION
CT14	1	CT11000020	Trimming 10p F
CT15	1	EA22602530	Elect 22 μ F 25V
CT16	1	EV10602560	Elect 10 μ F 25V
CT17	1	DK46102300	Ceramic 0.001 μ F \pm 10%
CT18	1	EV10602560	Elect 10 μ F 25V
CT19	1	DK46102300	Ceramic 0.001 μ F \pm 10%
CT20	1	DD40040300	Ceramic 4p F \pm 0.25pF
CT21	1	DD40040300	Ceramic 4p F \pm 0.25pF
CT22	1	DD41080300	Ceramic 8p F \pm 0.5pF
CT23	1	DD41080300	Ceramic 8p F \pm 0.5pF
CT24	1	DD40040300	Ceramic 4p F \pm 0.25pF
CT25	1	DD40040300	Ceramic 4p F \pm 0.25pF
CT26	1	DD45331300	Ceramic 330p F \pm 5%
CT27	1	DK46102300	Ceramic 0.001 μ F \pm 10%
CT28	1	DD41080300	Ceramic 8p F \pm 0.5pF
CT29	1	DD45331300	Ceramic 330p F \pm 5%
CT30	1	DD40040300	Ceramic 4p F \pm 0.25pF
CT31	1	DD40040300	Ceramic 4p F \pm 0.25pF
CT32	1	DD40040300	Ceramic 4p F \pm 0.25pF
CT33	1	DD40040300	Ceramic 4p F \pm 0.25pF
CT34	1	DD45270300	Ceramic 27p F \pm 0.5%
CT35	1	DD41060300	Ceramic 6p F \pm 0.5pF
CT36	1	DK18102300	Ceramic 0.001 μ F \pm 10%
CT37	1	DK18102300	Ceramic 1000pF \pm 10%
CT38	1	DK46102300	Ceramic 0.001 μ F \pm 10%
CT39	1	DK46102300	Ceramic 0.001 μ F \pm 10%
CT40	1	DK46102300	Ceramic 0.001 μ F \pm 10%

REF. DESIG.	Q'TY	PART NO.	DESCRIPTION
CT41	1	EV47501060	Elect 4.7 μ F 10V
CT42	1	DK46102300	Ceramic 0.001 μ F \pm 10%
CT43	1	DK46102300	Ceramic 0.001 μ F \pm 10%
CT44	1	DC18102030	Feedthru 2000pF
CT45	1	EA47502530	Elect 4.7 μ F 25V
CT46	1	EA47502530	Elect 4.7 μ F 25V
CT47	1	EA22601630	Elect 22 μ F 16V
CT48	1	EV10502560	Elect 1 μ F 25V
CT49	1	DD45470300	Ceramic 47pF \pm 5%
CT50	1	DK46102300	Ceramic 0.001 μ F \pm 10%
CT51	1	DC18102030	Feedthru 1000pF
CT52	1	DK46102300	Ceramic 0.001 μ F \pm 10%
CT53	1	DK46102300	Ceramic 0.001 μ F \pm 10%
CT54	1	DK46102300	Ceramic 0.001 μ F \pm 10%
CT55	1	DK46102300	Ceramic 0.001 μ F \pm 10%
CT56	1	EA47502560	Elect 4.7 μ F 25V
CT57	1	DC18202050	Feedthru 1000pF
CT58	1	DK18102030	Ceramic 0.001 μ F \pm 10%
CT59	1	DK46102300	Ceramic 0.001 μ F \pm 10%
CT61	1	DD15200300	Ceramic 20pF \pm 5%
R101	1	R105332180	P101-RESISTORS (All Resistors are \pm 5%) 3.3K Ω , Chip 1/8W
R102	1	GD05103140	10K Ω 1/8W
R103	1	R105681180	680 Ω , Chip 1/8W
R104	1	R105222180	2.2K Ω , Chip 1/8W
R106	1	R105102180	1K Ω , Chip 1/8W
R107	1	R105103180	10K Ω , Chip 1/8W
R108	1	R105102180	1K Ω , Chip 1/8W
R109	1	R105222180	2.2K Ω , Chip 1/8W
R110	1	R105821180	820 Ω , Chip 1/8W
R111	1	R105101180	100 Ω , Chip 1/8W

REF. DESIG.	Q'TY	PART NO.	DESCRIPTION
R112	1	R105470180	47 Ω , Chip 1/8W
R113	1	R105561180	560 Ω , Chip 1/8W
R114	1	R105560180	56 Ω , Chip 1/8W
R115	1	GD05393140	39K Ω , Chip 1/8W
R116	1	R105563180	56K Ω , Chip 1/8W
R117	1	GD05683140	68K Ω , Chip 1/8W
R118	1	R105103180	10K Ω , Chip 1/8W
R119	1	R105121180	120 Ω , Chip 1/8W
R120	1	R105100180	10 Ω , Chip 1/8W
R121	1	GD05221140	220 Ω 1/8W
R122	1	GD05821140	820 Ω 1/8W
R123	1	GD05056140	5.6 Ω 1/8W
R124	1	GD05821140	820 Ω 1/8W
R125	1	R105101180	100 Ω , Chip 1/8W
R126	1	GD05184140	180K Ω 1/8W
R127	1	GD05102140	1K Ω 1/8W
R128	1	R105103180	10K Ω , Chip 1/8W
R129	1	GD05391140	390 Ω 1/8W
R130	1	GD05332140	3.3K Ω 1/8W
R132	1	GD05222140	2.2K Ω 1/8W
R133	1	GD05222140	2.2K Ω 1/8W
R134	1	R105561180	560 Ω , Chip 1/8W
R135	1	GD05152140	1.5K Ω , Chip 1/8W
R136	1	GD05392140	3.9K Ω 1/8W
R137	1	GD05471140	470 Ω 1/8W
R138	1	GD05101140	100 Ω 1/8W
R139	1	GD05223140	22K Ω 1/8W
R140	1	GD05272140	2.7K Ω 1/8W

REF. DESIG.	Q'TY	PART NO.	DESCRIPTION
R141	1	GD05470140	47 Ω 1/8W
R142	1	GD05101140	100 Ω 1/8W
R143	1	R105121180	120 Ω , Chip 1/8W
R144	1	R105100180	10 Ω , Chip 1/8W
R146	1	R105000180	0 Ω , Chip 1/8W
R147	1	RC00000140	0 Ω 1/8W
R148	1	RC00000140	0 Ω 1/8W
R149	1	R105000180	0 Ω , Chip 1/8W
RL01	1	RA05020350	5.0K Ω , Trimming VOL.
RL02	1	R105473180	47K Ω , Chip 1/8W
RL03	1	R105102180	1K Ω , Chip 1/8W
RL04	1	R105182180	1.8K Ω , Chip 1/8W
RL05	1	R105182180	1.8K Ω , Chip 1/8W
RL06	1	R105683180	68K Ω , Chip 1/8W
RL07	1	R105103180	10K Ω , Chip 1/8W
RL08	1	R105103180	10K Ω , Chip 1/8W
RL09	1	R105103180	10K Ω , Chip 1/8W
RL10	1	R105105180	1M Ω , Chip 1/8W
RL12	1	R105103180	10K Ω , Chip 1/8W
RL13	1	R105103180	10K Ω , Chip 1/8W
RL14	1	GD05224180	220K Ω 1/8W
RL15	1	R105103180	10K Ω , Chip 1/8W
RL16	1	R105103180	10K Ω , Chip 1/8W
RL17	1	R105103180	10K Ω , Chip 1/8W
RL18	1	R105103180	10K Ω , Chip 1/8W
RL19	1	R105103180	10K Ω , Chip 1/8W
RL20	1	R105103180	10K Ω , Chip 1/8W
RL21	1	R105103180	10K Ω , Chip 1/8W
RL22	1	R105103180	10K Ω , Chip 1/8W
RL23	1	R105103180	10K Ω , Chip 1/8W
RL24	1	R105103180	10K Ω , Chip 1/8W
RL25	1	R105103180	10K Ω , Chip 1/8W

REF. DESIG.	Q'TY	PART NO.	DESCRIPTION
RL26	1	R105103180	10K Ω , Chip 1/8W
RL27	1	R105103180	10K Ω , Chip 1/8W
RL28	1	R105103180	10K Ω , Chip 1/8W
RL29	1	R105103180	10K Ω , Chip 1/8W
RL30	1	R105103180	10K Ω , Chip 1/8W
RL31	1	R105103180	10K Ω , Chip 1/8W
RL32	1	R105103180	10K Ω , Chip 1/8W
RL33	1	R105103180	10K Ω , Chip 1/8W
RL34	1	R105332180	3.3K Ω , Chip 1/8W
RL35	1	RA05020350	5.0K Ω , Trimming
RL36	1	R105222180	2.2K Ω , Chip 1/8W
RL37	1	R105330180	33 Ω , Chip 1/8W
RL38	1	R105330180	33 Ω , Chip 1/8W
RL39	1	GD05330140	33 Ω 1/8W
RL40	1	R105330180	33 Ω , Chip 1/8W
RL41	1	R105330180	33 Ω , Chip 1/8W
RL42	1	R105330180	33 Ω , Chip 1/8W
RL43	1	R105330180	33 Ω , Chip 1/8W
RL44	1	R105330180	33 Ω , Chip 1/8W
RL45	1	R105103180	10K Ω , Chip 1/8W
RL46	1	R105103180	10K Ω , Chip 1/8W
RL48	1	R105273180	27K Ω , Chip 1/8W
RL49	1	RC00000140	0 Ω 1/8W

REF. DESIG.	Q'TY	PART NO.	DESCRIPTION
RR01	1	GD05124140	120K Ω , 1/8W
RR02	1	GD05473140	47K Ω , 1/8W
RR03	1	GD05104140	100K Ω , 1/8W
RR04	1	GD05101140	100 Ω , 1/8W
RR05	1	GD05470140	47 Ω , 1/8W
RR06	1	GD05470140	47 Ω , 1/8W
RR07	1	GD05682140	6.8K Ω , 1/8W
RR08	1	GD05473140	47K Ω , 1/8W
RR09	1	GD05104140	100K Ω , 1/8W
RR10	1	GD05221140	220 Ω , 1/8W
RR11	1	GD05470140	47 Ω , 1/8W
RR12	1	GD05470140	47 Ω , 1/8W
RR13	1	GD05473140	47K Ω , 1/8W
RR14	1	GD05221140	220 Ω , 1/8W
RR15	1	GD05470140	47 Ω , 1/8W
RR16	1	GD05222140	2.2K Ω , 1/8W
RR17	1	GD05222140	2.2K Ω , 1/8W
RR18	1	GD05222140	2.2K Ω , 1/8W
RR19	1	GD05473140	47K Ω , 1/8W
RR20	1	GD05123140	12K Ω , 1/8W
RR21	1	RA03340030	330K Ω , Trimming
RR22	1	RA05030310	50K Ω , Trimming
RR23	1	RI05103180	10K Ω , Chip
RR24	1	RI05102180	1K Ω , Chip
RR25	1	RI05103180	10K Ω , Chip
RR26	1	RD12030110	20K Ω (A), Variable
RR27	1	RI05682180	6.8K Ω , Chip
RR28	1	RI05332180	3.3K Ω , Chip
RR29	1	RI05272180	2.7K Ω , Chip
RR30	1	GD05823140	82K Ω , 1/8W
RR31	1	GD05102140	1K Ω , 1/8W
RR32	1	RI05222180	2.2K Ω , Chip
RR33	1	RI05332180	3.3K Ω , Chip

REF. DESIG.	Q'TY	PART NO.	DESCRIPTION
RR34	1	RI05332180	3.3K Ω , 1/8W
RR35	1	RI05104180	100K Ω , 1/8W
RR36	1	RI05102180	1K Ω , Chip
RT01	1	RI05222180	2.2K Ω , Chip
RT02	1	GD05182140	1.8K Ω , 1/8W
RT03	1	GD05660140	56 Ω , 1/8W
RT04	1	RI05821180	820 Ω , Chip
RT05	1	RI05470180	47 Ω , Chip
RT06	1	RI05220180	22 Ω , Chip
RT07	1	RI05470180	47 Ω , Chip
RT08	1	RI05821180	820 Ω , Chip
RT09	1	RI05100180	10 Ω , Chip
RT10	1	RI05662180	5.6K Ω , Chip
RT11	1	HP00004230	Varistor, P.T.H.
RT12	1	RI05152180	1.5K Ω , Chip
RT13	1	RI05101180	100 Ω , 1/8W
RT14	1	GD05273140	27K Ω , 1/8W
RT15	1	GD05681140	680 Ω , 1/8W
RT16	1	RA05020350	5.0K Ω (B), Trimming
RT17	1	RI05222180	2.2K Ω , Chip
RT18	1	GD05222140	2.2K Ω , 1/8W
RT19	1	GU05221120	220 Ω , 1/8W
RT20	1	RC00000140	0 Ω , 1/8W
RT21	1	RI05154180	150K Ω , Chip
RT22	1	RA05020350	5.0K Ω , Trimming
RT23	1	GD05101140	100 Ω , 1/8W
RT24	1	RA01030560	10K Ω (B), Trimming
RT25	1	RI05822180	8.2K Ω , Chip
RT26	1	RC00000140	0 Ω , 1/8W

REF. DESIG.	Q'TY	PART NO.	DESCRIPTION
Q101	1	HC10047050	P101-SEMICONDUCTORS
Q102	1	HC10063050	IC TC9122P
Q103	1	HC10023050	IC TC5081AP
Q104	1	HX111621A0	IC TC5082PL
Q105	1	HX327121A0	Transistor 2SA1162 (GR)
Q106	1	HT32026100	Transistor 2SC2712 (GR)
Q107	1	HD20001200	Diode MI301
Q108	1	HD20001200	Diode MI301
Q109	1	HF401001A0	F.E.T. 3SK100(O)
Q110	1	HD20015060	Diode ND487C1-3R
Q111	1	HT304601B0	Transistor 2SC460(B)
Q112	1	HF202411C0	F.E.T. 2SK241 (GR)
Q113	1	HC707300A0	IC 74LS73
Q114	1	HD20010060	Diode 1S553
Q115	1	HD20010060	Diode 1S553
Q116	1	HT305351B0	Transistor 2SC535(B)
Q117	1	HT32026100	Transistor 2SC2026
QL01	1	HX327121A0	Transistor 2SC2712(GR)
QL02	1	HC401601B0	IC HD14016B
QL03	1	HC10071030	IC LM6402A 043
QL04	1	HD20011050	Diode 1S1555
QL05	1	HD20011050	Diode 1S1555
QL06	1	HD20011050	Diode 1S1555
QL08	1	HD20011050	Diode 1S1555
QL09	1	HD20011050	Diode 1S1555
QL10	1	HD20011050	Diode 1S1555
QL11	1	HT305360F0	Transistor 2SC536F
QL12	1	HD20002020	Diode MA522
QL13	1	HD10004020	Diode OA91
QL14	1	HT30982100	Transistor 2SC982
QL15	1	HT30982100	Transistor 2SC982

REF. DESIG.	Q'TY	PART NO.	DESCRIPTION
QL16	1	HT30982100	Transistor 2SC982
QL17	1	HT30982100	Transistor 2SC982
QL18	1	HD10004020	Diode OA91
QL19	1	HD10004020	Diode OA91
QL20	1	HD10004020	Diode OA91
QL21	1	HD10004020	Diode OA91
QL22	1	HD10004020	Diode OA91
QL23	1	HD20011050	Diode 1S1555
QR01	1	HD20011050	Diode 1S1555
QR02	1	HD20011050	Diode 1S1555
QR03	1	HF400971A0	F.E.T. 3SK97(O)
QR04	1	HF400971A0	F.E.T. 3SK97(O)
QR05	1	HF202411C0	F.E.T. 2SK241 (GR)
QR06	1	HD10004020	Diode OA91
QR07	1	HD10004020	Diode OA91
QR08	1	HC10015170	IC MC3357P
QR09	1	HC10031010	IC HA1366W
QR10	1	HD20011050	Diode 1S1555
QR11	1	HD20011050	Diode 1S1555
QR12	1	HC10003180	IC MB3756
QR13	1	HC10031060	IC 78L05
QR14	1	HC10034020	IC AN7805
QR15	1	HD20001100	Diode 10D2
QR16	1	HD20011050	Diode 1S1555
QR17	1	HD20011050	Diode 1S1555
QR18	1	HD20011290	Diode S3V
QR19	1	HD20011050	Diode 1S1555
QR20	1	HD20011050	Diode 1S1555

REF. DESIG.	Q'TY	PART NO.	DESCRIPTION
QT01	1	HT32026100	Transistor 2SC2026
QT02	1	HT32407100	Transistor 2SC2407
QT03	1	HD20011050	Diode 1S1555
QT04	1	HC10017200	IC M57704M
QT05	1	HT305360F0	Transistor 2SC536F
QT06	1	HT305360F0	Transistor 2SC536F
QT07	1	HT305360F0	Transistor 2SC536F
QT08	1	HT403132A0	Transistor 2SD313
QT09	1	HD20005060	Diode 1SS16
QT10	1	HD20011050	Diode 1S1555
QT11	1	HD20006200	Diode MI308
QT12	1	HD20001200	Diode MI301
QT13	1	HD20001200	Diode MI301
QT14	1	HD10004020	Diode OA91
QT15	1	HC10014090	IC NJM4558S
FR01	1	XU221400M5	P101-MISCELLANEOUS
FR02	1	FG455306E0	Crystal 21.4MHz
JL01	1	YJ07000440	Ceramic Filter CFW455E
JL02	1	YJ07000460	Jack (4P)
JL03	1	YJ07000520	Jack (6P)
JL04	1	YJ07000430	Jack (12P)
JL05	1	YJ07000430	Jack (3P)
JL06	1	YJ07000430	Jack (3P)
JL07	1	YJ07000420	Jack (2P)
	1	YJ07000440	Jack (4P)
L101	1	LC11050040	Choke Coil 1mH
L102	1	LC11050040	Choke Coil 1mH
L103	1	LL635004A3	Coil (4T)
L104	1	LC15010240	Choke Coil (4T)
L105	1	LB05005110	Balun Coil
L106	1	LB05005110	Balun Coil

REF. DESIG.	Q'TY	PART NO.	DESCRIPTION
L107	1	LC18210010	Choke Coil 0.82μH
L108	1	LC11050040	Choke Coil 1mH
L109	1	LC11220020	Choke Coil 1.2μH
L110	1	LC13940010	Choke Coil 390μH
L111	1	LC11020020	Choke Coil 1μH
L112	1	LA55016080	Ant. Coil L/O Coil
L113	1	LA55016080	Ant. Coil L/O Coil
L114	1	LA70260300	Ant. Coil
L115	1	LC11040010	Choke Coil 100μH
L116	1	LC11020070	Choke Coil 1μH
LR01	1	LC11810030	Choke Coil
LR02	1	LC11810060	Cavity Coil
LR03	1	LA70260310	Ant. Coil (RF)
LR04	1	LC13510020	Choke Coil (Local 3T)
LR05	1	LI70280040	I.F.T. Coil (21.4MHz)
LR06	1	LI70280040	I.F.T. Coil (21.4MHz)
LR07	1	LI70280010	I.F.T. Coil (21.4MHz)
LR08	1	LI71016090	I.F.T. Coil (455KHz)
LR09	1	LI71016170	I.F.T. Coil (455KHz)
LR10	1	LC25850010	Choke Coil 5.8mH

REF. DESIG.	Q'TY	PART NO.	DESCRIPTION
LT01	1	LL635003A3	Coil (3T)
LT02	1	LC12000030	Choke Coil (1T)
LT03	1	LC15000110	Choke Coil (2T)
LT04	1	3512121020	Link
LT05	1	LC12010012	Choke Coil (8T)
LT06	1	LC12010012	Choke Coil (8T)
LT07	1	LC15000230	Choke Coil (2T)
LT08	1	LC15000110	Choke Coil (2T)
LT09	1	LC15000170	Choke Coil (8T)
LT10	1	LC15000110	Choke Coil (2T)
LT11	1	LC15000230	Choke Coil (2T)
LT12	1	LC15000110	Choke Coil (2T)
LT13	1	LC11020020	Choke Coil 1μH
LT14	1	LL635005A0	Coil (5T)
SL01	1	SS02020190	Switch, Slide
W101	1	YB01300280	Connective Cord
W102	1	YB01300290	Connective Cord
W103	1	YB01300300	Connective Cord
W104	1	YB01300250	Connective Cord
WL01	1	YB01300050	Connective Cord
WL02	1	YB01300060	Connective Cord
WL03	1	YB01300070	Connective Cord
WL04	1	YB01300080	Connective Cord
WL05	1	YB01300090	Connective Cord
WL08	1	YB01300120	Connective Cord
WL10	1	YB01300140	Connective Cord
WR01	1	YB01300180	Connective Cord
WR02	1	YB01300190	Connective Cord
WR03	1	YB01300200	Connective Cord
WR04	1	YB01300210	Connective Cord
WR05	1	YB01300220	Connective Cord

REF. DESIG.	Q'TY	PART NO.	DESCRIPTION
WR06	1	YB01300230	Connective Cord
WR07	1	YB01300240	Connective Cord
WR08	1	YB01300250	Connective Cord
WR09	1	YB01300260	Connective Cord
WR10	1	YB01300270	Connective Cord
WR11	1	YB01300310	Connective Cord
WR12	1	YB01300150	Connective Cord
WR13	1	YB01300320	Connective Cord
WT01	1	YB01300320	Connective Cord
WT02	1	YB01300160	Connective Cord
WT03	1	YB01300170	Connective Cord
WT04	1	YB01300330	Connective Cord
X101	1	XB112004L0	Crystal 3.2MHz
X102	1	XB303012G2	Crystal 44.1777MHz
X103	1	XB303011G2	Crystal 46.5555MHz
XL01	1	FQ04003010	Seramic Vib. CSB400P
XR01	1	XZ116001L2	Crystal 20.945MHz

REF. DESIG.	QTY	PART NO.	DESCRIPTION
001K	1	211C109010	Shield
003K	1	211C109020	Shield
004K	2	51102606A0	B.H.M. Screw B2.6 x 6
005K	1	2127118020	Spacer
006K	1	211C109030	Shield
007K	1	211C109110	Shield
008K	1	51100306A9	B.H.M. Screw B3 x 6
009K	1	53110303A0	Hexagon Nut M3
010K	1	211C109040	Shield
011K	1	211C109050	Shield
012K	1	211C109060	Shield
013K	1	211C120020	Insulator
016K	1	211C109070	Shield
017K	1	211C109080	Shield
018K	5	51100204E0	B.H.M. Screw B2 x 4
019K	1	62021030W0	Lug
020K	1	4724109120	Shield
021K	1	4724109130	Shield
022K	1	4724115010	Spring
023K	2	4724161020	Ferric Core
024K	2	51282605B0	B.H. Tapped Screw B2.6 x 6
025K	2	4724275010	Bobbin
031K	1	026C267010	Heatsink
034K	1	211C109090	Shield
035K	1	211C120030	Insulator
036K	1	51502605B0	F.H. Tapitite Screw F2.6 x 5
038K	1	211C109100	Shield
039K	1	211C120040	Insulator
042K	1	51102604A0	B.H.M. Screw B2.6 x 4
044K	1	51102604A0	B.H.M. Screw B2.6 x 4

REF. DESIG.	QTY	PART NO.	DESCRIPTION
P801	1	WH211C1210 ZZ211C1210	P.W. Board, Rotary Switch P.W. Board, Rotary Switch Ass'y
J801	1	YJ10001850	Jack (7P)
J802	1	YJ01000570	Jack EXT. SPKR
J807	1	YB01100040	Connective Cord (3P)
S802	1	SR18020010	Rotary Switch (18 Position)
P802	1	WH211C1220 ZZ211C1220	P.W. Board, Slide Switch P.W. Board, Slide Switch Ass'y
C801	1	EJ47502510	P801-CAPACITORS Elect 4.7 μ F 25V
C802	1	EJ10505010	Elect 1 μ F 50V
R801	1	GD05103180	P801-RESISTORS (All Resistors are \pm 5% and 1/8W) 10K Ω
R802	1	GD05103180	10K Ω
R803	1	GD05103180	10K Ω
R804	1	GD05153180	15K Ω
R805	1	GD05473180	47K Ω
Q801	1	HC10067050	P801-SEMICONDUCTOR IC TA7654P
J805	1	YB00900050	P801-MISCELLANEOUS Connective Cord (4P)
J806	1	YB00600270	Connective Cord (3P)
S801	1	SS02030180	Slide Switch Buak up

REF. DESIG.	QTY	PART NO.	DESCRIPTION
PH01	1	WZ211C0110 ZZ211C0110	P.W. Board, Mic Amp. P.W. Board, Mic Amp. Ass'y
CH01	1	DK46103300	PH01-CAPACITORS Ceramic 0.01 μ F \pm 10%
CH02	1	DD45151300	Ceramic 150pF \pm 5%
CH03	1	DK46471300	Ceramic 470pF \pm 10%
CH04	1	DD45151300	Ceramic 150pF \pm 5%
CH05	1	DK46471300	Ceramic 470pF \pm 10%
CH06	1	DK46472300	Ceramic 0.0047 μ F \pm 10%
CH07	1	DD45201300	Ceramic 200pF \pm 5%
CH08	1	DK46473200	Ceramic 0.047 μ F \pm 10%
RH01	1	R105102180	PH01-RESISTORS (All Resistors are \pm 5% and 1/8W) 1K Ω , Chip
RH02	1	R105184180	180K Ω , Chip
RH03	1	R105472180	4.7K Ω , Chip
RH04	1	R105103180	10K Ω , Chip
RH05	1	R105104180	100K Ω , Chip
RH06	1	R105564180	560K Ω , Chip
RH07	1	R105822180	8.2K Ω , Chip
RH08	1	R105101180	100 Ω , Chip
RH09	1	R105823180	82K Ω , Chip
RH10	1	R105473180	47K Ω , Chip
QH01	1	HX327121A0	PH01-SEMICONDUCTOR Transistor 2SC2712 (GR)
JH01	1	YP06000720	PH01-MISCELLANEOUS Plug (11P)

REF. DESIG.	QTY	PART NO.	DESCRIPTION
PH20	1	WZ211C0310 ZZ211C0310	P.W. Board, SQL Amp. P.W. Board, SQL Amp. Ass'y
CH20	1	DK46473200	PH20-CAPACITORS Ceramic 0.047 μ F \pm 10%
CH21	1	DK46332300	Ceramic 3300pF \pm 10%
CH22	1	DK46471300	Ceramic 470pF \pm 10%
RH20	1	R105103180	PH20-RESISTORS (All Resistors are \pm 5% and 1/8W) 4.7K Ω , Chip
RH21	1	R105473180	47K Ω , Chip
RH22	1	R105272180	2.7K Ω , Chip
RH23	1	R105103180	10K Ω , Chip
RH24	1	R105103180	10K Ω , Chip
RH25	1	R105392180	3.9K Ω , Chip
RH26	1	R105332180	3.3K Ω , Chip
RH27	1	R105224180	220K Ω , Chip
RH28	1	R105000180	0 Ω , Chip
RH29	1	R105000180	0 Ω , Chip
RH30	1	R105000180	0 Ω , Chip
QH20	1	HX327121A0	PH20-SEMICONDUCTORS Transistor 2SC2712 (GR)
QH21	1	HX111621A0	Transistor 2SA1162 (GR)
JH20	1	YP06000720	PH20-MISCELLANEOUS Plug (11P)
PH40	1	WZ211C0210 ZZ211C0210	P.W. Board, Meter Amp. P.W. Board, Meter Amp. Ass'y
CH40	1	DD45101300	PH40-CAPACITORS Ceramic 100pF \pm 5%
CH41	1	DK48223300	Ceramic 0.022 μ F \pm 10%
CH42	1	DK46103300	Ceramic 0.01 μ F \pm 10%
CH43	1	DK48223300	Ceramic 0.022 μ F

REF. DESIG.	Q'TY	PART NO.	DESCRIPTION
CH44	1	DK46102300	Ceramic 0.001 μ F \pm 10%
CH45	1	DK46102300	Ceramic 0.001 μ F \pm 10%
RH40	1	R105563180	PH40-RESISTORS (All Resistors are \pm 5% and 1/8W)
RH42	1	R105221180	56K Ω , Chip
RH43	1	R105821180	220 Ω , Chip
RH44	1	R105101180	820 Ω , Chip
RH45	1	R105473180	100 Ω , Chip
RH46	1	R105221180	47K Ω Chip
RH47	1	R105473180	220 Ω , Chip
RH48	1	R105000180	47K Ω , Chip
RH49	1	R105153180	0 Ω , Chip 15K Ω , Chip
QH40	1	HY202101A0	PH40-SEMICONDUCTORS
QH41	1	HX327141B0	Transistor 2SK210 (GR) Transistor 2SC2714 (O)
JH40	1	YP06000720	PH40-MISCELLANEOUS Plug (11P)

REF. DESIG.	Q'TY	PART NO.	DESCRIPTION
PH60	1	WZ211C0410 ZZ211C0410	P.W. Board, Audio Pri Amp. P.W. Board, Audio Pri Amp. Ass'y
CH60	1	DK46152300	PH60-CAPACITORS
CH61	1	DK46473200	Ceramic 1500pF \pm 10%
CH62	1	DK46473200	Ceramic 0.047 μ F \pm 10%
CH63	1	DK46103300	Ceramic 0.047 μ F \pm 10%
CH64	1	DK46102300	Ceramic 0.01 μ F \pm 10%
CH65	1	DK46473200	Ceramic 0.001 μ F \pm 10%
RH60	1	R105563180	PH60-RESISTORS (All Resistors \pm 5% and 1/8W)
RH61	1	R105103180	56K Ω , Chip
RH62	1	R105473180	10K Ω , Chip
RH63	1	R105153180	47K Ω , Chip
RH64	1	R105472180	15K Ω , Chip
RH65	1	R105563180	4.7K Ω , Chip
RH66	1	R105103180	56K Ω , Chip
RH67	1	R105331180	10K Ω , Chip
RH68	1	R105272180	330 Ω , Chip
RH69	1	R105102180	2.7K Ω , Chip
RH70	1	R105562180	1K Ω , Chip
RH71	1	R105102180	5.6K Ω , Chip
RH72	1	R105000180	1K Ω , Chip 0 Ω , Chip
QH60	1	HX327121A0	PH60-SEMICONDUCTORS
QH61	1	HX327121A0	Transistor 2SC2712 (GR) Transistor 2SC2712 (GR)
JH60	1	YP06000720	PH60-MISCELLANEOUS Plug (11P)

REF. DESIG.	Q'TY	PART NO.	DESCRIPTION
PM01	1	YF211C0020 ZZ211C0020	P.W. Board, Display P.W. Board, Display Ass'y
RM01	1	GD05471180	PM01-RESISTORS (All Resistors are \pm 5% and 1/8W)
RM02	1	GD05471180	470 Ω
RM03	1	GD05221180	470 Ω
RM04	1	GD05221180	220 Ω
RM05	1	GD05221180	220 Ω
QM01	1	HI10029030	PM01-SEMICONDUCTORS
QM02	1	HI10014030	L.E.D. SL1405-21
QM03	1	HI10014030	L.E.D. SLP 151B
QM04	1	HI10025030	L.E.D. SLP 151B
QM05	1	HI10025030	L.E.D. SLP 251B
QM06	1	HI10025030	L.E.D. SLP 251B
SM01	1	SP01010570	PM01-MISCELLANEOUS
SM02	1	SP01010570	Push Switch
SM03	1	SP01010570	Push Switch
SM04	1	SP01010570	Push Switch
PT01	1	WF211C0030 ZZ211C0030	P.W. Board, Tone P.W. Board, Tone Burst Ass'y
C001	1	DK26103020	PT01-CAPACITORS
C002	1	DK26104010	Ceramic 0.01 μ F \pm 10%
C003	1	EV33501660	Ceramic 0.1 μ F \pm 10%
C004	1	DK26333010	Elect 3.3 μ F 16V
C005	1	DK26472010	Ceramic 0.033 μ F \pm 10%
C006	1	DK26473010	Ceramic 0.0047 μ F \pm 10%
C009	1	EV10601060	Ceramic 0.047 μ F \pm 10% Elect 10 μ F 10V

REF. DESIG.	Q'TY	PART NO.	DESCRIPTION
R001	1	GD05103180	PT01-RESISTORS
R002	1	GD05104180	10K Ω 1/8W
R003	1	GD05105180	100K Ω 1/8W
R004	1	GD05224180	1M Ω 1/8W
R005	1	RA01030520	220K Ω 1/8W
R006	1	GD05824180	10K Ω 1/8W
R007	1	RA04730100	820K Ω 1/8W
R008	1	GD05473180	47K Ω Trimming
R009	1	GD05821180	47K Ω 1/8W
R010	1	RA01030530	820 Ω 1/8W Trimming
R011	1	GD05223180	10K Ω 1/8W
R012	1	GD05224180	22K Ω 1/8W
R013	1	GD05103180	220K Ω 1/8W
Q001	1	HT305360F0	PT01-SEMICONDUCTORS
Q002	1	HD20011050	Transistor 2SC536(F)
Q003	1	HC409317B0	Diode 1S1555
Q004	1	HD20011050	IC MC14093B
Q005	1	HT305360F0	Diode 1S1555 Transistor 2SC536(F)
901G	1	211C160060	Bracket (Tone)
902G	1	51282605B0	B.H. Tapped Screw B2.6 x 5
903G	1	51102605A0	B.H.M. Screw B2.6 x 5
904G	1	211C120070	Insulator for Tone P.W.B.
PV01	1	WZ211C0510 ZZ211C0510	P.W. Board, VCO P.W. Board, VCO Ass'y.
CV01	1	DC18102030	PV01-CAPACITORS
CV02	1	DD41100360	Feedthru 1000pF
CV03	1	DD40030300	Ceramic 10pF \pm 0.5pF N750
CV04	1	DD41070300	Ceramic 3pF \pm 0.25pF
CV05	1	CT10400010	Ceramic 7pF \pm 0.5pF Trimming 4pF \pm 0.25pF

REF. DESIG.	Q'TY	PART NO.	DESCRIPTION
CV06	1	DK46471300	Ceramic 470p F ±10%
CV07	1	DD40020300	Ceramic 2p F ±0.25pF
CV08	1	DD40040300	Ceramic 4p F ±0.25pF
CV09	1	CT10400010	Trimming 4p F ±0.25pF
CV10	1	DK46102300	Ceramic 0.001μF ±10%
CV11	1	EV10502560	Elect 1μF 25V
CV12	1	DD45101300	Ceramic 100p F ±5%
CV13	1	DD45101300	Ceramic 100p F ±5%
CV14	1	DK46102300	Ceramic 0.001μF ±10%
CV15	1	DD40050300	Ceramic 5p F ±0.25pF
CV16	1	DD41100300	Ceramic 10p F ±0.5pF
CV17	1	DD40010300	Ceramic 1p F ±0.25pF
CV18	1	DD45101300	Ceramic 100p F ±5%
CV19	1	DK46102300	Ceramic 0.001μF ±10%
CV20	1	DD45101300	Ceramic 100p F ±5%
CV21	1	DK46102300	Ceramic 0.001μF ±10%
CV22	1	DC18102030	Feedthru 1000p F
CV23	1	DC18102030	Feedthru 1000p F
CV24	1	DC18102030	Feedthru 1000p F
CV25	1	EA10701030	Elect 100μF 10V
RV01	1	GD05220140	PV01-RESISTORS (All Resistors are ±5%) 22Ω ¼W
RV02	1	R105220180	22Ω, Chip 1/8W
RV04	1	R105123180	12KΩ, Chip 1/8W
RV05	1	R105822180	8.2KΩ, Chip 1/8W
RV06	1	R105101180	100Ω, Chip 1/8W
RV07	1	R105152180	1.5KΩ, Chip 1/8W
RV08	1	R105103180	10KΩ, Chip 1/8W
RV09	1	GD05101180	100Ω ¼W
RV10	1	GD05101140	100Ω ¼W
RV11	1	GD05101140	100Ω ¼W

REF. DESIG.	Q'TY	PART NO.	DESCRIPTION
RV12	1	GD05103140	10KΩ ¼W
RV13	1	R105271180	270Ω, Chip 1/8W
RV14	1	R105472180	4.7KΩ, Chip 1/8W
QV01	1	HD40001060	PV01-SEMICONDUCTORS Varicap 1SV50
QV02	1	HD20001200	Diode M1301
QV03	1	HF201251B0	F.E.T. 2SK125 (4)
QV04	1	HT32026100	Transistor 2SC2026
LV01	1	LC11510100	PV01-MISCELLANEOUS Choke Coil 10T
LV02	1	LA70350030	VCO Coil 11/2T
LV03	1	LC11510100	Choke Coil 10T
LV04	1	LC11510100	Choke Coil 10T
LV05	1	LC13010022	Choke Coil 100K
LV06	1	LL635004A0	Coil (4T)
LV07	1	LC11530040	Choke Coil 15μH
K101	1	FC50068010	Ferrite Core TDK
K102	1	FC50068010	Ferrite Core TDK

186-15 82-9-[17-01]

Assembly and Wiring

Adjustment

Correction

(W01-99)

(T01-99)

(X01-00)

Use this page as a bracket mounting hole pattern for mobile installation.

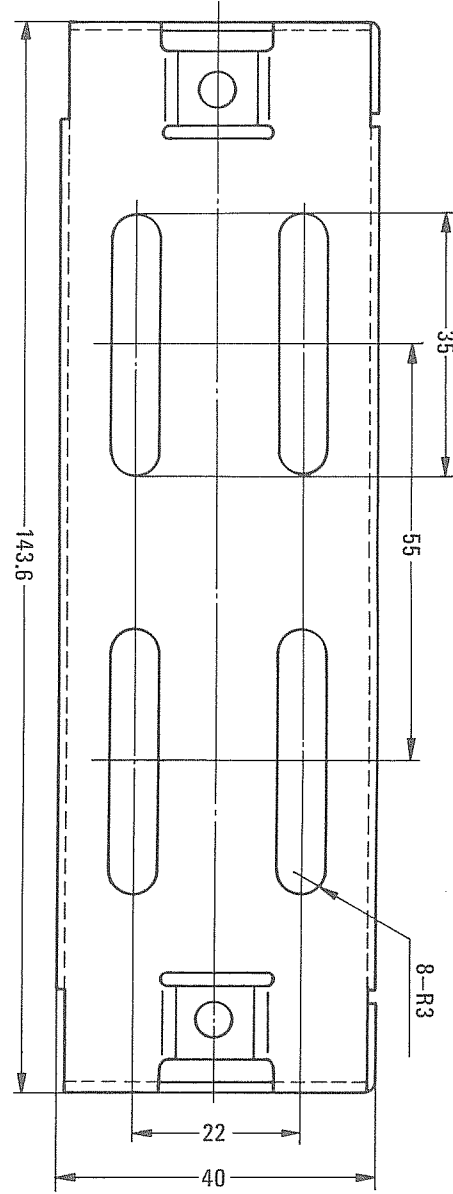

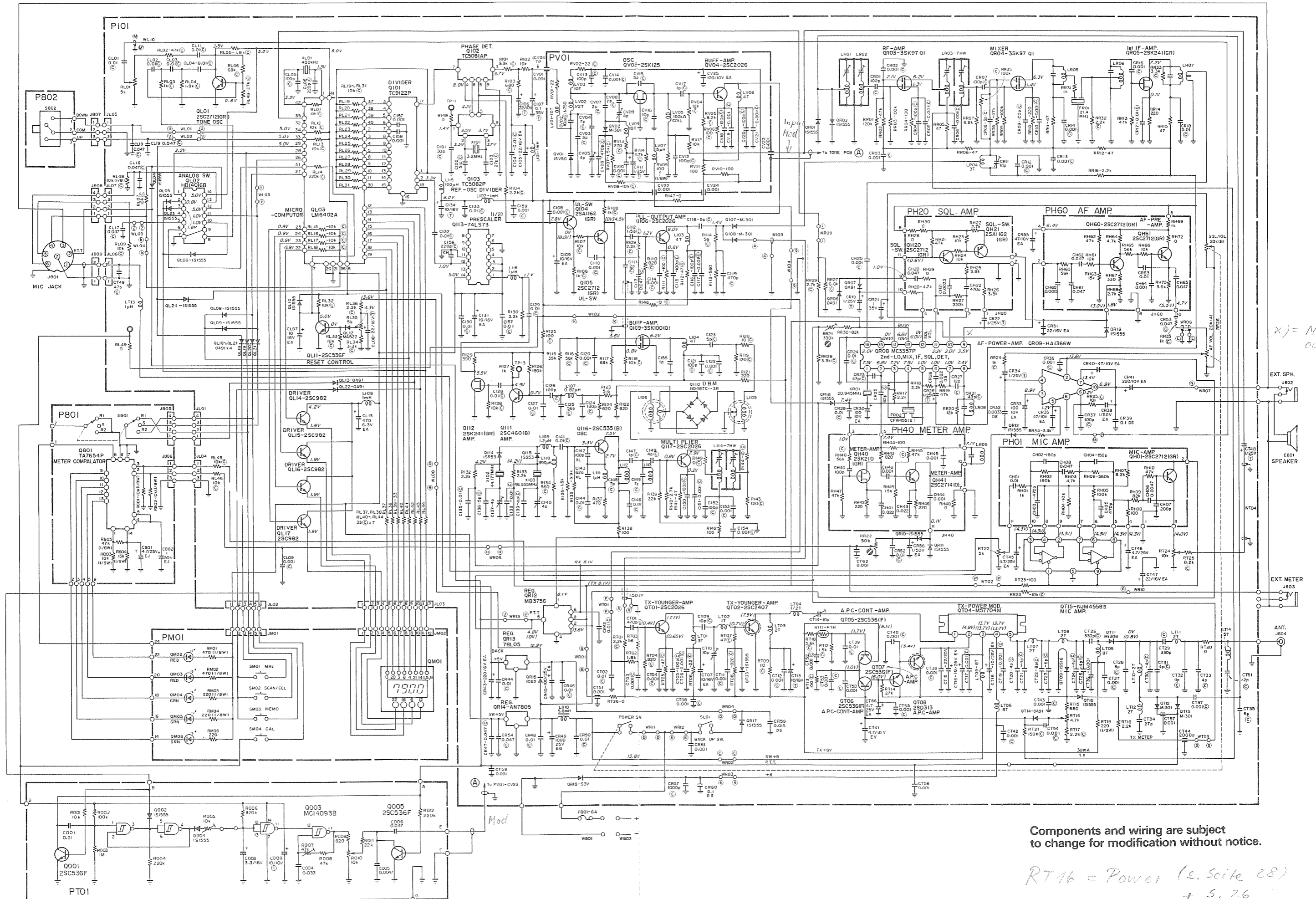

Components and wiring are subject to change for modification without notice.

RT16 = Power (s. Seite 28) + 5.26