

MODEL 400 S.N. B152404
470 S.N. V122502
117B S.N. K139620

OPERATION AND MAINTENANCE

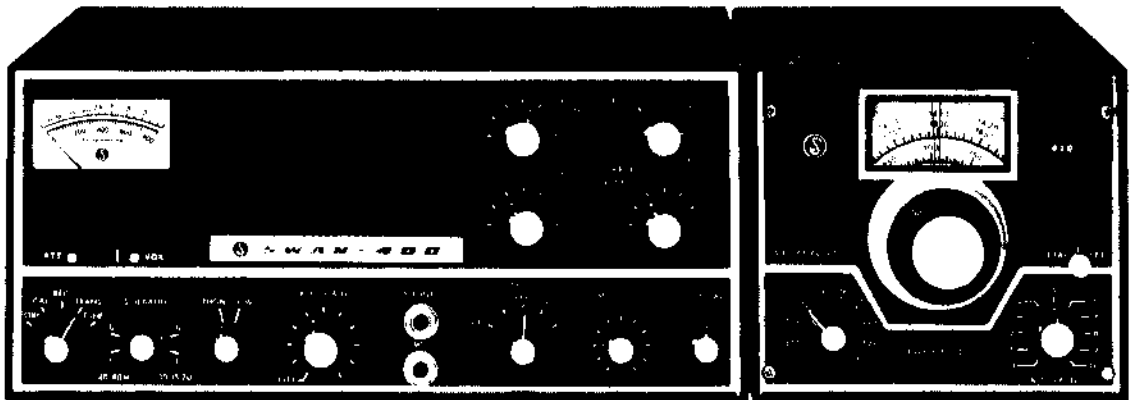

SWAN MODEL 400

 **SWAN**
ELECTRONICS
Oceanside, California

OPERATION and MAINTENANCE
MODEL 400 SERIES
SINGLE SIDEBAND TRANSCEIVER

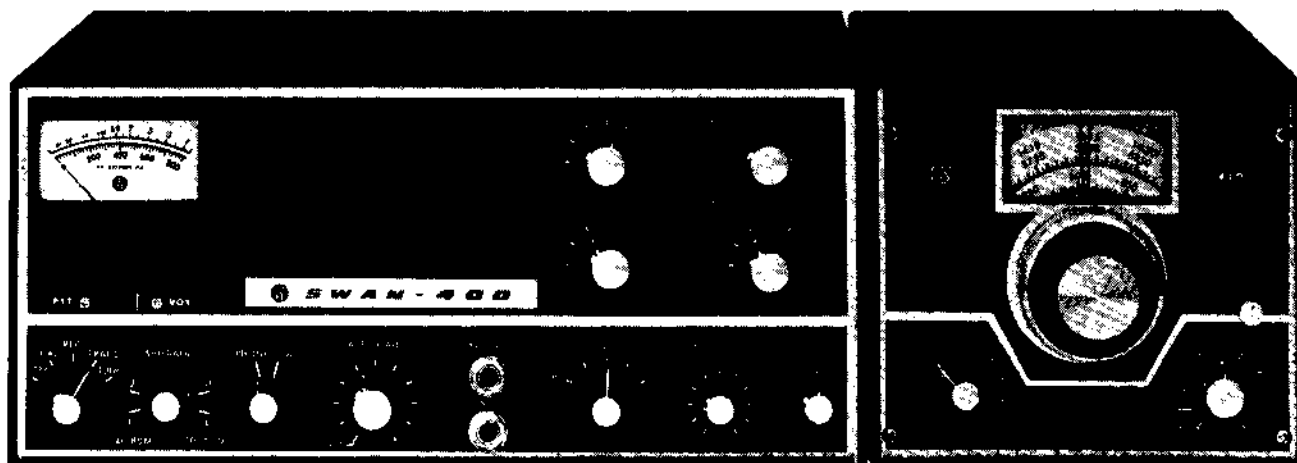

INTRODUCTION

The Swan Model 400 Single Sideband Transceiver, together with its accessories and optional equipment, is designed to be used in either CW or SSB modes on all portions of the 80-, 40-, 20-, 15-, and 10-meter amateur radio bands. Operation on AM (Single Sideband with Carrier) is possible by zero-beating the received signal.

The Swan 400 generates the single sideband signal by means of a crystal lattice filter, and the transceive operation automatically tunes the transmitter to the received frequency. Provisions are included in the transceiver for operation on either upper or lower sideband, and provisions for complete band coverage are included within the basic transceiver.

Basic circuitry of the single conversion design has been proven in thousands of hours of operation of the very popular Swan 240 and 350 series of transceivers. Mechanical, electrical, and thermal stability are exceptionally high, and all oscillators are voltage regulated and temperature compensated. Push-to-talk operation is possible in all installations, and operation with a two-contact

microphone is possible by use of the Function Switch or the VOX accessory. The basic transceiver is designed for use with either the Model 410 Frequency Control Unit, which provides full coverage of all portions of the amateur bands, or with the Model 406B Frequency Control Unit which provides coverage of all phone portions of the 80 through 15 meter bands and a 500 kc portion of the 10-meter band. With a suitable power supply, operation may be fixed, portable or mobile.

Power input on all bands exceeds 400 Watts, PEP, on single sideband, and 320 Watts DC input on CW. The basic transceiver includes automatic gain control, (AGC) automatic limiting control, (ALC), selectable sideband, grid-block keying, calibrator, and speaker.

Part I of this Manual covers the basic transceiver. Parts II and III cover the Models 406B and 410 Frequency Control Units, respectively. Part IV covers the recommended power supplies, Model 117-XB or 117-XC for ac operation and Model 14-117 for 12 volt dc operation. Models are also available for 230 volt AC operation.

**SWAN**
ELECTRONICS CORP.
Oceanside, California

I MODEL 400 TRANSCEIVER

SPECIFICATIONS

FREQUENCY RANGES

Model 410 Frequency Control Unit

Full frequency coverage of 80, 40, 20, 15, and 10 meter amateur radio bands in 8 ranges of 500 kc each, as follows: 3.5-4.0, 7.0-7.5, 13.85-14.35, 21.0-21.5, 28.0-28.5, 28.5-29.0, 29.0-29.5, 29.2-29.7 mc.

Model 406B Frequency Control Unit

Full phone band coverage of 80, 40, 20, and 15 meters, plus a 500 kc segment of 10 meters, as follows: 3.8-4.0, 7.1-7.3, 14.15-14.35, 21.25-21.45, 28.5-29.0 mc.

POWER INPUT

Single Sideband Suppressed Carrier

400 Watts PEP, minimum, on all bands.

CW

320 Watts DC input on all bands.

AM (Single Sideband With Carrier)

125 Watts DC input on all bands.

DISTORTION

Distortion products down at least 30 db.

UNWANTED SIDEBAND SUPPRESSION

Unwanted sideband down at least 40 db.

CARRIER SUPPRESSION

Carrier suppression at least 50 db.

RECEIVER SENSITIVITY

Less than 0.5 microvolt at 50 ohms impedance for signal-plus-noise to noise ratio of 10 db.

AUDIO OUTPUT AND RESPONSE

Audio output through built-in speaker approx. 3 watts to 3.2 ohm load. Response essentially flat 300 to 3000 cps on both receive and transmit.

METERING

PA Cathode current, 0-800 ma on transmit S-Meter, 0-70 db over S9 on receive.

FRONT PANEL CONTROLS

Function Switch, Sideband Selector, Phone-CW, AF Gain, Bandswitch, Mic. Gain, Carrier Balance, PA Plate Tune, PA Grid Tune, PA Load Coarse, PA Load Fine, VOX-PTT

REAR PANEL CONTROLS

AND CONNECTORS

Bias Potentiometer, Grid-Block CW key jack, Jones plug power connector, VOX Connector, Frequency Control Unit Connector, Antenna, S-Meter Zero, SPDT Relay Terminal.

FREQUENCY CONTROL UNIT CONTROLS

Bandswitch, Main Tuning, RF Gain

VACUUM TUBE COMPLEMENT

- V1 - 6EW6 VFO Amplifier
- V2 - 12BE6 Transmitter Mixer
- V3 - 6GK6 Driver
- V4 - 6HF5 Power Amplifier
- V5 - 6HF5 Power Amplifier
- V6 - 12BZ6 Receiver RF Amplifier
- V7 - 12BE6 Receiver Mixer
- V8 - 6EW6 First IF Amplifier
- V9 - 12BA6 Second IF Amplifier
- V10 - 12AX7 Product Detector/Receiver Audio
- V11 - 6BN8 AGC Amplifier/Detector
- V12 - 6GK6 Audio Output
- V13 - 12BA6 100 KC Crystal Calibrator
- V14 - 7360 Balanced Modulator
- V15 - 12BA6 Carrier Oscillator
- V16 - 12AX7 Mic. Amplifier/Transmit Audio
- V17 - OA2 Voltage Regulator

DIODE AND TRANSISTOR COMPLEMENT

- Q1* 2N706 Oscillator
 - Q2* 2N706 Emitter Follower
 - D401 TS-2 ALC Diode
 - D402 TS-2 ALC Diode
 - D601 TS-2 S-Meter Delay
 - D1701 1N2974A Zener Voltage Regulator
- * Transistor complement identical for either Model 410 or Model 406B Frequency Control Unit.

TRANSMITTER OUTPUT IMPEDANCE

Wide-range Pi-network output matches antennas essentially resistive at 20 to 300 ohms impedance with provisions for both coarse and fine adjust.

POWER REQUIREMENTS

- Filaments 12.6 volts, 5.5 amp ac or dc
- Relay 12 volts dc, 250 ma
- Bias -110 volts dc, 100 ma
- Medium Voltage 275 volts dc, 150 ma trans.
- High Voltage 800 volts dc, 500 ma

DIMENSIONS

Model 400 Transceiver

5-1/2 in. high, 13 in. wide, 11 in. deep

Model 410 Frequency Control Unit

5-1/2 in. high, 6-1/2 in. wide, 11 in. deep

Model 406B Frequency Control Unit

3 in. high, 4-3/4 in. wide, 5 in. deep.

WEIGHT

- Model 400 Transceiver 17 lb.
- Model 410 Frequency Control Unit 9 lb.
- Model 406B Frequency Control Unit 3 lb.

PART I MODEL 400 TRANSCEIVER

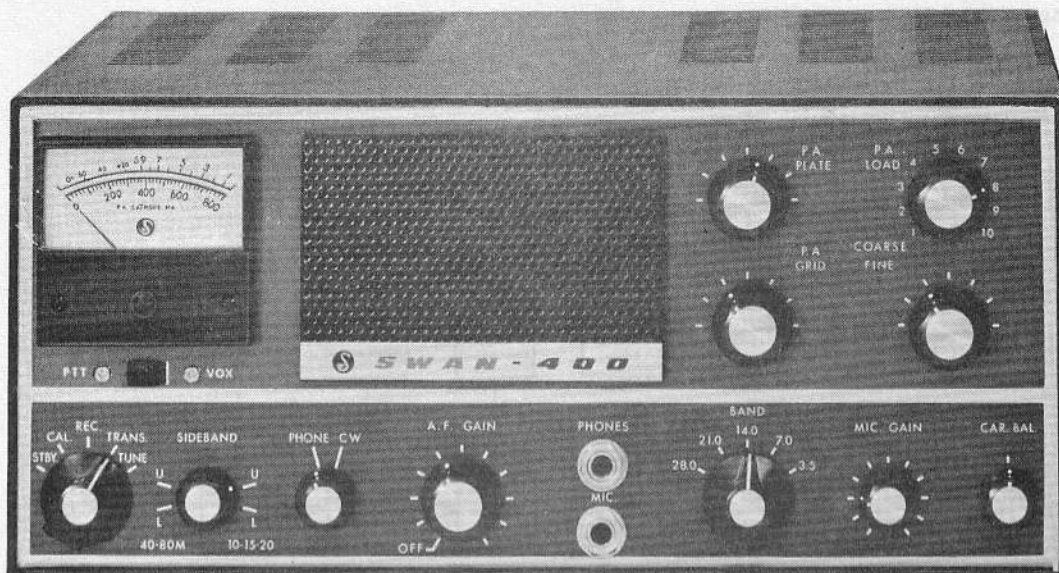

A. CIRCUIT THEORY

GENERAL DISCUSSION

The Swan 400 Transceiver provides single sideband, suppressed carrier transceive operation, and generates the single sideband signal by means of a crystal lattice filter. To permit a logical discussion of this mode of operation, certain definitions are necessary. In a normal AM signal (double sideband with carrier), a radio frequency is modulated with an audio frequency signal. This is considered by many to be merely a case of varying the amplitude of the carrier at an audio rate. In fact, however, there are actually sideband frequencies generated which are the results of mixing the RF and AF signals. These sidebands are the sum of, and the difference between the two heterodyned signals. For detection by means of conventional diode detectors, the two sidebands are mixed with the carrier to detect and to demodulate the audio intelligence. This inefficient means of transmission permits only approximately 25 per cent of the full transmitted power to be used to transmit intelligence. There are other attendant drawbacks, also. The bandwidth of the transmitted

signal is on the order of 6 kc, while the actual demodulated audio is less than 3 kc. The result is very limited use of the band, and over half of the allotted frequency range is unusable because of heterodynes, interference, and congestion.

In the single sideband, suppressed carrier mode of transmission, only one sideband of the RF and AF heterodyned signal is transmitted, the other sideband and the carrier being suppressed to a level which effectively permits using only the audio intelligence bandwidth. This results in increasing the transmission efficiency many times over, and permits an effective doubling of the use of the allocated frequencies.

It must be remembered that in the single sideband, suppressed carrier mode of transmission, both the unwanted sideband and the carrier are only suppressed, not entirely eliminated. Thus, with a transmitted signal from a transmitter with 40 db sideband suppression, the other, or unwanted sideband is present, and it is transmitted, but its level is 40 db below the wanted sideband. When

I MODEL 400 TRANSCEIVER

A. Circuit Theory (Cont)

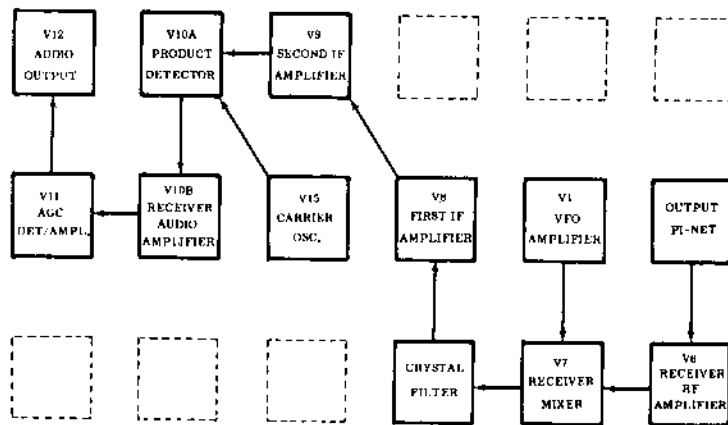

FIGURE 1 BLOCK DIAGRAM, RECEIVE

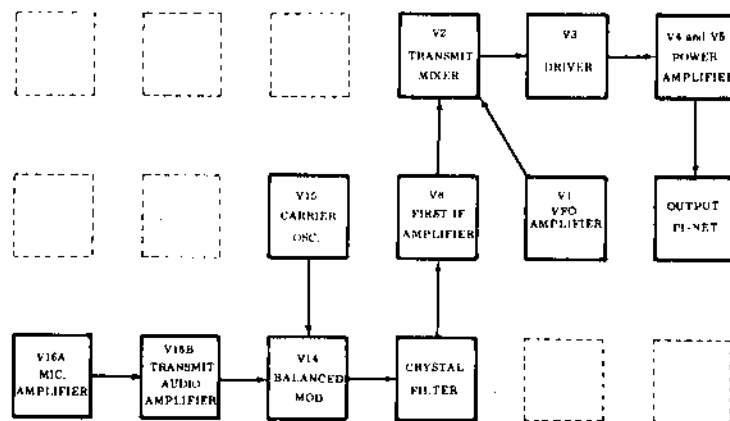

FIGURE 2 BLOCK DIAGRAM, TRANSMIT

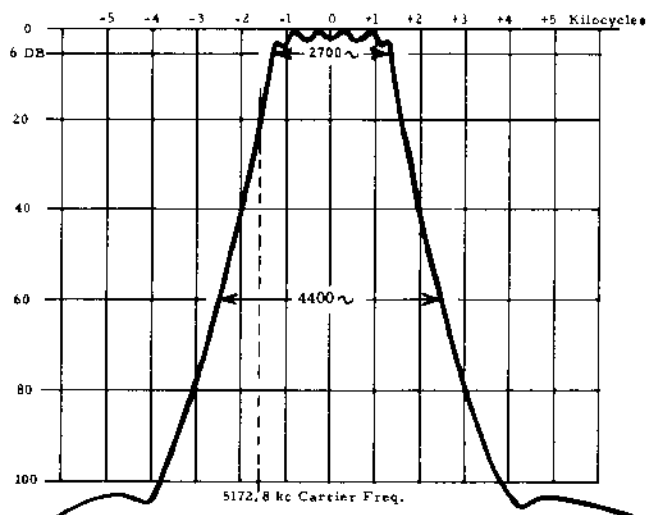

FIGURE 3 CRYSTAL FILTER, TYPICAL CHARACTERISTIC

I MODEL 400 TRANSCEIVER

A. Circuit Theory (Cont)

this signal is received at a level of 20 db over S9, the unwanted sideband will be present at a level of approximately S5. The same is true of carrier suppression. With carrier suppression of 50 db, and a signal level of 50 db over S9, carrier will be present at a level of approximately S3 to S4.

In the Model 400 Transceiver, the single sideband, suppressed carrier signal is generated by the crystal lattice filter method. Refer to the schematic diagram, and to Figures 1 and 2, Block Diagrams.

SIGNAL GENERATION

In the TRANSMIT position (i. e., when the push-to-talk switch on the microphone is pressed or when the Function Switch is moved to TRANSMIT), the transmitter portion of the transceiver is activated, and generates a single sideband, suppressed carrier signal in the following manner: Carrier is generated by V15, Carrier Oscillator, which is a Pierce oscillator, with the crystal operating in parallel resonance. This stage operates in both the transmit and receive modes. When transmitting, the RF output of the oscillator is injected into the control grid of the Balanced Modulator, V14. This balanced modulator is a beam deflection type, and operates similar to a cathode ray tube in that the electron beam from the cathode is deflected to one output plate or the other by the charge appearing on the deflection plates. The RF energy fed to the control grid of the balanced modulator appears on both plates of the output, in the absence of signals to the deflection plates. The two output plates feed the carrier to Transformer Z1401 in push pull, and the two RF signals cancel each other out in the output of the transformer. The deflection plate reference voltages are adjusted by means of the carrier balance control

so that with no audio, the RF being fed to the output plates will cancel out, and the output from Z1401 will be zero. Audio from Microphone Amplifier V16 is superimposed on one deflection plate, thereby unbalancing the modulator, and the two sidebands resulting from the sum and difference frequencies of the audio and carrier appear as a double sideband, suppressed carrier signal in the output of Transformer Z1401. The carrier suppression is approximately 50 db.

The double sideband, suppressed carrier signal is then coupled to the crystal filter, which suppresses one sideband, and permits the other sideband to be fed to the First IF Amplifier, V8. The carrier frequency crystal and the filter crystals are selected so that in the LSB position on 40 and 80 meters, the sideband signal is generated with a carrier frequency of 5172.8 kc, and this signal will fall within the bandpass of the filter such that the lower sideband will be attenuated by at least 40 db. See Figure 3. On the USB position of 40 and 80 meters, the carrier crystal is 5176.8 kc, which positions the double sideband signal on the other side of the response curve of the filter, attenuating the upper sideband by at least 40 db. In the single conversion mixing process, these sidebands become inverted.

On 20, 15, and 10 meters, where operation is generally on upper sideband, the signal is generated with the same carrier crystal used in generating the lower sideband on 40 and 80 meters. The five crystal filter used in the transceiver results in an improved response characteristic on the low frequency end of the bandpass, and advantage is taken of this effect to provide better sideband suppression on the most used sideband for each frequency band.

I MODEL 400 TRANSCEIVER

A. Circuit Theory (Cont)

The single sideband, suppressed carrier signal from the First IF Amplifier is fed to the Transmitter Mixer, V2, where signals from the VFO Amplifier are mixed, and the resultant signal at the final transmitted frequency is amplified through the Transmitter Mixer, the Driver, V3, and the Power Amplifiers, V4 and V5. The signal from the VFO Amplifier is initiated in the particular Frequency Control Unit being used. The signal from the Frequency Control Unit is routed to the VFO Amplifier, and on 40 and 80 meters, is subtractively mixed with the single sideband signal from the IF Amplifier. On 20, 15, and 10 meters, the frequencies are additively mixed, resulting in output on the opposite sideband.

When in TRANSMIT, the gain of the First IF Amplifier is controlled through the Automatic Limiting Control network D401-402, etc., to control the gain of the stage in response to the average input power to the power amplifiers. This ALC system will compensate for any extremely strong input signals, but does not completely eliminate the necessity of proper adjustment of the Mic. Gain Control. Although this feature will prevent the transmitter from flat-topping and spurious emissions, considerable distortion may occur if the Mic. Gain control is not properly adjusted. Refer to Operating Instructions.

TUNE AND CW OPERATION

Normally, the frequency of the carrier oscillator is approximately 300 cps outside the passband of the crystal lattice filter. In TUNE position, to enable the transmitter to be tuned to the maximum power output condition, the frequency of the carrier oscillator is moved approximately 500 cps to place it well within the passband of the crystal lattice filter.

At the same time, one deflection plate of the balanced modulator is grounded, unbalancing the modulator and allowing full carrier input for tuning purposes. A similar procedure is followed in the CW position of the Phone-CW switch, to allow full carrier output during CW operation. During CW operation the cathode of V16B is opened from ground, cutting off the tube. This allows CW operation with no danger of pickup of audio through an open microphone. Attempts to operate on CW by keying the microphone jack, and inserting carrier, are not recommended.

RECEIVE

In RECEIVE position, or at any time when the transmitter is not in TRANSMIT or STANDBY, all circuits used in transmitting are disabled through the relay controlled circuits, the relays being energized for transmitting, and de-energized for receiving. Relay K2, when de-energized, allows signals from the transmitting tank circuit and antenna to be fed to the Receiver RF Amplifier, V6, where they are amplified, and then fed to the control grid of the Receiver Mixer, V7. The local oscillator signal from the VFO Amplifier is now used to heterodyne the received frequency to the IF frequency, either upper or lower sideband. All IF amplification is accomplished at this frequency, nominally 5174.5 kc, and in the Product Detector V10A, the IF frequency is heterodyned with carrier frequency generated by Carrier Oscillator, V15, to result in detection of the same sideband used to generate the transmitted signal. It is thus not possible for the transceiver to receive a signal on any frequency other than that to which the transmitter is tuned, nor to detect the wrong sideband. This simple single conversion design results in an extremely stable signal, and an image response down more than 80 db. Since the VFO frequency from the

I MODEL 400 TRANSCEIVER

A. Circuit Theory (Cont)

Frequency Control Unit is determined by circuit elements which are far removed from any heat source, and the voltage regulation is very precise to the transistor oscillator, frequency stability is extremely good.

Automatic Gain Control, (AGC) is provided by the AGC Amplifier/Detector, V11, which provides an AGC signal for control of the gain of V6, Receiver RF Amplifier, V7, Receiver Mixer, and V9, Second IF Amplifier.

TRANSMIT AND RECEIVE SWITCHING

All transmit and receive switching is performed by relays K1 and K2. In TRANSMIT position, only those tubes that operate in the transmit mode are operative, all others being biased to cut-off through the relay contacts. In the RECEIVE position, with the relay de-energized, the tubes that are normally used only in transmitting are cut off in the same manner. Relay K2, which when de-energized feeds signals from the output pi-network to the receiver, and is used also to control any external switching. In the TRANSMIT position, the meter indicates the combined cathode current of the two Power Amplifiers. In the RECEIVE position, it indicates the voltage across R902 in the cathode of the Second IF Amplifier, V9, which is inversely proportional to the AGC voltage used to control the gain of the tube. Thus the S-Meter reads left to right on transmit, and right to left on receive.

POWER RATING

The Swan 400 is capable of 400 watts, PEP input under steady two-tone test conditions, when operated with any of the recommended power supplies. The peak envelope power, when voice modu-

lated, is considerably more, typically 500 watts, or more.

Recommended power supplies produce a no-load plate voltage of approximately 925 volts. Under TUNE conditions, or CW operation, this voltage may drop to as low as 720 volts. Under steady state two-tone modulation, the voltage will drop to approximately 750 volts. If Power Amplifier idling current is 50 ma, and two tone plate current, just before flat-topping, is 375 ma, the peak two-tone current will be 560 ma. The PEP input will then be 750 volts x 560 ma = 420 watts. Under voice modulation, because average power is considerably less, the Power Amplifier plate and screen voltages will be maintained higher, even during voice peaks, by the power supply filter capacitors. Peak voice plate current will therefore also be higher than with two-tone test conditions. Under typical operating conditions, peak plate current before flat-topping will be 625 ma at 800 volts, to result in a peak envelope power input of 500 watts.

Readings of cathode current would not reflect this 500 watt power input, however, because of the damping in the cathode current meter. The meter damping is such that the meter is unable to respond to variations of cathode current in the audible range. Cathode current readings under normal voice input, should not exceed approximately 150 to 175 ma.

POWER AMPLIFIER PLATE DISSIPATION

There is often a misunderstanding about the plate dissipation of tubes operated as AB amplifiers under voice modulation. In the Swan 400, while in the transmit position, and with no modulation, the plate voltage will be 890 volts, the plate current 50 ma, and the power input will be 50 watts.

I MODEL 400 TRANSCEIVER

A. Circuit Theory (Cont)

Authorities agree that the average voice power is 10 to 20 db below peak voice power. Normally some peak clipping in the Power Amplifier can be tolerated, and a peak-to-average ratio of only 6 db may sometimes occur. Under such a condition, the average power input will be 125 watts, and plate current will be about 156 ma. With an average Power Amplifier efficiency of 55 per cent, plate dissipation will be 57 watts, or 28.5

watts per tube. The 6HF5 is rated at 28 watts continuous duty cycle in normal TV service. Thus it can be seen that under normal operating conditions the PA tubes in the Swan 400 are not being driven very hard. Only during the tune up is there any need to exercise caution by limiting the length of time the unit is held in the TUNE position to about 30 seconds at a time.

B. INSTALLATION

GENERAL

The Swan 400 transceiver has been designed to provide the utmost in ease of operation, stability, versatility, and enjoyment. Maximum enjoyment from your Swan will depend to a great extent on the installation. For fixed station or portable use, operation with the Model 117XB or 117XC power supply provides a compact arrangement with maximum ease of operation. All switching is performed in the transceiver. For mobile installations, the Model 14-117 supply provides switching arrangements, and speaker output may be fed through the car broadcast receiver speaker.

POWER SUPPLY

The Swan Models 117XB or 117XC power supplies provide all necessary voltages required by the transceiver. The supplies come equipped with a pre-wired plug and cable, all ready for plugging into the transceiver. The Model 14-117 supply for mobile operation includes all necessary cables, connector plug, fuses, and installation hardware. The Jones plug for connection to the transceiver is furnished with the unit.

Power requirements for the Swan 400 are shown in the following table. Pin connections to the Jones type power connector are also listed as an aid in connecting other brands or home-brew power supplies.

	Pin	Nominal	Minimum	Maximum
High Voltage	8	800 VDC 500 MA	600 VDC Low Pwr.	1000 VDC Hi. Power
Medium Voltage	10	275 VDC 150 MA	225 VDC	325 VDC
Bias Voltage	3	-110 VDC 100 MA	-100 VDC	-130 VDC
Filament Voltage	4	12.6 V* 5.5 amp.	11.5 V	14.5 V
Relay Voltage	5	12 VDC 250 MA	10 VDC	14.5 VDC

*AC or DC

EXTERNAL SPEAKER CONNECTIONS

Audio output from the transceiver is provided at pin 12 of the Jones plug. The other speaker lead goes to the common chassis ground at pin 6. Output impedance is between 3 and 4 ohms. For mobile installations, the car broadcast speaker may be used, in which case a DPDT

I MODEL 400 TRANSCEIVER

B. Installation (Cont)

selector switch should be installed to select either the broadcast receiver or transceiver output.

MICROPHONE

The microphone input is designed for high impedance microphones only. The choice of microphone is important, for good speech quality, and should be given serious consideration. The crystal lattice filter in the transceiver provides all the restriction necessary on audio response, and further restriction in the microphone is not required. It is more important to have a microphone with a smooth, flat response throughout the speech range. The microphone plug should be a standard 1/4 in. diameter three-contact type. The tip connection is for push-to-talk relay control, the ring connector is for the microphone terminal, and the sleeve is for the common chassis ground. The manufacturer's instructions should be followed in connecting the microphone cable to the plug. With many microphones, the push-to-talk button must be pressed to make the microphone operative, even though the panel function switch is in the transmit position. This feature may be disabled, if desired, by opening the microphone case and permanently connecting the contacts which control the microphone.

ANTENNA

Any of the common antenna systems designed for use on the high frequency amateur bands may be used with the Swan transceiver, provided the input impedance of the transmission line is not outside the capability of the pi-output matching network. An antenna which reflects a standing wave ratio on 50 or 75 ohm transmission line, below approximately 4:1 at the proposed operating frequency, or a system that results in a

transmission line input impedance that is essentially resistive and between 15 and 500 ohms will take power from the transceiver with little difficulty. If tuned open-wire transmission line is used to excite the antenna, a suitable antenna tuner should be used between the transceiver and the antenna to provide a reasonable impedance match between the unbalanced coaxial output and the balanced open-wire line. Methods of constructing and operating such tuners are described in detail in the ARRL Antenna Handbook, and similar publications. For operation on the 75- and 40-meter bands, a simple dipole antenna, cut to resonate in the most used portion of the band, will perform satisfactorily. For operation on the 10, 15, and 20 meter bands, the efficiency of the station will be greatly increased if a good directional rotary antenna is used.

MOBILE ANTENNA

Mobile antenna installations are critical, since any mobile antenna for use on the high frequency bands represents a number of compromises. Many amateurs lose the efficiency of their antenna through improper tuning. Points to remember about the mobile antenna used with the Swan 400 are:

1. The "Q" of the antenna loading coil should be as high as possible. There are several commercial models available which use high "Q" coils, including the Swan Model 45 and Model 55 5 band "Swantennas."
2. The loading coil must be capable of handling the power of the Model 400 without overheating. In TUNE position, the power output of the transceiver may exceed 250 watts. Wide spaced, heavy wire loading coils are essential.

I MODEL 400 TRANSCEIVER

B. Installation (Cont)

3. The SWR bridge is a useful instrument, but unfortunately it is quite often misunderstood and overrated in importance. Basically, the SWR bridge will indicate how closely the antenna load impedance matches the transmission line. With long transmission lines, such as will be used in many fixed station installations, it is desirable to keep the impedance match fairly close in order to limit power loss. This is particularly true at the higher frequencies. The longer the line, and the higher the frequency, the more important SWR becomes. However, in mobile installations the transmission line seldom exceeds 20 feet in length, and an SWR of even 4 to 1 adds very little to power loss. The only time SWR will indicate a low figure is when the antenna presents a load close to 50 ohms, but many mobile antennas will have a base impedance as low as 15 or 20 ohms at their resonant frequency. In such a case, SWR will indicate 3 or 4 to 1, and yet the system will be radiating efficiently.
4. The really important factor in your mobile antenna is that it should be carefully tuned to resonance at the desired frequency. The fallacy in using an SWR bridge lies in the fact that it is sometimes possible to reduce the SWR reading by detuning the antenna. Field strength may actually be reduced in an effort to bring SWR down. Since field strength is the primary goal, we recommend a Field Strength Meter for antenna tuning.

5. For antenna adjustments, the Swan 400 may be loaded lightly to about 100 ma. cathode current instead of the usual 500 ma. This will limit tube dissipation during adjustments, and will also help reduce interference on the frequency. In any case, do not leave the transmitter on for very long at one time. Turn it on just long enough to tune and load, and get a field strength reading.

Start out with the antenna whip at about the center of its adjustment range. Set the VFO to the desired operating frequency and then adjust P. A. TUNE for dip, and P. A. LOAD for 100 ma. Then observe the field strength reading. The Field Strength Meter may be set on top of the dash, on the hood, or at an elevated location some distance from the car.

Change the whip length a half inch, or so, at a time, retune the P. A. for 100 ma. loading each time, and check field strength. Continue this procedure until the point of maximum field strength is found. This adjustment will be most critical on 75 meters, somewhat less critical on 40, etc., until on 10 meters the adjustment will be quite broad. After tuning the antenna to resonance, load the P. A. to full power.

I MODEL 400 TRANSCEIVER

B. Installation (Cont)

CONTROL FUNCTIONS

Functions of the various controls are as follows:

ON-OFF SWITCH	Controls main power to the transceiver.	CARRIER BALANCE	Controls potentiometer R1405 in the balanced modulator deflection plate circuit, and permits balancing of the carrier.
FUNCTION SWITCH	Controls the various modes of operation of the transceiver.		
Standby	DC Supply - Power to the transceiver is disabled. AC Supply - All voltages except medium voltage are supplied.	RF GAIN (In Frequency Control Unit)	Controls variable resistor R1801 which is common in the cathodes of V6, RF Amplifier, V8 1st IF Amplifier, and V9, 2nd IF Amplifier, controlling gain of these stages.
Calibrate	AC Supply - Plate and screen voltage are applied to V13. DC Supply - 12 volts dc is provided to the relay circuit, high and medium voltages supplied to the plate circuits and bias voltage is provided to the relay controlled circuits.	AF GAIN	Controls potentiometer R1201 in grid circuit of V12 AF Output, and varies the gain of the final audio output amplifier.
Receive	Same as for Calibrate but voltage to V13 removed.	MAIN TUNING	Controls C1804 in frequency determining tank circuit of Frequency Control Unit.
Transmit	12 volt dc circuit through relay K1 and K2 is completed, and all tubes used only in receive are biased to cutoff.	PA GRID	Controls CIA and CIB in plate tanks of transmitter mixer and driver.
Tune	All circuits for transmit are energized, as above, but only deflection plate of the balanced modulator is grounded, capacitor C1504 in the carrier oscillator is removed from ground, C1503 is grounded.	PA TUNE	Controls C417 in pi-network to tune final power amplifier plate to resonance.
		PA LOAD, Fine	Controls C420 in pi-network to match impedance of output load. Tunes input to Receiver RF Amplifier.
		PA LOAD, Coarse	Switches in progressively more capacitance in parallel with PA Load, Fine.
MICROPHONE GAIN	Controls potentiometer R1603 in the grid V16B and controls amount of audio to the balanced modulator.	MAIN BANDSWITCH	Switches, plate coils, and associated capacitors of VFO Amplifier, V1, Transmitter Mixer, V2, and Driver, V3. Also switches tank coil of pi-coupling system and associated capacitors in PA output tank.

C. OPERATION

WARNING

DANGEROUS HIGH VOLTAGE IS PRESENT ON THE PLATE OF THE POWER AMPLIFIER WHENEVER THE POWER SUPPLY IS ENERGIZED. NEVER TURN POWER ON WHEN THE POWER AMPLIFIER COVER IS REMOVED. HIGH VOLTAGE IS ALSO PRESENT AT PIN EIGHT OF THE POWER PLUG.

The Swan Model 400 may be operated with either the Model 406B or Model 410 Frequency Control Unit, and may be operated from 117 volts, ac, 50 to 60 cycle power with the Model 117XB power supply or the Model 117XC power supply. The Model 400 may be operated from a 12.6 volt dc source with the Swan Model 14-117 power supply.

Before connecting any cables to the Swan 400, perform the following steps:

1. Rotate the PA Bias control on the rear chassis apron, fully counter clockwise.
2. Rotate the Function Switch located on the lower left of the front panel counter clockwise to STBY.
3. Rotate the AF Gain Control counter clockwise to operate the power switch to OFF.

POWER SUPPLY AND ANTENNA CONNECTIONS

1. Connect either the Swan 406B or 410 Frequency Control Unit to the 9 pin connector near the center of the rear chassis apron.
2. Connect a 50 to 75 ohm antenna to the coaxial connector on the rear chassis panel.
3. Connect the power supply cable to the Jones connector on the rear chassis apron.

4. Connect the power supply to the proper voltage source.

RECEIVE OPERATION

1. Rotate the AF Gain Control clockwise to about the 3 o'clock position. The power switch will operate applying filament, relay, bias, and 800 volt high voltage to the transceiver.
2. Wait approximately one minute to allow the tube filaments to reach operating temperature. During this period, perform the following steps:
 - (a) Rotate the Sideband Selector to the counter-clockwise position, providing lower sideband on 40 and 80 meters, and upper sideband on 20, 15, and 10 meters. The opposite sideband will be selected when the switch is in the clockwise position.
 - (b) Rotate the Phone-CW switch to Phone.
 - (c) Rotate the Bandswitch to desired band.
 - (d) Rotate Mic. Gain fully counter-clockwise.
 - (e) Rotate Car. Bal. control to the midscale position, with white dot on knob aligned with the index mark on the panel.
 - (f) Preset PA Plate control to mid-position.
 - (g) Preset PA Grid Control to mid-position.
 - (h) Preset PA Load Fine to mid-position.

I MODEL 400 TRANSCEIVER

C. Operation (Cont)

- (i) Rotate PA Load Coarse to position 6.
 - (j) Rotate Bandswitch on Frequency Control Unit to desired band.
 - (k) Set Frequency Control Unit tuning dial to desired operating frequency.
 - (l) Set RF Gain Control to approximately 3 o'clock position.
3. Rotate the Function Switch clockwise to the REC position.
 4. Carefully adjust the PA Grid and the PA Plate controls for maximum receiver noise. Note: The PA Grid Control resonates the transmitter driver stages and the receiver RF amplifier plate circuit. The PA Plate and PA Load controls adjust the input and output capacitors in the transmitter power amplifier final plate circuit, as well as the receiver RF amplifier grid circuit. Proper adjustment of these controls in the receive position will result in approximately resonant conditions in the transmitter stages.

RECEIVER TUNING - IMPORTANT, READ CAREFULLY.

Precise tuning of a single sideband signal is very important. Do not be satisfied to merely tune until the voice can be understood, but take the extra care of setting the dial to the exact spot where the voice sounds natural. Above all, avoid the habit of tuning so that the voice is pitched higher than normal. This is an unfortunate habit practiced by quite a number of opera-

tors. The following points help to explain the effects of mistuning:

1. If you tune so the received voice is higher than normal pitch, you will then transmit off frequency, and your voice will sound lower than normal pitch to the other station. He will probably retune his dial to make you sound right. If you keep this up, you'll gradually waltz one another across the band. If both of you are mistuning to an unnatural higher pitch, you'll waltz across the band twice as fast. (And someone will no doubt be accused of frequency drift).
2. Mistuning results in serious harmonic distortion on the voice, and should be quite noticeable to the average ear. Some will claim that if they don't know how the other person's voice actually sounds, they can't tune him in properly, but this is not true. With a little practice, it will be fairly easy to tell. Some voices are relatively rich in harmonics, and are easier to tune in than a person with a "flat" voice. Also, a transmitter which is being operated properly with low distortion will be easier to tune in than one which is being over-driven and is generating excessive distortion. There is no mistaking when you have a station tuned right on the nose. It will sound just like "AM," so to speak. Mainly, avoid the habit of tuning so everyone sounds higher than normal pitch, or like Donald Duck. This is incorrect, unnecessary and sounds terrible.
3. A vernier control for receive frequency, sometimes referred to as "incremental tuning," is not available on the Swan 400. Such a device is not necessary if proper tuning habits are exercised.

I MODEL 400 TRANSCEIVER

C. Operation (Cont)

4. Your Swan 400 will automatically transmit on exactly the same frequency as the one to which you are listening. There is no adjustment for making them the same, since, by using the same oscillator for both send and receive, it happens automatically. If separation of receive and transmit frequency control is desired, the Model 22 dual VFO adaptor may be installed in the VFO socket on back of the 400, and a pair of 410's or 406B's may then be plugged into the adaptor.
2. Quickly rotate the CAR BAL control on the front panel until the meter reads minimum cathode current.
3. Next, adjust the PA Bias control on the rear of the chassis until the meter reads 50 ma.
4. If this is the first time the transceiver is being tuned on this band, set the PA LOAD switch to position 1. After experience in tuning up, the control may be set to whatever position has been found to be optimum on each respective band. Now, in rapid succession:

CALIBRATE

To calibrate the Model 410 Frequency Control Unit dial, follow these four steps:

1. Rotate the function switch to CAL.
2. Rotate the Kilocycles dial to the 100 kc increment nearest the desired operating frequency.
3. An audio beat note will be heard in the speaker.
4. Adjust the Dial Set knob for zero beat.

TRANSMITTER TUNING

Tuning of the transmitter is not complicated, providing the few simple steps are followed in the correct order. Do not attempt initial tuneup without first performing the procedures for Receive operation described above. The following procedures assume that the unit has been checked out in Receive position, and that the power supply and Frequency Control Unit are adjusted and operating properly.

1. Rotate the Function Switch to TRANSMIT, read the cathode current on the front panel meter.

- (a) Turn the CAR. BAL. control clockwise until a slight increase in meter reading is obtained.
- (b) Rotate the PA GRID control for maximum meter reading.
- (c) Rotate the PA PLATE control for minimum meter reading.
- (d) Adjust car. bal. for a reading of 150 ma.

IMPORTANT - Tuning the PA PLATE for minimum, or "dip," is known as "resonating" the power amplifier plate circuit, and is very important to preserving tube life. If the transceiver is held in Transmit or TUNE position for more than a few seconds while out of resonance and with some grid drive, the 6HF5 tubes may be severely damaged. For this reason we repeat: **CAUTION** - Do not hold the transceiver in Transmit or TUNE position for any length of time without "dipping" the PA PLATE control. The PA GRID must first be "peaked" as in (b), above, and this requires some carrier supplied as described in (a), so it can be seen that these steps must be performed quickly. If the PA LOAD control is too far clockwise, it may

I MODEL 400 TRANSCEIVER

C. Operation (Cont)

not be possible to find a "dip" with the PA PLATE control. For this reason, be sure to observe the first sentence in this section, Step 4.

5. Rotate the REC. TUNE switch to TUNE position. Quickly check the PA PLATE control for "dip" or minimum reading. If the meter dips to less than 500 ma., increase loading by rotating the PA LOAD controls clockwise. After each increase in PA LOAD, resonate the PA PLATE again; that is, adjust it for dip. Continue increasing PA LOAD until the PA PLATE dips to 450-500 ma. Then switch back to RECEIVE.

CAUTION: Do not hold the transceiver in TUNE position for more than 30 seconds at a time, even though PA PLATE is resonated. With full grid drive to the 6HF5 PA tubes, which you have in TUNE position, they are dissipating considerably more power than they do during normal voice transmission, so a short tuning period must be observed.

- A key mic and balance carried out with carrier balance control.*
6. Under some conditions, it may not be possible to load up to 500 ma. This may occur with lower than normal line voltage or tubes not quite up to par, particularly on 10 meters. The current increase when tuning the plate circuit off resonance will provide a clue as to how far the power amplifier can be loaded. If the meter swings up to 600 or 700 ma. on either side of resonance, it will be easy to load up to 500 or even more. But, if the tubes draw just 500 ma. off resonance, you can only load to 400 or 450 ma. This is not necessarily a sign that you have a problem. Peak input power with

voice modulation will still be 400 watts when you load to 400 ma. in TUNE position. A new pair of PA tubes may allow you to load higher, or possibly a new driver tube will help. Primarily, the level to which you can load will serve as an indication of when tubes are deteriorating. If you can load to 500 ma. when the set is new, and after a few months of operating you cannot get above 400 ma., or so, it is probably time to replace the 6HF5 tubes, and possibly the 6GK6 driver. The other tubes should also be checked at that time.

7. AVERAGE PA LOAD SWITCH POSITIONS. The following positions are for a 50 ohm non-inductive load, and indicate approximately where the PA LOAD switch will end if the antenna and coaxial cable are well matched.

BAND	PA LOAD SWITCH
80	POS. 7
40	8
20	9
15	9
10	10

A large deviation from these positions indicates a possible matching problem, although operation may still be quite satisfactory. PA LOAD switch positions below 5 will generally be needed only with very low impedance loads, such as a 75 meter mobile antenna with center loading coil.

7. VOICE TRANSMISSION. After tuning up as outlined above, press the Push-to-Talk button on the mike and carefully set the CAR. BAL. control for minimum meter reading. While speaking into the mike, slowly rotate

I MODEL 400 TRANSCEIVER

C. Operation (Cont)

the MIC. GAIN control until occasional peak reading of 175 to 200 ma. are obtained. With most microphones, the MIC. GAIN control will be set between 9 and 12 o'clock, but it may vary considerably. The ALC circuit will help limit cathode current to about 200 ma., but turning the MIC. GAIN up too high will still produce flat-topping and spurious signals, so it is important to hold it down. The meter is quite heavily damped, and its reading with average voice modulation may not look very impressive, but the voice peaks are going well over the 400 watt power rating of your Swan transceiver, and signal reports will verify this fact.

8. TRANSMITTER TUNING WITH SWR BRIDGE OR FIELD STRENGTH METER. If either of these instruments is available, they are highly recommended as a better method of tuning the PA Amplifier, since they provide a direct indication of relative output. With the SWR Bridge in Forward position, or with the Field Strength Meter set to pick up a portion of the radiated power, simply adjust the PA TUNE and PA LOAD controls for maximum output. This must be done quickly, limited to about 30 seconds, to limit tube dissipation as previously mentioned. This method will result in maximum possible output and efficiency, as well as maximum linearity. You will probably find that cathode current readings end up somewhat less than 500 ma. on 10 meters because grid drive is the least on this band. On 80 meters where grid drive is the greatest, maximum output will be reached at more than 500 ma. These are a normal condition.

NOTE - The cathode current level to which the PA is loaded will have no bearing on tube life. When transmitting with normal voice modulation, average power input will be the same regardless of how high or low the PA was loaded while tuning. Peak output, linearity, and lowest distortion will go along with maximum loading. In other words, you will not extend tube life by loading to a lesser degree. The secret to long tube life is simply to keep TUNE-up periods short and not too frequent.

AM OPERATION

(Single Sideband With Carrier)

1. Tune up transmitter to full output on single sideband on desired frequency band as described above.
2. Rotate MIC GAIN control to full counter-clockwise position.
3. With Function Switch in TRANSMIT, rotate CAR BAL control until cathode current is approximately 150 ma.
4. While talking in a normal tone of voice into the microphone, increase MIC GAIN setting until variation is just discernible on meter. This setting will result in adequate modulation with one sideband.

CW OPERATION

1. Tune transmitter to full output as described above.
2. Insert CW key in the key jack provided on the back of the 400. Use a standard 1/4 inch diameter 2 circuit phone plug.

I MODEL 400 TRANSCEIVER

C. Operation (Cont)

3. Add a .4T or .5MF., 200 volt capacitor across the key. This capacitor may be added internally if desired.
4. Switch the PHONE-CW control over to CW position. Then switch the

Function Switch to TRANS. to transmit, and REC. to receive.

5. Information on a sidetone modification for the 400 is available on request.

D. ALIGNMENT AND TROUBLESHOOTING

GENERAL

The following procedures are given in the order performed during the factory alignment for the transceiver. For home servicing only partial alignment may be necessary. Read all procedures carefully before commencing either partial or complete alignment. See Figures 4 and 5 for component placement.

Equipment Required

1. Calibrated audio frequency signal generator, range 200 to 5000 cps.
2. 500 watt dummy load with output meter.
3. Vacuum tube voltmeter.
4. Walsco 2543 coil adjustment tool.
5. Field strength meter
6. Calibrated RF Signal Generator.

Pre-Alignment Conditions

1. Neutralizing capacitors C413 set to mid-point and C316 set to approximately 3/4 turn from full compression.
2. Peak IF transformers for maximum background noise with AF and RF gain full clockwise (either bottom or top core adjustment).
3. Loosely, couple field strength meter to C317 (off pin 9 of V4) with alligator clip on ceramic capacitor body.

4. Transmit bias potentiometer full counter-clockwise (maximum bias).

VFO AMPLIFIER PLATE CIRCUIT ALIGNMENT

With VTVM from pin 1 of V7, Receiver Mixer, to ground, on -15 volt scale, and using a Model 410 or 406B Frequency Control Unit, adjust VFO Amplifier Plate coils for peak VTVM heading as follows:

Band	VFO Frequency, kc	VFO Dial Reading Frequency (kc)	Coil
80	8,975	3,800	L104
40	12,300	7,125	L103
15	16,050	31,225	L102
10	23,325	28,500	L101

TRANSMITTER MIXER AND DRIVER PLATE CIRCUIT ALIGNMENT

1. Remove screen voltage from V4 and V5 by disconnecting orange wire to terminal strip immediately adjacent to V5 base. (Pt. A in Fig. 5.)
2. Connect VTVM across R412, 4.7K resistor between pins 1 and 2 of terminal strip immediately behind bifilar coil in crystal filter, range -15 volt scale. (Points B and C in Fig. 5).

I MODEL 400 TRANSCEIVER

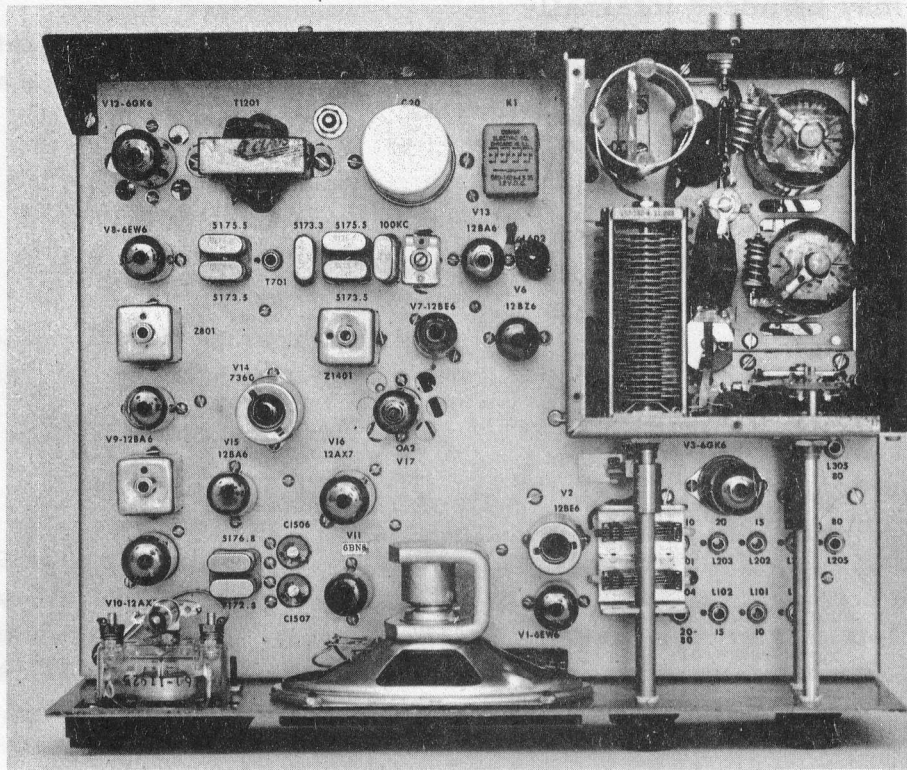

FIGURE 4 TOP VIEW, MODEL 400 TRANSCEIVER.

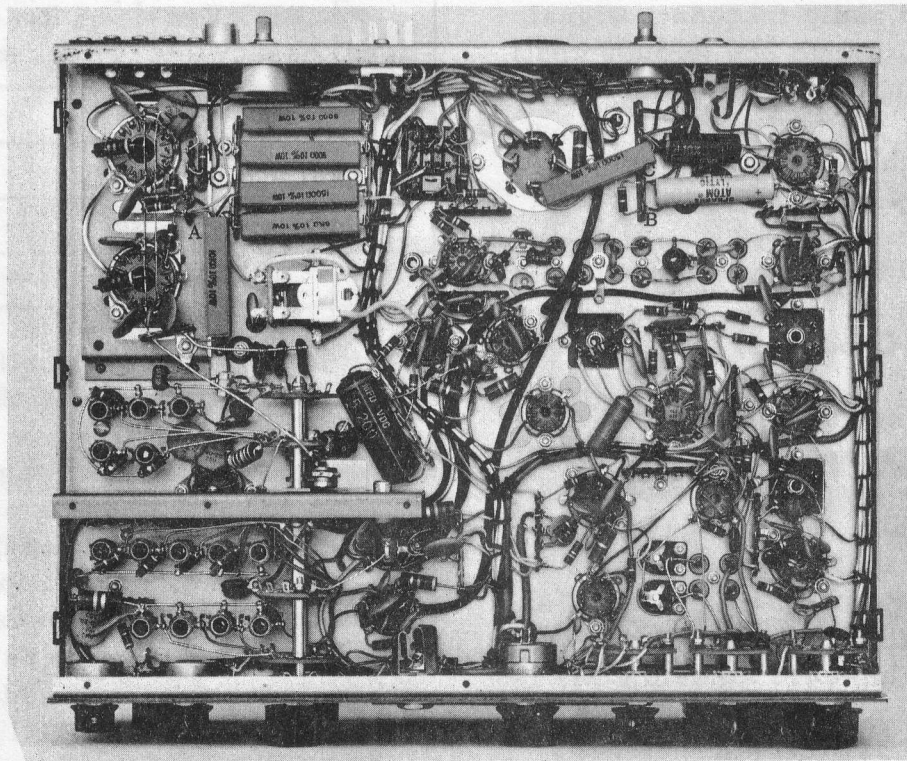

FIGURE 5 BOTTOM VIEW, MODEL 400 TRANSCEIVER

I MODEL 400 TRANSCEIVER

D. Alignment and Troubleshooting (Cont)

3. Set PA grid tuning fully clockwise, phone-cw switch in phone position, sideband selector in USB position.

Procedure:

Adjust bandswitch to band shown and adjust coils for peak VTVM reading as follows:

Function Switch	Band	VFO Freq. (kc)	Adjust
Tune*	80	4,025	L205, L305, C1507, Z1401
Tune	40	7,350	L204, L304
Tune	20	14,500	L203, L303
Tune	15	21,500	L202, L302
Tune	10	29,700	L201, L301

* Note: If VTVM and field strength meter exceed full scale reading, switch to transmit position and insert carrier with carrier balance control to keep reading on scale. Field strength meter and VTVM must both peak at same time since it is possible to tune the coils to the VFO frequency on 10 meters. Care must be taken that the coils be tuned properly.

Following the above procedures, replace orange wire to pin 1 of terminal strip adjacent to V5.

ALIGNMENT OF 5175 KC FILTER TRAP

With RF and AF gain at midscale, feed 5175 kc signal to antenna connector and adjust L602 until heterodyne disappears or S-meter reads zero.

ADJUSTMENT OF CARRIER FREQUENCY

- A. With dummy load and output meter attached, tune transceiver for maximum output.
- B. Null out carrier with PTT pressed and set resting plate current to 50 ma with bias pot.
- C. Connect AF generator to MIC JACK, adjust MIC. GAIN full CCW.

Procedure:

1. With AF generator at 1500 cps, increase MIC. GAIN to produce a 100 ma. reading on the meter.
2. Adjust Z801 for maximum meter reading.
3. Adjust both top and bottom cores of Z1401 for maximum meter reading.
4. Adjust MIC. GAIN for meter reading of 300 ma.
5. Set AF generator to 300 cps. Adjust C1507 for meter reading of 75 ma.
6. Repeat steps 1 through 5 for USB operation, adjusting C1506.

PA NEUTRALIZATION

With P. A. coarse load in position 1, set freq. to 14.150, PA Plate control at 9 o'clock, insert carrier and peak P. A. Grid control, adjusting Car. Bal. control for 200 MA. Turn PA control slowly through resonance. Cathode current should dip smoothly and rise to 200 MA on the low capacity side of resonance. If, instead, there is a peak above 200 MA either side of the dip, stop rotation of the PA plate control at

I MODEL 400 TRANSCEIVER

D. Alignment and Troubleshooting (Cont)

the peak and adjust C 413 to reduce Ip to 200 MA. Repeat above check and readjust as necessary to obtain the desired smooth dip. For 10 meters, use above procedure but adjust #C 315.

ADJUSTMENT OF L601

With transceiver tuned to 28.8 mc, and RF and AF gain at maximum, adjust L601 for maximum background noise.

CRYSTAL CALIBRATOR ADJUST

With transceiver tuned to 15.0 mc WWV adjust C1304 for zero beat with WWV.

S-METER ADJUSTMENT

With antenna disconnected and with RF gain fully clockwise, set R606, located on rear panel to read zero. Make sure no local signals are being received.

TUBE TYPE		VOLTAGE CHART											
		PIN NO.											
		1	2	3	4	5	6	7	8	9	10	11	12
V1 6EW6	R	0	.75	6.3	0	130	130	0					
	T	0	.75	6.3	0	125	125	0					
V2 12BE6	R	-90	0	12.6	0	245	240	-90					
	T	-2.0	0	12.6	0	245	100	0					
V3 6GK6	R	0	-30	0	6.3	0	0	255	255	0			
	T	0	-6.0	0	6.3	0	0	250	250	0			
V4 6HF5	R	6.3	-	-	0	-75	0	-	0	-75	0	-	0
	T	6.3	-	-	.12	-75	215	-	215	-75	.12	-	0
V5 6HF5	R	12.6	-	-	0	-75	0	-	0	-75	0	-	6.3
	T	12.6	-	-	.12	-75	215	-	215	-75	.12	-	6.3
V6 12BZ6	R	0	2.8	0	6.3	230	140	0					
	T	-85	0	0	6.3	230	0	0					
V7 12BE6	R	-3.0	0	12.6	0	235	75	0					
	T	-3.0	0	12.6	0	210	0	-75					
V8 6EW6	R	0	2.6	12.6	6.3	230	130	0					
	T	0.2	0.5	12.6	6.3	205	120	0					
V9 12BA6	R	0	0	12.6	0	230	105	3.2					
	T	75	0	12.6	0	220	0	0					
V10 12AX7	R	155	-0.6	0	12.6	0	160	0	1.5	6.3			
	T	190	-75	0	12.6	0	155	0	1.5	6.3			
V11 6BN8	R	0.2	22	0.2	12.6	6.3	0	200	6	70			
	T	0	21	0	12.6	6.3	-70	100	3	40			
V12 6GK6	R	0	-8	-	12.6	6.3	-	240	230	0			
	T	0	-21	-	12.6	6.3	-	250	220	0			
V13 12BA6 C A L	R	-1.0	0	12.6	0	180	100	0					
	T	0	245	-90	6.3	0	225	225	25	25			
V14 7360	R	0	85	0	6.3	0	135	135	23	23			
	T	0	85	0	6.3	0	135	135	23	23			
V15 12BA6	R	-7	0	0	12.6	60	100	0					
	T	-7	0	0	12.6	60	100	0					
V16 12AX7	R	95	0	0.8	6.3	6.3	70	0.2	0	0			
	T	50	0	0.3	6.3	6.3	50	0.2	0	0			
V17 6A2	R	150	-	-	-	150	0	0					
	T	150	-	-	-	150	0	0					

TROUBLESHOOTING GUIDE	
DEFECT	POSSIBLE CAUSE
PA IDLING CURRENT UNSTABLE	<ol style="list-style-type: none"> 1. Defective 6HF5 2. Defective Bias Potentiometer 3. Defective Bias Supply
INABILITY TO LOAD TO 400-500 MA (SEE PAGE 10)	<ol style="list-style-type: none"> 1. PA Grid Improperly Tuned 2. Bandswitch Improperly Set 3. Antenna Not Resonant at Frequency 4. Defective Transmission Line 5. Defective Mobile Antenna Coil 6. V2, V3, V4, V5 Defective 7. R407 or R408 Defective
INSUFFICIENT CARRIER SUPPRESSION	<ol style="list-style-type: none"> 1. Carrier Balance Control Improperly Adjusted. 2. Defective 7360 Balanced Modulator 3. Carrier Oscillator Frequency Incorrect.
INSUFFICIENT SIDERAND SUPPRESSION	<ol style="list-style-type: none"> 1. Excessive MIC. Gain 2. Incorrect PA Load Adjustment 3. Carrier Oscillator Frequency Incorrect
MICROPHONICS IN TRANSMITTER	<ol style="list-style-type: none"> 1. Excessive Mic. Gain 2. V16, V14, V15 Defective
MICROPHONICS IN RECEIVER	<ol style="list-style-type: none"> 1. Z901 Improperly Tuned 2. V15, V10, V9, V8, V7, or V6 Defective
LOW RECEIVER SENSITIVITY	<ol style="list-style-type: none"> 1. PA Grid, Plate, or Load Improperly Set 2. Bandswitch Improperly Set 3. K2 Back Contacts Defective 4. V6, V7, V8, V9, V10, V11, V12 Defective.

I MODEL 400 TRANSCEIVER

E. PARTS LIST

CAPACITORS

C101	.002, 20%, 1KV Disc	C411	.002, 20% 3 KV Disc
C102	.01, +80-20%, 500V Disc	C412	.002, 20% 3 KV Disc
C103	.01, 20%, 1KV Disc	C413	20 pf P.A. Neut. Trimmer
C104	.002 +80-20% 500V Disc	C414	15 20% 3 KV Disc
C105	.01, +80-20% 500V Disc	C415	270, 5% 2500V Mica
C106	50, 5% 500V Mica	C416	270, 5% 2500V Mica
C201	.01, +80-20% 500V Disc	C417	200 pf PA Tune
C202	40-30-10-20 Mfd. 450-450-450-25 WV Elect.	C418	50 10% 6 KV Disc
C203	.002, 20% 1 KV Disc	C419	Two 50 10% 6 KV Discs
C204	1000, 5% 500V Mica	C420	410 pf P.A. Fine Load
C205	15, 5% 500V Mica	C421	Two 150, 10% 1 KV NPO Discs
C206	24, 5% 500V Mica	C422	Two 150, 10% 1 KV NPO Discs
C207	120, 5% 500V Mica	C423	330 10% 500V Mica
C208	130, 5% 500V Mica	C424	330, 10% 500V Mica
C209	10, 5% 500V Mica	C425	330, 10% 500V Mica
C210	12, 5% 500V Mica	C426	330, 10% 500V Mica
C211	15, 5% 500V Mica	C427	330, 10% 500V Mica
C212	50, 5% 500V Mica	C428	330, 10% 500V Mica
C213	2 pf 10% 500V Ceramic	C429	330, 10% 500V Mica
C303	.01 +80-20% 500V Disc	C430	.01 +80-20% 500V Disc
C304	.01 +80-20% 500V Disc	C431	.5 10% 200V Mylar
C305	100 5% 500V Mica	C601	.01 +80-20% 500V Disc.
C306	100 5% 500V Mica	C602	.01, +80-20% 500V Disc.
C307	68, 5% 500V Mica	C603	.01, +80-20% 500V Disc.
C308	15, 5% 500V Mica	C604	10, 5% 500V Mica
C309	20, 5% 500V Mica	C605	5pf, 10%, NPO
C310	68, 5% 500V Mica	C606	100, 5%, MICA
C311	470, 5% 500V Mica	C701	30, 10% 1 KV Disc
C312	510, 5% 500V Mica	C702	30, 10% 1 KV Disc
C312A	30, 5% 500V Mica	C703	.01 +80-20% 500V Disc
C313	680, 5% 500V Mica	C704	220 5% 500V Mica
C314	50, 5% 500V Mica	C705	430 5% 500V Mica
C315	91, 5% 500V Mica	C706	5 10% NPO Disc.
C316	1.5/20 pf Mica Trimmer	C707	5, 10% NPO Disc.
C317	.002, 20% 1 KV Disc	C709	.01, +80-20% 500V Disc
C402	.002, 20% 1 KV Disc	C801	.01, +80-20% 500V Disc
C403	.01 +80-20% 500V Disc	C802	.01, +80-20% 500V Disc
C404	.01, +80-20% 500V Disc	C803	.01, +80-20% 500V Disc
C405	.01, +80-20% 500V Disc	C804	10, 10% 1 KV Disc
C406	10 mf 150WV Electrolytic	C805	.002 20% 1 KV Disc
C407	.01, +80-20% 500V Disc	C901	.01 +80-20% 500V Disc.
C408	.01 mf +80-20% 500V Disc	C902	.01 +80-20% 500V Disc
C409	.01 mf +80-20% 500V Disc	C903	.01, +80-20% 500V Disc
C410	.002, 20% 1 KV Disc	C904	.01, +80-20% 500V Disc
		C1001	1 pf 10% Ceramic
		C1002	.01, +80-20% 500V Disc
		C1003	220, 20% 1 KV Disc

I MODEL 400 TRANSCEIVER

E. Parts List (Cont)

CAPACITORS (Cont)

C1004 .002, 20% 1 KV Disc
 C1005 .002, 20% 1 KV Disc
 C1006 .002, 20% 1 KV Disc
 C1101 .001, 20% 1 KV Disc
 C1102 .01, +80-20% 500V Disc
 C1103 .5 mf 10% 200V Mylar
 C1201 .002 20% 1 KV Disc
 C1202 220, 20% 1 KV Disc
 C1203 .005, 10% 1600V Mylar
 C1301 .01, +80-20% 500V Disc
 C1302 150, 10% 500V Mica
 C1303 5-80 pf Mica Trimmer
 C1401 .01 +80-20% 500V Disc.
 C1402 220 20% 1 KV Disc
 C1403 .01, +80-20% 500V Disc
 C1404 .002, 20% 1 KV Disc
 C1405 .01, +80-20% 500V Disc
 C1501 20, 5% 500V Mica
 C1502 5, 10% NPO Disc
 C1503 50, 5% 500V Mica
 C1504 30, 5% 500V Mica
 C1505 50, 5% 500V Mica
 C1506 6-30 pf Ceramic Trimmer
 C1507 6-30 pf Ceramic Trimmer
 C1508 .01 +80-20% 500V Disc.
 C1601 .01, +80-20% 500V Disc.
 C1602 .01, +80-20% 500V Disc.
 C1603 220, 20% 1 KV Disc.
 C1604 100, 20% 1 KV Disc.
 C1605 .01, +80-20% 500V Disc
 C1A-B 85 pf per section

RESISTORS

R101 75 ohms
 R102 56 ohms
 R103 47K - 1 watt
 R104 12K - 2 watt
 R201 27K
 R203 18K - 2 watt
 R204 4.7K - 1 watt
 R205 6.8 K
 R206 4.7 K
 R207 4.7 K
 R301 100 K
 R302 270 K

R304 100
 R305 10K
 R306 8.2K
 R307 10K
 R402 1K
 R403 100
 R404 100
 R404A* Selected
 R405 2K - 5% - 1/2W
 R406 10K - 10 watt
 R407 4.7 - 5% - 1 w
 R408 4.7 - 5% - 1 w
 R410 10K Bias Pot.
 R411 10K - 1 w
 R412 4.7K
 R413 2.2 Meg.
 R601 1 Meg.
 R602 56
 R603 47K - 1 w
 R605 1K
 R606 1K - S-Meter Pot.
 R607 270
 R608 470K
 R609 150K
 R701 27K
 R703 1K
 R704 22K - 1 w
 R801 470
 R802 56
 R803 47K
 R804 1K
 R805 100K
 R901 47K
 R902 100
 R903 47K
 R904 1K
 R905 100K
 R1001 1 Meg.
 R1002 100K
 R1003 270K
 R1004 270K
 R1005 2.7K
 R1006 100K
 R1101 470K
 R1102 1K
 R1103 47K
 R1104 27K
 R1105 270K

I MODEL 400 TRANSCEIVER

E. Parts List (Cont)

RESISTORS (Cont)

R1106	120 - 2 w
R1201	1 Meg. A. F. Gain Pot.
R1202	1 Meg.
R1203	270K
R1301	27K
R1302	100K
R1303	1 Meg.
R1401	47K
R1402	47K
R1403	150K
R1404	4.7K
R1405	5K Car. Bal. Pot.
R1406	47K
R1407	47K
R1408	100K
R1409	100K
R1410	27K
R1501	1 Meg.
R1502	27K
R1503	27K
R1504	1K
R1601	150K
R1602	1K
R1603	1 Meg. Mic. Gain Pot.
R1604	270K
R1605	2.2 Meg.
R1606	47K
R1701	800 - 10 w
R1702	900 - 10 w
R1703	27K
R1704	27K
R1705	1.5K - 10 w
R1706	6K - 10 w
R1707	1.5K 10 w
R1708	47K

COILS

L101	23 mc - 2 uh
L102	16 mc - 4 uh
L103	12 mc - 7 uh
L104	9 mc - 4 uh
L201	28 mc - 2 uh
L202	21 mc - 2 uh
L203	14 mc - 3.2 uh
L204	7 mc - 3.6 uh

L205	4 mc - 11 uh
L206	RFC - 200 uh
L301	28 mc - 2 uh
L302	21 mc - 2 uh
L303	14 mc - 3.2 uh
L304	7 mc - 3.6 uh
L305	4 mc - 11 uh
L306	RFC - 200 uh
L401	14 mc - 0.8 uh
L402	4 mc - 6 uh
L403	RFC - mh
L404	RFC - 200 uh
L405	RFC - 17 h
L406	RFC - 55 uh
L601	28 mc - 1.2 uh
L602	5175 kc - 90 uh
L603	13 mc, 30 uh
L604	13 mc, 1.5 uh
L701	RFC - 200 uh
L1001	RFC - 200 uh

TRANSFORMERS

Z301	Parasitic Suppressor
Z401	Parasitic Suppressor
Z501	Parasitic Suppressor
Z801	5175 kc I. F. Trans.
Z901	5175 kc I. F. Trans.
Z1401	5175 kc Bal. Mod. Trans.
T701	Bifilar Filter Coil
T1201	A. F. Output Trans.

SWITCHES

S-1	A-B-C-D-E-F Bandswitch
S-2	P. A. Coarse Load
S-4	Phone-Cw Selector
S-5	Function Switch
S-6	Sideband Selector
S-1201	Power On-Off Ganged with R1201 A. F. Gain Pot.

DIODES

D401	TS-2 ALC Diode
D402	TS-2 ALC Diode
D601	TS-2 S-Meter Diode
D1701	1N 2974RB Zener

I MODEL 400 TRANSCEIVER

E. Parts List (Cont)

RELAYS

K1 4PDT Relay, 12 VDC Coil
K2 2PDT Relay, 12 VDC Coil

CRYSTALS

Y701 5175.5 KC Series Res.
Y702 5175.5 KC Series Res.
Y703 5173.5 KC Series Res.
Y704 5173.5 KC Series Res.
Y705 5173.3 KC Series Res.
Y1301 100 KC Calib. Osc.
Y1501 5176.8 KC Car. Osc.
Y1502 5172.8 KC Car. Osc.

TUBES

V1 6EW6 VFO Amplifier
V2 12BE6 Trans. Mixer
V3 6GK6 P.A. Driver

V4 6HF5 Power Amplifier
V5 6HF5 Power Amplifier
V6 12BZ6 Rec. R.F. Amp.
V7 12BE6 Rec. Mixer
V8 6EW6 1st I.F. Amp.
V9 12BA6 2nd I.F. Amp.
V10 12AX7 Prod. Det/Rec. A. F.
V11 6BN8 AGC Amp./Rect.
V12 6GK6 A. F. Output Amp.
V13 12BA6 Crystal Calibrator
V14 7360 Bal. Mod.
V15 12BA6 Carrier Oscillator
V16 12AX7 Mic. Amplifier
V17 OA2 Voltage Regulator

ADDITIONS

C432 .01 500 V Disc.
C317 15, 500 V Disc
C1104 .001, 500V Disc
R414 4.7K Composition

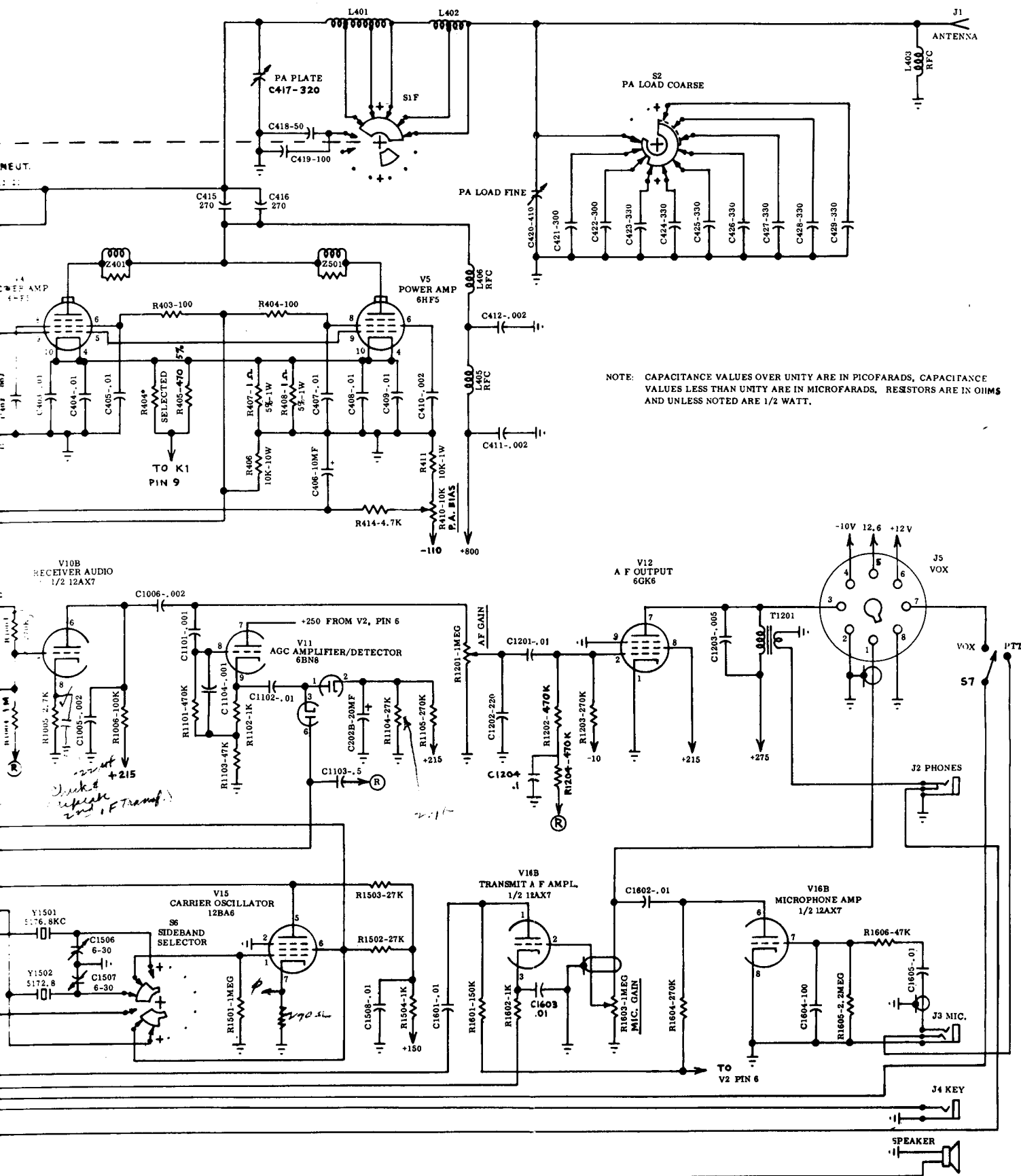

SCHMATIC DIAGRAM--SWAN MODEL 400 SINGLE SIDEBAND TRANSCEIVER