

In reality soldering chip components is no very difficult. Chip capacitors, resistors, inductors, and zener diodes have metalized parts on both ends. Solder the metalized ends to the pads. So far as SMD IC's and transistors are concerned, they have shorter leads. Solder the leads to the pads.

Take mounting the chip capacitor for example. First, place a little solder to one of the pads to mount the chip capacitor. Then place the capacitor on the pads with use a pair of tweezers. Do not use too much force to hold the capacitor. Too much force would damage the component. Use the tip of the solder iron to heat the pad which has been tinned with solder until the solder melts. Pull away the solder iron. Now, the capacitor has been fixed. However, the capacitor might not be flat on the pads. Use a tooth pick to press the capacitor lightly, and apply solder iron again until the capacitor is flat on the pads. Now, solder the other pad.

Alternatively, you could use the flux to stick the capacitor in position first, and then, solder the pads one by one.

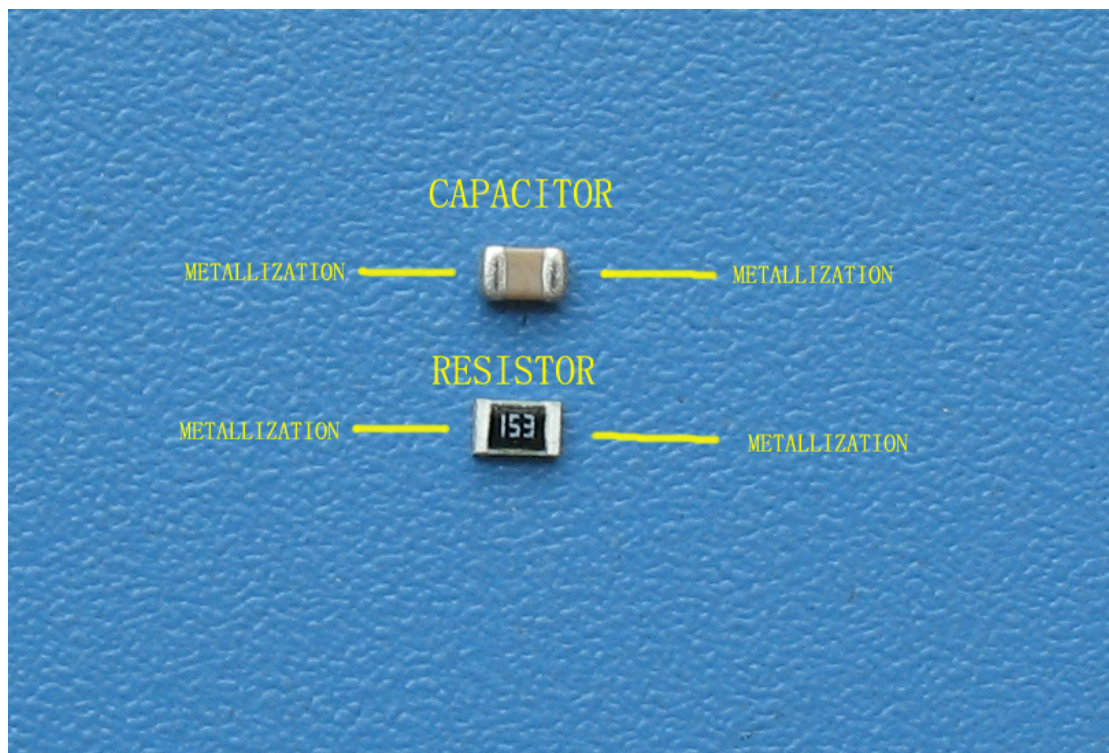

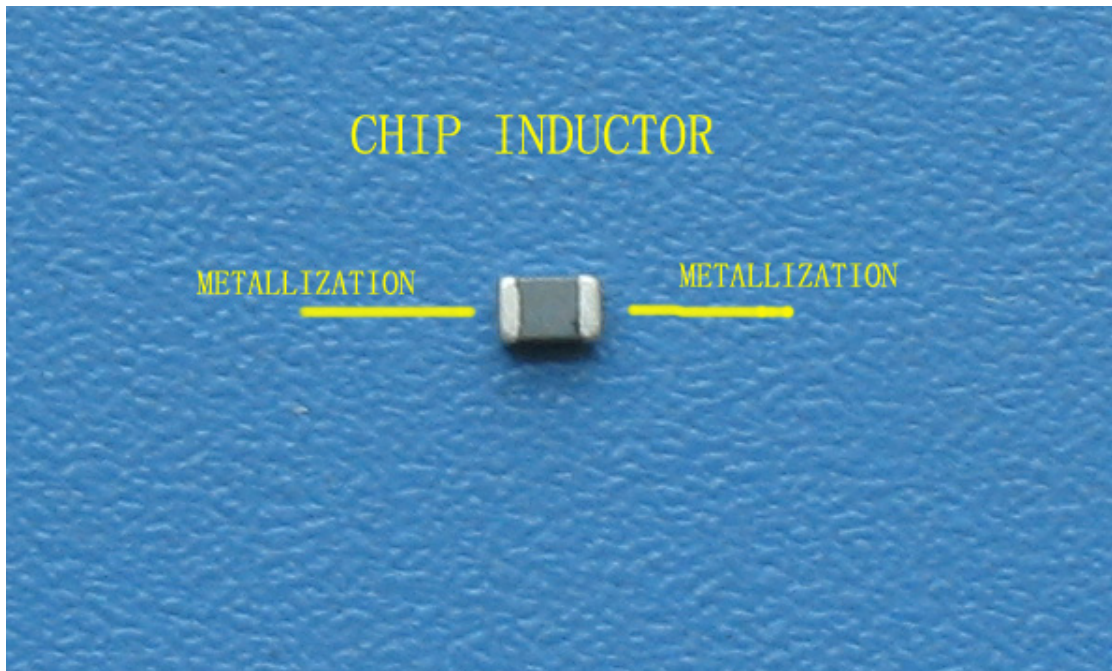
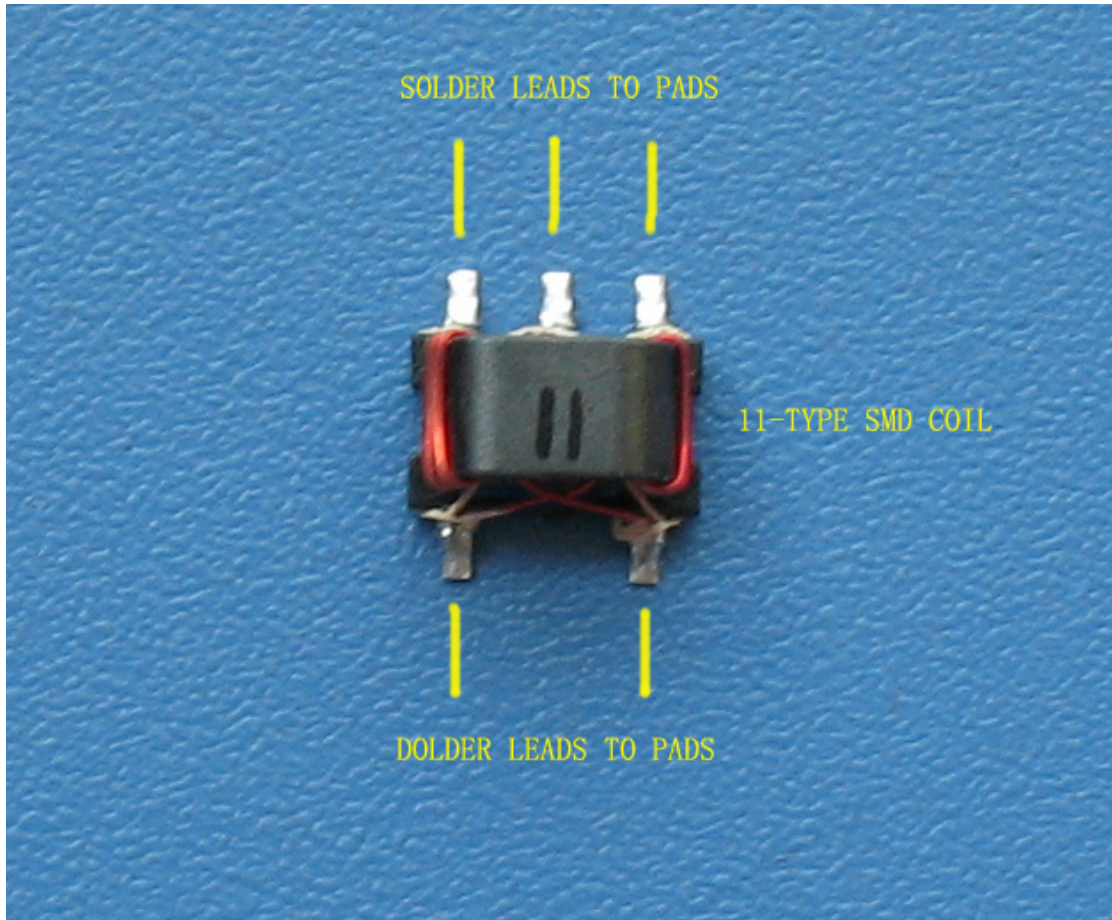

## CHIP ALUMINUM CAP

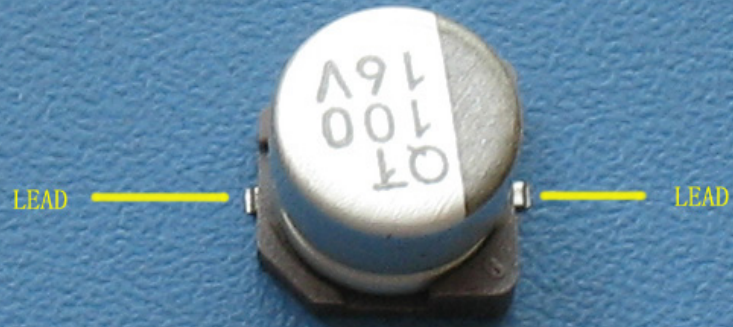

SOLDER LEADS TO PADS

## ZENER DIODE

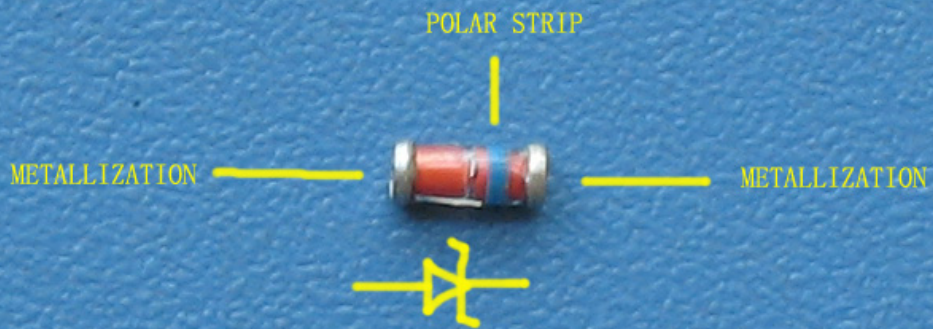

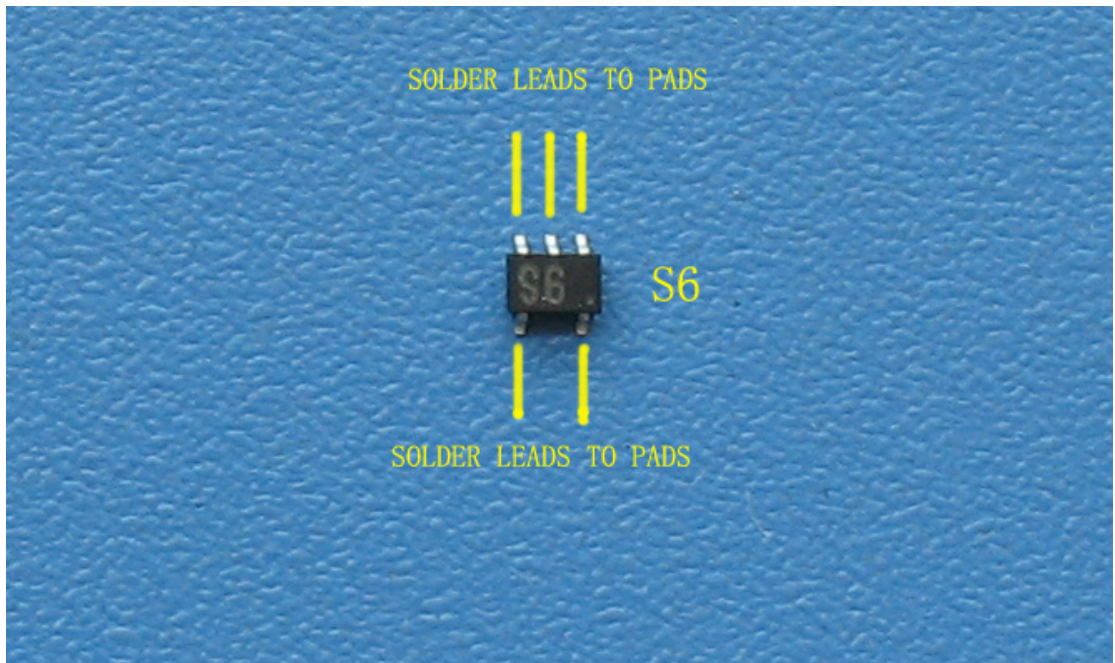
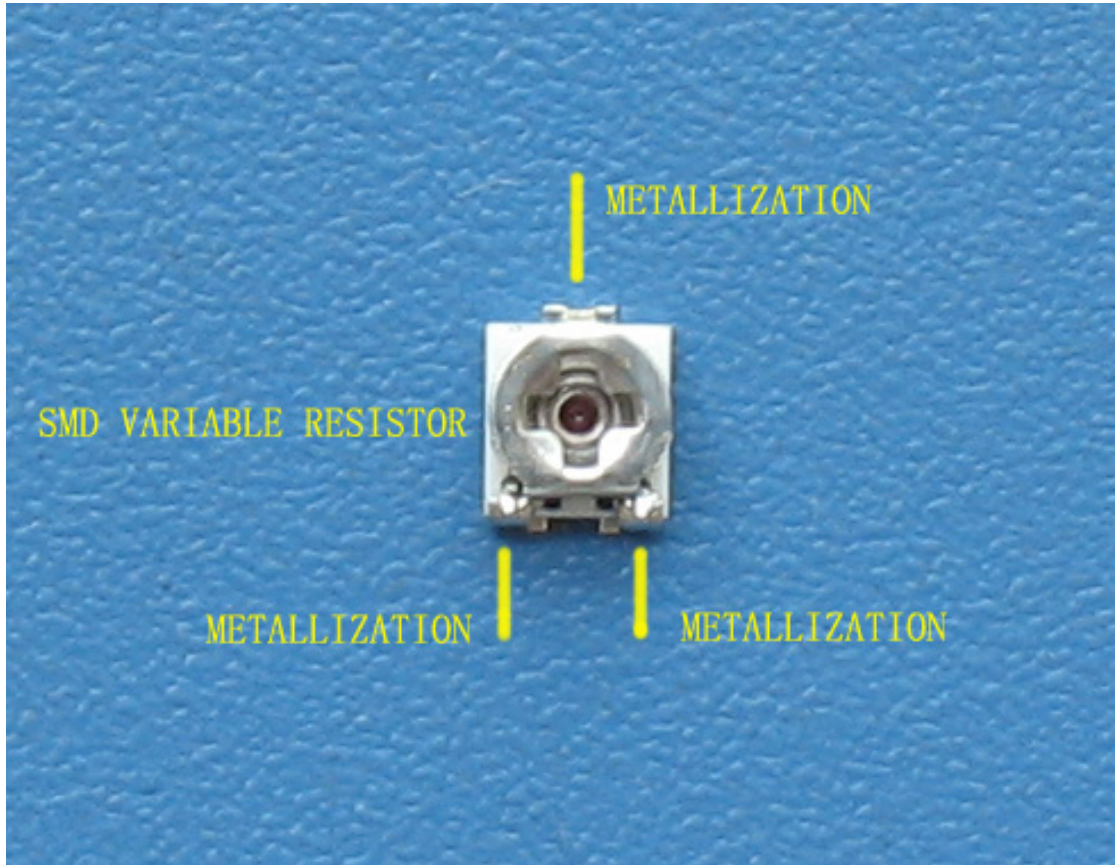

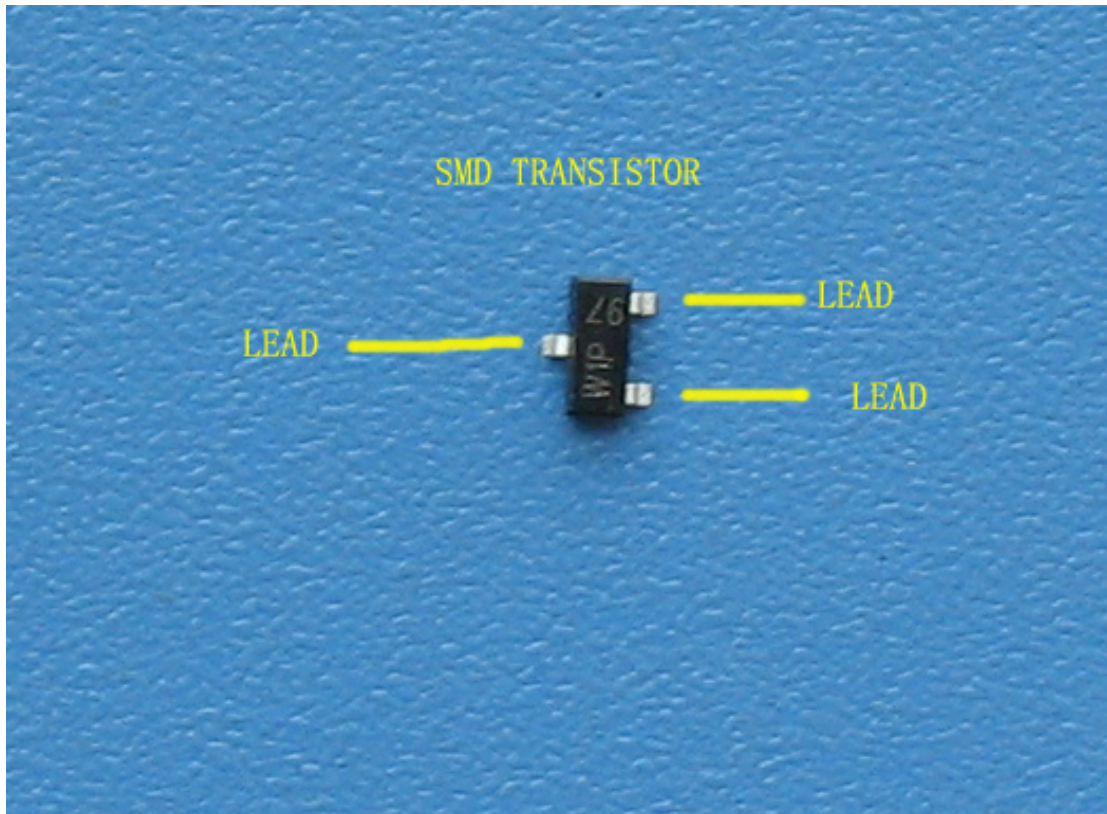

The following instruction is taken from *ARRL HANDBOOK* (1987: 32-15):

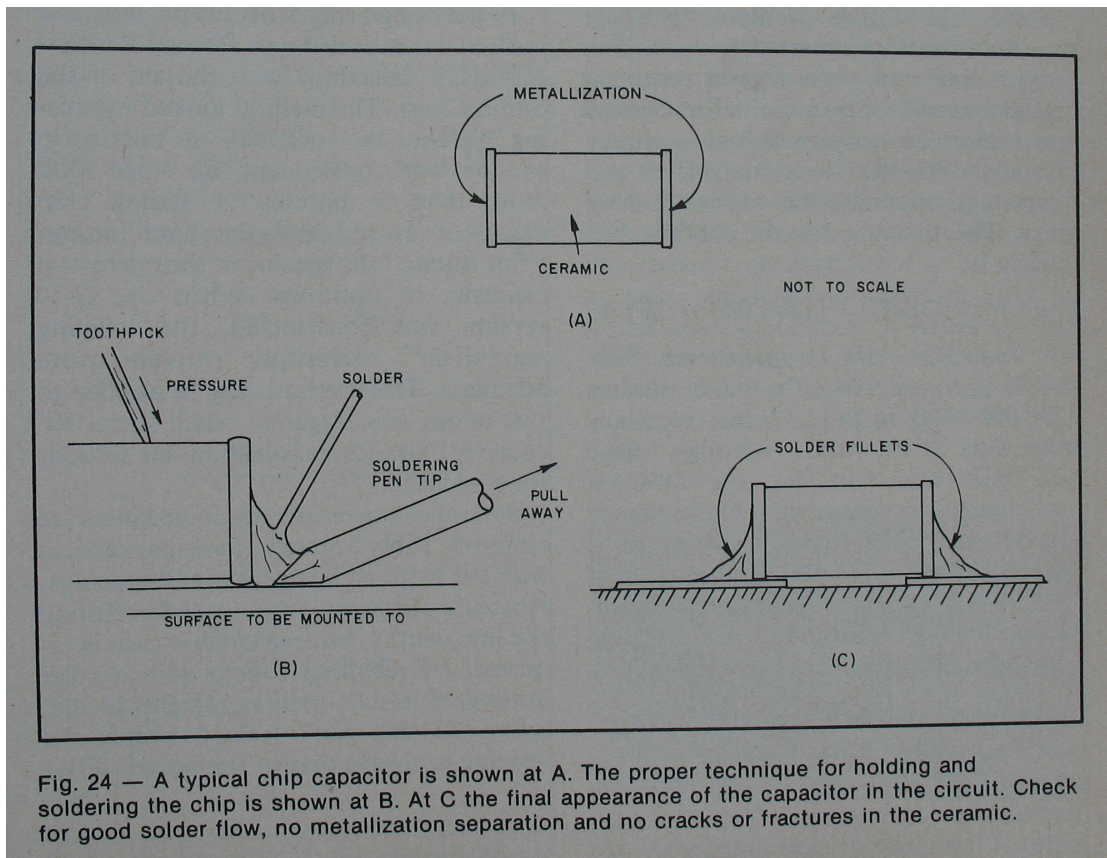

Fig. 24 — A typical chip capacitor is shown at A. The proper technique for holding and soldering the chip is shown at B. At C the final appearance of the capacitor in the circuit. Check for good solder flow, no metallization separation and no cracks or fractures in the ceramic.

Special care must be exercised in soldering the chip capacitors. Fig. 24 illustrates a good technique. All surfaces should be clean and lightly tinned before you attempt to solder the chip. Position the chip in place and hold it with a toothpick. Do not use a screwdriver or tweezers, since the metal can easily damage the ceramic base of the capacitor. Lay the chisel side

of the tip of a 15- to 20-watt soldering pen on the surface to which the capacitor is to be soldered, with the tip of the chisel just touching the chip capacitor.

Touch and flow a minimum amount of solder between the chip and the soldering pen tip and pull the tip away at a low angle to the surface. Repeat the procedure on the other side of the chip. If you don't dump too much heat into the chip while soldering the second end, you may not have to hold it in place. Fig. 24C illustrates how the connection should look when done. Inspect the solder and the chip capacitor with a magnifier for good solder flow and lack of fractures and cracks. Don't overheat the chip or the metallization may separate from the ceramic and you'll have to discard the capacitor. Several attempts may be necessary, but the technique can be mastered after a few tries.