



WMS 40

Service Manual

*

11/07

Last modifications:
Parts canceled, no longer available
New part number pos. 15 page 6
Correction of part number's page 6
New part number pos.17 page 12
Part number for XL1, page 20
Designation of KR3 crystal corrected from 19115330 to 19115530
Page 22 connector: remark added
HT40: parts added
Page 20: CF1,3 part number corrected from 17001073 to 17201073

The complete WMS 40 system:

The actual frequency is not differentiated by item number!

WMS 40 HT/US – Set with US power supply: 7611X0001

WMS 40 HT/EU – Set with EU power supply: 7612X0001

WMS 40 HT/UK – Set with UK power supply: 7613X0001

WMS 40 PT/US – Set with US power supply: 7611X0002

WMS 40 PT/EU – Set with US power supply: 7612X0002

WMS 40 PT/UK – Set with US power supply: 7613X0002

WMS 40 PT/US/Aerobic – Set with C444 and US power supply: 7611X0003

WMS 40 PT/EU/Aerobic – Set with C444 and EU power supply: 7612X0003

HT 40, handheld transmitter only: 7600X0001

PT 40, bodypack transmitter only: 7600X0002

SR40/US, receiver only with US power supply: 7601X0003

SR40/EU, receiver only with EU power supply: 7602X0003

SR40/UK, receiver only with UK power supply: 7603X0003

General remarks

This manual contains technical information on the system functions and design. Exploded views and lists of all available mechanic parts and electronic assemblies are added. Further a list of electronic components for one specific frequency for both handheld and bodypack transmitters and receiver is added for better technical understanding and trouble shooting. However we do not stock or sell electronic components contained in those electronic components lists. When ordering frequency depending boards please state part number **plus** required frequency.

All measurement values are nominal if not otherwise specified. All data subject to change without prior notice . All rights reserved. The contents of this manual shall be used for service purposes only. Any use of the information given herewith by third parties without permission of the copyright owner is strictly forbidden!

© 2000 by AKG Acoustics GmbH, A Harman International Company,
A-1230 Wien, Austria.

Contacts:

e-mail: service@akg.com

All rights reserved. This document may not be duplicated or passed on to any third person without our consent, nor misused in any other way

Für diese Unterlage behalten wir uns alle Rechte vor. Ohne unsere Zustimmung darf sie weder vervielfältigt, Dritten zugänglich gemacht, oder anders mißbräuchlich verwendet werden.

Short description Transmitter HT40:

Audio part:

The dynamic unit (D880) is connected via L1-L2-C6-C7 (RF-filter), to the MICAMP stage. The MICAMP is built as an amplifier, which is a part of the NE575- integrated circuit and has a gain of 8.8dB. It also forms the LOCUT filter at 30 Hz. Then the signal is fed to the COMPressor.

Here the dynamic of the amplitude is reduced to its half value, expressed in dB. This compressor is built with the integrated circuit NE575 from Signetics. In the feedback loop of the amplifier (Pin 12 and 14) there is the variable gain cell inserted. The variable gain cell is controlled by the rectified output voltage of the amplifier. C60 smoothes the rectified signal and controls the variable gain cell. C60 defines the so called time constant of the compressor. This feedback loop leads in an compression of the input signal. R7-R8-C10 build the DC path in the feedback loop.

The second amplifier is used to build the PREEMphasis circuit, which boosts the higher frequencies with an time constant of 50usec and a fixed gain of 7.9dB at the lower frequencies.

The DEVIation ADjustment is realized with the potentiometer R16. Here at an input level of 100mV/1kHz the deviation is adjusted to 15kHz, which is the nominal modulation. Also at MUTE-position of the main switch, the signal is here shorted.

Q2 with the additional parts form the HICUT filter at app. 25 kHz/3rd order.

Via C29-R28-C30-R30 the signal modulates the CCO.

RF part:

The UHF Signal is generated by a crystal controlled oscillator CCO and multiplier amplifier stages (AMP1, AMP2, AMP3, AMP4).

The third harmonic of the CCO is filtered by BPF1, after 3 doubler stages Ftransmit/2 is filtered by BPF2. After the output amplifier AMP5 the signal is filtered by LPF and a ceramic filter BPF3.

SETCode	Transmitter Frequency	Crystall Frequency	Color
US54	710,400MHz	14,800MHz	reddish brown
US58	734,600MHz	15,304MHz	purple
EU62	802,525MHz	16,719MHz	warm red
EU63	812,800MHz	16,933MHz	yellow
UK69A	854,900MHz	17,810MHz	violet
UK69B	858,200MHz	17,879MHz	green
ISM1	863,100MHz	17,981MHz	melon yellow
ISM2	864,375MHz	18,008MHz	cool gray
SP1	848,750 MHz	17,6822 MHz	skyblue
SP2	851,750 MHz	17,7447 MHz	yellow green
KR3	745,650 MHz	15,5344 MHz	mintgreen
KR4	750,900 MHz	15,6438 MHz	dark grey

Power supply:

The internal voltage of 3.9V is generated from 2 AA size batteries with a DC/DC converter.

All rights reserved. This document may not be duplicated or passed on to any third person without our consent, nor misused in any other way

Für diese Unterlage behalten wir uns alle Rechte vor. Ohne unsere Zustimmung darf sie weder vervielfältigt, Dritten zugänglich gemacht, oder anders mißbräuchlich verwendet werden.

HT40-block schematics

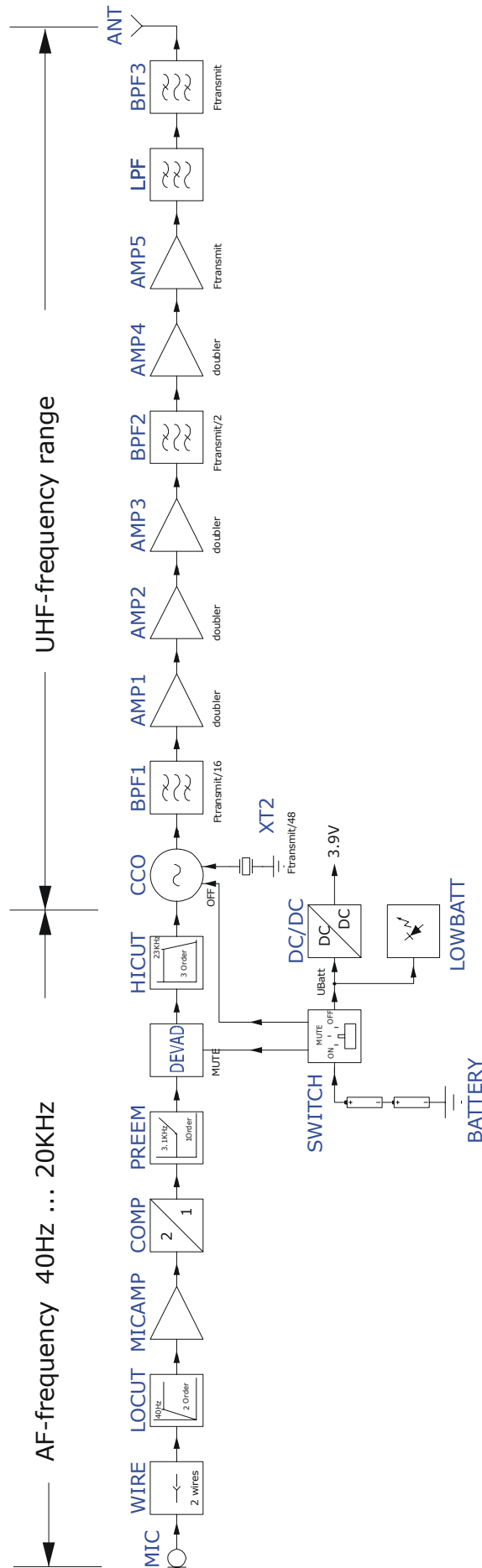

All rights reserved. This document may not be duplicated or passed on to any third person without our consent, nor misused in any other way

Attention: Before reassembly twist stranded wires leading to capsule in counter-direction to the way of screwing in the threaded sleeve. Otherwise the wires will break.

Achtung: Vor dem Zusammenbau die Litzen zur Kapsel im Gegensinn zur Schraubrichtung der Gewindehülse verdrillen, da sonst die Anschlüsse abreißen!

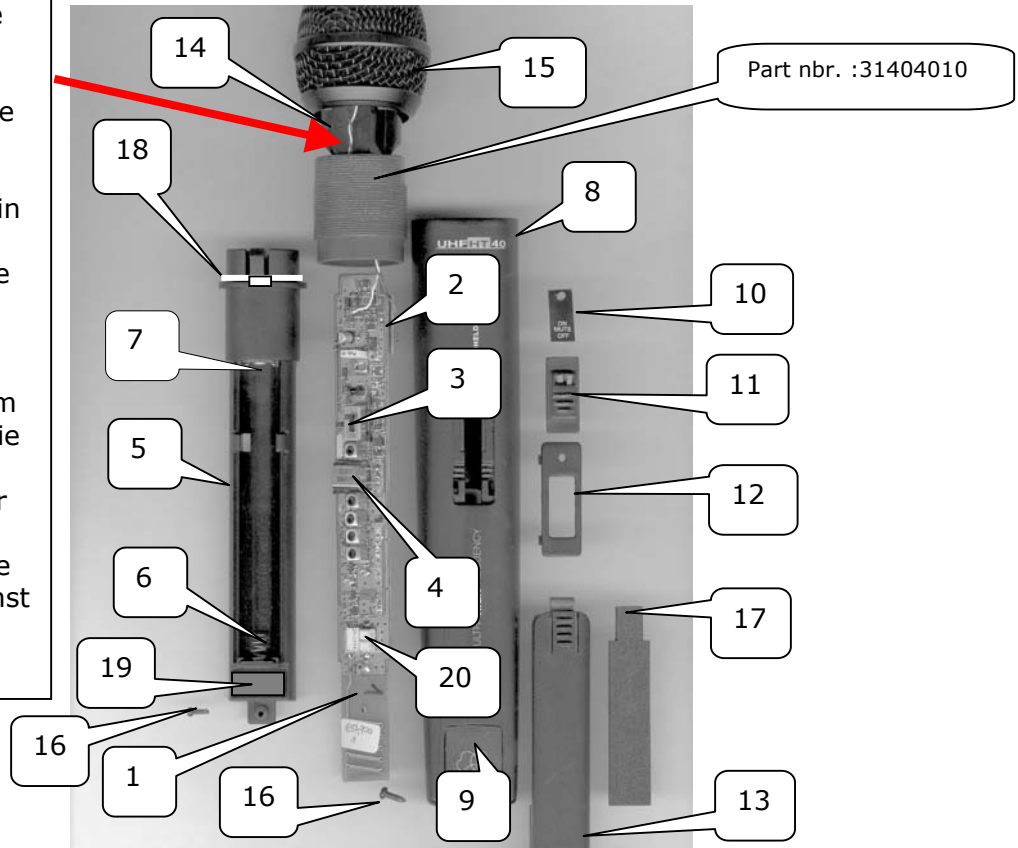

Für diese Unterlage behalten wir uns alle Rechte vor. Ohne unsere Zustimmung darf sie weder vervielfältigt, Dritten zugänglich gemacht, oder anders mißbräuchlich verwendet werden.

All rights reserved. This document may not be duplicated or passed on to any third person without our consent, nor misused in any other way

Description	Part number	Item
Printed circuit main board, complete, tested	80004012	1
Printed circuit dc/dc board, complete, tested	80004013	2
ON/MUTE/OFF switch	92100400	3
Crystal 14.8003MHz (For US54, 710.400MHz) reddish brown	19114801	4
Crystal 14.8128MHz (For US54B, 711.000MHz) skyblue	19114811	4
Crystal 15.3045MHz (For US58, 734.600MHz) purple	19115301	4
Crystal 15.354MHz (For US58B, 736.975MHz) yellowgreen	19115350	4
Crystal 15.602 MHz (For US60A, 748.875MHz) green	19115600	4
Crystal 15.6576MHz (For US60B, 751.550MHz) dark purple	19115650	4
Crystal 16.7196MHz (For EU62, 802.525MHz) warm red	19116710	4
Crystal 16.7732MHz (For EU62B, 805.100MHz) pink	19116772	4
Crystal 16.9336MHz (For EU63, 812.800MHz) yellow	19116930	4
Crystal 16.9399MHz (For EU63B, 813.100MHz) light red	19116931	4
Crystal 17.8107MHz (For UK69A, 854.900MHz) violetblue	19117810	4
Crystal 17.8795MHz (For UK69B, 858.200MHz) green	19117871	4
Crystal 17.9815MHz (For ISM1, 863.100MHz) melon yellow	19117980	4
Crystal 18.0081MHz (For ISM2, 864.375MHz) cool gray	19118000	4
Crystal 18.0180MHz (For ISM3, 864.850MHz) violet	19118011	4
Crystal 15.5344MHz (For KR3, 745.650MHz) mint green	19115530	4
Crystal 15.6438MHz (For KR4, 750.900MHz) dark gray	19115640	4
Crystal 17.6822MHz (For SP1, 848.750MHz)	19117680	4
Crystal 17.7447MHz (For SP2, 851.750MHz)	19117740	4
Crystal 16.846MHz (For JP1, 808.625MHz) greenbrown	19116840	4
Crystal 16.857MHz (For JP2, 809.125MHz) light blue	19116850	4
Ceramic Filter 710.151MHz (For US54)	19307100	20
Ceramic Filter 734.151MHz (For US58)	19307340	20
Ceramic Filter 747.141MHz (For KR3)	19374710	20
Ceramic Filter 750.141MHz (For KR4)	19307500	20
Ceramic Filter 802.151MHz (For EU62)	19308020	20
Ceramic Filter 812.151MHz (For EU63)	19308120	20
Ceramic Filter 854.151MHz (For UK69A)	19308540	20
Ceramic Filter 858.151MHz (For UK69B)	19308580	20
Ceramic Filter 864.152MHz (For ISM1)	19308640	20
Ceramic Filter 864.152MHz (For ISM2)	19308640	20
Ceramic filters for further frequencies on request		20
Battery compartment	24200010	5
Battery contact (helical spring)	36304010	6
Battery contact (plate)	36205150	7
Housing tube, printed	27004010	8
Antenna cover, black	21504010	9
Antenna cover, orange	21504013	9
Antenna cover, yellow	21504014	9
Antenna cover, red	21504012	9
Antenna cover, brown	21504011	9
Antenna cover, pink	21504017	9
Antenna cover, green	21504015	9
Antenna cover, violet	21504016	9
Antenna cover, grey	21504018	9
ON/MUTE/OFF label with LED lens	22004010	10
ON/MUTE/OFF slider	25204010	11
Frame for ON/MUTE/OFF slider	22204010	12
Battery door	20104040	13
Capsule	261020034	14
Top grill	9999N07180	15
Housing screw	33002060	16
Rubber plate	65045140	17
Ring	36104010	18
Cover	30818090	19
Stand adapter	23200010	--

Short description Transmitter PT40:

Audio part:

The input signal is connected at Pin2 via L13L14C44C72 (RFFilter), to the MICAMP stage (with Pin1 = ground). The supply voltage of 3.9V for the microphones is connected via R68 at pin 3 of the connector . For microphone application Pin2 and Pin3 has to be shorten in the connector of the microphone. The MICAMP is built as an amplifier, which is a part of the NE575 integrated circuit and has a variable gain of 0dB to 21dB. It also forms the LOCUT filter at 30 Hz and the MIC/LINE switch is situated here, which reduces the input signal by app. 14dB at line position.

Then the signal is fed to the COMPressor. Here the dynamic of the amplitude is reduced to its half value, expressed in dB. This compressor is built with the integrated circuit NE575 from Signetics. In the feedback loop of the amplifier (Pin 12 and 14) is the variable gain cell inserted. The variable gain cell is controlled by the rectified output voltage of the

Für diese Unterlage behalten wir uns alle Rechte vor. Ohne unsere Zustimmung darf sie weder ververviältigt, Dritten zugänglich gemacht, oder anders mißbräuchlich verwendet werden.

amplifier. C18 smoothes the rectified signal and controls the variable gain cell and is the so called timeconstant of the compressor. This feedback loop leads in an compression of the input signal. R45R46C24 build the dcpath in the feedback loop.

The second amplifier is used to build the preemphasis circuit, which boosts the higher frequencies with an time constant of 50usec and a fixed gain of 7.9dB for the lower frequencies.

The deviationadjustment is realized with the potentiometer VR3. Here at an inputlevel of 300mV at 1kHz (and the inputgain set to 0dB=minimumgain) the deviation is adjusted to 15kHz, which is the nominal modulation. Also at MUTEposition of the main switch, the signal is here shorted.

Q7with the additional parts form the HICUTfilter at app. 25 kHz / 3. order.
Via C25R69C26R17 the signal modulates the CCO.

RF part:

The UHF Signal is generated by a crystal controlled oscillator CCO and multiplier amplifier stages (AMP1, AMP2, AMP3, AMP4).

The third harmonic of the CCO is filtered by BPF1, after 3 doubler stages Ftransmit/2 is filtered by BPF2. After the output amplifier AMP5 the signal is filtered by LPF and a ceramic filter BPF3.

Power supply:

The internal voltage of 3.9V is generated from 2 AA size batteries with a DC/DC converter.

All rights reserved. This document may not be duplicated or passed on to any third person without our consent, nor misused in any other way

Für diese Unterlage behalten wir uns alle Rechte vor. Ohne unsere Zustimmung darf sie weder vervielfältigt, Dritten zugänglich gemacht, oder anders mißbräuchlich verwendet werden.

PT40-block schematics

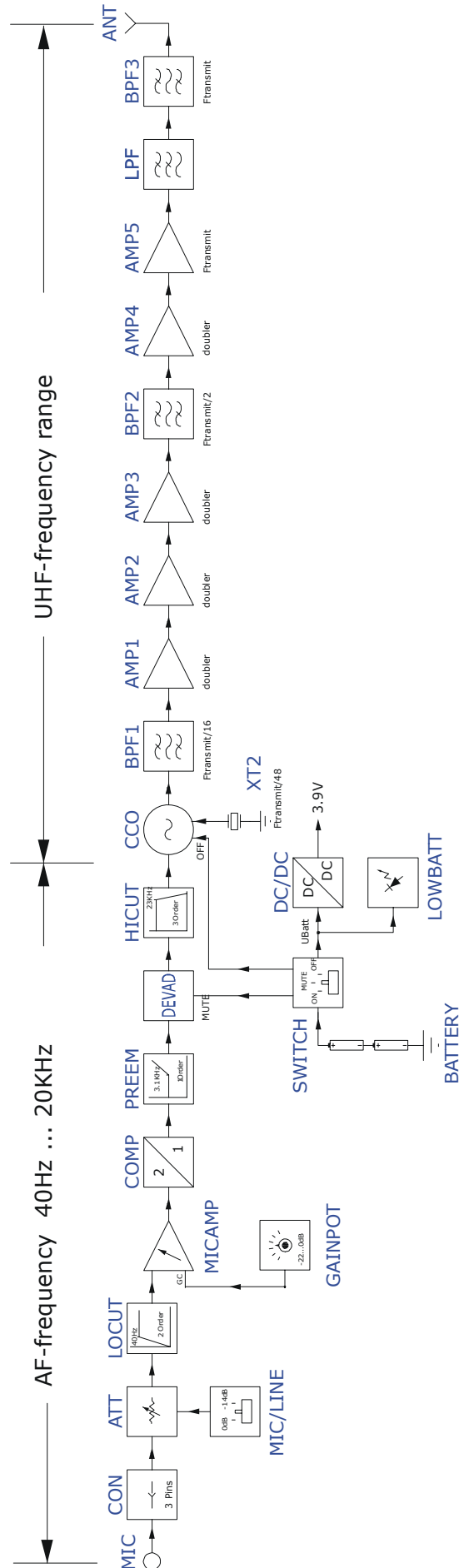

All rights reserved. This document may not be duplicated or passed on to any third person without our consent, nor misused in any other way

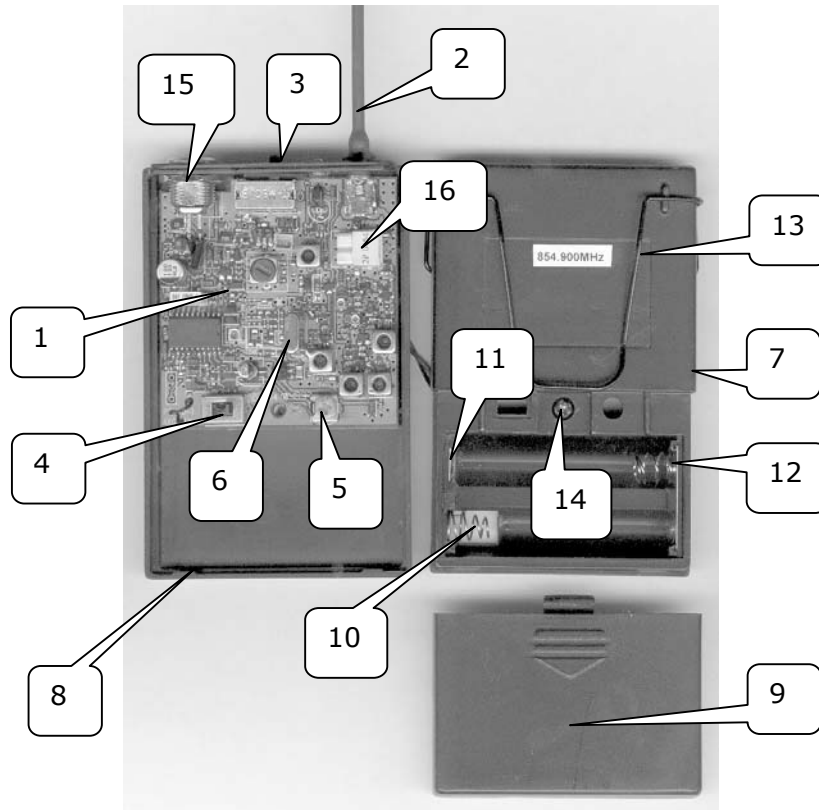

<i>Description</i>	<i>Part number</i>	<i>Item</i>
Printed circuit board, complete, tested	80000402	1
Antenna	83200820	2
ON/MUTE/OFF switch	92100700	3
MIC/LINE switch	92100190	4
Sensitivity trimmer potentiometer	11001043	5
Crystal: see parts list for HT40, Pos 4		6
Housing, bottom shell	21600400	7
Housing, top shell, printed	20300400	8
Battery door	20100400	9
Battery contact (single helical spring)	36300400	10
Battery contact (plate)	36200400	11
Battery contact (plate with helical spring)	36003340	12
Belt clip	36400151	13
Housing screw	33026120	14
Mic socket	90605030	15
Ceramic Filter: see parts list for HT40, Pos 20		16

Für diese Unterlage behalten wir uns alle Rechte vor. Ohne unsere Zustimmung darf sie weder ververviältigt, Dritten zugänglich gemacht, oder anders mißbräuchlich verwendet werden.

Short description Receiver SR40:

The SR40 is a stationary non diversity receiver applying a double conversion conception. The receiver is non switchable, his reception frequency in the UHF range is:

SET CODE	FRx:	FLO1:	XT1:	FIF1:	FLO2=XT2:	FIF2:
US54	710,400MHz	654,400MHz	36,356MHz	56,0MHz	45,3MHz	10,7MHz
US58	734,600MHz	678,600MHz	37,700MHz	56,0MHz	45,3MHz	10,7MHz
EU62	802,525MHz	746,525MHz	41,474MHz	56,0MHz	45,3MHz	10,7MHz
EU63	812,800MHz	756,800MHz	42,044MHz	56,0MHz	45,3MHz	10,7MHz
UK69A	854,900MHz	798,900MHz	44,383MHz	56,0MHz	45,3MHz	10,7MHz
UK69B	858,200MHz	802,200MHz	44,567MHz	56,0MHz	45,3MHz	10,7MHz
ISM1	863,100MHz	807,100MHz	44,839MHz	56,0MHz	45,3MHz	10,7MHz
ISM2	864,375MHz	808,375MHz	44,910MHz	56,0MHz	45,3MHz	10,7MHz

The elements determining the reception frequency are the band pass filter BPF1 and the crystal of local mixer oscillator XT1

RFPart:

The front end consists of a ceramic pass band filter BPF1, a bipolar transistor amplifier AMP1 and a low pass filter LPE. The 1st MIXER1 converts the RF signal to the 1st intermediate frequency of 56MHz, the 2nd MIXER2 converts the signal to the 2nd intermediate (demodulation) frequency 10.7MHz.

The 2nd intermediate frequency is band pass filtered (BPF2,3), amplified (AMP2) and gets to the input of the demodulator IC (LIMAMP and DEMODO).

The 1st mixer oscillator (CCO1) is designed as a crystal controlled oscillator (the 3rd harmonic is filtered out by BPF4) and multiplier amplifiers AMP3 and AMP4. The LO signal is filtered by BPF5, BPF6 and is 56MHz below the reception frequency.

The 2nd mixer oscillator (CCO2) is crystal controlled too, his frequency is 45,3MHz.

AudioPart:

The audio signal from DEMODO (BA4110IFdemodulator) is amplified by AFAMP with U11Pin123. Here the output signal is adjusted to 500mV/1kHz at 15kHz deviation.

Then the signal runs to the MUTEstage, which is the second half of U11. Muting is realized with Q29, which shortens the feedback path. Q29 is controlled by the RSSI signal.

The RSSI signal comes from the IFcircuit BA4110. U7 forms an COMPARATOR, which switches the MUTEtransistor Q29 at RSSI level lower than 98dBm. This value can be adjusted via SQUELCHpotentiometer VR1.

Q25 builds an HICUTfilter at 20 kHz/2nd order. Amplifier Pin17/18/19 of NE575 forms the DEEMphasis circuit. The frequencies above 3 kHz are decreased with first order (timeconstant 50 µsec).

Then the signal is expanded with the EXPander circuit NE575. Here the original level behavior of the input signal at the transmitter input is restored. The expander time constant is defined by C48.

The second free amplifier of NE575 is used as buffer before the volume control section. With VR2 (VOLUME) the output level can be adjusted from line level (500mV) to mic. level (35mV). The next stage is a amplifier with a gain of 3.9dB OUTAMP.

C39 separates the dc voltage from the signal and then the signal is fed to the XLR and 6.3mm JACK. Q31 and Q32 build a CLICKSUPPressioncircuit. In the OFF position of the main switch this transistors are turned on. If the receiver is turned ON, the transistors remain ON for a short time (by C50), so the clicksignals caused by the amplifiers is suppressed.

The balanced output has symmetrical impedance, which is built by R84/R87 and R88/R89.

The receiver is powered by an external device which is to be connected at the rear panel (DC jack POWER) and can be turned on and off by a switch at the front panel (ON/OFF). The internal used voltage (+8V) is stabilized by the DC circuitry (VREG).

All rights reserved. This document may not be duplicated or passed on to any third person without our consent, nor misused in any other way

Für diese Unterlage behalten wir uns alle Rechte vor. Ohne unsere Zustimmung darf sie weder vervielfältigt, Dritten zugänglich gemacht, oder anders mißbräuchlich verwendet werden.

All rights reserved. This document may not be duplicated or passed on to any third person without our consent, nor misused in any other way

Für diese Unterlage behalten wir uns alle Rechte vor. Ohne unsere Zustimmung darf sie weder vervielfältigt, Dritten zugänglich gemacht, oder anders mißbräuchlich verwendet werden.

SR40-block schematics

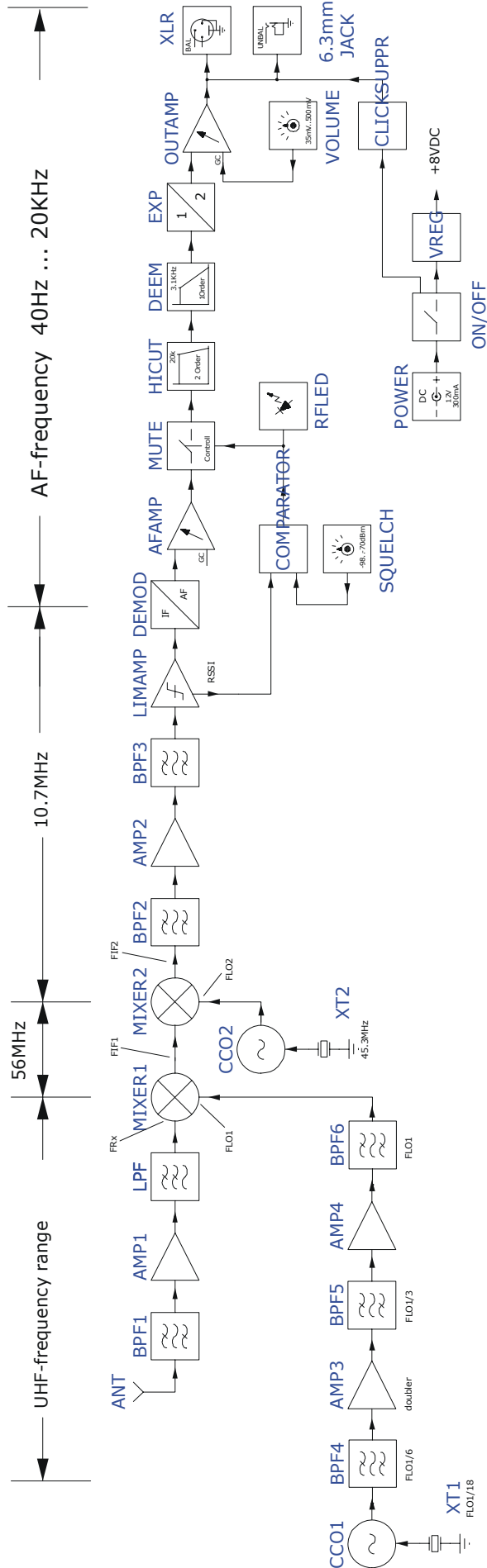

All rights reserved. This document may not be duplicated or passed on to any third person without our consent, nor misused in any other way

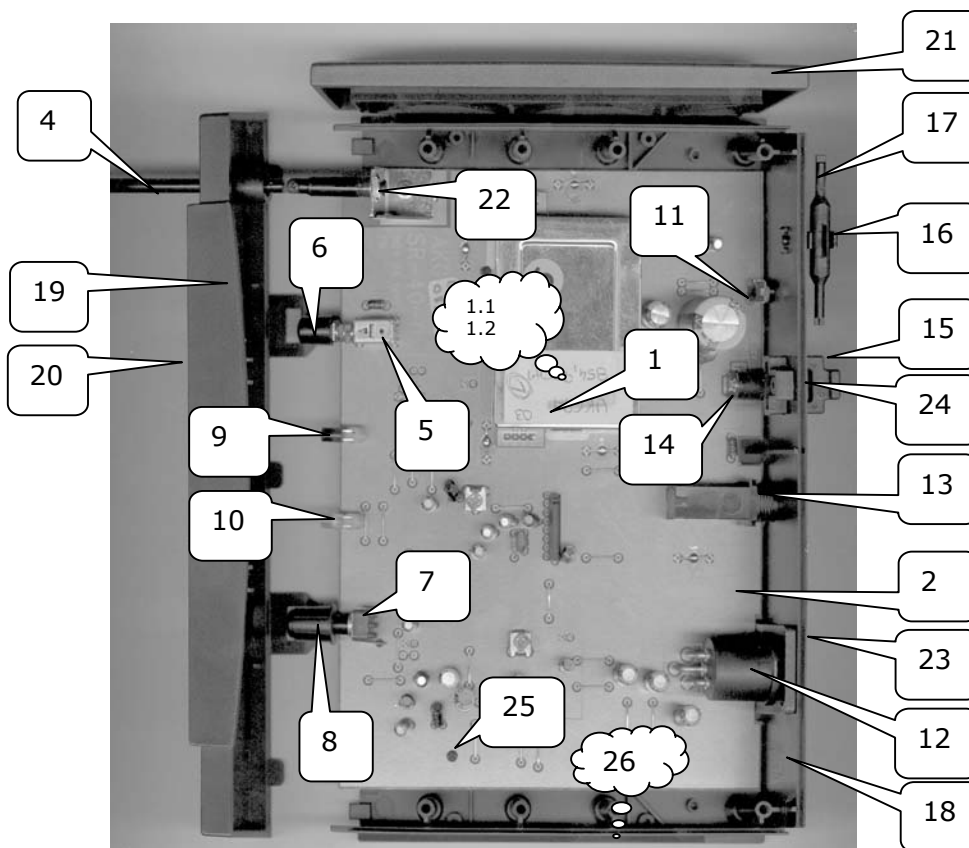

Description	Part number	Item
Tuner, complete, tested PLEASE STATE REQUIRED FREQUENCY!!!	80004010	1
Crystal 45,300 MHz	19204530	1.1
Crystal 36.3556MHz (For US54, 710.400MHz)	19236350	1.2
Crystal 37.7000MHz (For US58, 734.600MHz)	19237700	1.2
Crystal 41.4736MHz (For EU62, 802.525MHz)	19241470	1.2
Crystal 42.0444MHz (For EU63, 812.800MHz)	19242040	1.2
Crystal 44.3833MHz (For UK69A, 854.900MHz)	19244380	1.2
Crystal 44.5667MHz (For UK69B, 858.200MHz)	19244560	1.2
Crystal 44.8389MHz (For ISM1, 863.100MHz)	19244830	1.2
Crystal 44.9097MHz (For ISM2, 864.375MHz)	19244900	1.2
Crystal 38.3139MHz (For KR3, 745.650MHz)	19238310	1.2
Crystal 38.6056MHz (For KR4, 750.900MHz)	19238600	1.2
Crystal 44.0416MHz (For SP1, 848.750MHz)	19244040	1.2
Crystal 44.2083MHz (For SP2, 851.750MHz)	19244200	1.2
Crystals for further frequencies on request		
Main board, complete, tested	80000400	2
Antenna	33398010	4
Power switch	92301900	5
Power switch knob	25100090	6
Volume potentiometer	11200061	7
Volume potentiometer knob	25000060	8
LED green	16531245	9
LED red	16551242	10
Squelch potentiometer	11001042	11
XLR socket	90400081	12
1/4" jack socket	90106470	13
Power supply socket	90000140	14
Tension relief bracket	25300400	15
Screw driver holder	24400121	16
Screw driver	309232000	17
Housing (bottom shell)	21100400	18
Housing (top cover)	20000400	
Front panel, printed	22000400	19
Front panel foil, printed	30100400	20
Side panel, left, right	22300400	21
Screw 2,6x5	33026051	22
Screw 3x8	33030830	23
Screw 2,6x7	33026070	24
Screw 2x6	33002060	25
Screw 2,5x30	33025300	26
Power supply 230 volts Europe version	0027E0006	
Power supply 230 volts UK version	94015930	
Power supply 117 volts US version	94014260	

Für diese Unterlage behalten wir uns alle Rechte vor. Ohne unsere Zustimmung darf sie weder vervielfältigt, Dritten zugänglich gemacht, oder anders mißbräuchlich verwendet werden.

The following parts lists refer to the WMS40 with 863.100 MHz. Crystals and ceramic filters see parts list of HT40, PT40 and SR40

MICROPHONE HT40 Freq. 863.100MHz								
R1, 24	Carbon	10 ohm	±5%	SMT		10310003		
R4, 19	Carbon	1 kohm	±5%	SMT		10310023		
R13,	Carbon	10 kohm	±1%	SMT		10310031		
R28	Carbon	3.9 kohm	±5%	SMT				
R5, 20, 27, 83	Carbon	10 kohm	±5%	SMT		10310033		
R82	Carbon	1.2 kohm	±5%	SMT		10312023		
R17	Carbon	12 kohm	±1%	SMT		10312031		
R40	Carbon	150 kohm	±5%	SMT				
R15	Carbon	18 kohm	±1%	SMT		10318031		
R18	Carbon	220 ohm	±1%	SMT		10322011		
R33	Carbon	2.2 kohm	±5%	SMT		10322023		
R11	Carbon	22 kohm	±1%	SMT		10322031		
R29	Carbon	22 kohm	±5%	SMT		10322033		
R3, 31, 35	Carbon	220 kohm	±5%	SMT		10322043		
R7, 8	Carbon	30 kohm	±5%	SMT		10330033		
R21, 39	Carbon	33 kohm	±5%	SMT		10333033		
R37, 38, 40	Carbon	330 kohm	±5%	SMT		10333043		
R25	Carbon	4.7 kohm	±5%	SMT		10347023		
R30	Carbon	47 kohm	±5%	SMT		10347033		
R32	Carbon	470 kohm	±5%	SMT		10347043		
R6	Carbon	5.6 kohm	±5%	SMT		10356023		
R2	Carbon	56 kohm	±5%	SMT		10356033		
R81	Carbon	68 ohm	±5%	SMT		10368003		
R80	Carbon	680 ohm	±5%	SMT		10368013		
R22	Carbon	68 kohm	±5%	SMT		10368033		
R23	Carbon	680 kohm	±5%	SMT		10368043		
R14	Carbon	8.2 kohm	±1%	SMT		10382021		
R41	Carbon	82 kohm	±5%	SMT		10368033		
R16	20K, POZ3AN51203N ±30% SMT						11302030	
C24	Metallized Polyester Film	0.0068µF	63V	±5%		12306820		
C13	Electrolytic	22 µF	6.3V			12522031		
C52	Ceramic	0,3 pF	50V	±0.25pF	NPO			
C39, 40	Ceramic	1 pF	50V	±0.25pF	NPO	13100013		
C43, 44, 45, 53, 57, 58	Ceramic	2 pF	50V	±0.25pF	NPO	13100023		
C42, 54	Ceramic	3 pF	50V	±0.25pF	NPO	13100033		
C11	Ceramic	4.7 pF	50V	±0.25pF	NPO	13100042		
	Ceramic	5 pF	50V	±0.25pF	NPO	13100053		
C41, 68	Ceramic	10 pF	50V	±0.5pF	NPO	13100103		
C6, 14, 67	Ceramic	15 pF	50V	±5%	NPO	13100153		
C31, 33	Ceramic	30 pF	50V	±5%	NPO	13100303		
C32, 38, 66	Ceramic	50 pF	50V	±5%	NPO	13100503		
C16,	Ceramic	68 pF	50V	±5%	NPO	13100683		

All rights reserved. This document may not be duplicated or passed on to any third person without our consent, nor misused in any other way

Für diese Unterlage behalten wir uns alle Rechte vor. Ohne unsere Zustimmung darf sie weder vervielfältigt, Dritten zugänglich gemacht, oder anders missbräuchlich verwendet werden.

All rights reserved. This document may not be duplicated or passed on to any third person without our consent, nor misused in any other way

C7, 18	Ceramic	100 pF	50V	±5%	NPO	13101003	
C48, 49, 50, 56, 69, 70, 81	Ceramic	0.001 µF	50V	±10%	X7R	13101023	
C22	Ceramic	2200 pF	50V	±10%	X7R		
C36, 37, 88	Ceramic	0.01 µF	50V	±10%	X7R	13101033	
C3, 4	Ceramic	0.047 µF	25V	±10%	X7R	13114733	
C60	Ceramic	1 µF	16V	±10%	X7R	13101051	
C28, 82, 84, 85, 86, 87	Ceramic	10 µF	50V	+80%20%		13101066	
C8, 23	Ceramic	220 pF	50V	±5%	NPO	13102203	
C2	Ceramic	470 pF	50V	±5%	NPO	13104703	
	Tantalum	0.1 µF	35V	±20%	SMT	13401043	
C1, 10, 26, 27, 34, 35, 83	Tantalum	10 µF	10V	±20%	SMT	13401063	
C17, 21, 29, 30	Tantalum	2.2 µF	16V	±20%	SMT	13402253	
C5, 9, 25, 61	Tantalum	4.7 µF	16V	±20%	SMT	13404753	
C51, 55	210P TZVY2Z100A110					13520100	
L3, 4, 5, 6	LQP11A15nG00T1M SMT					14715000	
L10	LQP11A22nG14 SMT					14722000	
L11	LQN21A100n SMT						
L8		100 µH	TDK NL3225221R2K			14710100	
L1, 2		82 nH	TDK NL322522082J			14782001	
U2	Philips NE575D SMT					15105750	
U1	3V SIKEO, S81230SGUPDQBT1					15181230	
Q1	CTR, FMW1, T148 SMT					15301480	
Q13	ROHM 2SD2098					15320980	
Q2, 3, 14	Toshiba 2SC2712GR, SMT					15327120	
Q4, 5, 6, 8	Toshiba 2SC2714Y					15327140	
Q7, 9	NEC 2SC3356					15333560	
D1	LED	3φ, Red				16530012	
D2	VARACTOR	Toshiba	1SV161			16201610	
D5	ZENER	ROHM	3V9			16603900	
D6		ROHM	RB451			16904510	
T2, 3	A294SNST1191Z					19011910	
T4	A294SNST1192Z					19011920	
T5	A294SNST1388Z					19013880	
T1	A294SNST1414Z					19014140	
T6	H054444168					19041680	
L7	Center Freq. 864MHz 3dB Band Width ±1.5MHz					19308640	
SW1	Slide Switch, SS019P223MAMHPA3					92100400	
XT1	NIC17.9815MHz					19117980	
J107, 109	3 P (2mm) 61003PASG1					90300032	

Für diese Unterlage behalten wir uns alle Rechte vor. Ohne unsere Zustimmung darf sie weder vervielfältigt, Dritten zugänglich gemacht, oder anders mißbräuchlich verwendet werden.

All rights reserved. This document may not be duplicated or passed on to any third person without our consent, nor misused in any other way

TRANSMITTER PT40 Freq. 863.100MHz								
R47, 55	Carbon	10 ohm	±5%	SMT		10310003		
R36, 50, 66	Carbon	1 kohm	±5%	SMT		10310023		
R67	Carbon	100 ohm	±5%	SMT		10310013		
R53	Carbon	10 kohm	±1%	SMT		10310031		
R69	Carbon	3.9 kohm	±5%	SMT				
R18, 38, 73	Carbon	10 kohm	±5%	SMT		10310033		
R57	Carbon	100 kohm	±5%	SMT		10310043		
R43	Carbon	1.2 kohm	±5%	SMT		10312023		
R62	Carbon	22 kohm	±1%	SMT				
R6	Carbon	1.5 kohm	±5%	SMT		10315023		
R41	Carbon	150 kohm	±5%	SMT				
R61	Carbon	56 kohm	±1%	SMT				
R20	Carbon	220 ohm	±1%	SMT		10322011		
R29	Carbon	2.2 kohm	±5%	SMT		10322023		
R35	Carbon	22 kohm	±1%	SMT		10322031		
R44,	Carbon	22 kohm	±5%	SMT		10322033		
R25, 51, 70, 71	Carbon	220 kohm	±5%	SMT		10322043		
R45, 46	Carbon	30 kohm	±5%	SMT		10330033		
R56	Carbon	33 kohm	±5%	SMT		10333033		
R32, 40	Carbon	330 kohm	±5%	SMT		10333043		
R4, 68	Carbon	4.7 kohm	±5%	SMT		10347023		
R17, 59	Carbon	47 kohm	±5%	SMT		10347033		
R72	Carbon	470 kohm	±5%	SMT		10347043		
R54	Carbon	56 kohm	±5%	SMT		10356033		
R34	Carbon	68 ohm	±5%	SMT		10368003		
R33, 52	Carbon	680 ohm	±5%	SMT		10368013		
R37, 39	Carbon	68 kohm	±5%	SMT		10368033		
R63	Carbon	680 kohm	±5%	SMT		10368043		
R1	Carbon	8.2 kohm	±1%	SMT		10382021		
R42	Carbon	82 kohm	±5%	SMT		10368033		
VR2	Panasonic 10 kohm MATEVND8YA03B24						11001043	
VR3	20K, POZ3AN51203N ±30% SMT						11302030	
C19	Metallized Polyester Film	0.0022µF	63V	±5%				
C6	Electrolytic	100 µF	6.3V			12501071		
C7	Electrolytic	22 µF	6.3V			12522031		
C10, 35	Ceramic	0,3 pF	50V	±0.25%	NPO			
	Ceramic	1 pF	50V	±0.25%	NPO	13100013		
C45, 47, 53, 56, 57	Ceramic	2 pF	50V	±0.25%	NPO	13100023		
C39, 49	Ceramic	3 pF	50V	±0.25%	NPO	13100033		
C62	Ceramic	4.7 pF	50V	±0.25%	NPO	13100042		
	Ceramic	5 pF	50V	±0.25%	NPO	13100053		
C70	Ceramic	7 pF	50V	±0.25%	NPO	13100073		
C42	Ceramic	10 pF	50V	±0.5%	NPO	13100103		
C40	Ceramic	12 pF	50V	±5%	NPO	13100123		

Für diese Unterlage behalten wir uns alle Rechte vor. Ohne unsere Zustimmung darf sie weder vervielfältigt, Dritten zugänglich gemacht, oder anders mißbräuchlich verwendet werden.

All rights reserved. This document may not be duplicated or passed on to any third person without our consent, nor misused in any other way

C50, 72	Ceramic	15 ρ F	50V	\pm 5%	NPO	13100153	
C38, 52	Ceramic	30 ρ F	50V	\pm 5%	NPO	13100303	
C35, 37, 43	Ceramic	50 ρ F	50V	\pm 5%	NPO	13100503	
C59, 64	Ceramic	68 ρ F	50V	\pm 5%	NPO	13100683	
C44, 63	Ceramic	100 ρ F	50V	\pm 5%	NPO	13101003	
C29, 46, 54, 65, 66	Ceramic	0.001 μ F	50V	\pm 10%	X7R	13101023	
C28	Ceramic	2200 ρ F	50V	\pm 10%	X7R		
C33, 41, 48, 58, 67, 69, 76	Ceramic	0.01 μ F	50V	\pm 10%	X7R	13101033	
C51, 61	Ceramic	0.047 μ F	25V	\pm 10%	NPO	13114733	
C18	Ceramic	1 μ F	16V	\pm 10%	X7R	13101051	
C1, 3, 4, 23, 75	Ceramic	10 μ F	V	+80%20%		13101066	
C68	Ceramic	220 ρ F	50V	\pm 5%	NPO	13102203	
C60	Ceramic	330 ρ F			X7R	13103303	
	Tantalum	0.1 μ F	35V	\pm 20%	SMT	13401043	
C13	Tantalum	1 μ F	16V	\pm 20%	SMT	13401053	
C2, 9, 11, 15, 16, 24, 73, 74,	Tantalum	10 μ F	10V	\pm 20%	SMT	13401063	
C12, 20, 21, 25, 26	Tantalum	2.2 μ F	16V	\pm 20%	SMT	13402253	
C8, 17	Tantalum	4.7 μ F	16V	\pm 20%	SMT	13404753	
C14, 71	210P TZVY2Z100A110					13520100	
L5, L8		LQP11A10nG14 SMT				14710000	
L6, 7		LQP11A15nG00T1M SMT				14715000	
L3, 11, 12		LQP11A22nG14 SMT				14722000	
L13		LQN21A100n SMT					
L4		100 μ H	TDK NL3225221R2K			14710100	
L13, 14		82 nH	TDK NL322522082J			14782001	
U1	Philips NE575D SMT					15105750	
U2	3V SIKEO, S81230SGUPDQB1					15181230	
Q19	CTR, FMW1, T148 SMT					15301480	
Q4	ROHM 2SD2098					15320980	
Q7, 8, 23	Toshiba 2SC2712GR, SMT					15327120	
Q2, 10, 11, 21	Toshiba 2SC2714Y					15327140	
Q12, 16	NEC 2SC3356					15333560	
D3	LED	3 ϕ , Red				16530012	
D6	VARACTOR	Toshiba	1SV161			16201610	
D2	ZENER	ROHM	3V9			16603900	
D8	RECTIFIER	ROHM	1SR154400			16701541	
D1		ROHM	RB451			16904510	
T1, 4	A294SNST1191Z					19011910	
T6	A294SNST1388Z					19013880	
T2	A294SNST1192Z					19011920	
T3	A294SNST1414Z					19014140	
L1	H054444168					19041680	
L2	Center Freq. 864MHz 3dB Band Width \pm 1.5MHz					19308640	
SW1	Slide Switch, SS019P022BBmPA7					92100190	
SW2	Slide Switch, SS070P823MBbPB6					92100700	

Für diese Unterlage behalten wir uns alle Rechte vor. Ohne unsere Zustimmung darf sie weder vervielfältigt, Dritten zugänglich gemacht, oder anders missbräuchlich verwendet werden.

All rights reserved. This document may not be duplicated or passed on to any third person without our consent, nor misused in any other way

XLT1	NIC17.9815MHz				19117980	
	Antenna Fixed Plate				34600400	
J3	PCB Jack	2 P			90200022	

Für diese Unterlage behalten wir uns alle Rechte vor. Ohne unsere Zustimmung darf sie weder vervielfältigt, Dritten zugänglich gemacht, oder anders missbräuchlich verwendet werden.

All rights reserved. This document may not be duplicated or passed on to any third person without our consent, nor misused in any other way

RECEIVER SR40 Freq. 863.1MHz							
R69	Carbon	10	ohm	±5%	0603	10310003	
R87, 88	Carbon	100	ohm	±1%	0603	10310011	
R1	Carbon	100	ohm	±5%	0603	10310013	
R3, 8, 9, 56, 57, 77, 116	Carbon	1	kohm	±5%	0603	10310023	
R40, 120	Carbon	10	kohm	±1%	0603	10310031	
R49, 59	Carbon	10	kohm	±5%	0603	10310033	
R34, 35, 39, 54, 82	Carbon	100	kohm	±5%	0603	10310043	
R18, 32, 73	Carbon	120	kohm	±5%	0603	10312043	
R4	Carbon	1.5	kohm	±5%	0603	10315023	
R29, 30	Carbon	15	kohm	±5%	0603	10315033	
R61	Carbon	18	kohm	±1%	0603	10318031	
R6	Carbon	22	ohm	±5%	0603	10322003	
R62	Carbon	220	ohm	±5%	0603	10322013	
R12, 22	Carbon	2.2	kohm	±5%	0603	10322023	
R20, 46, 74	Carbon	22	kohm	±5%	0603	10322033	
R55, 67, 107	Carbon	220	kohm	±5%	0603	10322043	
R72	Carbon	2.2	Mohm	±5%	0603	10322053	
R44	Carbon	27	kohm	±1%	0603	10327031	
R2, 5, 47	Carbon	330	ohm	±5%	0603	10333013	
R43	Carbon	3.3	Kohm	±5%	0603	10333023	
R10, 11, 38, 118	Carbon	47	ohm	±5%	0603	10347003	
R117	Carbon	470	ohm	±5%	0603	10347013	
R15, 51, 78, 79, 80, 81	Carbon	4.7	Kohm	±5%	0603	10347023	
R65, 66, 85, 86	Carbon	47	kohm	±5%	0603	10347033	
R84, 89	Carbon	560	ohm	±1%	0603	10356011	
R83	Carbon	560	ohm	±5%	0603	10356013	
R26	Carbon	5.6	kohm	±5%	0603	10356023	
R68	Carbon	56	kohm	±5%	0603	10356033	
R119	Carbon	680	ohm	±5%	0603	10368013	
R7	Carbon	6.8	kohm	±5%	0603	10368023	
R76	Carbon	68	kohm	±5%	0603	10368033	
VR1	Carbon	10KΩ	Panasonic EVND2YA03B14			11001042	
VR2	Carbon	10 KA	RK09K1110452			11200061	
VR3	Carbon	20KΩ	Panasonic MATEVND8YA03B24			11002040	
VR4	Carbon	100KΩ	Panasonic MATEVND8YA03B15			11001050	
C14	Polyester	0.0027 μF	50V	±5%		12202726	
C32	Electrolytic	0.1 μF	50V	±20%		12401046	
C31, 45	Electrolytic	1 μF	50V	±20%		12401056	
C10, 25, 28, 36, 44	Electrolytic	10 μF	16V	±20%		12401063	
C49, 53	Electrolytic	100 μF	16V	±20%		12401073	
C4,33 43	Electrolytic	2.2 μF	50V	±20%		12402256	
C9	Electrolytic	220 μF	16V	±20%		12402273	
C11	Electrolytic	2200 μF	25V	±20%		12402294	

Für diese Unterlage behalten wir uns alle Rechte vor. Ohne unsere Zustimmung darf sie weder vervielfältigt, Dritten zugänglich gemacht, oder anders mißbräuchlich verwendet werden.

All rights reserved. This document may not be duplicated or passed on to any third person without our consent, nor misused in any other way

C19, 35, 37, 38, 39, 46	Electrolytic	4.7 μ F	50V	\pm 20%	12404756	
C50, 51, 52	Electrolytic	47 μ F	50V	\pm 20%	12404765	
C2, 3, 15, 26, 27	Ceramic	27 ρ F		NPO	13100273	
C22	Ceramic	50 ρ F	50V	NPO	13100503	
C75, 78, 103	Ceramic	100 ρ F	50V	NPO	13101003	
C5, 12, 20, 24, 34, 55, 80	Ceramic	0.001 μ F	50V	X7R	13101023	
C1, 8, 107	Ceramic	0.01 μ F	50V	X7R	13101033	
C76, 77, 110, 111	Ceramic	220 ρ F	50V	NPO	13102203	
C13, 17, 18, 21, 23, 73, 82, 102	Ceramic	0.022 μ F	50V	10% X7R	13102233	
C16, 84, 85	Ceramic	680 ρ F	50V	X7R	13106803	
C74	Ceramic	470 ρ F	50V		13104703	
C83	Ceramic	0.0015 μ F	50V	X7R	13101523	
C48	Ceramic	1 μ F	16V	10% X7R	13101051	
L1			5.6 μ H	\pm 5%	14405600	
L2	KOA LFC32		1 μ H	\pm 5%	14701000	
L3	TDK NL322522		100 μ H	\pm 5%	14710100	
L4	TDK NL3225226R8J		6.8 μ H	\pm 5%	14706800	
U3	Rohm BA4110				15041100	
U10	Philips NE575D SMT				15105750	
U7	Rohm BA10393F				15110390	
U9, 11	Rohm BA4558FEZ				15145580	
Q30	Rohm CTR, IMX2				15300020	
Q31	Rohm CTR, FMW1				15301480	
Q18	Rohm 2SB1188R				15311880	
Q16, 23, 25, 27, 29, 32	Toshiba 2SC2712GR				15327120	
D7, D8	Silicon	1N4001	Hitachi		16140010	
D1	LED	4.7 ϕ	RED		16504702	
D2	LED	4.7 ϕ	GREEN		16504705	
D6	Zener	ROHM	5V1	SMT	16605101	
D3	Zener	ROHM	8V2	SMT	16608200	
Q24, 28		ROHM	DAN212K		16902120	
Q17		ROHM	DAN217		16902170	
CF1	CDA10.7MA18A				17201073	
J5	AF Output	6.3 mm			90106470	
J4	DC Jack	2 mm			90000140	
	Balanced Jack 94M008P1				90400081	
SW1	SPPJ22NE01 2P				92301900	

Für diese Unterlage behalten wir uns alle Rechte vor. Ohne unsere Zustimmung darf sie weder vervielfältigt, Dritten zugänglich gemacht, oder anders missbräuchlich verwendet werden.

All rights reserved. This document may not be duplicated or passed on to any third person without our consent, nor misused in any other way

TUNER							
R24	Carbon	0	ohm	±5%	0603	10300003	
R3, 6, 27, 39, 43	Carbon	1	kohm	±5%	0603	10310023	
R23, 36	Carbon	2.2	kohm	±5%	0603	10322023	
R4, 5, 29	Carbon	4.7	kohm	±5%	0603	10347023	
R30	Carbon	5.6	kohm	±5%	0603	10356023	
R14	Carbon	10	ohm	±5%	0603	10310003	
R1, 2, 25	Carbon	10	kohm	±5%	0603	10310033	
R11	Carbon	47	ohm	±5%	0603	10347003	
R28, 38, 40, 42	Carbon	47	kohm	±5%	0603	10347033	
R26, 31	Carbon	82	kohm	±5%	0603	10382033	
R9, 10, 12, 13	Carbon	100	ohm	±5%	0603	10310013	
R8, 22	Carbon	100	kohm	±5%	0603	10310043	
R35	Carbon	220	kohm	±5%	0603	10322043	
R7	Carbon	330	ohm	±5%	0603	10333013	
R41	Carbon	390	ohm	±5%	0603	10339013	
R12, 20	Carbon	560	ohm	±5%	0603	10356013	
C33, 45	Ceramic	1 ρF	50V	±5%	NPO	13100013	
C50	Ceramic	1.5 ρF	50V	±5%	NPO	13100011	
C54, 111	Ceramic	3 ρF	50V	±5%	NPO	13100033	
C12, 37	Ceramic	4 ρF	50V	±5%	NPO	13100043	
C52, 110	Ceramic	5 ρF	50V	±5%	NPO	13100053	
C51	Ceramic	7 ρF	50V	±5%	NPO	13100073	
C32, 35	Ceramic	8 ρF	50V	±5%	NPO	13100083	
C10, 31, 55	Ceramic	10 ρF	50V	±5%	NPO	13100103	
C13	Ceramic	12 ρF	50V	±5%	NPO	13100123	
C1, 26	Ceramic	15 ρF	50V	±5%	NPO	13100153	
C47	Ceramic	20 ρF	50V	±5%	NPO	13100203	
C30,40, 44, 49	Ceramic	27 ρF	50V	±5%	NPO	13100273	
C2, 27	Ceramic	30 ρF	50V	±5%	NPO	13100303	
C43	Ceramic	50 ρF	50V	±5%	NPO	13100503	
C53	Ceramic	68 ρF	50V	±5%	NPO	13100683	
C25, 36, 88	Ceramic	100 ρF	50V	±5%	NPO	13101003	
C3, 29, 34, 42, 46, 48, 84, 85	Ceramic	0.001 μF	50V	10%	X7R	13101023	
C28	Ceramic	0.01 μF	50V	10%	X7R	13101033	
C4, 5, 6, 8, 41, 73	Ceramic	0.022 μF	50V	10%	X7R	13102233	
C39, 47	Ceramic	220 ρF	50V	±5%	NPO	13102203	
C7, 38	Ceramic	470 ρF	50V	±5%	NPO	13104703	
L14		1.3GHz	B69610G1307B412 4x4mm			14400130	
L19		LQP11A10nG14 SMT				14710000	
L17, 19		LQP11A15nG00T1M SMT				14715000	
L16, 22		LQP11A22nG14 SMT				14722000	
L15		LQP11A33nG00T1M SMT				14733000	
L1, 9		1μH	TDK NL3225221R0J			14701001	

Für diese Unterlage behalten wir uns alle Rechte vor. Ohne unsere Zustimmung darf sie weder ververvielfältigt, Dritten zugänglich gemacht, oder anders mißbräuchlich verwendet werden.

All rights reserved. This document may not be duplicated or passed on to any third person without our consent, nor misused in any other way

L17		3.3 nH	LQG11A3N3S00	14700033	
L12		5.6 nH	LQG11A5N6S00	14700056	
L20		100nH	TDK NL322522TR10J	14700100	
L2		0.82 μH	KOA LFC320.82μH	14700820	
L21		8.2 μH	KOA LFC328.2μH	14708200	
L3, 5		0.47 nH	TDK NL322522TR47J	14704710	
Q1, 2, 4,		Toshiba 2SC2714Y		15327140	
Q5		NEC 2SC3356		15333560	
Q3	FieldEffect	Toshiba FET 3SK151Y		15401510	
VC1	6CTC10	4.5~20	RED TZBX4R200BA110	13520010	1R0.5K
CF1, 3	E10.7MH			17201073	
BPF	Center Freq. 864MHz 3dB Band Width ±1.5MHz			19308640	
L4, 10	A294SNST1192Z			19011920	
L13	A294SNST1407Z			19014070	
J1	2 P P2.54mm			90300023	
J4	4 P P2.54mm			90300043	
XL1	NIC45.3000MHz			19204530	
XL2	NIC44.8389MHz			19244830	

Für diese Unterlage behalten wir uns alle Rechte vor. Ohne unsere Zustimmung darf sie weder vervielfältigt, Dritten zugänglich gemacht, oder anders mißbräuchlich verwendet werden.

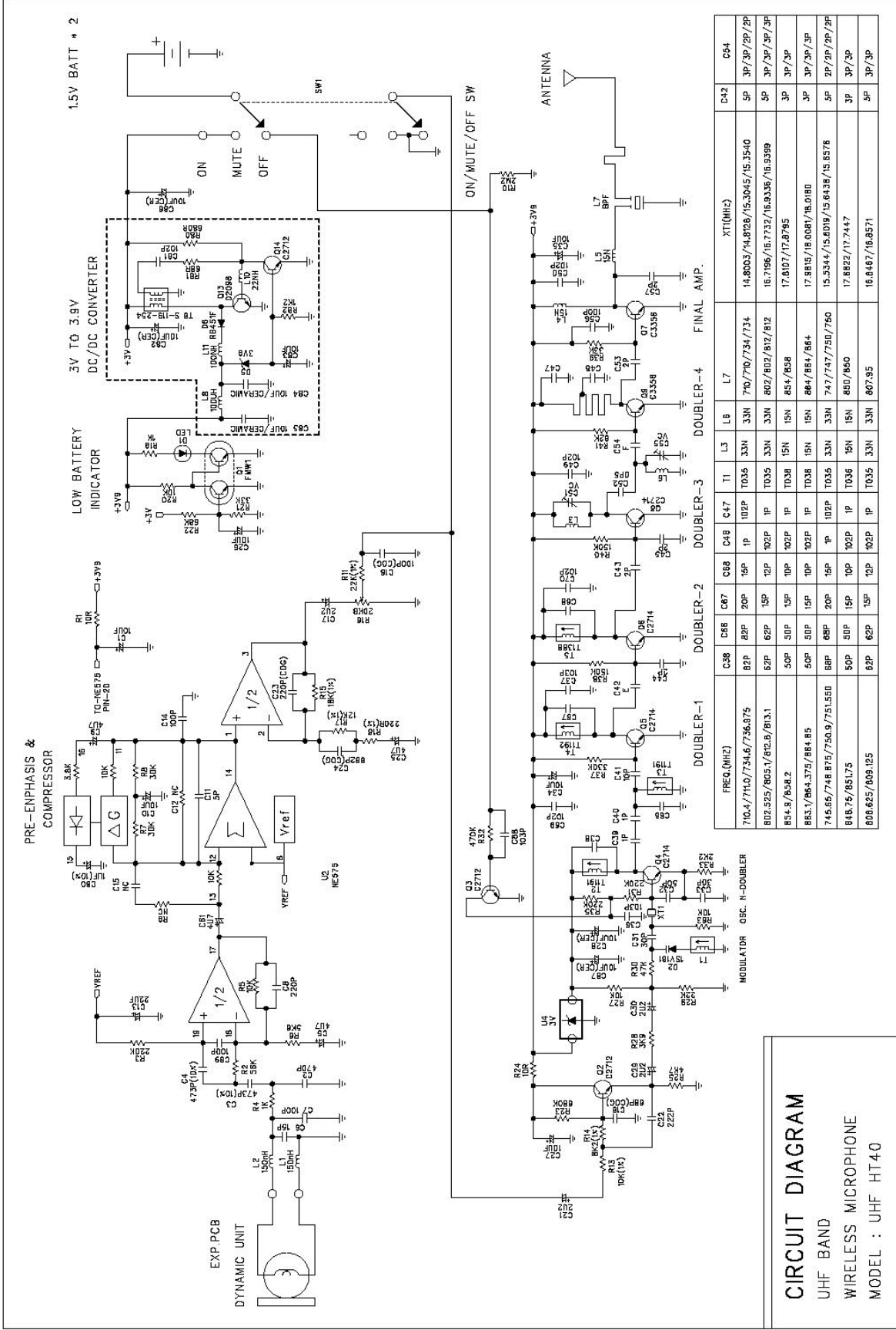

CIRCUIT DIAGRAM
 UHF BAND
 WIRELESS MICROPHONE
 MODEL : UHF HT40

FREQ.(MHZ)	C38	C48	C47	L3	L7	XT(MHZ)	C54
700.4/711.0/734.6/736.9/75	82P	20P	1P	102P	33N	746/770/734/734	5P
802.525/805.1/812.8/813.1	82P	15P	1P	102P	33N	802/802/812/812	5P
854.5/858.2	50P	15P	1P	102P	15N	17.0107/17.2795	3P
883.7/884.373/884.85	50P	15P	1P	102P	15N	17.9815/18.0061/18.0180	3P
948.75/951.75	50P	15P	1P	102P	33N	15.5344/15.6019/15.6438/15.6578	5P
808.625/809.125	82P	15P	1P	102P	33N	17.8822/17.7447	3P
						16.8487/16.8571	5P

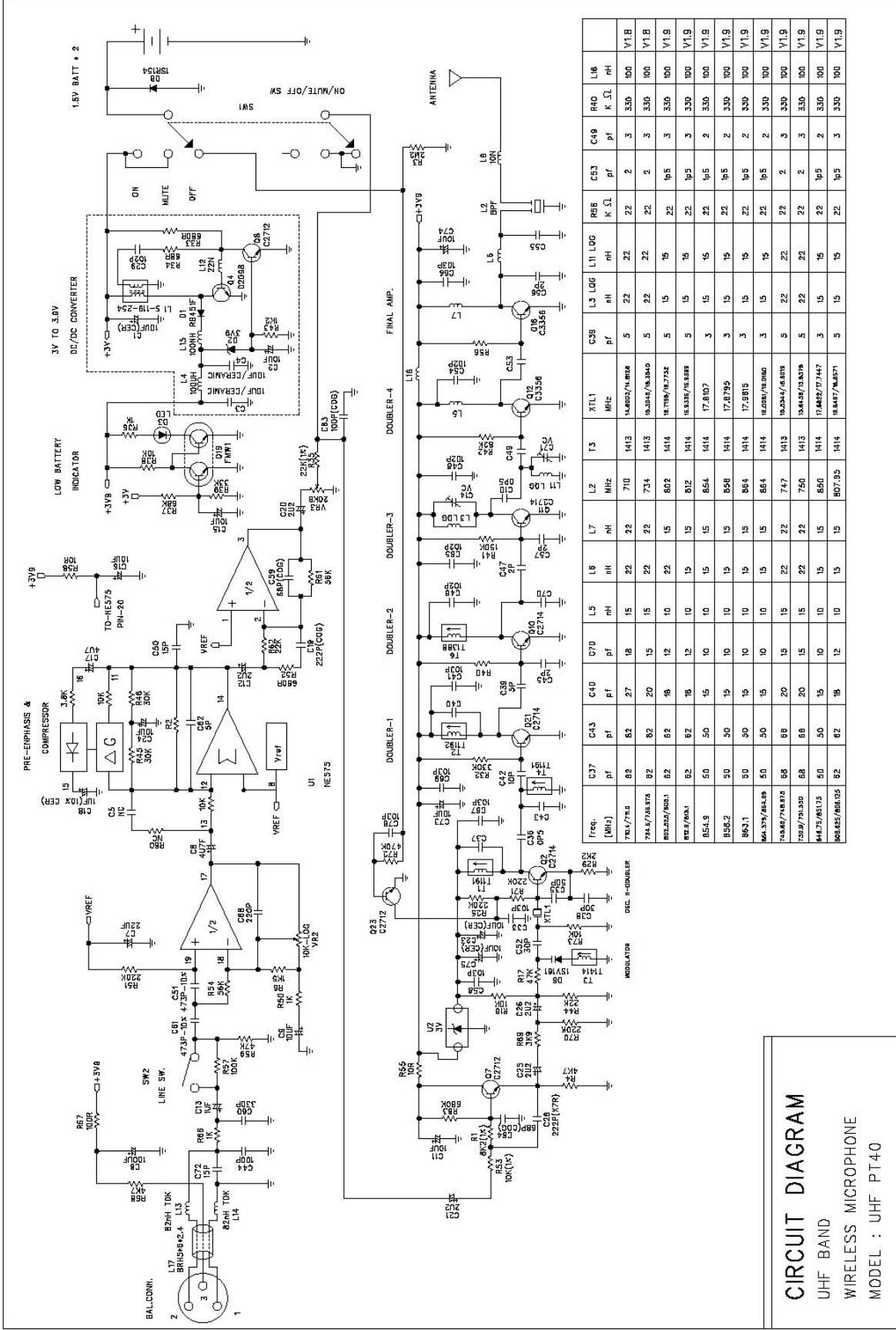

Freq. [MHz]	C37	C43	C40	C70	L3	L8	L7	L2	T3	XTL1	C39	L3	L06	L11	L06	R66	C49	R40	L16	
	pf	pf	pf	pf	nH	nH	nH	MHz	MHz	MHz	pf	nH	nH	nH	nH	K Ω	pf	K Ω	nH	
76.4/76.8	82	82	27	18	15	22	22	710	1413	14.8052/14.8088	5	22	22	22	22	22	2	3	330	100
78.4/78.875	82	82	20	15	15	22	22	734	1413	16.3541/16.3580	5	22	22	22	22	22	2	3	330	100
80.252/80.251	82	82	18	12	10	22	15	802	1414	18.7198/18.7232	5	15	15	15	15	22	145	3	330	100
82.8/83.4	82	82	18	12	10	15	15	812	1414	18.8387/18.8428	5	15	15	15	15	22	145	3	330	100
85.4.8	50	50	15	10	10	15	15	854	1414	17.8107	3	15	15	15	15	22	145	2	330	100
88.2	50	50	15	10	10	15	15	858	1414	17.8795	3	15	15	15	15	22	145	2	330	100
863.1	50	50	15	10	10	15	15	864	1414	17.93615	3	15	15	15	15	22	145	2	330	100
864.372/864.38	50	50	15	10	10	15	15	864	1414	18.0084/18.0120	3	15	15	15	15	22	145	2	330	100
864.667/864.672	68	68	20	15	15	22	22	747	1413	18.0341/18.0378	5	22	22	22	22	22	2	3	330	100
88.8/89.350	68	68	20	15	15	22	22	750	1413	18.0647/18.0688	5	22	22	22	22	22	2	3	330	100
84.75/85.13	60	50	15	10	10	15	15	860	1414	17.8482/17.847	3	15	15	15	15	22	145	2	330	100
90.432/90.435	82	62	18	12	10	15	15	807.35	1414	18.8487/18.8571	5	15	15	15	15	22	145	3	330	100

CIRCUIT DIAGRAM
 UHF BAND
 WIRELESS MICROPHONE
 MODEL : UHF PT40

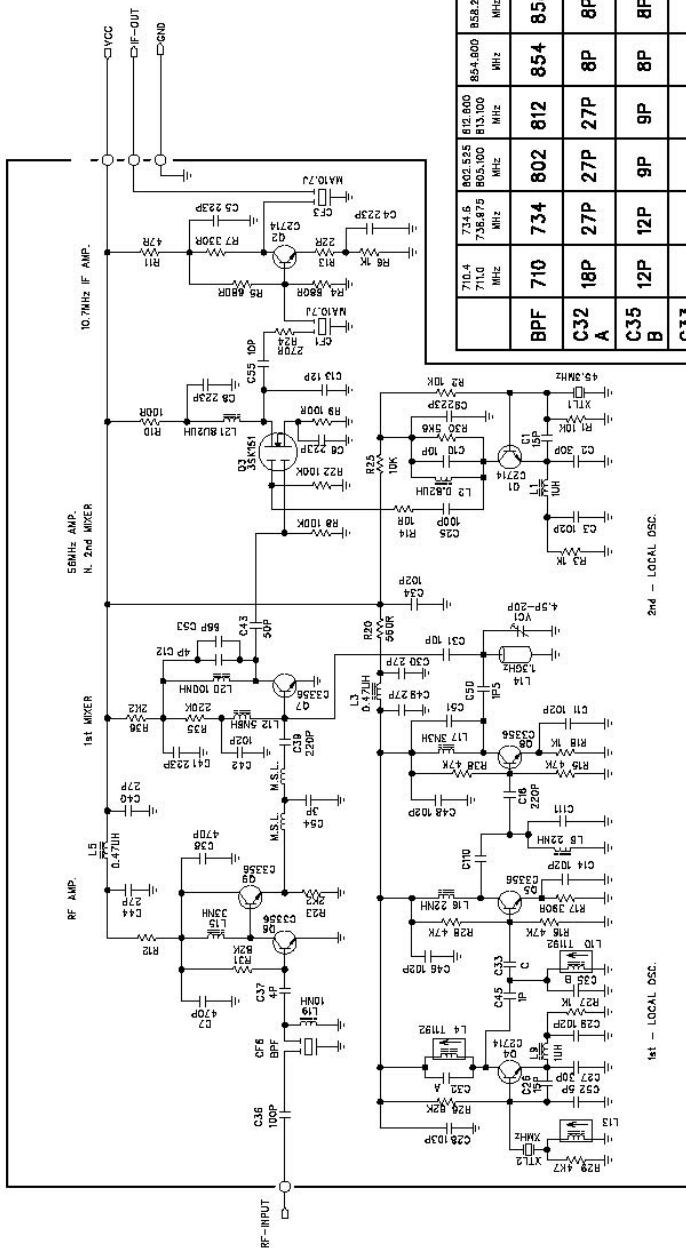

1st - LOCAL OSC.

2nd - LOCAL OSC.

REF. : SR-40-TUNER

710.4	724.5	734.5	745.85	750.9	759.9	768.75	775.85	781.35	785.75	806.855	808.855
710.4	734.5	745.85	750.9	759.9	768.75	775.85	781.35	785.75	785.75	806.855	808.855
710.4	734.5	745.85	750.9	759.9	768.75	775.85	781.35	785.75	785.75	806.855	808.855
BPF	710	734	802	812	854	858	864	864	850	850	807
C32	18P	27P	27P	27P	8P	8P	8P	8P	8P	8P	27P
C35	12P	12P	9P	9P	8P	8P	8P	8P	8P	8P	9P
C33	3P	3P	1P5	1P5	1P	1P	1P	1P	1P	1P	1P5
C26	10P	10P	15P	15P	15P	15P	15P	15P	15P	15P	15P
XTL2	36.3558	37.7000	41.4736	42.0444	44.3097	44.3097	44.3097	44.3097	44.3097	44.3097	44.3097
XMHZ	36.3689	37.8319	41.6167	42.0611	44.3683	44.3683	44.3683	44.3683	44.3683	44.3683	44.3683
C110	7P	7P	4P	5P	5P	5P	5P	5P	5P	5P	5P
C111	8P	8P	8P	8P	8P	8P	8P	8P	8P	8P	8P
C51	12P	10P	10P	8P	7P	7P	7P	7P	7P	7P	8P
R12	270R	270R	270R	270R	100R	100R	100R	100R	100R	100R	270R
L13	T1408	T1408	T1407	T1407	T1407	T1407	T1407	T1407	T1407	T1407	T1407

SCHEMATIC DIAGRAM
UHF BAND
WIRELESS RECEIVER
MODEL: SR-40T

AUG 03 02 V1.4

All rights reserved. This document may not be duplicated, reproduced, or transmitted in any form or by any means, without our consent, nor misused in any other way.

Für diese Unterlage behalten wir uns alle Rechte vor. Ohne unsere Zustimmung darf sie weder vervielfältigt, Dritten zur Verfügung gestellt, noch in irgendeiner Weise verbreitet werden.

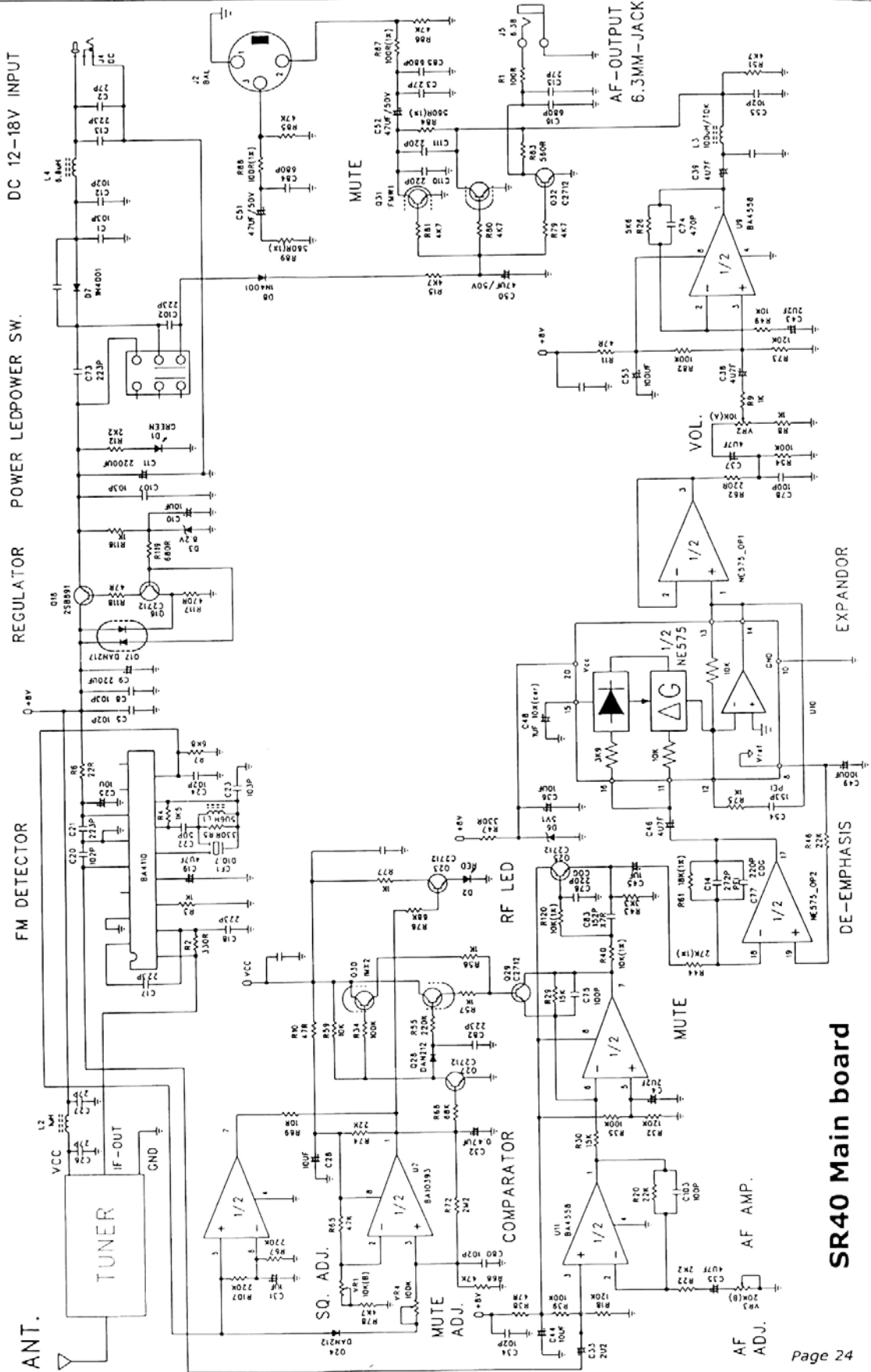

SR40 Main board

ANT. DC 12-18V INPUT

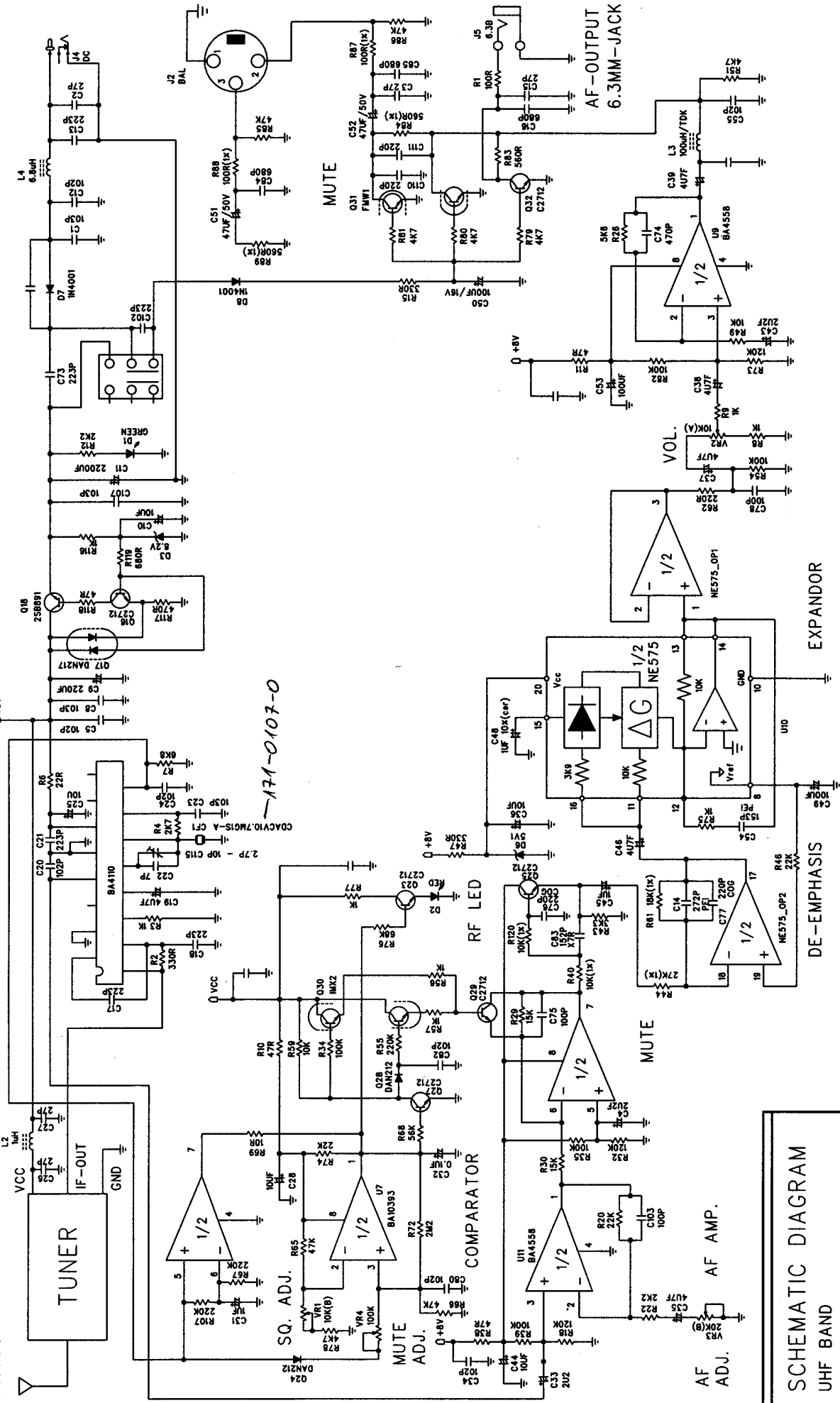

171-0107-0

SCHEMATIC DIAGRAM
 UHF BAND
 WIRELESS RECEIVER
 MODEL: SR-40 AUDIO AMP.