

PROFESSIONAL

TABLE OF CONTENTS

SERVICE INFORMATION

Specifications	42
Adjustments	43
Voltage Chart	44
Block Diagram	45

SCHEMATICS

Drawing No. 1 Tone Generators & Power Supply	46
Drawing No. 2 Keyswitches & Tabswitches	47
Drawing No. 3 Keyswitches & Tabswitches	48
Drawing No. 4 Sustain Keyswitches, Percussion Keyswitches & Clarinet/Sharp Preamps	49
Drawing No. 5 Flute Filters, Celeste Filters & Preamps	50
Drawing No. 6 Vibrato, Percussion & Amplifier	51

PHOTOGRAPHS

SERVICE ACCESS AND CIRCUIT LOCATION

Front View	52
Front View (With Tabswitch Assembly Raised)	53
Top View (With Cover Removed)	54
Bottom View	55

PRINTED CIRCUIT BOARDS

Amplifier & Percussion Board (PA110)	56
Rectifier Board (PA117)	57
Regulator Board (PA103)	57
Tone Generator Board (With Oscillator, Divider & Sustain Keyer Boards) (PA76)	58
Vibrato, Filter & Preamp Board (PA112)	59
Voicing Board (PA111)	59

PARTS

Parts Information	60
Parts List	68

PROFESSIONAL

SPECIFICATIONS

MAIN FEATURES

61 Notes Keyboard—C to C
Phonic extension: 32.7 cycles to 7,902 cycles

Swell Pedal

Flute Section

8 Voice Stops: 16' - 8' - 5-1/3'
4' - 2-2/3' - 2' - 1-3/5' - 1-1/3'

Cancel Tab

Independent Volume Control

Independent Vibrato Control

Clarinet-Sharp Section

4 Clarinet Voice Stops: 16' - 8' - 5-1/3' - 4'
4 Sharp Voice Stops: 2-2/3' - 2' - 1-3/5' - 1-1/3'

Cancel Tab

Independent Volume Control

Independent Vibrato Control

Percussion Section

8 Stops: 16' - 8' - 5-1/3' - 4' - 2-2/3' - 2' - 1-3/5' - 1-1/3'

Percussion length control: Short - Medium - Long

Cancel Tab operating on the 3 lowest octaves

Cancel Tab operating on the 2 highest octaves

2-position tab for Percussion with synchronized

repetition or for Percussion according to the

Phrasing.

Independent Volume Control

Sustain Section

3 Stops: Celesta - Harpsichord - Kinura

2-position Sustain length control tab

Cancel Tab operating on the 3 lowest octaves

Independent Volume Control

Independent Vibrato Control

Vibrato Section

3 Stops: On/Off - Slow/Fast - Light/Heavy

Overall Output Volume Control

Output for Stereo Headset

Tilting Keyboard

On/Off switch and Pilot lamp

Folding legs

Elegant carrying bag

Voltage: 115 Volt AC, 60 cycles

Dimensions when in use: 38" x 18 3/4" x 36"

Dimensions of the instrument closed:

40" x 10" x 20"

Weight: 87 lbs.

PROFESSIONAL

ADJUSTMENTS PROFESSIONAL

VR1-VR11 FILTERS

These adjustments are carefully set at the factory! Readjustment should not be necessary unless Filter components are replaced. To adjust a filter: First, connect an A.C. voltmeter across the speakers in the amplifier to which the organ is connected. Then, with a clip lead, ground the transistor collector lead of the filter requiring adjustment. While the filter is grounded and using only one flute tabswitch at a time, locate a group of dead keys on the keyboard and hold down one key at or near the center of this group. Next, while holding the note, remove the clip lead from the filter transistor. Now with the note playing, adjust the A.C. meter range so that the meter needle reads near center scale. (Use any meter range and organ volume combination that is convenient). With the note still playing, set the filter adjustment to a point that gives the maximum increase in A.C. voltage.

VR12-VR13 VIBRATO DEPTH & LEVEL

These two adjustments affect each other. Adjustment of one will change the other. Proper adjustment is achieved when the vibrato functions clearly. Extreme setting of either the depth or level adjustments will result in **no vibrato**. Always try adjusting vibrato before servicing the vibrato circuits.

VR14-VR15 PERCUSSION LENGTH & ATTACK

These two adjustments affect each other. Adjustment of one will change the other. Proper adjustment is achieved when the percussion functions with the least amount of key pop; and with a distinct difference in percussion length between short and long percussion tabswitch settings. Extreme setting of either the length or attack adjustments will result in **no percussion**. Always try adjusting percussion before servicing the percussion circuits.

VR16 SQUELCH

The function of this adjustment is to compensate for tolerances in Squelch Keyer transistors. Since this adjustment is carefully set at the factory, adjustment should only be necessary when squelch circuit components are replaced. Proper setting is achieved when this adjustment is at or near center and the organ plays with ample volume range.

VR17 ORGAN LEVEL

Set this adjustment according to customer preference! A normal setting is approximately three-fourths toward full volume.

VR22 +12 VOLTAGE

This adjustment is carefully set at the factory! Re-adjustment should not be necessary unless Power Supply components are replaced. To adjust, connect

a D.C. voltmeter to plug and socket #1 pin 3, then set the adjustment so that the meter reads +12 volts. Improper voltage adjustment will result in unstable tone generator operation. Always check the +12 volt supply voltage before servicing tone generators.

VR23 STABILITY

The stability adjustment is carefully set at the factory! Readjustment should not be necessary unless Power Supply components are replaced. This adjustment has a wide range of normal operation. Only extreme settings on this adjustment will result in unstable Power Supply operation.

VR24 +6 VOLTAGE

This adjustment is carefully set at the factory! Re-adjustment should not be necessary unless Power Supply components are replaced. To adjust, connect a D.C. voltmeter to plug and socket #1 pin 5, then set the adjustment so that the meter reads +6 volts. +6V is used for audio ground. Low or missing +6V will result in hum and increased sound leakage. Always check the +6 volt supply voltage before servicing.

L1 TUNING

The 12 Tone Generator Master Oscillator circuits determine the pitch of the entire organ. Adjusting any one of the Master Oscillator tuning adjustments will tune all the notes of that tone generator. Tuning any group of 12 notes automatically tunes the entire organ.

Tuning may be accomplished by using a small non-conductive screwdriver and one of the following methods:

1. Set of 12 Tuning Forks: Zero beat the note of the organ to be tuned to the sound of the corresponding tuning fork. This is a highly accurate method for tuning.
2. Strobe Conn or Strobe Tuner: This is done by visual observation of a strob pattern. Simply follow directions supplied with the Strobotuner. This is a highly accurate tuning method.
3. Another instrument: Zero beat the note of the organ to be tuned to the sound of a corresponding note on an "in tune" instrument (piano, organ, accordion, etc.). Accuracy is dependent upon the tuning of the other instruments. This method is especially desirable when the other instrument is to be played with the organ.
4. One Tuning Fork: One tuning fork is used to set the "temperment" (one note). The other 11 notes are set by ear using the number of beats between "4ths" and "5ths." This requires a trained ear. Accuracy is dependent upon the tuner.

PROFESSIONAL

TRANSISTOR VOLTAGES

Q No.	Circuit	Collector or Drain	Emitter or Source	Base or Gate
Q1	Master Oscillator	+2.2	+12	+14
Q2-Q3	1st Divider	+6	+1.3	+1.5
Q4-Q5	2nd Divider	+6	+1.3	+1.5
Q6-Q7	3rd Divider	+6	+1.3	+1.5
Q8-Q9	4th Divider	+6	+1.3	+1.5
Q10-Q11	5th Divider	+6	+1.3	+1.5
Q12-Q13	6th Divider	+6	+1.3	+1.5
Q14	16' Solo Divider	+10	+1.1	+1
Q15	16' Solo Divider	+1.3	+1.1	+1.8
Q16	Clarinet/Sharp Preamp	+3.8	+7	+4
Q17	Clarinet/Sharp Preamp	+4.5	+3.1	+3.8
Q18	103-Flute Filter	+4.9	+7	+1
Q19	206-Flute Filter	+4.9	+7	+1
Q20	412-Flute Filter	+4.9	+7	+1
Q21	824-Flute Filter	+4.9	+7	+1
Q22	1648-Flute Filter	+4.9	+7	+1
Q23	3296-Flute Filter	+4.9	+7	+1
Q24	6592-Flute Filter	+5.4	+7	+1.6
Q25	Flute Preamp	+3.5	+9	+1
Q26	206-Celeste Filter	+5.5	+5	+5
Q27	412-Celeste Filter	+5	+5	+5
Q28	824-Celeste Filter	+5.2	+5	+5
Q29	1648-Celeste Filter	+5.5	+5	+5
Q30	Celeste/Kinura Preamp	+4.9	+6	+9
Q31	Percussion Multivibrator	+3	ϕ	+7
Q32	Percussion Multivibrator	+12	ϕ	ϕ
Q33	Percussion Driver	ϕ	+9	+12
Q34	Percussion Modulator	+9	ϕ	+9
Q35	Percussion Preamp	+3.5	+5	+4
Q36	Percussion Preamp	+6	+3	+3.5
Q37	Vibrato Oscillator	+5	+1.7	+1.5
Q38	Vibrato Phase Shifter	+9	+1.5	+7
Q39	Vibrato Phase Keyer	+9	+9	+2.8
Q40	Vibrato Output Preamp	+5		+3
Q41	Squelch Keyer	ϕ	+11	+8.8
Q42	Amp Input Preamp	+7	+1	+1.2
Q43	Squelch Gate	+1.3	+4	+1.5
Q44	Driver	+4.2	+7	+1.3
Q45	Output	ϕ	+5	+4.2
Q46	Output	+12	+5.5	+6
Q47	Voltage Sensor	-12	+5.8	+5.2
Q48	Voltage Regulator	ϕ	-12.5	-12.5
Q49	Voltage Regulator	ϕ	+12	+12

BLOCK DIAGRAM

PROFESSIONAL

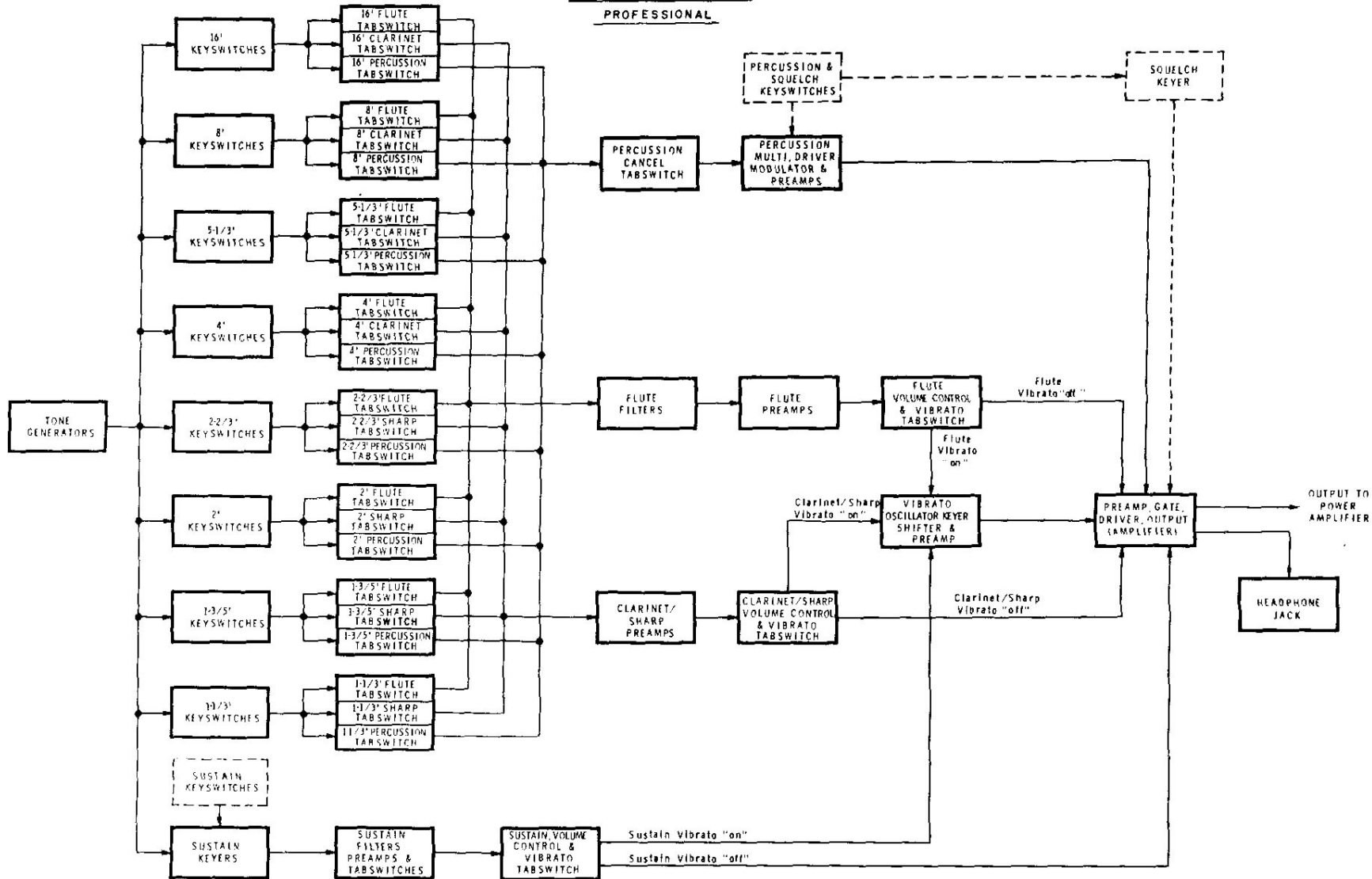

LEGEND

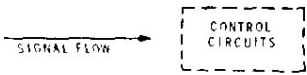

GEN.	C1	C2-C3
C	.0068	.012
C#	.0068	.012
D	.0056	.01
D#	.0047	.0082
E	.0047	.0082
F	.0047	.0082
F#	.0039	.0068
G	.0039	.0068
G#	.0039	.0068
A	.0039	.0068
A#	.0039	.0068
B	.0039	.0068

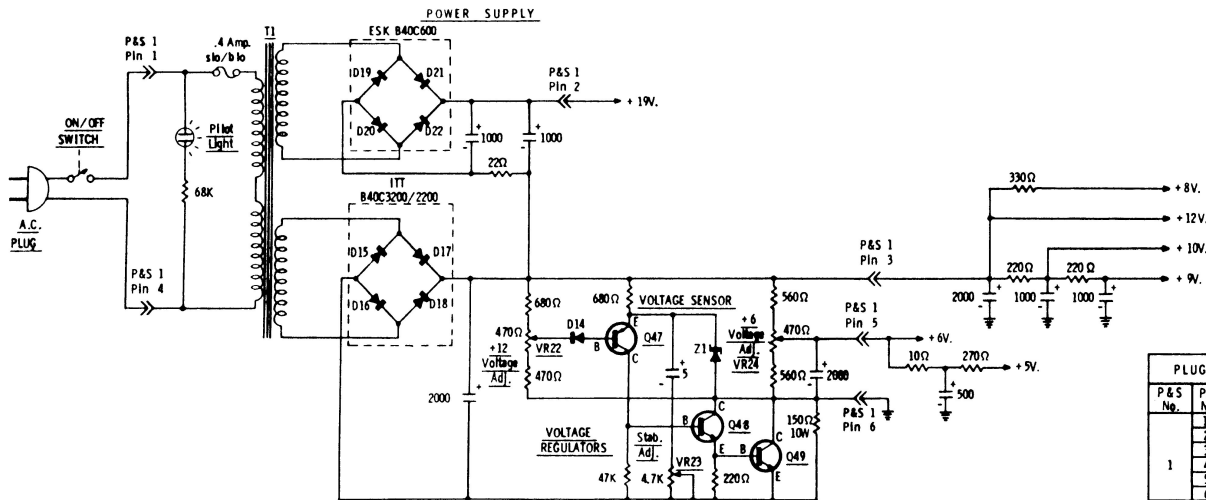
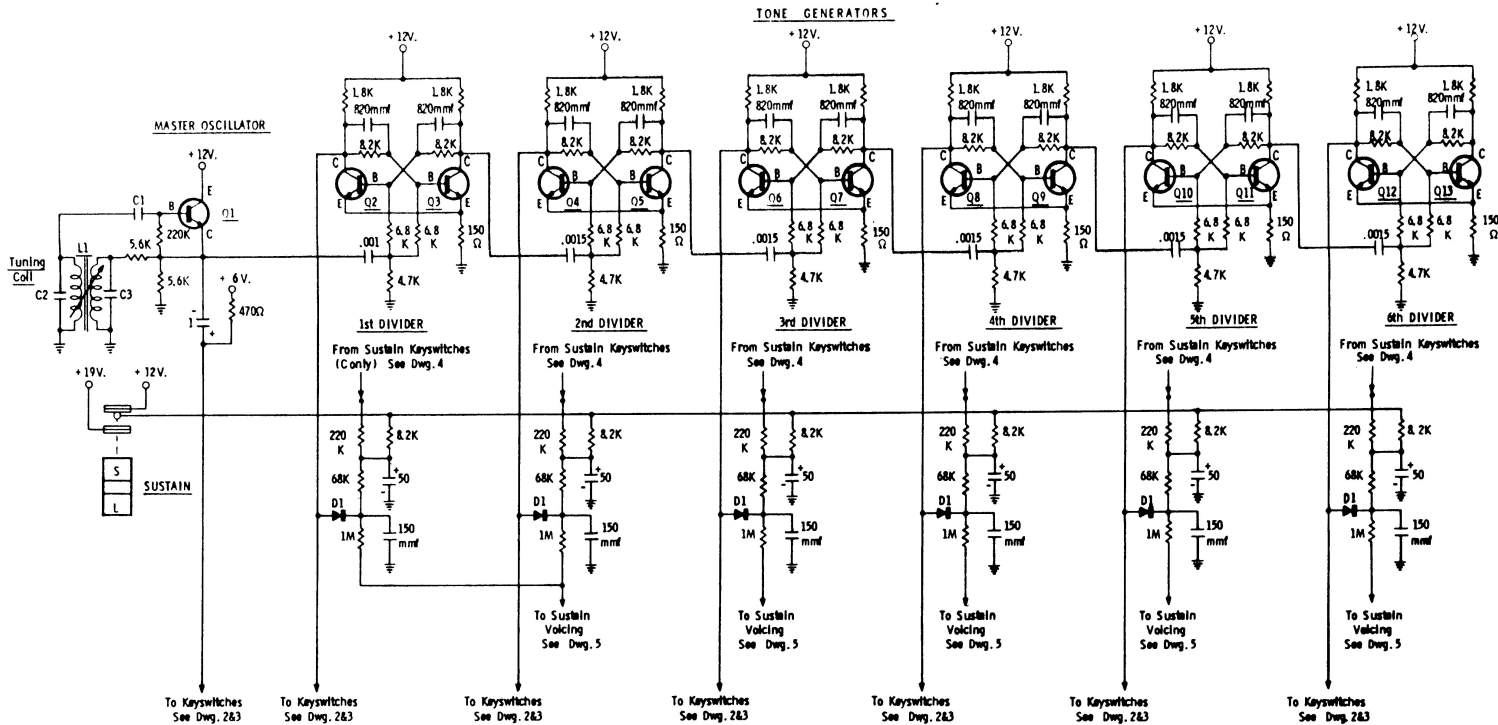

- NOTES:
1. All resistors 1/2 watt 10% unless otherwise specified.
 2. All capacitors are in microfarads unless otherwise specified.
 3. All voltages measured to ground with a Simpson 260 VOM.
 4. See parts list for component part numbers.
 5. Radar spelled backwards is radar. They get you coming and going.
 6. All tabswitches shown in "on" position.

P&S No.	Pin No.	Voltage	INFORMATION
1	1	117 VAC	Line Voltage
	2	+19V	Sustain Short B+
	3	+12V	Screen B+
	4	117 VAC	Line Voltage
	5	+6V	Audio Ground
	6	Gnd	Ground

TOPE GENERATORS & POWER SUPPLY
PF722
 Dwg. No. 1 PROFESSIONAL

4' KEYSWITCHES

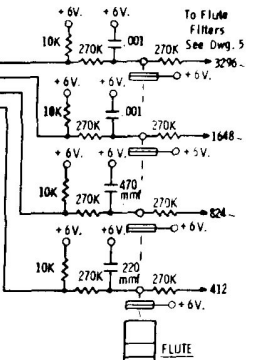
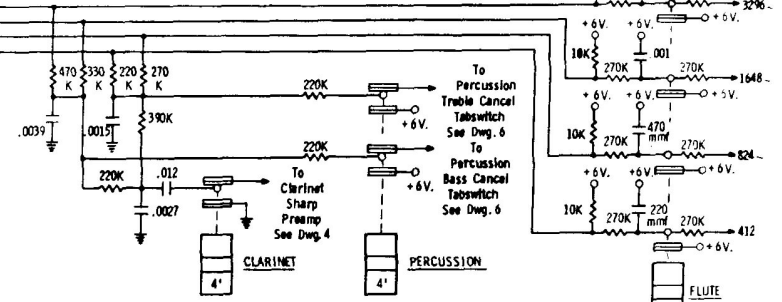
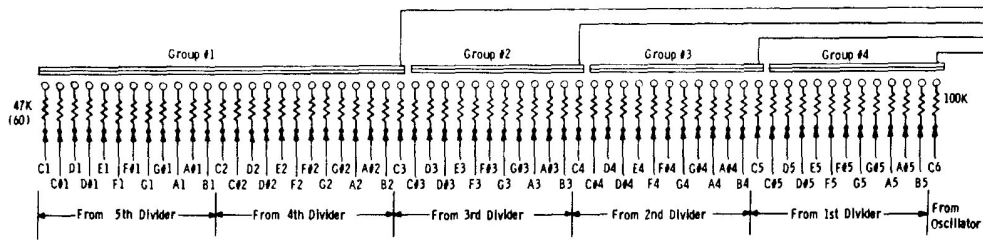

5 1/3' KEYSWITCHES

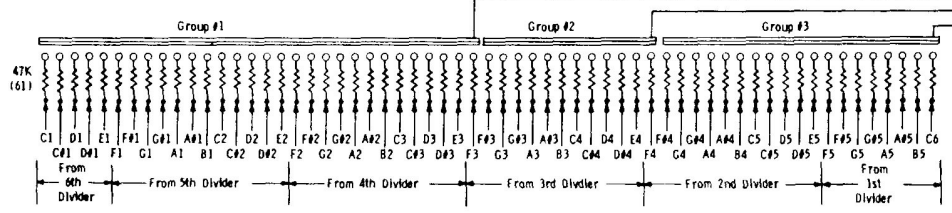

KEY	GEN
C	G
C#	G#
D	A
D#	A#
E	B
F	C
F#	C#
G	D
G#	D#
A	E
A#	F
B	F#

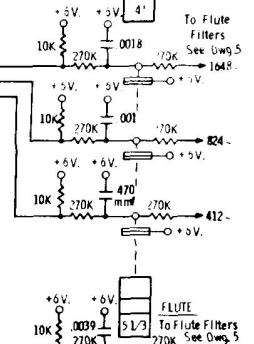
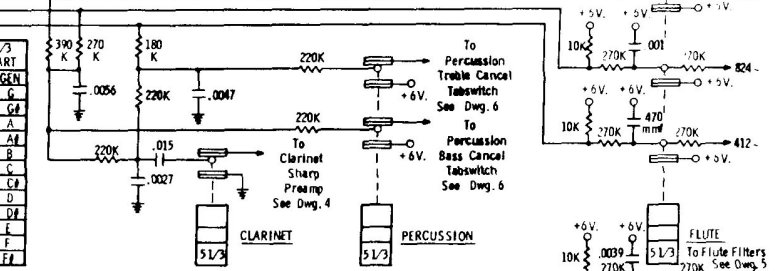

8' KEYSWITCHES

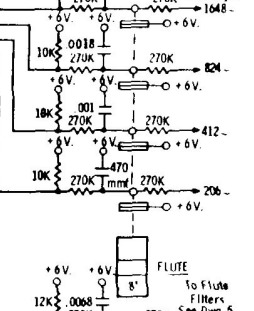
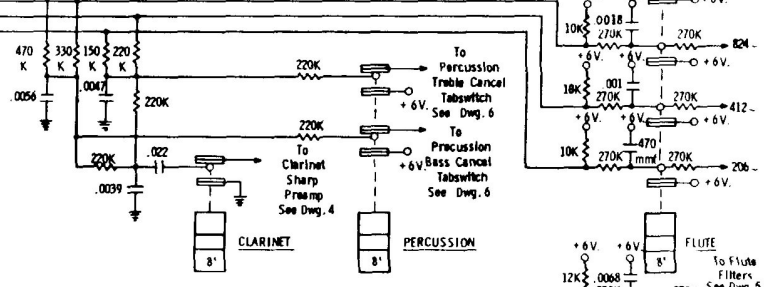
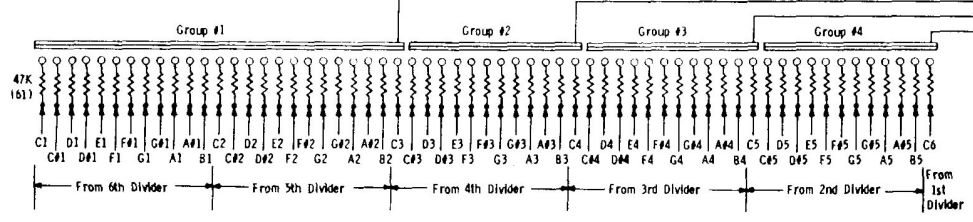

16' KEYSWITCHES

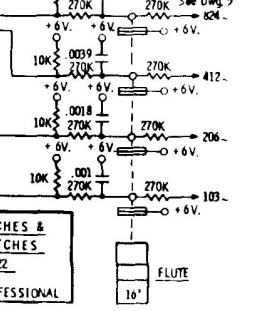
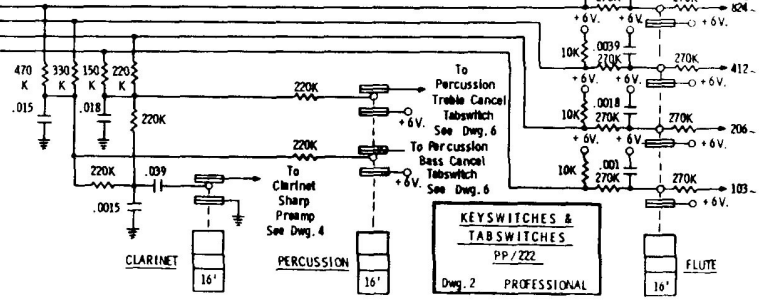
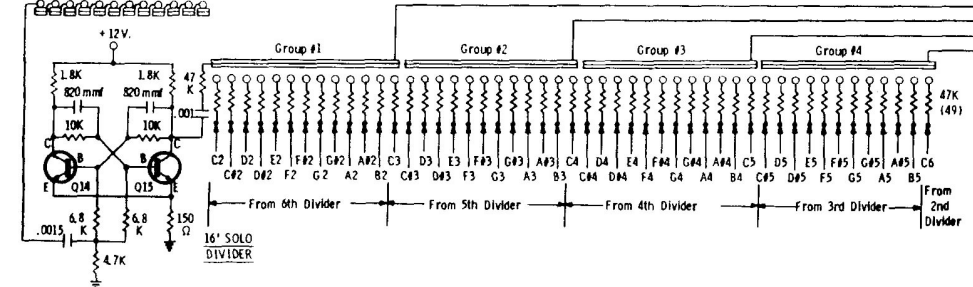

KEYSWITCHES & TABSWITCHES
PP/ZZZ
Dwg. 2 PROFESSIONAL

SUSTAIN KEYSWITCHES

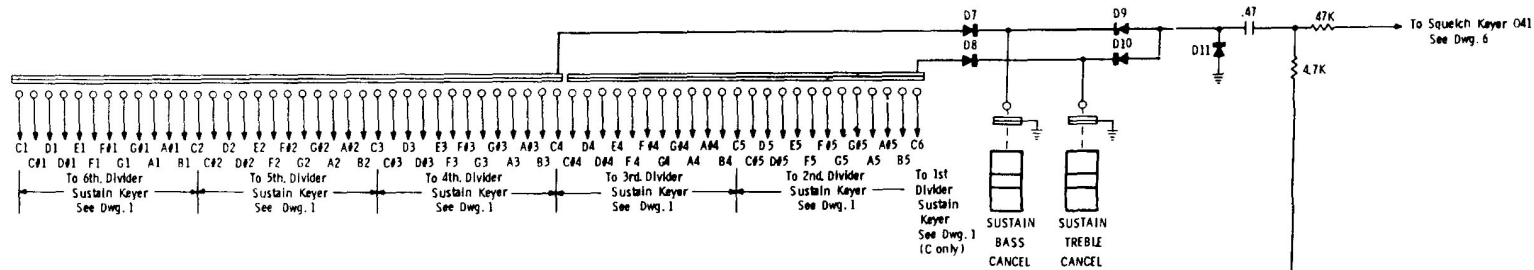

POLYPHONIC PERCUSSION KEYSWITCHES

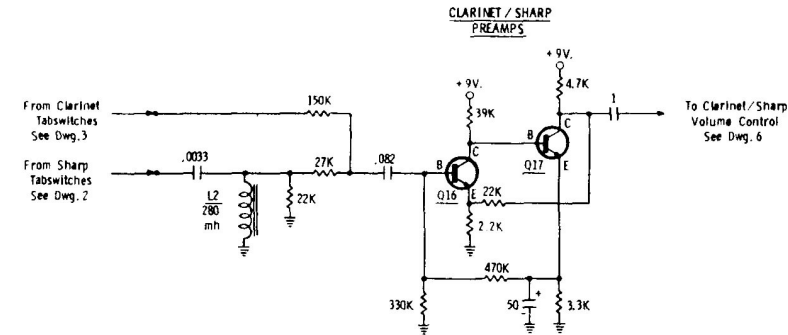
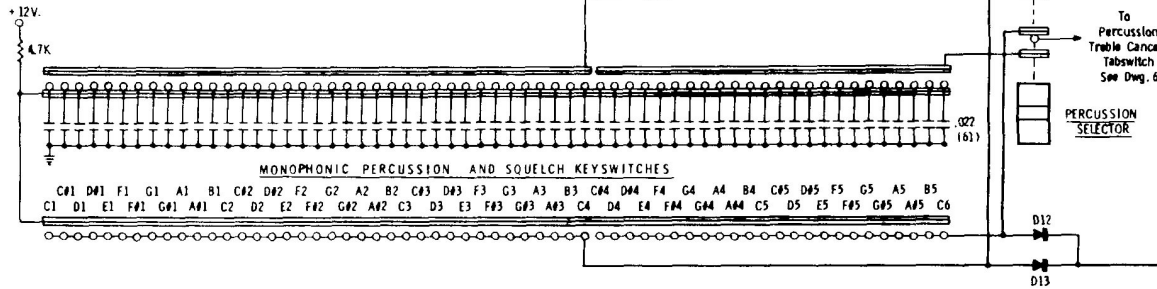

NOTES:

1. All resistors 1/2 watt 10% unless otherwise specified.
2. All capacitors are in microfarads unless otherwise specified.
3. All voltages measured to ground with a Simpson 260 VOM.
4. Winning's not everything, but losing is just plain nothing!
5. All keyswitches shown in "off" position.
6. See parts list for component part numbers.

SUSTAIN KEYSWITCHES
 PERCUSSION KEYSWITCHES &
 CLARINET / SHARP PREAMP
 PP 272
 Dwg. No. 4 PROFESSIONAL

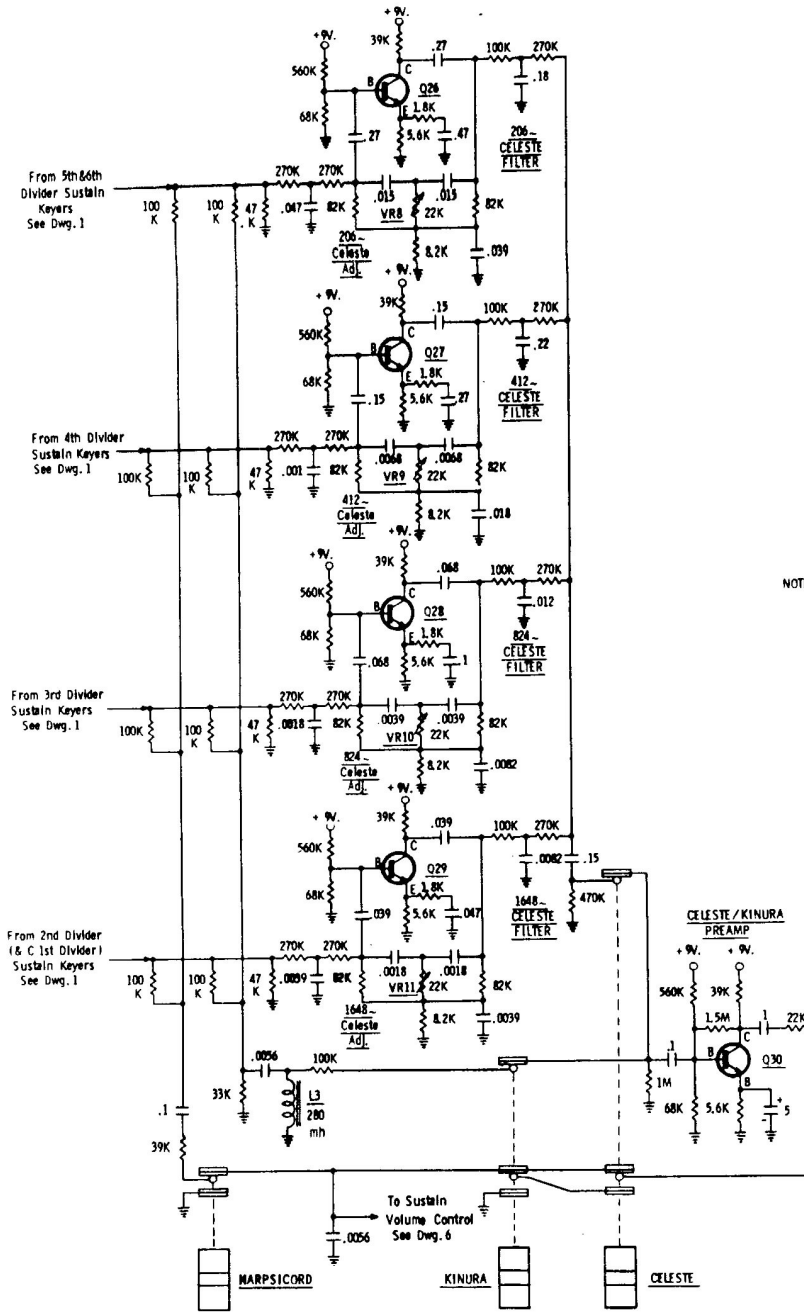
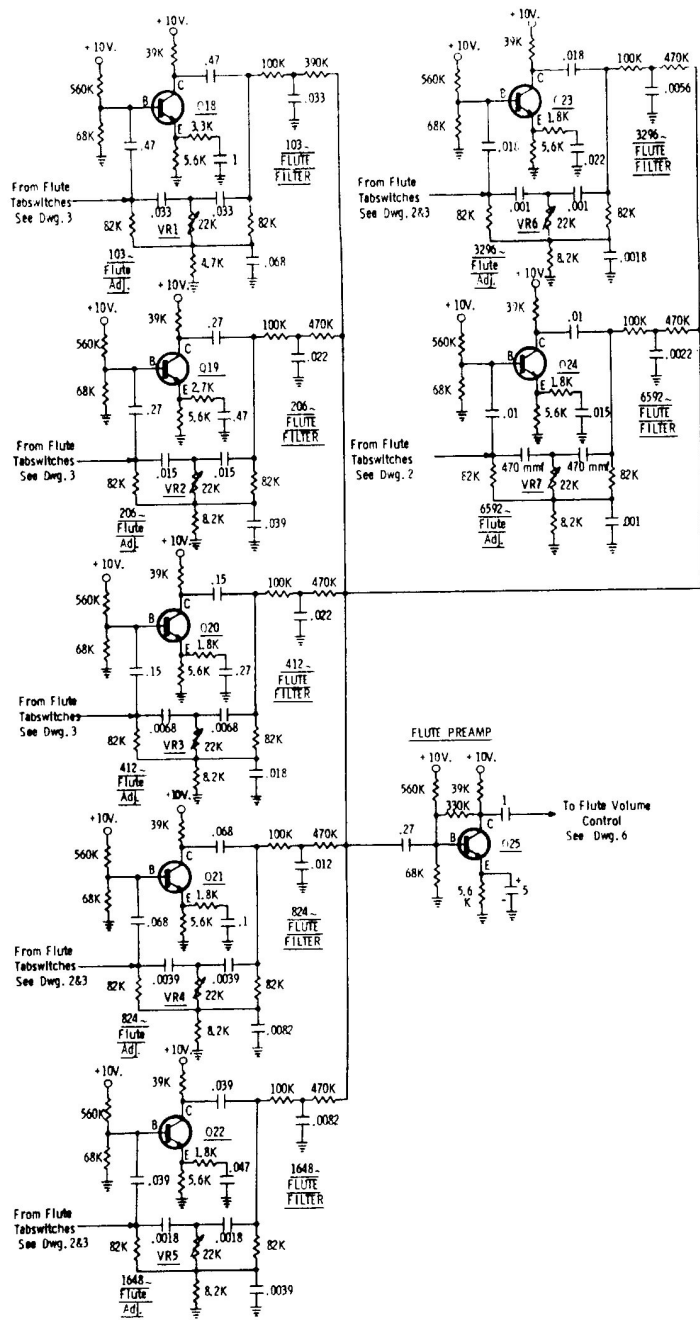

NOTE :

1. ALL RESISTORS 1/2 WATT 10% UNLESS OTHERWISE SPECIFIED.
2. ALL CAPACITORS ARE IN MICROFARADS UNLESS OTHERWISE SPECIFIED.
3. ALL VOLTAGES MEASURED TO GROUND WITH A SIMPSON 260 VOM.
4. EPITAPH ON A PESSIMIST'S HEADSTONE: "I EXPECTED THIS, AND HERE I AM."
5. SEE PARTS LIST FOR COMPONENT PART NUMBERS.
6. ALL TABSWITCHES SHOWN IN "ON" POSITION.

FLUTE FILTERS, CELESTE FILTERS, & PREAMPS
PP/222
Dwg. No. 5 PROFESSIONAL

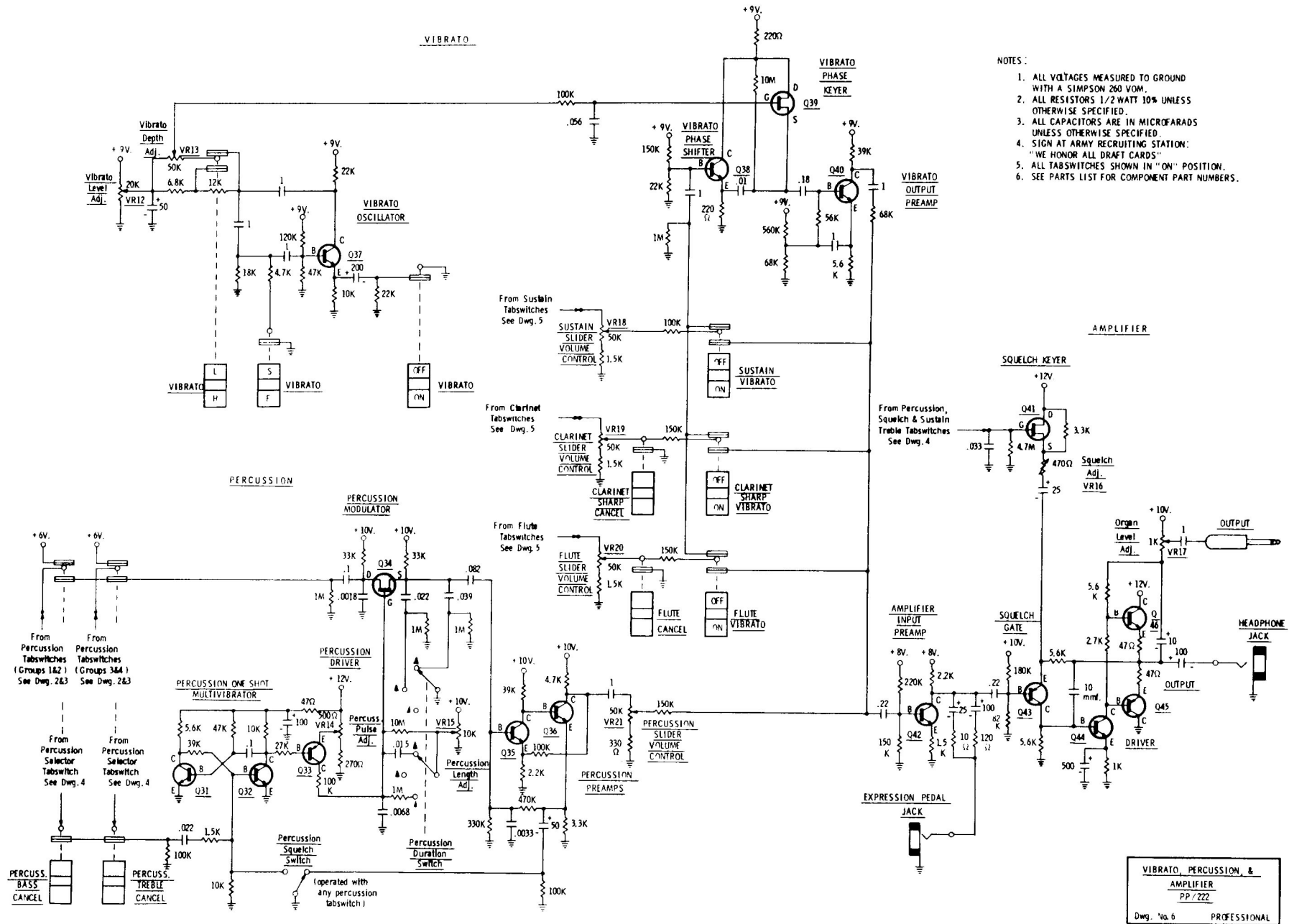

PROFESSIONAL

FRONT VIEW PROFESSIONAL

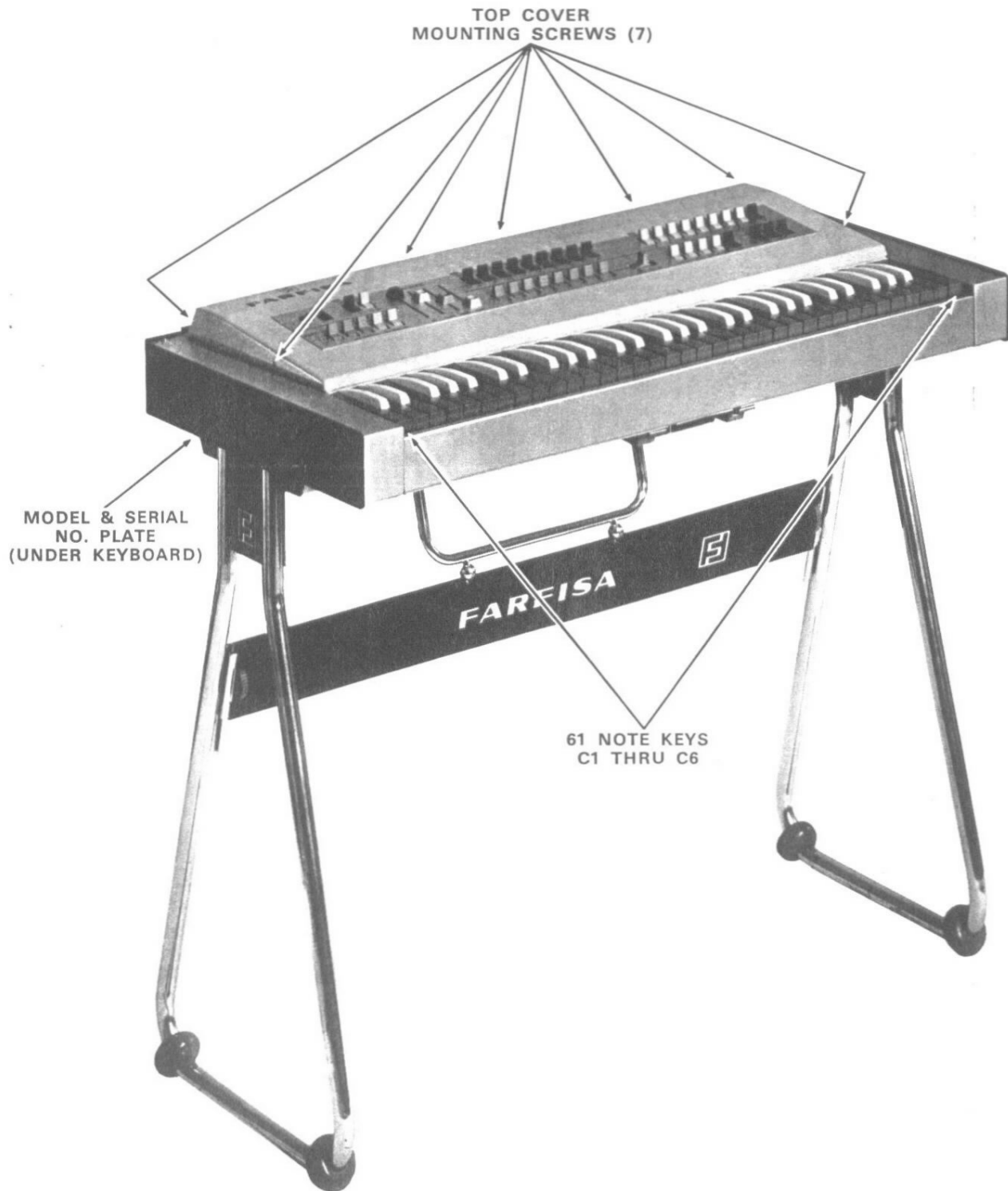

**FRONT VIEW
PROFESSIONAL
(Tabswitch Assembly Raised)**

VOLTAGE
REGULATOR
TRANSISTOR
Q49

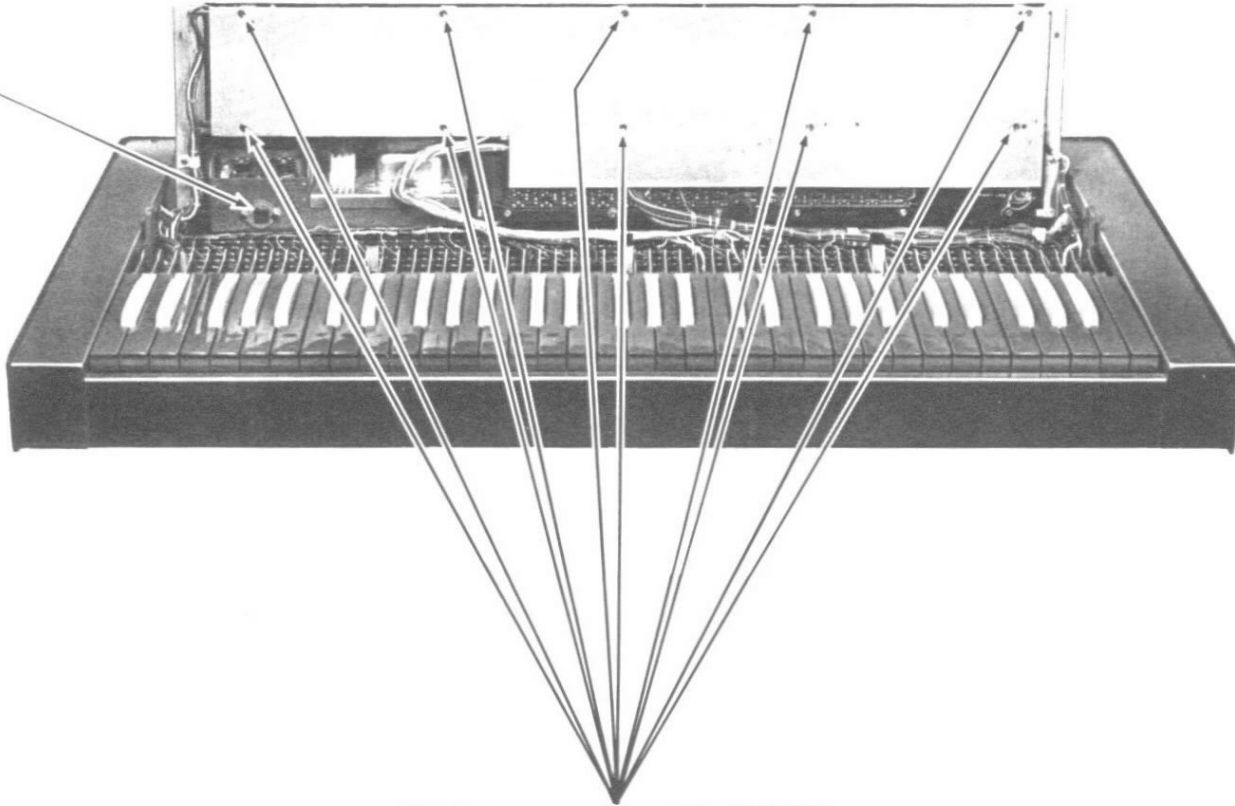

PRINTED CIRCUIT BOARD BOTTOM
COVER MOUNTING SCREWS (10)

TOP VIEW
(With Cover Removed)

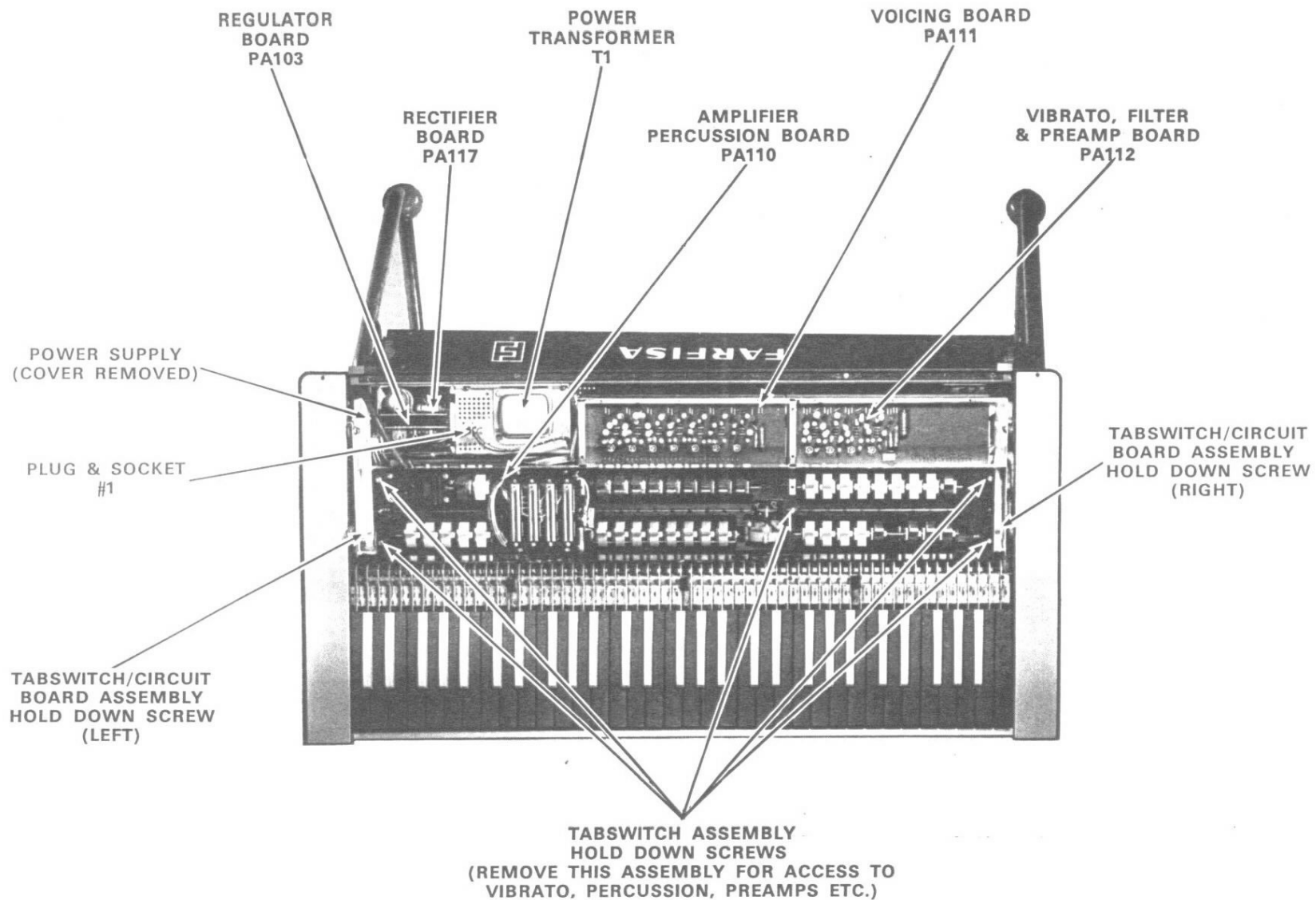

PROFESSIONAL

BOTTOM VIEW PROFESSIONAL

HEADPHONE
JACK

TONE GENERATOR ASSEMBLY
HOLD DOWN SCREWS(3)

BOTTOM PANEL
SCREW LOCATIONS (15)

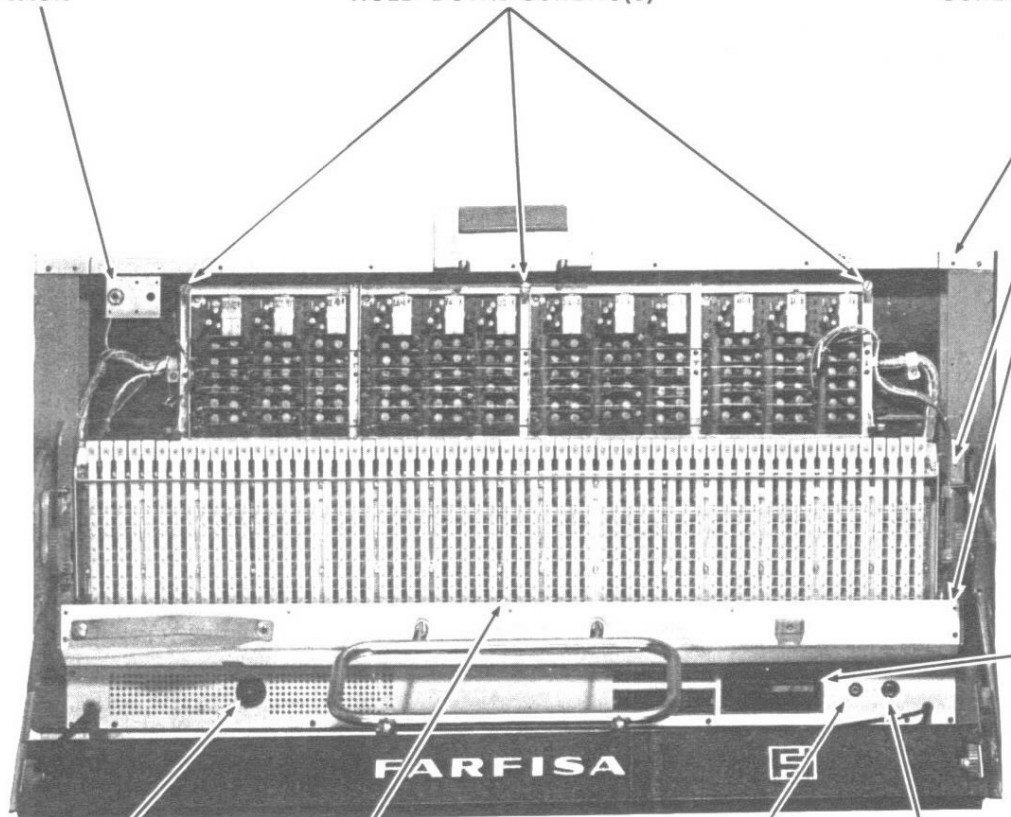

MODEL & SERIAL NO.
PLATE

.4 AMP
FUSE

KEYSWITCHES
TOP TO BOTTOM
PERCUSSION (MONO.)
PERCUSSION (POLY.)
SUSTAIN
16, 8, 5-1/3, 4, 2-2/3,
1-3/5 & 1-1/3

ORGAN LEVEL
ADJ. VR17

SWELL PEDAL
JACK

PROFESSIONAL

AMPLIFIER & PERCUSSION BOARD PROFESSIONAL (PA-110)

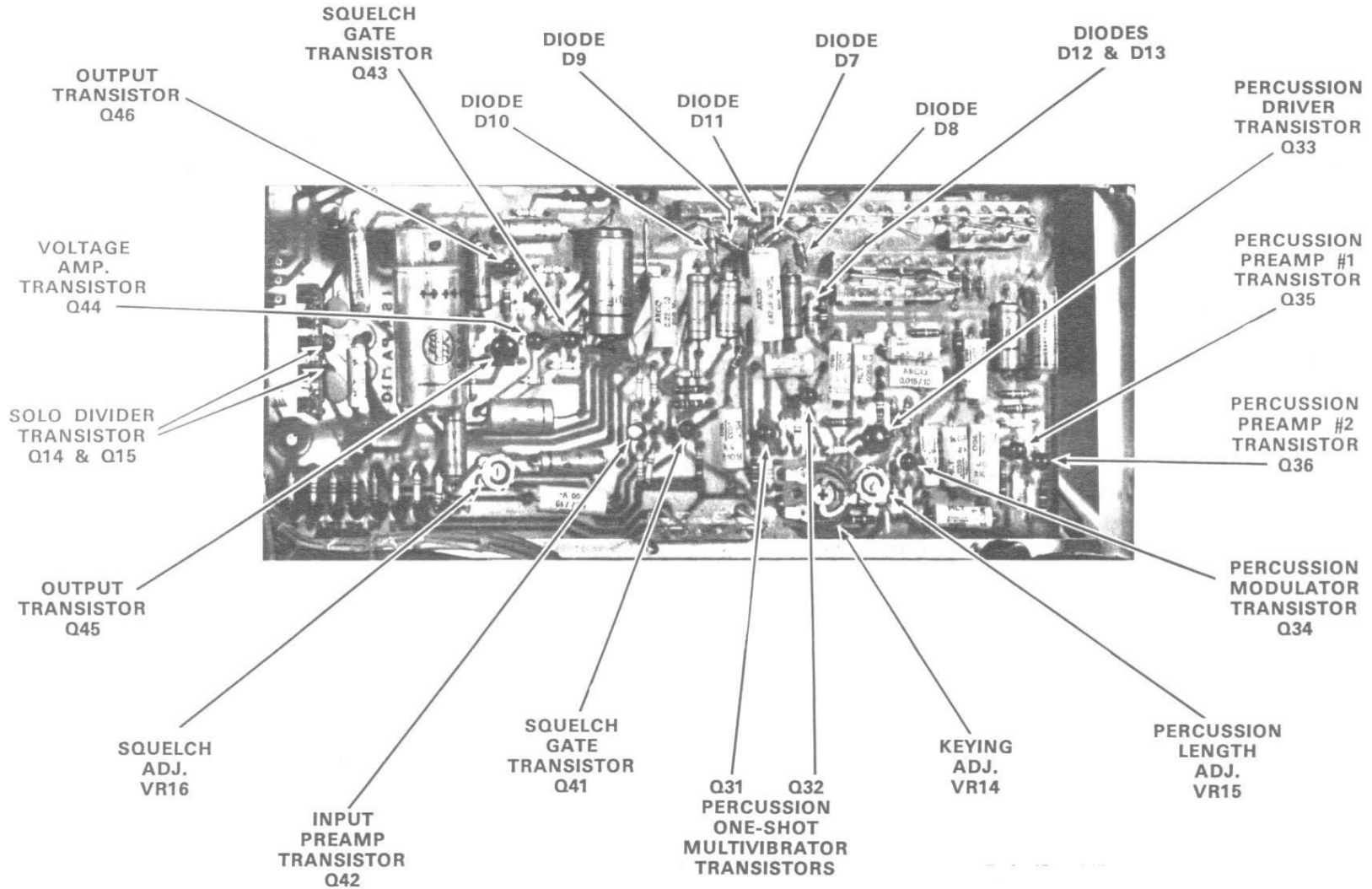

RECTIFIER BOARD PROFESSIONAL (PA-117)

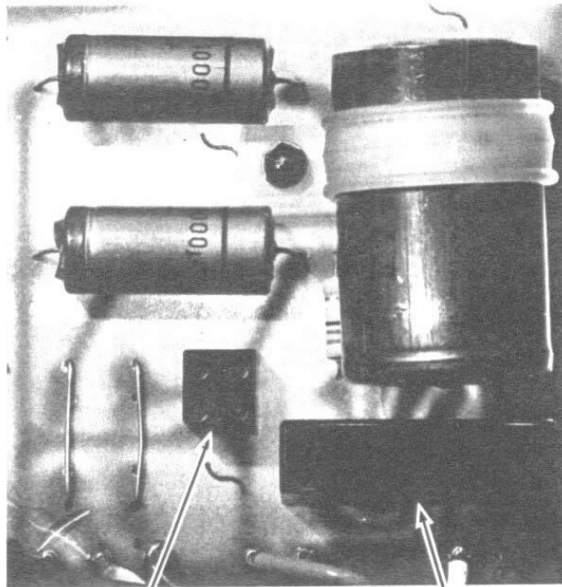

RECTIFIER
DIODES
D19-D22

RECTIFIER
DIODES
D15-D18

REGULATOR BOARD PROFESSIONAL (PA-103)

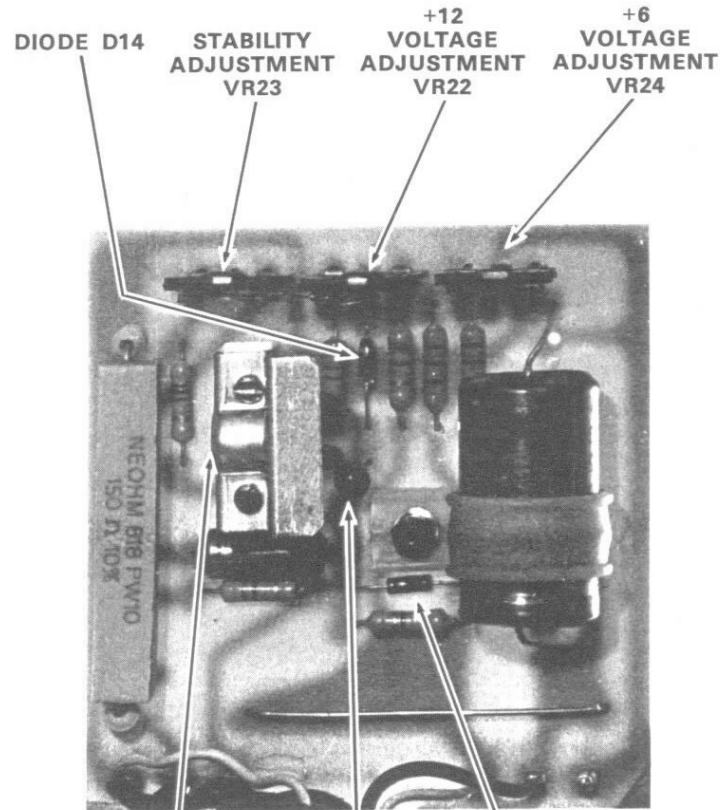

VOLTAGE
REGULATOR
TRANSISTOR
Q48

VOLTAGE
SENSOR
TRANSISTOR
Q47

ZENER DIODE
Z1

TONE GENERATOR BOARD (With Oscillator, Divider & Sustain Keyer Boards) PROFESSIONAL

1ST DIVIDER
TRANSISTORS
Q2 Q3

2ND DIVIDER
TRANSISTORS
Q4 Q5

3RD DIVIDER
TRANSISTORS
Q6 Q7

4TH DIVIDER
TRANSISTORS
Q8 Q9

5TH DIVIDER
TRANSISTORS
Q11 Q10

6TH DIVIDER
TRANSISTORS
Q13 Q12

OSCILLATOR
BOARD
(PA-73)

CAPACITOR C4

CAPACITOR C1

CAPACITOR C3

CAPACITOR C2

MASTER
OSCILLATOR
TRANSISTOR
Q1

1 & 2

3

4

5 & 6

SUSTAIN GROUP
BUSS BARS

TONE GENERATOR
BOARD (PA-76)

DIVIDER
BOARDS
(PA-74)

SUSTAIN KEYS
BOARD (PA-75)

SUSTAIN
DIODES D1

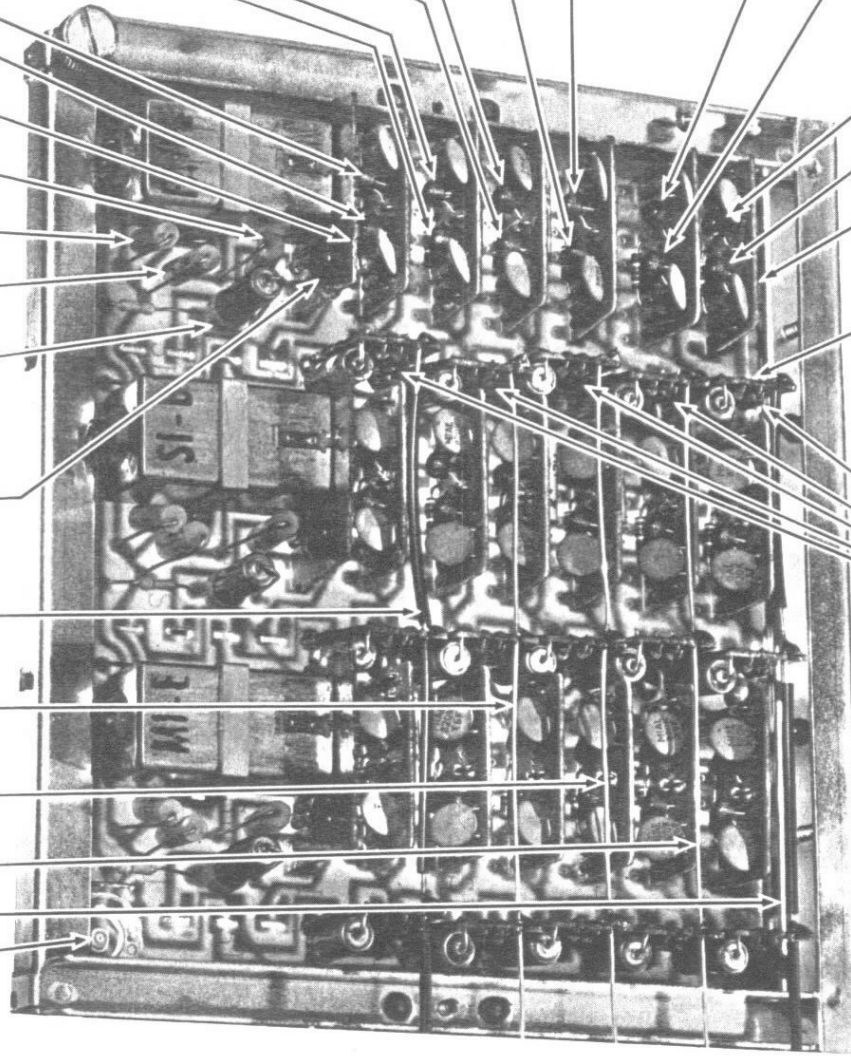

VIBRATO, FILTER & PREAMP BOARD (PA-112) & VOICING BOARD (PA-111) PROFESSIONAL

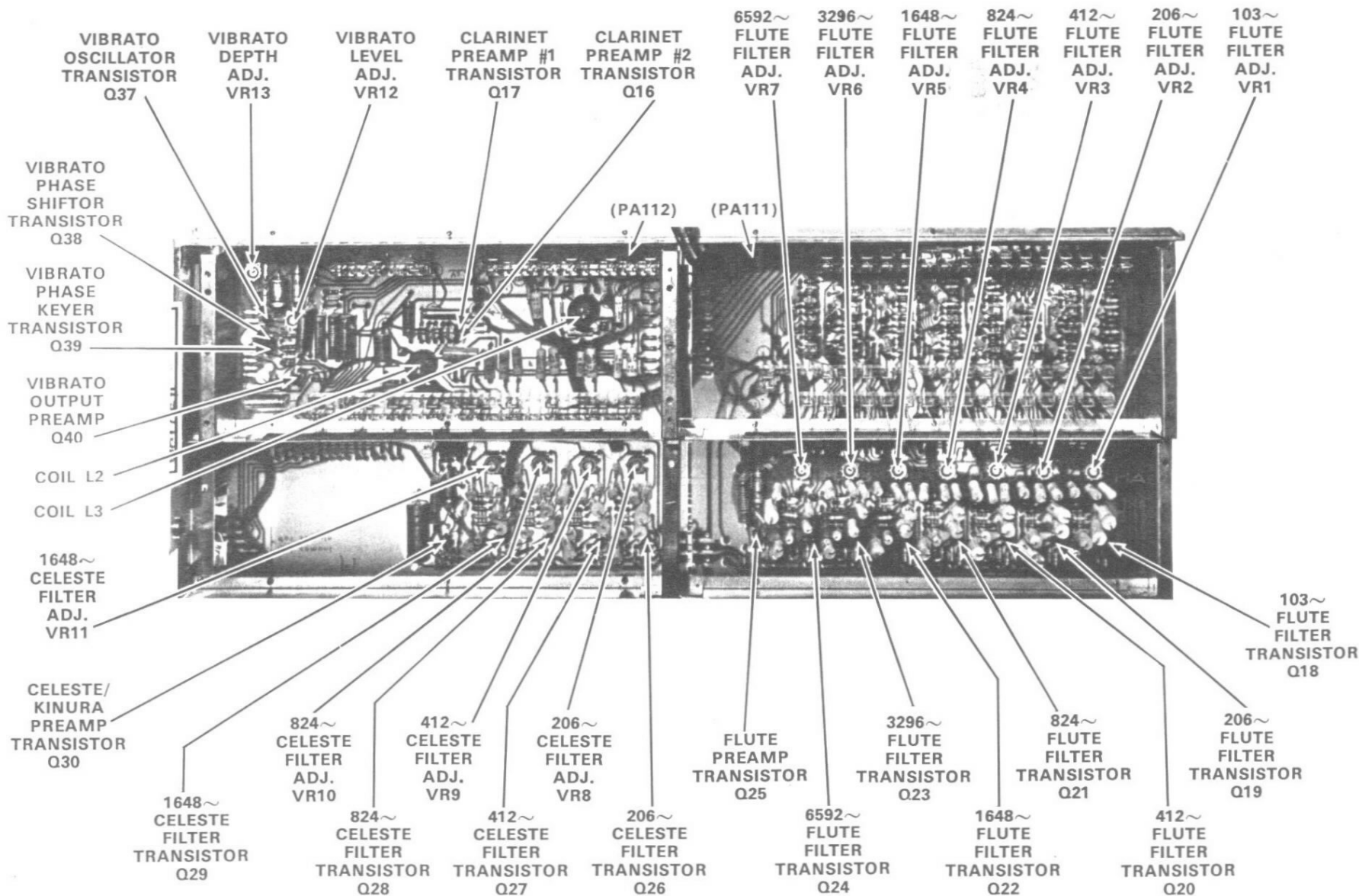

PARTS INFORMATION

STANDARD PARTS

Replacements for all standard electronic parts and hardware may be purchased directly from local suppliers generally in less time than would be required to obtain them from the factory.

SPECIAL PARTS

In addition to the standard replacement parts, special electronic and mechanical parts are also used. These parts are manufactured by and to the specifications of the factory. Order these parts directly from the factory since they would be difficult or impossible to obtain from other sources.

PARTS ORDERING INFORMATION

When ordering parts be sure to include the following information:

1. Model and Serial Number
2. Part Number
3. A description of the part
4. Specify how you want the part shipped.

Most special electronic parts and mechanical parts will have a part number stamped on them. In the

event that the part number is missing, or you are unable to read the part number, a complete description of the part and where it is used will allow the factory to fill your parts order. When parts are ordered in the proper manner the factory is able to fill your orders promptly—delays that might result are avoided.

ADDRESS PARTS ORDERS TO:

C.M.I. SERVICE DEPT.
7373 No. Cicero Ave.
Chicago, Illinois 60646

IMPORTANT

IN ANY CORRESPONDENCE CONCERNING
THIS INSTRUMENT ALWAYS INCLUDE
MODEL AND SERIAL NUMBERS

PARTS LIST

THE PARTS LIST CONTAINS THE FOLLOWING INFORMATION:

1. Name of Part
2. Value, Tolerance and Code (when important)
3. Brief description
4. Where the part is found (assembly, printed circuit board and etc.)
5. Schematic Reference Number
6. PART NUMBER — USE IT!

This parts list includes all standard stock replacement parts. No attempt has been made to include every nut, bolt and screw. If the necessity for a non-listed part arises, please write describing the part's location and function as well as model and serial number of the unit.

PROFESSIONAL

PART	DESCRIPTION	SCHEMATIC REFERENCE	PART NUMBER
KEYSWITCH ASSEMBLY			
Actuator	Keyswitch (White Plastic).....		964-013065
Contact	Spring		975-013051
Key	C Natural Gray with metal channel.....		964-013065-C
Key	C# Natural Gray with metal channel.....		964-013065-C#
Key	D Natural Gray with metal channel.....		964-013065-D
Key	D# Natural Gray with metal channel.....		964-013065-D#
Key	E Natural Gray with metal channel.....		964-013065-E
Key	F Natural Gray with metal channel.....		964-013065-F
Key	F# Natural Gray with metal channel.....		964-013065-F#
Key	G Natural Gray with metal channel.....		964-013065-G
Key	G# Natural Gray with metal channel.....		964-013065-G#
Key	A Natural Gray with metal channel.....		964-013065-A
Key	A# Natural Gray with metal channel.....		964-013065-A#
Key	B Natural Gray with metal channel.....		964-013065-B
Key	All Sharps (White) with metal channel.....		964-013066
Spring	Pull Down		975-013050

POWER SUPPLY CHASSIS

Assembly	Rectifier Board (PA-117).....		996-013078
Capacitor	Regulator Board (PA-103).....		996-013057
Capacitor	Electrolytic 5 UF 40V.....		945-011203-41
Capacitor	Electrolytic 1000 UF 12V.....		945-011203-21
Capacitor	Electrolytic 2000 UF 30V.....		945-011203-42
Capacitor	Electrolytic 2000 UF 12V.....		954-011203-26
Diode	Keying	D14	919-013081
Diode	Rectifier (Semikron B40C3200/2200).....	D15-18	919-013079
Diode	Zener	Z1	919-013083
Fuse	4/10 Amp		939-013065
Holder	Fuse		906-006303
Potentiometer	470 Ohm Voltage Adj.....	VR22, 24	925-013059
Potentiometer	47K Stability Adj.....	VR23	925-013060
Resistor	150 Ohm 10W (Neoohm 737).....		924-013062
Transistor	Voltage Sensor (1W9640).....	Q47	991-011225
Transistor	Voltage Regulator (BC114).....	Q48	991-011219
Transistor	Voltage Regulator (RCA 2N5036).....	Q49	991-013063
Transformer	Power (T-1048)	T1	954-013081

TABSWITCH ASSEMBLY

Actuator	Tabswitch (White Plastic).....		964-013073
Contact	Spring		917-013074
Knob	Volume Slider (Dark Green)		925-013061-1
Knob	Volume Slider (Light Green)		925-013061-2
Knob	Volume Slider (Orange)		925-013061-3
Knob	Volume Slider (Yellow)	VR18-21	925-013061-4
Potentiometer	Slide-Volume Balance		925-013077
Tab	Blue		915-013075-1
Tab	Green		915-013075-2
Tab	Light Green		915-013075-3
Tab	Yellow		915-013075-4
Tab	Orange		915-013075-5
Tab	Percussion Duration (3 Position).....		915-013076
Switch	Percussion Duration (3 Position).....		960-013090
Switch	Percussion Squelch		960-013091

PROFESSIONAL

PART	DESCRIPTION	SCHEMATIC REFERENCE	PART NUMBER
TONE GENERATOR BOARD			
Assembly	Oscillator Board (PA-73).....	997-013086
Assembly	Divider Board (PA-74).....	997-013087
Assembly	Sustain Board (PA-75).....	997-013088
Assembly	Tone Generator Board (PA-76) (3 Notes).....	996-013070
Capacitor	1 UF 40V.....	945-011203-1
Capacitor	50 UF 25V.....	945-011203-9
Coil	Tuning (F#-B) T-4023.....	L1.....	952-013085-1
Coil	Tuning (C-F) T-4024.....	L1.....	952-013085-2
Diode	Keying (1809).....	D1.....	919-013067
Transistor	Master Oscillator (1W9810).....	Q1.....	991-011319
Transistor	Divider (1W9787).....	Q2-13.....	991-011318

VIBRATO, FILTER & PREAMP BOARD

Assembly	Vibrato, Filter & Preamp Board (PA-112).....	996-013035
Capacitor	Electrolytic 50 UF 6V.....	945-011203-37
Capacitor	Electrolytic 50 UF 25V.....	945-011203-9
Capacitor	Electrolytic 200 UF 6V.....	945-011203-38
Capacitor	Electrolytic 500 UF 6V.....	945-011203-40
Coil	220 MH (18/11-3H1).....	L2, 3.....	952-013022
Potentiometer	20K Vibrato Level.....	VR12.....	925-013084
Potentiometer	50K Vibrato Depth.....	VR13.....	925-011233
Transistor	Ciarinet/Sharp Preamp & Vibrato Osc. (1W9787)	Q16, 17, 37.....	991-011318
Transistor	Vibrato Phase Shifter & Output Preamp (BC114)	Q38, 40.....	991-013044
Transistor	Vibrato Phase Keyer (E103).....	Q39.....	991-013055

VOICING BOARD

Assembly	Voicing Board (PA-111).....	996-013071
Capacitor	1 UF 12V.....	945-011203-1
Capacitor	5 UF 12V.....	945-011203-27
Capacitor	1000 UF 12V.....	945-011203-21
Potentiometer	22K Filter Adj.....	VR1-11.....	925-011329
Transistor	Flute & Celeste Filters & Flute Preamp (BC114)	Q18-29.....	991-013044
Transistor	Celeste/Kinura Preamp.....	Q30.....	991-013068