



POD X3

Service Manual



ECOs INCLUDED ON THIS SCHEMATIC/PCB REVISION		
ECO NO:	DATE:	DESCRIPTION:
0722606	08.14.07	Released as rev.C - moved C170 so it can be bent over and not hit chassis.
0725503	09.12.07	Released as rev.D - DSP to 1.27V mic taper to Audio, LCD backlight

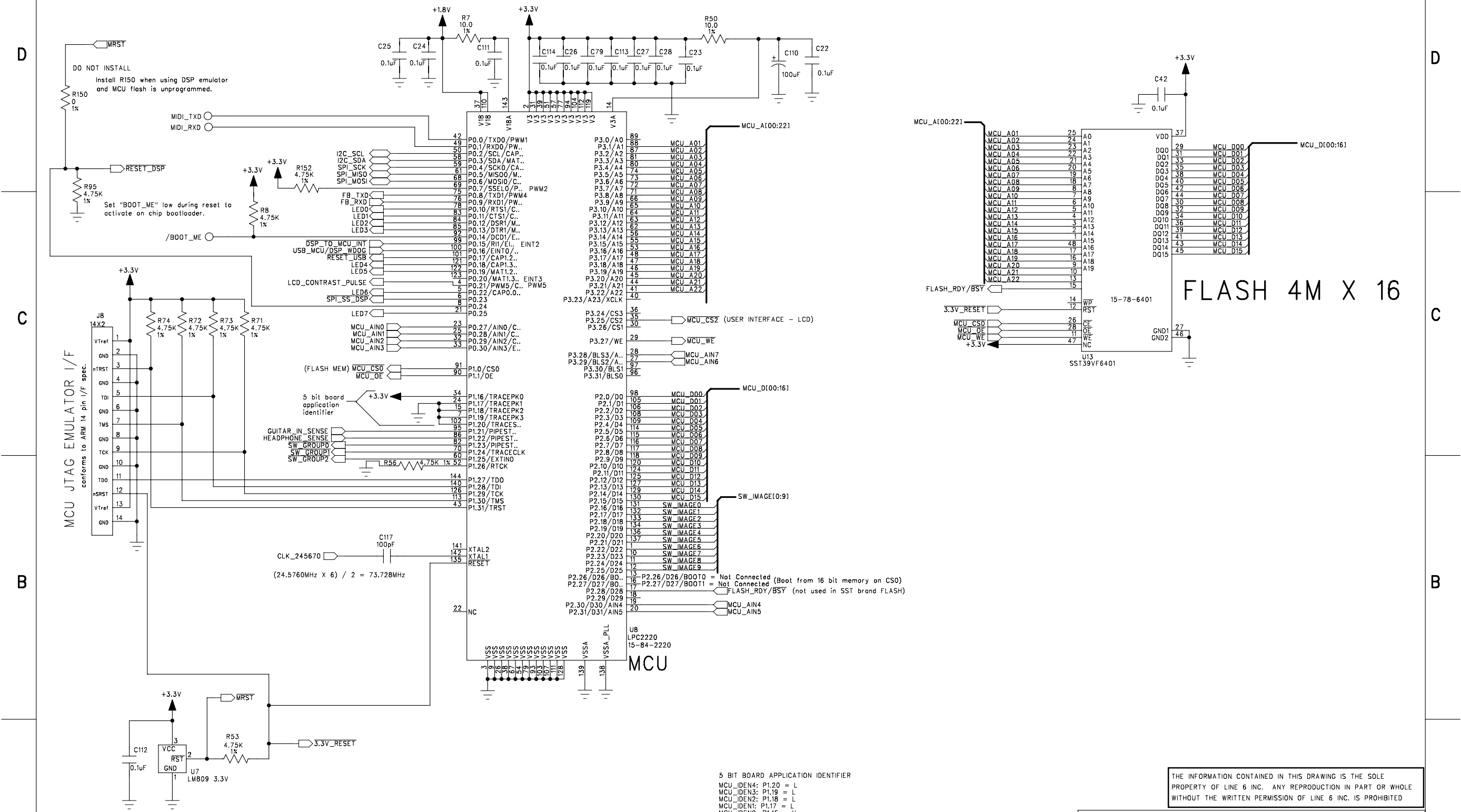

THE INFORMATION CONTAINED IN THIS DRAWING IS THE SOLE PROPERTY OF LINE 6 INC. ANY REPRODUCTION IN PART OR WHOLE WITHOUT THE WRITTEN PERMISSION OF LINE 6 INC. IS PROHIBITED

5 BIT BOARD APPLICATION IDENTIFIER
 MCU_IDEN4: P1.20 = L
 MCU_IDEN3: P1.19 = L
 MCU_IDEN2: P1.18 = L
 MCU_IDEN1: P1.17 = L
 MCU_IDEN0: P1.16 = H
 POD TNG = 0x01

This board: All resistors are 1% Tolerance

**PRELIMINARY DRAWINGS
 FOR QUOTATION PURPOSES ONLY
 DO NOT USE FOR PRODUCTION**

DRAWN: D. MOLNAR
 CHECKED: review panel

DATED: 01.31.2007
 DATED:

COMPANY:		LINE 6	
TITLE: P10: POD TNG			
PROGRAM: PADS LOGIC 2004			REV: D
FILENAME:			
SCALE: 1:1	SIZE: C	PART NUMBER: 35-00-0079	SHEET: 1 of 10

6 5 4 3 2 1

ECOs INCLUDED ON THIS SCHEMATIC/PCB REVISION		
ECO NO:	DATE:	DESCRIPTION:

USB SECTION

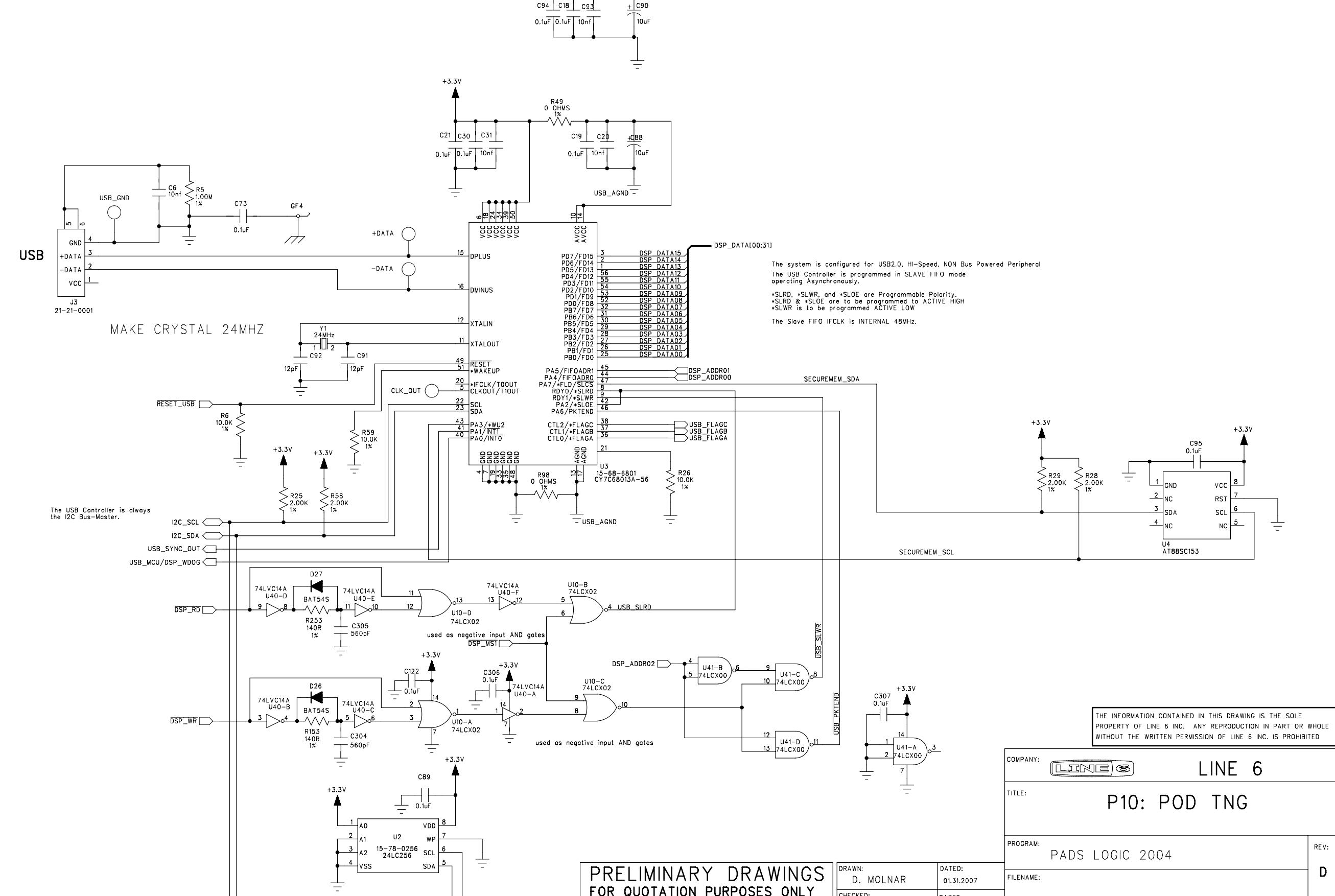

THE INFORMATION CONTAINED IN THIS DRAWING IS THE SOLE PROPERTY OF LINE 6 INC. ANY REPRODUCTION IN PART OR WHOLE WITHOUT THE WRITTEN PERMISSION OF LINE 6 INC. IS PROHIBITED

COMPANY:	LINE 6
TITLE:	P10: POD TNG
PROGRAM:	PADS LOGIC 2004
REV:	D
SCALE: 1:1	SIZE: C
PART NUMBER: 35-00-0079	SHEET: 3 of 10

PRELIMINARY DRAWINGS FOR QUOTATION PURPOSES ONLY DO NOT USE FOR PRODUCTION

DRAWN:	D. MOLNAR	DATED:	01.31.2007
CHECKED:	review panel	DATED:	

POTENTIOMETERS

ECOs INCLUDED ON THIS SCHEMATIC/PCB REVISION		
ECO NO:	DATE:	DESCRIPTION:

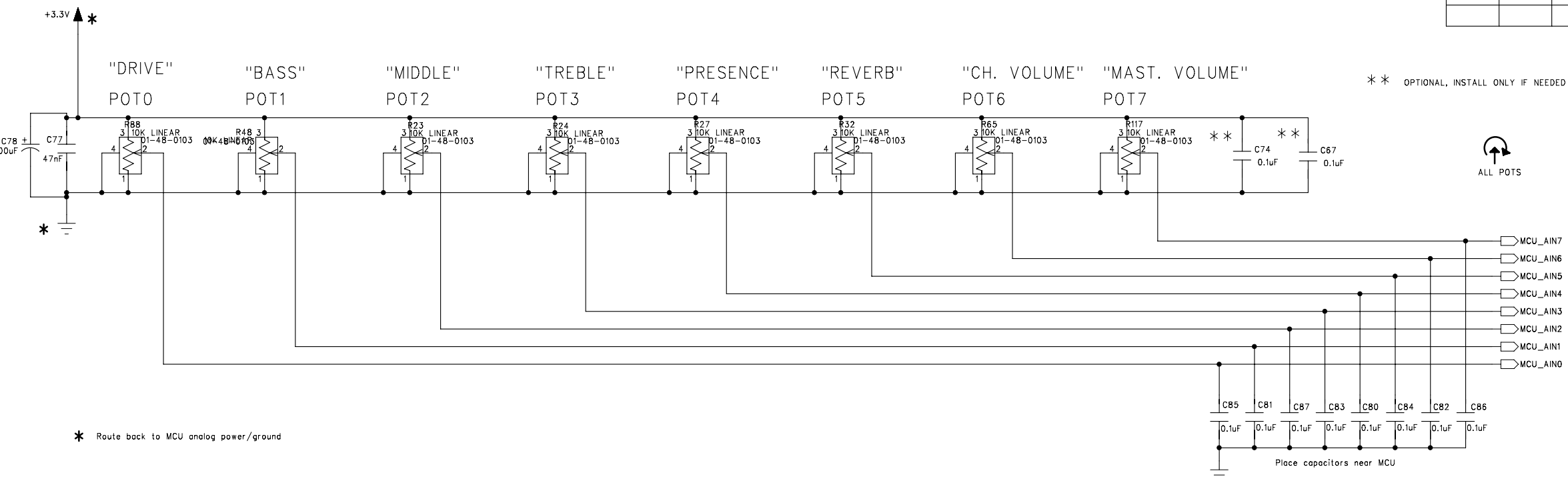

LEDS

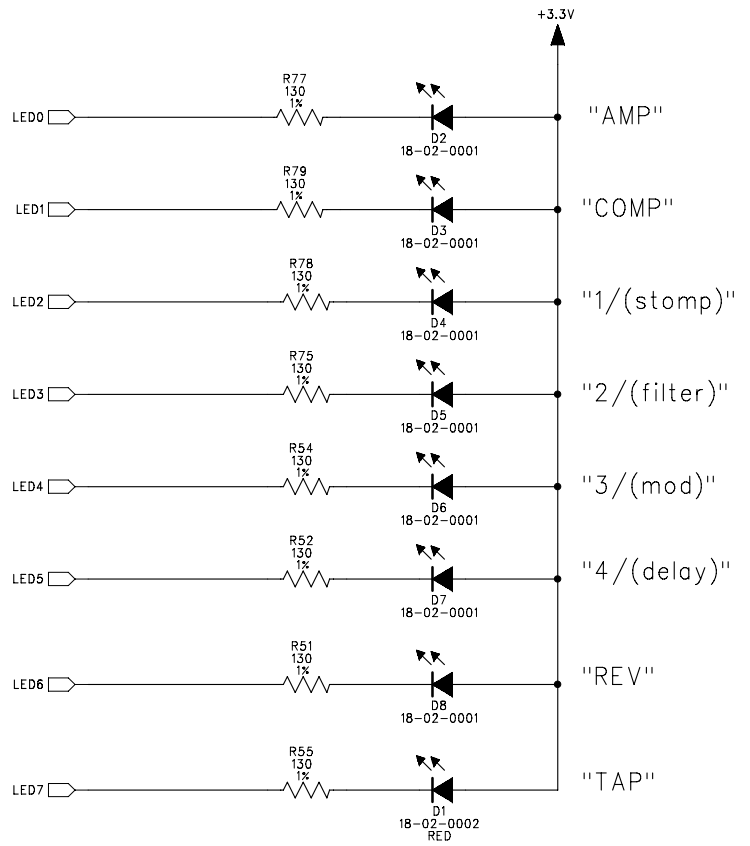

THE INFORMATION CONTAINED IN THIS DRAWING IS THE SOLE PROPERTY OF LINE 6 INC. ANY REPRODUCTION IN PART OR WHOLE WITHOUT THE WRITTEN PERMISSION OF LINE 6 INC. IS PROHIBITED

COMPANY:	LINE 6
TITLE:	P10: POD TNG
PROGRAM:	PADS LOGIC 2004
REV:	D
SCALE: 1:1	SIZE: C
PART NUMBER: 35-00-0079	SHEET: 4 of 10

**PRELIMINARY DRAWINGS
FOR QUOTATION PURPOSES ONLY
DO NOT USE FOR PRODUCTION**

DRAWN:	D. MOLNAR	DATED:	0131.2007
CHECKED:	review panel	DATED:	

6 5 4 3 2 1

ECOs INCLUDED ON THIS SCHEMATIC/PCB REVISION		
ECO NO:	DATE:	DESCRIPTION:

SWITCHES

Pullup resistors are not needed because the LPC2210 has built in pullup resistors in its I/O pins

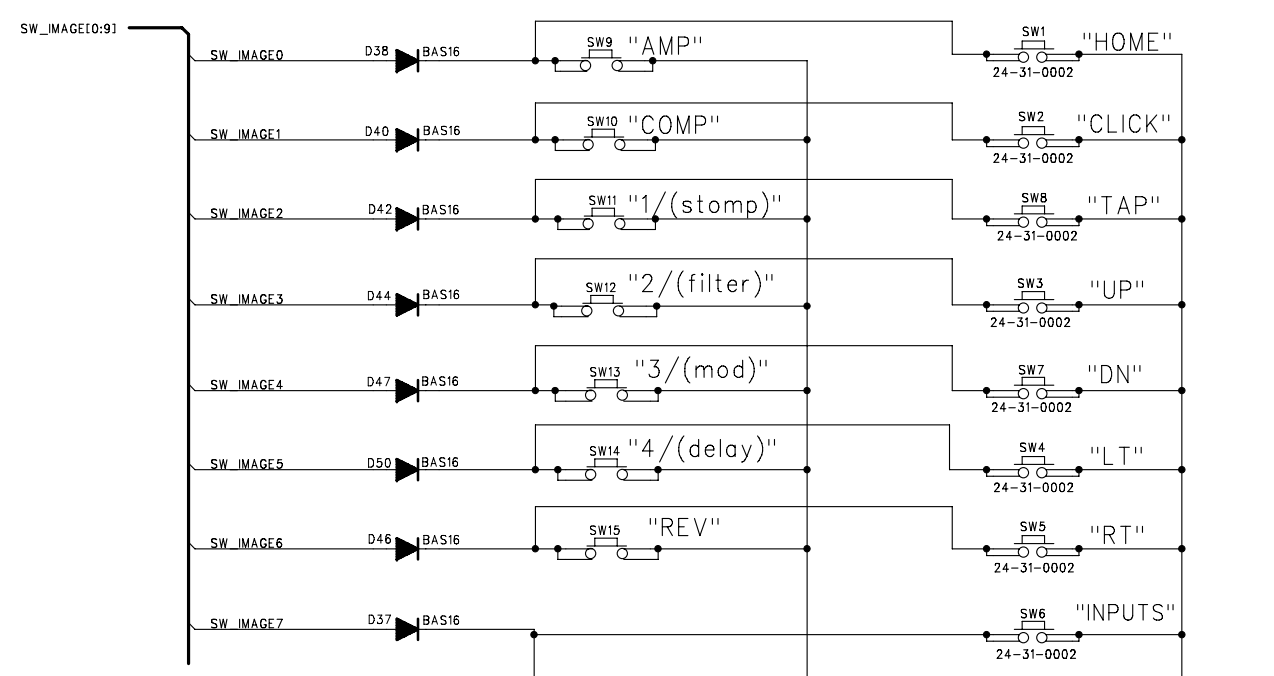

ENCODERS

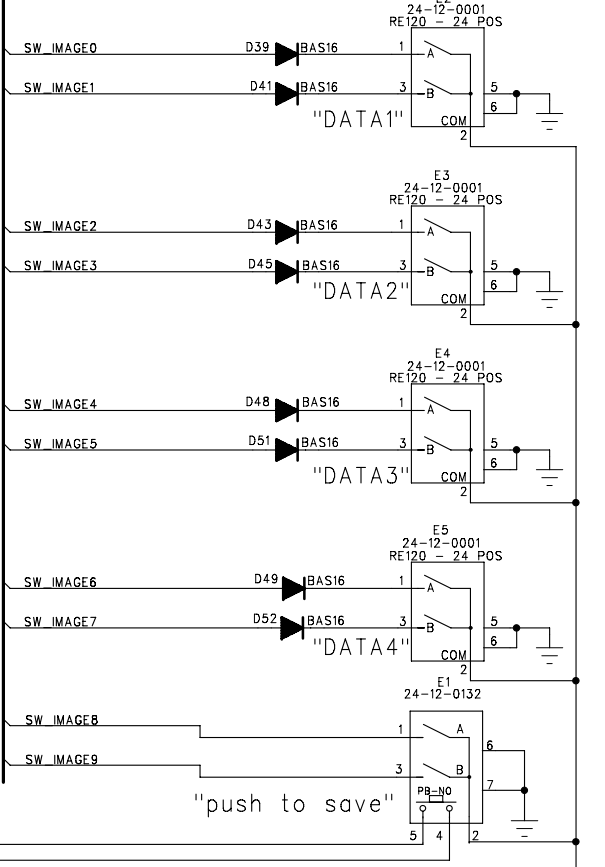

SWITCH MATRIX 10 X 3

	SW_GROUP0	SW_GROUP1	SW_GROUP2
SW_IMAGE0	AMP	HOME	E1-A
SW_IMAGE1	COMP	CLICK	E1-B
SW_IMAGE2	1/(stomp)	TAP	E2-A
SW_IMAGE3	2/(filter)	UP	A2-B
SW_IMAGE4	3/(mod)	DN	E3-A
SW_IMAGE5	4/(delay)	LT	E3-B
SW_IMAGE6	REV	RT	E4-A
SW_IMAGE7	E5 pushbutton	INPUTS	E4-B
SW_IMAGE8			E5-A
SW_IAMGE9			E5-B

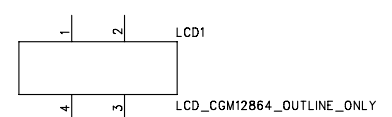
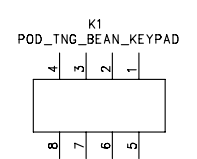

LCD MODULE AND SUPPORT CIRCUITRY

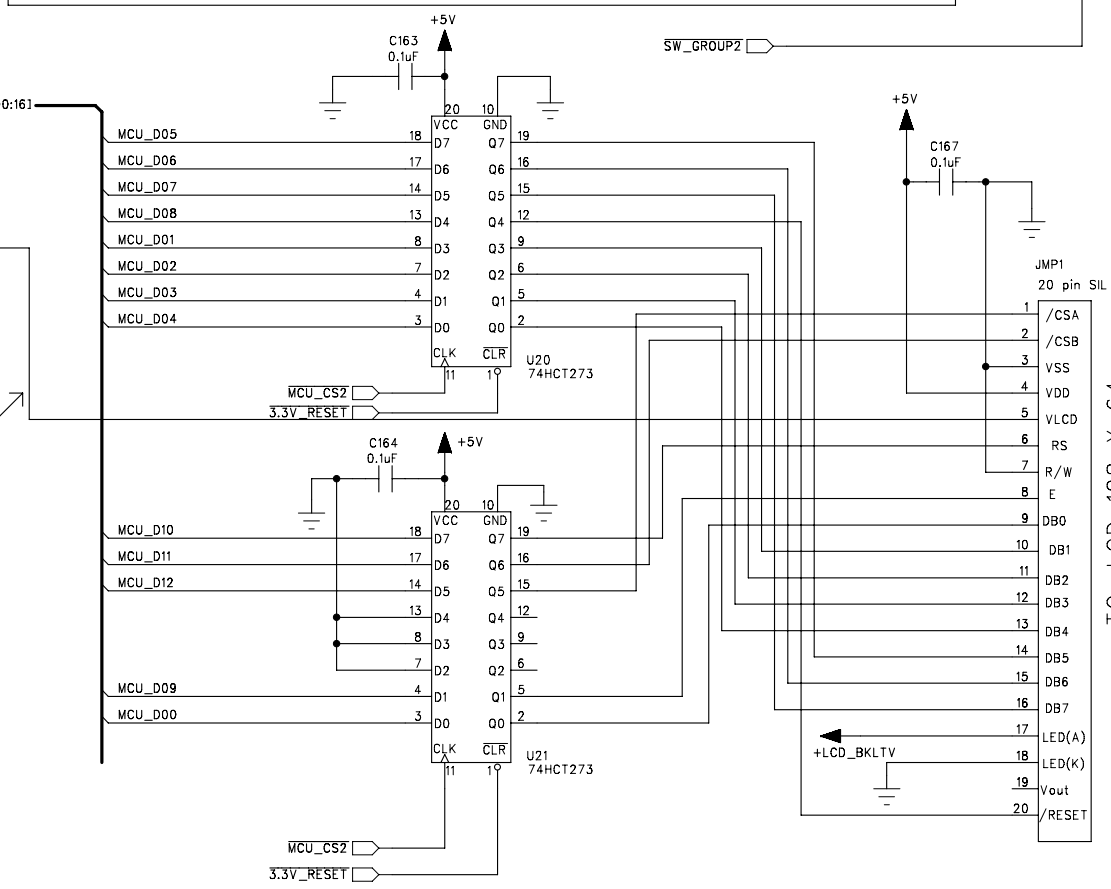
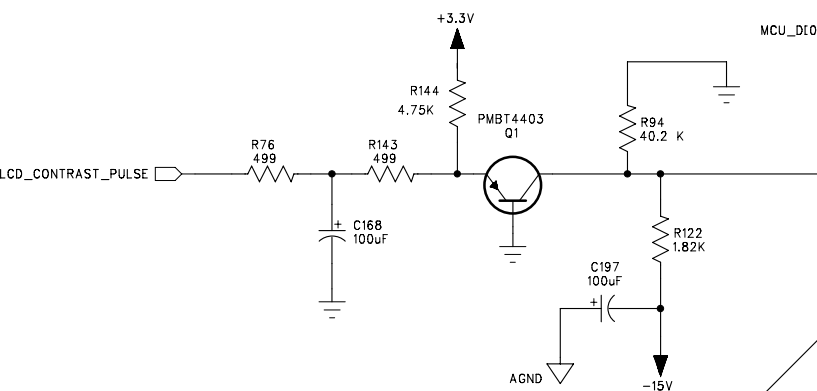

MCU TO LCD CONTROLS		
MCU_DXX	LCD	LCD PIN
D0	DB0	9
D1	DB1	10
D2	DB2	11
D3	DB3	12
D4	DB4	13
D5	DB4	14
D6	DB6	15
D7	DB7	16
D8	/RESET	20
D9	E	8
D10	RS	6
D11	/CSB	2
D12	/CSA	1

THE INFORMATION CONTAINED IN THIS DRAWING IS THE SOLE PROPERTY OF LINE 6 INC. ANY REPRODUCTION IN PART OR WHOLE WITHOUT THE WRITTEN PERMISSION OF LINE 6 INC. IS PROHIBITED

COMPANY: **LINE 6**

TITLE: **P10: POD TNG**

PROGRAM: PADS LOGIC 2004

FILENAME: _____

SCALE: 1:1 SIZE: C PART NUMBER: 35-00-0079 SHEET: 5 of 10

PRELIMINARY DRAWINGS FOR QUOTATION PURPOSES ONLY DO NOT USE FOR PRODUCTION

DRAWN: D. MOLNAR	DATED: 01.31.2007
CHECKED: review panel	DATED: _____

D
C
B
A

S/PDIF OUTPUT

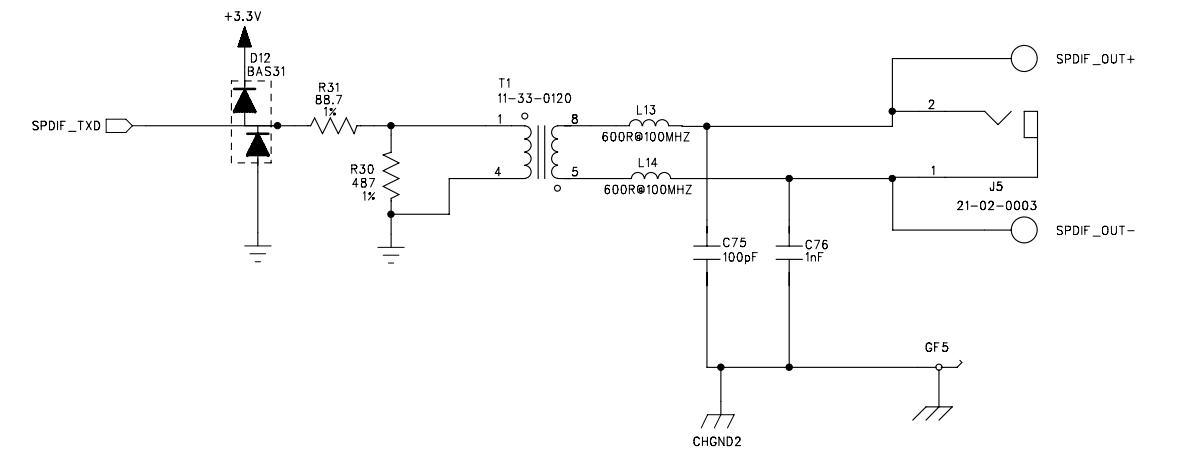

S/PDIF OUTPUT
 Vout = .5Vpp NOM
 Zout = 75ohm NOM

ECOs INCLUDED ON THIS SCHEMATIC/PCB REVISION		
ECO NO:	DATE:	DESCRIPTION:

FBV CLASS INTERFACE

FBV CLASS RJ-45 I/F

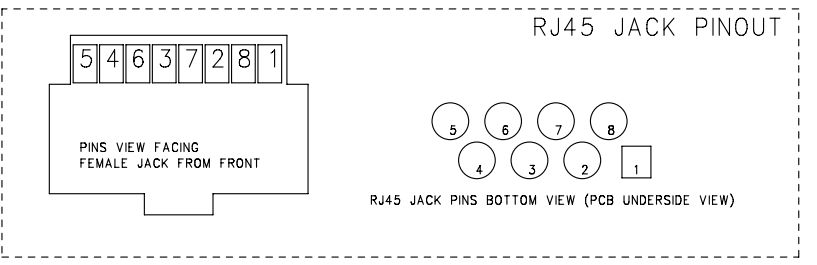
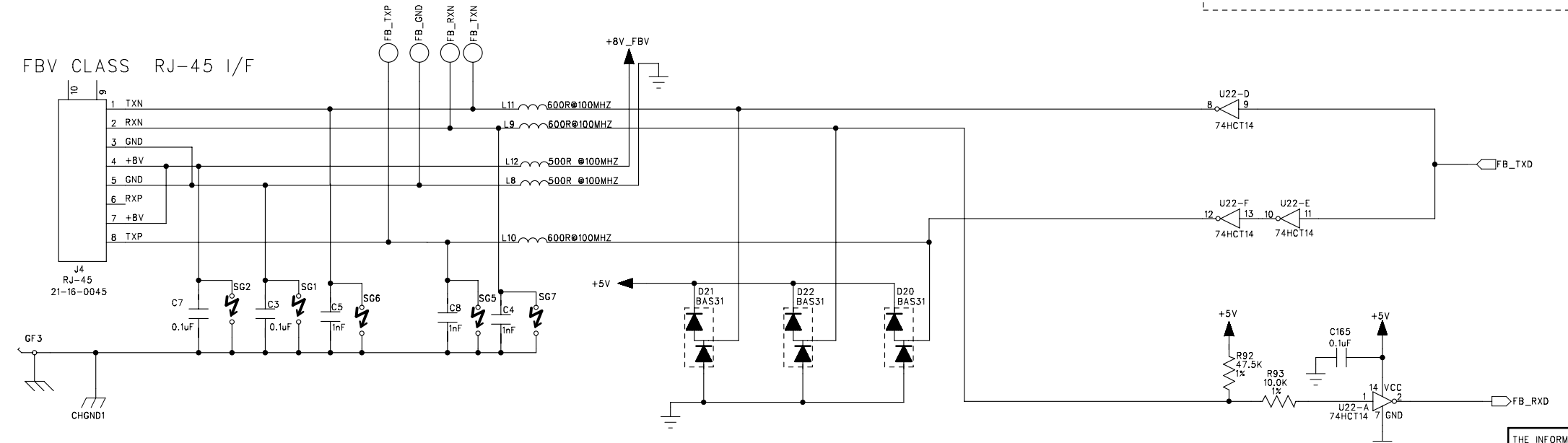

THE INFORMATION CONTAINED IN THIS DRAWING IS THE SOLE PROPERTY OF LINE 6 INC. ANY REPRODUCTION IN PART OR WHOLE WITHOUT THE WRITTEN PERMISSION OF LINE 6 INC. IS PROHIBITED

COMPANY:	LINE 6
TITLE:	P10: POD TNG
PROGRAM:	PADS LOGIC 2004
FILENAME:	
REV:	D
SCALE: 1:1	SIZE: C
PART NUMBER: 35-00-0079	SHEET: 6 OF 10

PRELIMINARY DRAWINGS
 FOR QUOTATION PURPOSES ONLY
 DO NOT USE FOR PRODUCTION

DRAWN:	D. MOLNAR	DATED:	01.31.2007
CHECKED:	review panel	DATED:	

ECOs INCLUDED ON THIS SCHEMATIC/PCB REVISION		
ECO NO:	DATE:	DESCRIPTION:

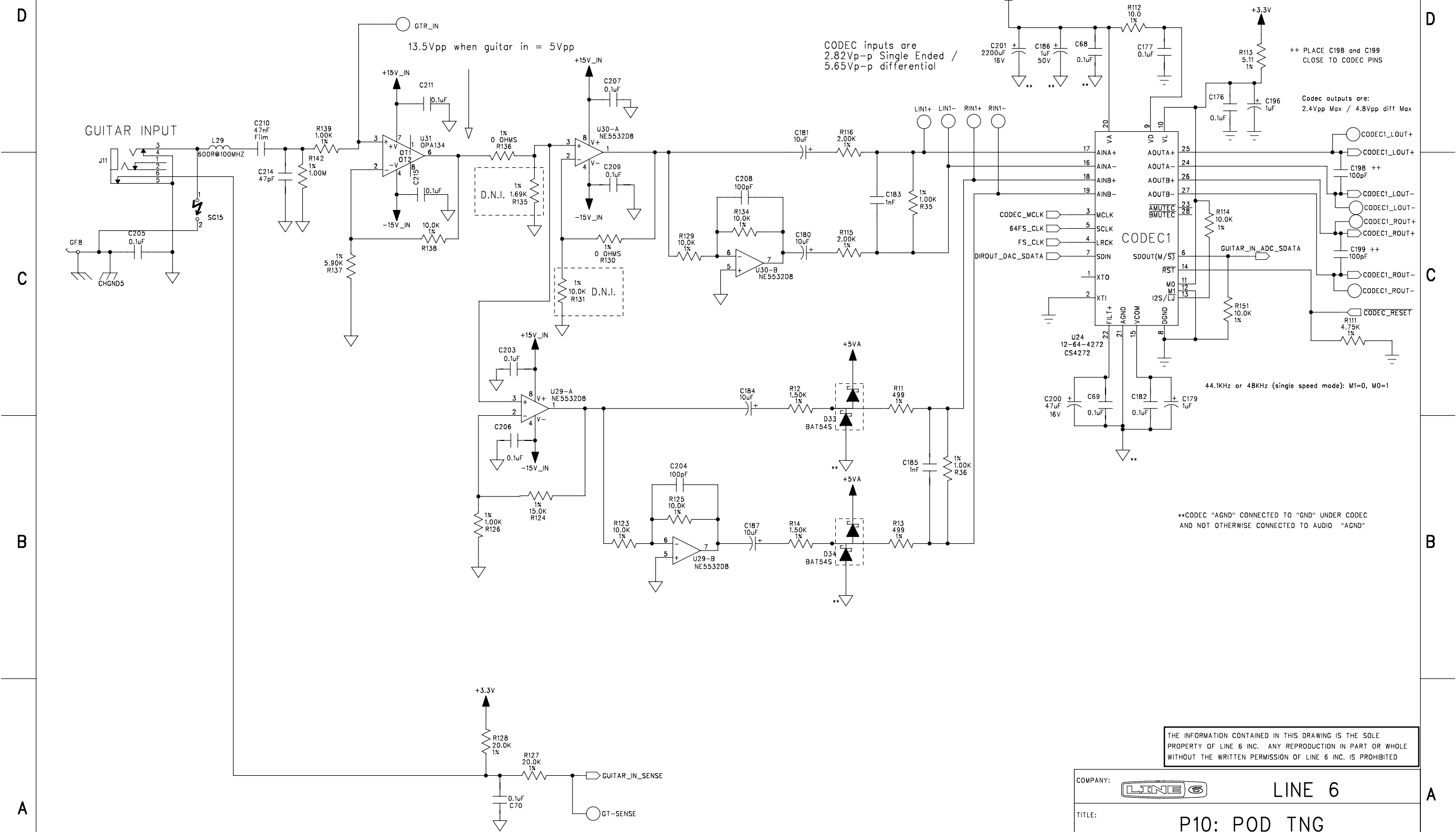

THE INFORMATION CONTAINED IN THIS DRAWING IS THE SOLE PROPERTY OF LINE 6 INC. ANY REPRODUCTION IN PART OR WHOLE WITHOUT THE WRITTEN PERMISSION OF LINE 6 INC. IS PROHIBITED

COMPANY:		LINE 6	
TITLE: P10: POD TNG			
PROGRAM: PADS LOGIC 2004		REV: D	
FILENAME:			
SCALE: 1:1	SIZE: C	PART NUMBER: 35-00-0079	SHEET: 7 of 10

PRELIMINARY DRAWINGS FOR QUOTATION PURPOSES ONLY DO NOT USE FOR PRODUCTION

DRAWN: D. MOLNAR	DATED: 01.31.2007
CHECKED: review panel	DATED:

6 5 4 3 2 1

ECOs INCLUDED ON THIS SCHEMATIC/PCB REVISION		
ECO NO:	DATE:	DESCRIPTION:

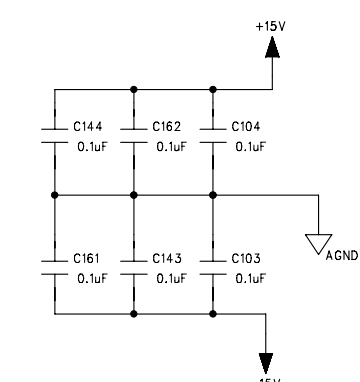
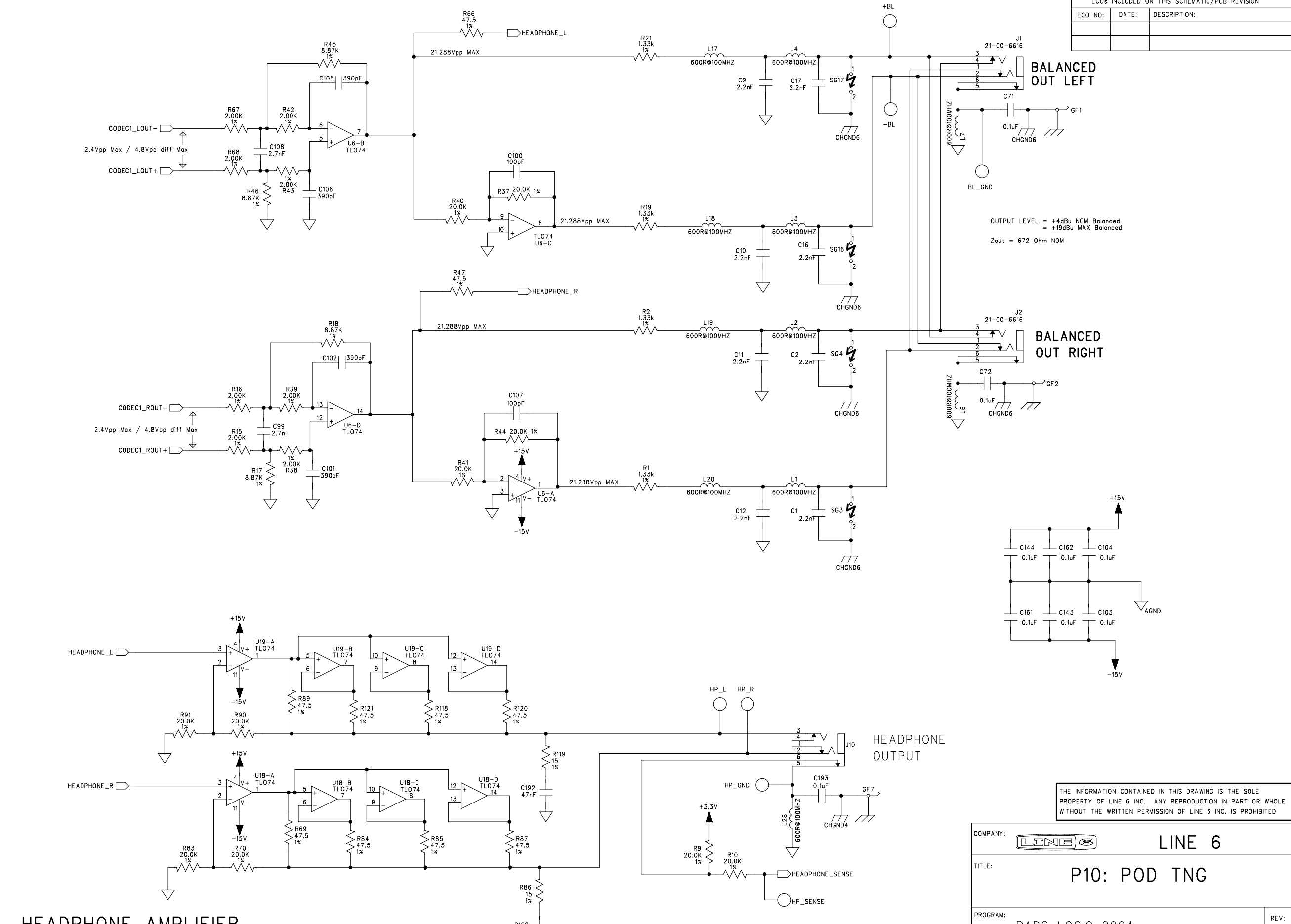

HEADPHONE AMPLIFIER

**PRELIMINARY DRAWINGS
FOR QUOTATION PURPOSES ONLY
DO NOT USE FOR PRODUCTION**

DRAWN: D. MOLNAR
CHECKED: review panel

DATED: 01.31.2007
DATED:

COMPANY:		LINE 6	
TITLE: P10: POD TNG			
PROGRAM: PADS LOGIC 2004			REV: D
FILENAME:			
SCALE: 1:1	SIZE: C	PART NUMBER: 35-00-0079	SHEET: 8 of 10

THE INFORMATION CONTAINED IN THIS DRAWING IS THE SOLE PROPERTY OF LINE 6 INC. ANY REPRODUCTION IN PART OR WHOLE WITHOUT THE WRITTEN PERMISSION OF LINE 6 INC. IS PROHIBITED

ECOs INCLUDED ON THIS SCHEMATIC/PCB REVISION		
ECO NO:	DATE:	DESCRIPTION:

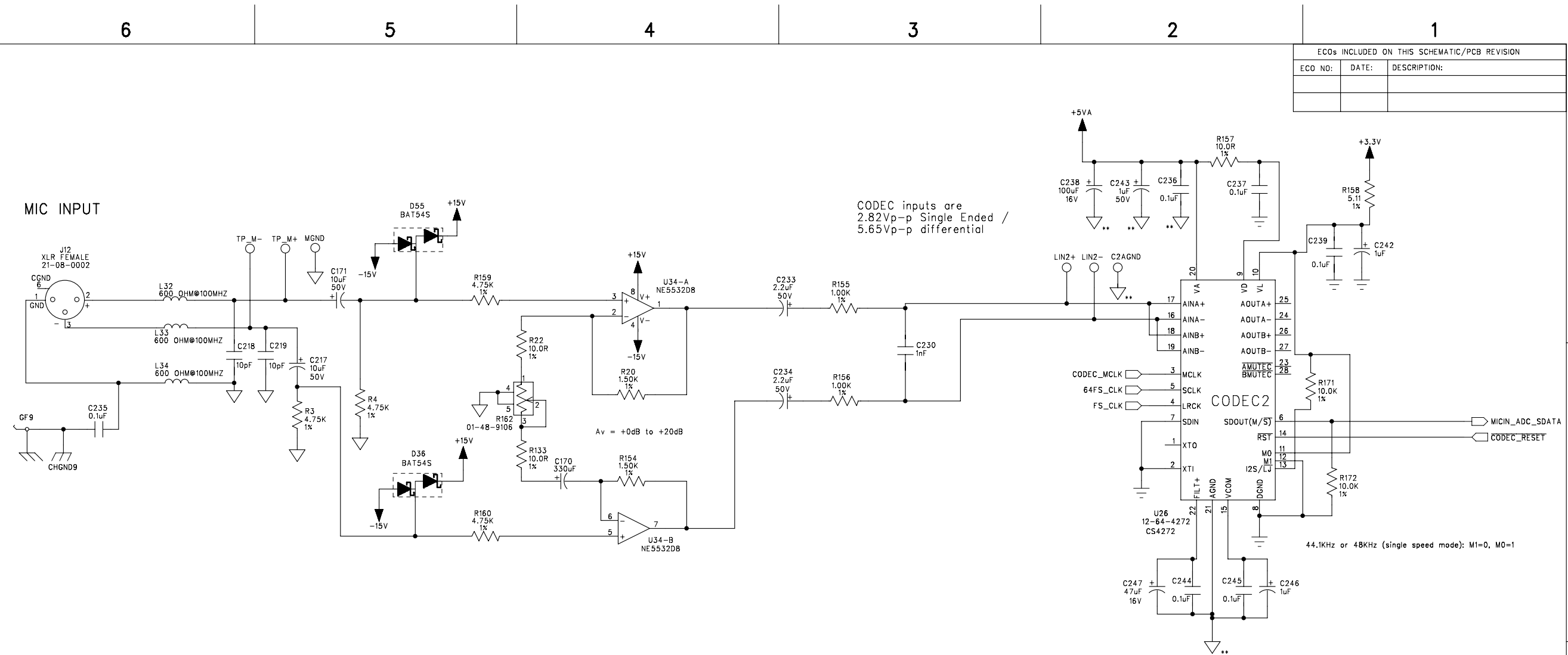

CODEC inputs are
2.82Vp-p Single Ended /
5.65Vp-p differential

**CODEC "AGND" CONNECTED TO "GND" UNDER CODEC
AND NOT OTHERWISE CONNECTED TO AUDIO "AGND"

THE INFORMATION CONTAINED IN THIS DRAWING IS THE SOLE
PROPERTY OF LINE 6 INC. ANY REPRODUCTION IN PART OR WHOLE
WITHOUT THE WRITTEN PERMISSION OF LINE 6 INC. IS PROHIBITED

COMPANY:		LINE 6	
TITLE: P10: POD TNG			
PROGRAM: PADS LOGIC 2004			REV: D
FILENAME:			
SCALE: 1:1	SIZE: C	PART NUMBER: 35-00-0079	SHEET: 9 of 10

**PRELIMINARY DRAWINGS
FOR QUOTATION PURPOSES ONLY
DO NOT USE FOR PRODUCTION**

DRAWN: D. MOLNAR	DATED: 01.31.2007
CHECKED: review panel	DATED:

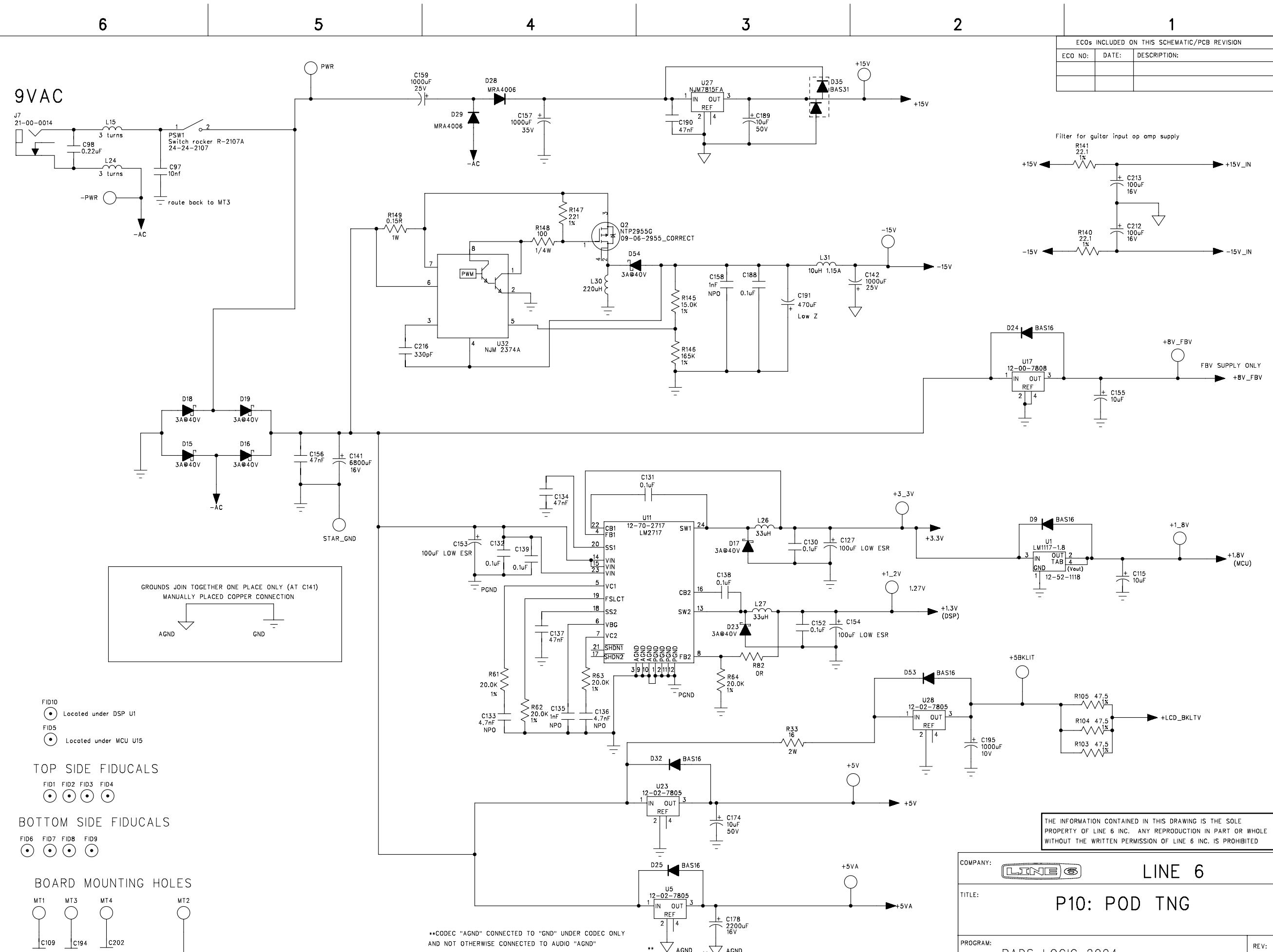

ECOs INCLUDED ON THIS SCHEMATIC/PCB REVISION		
ECO NO:	DATE:	DESCRIPTION:

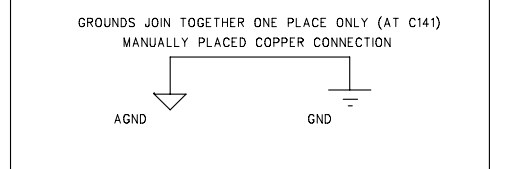

- FID10 Located under DSP U1
- FID5 Located under MCU U15

- TOP SIDE FIDUCIALS
- FID1
 - FID2
 - FID3
 - FID4

- BOTTOM SIDE FIDUCIALS
- FID6
 - FID7
 - FID8
 - FID9

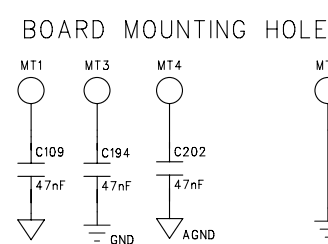

**CODEC "AGND" CONNECTED TO "GND" UNDER CODEC ONLY AND NOT OTHERWISE CONNECTED TO AUDIO "AGND"

PRELIMINARY DRAWINGS FOR QUOTATION PURPOSES ONLY DO NOT USE FOR PRODUCTION

DRAWN: D. MOLNAR / T. BURTON/gk
CHECKED: review panel
DATED: 01.31.2007

COMPANY: LINE 6

TITLE: P10: POD TNG

PROGRAM: PADS LOGIC 2004

FILENAME:
 REV:
 SCALE: 1:1 SIZE: C PART NUMBER: 35-00-0079 SHEET: 10 of 10

THE INFORMATION CONTAINED IN THIS DRAWING IS THE SOLE PROPERTY OF LINE 6 INC. ANY REPRODUCTION IN PART OR WHOLE WITHOUT THE WRITTEN PERMISSION OF LINE 6 INC. IS PROHIBITED

99-060-1105 P10-1 POD X3 US			
Part Number	Description	Qty. Per	Reference Designator(s)
11-32-0000	XFMR PX2 120VAC/60Hz 9VAC/2A UL 2464 VW-1 6FT. BLK US	1	PACKOUT
21-34-2000	CBL USB HIGH SPEED 2 METER BLK	1	
40-00-0119	CHART PRESET POD TNG BEAN P10-1	1	
40-00-0120	MANUAL USER POD TNG BEAN/LIVE P10-1 P11-1	1	
40-00-1000	CARD WARRANTY LINE 6 HARDWARE	1	
40-01-0016	CARD LICENSE-AGREEMNT END-USERALL-PRODUCTS	1	
40-03-0031	CARD REGISTRATION UK	1	
40-03-2000	CARD REGISTRATION US	1	
40-03-2000-1	CARD REGISTRATION EUROPE	1	
40-10-0173	CARTON GIFT POD TNG BEAN P10-1	1	
40-10-0176	INSERT CARTON SHARCPOD/BOD	1	
40-10-0199	CARTON FLAP POD TNG BEAN P10-1	1	
40-20-0011	BAG PLASTIC 10 x 16 2 mil	1	
40-20-0070	BAG PLASTIC SHIPPING 9" x 12" 2-MIL	1	
40-25-0024	STICKER ART SEAL EULA REV.B	1	
59-00-0036	ASSY UNIT COMPLETE POD-TNG P10-1	1	
59-00-0036 ASSY UNIT COMPLETE POD-TNG P10-1			
Part Number	Description	Qty. Per	Reference Designator(s)
30-00-1632	SCREW 6-32 x 3/8IN PPB TAP-TITE STL	4	CHASSIS TOP to CHASSIS BOTTOM
30-15-0038	SPCR ENCDR SPRT .44 OD x .33 ID x .32 LG BLK ABS P10-1	4	MAIN PCB E2,E3,E4,E5
30-27-0207	BEZEL DISPLAY 5.8 x 3.3 x .08 CLR PC P10-1	1	CHASSIS TOP
30-27-0208-1	BUTTON DBL LEFT 1.6 x 1.3 x .78 ABS PLASTIC P10-1	1	4-WAY SWITCH LEFT/E1
30-27-0208-2	BUTTON DBL RT 1.6 x 1.3 x .7 8 ABS PLASTIC P10-1	1	
30-27-0217-1	BUTTON 4 WAY TOP .8 DIA x .4 HT ABS NO PLTG (P10-1)	1	
30-27-0218	BUTTON 4 WAY BOTTOM .8 DIA x .5 HT ABS P10-1	1	
30-27-0221	4-WAY SW PIVOT PIN .37 x .200 DIA NYLON 6/6 WHITE P10-1	1	4-WAY SWITCH RIGHT
30-27-0222-1	KNOB POT .55 DIA x .41 HT ABS BLK NO ART WORK P10-1	4	E2,E3,E4,E5
30-27-0222-2	KNOB POT .55 DIA x .41 HT ABS BLK W/ART WORK P10-1	1	E1
30-45-0011	KNOB POT .77 DIA x .76 HT PLASTIC CHROME-PLATED	8	POTS
30-48-0010	FOOT RUBBER w/ADHSV 3M-BUMPON SJ-5012 (or equiv)	4	CHASSIS BOTTOM
30-51-0275	CHASSIS TOP 11.0 x 7.4 x 1.0 AL P10-1	1	
30-51-0276	CHASSIS BOTTOM 11.0 x 7.4 x 2.0 AL P10-1	1	
30-51-0277	PUSH RTNR FOR 3.0MM SHAFT STL BLK P10-1	6	
30-60-0006	LOGO LINE 6 SML 38.35 x 7.98mmw/ADHSV BRUSHED/BLK FINISH AL	1	CHASSIS TOP
30-63-0028	FOAM RING 4-WAY SW RET PU .75 OD x .40 ID x .18 HT BLK P10-1	1	TO DOUBLE BUTTON RIGHT
30-75-0048	KEYPAD RUBBER 5.3 x .7 x .7" P10-1	1	K1
40-25-0020	LABEL INSPECTION QUALITY	1	CHASSIS BOTTOM
40-25-0101	LABEL BAR CODE S/N 2-PNL LTX 16 1125502	1	1-CHASSIS BOTTOM, 1-PCBA
40-25-0269	LABEL COMPLIANCE POD TNG BEAN P10-1	1	CHASSIS BOTTOM
50-02-0079	PCBA MAIN POD X3 TNG BEAN P10-1	1	

50-02-0079 PCBA MAIN POD X3 TNG BEAN P10-1			
Part Number	Description	Qty. Per	Reference Designator(s)
01-12-0101	RES CARBON FILM 100R 1/4W 5% TH	1	R148
01-21-015R	RES METAL OXIDE 0.15R 1W 5% TH incorrect PN.. use 01-21-0R15	1	R149
01-22-0160	RES METAL OXIDE 16R 2W 5% TH	1	R33
01-24-0000	RES 0R 1% 0805	2	L5,L16
01-24-10R0	RES 10.0R 1% 0805	3	R7,R50,R112
01-24-1300	RES 130R 1% 0805	8	R51,R52,R54,R55,R75,R77,R78,R79
01-24-1331	RES 1.33K 1% 0805	4	R1-2,R19,R21
01-24-1502	RES 15.0K 1% 0805	1	R145
01-24-15R0	RES 15R 1% 0805	2	R86,R119
01-24-1653	RES 165K 1% 0805	1	R146
01-24-2002	RES 20.0K 1% 0805	16	R9,R10,R37,R40,R41,R44,R61,R62,R63,R64,R70,R83,R90,R91,R127,R128
01-24-2210	RES 221R 1% 0805	1	R147
01-24-22R1	RES 22.1R 1% 0805	2	R140,R141
01-24-30R1	RES 30.1R 1% 0805	3	R60,R80,R81
01-24-3481	RES 3.48K 1% 0805	1	R82
01-24-4752	RES 47.5K 1% 0805	1	R92
01-24-47R5	RES 47.5R 1% 0805	13	R47,R66,R69,R84,R85,R87,R89,R103,R104,R105,R118,R120,R121
01-24-4870	RES 487R 1% 0805	1	R30
01-24-5R11	RES 5.11R 1% 0805	1	R113
01-24-8871	RES 8.87K 1% 0805	4	R17,R18,R45,R46
01-24-88R7	RES 88.7R 1% 0805	1	R31
01-25-0000	RES 0R 1% 0603	2	R130,R136
01-25-1001	RES 1.00K 1% 0603	6	R35-36,R126,R139,R155-156
01-25-1002	RES 10.0K 1% 0603	15	R6,R26,R34,R59,R93,R97,R114,123,R125,R129,R134,R138,R151,R171,R172
01-25-1004	RES 1.00M 1% 0603	2	R5,R142
01-25-10R0	RES 10.0R 1% 0603	3	R22,R133,R157
01-25-1400	RES 140R 1% 0603	2	R153,R253
01-25-1501	RES 1.50K 1% 0603	4	R12,R14,R20,R154
01-25-1502	RES 15.0K 1% 0603	1	R124
01-25-1821	RES 1.82K 1% 0603	1	R122
01-25-2001	RES 2.00K 1% 0603	14	R15,R16,R25,R28,R29,R38,R39,R42,R43,R58,R67,R68,R115,R116
01-25-4022	RES 40.2K 1% 0603	1	R94
01-25-4751	RES 4.75K 1% 0603	17	R3,R4,R8,R53,R56,R57,R71,R72,
01-25-4990	RES 499R 1% 0603	4	R11,R13,R76,R143
01-25-5901	RES 5.90K 1% 0603	1	R137
01-25-5R11	RES 5.11R 1% 0603	1	R158
01-48-0103	POT MONO 10KB LINEAR TAPER 25 mm D-SHAFT	8	R23-24,R27,R32,R48,R65,R88,R117

50-02-0079 PCBA MAIN POD X3 TNG BEAN P10-1			
Part Number	Description	Qty. Per	Reference Designator(s)
01-48-9106	POT SINGLE 10KC Log Taper Right Angle 25 mm Shaft	1	R162
03-10-0331	CAP ELEC 330uF 10V 20% RADIAL 6.3/11.2/5	1	C170
03-10-1107	CAP ELEC 100uF 6.3V 20% RADIAL5/11/5	3	C110,C126,C168
03-10-1108	CAP ELEC 1000uF 10V 20% RADIAL 10/12.5/5	1	C195
03-12-0107	CAP ELEC 100uF 16V 20% RADIAL 6.3/11/5	4	C78,C212,C213,C238
03-12-0228	CAP ELEC 2200uF 16V 20% RADIAL12.5/20/5	2	C178,C201
03-12-0476	CAP ELEC 47uF 16V 20% RADIAL 6.3/11.2/5	2	C200,C247
03-12-0688	CAP ELEC 6800uF 16V 20% RADIAL18/35.5/7.5	1	C141
03-13-0107	CAP ELEC 100uF 16V 20% 105C LowZ 0.350R RADIAL 6.3/11.2/5	3	C127,C153,C154
03-14-0108	CAP ELEC 1000uF 25V 20% RADIAL 10/20/5	0	C142,C159
03-15-1477	CAP ELEC 470uF 25V 20% 105C LowZ 0.1R RADIAL 10/20/5	1	C191
03-16-0108	CAP ELEC 1000uF 35V 20% RADIAL12.5/20/5	1	C157
03-18-0105	CAP ELEC 1uF 50V 20% RADIAL 5/11/5	6	C179,C186,C196,C242,D243,C246
03-18-0106	CAP ELEC 10uF 50V 20% RADIAL 5/11/5	10	C115,C155,C171,C174,C180,C181,C184,C187,C189,C217
03-18-0225	CAP ELEC 2.2uF 50V 20% RADIAL 5/11/5	2	C233,C234
03-19-0107	CAP ELEC 100uF 50V 20% 105C LowZ 0.2R RADIAL 8/20/5	1	C197
03-36-0224	CAP ESTR 0.22uF 50V 5% TH 11/6/11.5/7.5	1	C98
03-45-0473	CAP 47nF 16V 20% 1206 FILM	1	C210
03-50-0120	CAP NPO 12pF 50V 5% 0805	2	C91,C92
03-50-0272	CAP NPO 2.7nF 50V 5% 0805	2	C99,C108
03-50-0391	CAP NPO 390pF 50v 5% 0805	4	C101,C102,C105,C106
03-50-0472	CAP NPO 4.7nF 25V 5% 0805	2	C133,C136
03-50-0561	CAP NPO 560pF 50v 5% 0805	2	C304,C305
03-52-0222	CAP X7R 2.2nF 50V 10% 0805	8	C1,C2,C9,C10,C11,C12,C16,C17
03-52-0331	CAP X7R 330pF 50V 10% 0805	1	C216
03-52-0473	CAP X7R 47nF 50V 10% 0805	10	C77,C109,C134,C137,C156,C160,C190,C192,C194,C202
03-56-0100	CAP NPO 10pF 50V 5% 0603	2	C218,C219
03-56-0101	CAP NPO 100pF 50V 5% 0603	8	C75,C100,C107,C117,C198,C199,C204,C208
03-56-0102	CAP NPO 1nF 50V 5% 0603	6	C76,C135,C158,C183,C185,C230
03-56-0470	CAP NPO 47pF 50V 5% 0603	1	C214
03-58-0102	CAP X7R 1nF 50V 10% 0603	26	C4,C5,C8,C29,C35,C37,C40,C43,C44,C45,C47,C48,C51,C56,C58,C59,C60,C65,C66
03-58-0103	CAP X7R 10nF 50V 10% 0603	6	C6,C20,C31,C93,C97,C124
03-58-0104	CAP X7R 0.1uF 25V 10% 0603	27	C161,C162,C163,C164,C165,C167,C169,C176,C177,C182,C188,C193,C203,C205,C206,C207,C209,C211,C215,C235,C235,C236,C237,C239,C244,C245,C306,C307,C3,C7,C18,C19,C21,C22,C23,C24,C25,C26,C27,C28,C30,C32C,C33,C34,C36,C38,C39,C41,C42,C46,C49,C50,C52,C53,C54,C55,C57,C62,C63,C64,C67,C68,C69,C70,C71,C72,C73,C74,C79,C80,C81,C82,C83,C84,C85,C86,C87,C89,C94,C95,C103,C104,C111,C112,C113,C114,C116,C119,C120,D121,D122,D123

50-02-0079 PCBA MAIN POD X3 TNG BEAN P10-1			
Part Number	Description	Qty. Per	Reference Designator(s)
03-82-0106	CAP ELEC 10uF 16V 20% SM 4/5.4/5.5	2	C88,C90
04-01-0100	INDUCTOR DRUM-CORE 10uH @ 2.52MHz 1.15A SM GS43	1	L31
04-01-0220	INDUCTOR CHOKE 220uH 0.38R/2.4A SM	1	L30
04-04-0001	FERRITE BEAD 3-TURN 600R @ 100MHZ MATERIAL-61 RADIAL TH	2	L15,L24
06-20-0099	DIODE GEN PUR DUAL 70V 215mA 6nS SOT-23 SM BAV99-7-F	5	D12,D20,D21,D22,D35
06-23-0054	DIODE SCHOTTKY DUAL 30V 200mA 5nS SOT-23 SM BAT54S	6	D26,D27,D33,D34,D36,D55
06-32-0340	DIODE SCHOTTKY 3A 40V SMB SM B340B	8	D10,D15,D16,D17,D18,D19,D23,D54
06-32-4006	DIODE RECTIFIER 800V 1A SMA SM MRA4006T3G	2	D28,D29
06-34-0016	DIODE SWITCHING 75V 200mA 6nS SOT-23 SM BAS16LT1G	21	D9,D24,D25,D32,D37,D38,D39,D40,D41,D42,D43,D44,D45,D46,D47,D48,D49,D50,D51,D52,D53
09-06-2955	TRANS POWER-MOSFET P-CHAN 60V 230mR NTP2955 TO-220 TH	1	Q2
09-10-4403	TRANS PNP SMALL-SIGNAL MBT4403SOT-23 SM	1	Q1
11-00-0003	CRYSTAL 24MHz 2-P LOW PROFILE METAL CAN TH AT49	1	Y1
11-01-2258	OSCILLATOR 22.5792MHz 3.3V W/3-S HCMOS OUT 4P HS-DIP8	1	Y3
11-01-2458	OSCILLATOR 24.576MHz 3.3V W/3-S HCMOS OUT 4P HS-DIP8	1	Y2
11-10-0033	INDUCTOR CHOKE 33uH 0.23R/.88ACR-54 SM	2	L26,L27
11-10-0501	FERRITE BEAD 500R @100MHZ 2.5A 1206 SM	2	L8,L12
11-10-2012	FERRITE BEAD 600R@100MHZ 300mA 0805 SM	21	L1,L2,L3,L4,L5,L7,L9,L10,L11,L13,L14,L17,L18,L19,L20,L25,L28,L32,L33,L34
11-33-0120	XFMR AUDIO DIGITAL X-MISSION 1:1	1	T1
12-00-7808	IC REG +8V 1A TO-220 TH LM7808	1	U17
12-02-0015	IC REG +15V 1.5AMP TO-220F TH NJM7815FA#	1	U27
12-02-7805	IC REG +5v 1.5 Amp TH	3	U5,U23,U28
12-52-1118	IC REG 1.8V LDO LINEAR 800mA SOT-223 SM LM1117MPX-1.8	1	U1
12-54-0074	IC OP-AMP TL074 SM	3	U6,U18,U19
12-54-0134	IC OP AMP - OPA134UA SM SO-8	1	U31
12-54-5538	IC OP-AMP DUAL LO NOISE NE5532AD8 SM SO-8	3	U29,U30,U34
12-64-4272	IC CONVERTER A/D CODEC 24-BIT/192 kHz STEREO CS4272 TSSOP-28	2	U24,U26
12-70-2717	IC CONVERTER DUAL STEP-DOWN DC-DC LM2717 TSSOP-24 SM	1	U11
15-64-0000	IC 74HCT00 QUAD 2 INPUT NAND SO-14 SM	1	U41
15-64-0014	IC 74HCT14 HEX INVERTER 6 SM	1	U22
15-64-0273	IC 74HCT273 FLIP-FLOP D-TYPE 8-BIT SO-20 SM	2	U20,U21
15-65-0002	IC 74LCX02 LOW VOLTAGE CMOS QUAD 2 INPUT NOR SO-14 SM	1	U10
15-65-0015	IC SN74LVC14A LOW VOLTAGE CMOSINV HEX SCHMITT TRIG. SOP14 SM	1	U40
15-68-2374	IC CONTROLLER PWM DC/DC CONVERTER NJM2374AE DMP-8 SM	1	U32
15-68-6801	IC CONTROLLER USB 2.0 w/8052 MCU CY7C68013A-56PVX SSOP-56	1	U3
15-70-0002	IC SDRAM 3.3V 64MB 1M x 16 x 4TSOP-54 SM	2	U9,U14
15-78-0256	IC EEPROM 256KBIT I2C 2.5V SERIAL 24LC256I SOIC8(.200) SM	1	U2
15-79-0088	IC MEMORY SECURE AT88SC153-00 -2.7 8S1 (SO-8) SM	1	U4 Non Programmed IC (requires ESN)

50-02-0079 PCBA MAIN POD X3 TNG BEAN P10-1			
Part Number	Description	Qty. Per	Reference Designator(s)
15-84-2220	IC MCU LPC2220 16/32 Bit ARM w/64K S1RAM 10B ADC LQFP144 SM	1	U8
15-86-1369	IC DSP SHARC ADSP-21369KSZ MQFP208 SM	1	U15
15-92-5809	IC RESET 3.3V 5% ACTIVE-LOW SOT-23 SM LM809M3-3.08/NOPB	1	U7
18-02-0001	LED YELLOW SUPERBRITE T1(3MM) TH WP7104SYC	7	D2,D3,D4,D5,D6,D7,D8
18-02-0002	LED RED HI INTENSITY W934LSRD	1	D1
21-00-0014	JACK BARREL PCB MT 2.5mm DC PWR 3-PIN TH	1	J7
21-00-6616	JACK 1/4" TRS 6-PIN PCB MT HORIZ TH	4	J1,J2,J10,J11
21-02-0003	JACK RCA 2 PIN RT-ANGLE PCB-MNT	1	J5
21-08-0002	JACK XLR FEMALE PCB MT RT ANG TH W/NO RELEASE TAB	1	J12
21-16-0045	JACK RJ-45 8-PIN FEMALE PCB-MNT RT-ANG	1	J4
21-21-0001	JACK USB-B SHIELDED PCB-MNT BLACK WIESON 3700-4ABN4S1W	1	J3
24-12-0001	ENCODER 24-STEP w/25mm SHFT EC12PVF-D-25F-24-24C-16Y TH	4	E2,E3,E4,E5
24-12-0006	ENCODER 20-STEP 15mm w/SWITCH D-SHAFT METAL V-MNT	1	E1
24-24-2107	SWITCH ROCKER ON-OFF 2-PIN HOR MNT	1	PSW1
24-31-0002	SWITCH TACT 6mm SQ 4-PIN SMT W/ RND 3.5mm ACTUATOR	8	SW1,SW2,SW3,SW4,SW5,SW6,SW7,SW8
30-00-0617	SCREW #6 x 7/16IN SCKT-CAP BLKALLOY	2	(U17,U28)
30-12-2210	STANDOFF HEX .250 6-32 F-F .500 LG AL	2	
30-15-0007	INSULATOR XTAL 4.9mm C-C 11.8x5.6mm MYLAR	1	
30-18-3030	CLIP GND PCB .30x.30x.07	8	
35-00-0079	PCB MAIN POD TNG BEAN P10-1 REV.D	1	Not Available As A Replacement Part (unpopulated pcb)
40-30-2000	LABEL ESN 38.10 x 6.35mm THERMAL XFR GLOSSY WHITE	1	
45-02-0038	IC PROGRAMMED FLASH/MCU vB0.24POD TNG BEAN P10-1	1	
50-02-0118	PCBA DISPLAY LCD 128x64 Pos Graphic 6-:00 Amber P10-1	1	LCD1

50-02-0118 PCBA DISPLAY LCD 128x64 Pos Graphic 6-:00 Amber P10-1			
Part Number	Description	Qty. Per	Reference Designator(s)
18-30-1001	LCD CUSTOM FOR FBV FAMILY TQL001TPL-V3 (VERSION 3)	1	LCD1
21-30-0035	CBL SIL 20-PIN RIBBON .100 CENTERS x 3" 26AWG S/T	1	JMP1
30-27-0219	SPRT, DUAL LKG CKT BD TEARDROP3/16 NYLON NAT P10-1	4	



Technical Bulletin 026

Product: POD XT, X3, Tone Port products containing secure memory devices.

Overview:

The identified units below have a secure memory device installed on their respective main PCBA's. This device allows for a collection and transmission of an electronic serial number which will enable the customer (end-user) to access, obtain, and purchase specific upgrades, downloads or their user account on-line.

Service Objective:

When replacing the main PCBA in any of the following product, it is necessary to remove P/N: 15-79-0088 from the "old" PCBA and transplant it to the new PCBA.

Parts Affected:

15-79-0088- IC Memory Secure AT88SC153-00 -2.7 8S1 (SO-8) SM

Affected Product/ PCBA Locations:

POD XT and Bass POD XT: **U17**
POD XT Live and Bass POD XT Live: **U24**
POD XT Pro and Bass POD XT Pro: **U8**
Floor POD Plus: **U24**
POD X3: **U4**
POD X3 Live: **U2**
Tone Port KB37: **U6**
Tone Port UX8: **U3**

Tools/ Supplies Required:

Various hand-tools for product disassembly, soldering iron, RoHS compliant solder/ flux.

Procedure:

Remove secure memory IC, P/N: 15-79-0088 from original PCBA and transplant it to the correct reference designator location on new PCBA.

Warranty Implications:

This is a required step in replacing the main board on any of the above-identified products and should be considered as warranty.

Date Codes Affected:

All.



Engineering

Confidential

P10-1 POD TNG PCBA Assembly Instructions Rev D

MAIN PCBA: 50-02-0079

TOP ASSEMBLY

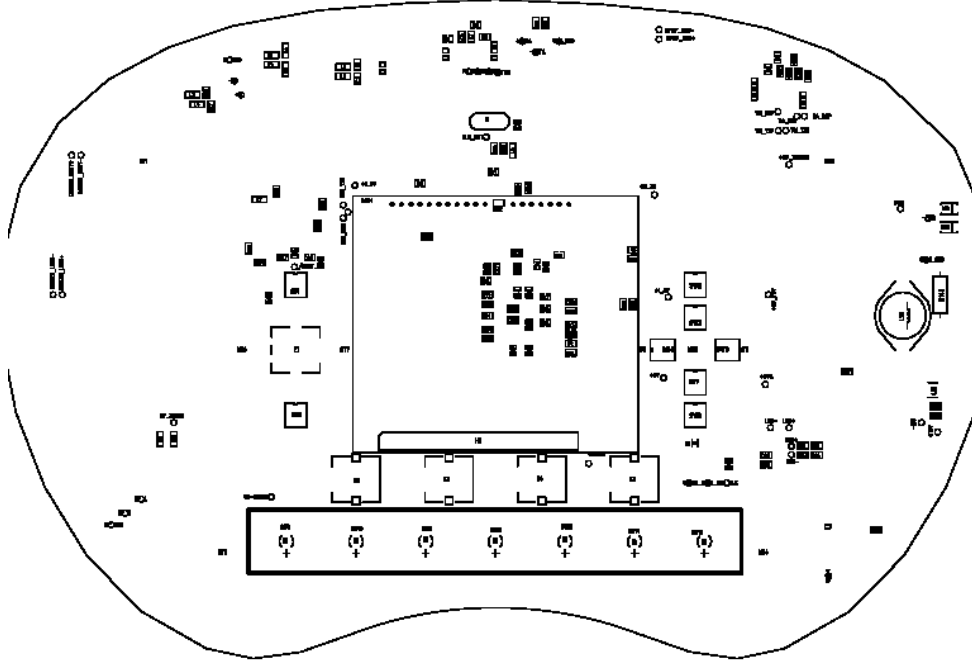

BOTTOM ASSEMBLY

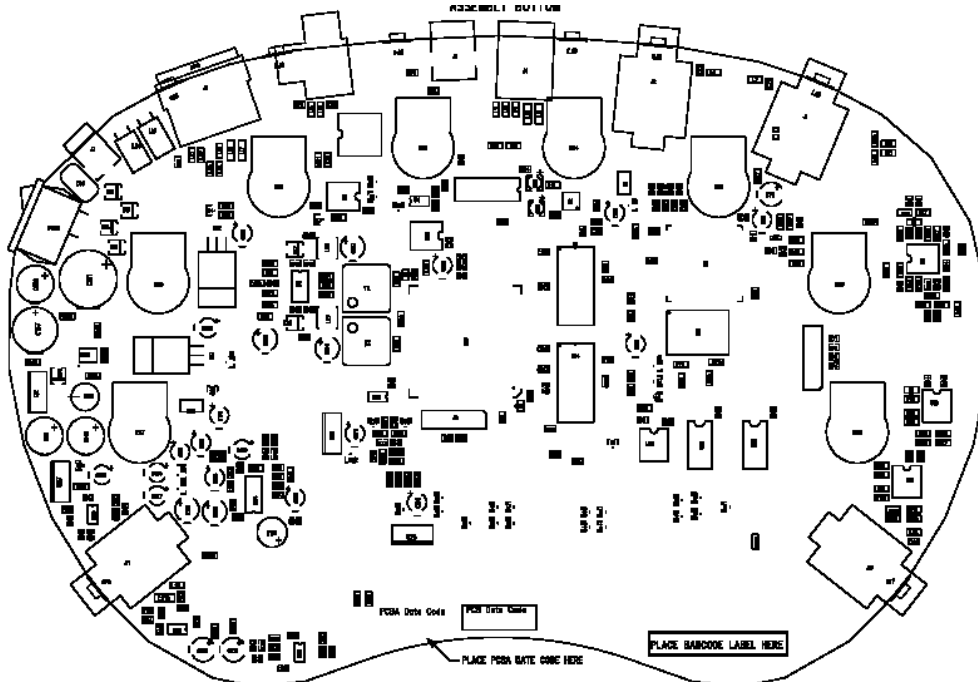

1. **“NOT INSTALLED” COMPONENTS:** Do not install the following components:
H1, H2, R150, R131, R135
2. **JACKS:** Make sure ALL jacks J1-2, J10-11 (P/N 21-00-6616) are mounted flush against the PCB and lined up with silkscreen outline within +/-1 degree of accuracy. **ALL jacks are mounted on the bottom side of the PCB.**

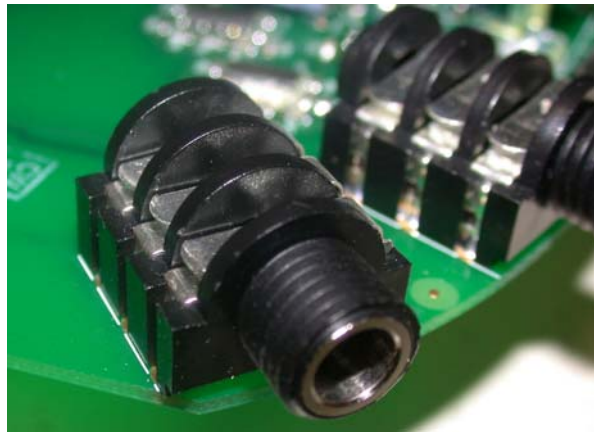

3. **POWER SWITCH and POWER JACK:** Power switch PSW1 (P/N 24-24-2107) and the power jack J7 (P/N 24-00-0014) are both mounted on the bottom side of the PCB with the switch and jack mounted flush to the PCB. The front edge of the switch body should just fit flush against the board edge.

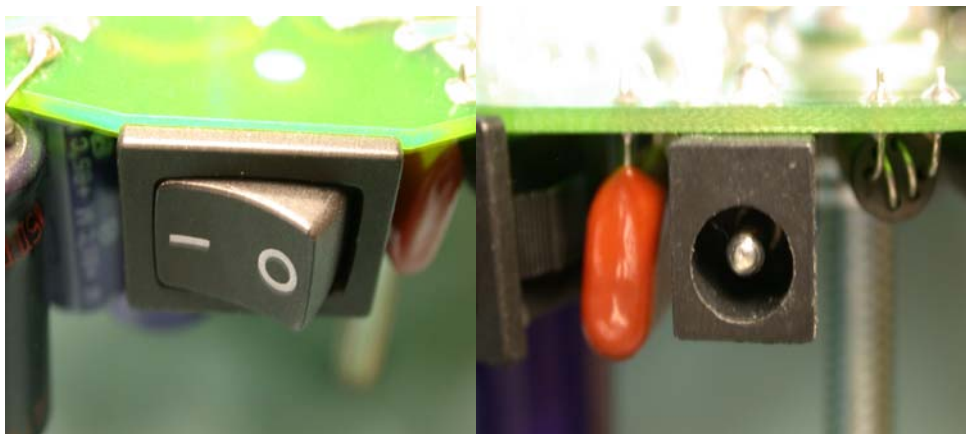

4. **REGULATOR ICs:** U17 is mounted with a screw (30-00-0607) and standoff (30-12-2210) flush against the PCB, tab side down. **The tab's hole must line up with the corresponding hole in the PCB.**

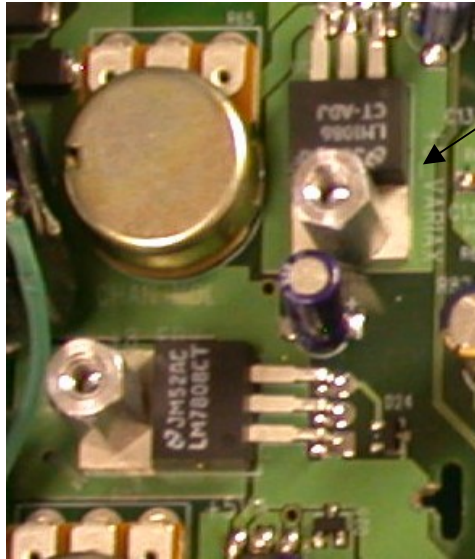

5. **GROUNDING FINGERS:** ALL grounding fingers (GF3-5, G7-9) 30-18-3030 are mounted flush against the PCB edge. They are mounted with their center clip hole on the TOP side of the PCB (all jacks are on the bottom side) see drawing below. The “curl” of the grounding finger should curve toward the bottom side (toward the corresponding jack if there is one). **They should then be manually soldered on the TOP side.**

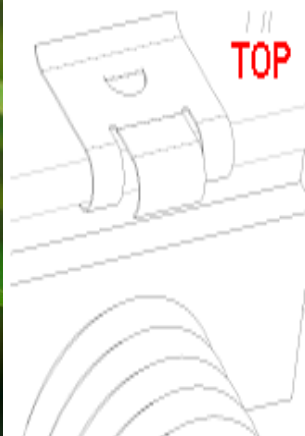
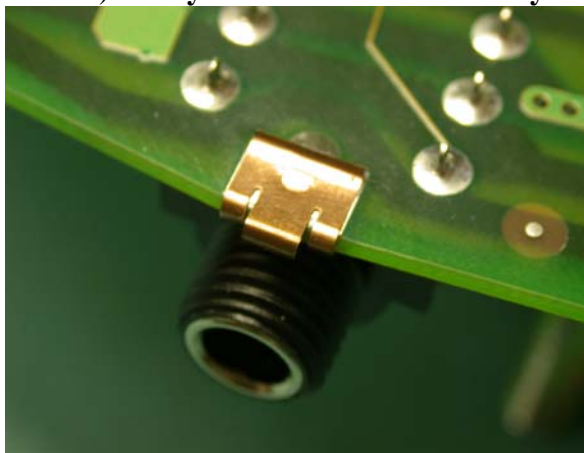

6. **METAL CAN OSCILLATOR:** Y2 (P/N 11-01-2458) and Y3 (P/N 11-01-2257) Metal can oscillator are to be mounted flush on the Bottom Side of the PCB. Make sure to check pin 1 orientation before installing. Add Insulator (P/N 30-15-0007) between the PCB and Y1 (P/N 11-00-0003) before mounting onto the Top Side of the PCB.
7. **ELECTROLYTIC CAPACITORS:** All large capacitors are mounted flush against the PCB on the Bottom Side of the PCB.
C141, C142, C157, C158, C159, C178, C191.

Add RTV around C170 so the capacitor can not short out to any components.

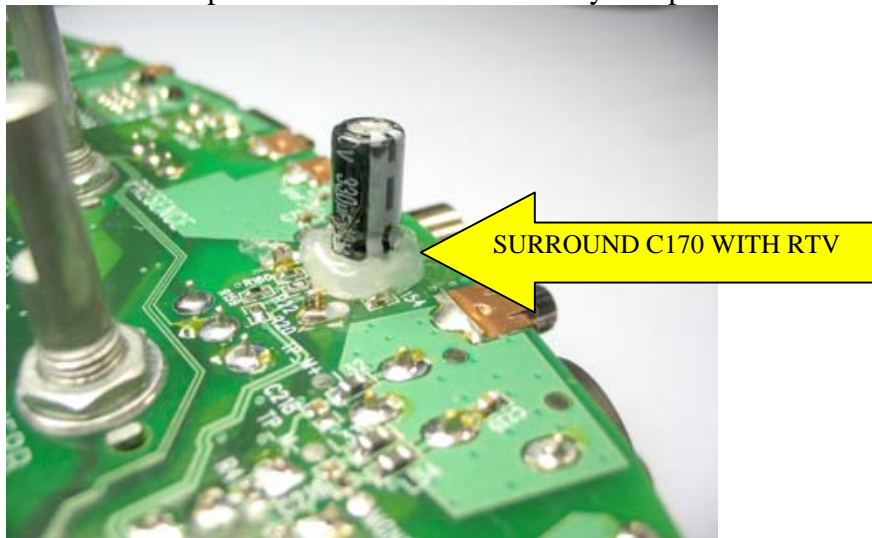

8. **THRU HOLE FERRITE BEADS:** L15 and L24 (P/N 04-04-0001) must be mounted on its side flush against the PCB and lined up with silkscreen outline. Clip leads to .060" on the TOP side of PCB. Make sure to apply a dab of RTV between L15 and L24, see picture below.



9. **USB JACK:** Mount the USB Jack flush on the Bottom Side of the PCB. Use scotch tape, electrical tape, or heat shrink tubing to prevent the USB jack J3 (P/N 21-21-0001) from shorting to the chassis. Place it around the front edges of the USB jack as shown below. For cosmetic reasons please apply tape or heat shrink as accurately as possible so that the tape or heat shrink does not protrude too far out from the jack.

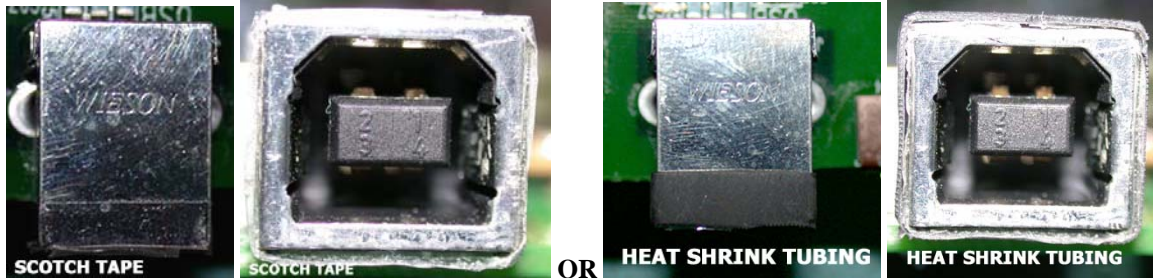

10. **POTENTIOMETERS:** Potentiometers R23-24, R27, R32, R48, R65, R88, and R117 are mounted on the bottom side of the PCB:
- Insert the shaft of the pot through the through-hole from the bottom side of the board. The pot shaft will sit perpendicular to the board when the pot is mounted flush to +/- 1 degree. Ensure that the 3 soldering leads and side pin extend through the board. **DO NOT SOLDER AT THIS POINT.** Secure the pot to the board using the supplied hexagonal nut and washer. Tighten until snug.
 - After securing the potentiometer using the hex nut and washer, solder the 3 terminal leads.

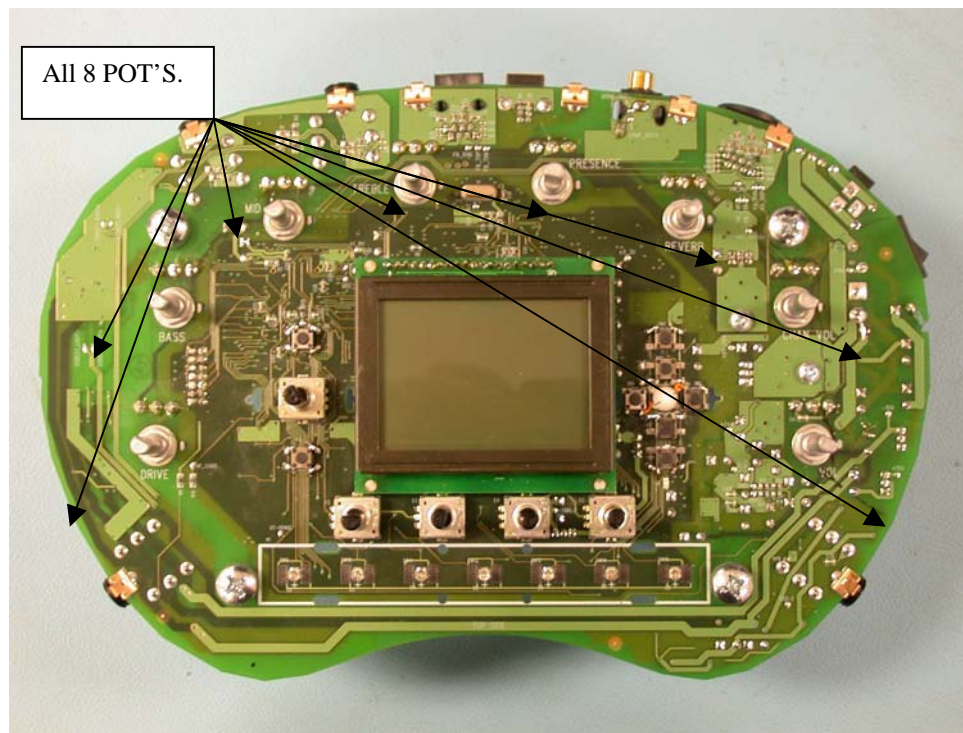

11. **ENCODERS:** Encoders E2-E5 are 24-step (24-12-0001). Encoder E1, is a 20 step with push switch (24-12-0006). ALL encoders are mounted on the TOP side of the PCB (See picture below). Each encoder should be mounted flush to the PCB within +/- 1 degree of accuracy. See picture below:

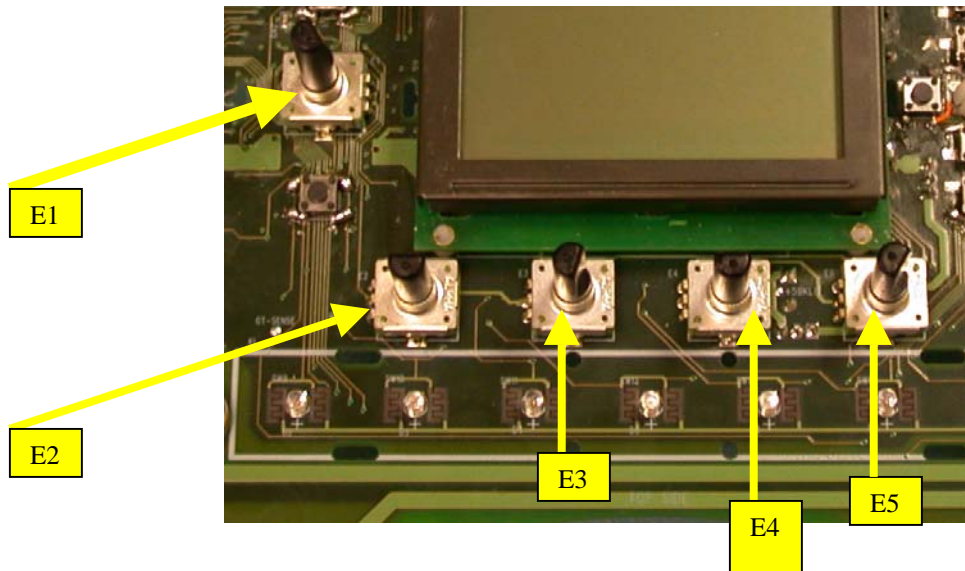

12. **THRU HOLE LED's:** Install LED's D2-8 (P/N 18-02-0001) on the Top Side of the PCB, making sure orientation is correct. Solder LEDs on the BOTTOM SIDE of the PCB.

13. **SMT LED:** SMT LED D1, (Part # 18-20-0002) has a small green triangle printed on the bottom. The point of the triangle denotes the cathode. Align the point of the triangle with the side of the diode that has a line in it on the silkscreen. **THIS IS A FRAGILE PART! SENSITIVE TO HEAT AND HUMIDITY. PLEASE HANDLE ACCORDING TO LED MANUFACTURER'S GUIDELINES**



CATHODE – Align the point of the triangle on LED with this side.

14. **LCD MODULE ASSEMBLY 50-02-0118:** There are five steps to setting up the LCD module:

Step 1 – Install the 4 Dual Locking Teardrops (P/N 30-27-0219) to the LCD Module (50-02-0118). See pictures below

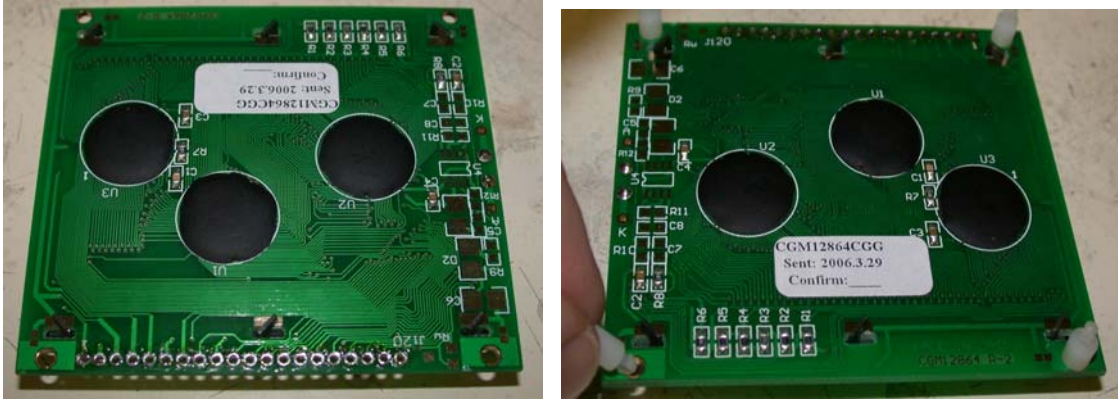

Step 2 – Solder the 20 pin female staked cable (P/N 21-30-0035) to the LCD Module. See picture below.



LINE 6

Engineering

Confidential

Step 3 – Solder the opposite side of the 20 pin cable (P/N 21-30-0035) to the Main PCBA. See picture below.

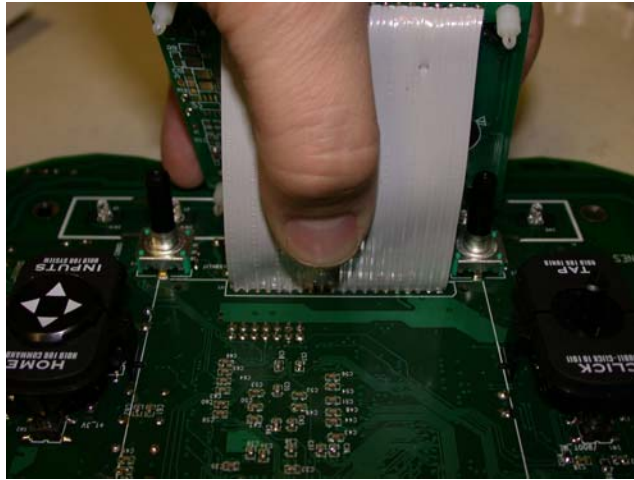

Step 4 – Cut leads on C126 so they do not short out the gray ribbon cable.

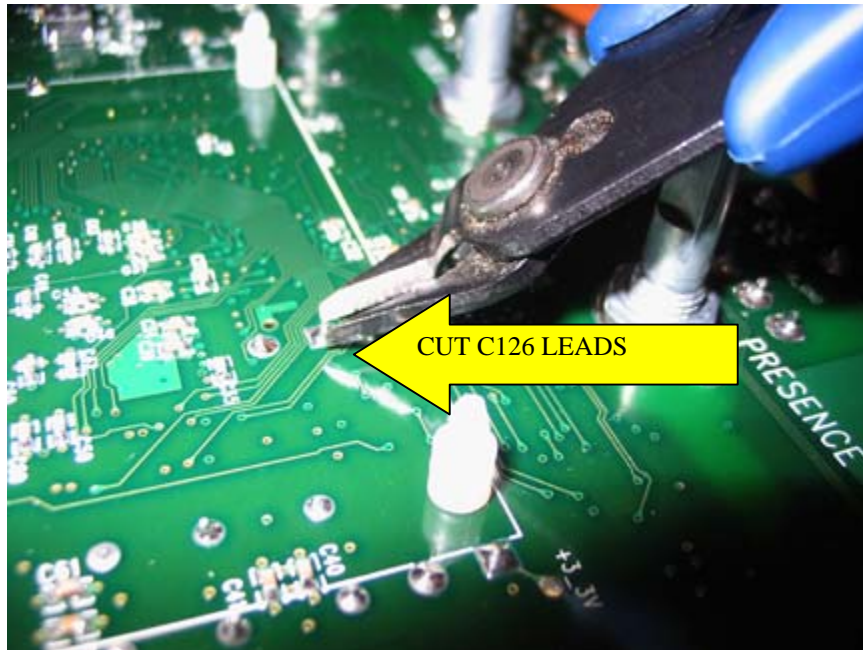

Step 5- Align the LCD Module with silkscreen outline on the Main PCBA and snap into place. Make sure all 4 Dual Locking Teardrops are secure in place. See picture below.



15. **BARCODE LABEL:** Place barcode label **40-30-2000** on BOTTOM side of PCB in the box labeled **“PLACE BARCODE LABEL HERE”** (see picture below).

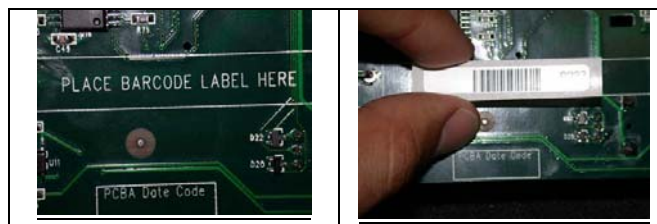

16. **PCBA Identification:** Place the appropriate date code in its location



Engineering

Confidential

POD TNG PCB Assembly Revisions

11/13/06 – Rev. X1	PCBA ASSEMBLY INSTRUCTION	Jorge Aguila
01/31/07 – Rev. X2	PCBA ASSEMBLY INSTRUCTION	Jorge Aguila
03/07/07 – Rev. X3	PCBA ASSEMBLY INSTRUCTION	Josh Forbes
05/01/07 – Rev. A	PCBA ASSEMBLY INSTRUCTION	Josh Forbes
06/12/07 – Rev. B	PCBA ASSEMBLY INSTRUCTION	Josh Forbes
	- added notes for adding resistor 1K mod.	
	- added DNI - R131, R135	
06/26/07 – Rev. C	PCBA ASSEMBLY INSTRUCTION	Josh Forbes
	- removed the instructions specific to Beta build	
07/05/07 – Rev. D	PCBA ASSEMBLY INSTRUCTION	Jim Williams
	- added apply RTV glue around C170 (page 4)	
	- added clip C126 leads under LCD (page 8)	

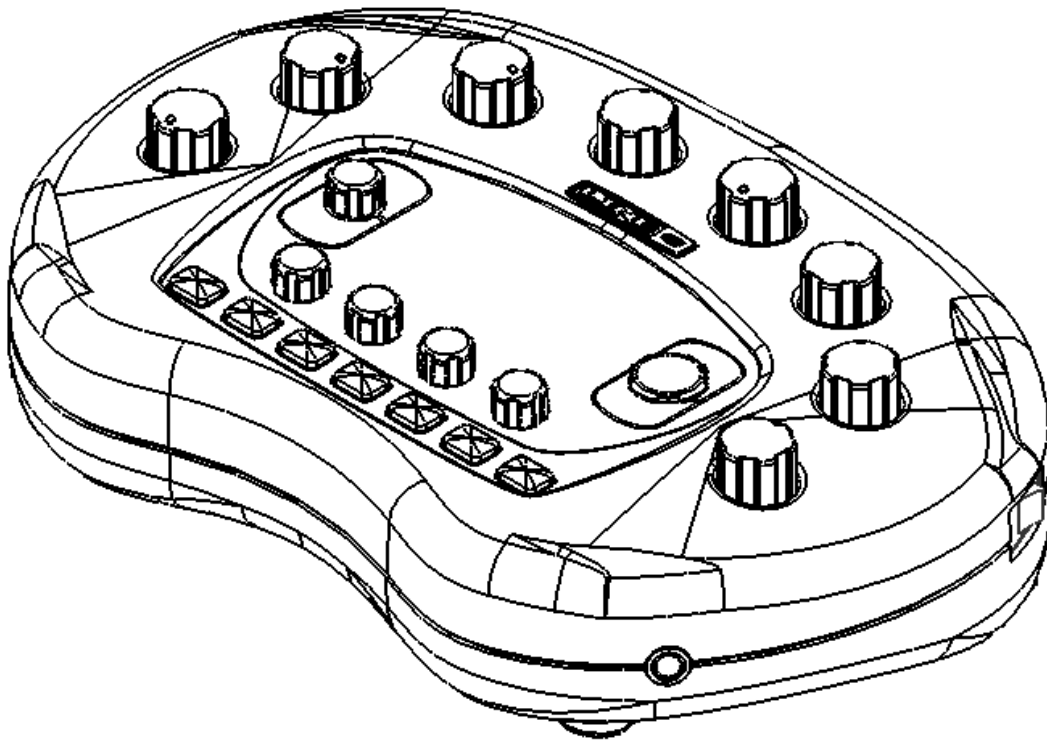

Forward and Notes

The information in this booklet applies to the P10-1 Complete Unit. It is suggested that the steps for assembly follow the order presented in these instructions.

These instructions deal with the assembling of the major subassemblies, the final product, and quality/inspection considerations. See also the Related Electrical assembly documentation for major considerations in assembling the electrical components of the PCBs (through the soldering process and preparation of the board for addition of custom components).

A note on the text: the illustrations in this book are for reference only. In some cases, color and geometry of illustrations may not accurately reflect the color or exact geometry of actual parts.

- Unless otherwise noted, all dimensions are in inches.
- Drawings are not to scale.
- Torque value tolerance +/- .5 in.-lbs. Do not over tighten any components.
- For clarity, not all component details are shown. This is especially true with respect to cable assemblies. They are often omitted from views to provide a clearer picture of the material discussed. Do not be confused by the absence (or unexpected presence) of any component in the illustrations in this book.



Revision Comment Sheet

Revision	Changes
A	Initial release. See ECO 0705904.

STEP 1

P/N required:

1 each **30-51-0276** CHASSIS BOTTOM

4 each **30-48-0010** RUBBER FOOT WITH ADHESIVE

Remove the protective film from the RUBBER FEET WITH ADHESIVE, and firmly press them into the round recesses of the CHASSIS BOTTOM as shown.

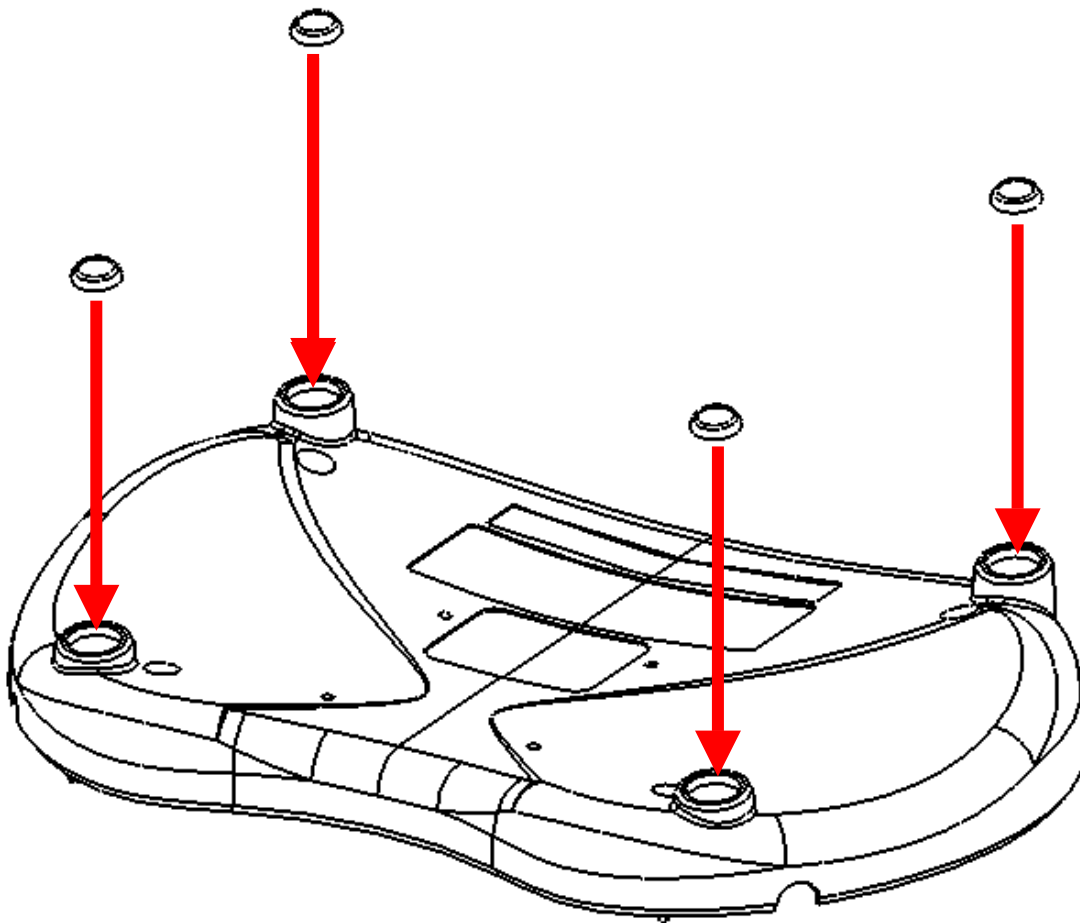

STEP 2

P/N required:

1 each **40-25-0020** LABEL INSPECTION QUALITY

1 each **40-25-0101** LABEL BAR CODE SERIAL NUMBER

1 each **40-25-0269** LABEL COMPLIANCE

Apply the LABEL INSPECTION QUALITY, LABEL BAR CODE SERIAL NUMBER, and LABEL COMPLIANCE in the recesses of the CHASSIS BOTTOM. The text shall be readable in the orientation shown.

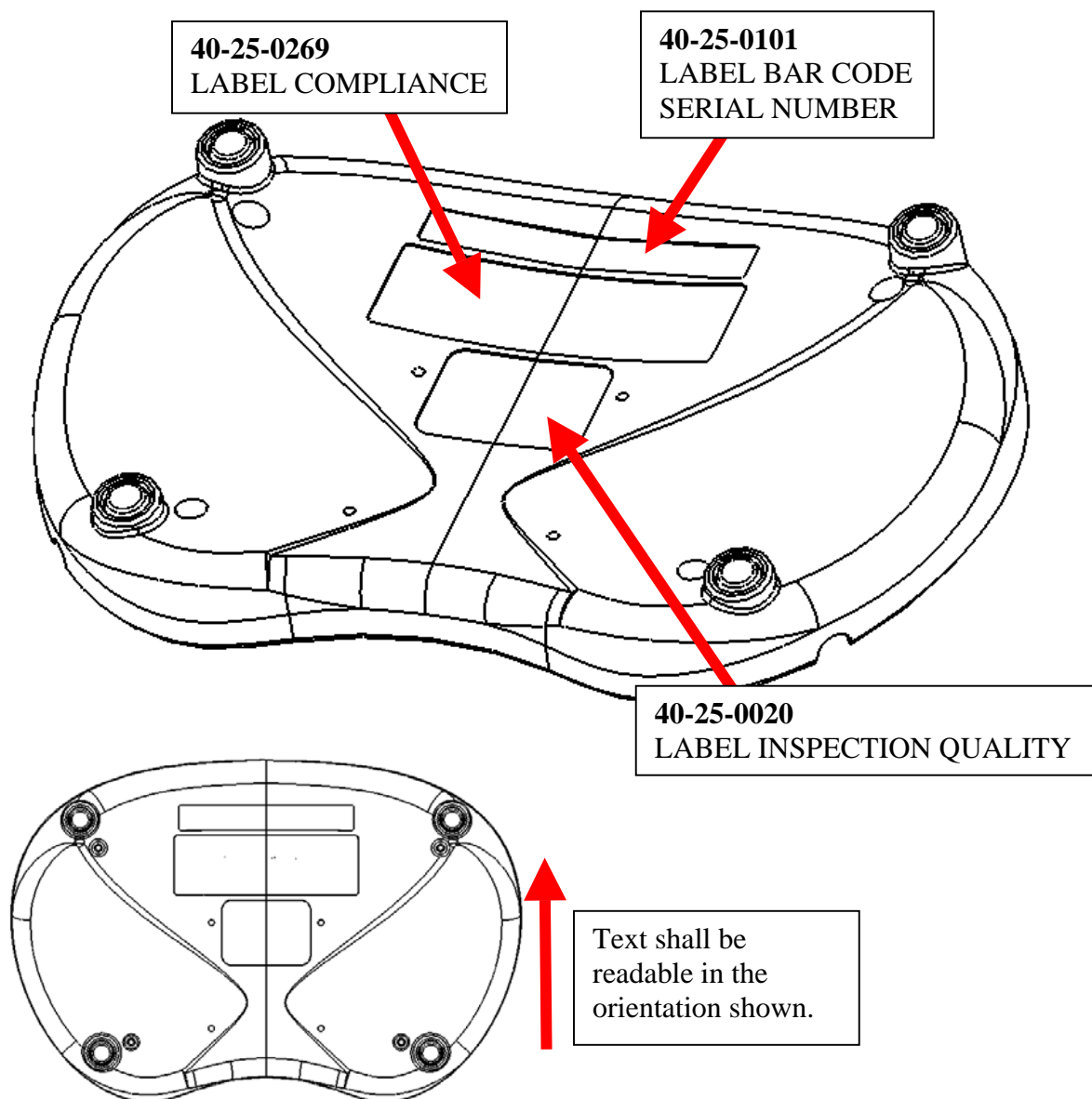

STEP 3

P/N required:

1 each **50-02-0079** MAIN PCBA

1 each **50-02-0118** LCD PCBA

4 each **30-27-0219** DUAL LOCKING SUPPORT

Attach the LCD PCBA to the MAIN PCBA with four DUAL LOCKING SUPPORTS.
The DUAL LOCKING SUPPORTS shall be fully engaged with the LCD PCBA and the MAIN PCBA.

Note: The ribbon cable between the MAIN PCBA and the LCD PCBA is not shown for clarity.

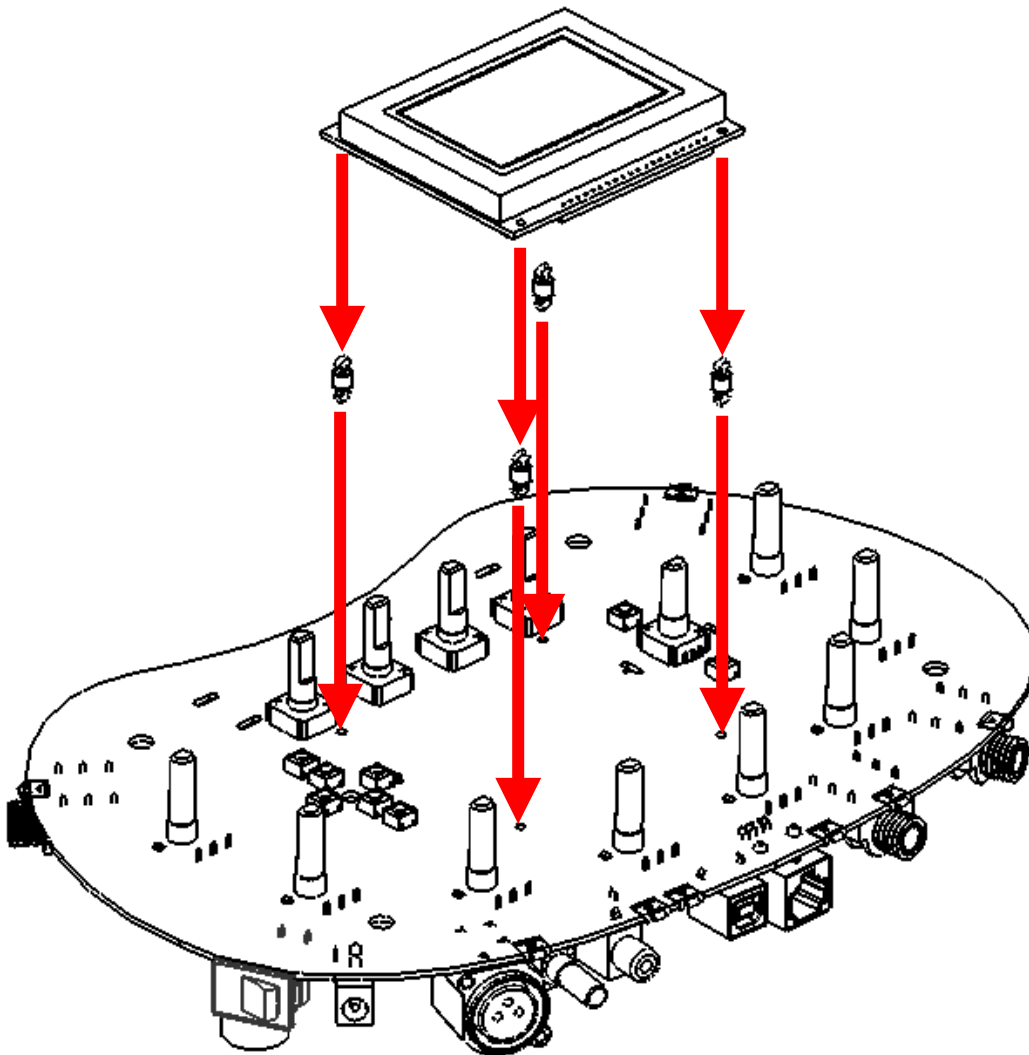

STEP 4

P/N required:

1 each **30-75-0048** RUBBER KEYPAD

Install the RUBBER KEYPAD onto the MAIN PCBA as shown. Secure the RUBBER KEYPAD by pulling the tabs through the slots on the MAIN PCBA. The RUBBER KEYPAD shall fit flat on the MAIN PCBA.

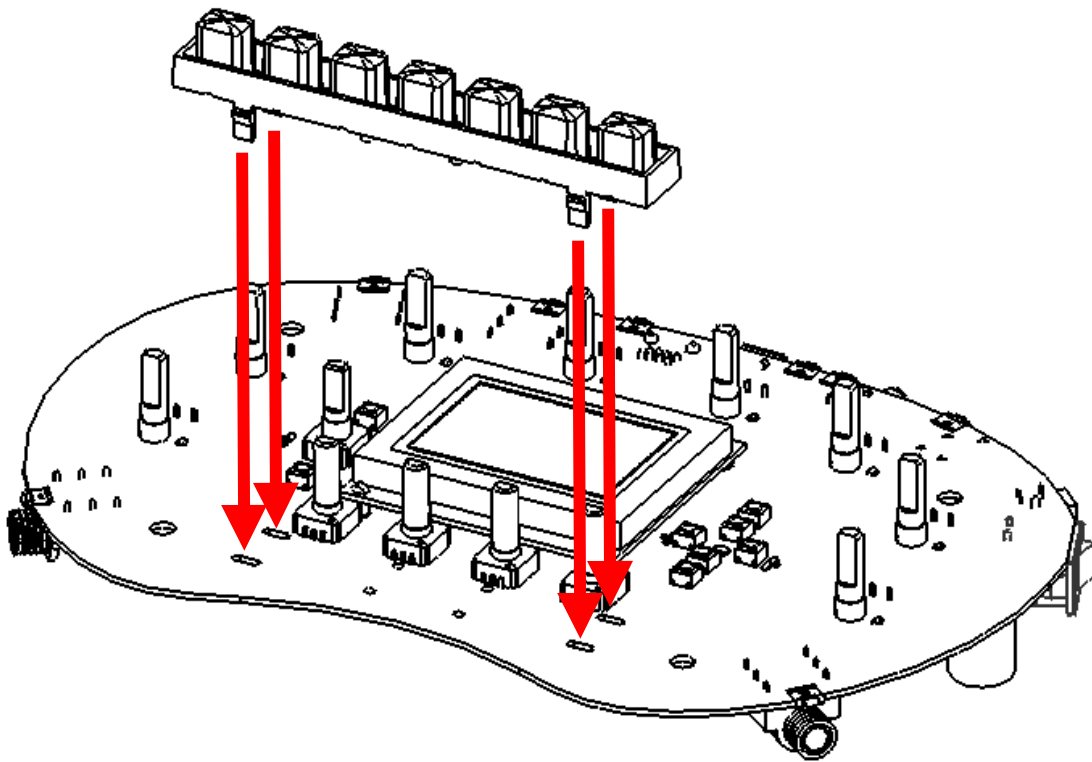

STEP 5

P/N required:

1 each **30-27-0221** 4-WAY SWITCH PIVOT PIN

Install the 4-WAY SWITCH PIVOT PIN into the hole between the tact switches as shown. Be sure that the 4-WAY SWITCH PIVOT PIN snaps completely into the hole.

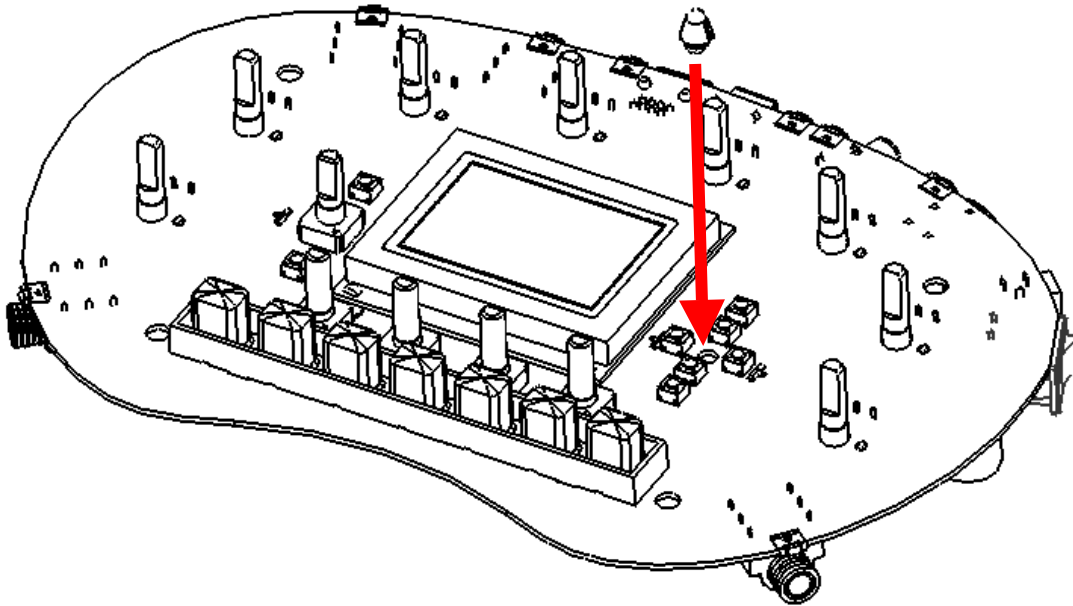

STEP 6

P/N required:
1 each **30-27-0208-1** DOUBLE BUTTON LEFT

Snap the DOUBLE BUTTON LEFT into the slots around the single encoder on the MAIN PCBA as shown. The DOUBLE BUTTON LEFT shall be oriented such that the text is readable in the orientation shown.

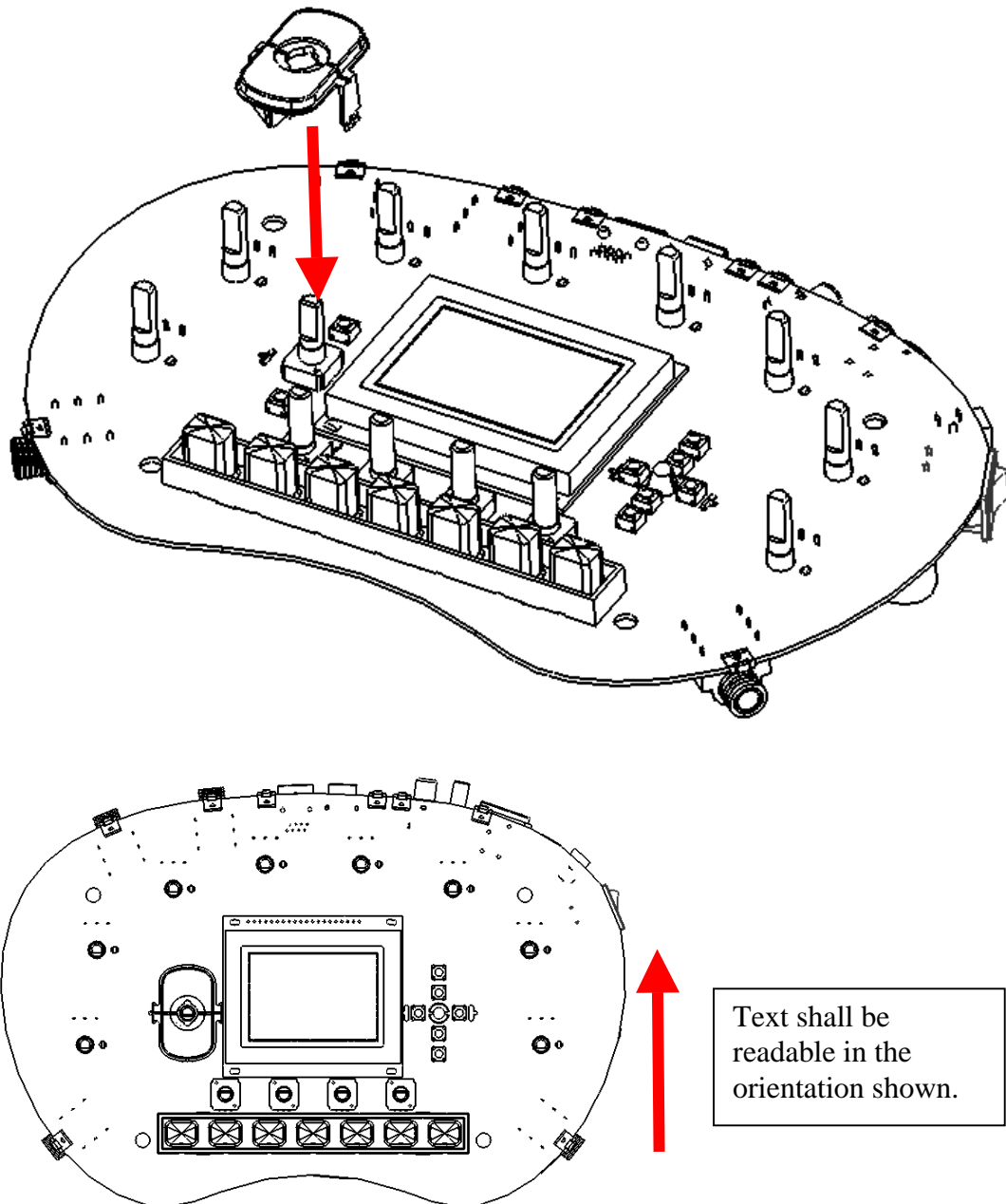

STEP 7

P/N required:

- 1 each **30-27-0217-1** 4-WAY BUTTON TOP
- 1 each **30-27-0208-2** DOUBLE BUTTON RIGHT
- 1 each **30-63-0028** 4-WAY BUTTON RETAINER RING
- 1 each **30-27-0218** 4-WAY BUTTON BOTTOM

Assemble the 4-WAY BUTTON TOP to the 4-WAY BUTTON BOTTOM by snapping them through the DOUBLE BUTTON RIGHT and 4-WAY BUTTON RETAINER RING as shown.

Be sure that the 4-WAY BUTTON TOP snap features expand fully when assembled.

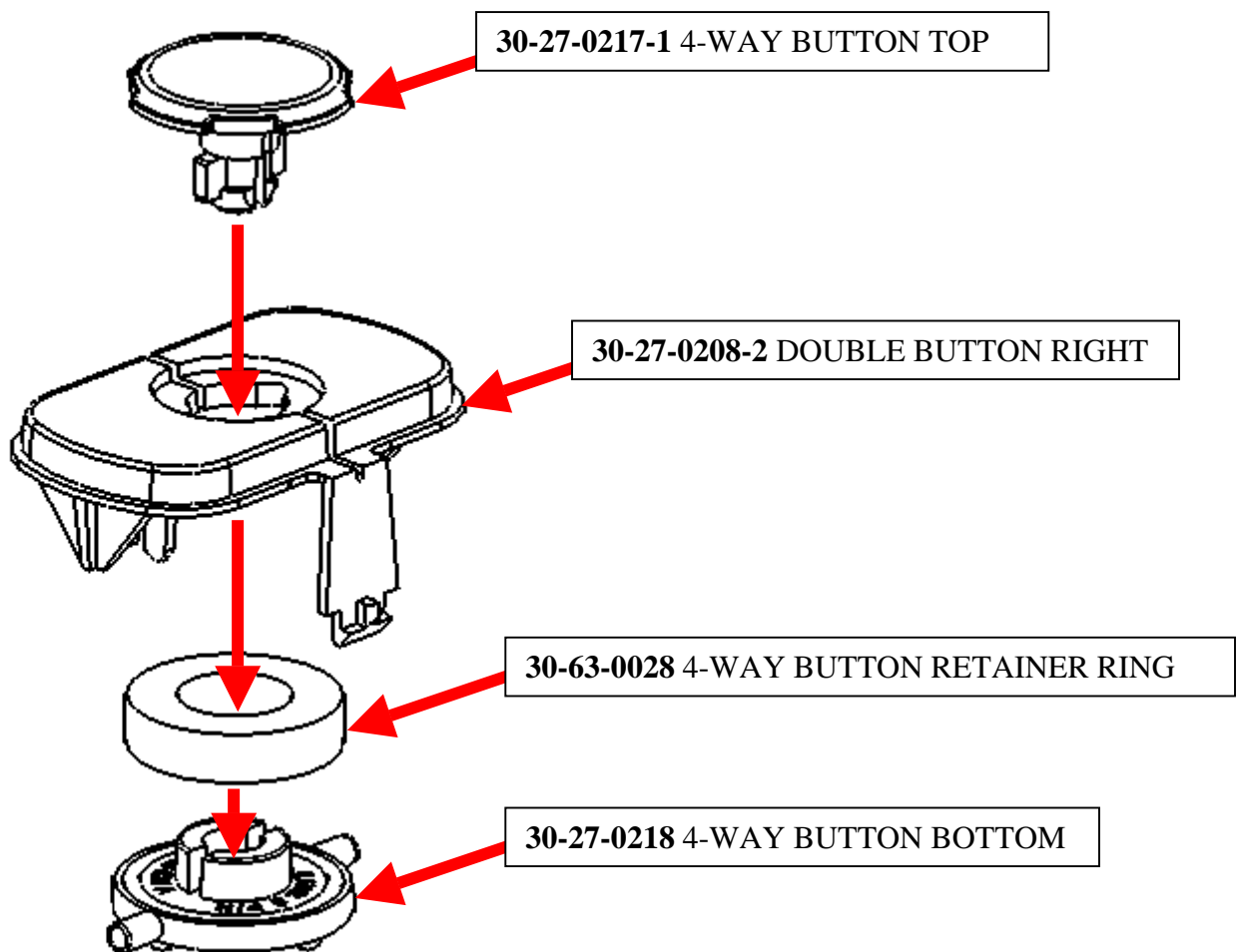

(Step 7 is continued on the next page.)

STEP 7 (continued)

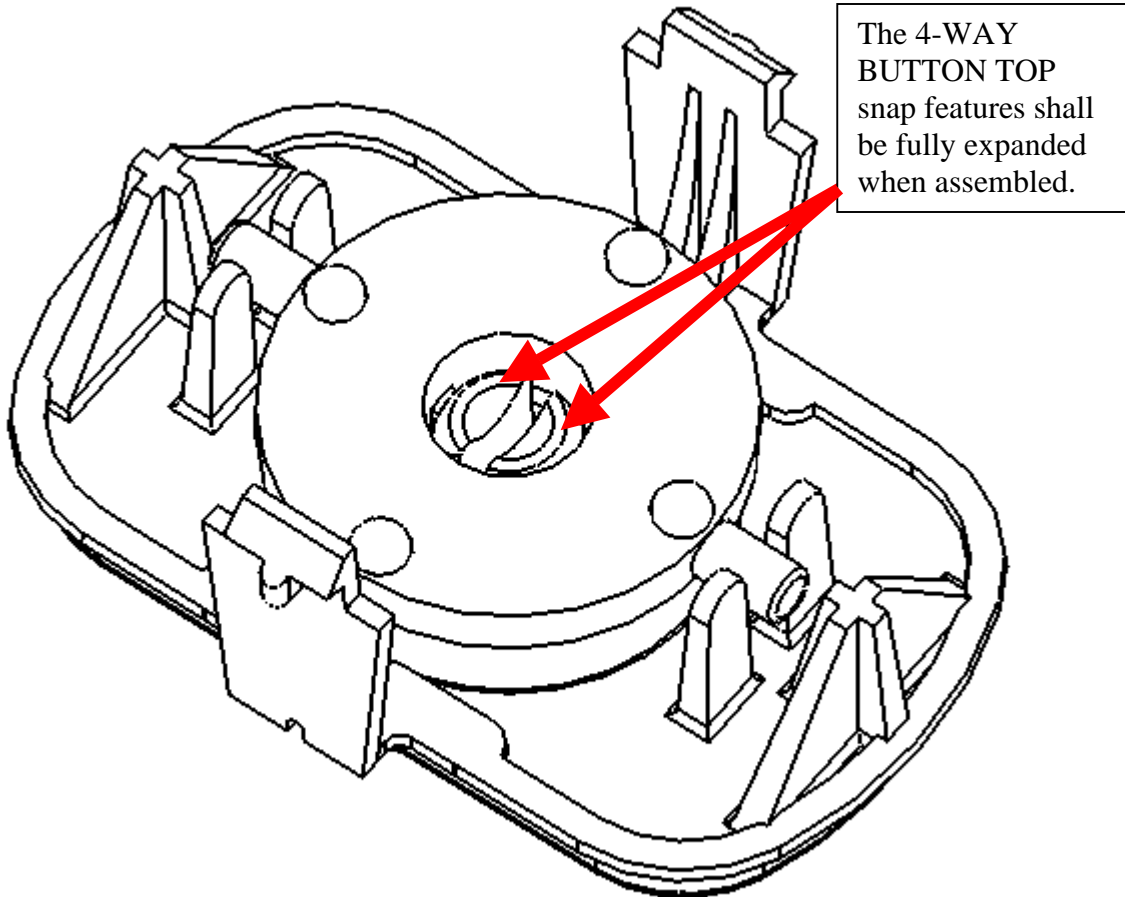

STEP 8

Snap the DOUBLE BUTTON assembly from the previous step into the slots around the four tact switches on the MAIN PCBA as shown. The DOUBLE BUTTON RIGHT shall be oriented such that the text is readable in the orientation shown.

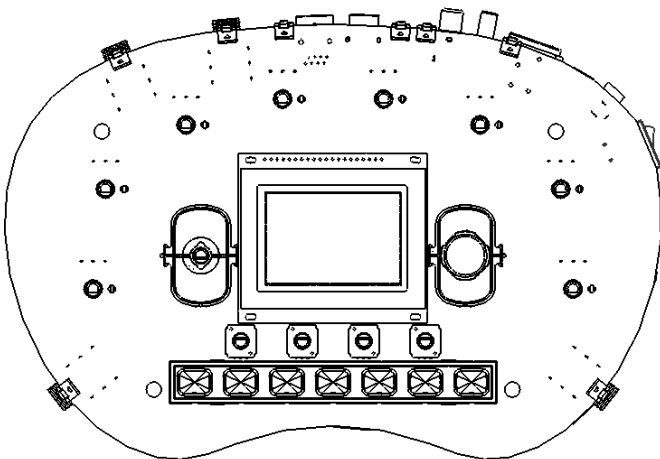
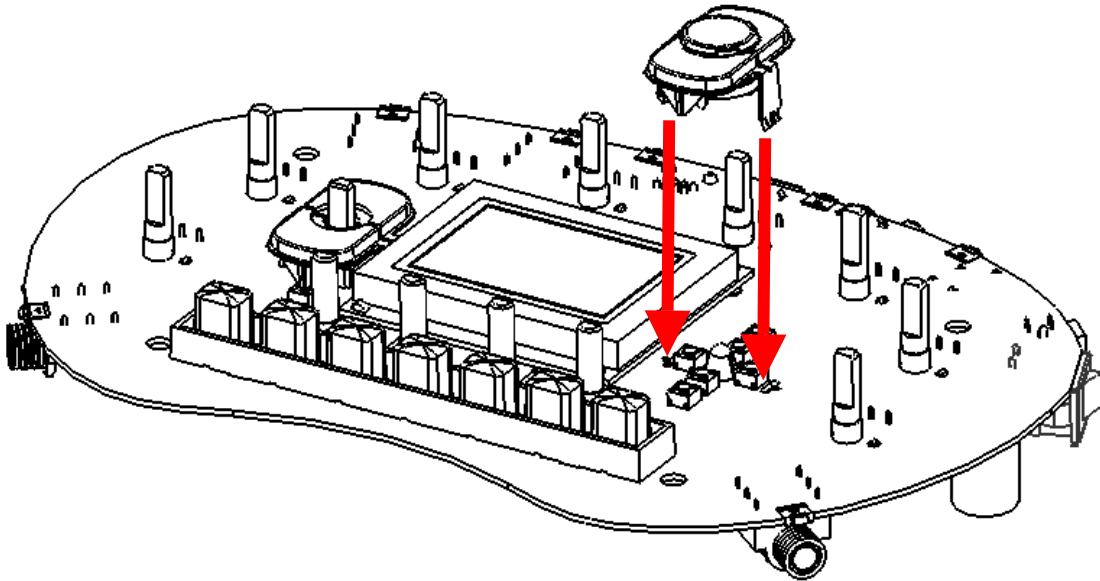

Text shall be readable in the orientation shown.

STEP 9

Apply RTV or hot glue adhesive to the snap features of the DOUBLE BUTTONS on the bottom of the MAIN PCBA.

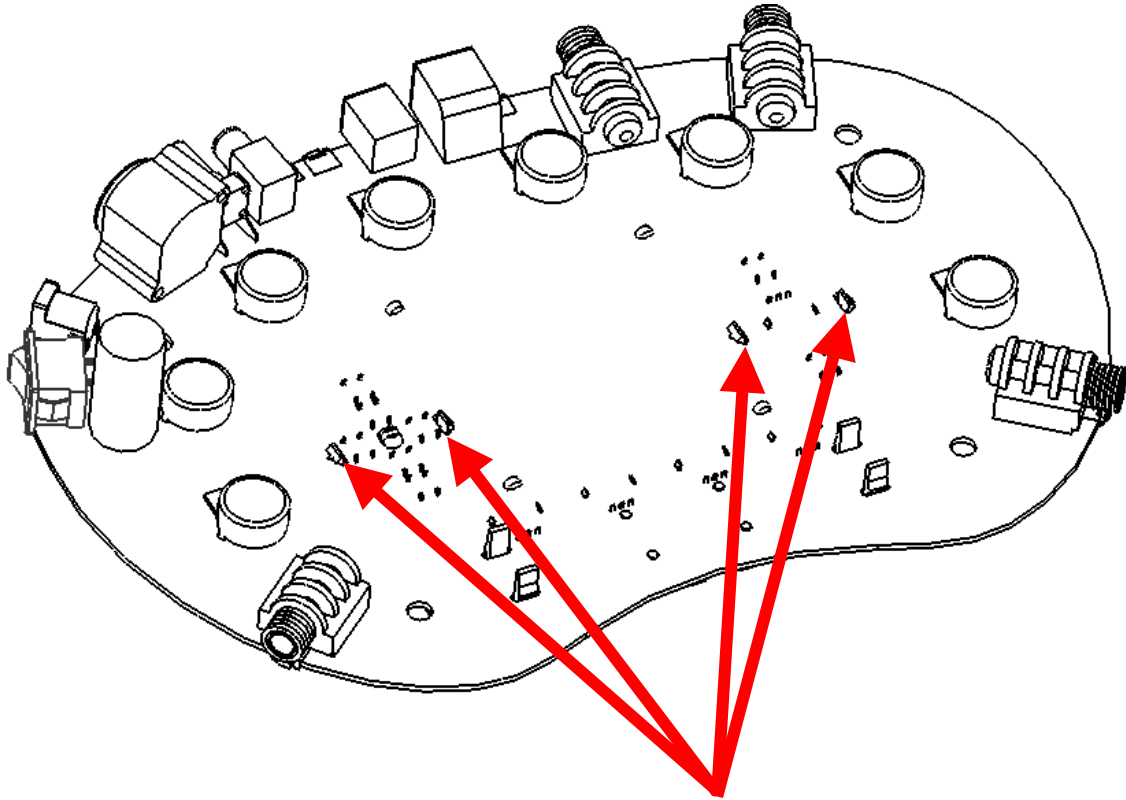

STEP 10

P/N required:

1 each **30-60-0006** LOGO

1 each **30-51-0275** CHASSIS TOP

Remove the protective backing from the LOGO and firmly press it into the recess in the CHASSIS TOP as shown. The LOGO shall be oriented such that it is readable in the direction shown.

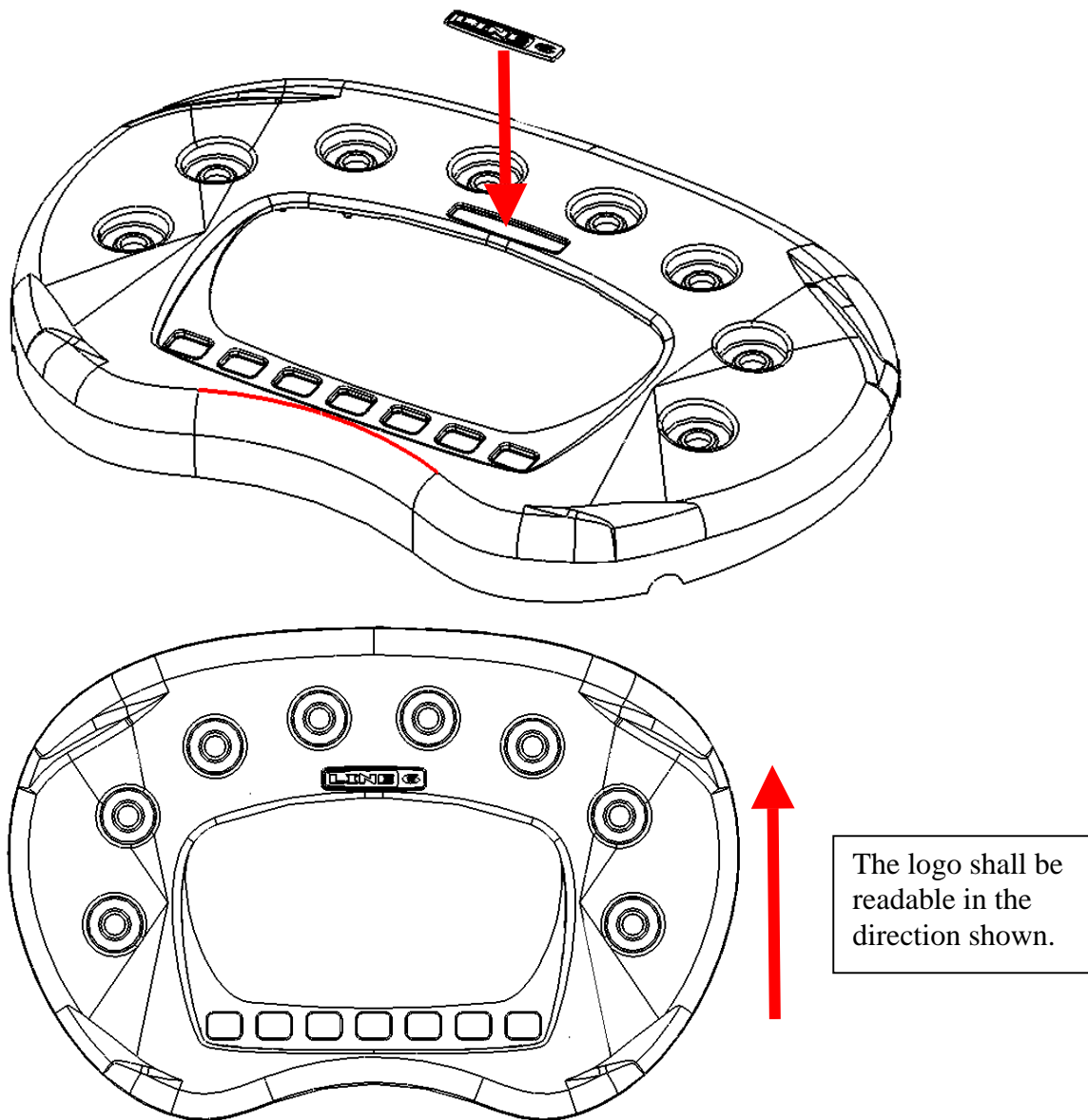

STEP 11

P/N required:

1 each **30-27-0207** DISPLAY BEZEL

6 each **30-51-0277** PUSH RETAINER

Secure the DISPLAY BEZEL to the CHASSIS TOP with six PUSH RETAINERS. Press the PUSH RETAINERS onto the posts in the CHASSIS TOP fully.

The DISPLAY BEZEL shall be oriented with the text readable from the outside of the assembly as shown.

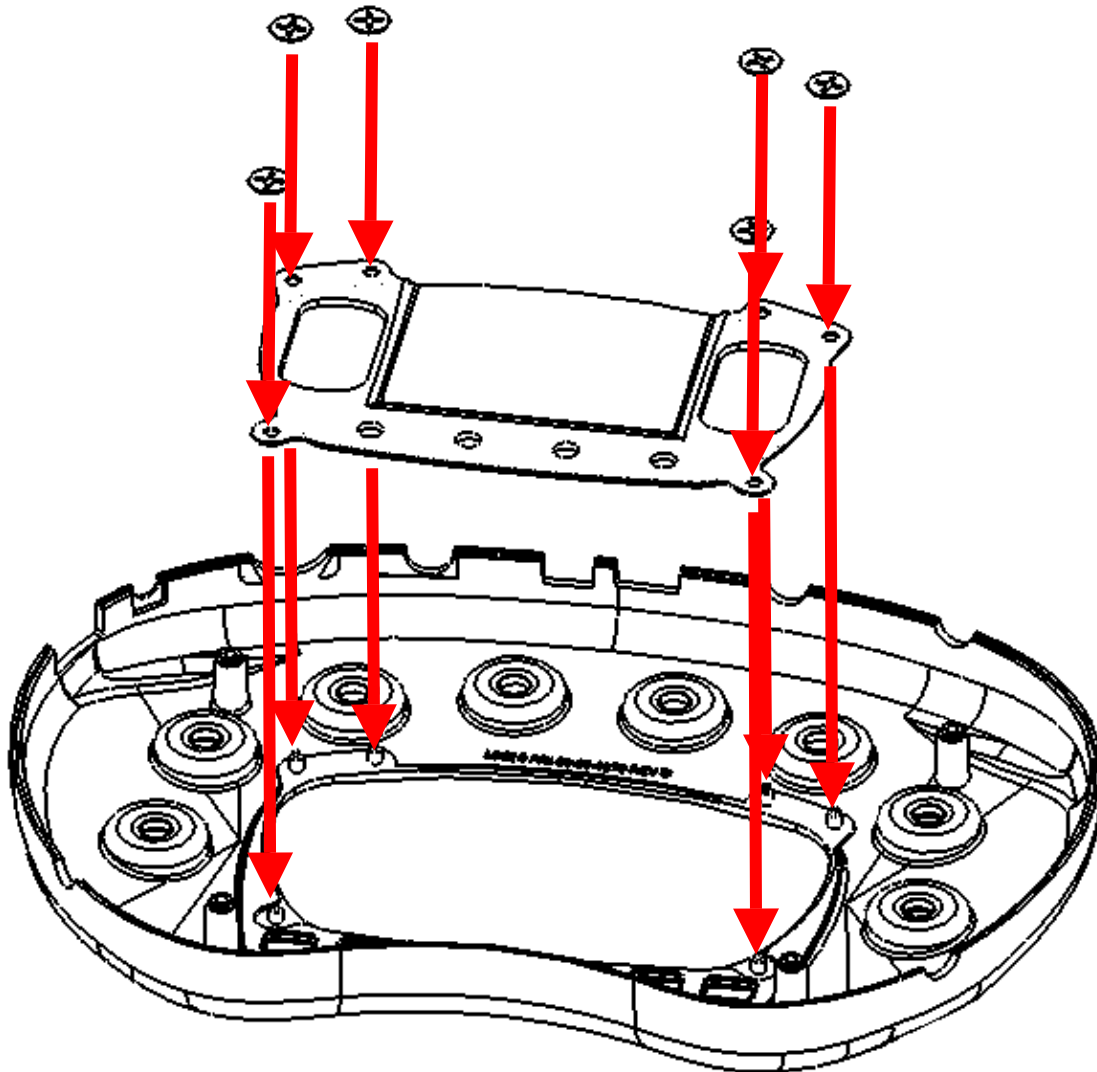

(Step 11 is continued on the next page.)

STEP 11 (continued)

The text on the DISPLAY
BEZEL shall be readable
from this side.

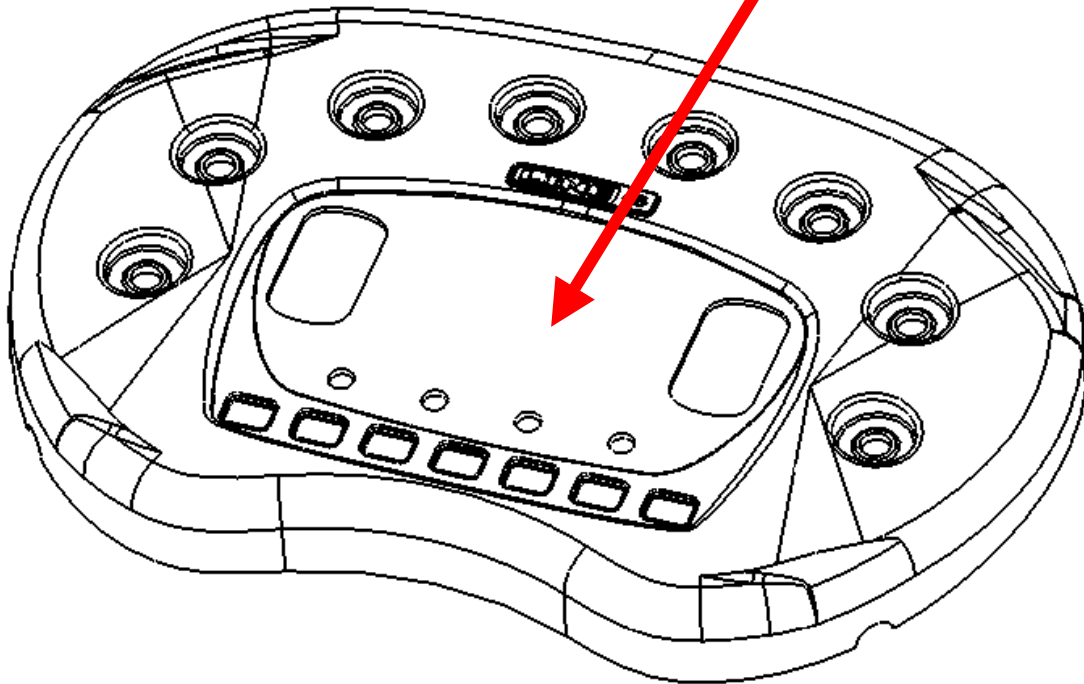

STEP 12

Place the MAIN PCBA into the CHASSIS BOTTOM such that the four mounting holes on the MAIN PCBA align with the mounting bosses in the CHASSIS BOTTOM.

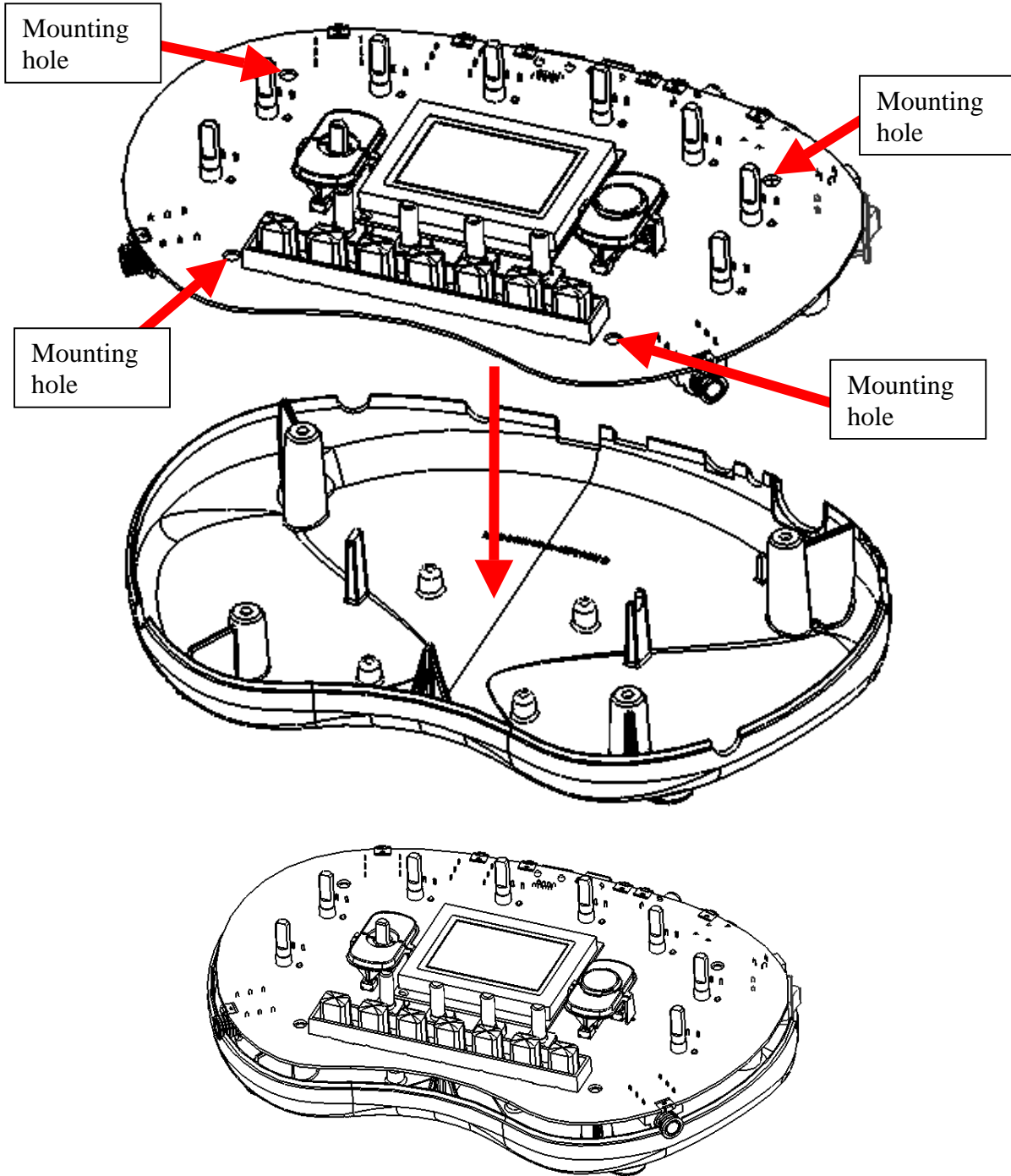

STEP 13

P/N required:
4 each **30-15-0038** ENCODER SPACER

Place an ENCODER SPACER over the shaft of each of the four encoders on the MAIN PCBA.

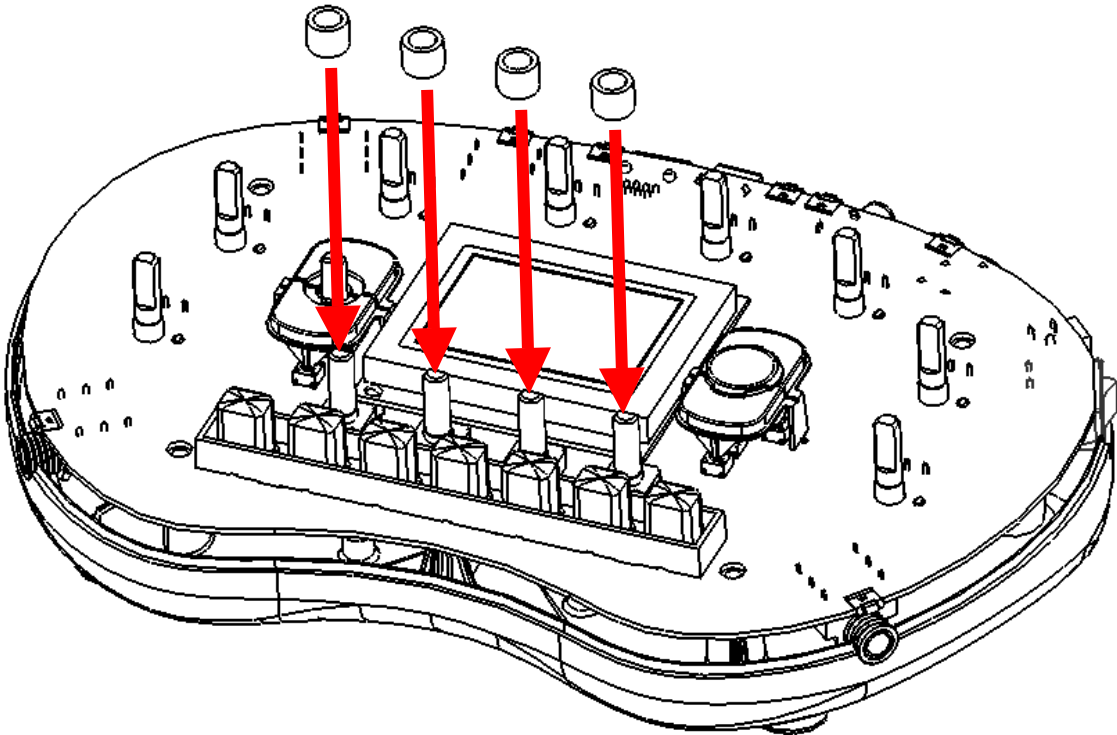

STEP 14

P/N required:

4 each **30-00-1632 SCREW** 6-32 x 3/8"

Place the CHASSIS TOP onto the assembly and secure with four SCREWS 6-32 x 3/8". Torque the screws until the heads are fully seated. Fully seating the screws should require approximately 11 inch-pounds of torque (14 inch-pounds maximum).

Do not over tighten the screws since this will damage the threads and the CHASSIS TOP.

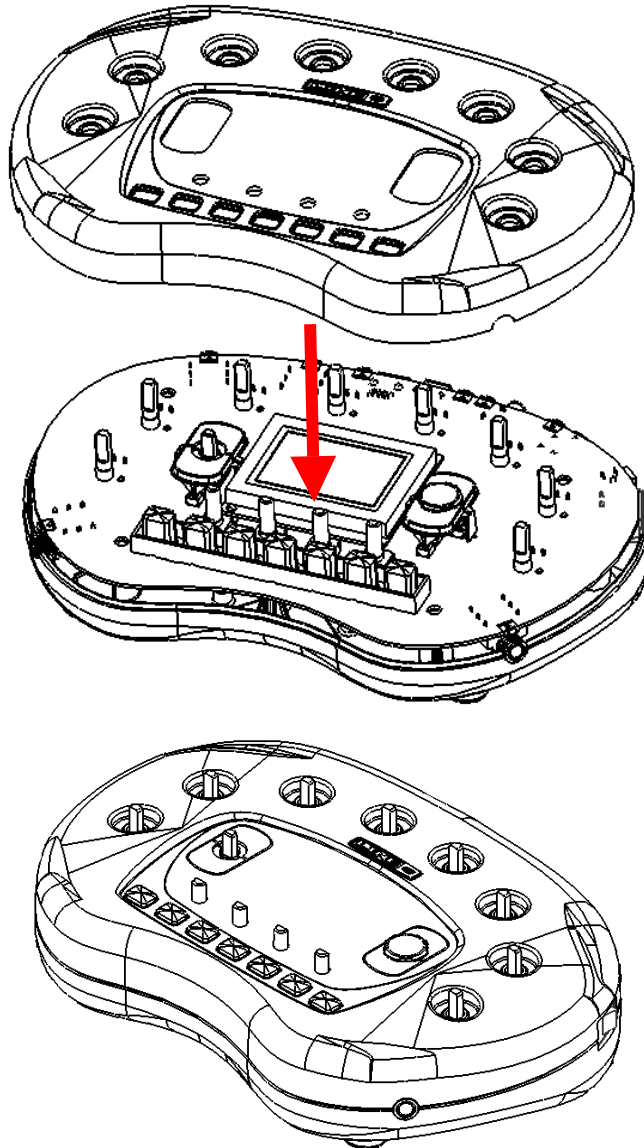

(Step 14 is continued on the next page.)

STEP 14 (continued)

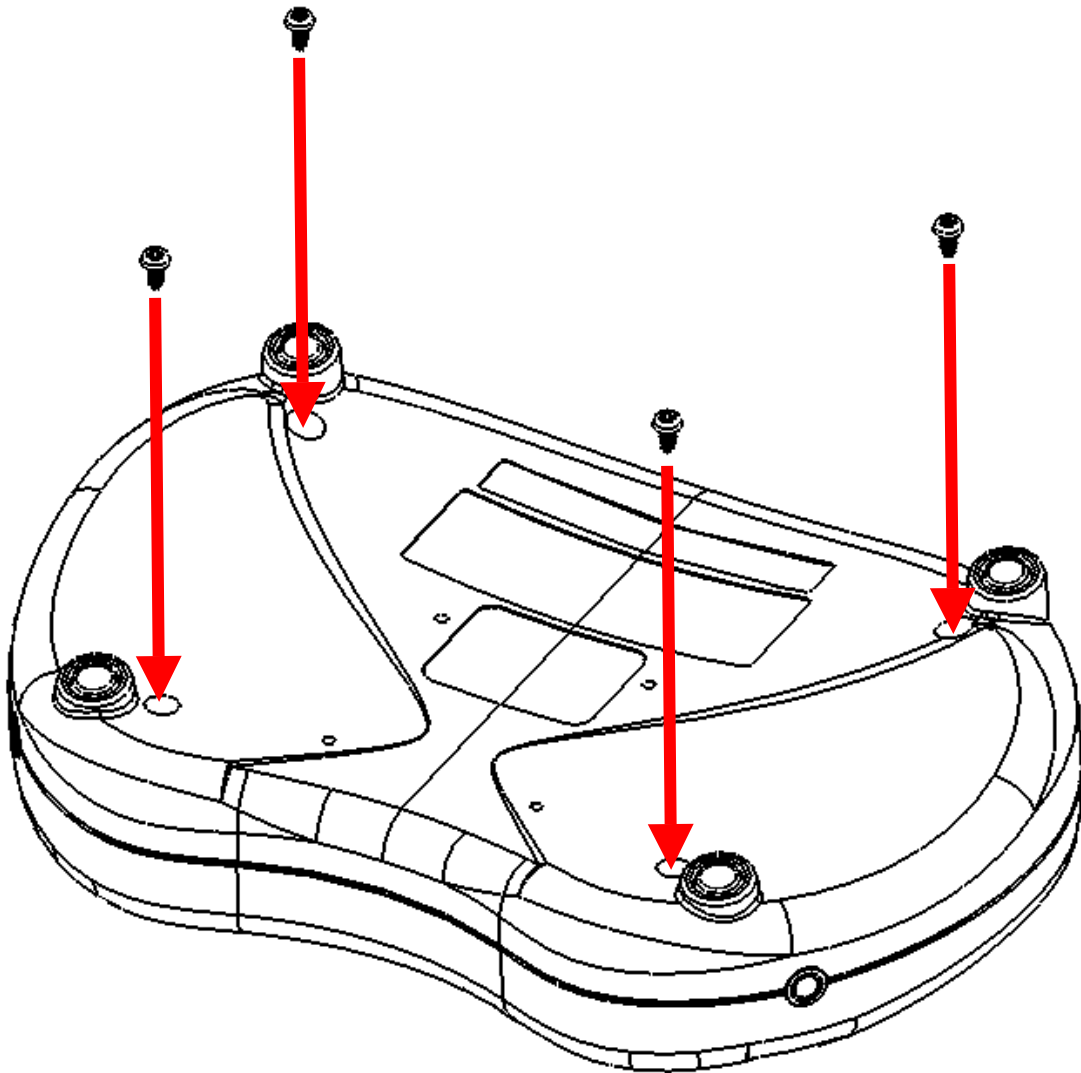

STEP 15

P/N required:

4 each **30-27-0222-1** KNOB

1 each **30-27-0222-2** KNOB WITH ARTWORK

Press one KNOB fully onto the shaft of each of the four encoders along the lower edge of the DISPLAY BEZEL.

Press one KNOB WITH ARTWORK fully onto the shaft of the encoder on the left side of the DISPLAY BEZEL.

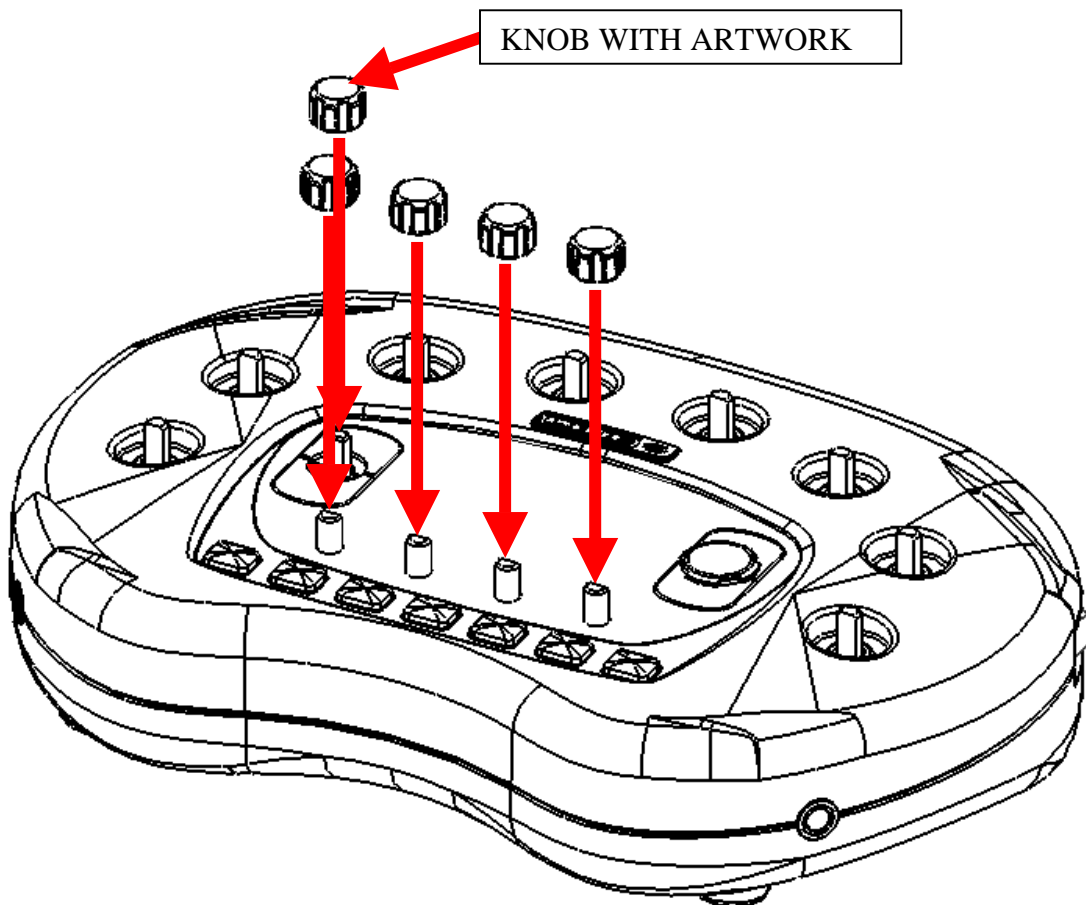

STEP 16

P/N required:
8 each **30-45-0011** KNOB, CHROME-PLATED

Press one KNOB, CHROME-PLATED fully onto the shaft of each of the eight pots.

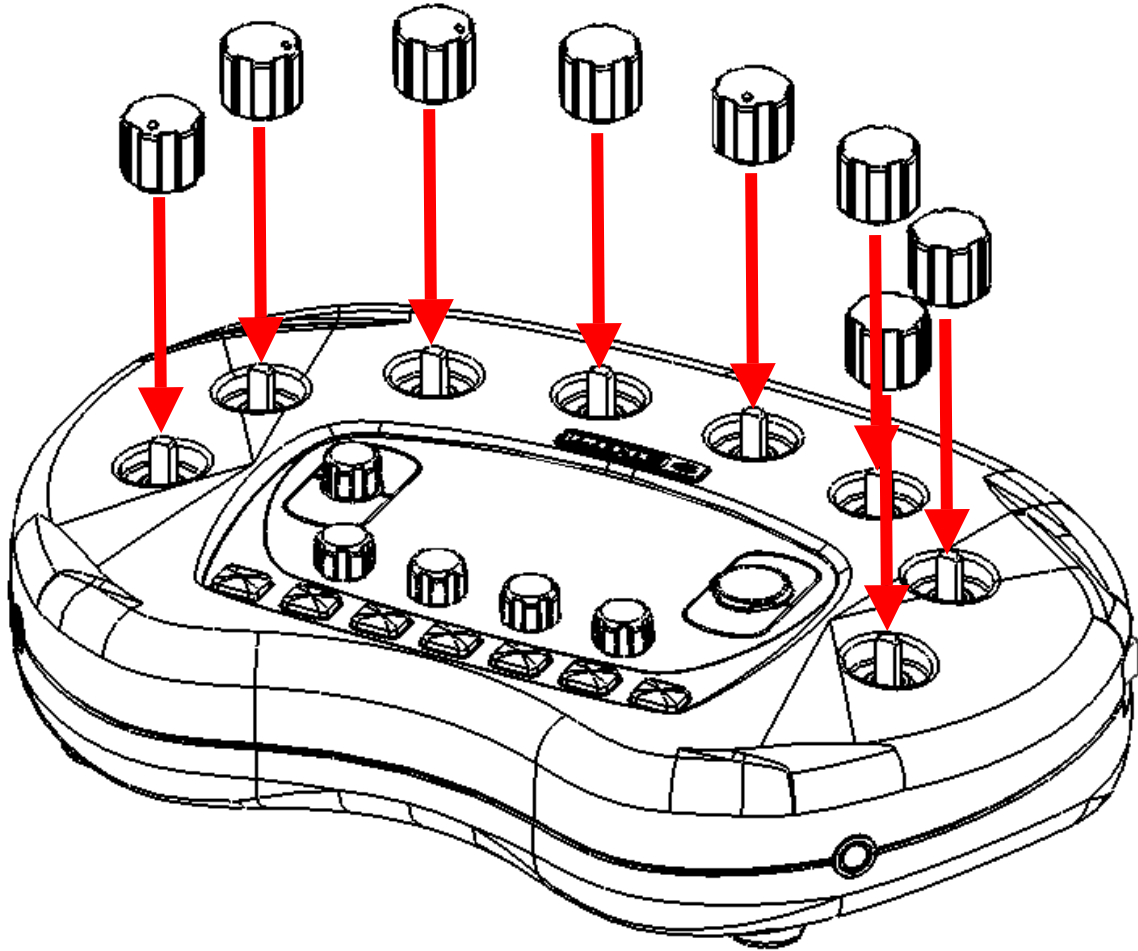

Assembly of the P10-1 Complete Unit is now complete.



POD X3 POD X3 Live

Pilot's Handbook

Manuel de pilotage

Pilotenhandbuch

Pilotenhandboek

Manual del Piloto

An in-depth exploration of the advanced technologies and pulsing tonal pleasures of POD X3 & POD X3 Live.

The serial number can be found on the bottom of your POD X3 or POD X3 Live. It's the number that begins with "(21)". Please note it here for future reference:

SERIAL NO: _____

WARNING: To reduce the risk of fire or electric shock, do not expose this appliance to rain or moisture.

CAUTION: To reduce the risk of fire or electric shock, do not remove screws. No user-serviceable parts inside. Refer servicing to qualified service personnel.

NOTICE: This equipment has been tested and found to comply with the limits for a Class B digital device pursuant to Part 15 of FCC Rules. Operation is subject to the following two conditions: (1) This device may not cause harmful interference, and (2) this device must accept any interference received, including interference that may cause undesired operation.



The lightning symbol within a triangle means "electrical caution!" It indicates the presence of information about operating voltage and potential risks of electrical shock.



The exclamation point within a triangle means "caution!" Please read the information next to all caution signs.

You should read these Important Safety Instructions

Keep these instructions in a safe place

Before using your POD X3 or POD X3 Live, carefully read the applicable items of these operating instructions and safety suggestions.

1. Obey all warnings on the POD X3, POD X3 Live, and in this Pilot's Handbook.
2. Do not place near heat sources, such as radiators, heat registers, or appliances which produce heat.
3. Guard against objects or liquids entering the enclosure.
4. Connect only to AC power outlets rated 100-120V or 230V 47-63Hz (depending on the voltage range of the included power supply).
5. Do not step on power cords. Do not place items on top of power cords so that they are pinched or leaned on. Pay particular attention to the cord at the plug end and the point where it connects to the POD X3 or POD X3 Live.
6. Unplug your POD X3 or POD X3 Live when not in use for extended periods of time.
7. Do not perform service operations beyond those described in this Pilot's Handbook. In the following circumstances, repairs should be performed only by qualified service personnel:
 - liquid is spilled into the unit
 - an object falls into the unit
 - the unit does not operate normally or changes in performance in a significant way
 - the unit is dropped or the enclosure is damaged
8. Prolonged listening at high volume levels may cause irreparable hearing loss and/or damage. Always be sure to practice "safe listening."

Please Note:

Line 6, POD, POD X3, POD X3 Live, PODxt, Vetta, FBV, FBV Shortboard, FBV Express, and FBV4 are trademarks of Line 6, Inc. All other product names, trademarks, and artists' names are the property of their respective owners, which are in no way associated or affiliated with Line 6. Product names, images, and artists' names are used solely to identify the products whose tones and sounds were studied during Line 6's sound model development for this product. The use of these products, trademarks, images, and artists' names does not imply any cooperation or endorsement.

Table of Contents

Tutorial: POD X3 Live for Guitar	1•1
Tutorial: POD X3 for Guitar	2•1
Controls & Connections	3•1
POD X3.....	3•1
POD X3 Live.....	3•8
Getting Around, Tones & Tuner	4•1
Home Page.....	4•1
The Dual Tone Concept.....	4•3
Dual Tone Volume Controls.....	4•5
Preset Folders.....	4•6
Recalling Presets.....	4•7
Recalling User Presets on POD X3 Live.....	4•8
Locking Tone 2.....	4•9
Saving Tones.....	4•9
Tuner.....	4•10
Reference: Tweaking Tones	5•1
Amp + Cab.....	5•1
Tone Controls.....	5•2
Stomp Boxes.....	5•4
Modulation Effects.....	5•7
Delay.....	5•9
Reverb.....	5•11
Gate.....	5•12
Compressor.....	5•13
EQ.....	5•14

Wah.....	5•15
Volume.....	5•16
Effects Loop (POD X3 Live only).....	5•17

Reference: Configuration & Setup 6•1

Inputs.....	6•1
Outputs.....	6•2
System.....	6•5
Commands.....	6•7

Example Setups 7•1

Mono or Stereo Recording or Direct to Mixer/PA.....	7•1
Recording Tone 1 & 2 to Separate Mono Tracks.....	7•2
Recording Tone 1 & 2 to Separate Stereo Tracks (POD X3 Live only).....	7•2
Feed One Guitar Amp.....	7•3
Feed Two Guitar Amps, One for Tone 1 and One for Tone 2.....	7•3
Feed Two Guitar Amps, One “Wet” and One “Dry”.....	7•4
Feed a Guitar Amp and Send Separate XLR Direct Outs (POD X3 Live only).....	7•5
Electric Guitar to On-Stage Amp & Direct Out + Vocals/Acoustic/etc. to Direct Out Only.....	7•6

USB & Computer Software..... 8•1

Updating POD X3 or POD X3 Live’s Firmware.....	8•1
Setting Up for USB Recording.....	8•2

Appendix A: Model Gallery A•1

Appendix B: Signal Flow B•1

POD X3 Live.....	B•1
POD X3.....	B•2

TUTORIAL: POD X3 LIVE FOR GUITAR

1. Plug your guitar into Guitar In.

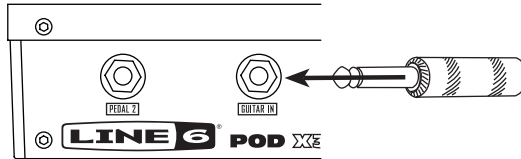

2. Turn on POD X3 Live.
3. Recall User Preset “32D: Tutorial1”.

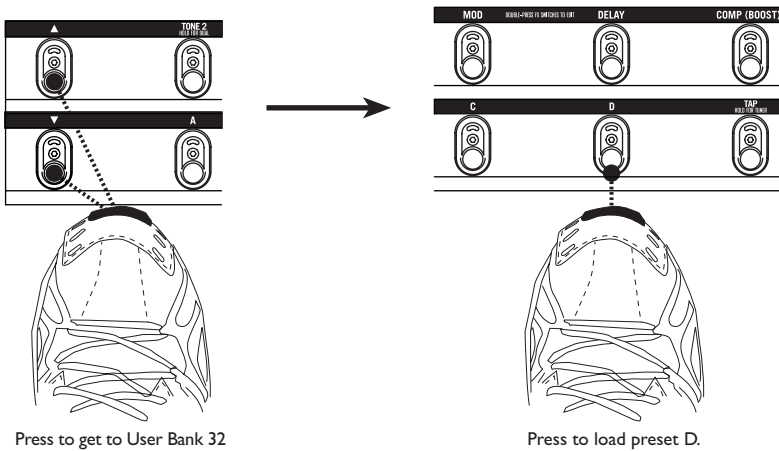

4. The Home Page shows with the Amp+Cab block selected.

The outlined block is the selected one.

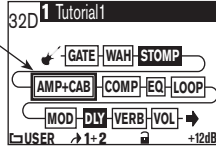

5. Pick an Amp Model.

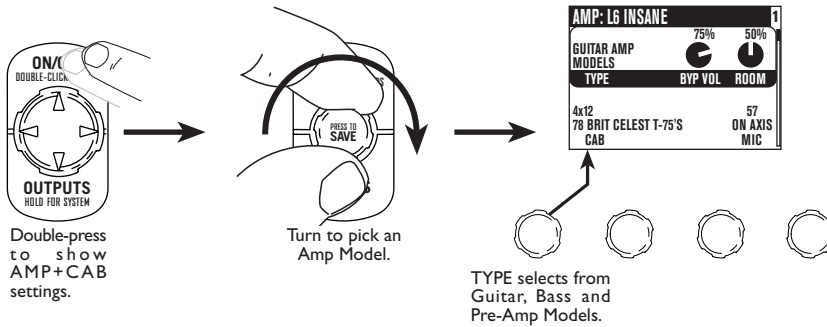

6. Tweak the Amp Tone Controls.

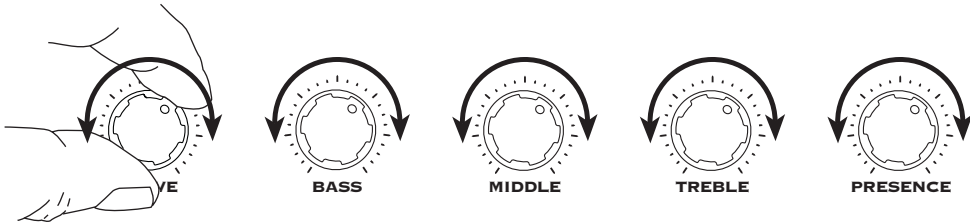

7. Pick a Stomp Model and tweak it.

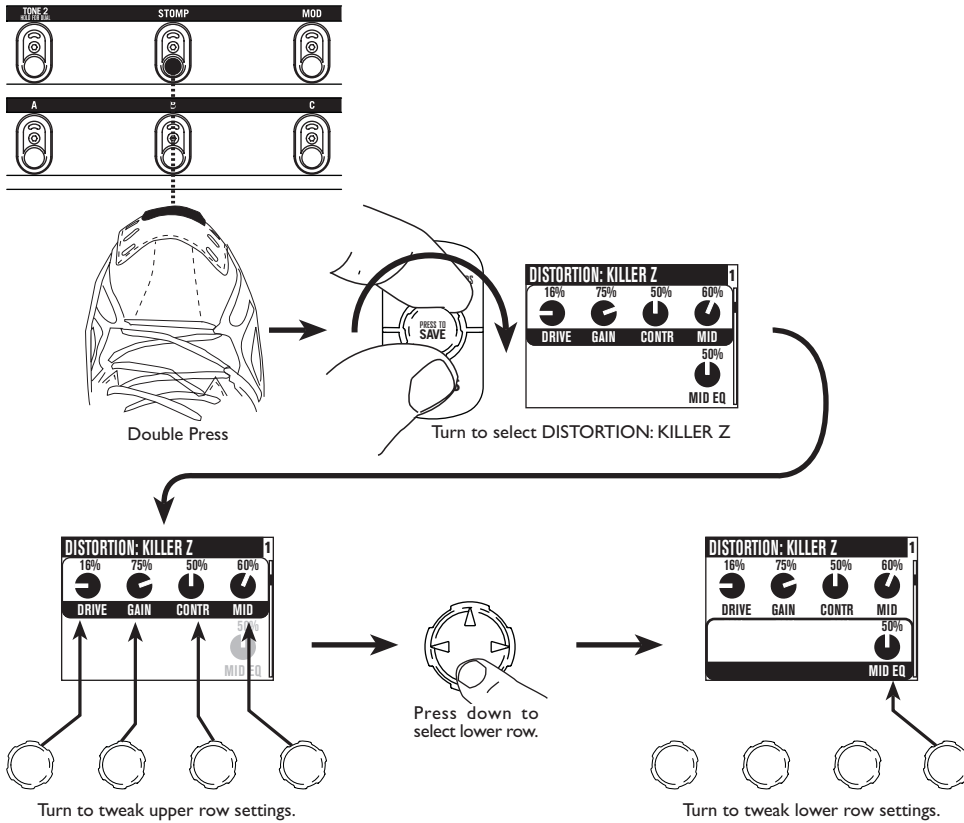

8. Show the Delay settings.

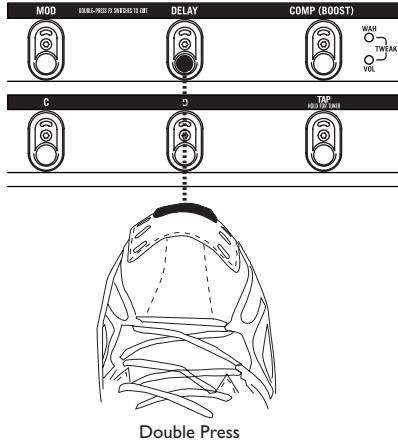

9. Set the Delay tempo, and set it to run post (after the Amp Model).

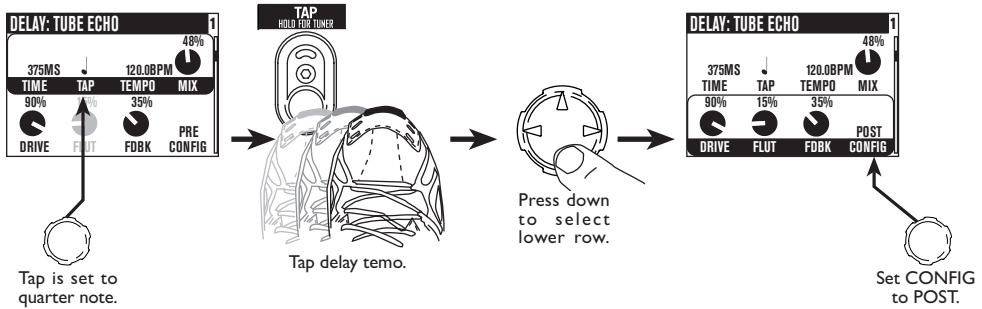

10. Select the EQ.

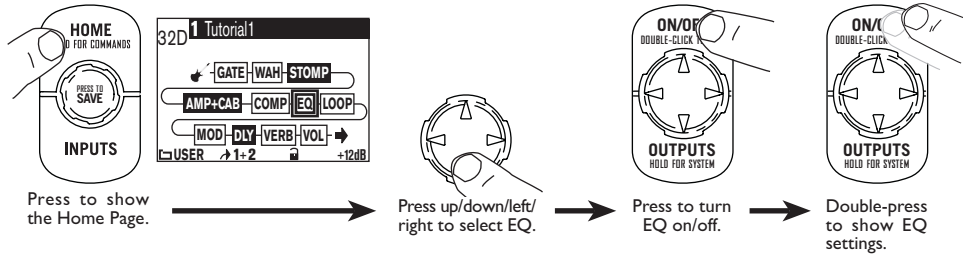

11. Tweak the EQ.

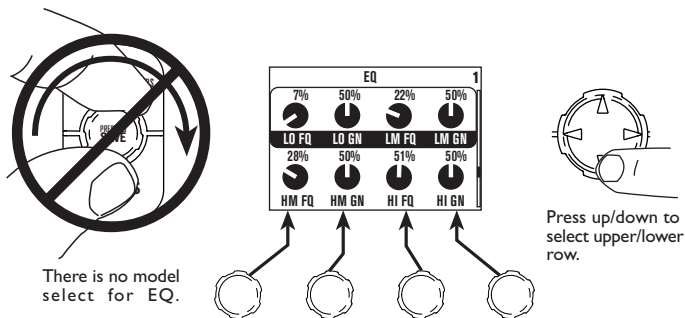

12. Turn Tone 2 on.

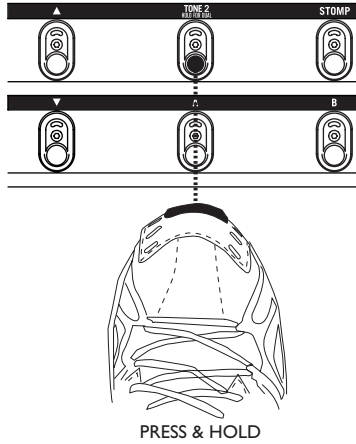

13. Load preset to Tone 2 Only.

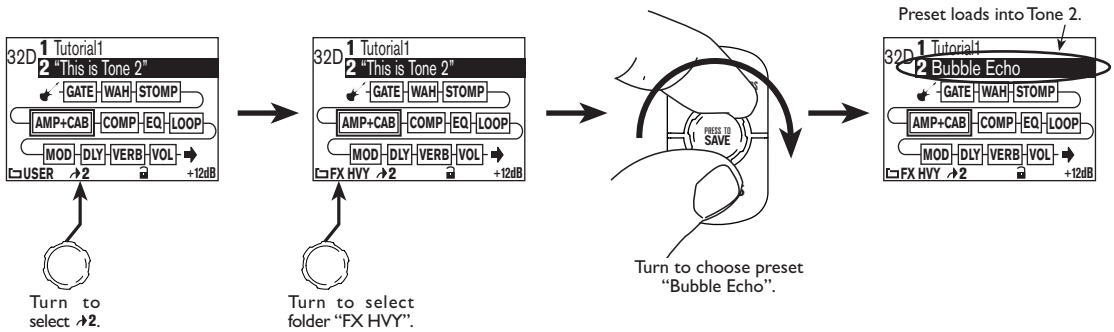

16. Tweak combined volume of Tone 1 + Tone 2.

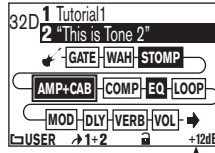

17. Save.

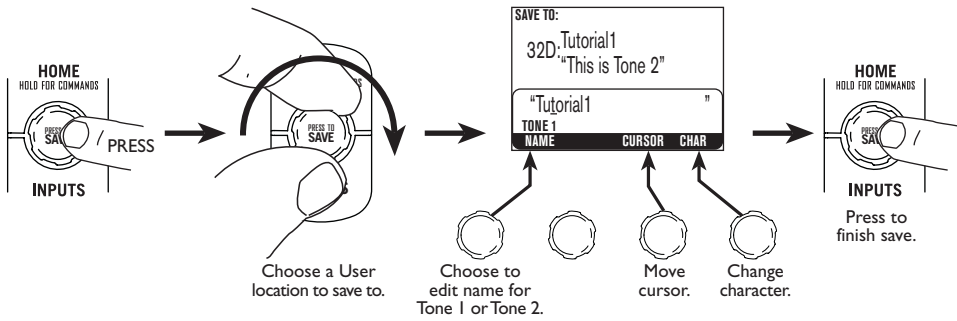

TUTORIAL: POD X3 FOR GUITAR

1. Plug your guitar into Input 1.

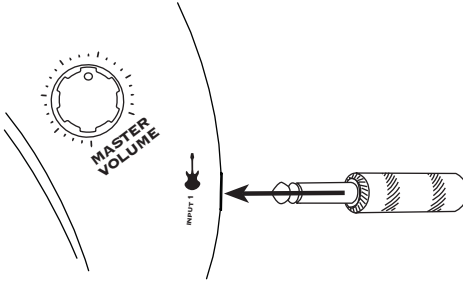

2•1

2. Turn on POD X3.
3. Recall User Preset “32D:Tutorial1”.

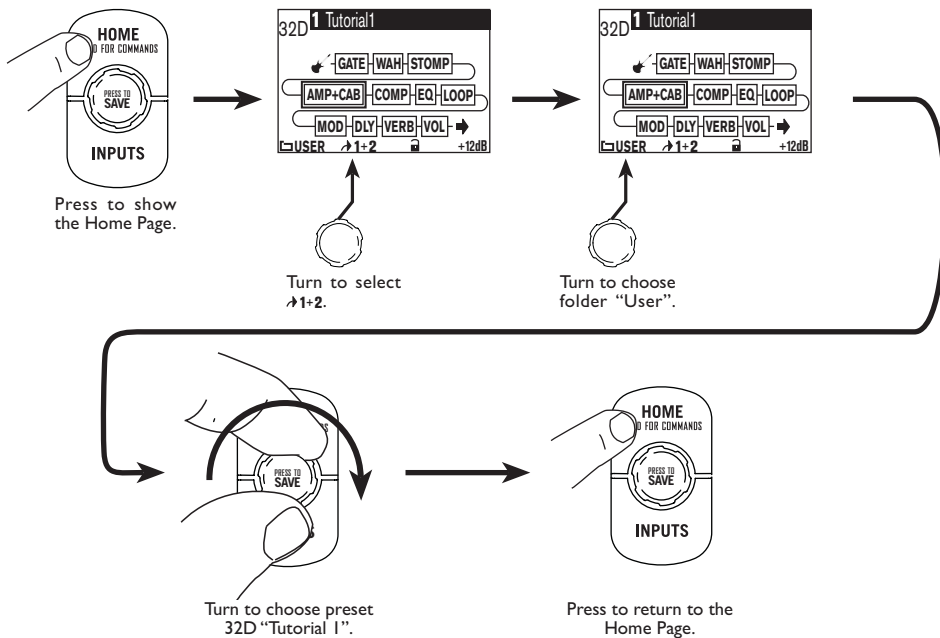

4. Turn on the Amp Model.

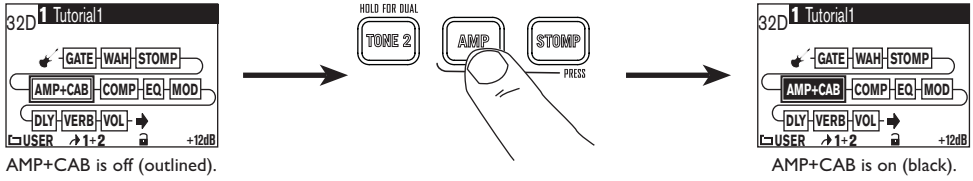

5. Pick an Amp Model.

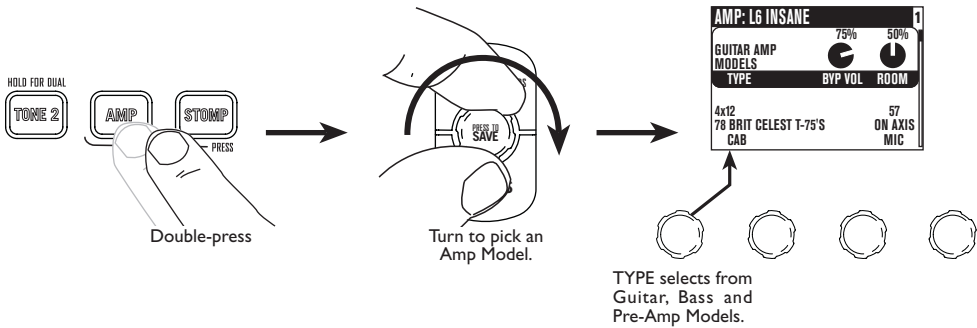

6. Tweak the Amp Tone Controls.

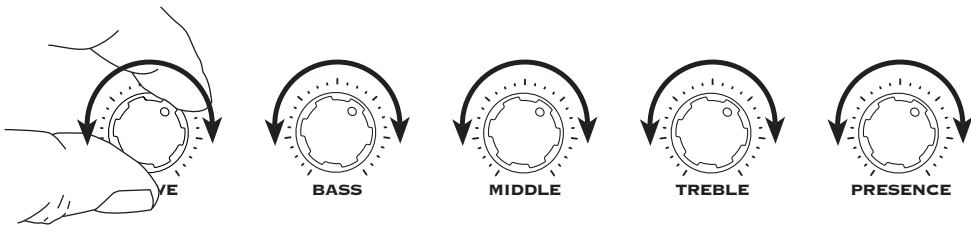

7. Pick a Stomp Model and tweak it.

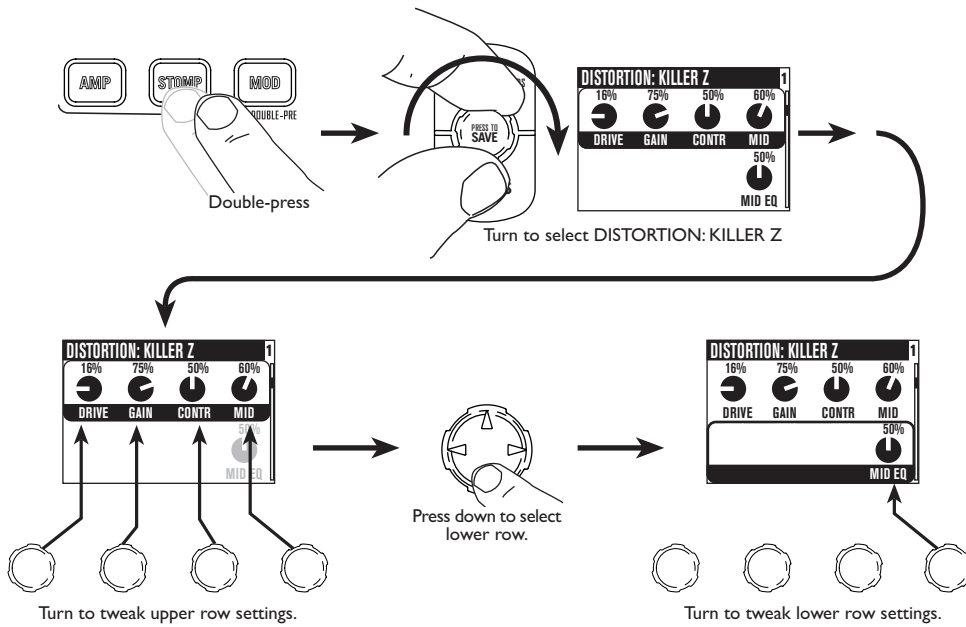

8. Show the Delay settings.

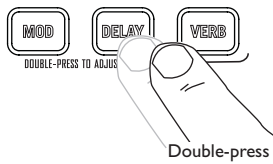

9. Set the Delay tempo, and set it to run post (after the Amp Model).

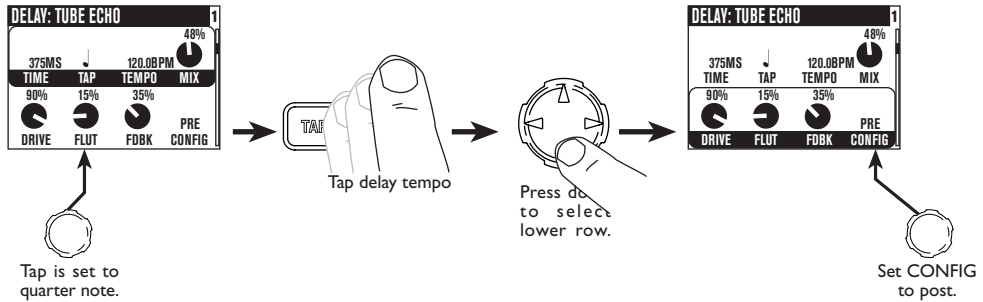

10. Select the EQ.

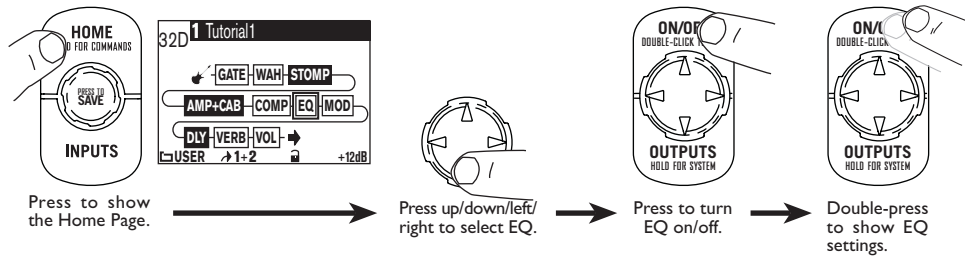

11. Tweak the EQ.

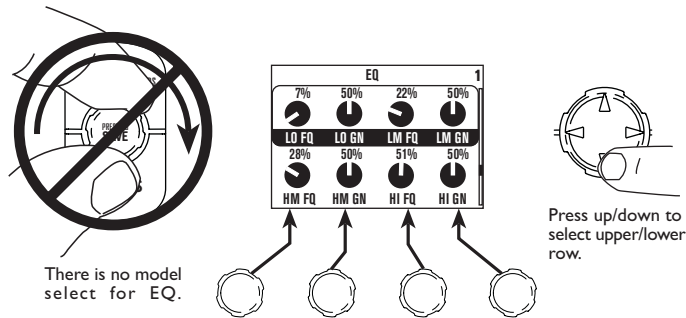

12. Turn Tone 2 on.

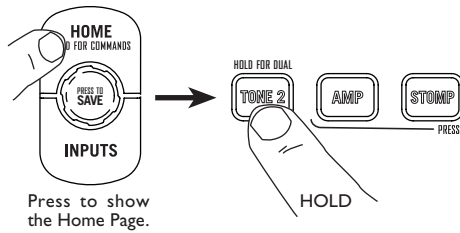

Press to show the Home Page.

13. Load preset to Tone 2 only.

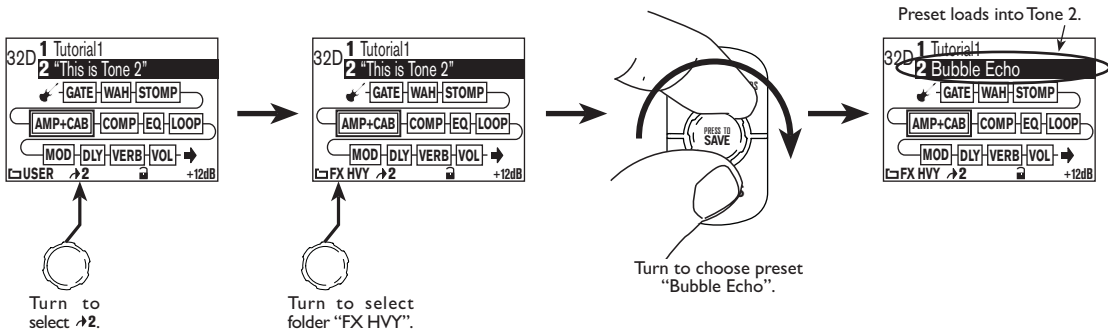

Turn to select →2.

Turn to select folder "FX HVY".

Turn to choose preset "Bubble Echo".

14. Select and tweak Tone 1/Tone 2.

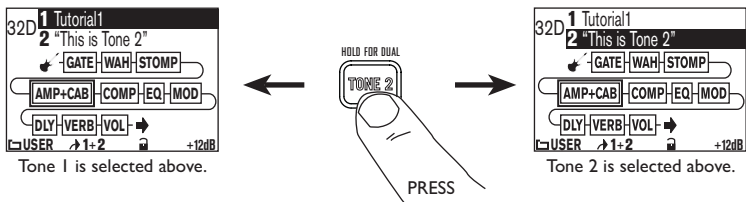

Tone 1 is selected above.

PRESS

Tone 2 is selected above.

15. These knobs and buttons control only one Tone at a time:

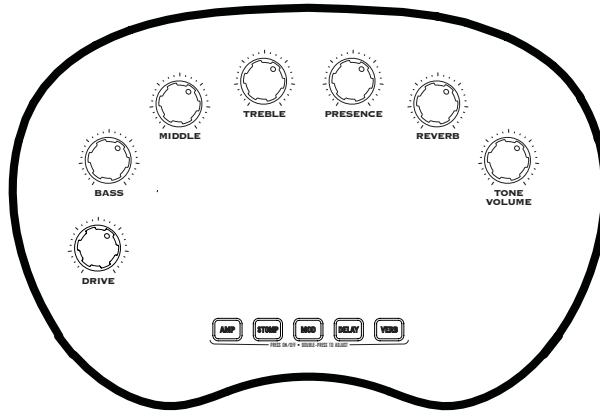

16. Tweak the combined volume of Tone 1 + Tone 2.

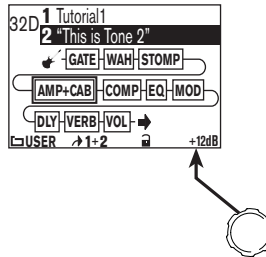

17. Save.

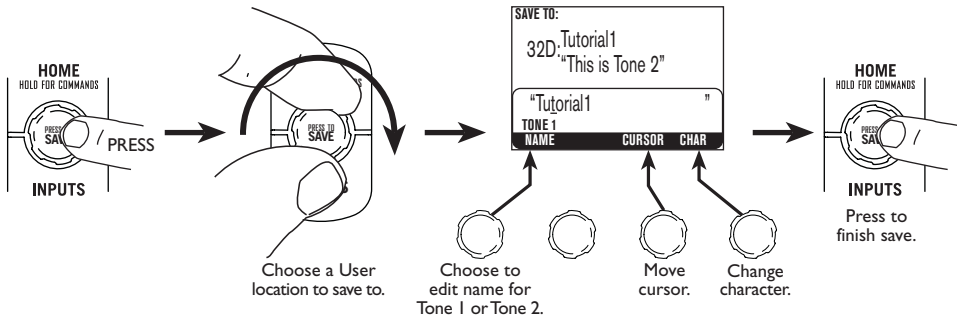

CONTROLS & CONNECTIONS

POD X3

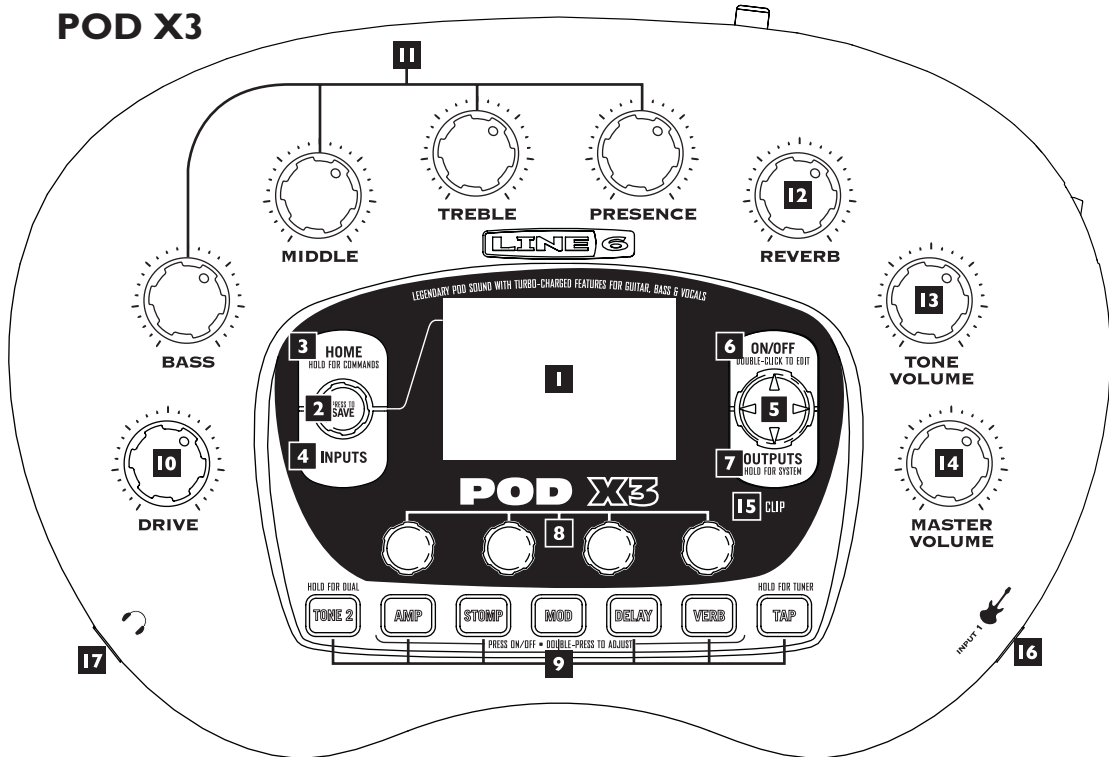

1 Display – The LCD (*liquid crystal display*) is your window into the power of POD X3. You’ll see (2) types of “pages” in the display:

Home Page – the “Tone Path” Home Page shows you all the digital processing “blocks” that are working to deliver your great tone. For User Presets, you can also switch to a “Big User” Home Page, which shows you the bank and channel number where the preset is stored. The tone names that are loaded in the current preset, and the bank and channel number where the preset is stored are also displayed. You can get to the Home Page at any time by pressing the **Home** button. You can toggle between the two Home Pages by repeatedly pressing the **Home** button.

Edit Page – shows you all parameters available to tweak for a processing block or setup page.

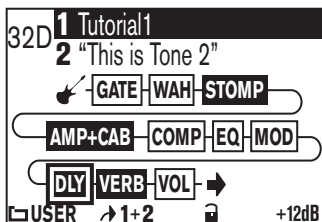

Tone Path Home Page

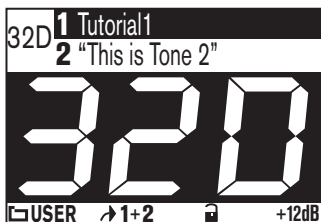

Big User Home Page
(available for User Presets only)

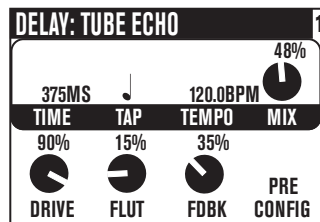

Edit Page

2 Select Knob – Turning this knob will do different things depending on what page you’re on.

Home Page – turn to select presets. See Chapter 4 for all the details.

Edit Page – turn to pick a different Model. This works for the Amp, Stomp, Mod, Delay, Reverb, and Wah edit pages. Full details are in Chapter 5.

You can also press this knob to store your own tweaked-up sounds in POD X3. Just press, choose what to store and where to store it, and press the button again to complete the Save. Chapter 4 will fill you in.

3 Home / Hold for Commands – Press to return to the Home Page. For User Presets, press repeatedly to toggle between the Tone Path Home Page and the Big User Home Page. Press and hold for 2 seconds to enter the Commands page. Full details are in Chapter 6.

4 Inputs – Press to enter the Inputs setup page to configure which inputs you’re using. Full details are in Chapter 6.

5 4-way Nav – Pressing this will do different things depending on what page you’re on.

Home Page – press **Up**, **Down**, **Left**, and **Right** to navigate to a processing block.

Edit Page – press **Up** and **Down** to move through each row of parameters available. You can also press **Left** and **Right** to move to the previous or next edit page.

6 On/Off – Press to turn the selected processing block on or off (the blocks are on when the buttons are lit and the block on the Home Page is solid). Double-press to enter the processing block’s Edit page, where you can fine-tune the parameters for that block.

Double-press the same button again (or press the **Home** button) to leave the Edit page and return to the Home Page. Chapter 5 gives you details on all the Edit pages available.

7 Outputs / Hold for System – Press to enter the Outputs setup page, where you can set up POD X3 for whatever you’re connecting it to. This is a very important step for getting the best sound out of your POD X3. Press and hold for 2 seconds to enter the System setup page. Full details are in Chapter 6.

8 Multi-function Knobs – Turn any one of these knobs to adjust the corresponding parameter in the display.

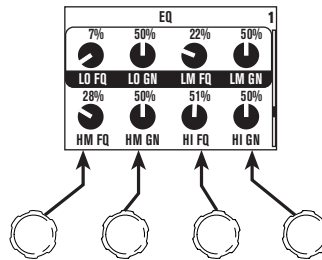

See Chapter 4 to learn about Home Page functions for these knobs.

9 Keypad – These buttons allow you to do the following:

Tone 2 / Hold for Dual – When Dual Tone is on, press to toggle between Tone 1 and Tone 2 (you’re editing Tone 2 when the button is lit). Press and hold to turn Dual Tone on or off. See Chapter 4 for more details.

Amp, Stomp, Mod, Delay, Verb – press to turn the Amp, Stomp, Mod, Delay, and Reverb processing blocks on or off (the blocks are on when the buttons are lit). Double-press one of these buttons to tweak the block. For example, just press the **Stomp** button two times quickly and you’re instantly taken to the Stomp Box Edit Page. Double-press the same button again (or press the **Home** button) to leave the Edit Page and return to the Home Page. Chapter 5 gives you details on all the Edit Pages available.

Tap / Hold for Tuner – POD X3 allows you to control the time and speed of your Delay and/or Mod effects by simply tapping on this button. Just tap a few times here and the effects that are set to “lock” to that tempo will change to match what you tapped. There’s also a Tempo parameter in the effects’ Edit Pages, so you’ll see exactly

what Tempo you've tapped. This is especially useful if you are trying to nudge your Tap setting to just the right value. See Chapter 5 to learn how to set up effects to follow the tempo that you've tapped.

Press and hold the **Tap** button for 2 seconds to activate the tuner. You can also add footswitch tuner activation with an optional FBV foot controller.

10 Drive – controls how hard you're driving the input of the chosen Amp Model. Like the input volume control on a non-master volume guitar amp, higher settings give you more “dirt.”

This knob, along with the **Tone Controls**, **Reverb**, and **Tone Volume** knobs, adjusts the Tone that is currently selected – Tone 1 or Tone 2. See Chapter 4 for more info on Dual Tone and how this all works.

11 Tone Controls – Bass, Middle, Treble, Presence. Just like any guitar amp. And when you change Amp Models, the response and interactivity of these controls change, too—so they act like the tone controls of the original amp that inspired the Amp Model you've selected.

12 Reverb – Spin this knob to set the Reverb level of the Tone that is currently selected.

13 Tone Volume – This knob controls the relative volume level of the current Tone.

14 Master Volume – This controls the overall output level of POD X3 and also sets the headphone level. Changing the **Master Volume** level does not change your tone, so you can get the tone you want at any volume level. This setting is not saved when you store settings into one of the POD X3's memory locations.

When running into line level gear (like recorders, mixers and PA's), POD X3 will generally give the best signal-to-noise performance when you have the **Master Volume** control at max. With the **Master Volume** control turned down low, you may get extra hiss—which obviously isn't what you want—if you turn up your mixer or recorder's output to compensate. In order to allow you to set the **Master Volume** as high as possible when connecting to recording, mixing, and other studio gear, **be sure you are plugging POD X3's outputs into line level**, not microphone or guitar level inputs. Line level inputs should allow you to turn POD X3's **Master Volume** up all the way (or close to it) and thereby get the best sound possible. If your gear has inputs that function as mic/line level

inputs, try to set the trim for those inputs to the minimum level, and POD X3's **Master Volume** to maximum, when setting levels.

15 Clip Light – This lights when clipping is detected, which generally means unpleasantly distorted, bad sound. Try reducing the output level of the device that's feeding your POD X3, or reducing the Tone Volume for Tone 1 or Tone 2, or the volume of Tone 1 + Tone 2 that can be adjusted from the right knob below the Home Page.

16 Input 1/Guitar In – Plug your guitar or bass in here. You techies will want to know this is a mono, unbalanced connection. The **Inputs** page is where you assign whether this input feeds Tone 1, Tone 2 or both. See Chapter 6 for more info.

17 Phones – Plug your headphones in here to avoid noise complaints from the neighbors (or the rest of your family). The volume is set by the **Master Volume** knob. Any time you use headphones, it's important to be sure they're not set for ridiculous volume before you slap them on your ears. Try a **Master Volume** knob setting of about 10 o'clock to start, then turn up from there if you need more volume.

To give you great sound through the headphones, your POD X3 automatically switches to Studio Mode whenever headphones are connected (for more on Studio Mode, see **Outputs** in Chapter 6.).

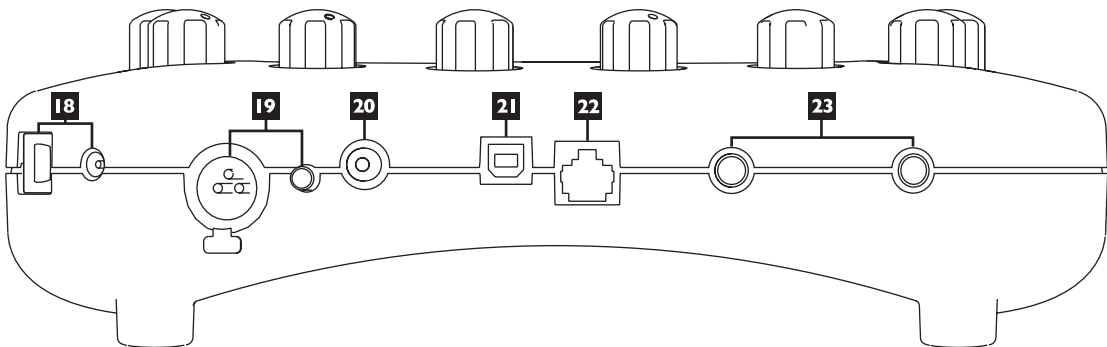

18 Power – Connect the included PX-2 power pack and flip the switch here to bring your POD X3 to life.

19 Input 2/Microphone In and Trim – Plug in your microphone here and use the Trim control to get a nice, healthy level. The **Inputs** page is where you assign whether this input feeds Tone 1, Tone 2 or both. See Chapter 6 for more info.

20 S/PDIF Out – This jack sends out 24-bit digital versions of the **Left & Right Outputs**. The **System** setup page lets you choose the sample rate and adjust the level. See Chapter 6 for the scoop.

21 USB 2.0 – POD X3's USB 2.0 jack lets you connect directly to a USB 2.0-equipped computer, and take advantage of many computer-powered features:

- Line 6 Monkey software makes it easy to install software and get updates.

Install driver software with Line 6 Monkey, and POD X3 provides 8 audio inputs to your computer via USB:

- 1-2 is the main signal, configured on POD X3's Outputs page for Digital Outs.
- 3-4 is Tone 1 separately in stereo.
- 5-6 is Tone 2 separately in stereo.
- 7 is the sum of the inputs you've chosen for Tone 1.
- 8 is the sum of the inputs you've chosen for Tone 2.

You can also connect your headphones or powered speakers directly to POD X3 to hear your computer-generated audio, along with POD X3's real-time processing. See Chapter 8 for more info.

22 FBV Pedal – Connect an optional foot controller here, including the FBV, FBV Shortboard, and FBV Express. The System page lets you set it all up. See Chapter 6 for details. Note that POD X3 does not work with the older Line 6 Floor Board or FB4.

23 Left & Right Outputs – These balanced, 1/4-inch TRS (tip/ring/sleeve) connectors are ready to rock with pro +4 dBu balanced equipment. They will also work happily with unbalanced –10 dBV equipment and standard guitar cables. If you need mono output, you can use either one.

Join the Club!

Visit www.line6.com/club to register online and join the All Access club, the place to get:

- Free iTunes and MP3 Jam Tracks
- Free loops for GarageBand, Acid, Reason and more
- Free guitar lessons from LA session pros
- Free chord and scale practice tools
- Stay informed of contest and special offers
- Access to discussion forums, software updates and more.

POD X3 Live

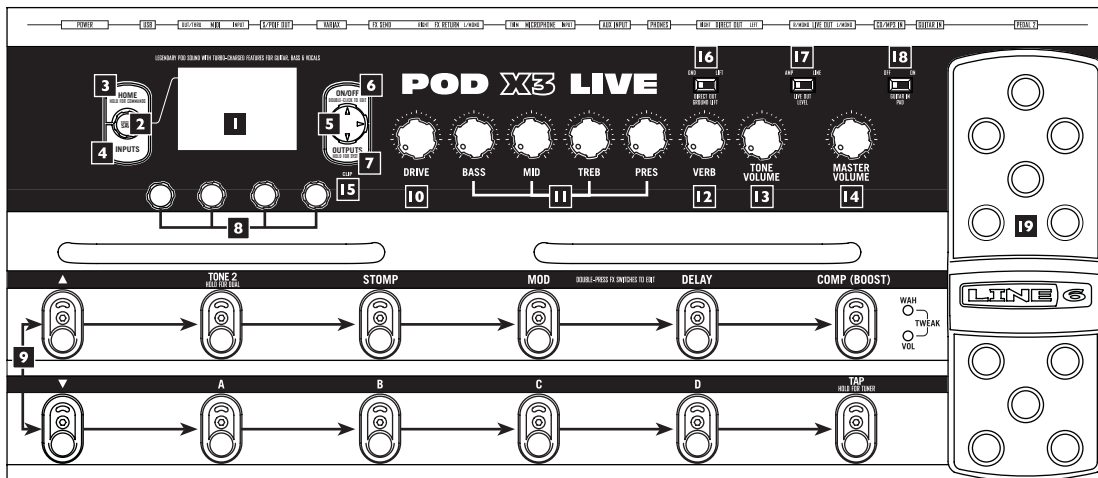

3•8

1 Display – The LCD (*liquid crystal display*) is your window into the power of POD X3 Live. You'll see (2) types of “pages” in the display:

Home Page – the “Tone Path” Home Page shows you all the digital processing “blocks” that are working to deliver your great tone. For User Presets, you can also switch to a “Big User” Home Page, which shows you the bank and channel number where the preset is stored. The tone names that are loaded in the current preset, and the bank and channel number where the preset is stored are also displayed. You can get to the Home Page at any time by pressing the **Home** button. You can toggle between the two Home Pages by repeatedly pressing the **Home** button.

Edit Page – shows you all parameters available to tweak for a processing block or setup page.

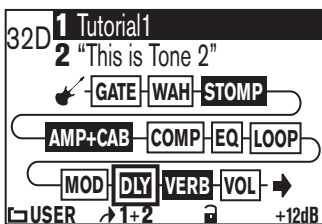

Tone Path Home Page

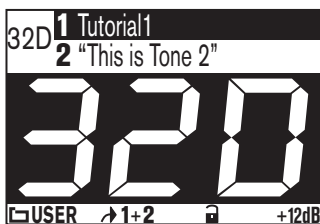

Big User Home Page
(available for User Presets only)

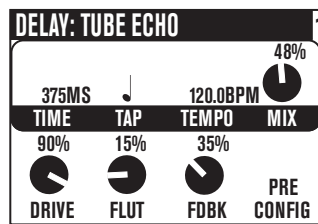

Edit Page

2 Select Knob – Turning this knob will do different things depending on what page you're on.

Home Page – turn to select presets. See Chapter 4 for all the detail.

Edit Page – turn to pick a different Model. This works for the Amp, Stomp, Mod, Delay, Reverb, and Wah edit pages. Full details are in Chapter 5.

You can also press this knob to store your own tweaked-up sounds in POD X3 Live. Just press, choose what to store and where to store it, and press the button again to complete the Save. Chapter 4 will fill you in.

3 Home / Hold for Commands – Press to return to the Home Page. For User Presets, press repeatedly to toggle between the Tone Path Home Page and the BigNumber Home Page. Press and hold for 2 seconds to enter the Commands page. Full details are in Chapter 6.

4 Inputs – Press to enter the Inputs setup page to configure which inputs you're using. Full details are in Chapter 6.

5 4-way Nav – Pressing these buttons will also do different things depending on what page you're on.

Home Page – press **Up**, **Down**, **Left**, and **Right** to navigate to a processing block.

Edit Page – press **Up** and **Down** to move through each row of parameters available. You can also press the **Left** and **Right** to move to the previous or next processing block in the Tone path.

6 On/Off – Press to turn the selected processing block on or off (the blocks are on when the buttons are lit and the block on the Home Page is solid). Double-press to enter the processing block's Edit page, where you can fine-tune the parameters for that block. Double-press the same button again (or press the **Home** button) to leave the Edit page and return to the Home Page. Chapter 5 gives you details on all the Edit pages available.

7 Outputs / Hold for System – Press to enter the Outputs setup page, where you can set up POD X3 Live for whatever you're connecting it to. This is a very important step for getting the best sound out of your POD X3 Live. Press and hold for 2 seconds to enter the System setup page. Full details are in Chapter 6.

8 Multi-function Knobs – Turn any one of these knobs to adjust the corresponding parameter in the display.

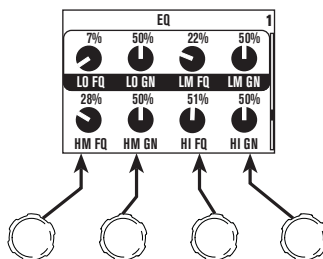

See Chapter 4 to learn about Home Page functions for these knobs.

9 Footswitches – These allow you to do the following:

Tone 2 / Hold for Dual – When Dual Tone is on, press to toggle between Tone 1 and Tone 2 (you're editing Tone 2 when the footswitch is lit). Press and hold to turn Dual Tone on or off. See Chapter 4 for more details.

Stomp, Mod, Delay – turns the Stomp, Mod, and Delay processing blocks on or off (the blocks are on when the footswitches are lit). Double-press one of these footswitches to tweak the block. For example, just press the **Stomp** footswitch two times quickly and you're instantly taken to the Stomp Box Edit Page. Double-press the same footswitch again (or press the **Home** button) to leave the Edit Page and return to the Home page. Chapter 5 gives you details on all the Edit Pages available.

Comp/Boost – turns the Compressor processing block on or off. Double-press to tweak the block. This footswitch can also be assigned to the Amp Model or Reverb processing block. See the **Pedal** info page in Chapter 5 for more details.

Bank Up, Down – These choose amongst POD X3 Live's 32 banks of User presets. Once you've footswitched your way to a new bank, you'll then also need to step on the **A, B, C** or **D** footswitch to actually load a preset from that bank. (We set things up this way so your audience won't hear you switching through presets as you make your way to your next bank of sounds.)

A, B, C, D – The lights on these footswitches show you which of the Presets in the current User Bank is running. You can step on any of them to choose a different preset.

Tap / Hold for Tuner – POD X3 Live allows you to control the time and speed of your Delay and/or Mod effects by simply tapping on this footswitch. Tap a few times here, and the effects that are set to “lock” to that tempo will change to match what you tapped. There’s also a Tempo parameter in the effects’ Edit Pages, so you’ll see exactly what Tempo you’ve tapped. This is especially useful if you are trying to nudge your Tap setting to just the right value. See Chapter 5 to learn how to set up effects to follow the tempo that you’ve tapped.

Press and hold the **Tap** footswitch for 2 seconds to activate the tuner.

10 Drive – controls how hard you’re driving the input of the chosen Amp Model. Like the input volume control on a non-master volume guitar amp, higher settings give you more “dirt.”

This knob, along with the **Tone Controls**, **Verb**, and **Tone Volume** knobs, adjusts the Tone that is currently selected – Tone 1 or Tone 2. See Chapter 4 for more info on Dual Tone and how this all works.

11 Tone Controls – Bass, Mid, Treb, Pres. Just like any guitar amp. And when you change Amp Models, the response and interactivity of these controls change, too—they act like the tone controls of the original amp that inspired the Amp Model you’ve selected.

12 Reverb – Spin this knob to set the Reverb level of the Tone that is currently selected.

13 Tone Volume – This knob controls the relative volume level of the current Tone.

14 Master Volume – This controls the overall output level of POD X3 Live and also sets the headphone level. Changing the **Master Volume** level does not change your tone, so you can get the tone you want at any volume level. This setting is not saved when you store settings into one of the POD X3 Live’s memory locations.

POD X3 Live will generally give the best signal-to-noise performance when you have the **Master Volume** control at max. With the **Master Volume** control turned down low, you may get extra hiss—which obviously isn’t what you want—if you turn up your mixer or recorder’s output to compensate. In order to allow you to set the **Master Volume** as high as possible when connecting to recording, mixing, and other studio gear, **be sure you are plugging POD X3 Live’s 1/4-inch outputs into line level**, not microphone

or guitar level inputs. Line level inputs should allow you to turn POD X3 Live's **Master Volume** up all the way (or close to it) and thereby get the best sound possible. If your gear has inputs that function as mic/line level inputs, try to set the trim for those inputs to the minimum level, and POD X3 Live's **Master Volume** to maximum, when setting levels.

15 Clip Light – This lights when clipping is detected, which generally means unpleasantly distorted, bad sound. Try reducing the output level of the device that's feeding your POD X3, or reducing the Tone Volume for Tone 1 or Tone 2, or the volume of Tone 1 + Tone 2 that can be adjusted from the right knob below the Home Page.

16 Direct Out Ground Lift – This switch lets you lift the grounds of POD X3 Live's XLR Direct Outs. This can be handy if you get an audible hum caused by a ground loop when connecting to other grounded equipment.

17 Live Out Level – This switch sets the level for the **Live Outputs**. When set to *Amp*, the **Live Outputs** are ready for connection to an on-stage amp. When set to *Line*, they're ready to plug into a mixer or recorder with line level inputs.

18 Guitar In Pad – The *Off* setting of this switch is appropriate for most guitars. If you see the **Clip** light coming on, that means you're overloading POD X3 Live's input. If that happens frequently, try the *On* setting here. This switches in input circuitry that's appropriate for hotter signals output by some guitars with active pickups, or from keyboards and other sources.

19 Onboard Pedal – The lights to the left of this pedal show whether the pedal will operate the Wah effect, Volume Pedal, or (when both lights are lit) Tweak. When operating the Wah, you can press hard with your toe at the top of the pedal, and the wah — as well as the wah light to the left of the pedal — will turn on and off. To learn how to change what the pedal controls, see page Chapter 6.

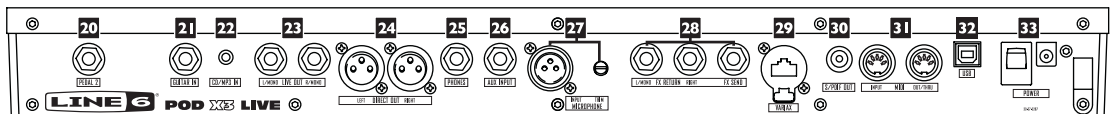

20 Pedal 2 – Connect a standard expression pedal, such as the Line 6 EX-1, and you'll be able to assign it to control the Volume Pedal or Effect Tweak functions. See Chapter 6 for the detail on that.

21 Guitar In – Plug your guitar or bass in here. You techies will want to know this is a mono, unbalanced connection. The **Guitar In Pad** switch sets the sensitivity of this jack. The **Inputs** page is where you assign whether this input feeds Tone 1, Tone 2 or both. See Chapter 6 for more info.

22 CD/MP3 In – Connect a CD player, MP3 player, drum machine or other device here, and you'll hear it at POD X3 Live's **Phones**, **Direct Out**, and **Live Out**.

23 Live Out – The unbalanced 1/4-inch connectors here get your POD X3 Live's sound to a guitar amplifier, recorder, mixer or PA system.

The **Output** display pages configure these outputs for Studio or Live use. In Studio Mode, they're ready to plug into a recorder with unbalanced –10 dBV inputs. In Live Mode, they don't have speaker simulation, and are ready for connection to an on-stage power amp. Whichever you choose, the front panel **Master Volume** knob determines how much signal you'll get at these jacks. You can use either jack as a mono output, by the way.

24 Direct Out – These balanced XLR connectors always provide studio-quality sound with speaker/microphone/room simulation ideal for direct recording and as a direct send to the house mixer or PA when playing live.

As detailed in Chapter 6, the **System** page lets you disable Master Volume control for these outputs, so you can make on-stage adjustments to the 1/4-inch outputs feeding and amp without affecting the levels sent to the house sound mixer or PA.

25 Phones – Plug your headphones in here to avoid noise complaints from the neighbors (or the rest of your family). The volume is set by the **Master Volume** knob. Any time you use headphones, it important to be sure they're not set for ridiculous volume before you slap them on your ears. Try a **Master Volume** knob setting of about 10 o'clock to start, then turn up from there if you need more volume.

26 Aux Input – This mono, unbalanced 1/4-inch input can be used for a second guitar or just about any other instrument. The **Inputs** page is where you assign whether this input feeds Tone 1, Tone 2 or both. See Chapter 6 for more info.

27 Microphone Input and Trim – Plug in your microphone here and use the Trim control to get a nice, healthy level. The **Inputs** page is where you assign whether this input feeds Tone 1, Tone 2 or both. See Chapter 6 for more info.

28 Effects Loop – The effects loop provides a mono send and stereo return,

operating at approximately 19.5 Volts peak-to-peak, able to be used with stomp boxes or line level devices. Use the **Left Return** jack for a mono return. The Loop can run pre or post Amp Model, and if nothing is connected to the loop, POD X3 Live is smart enough to disable the loop so you still get sound. See Chapter 5 for more details.

29 Variax – Connect a Line 6 Variax guitar here for a direct digital audio connection between the guitar and POD X3 Live. The **Inputs** page is where you assign whether this input feeds Tone 1, Tone 2 or both. See Chapter 6 for more info.

Be sure to keep the protective plastic cap on this connection when it's not connected to a Variax, so you won't damage it by mistakenly inserting a 1/4-inch guitar cable or other connection. When you are ready to connect a Variax, use only Line 6 supplied Variax-compatible cables—not standard Ethernet or other cables—to avoid damage to the jack.

You can learn more about the Variax family of guitars, each one giving you the sound of an entire guitar collection in one instrument, at www.line6.com.

30 S/PDIF Out – This jack sends out 24-bit digital versions of the **Direct Out** signals. The **System** setup screen lets you choose the sample rate and adjust the level. See Chapter 6 for the scoop.

31 MIDI – Connect POD X3 Live to your MIDI equipment to send and receive Program Change Messages for selecting Presets. POD X3 Live's MIDI OUT connects to another device's MIDI IN; its MIDI IN goes to another device's MIDI OUT. Chapter 6 has info on setting your MID Channel for communication.

32 USB 2.0 – POD X3 Live's USB 2.0 jack lets you connect directly to a USB 2.0-equipped computer, and take advantage of many computer-powered features:

- Line 6 Monkey software makes it easy to install software and get updates.

Install driver software with Line 6 Monkey, and POD X3 provides 8 audio inputs to your computer via USB:

- 1-2 is the main signal, configured on POD X3's Outputs page for Digital Outs.
- 3-4 is Tone 1 separately in stereo.
- 5-6 is Tone 2 separately in stereo.
- 7 is the sum of the inputs you've chosen for Tone 1.
- 8 is the sum of the inputs you've chosen for Tone 2.

You can also connect your headphones or powered speakers directly to POD X3 to hear your computer-generated audio, along with POD X3's real-time processing. See Chapter 8 for more info.

33 Power – Connect the included PX-2 power pack and flip the switch here to bring your POD X3 Live to life.

Join the Club!

Visit www.line6.com/club to register online and join the All Access club, the place to get:

- Free iTunes and MP3 Jam Tracks
- Free loops for GarageBand, Acid, Reason and more
- Free guitar lessons from LA session pros
- Free chord and scale practice tools
- Stay informed of contest and special offers
- Access to discussion forums, software updates and more.

GETTING AROUND, TONES & TUNER

POD X3 and POD X3 Live allow you to completely tweak your tone, giving you the ability to dial-in just about any sound you can image. More importantly, we've come up with an amazingly straight-forward way for you to take total control of your sound. It all starts at the Home Page.

Home Page

You can get to POD X3 and POD X3 Live's Home Page at any time by pressing the **Home** button. There are actually two versions of the Home Page, the "Tone Path" Home Page and the "Big User" Home Page:

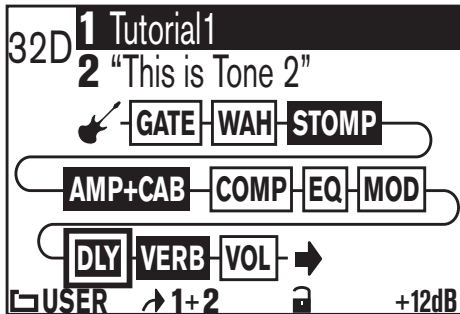

Tone Path Home Page



Big User Home Page
(available for User Presets only)

If the currently-loaded preset is from the User folder, you can toggle between these two Home Page displays by repeatedly pressing the **Home** button. Otherwise, the Tone Path Home Page will be the only one available. The Big User Home Page is handy when you're on stage – you'll be able to clearly see which User preset is loaded.

To the left of the Tone names is the bank and channel number ("32D", for example) if this is a User preset, or just a number if it's from one of the other preset folders.

The Tone Path Home Page also shows the Tone Path, which includes all the digital processing "blocks" that are working to deliver you great tone. The blocks include:

Getting Around, Tones & Tuner

- Amp+Cab
- Gate
- Wah
- Stomp
- EQ
- Comp
- Loop (POD X3 Live only)
- Mod
- Dly
- Rev
- Vol

Each block in the path can be selected, turned on or off, and tweaked to your liking. To select a block from the **Home Page**, use the **4-way Nav** button to get to the one you want. When a block is selected, you'll see that it gets a frame around it:

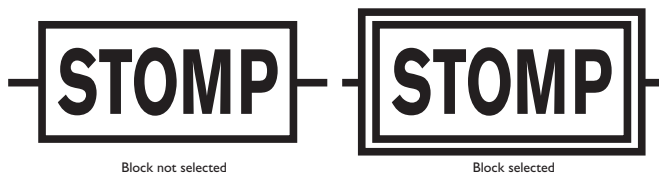

Once you select a block, you can press the **On/Off** button to turn that block on and off. The color of the block tells you whether it's off (inactive) or on (active):

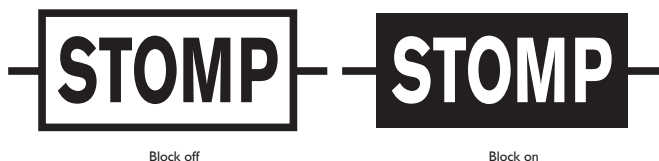

To tweak a block, select it and double-press the **On/Off** button. This will open up its Edit Page, where you can use the **Select** knob to pick Models (where available) and the **Multi-function** knobs to change the corresponding parameters as desired:

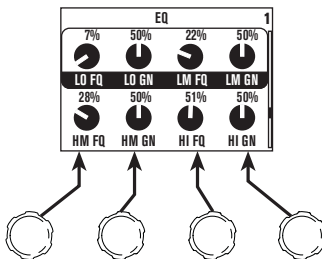

If there are multiple rows or multiple pages of parameters in an Edit Page, you can use the **Up** and **Down** buttons to get to them all.

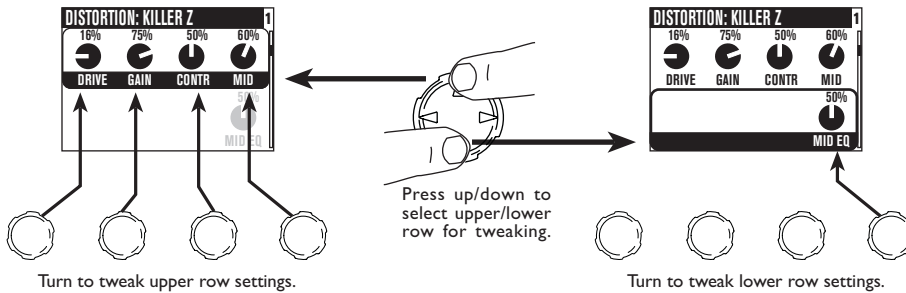

From any Edit page, you can also use the **Left** and **Right** buttons to step through the other Edit Pages, in this order:

AMP > STOMP > MOD > DLY > VERB > GATE > COMP > EQ > WAH > VOL > LOOP (POD X3 Live only)

To return to the Home Page from an Edit Page, you can either press the **Home** button or double-press the **On/Off** button.

By the way, you can also directly edit and turn blocks on or off using the POD X3 **Keypad** or POD X3 Live **Footswitches**. You know the drill—press to turn blocks on or off, and double-press to tweak.

Many of these blocks can be configured to be Pre or Post, so their location in the Home Page can visually change depending on how they're assigned.

See Chapter 5 for details on every block's Edit Page and the parameters available to tweak.

The Dual Tone Concept

One of the most powerful features of both POD X3 and POD X3 Live is Dual Tone capability. What is Dual Tone, you ask? There are actually two (2) completely independent Tone paths available in POD X3 and POD X3 Live! This allows you to:

Process two (2) completely independent Tones for two separate inputs at the same time, such as your guitar plus a microphone. We like to refer to these as tone “Pairs”.

or

Use two (2) completely independent Tones on a single input. This is like running through (2) amps at once! We call these tone “Blends”.

There are essentially (3) steps to getting Dual Tone going on POD X3 and POD X3 Live:

1. Assign inputs. To assign inputs to each Tone, press the **Inputs** button and select the input or combination of inputs to feed Tone 1 and Tone 2. Full details are available in Chapter 5.

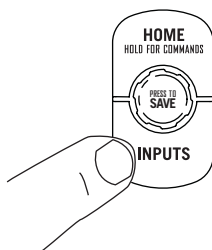

2. Turn on Dual Tone. The Home Page will tell you whether Dual Tone is On or Off:

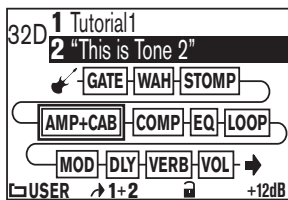

Dual tone on

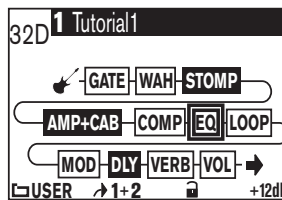
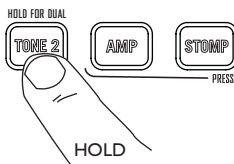

Dual tone off

If Dual Tone is on, press and hold the **Tone 2** button (POD X3) or **Tone 2** footswitch (POD X3 Live) to turn Dual Tone off. Turning Dual Tone off will silence whatever input is assigned to Tone 2. If Dual Tone is off, press and hold the **Tone 2** button (POD X3) or **Tone 2** footswitch (POD X3 Live) to turn Dual Tone on.

3. Tweak your Tones. From the Home Page, pressing the **Tone 2** button (POD X3) or stepping on the **Tone 2** footswitch (POD X3 Live) will toggle between the Tone 1 and Tone 2 processing paths. When you're on the one you want, you can select blocks, turn them on/off, tweak, and turn knobs as described earlier.

Tone 1 name is inverted if Tone 1 is selected. Tone 2 name is inverted if Tone 2 is selected:

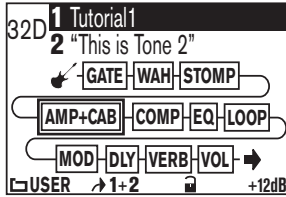

Edit Tone 1 (Home Page)

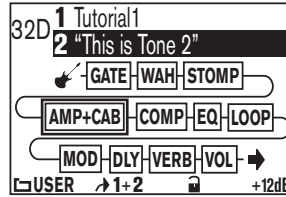

Edit Tone 2 (Home Page)

From a block's Edit Page, you can also press the **Tone 2** button (POD X3) or step on the **Tone 2** footswitch (POD X3 Live) to toggle between that block for each Tone.

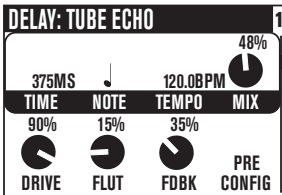

Edit Tone 1 (Edit Page)

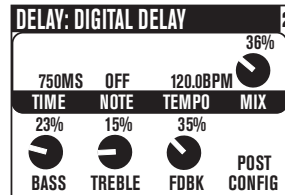

Edit Tone 2 (Edit Page)

Dual Tone Volume Controls

- The **Tone Volume** knob adjusts the volume of the Tone that is currently selected. Use this control to set the correct balance between Tone 1 and Tone 2.
- From the Home Page, the rightmost **Multi-function** knob lets you adjust the volume of Tone 1 + Tone 2. Back off on this control if you're seeing the **Clip** light turn on. This level is saved and recalled with each preset.



Tone Volume adjusts the volume of the currently selected Tone.

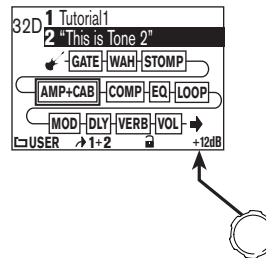

Multifunction Knob 4 adjusts the volume of both Tones at once.

You probably want all of your favorite sounds as loud as possible, while also having the right difference in volume between your lead and rhythm sounds, clean and dirty sounds, etc. Right? OK, then, to get this happy balance, start with your favorite ‘clean’ sounds. Turn up their volume as high as you can without getting the **Clip** indicator to light when you strum hard, and save them that way. Then switch amongst them to see if some are too loud, and turn them down a bit to match well with the others. Next, move on to select your ‘dirtier’ crunch and lead tones, comparing them to the clean sounds and saving them with lower volume settings to match well with those clean sounds. Now, each time you use your POD X3 or POD X3 Live, you just have to set a **Master Volume** level you like, and you can switch amongst your various sounds without unhappy volume differences.

Preset Folders

4•6

POD X3 and POD X3 Live include over 350 presets to cover a wide range of styles. These presets store complete amp-and-effect selections and settings that you can call up at the touch of a button. Of these presets, there are 128 User locations that you can use to store your own custom tones.

These folders of presets are available:

- USER: any presets you save go here (128 total)
- LOGAIN: for electric guitar (30)
- HIGAIN: for electric guitar (30)
- FX HVY: for electric guitar (20)
- SONGS: for electric guitar (40)
- ACOU: for acoustic guitar (15)
- VOCAL: for vocals (15)
- BASS: for bass guitar (40)
- BLENDS: Dual Tone Blends for electric guitar (30)
- DUAL: Dual Tone Pairs for independent inputs (30)

It’s important to remember that since POD X3 and POD X3 Live have Dual Tone functionality, each preset actually stores settings for both Tone 1 and Tone 2. In fact, separate names for Tone 1 and Tone 2 are stored in each preset. This comes in very handy when recalling presets.

Recalling Presets

There are a couple of ways to recall presets from the Preset Library. To recall a “complete” preset (both Tone 1 and Tone 2) at once, do the following:

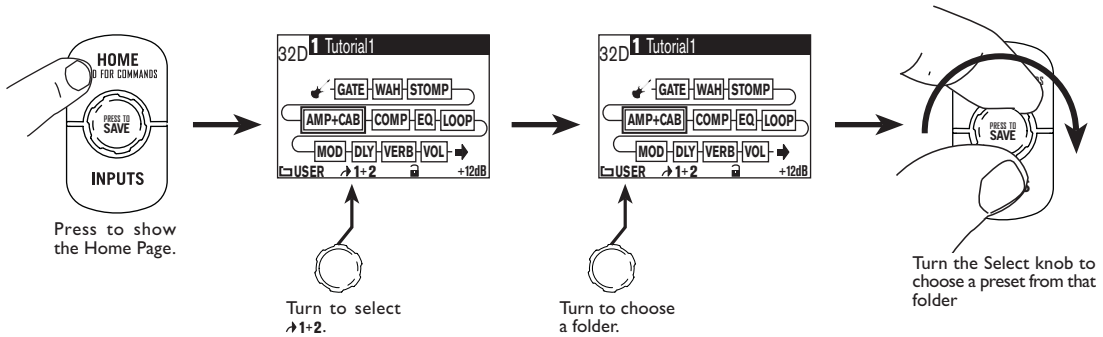

4•7

You can also choose to recall only Tone 1:

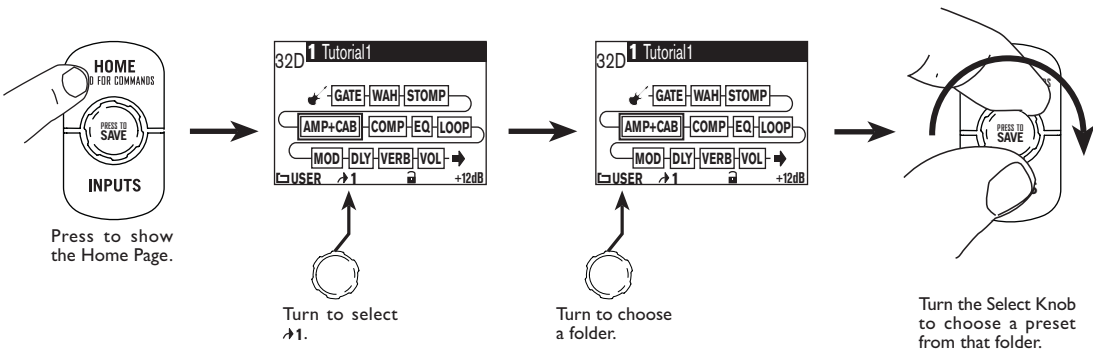

Or only Tone 2:

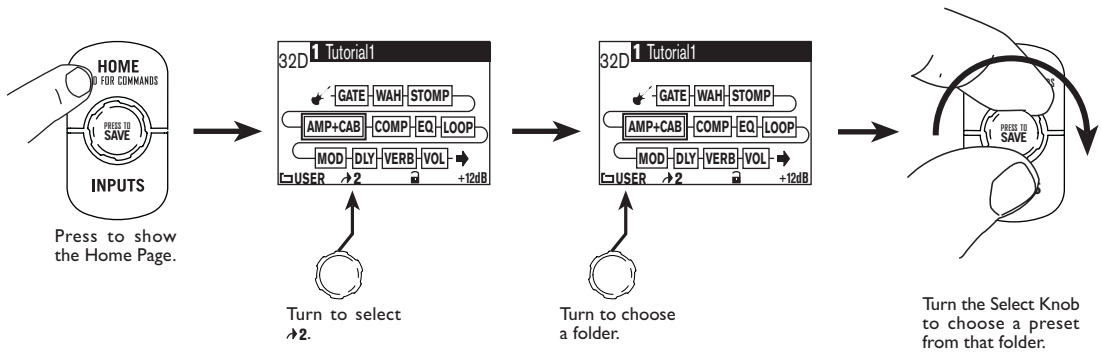

Recalling User Presets on POD X3 Live

Using POD X3 Live's footswitches, you can recall the 128 User presets with your feet. It's easy. Just step on the **Bank Up** or **Bank Down** footswitch to get to the bank you want (1-32), then use the **A, B, C,** or **D** footswitch to recall a preset from that bank (A-D). The preset will load as soon as you step on **A, B, C,** or **D**.

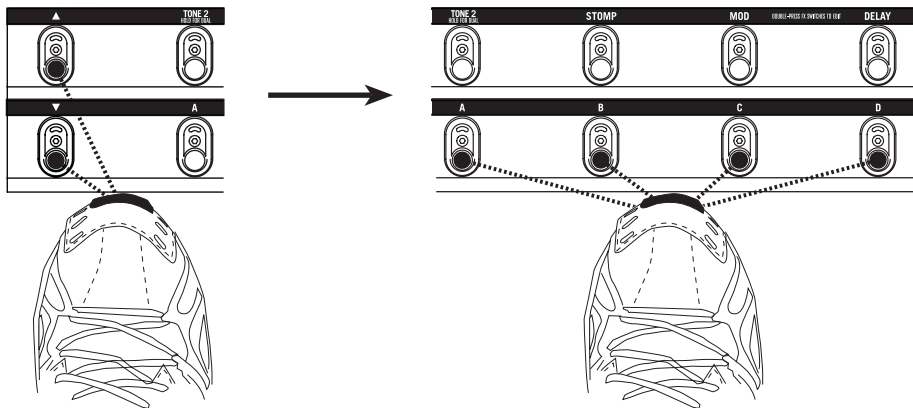

Locking Tone 2

From the Home Page, you can lock Tone 2 to prevent it from getting overwritten when loading new presets. This is handy when you're using Tone 2 for vocals and you want to make sure it doesn't change when you recall guitar presets on Tone 1.

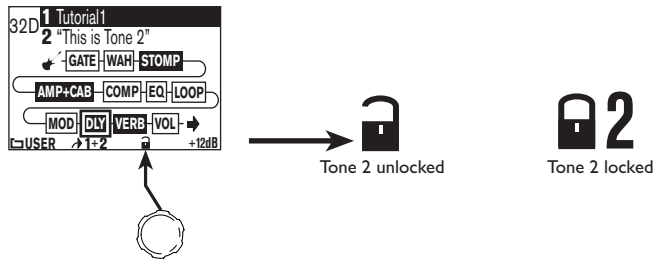

Saving Tones

You can edit any of the POD X3's presets or create one of your own and store it to one of the 128 User preset locations. To save a preset, follow these steps:

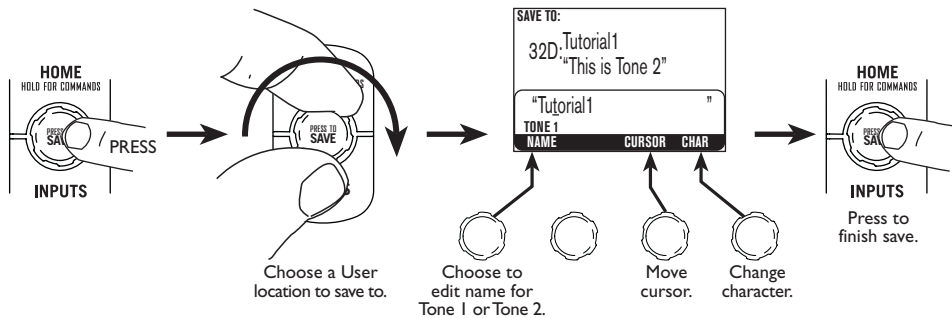

Tuner

Press and hold the **Tap** button or footswitch for 2 seconds to enter tuner mode — shazam! Instant digital chromatic tuner for Tone 1. The display will change to the following:

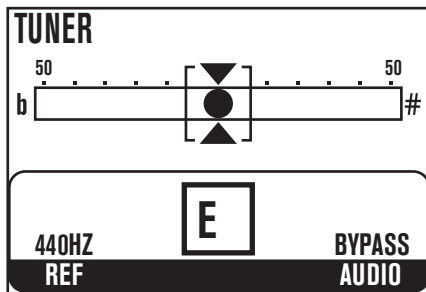

All Amp Model and effects processing are bypassed so you can hear those questionably-tuned strings clearly, should you choose to do so.

Play a note on your guitar and you'll see what it is on that handy display; all notes are displayed as flats, so you'll see $A\flat$ instead of $G\sharp$. Play that string you're trying to tune again, spin its tuning key so it goes sharp and flat, and the little ball will move to the right if it's sharp and back down to the left when the note's flat. The little ball will sit right in the middle when you've got it just right.

Ref – Want a different reference than $A=440\text{Hz}$? Turn the “Ref” knob to set the reference frequency anywhere from 430-450 Hz. This setting is stored so you don't have to reset it every time you turn on your POD X3 or POD X3 Live.

Audio – Normally, the audio will be muted while you're tuning, but if you prefer to hear yourself tune, turn the **Audio** knob to toggle between Mute and Bypass.

Press the **Tap** button or footswitch and the tuner disappears just as swiftly as it came.

REFERENCE: TWEAKING TONES

Amp + Cab

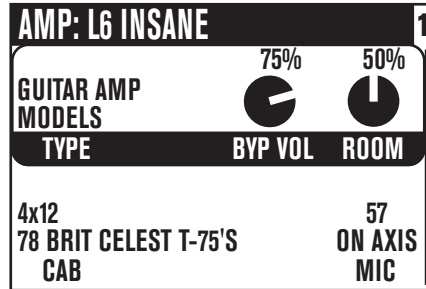

Type – turn this knob to select Guitar Amp Models, Bass Amp Models or Pre-Amp type Models.

Select Knob – once the Type has been selected, turn the Select Knob to pick an Amp Model. The Model names will appear at the top of the display.

Cab – spins through the available Cabinet Models. The available cabs will change depending on the Amp Model that is chosen.

Mic – changes the microphone selection.

Room - adjusts the amount of “room tone” in your sound. Low settings give you the sound of moving the virtual microphone closer to the virtual cabinet (you’ll hear only a small amount of the early reflections caused by the sound echoing in the room). Higher settings increase the early reflections, as if you moved the mic farther from the cabinet.

Byp Vol - sets the Bypass Volume, the volume that this tone will be set to when the Amp+Cab block is off. It doesn’t affect the volume you hear with the Amp+Cab block on.

Tone Controls

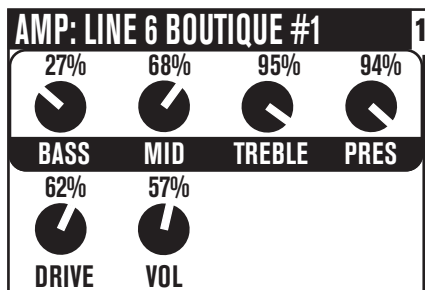

5•2

Tone Controls adjust the overall tone of the currently-loaded Amp Model. You should know that these controls are individually crafted for each Amp Model, so their response and interactivity will change depending on the Amp Model that is selected.

For Guitar and Bass Amp Models, these correspond to the dedicated **Tone Control** knobs on the front panel.

Guitar Amp Model Tone Controls

Bass – bass tone control.

Mid – mid tone control.

Treble – treble tone control.

Pres – presence control, which brightens your tone.

Drive – controls how hard you’re driving the input of the chosen Amp Model, and just like the input volume control on a non-master volume guitar amp, higher settings give you more “dirt”.

Vol – controls the relative volume level of the current Tone; you can use this to balance levels between various tones, but in general, you should set this as high as possible for the best signal-to-noise ratio.

Bass Amp Model Tone Controls

Bass – bass tone control.

Lo Mid – low-mid tone control.

Hi Mid – high-mid tone control.

Treble – treble tone control.

Drive – controls how hard you’re driving the input of the chosen Amp Model, and just like the input volume control on a non-master volume guitar amp, higher settings give you more “dirt”.

Vol – controls the relative volume level of the current Tone; you can use this to balance levels between various tones, but in general, you should set this as high as possible for the best signal-to-noise ratio.

Pre-Amp Model Tone Controls

Bass & Freq – bass tone control; level and frequency.

Lo Mid & Freq – low-mid tone control; level and frequency.

LMid – turn to choose 1x or 10x the low-mid frequency.

Hi Mid & Freq – High-mid tone control; level and frequency.

HMid – turn to choose 1x or 10x the high-mid frequency.

Hi Pass – high-pass filter frequency.

Lo Gn & Fq – low-frequency shelving tone control; level and frequency.

Lm Gn & Fq – low-mid peaking tone control; level and frequency.

Mid Gn & Fq – mid peaking tone control; level and frequency.

Hm Gn & Fq – high-mid peaking tone control; level and frequency.

Hi Gn & Fq – high-frequency shelving control; level and frequency.

Stomp Boxes

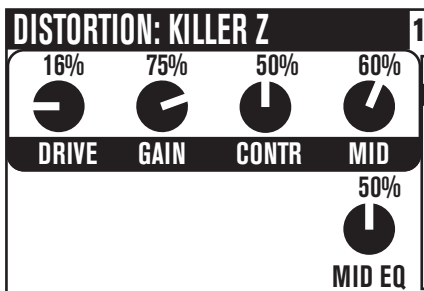

5•4

What guitarist doesn't like Stompboxes? POD X3 and POD X3 Live include an arsenal of amazing-sounding Distortion, Dynamics, and Filter Stomp Box Models, lovingly crafted after a whole carpet-full of the greatest effects of guitar history. Quick descriptions for the various parameters that appear for different Models are listed below.

Select Knob – turn to pick a Stomp Box model.

Distortion Stomp Boxes

Drive/Gain – amount of distortion/overdrive/grind/gain.

Tone – overall effect tone control.

Tone – on Killer Z, adjusts the contour of the tone.

Mid – mid tone control.

Treble – treble tone control.

Bass – bass tone control.

Blend – on the Bronze Master, adjusts the blend of tonal elements.

Mid Frq – selects middle frequency for tone adjustment.

Dynamics Stomp Boxes

Sust – varies the compression threshold.

Level – adjusts the overall level.

Sens – varies the effect’s response to your playing.

Amount – on Vetta Juice, varies the ratio of compression.

Ramp – for Swell effects, sets the time it takes for your sound to “ramp” from quiet to loud.

Depth – for Swell effects, sets how much the volume of your attacks is reduced.

Amount – on De-Essers, chooses the frequency that’s targeted for reduction.

Filter Stomp Boxes

Sens – varies the filter’s response to you playing.

Q – adjusts the filter’s width.

Decay – sets how fast (or slow) the effect trails off.

Wave – allows you to choose from among the effect’s available waveforms.

Mix – controls the ratio of wet (effected) to dry (non-effected) sound that is heard.

-1 Oct – controls how loud you want the “one octave down” waveform.

-2 Oct – controls how loud you want the “two octaves down” waveform.

Filter – sets the corner frequency of the filter’s low-pass filter; frequencies above this frequency are cut.

INTVL1 – chooses the first pitch interval of your original note played.

INTVL2 – chooses the second pitch interval of your original note played.

Attack – controls how long it takes for the effect to happen.

Reference: Tweaking Tones

Pos – represents the current angle of that pedal, with 0% meaning the pedal is fully heel down, and 100% meaning it's fully toe down. If you don't have a pedal connected, you can still adjust **Pos** to get a “parked wah” sound.

Heel – sets how much effect you'll hear when the pedal is at its minimum (heel down) setting. Set it to 0% to have no effect in the heel down position.

Toe – sets how much effect you'll hear when the pedal is at its maximum (toe down) setting.

Modulation Effects

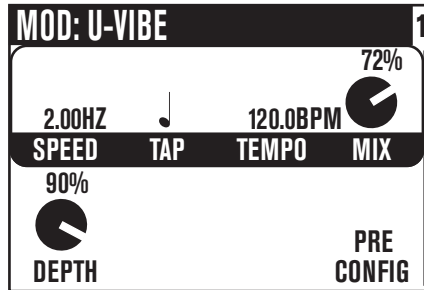

Modulation effects are things that swoosh, pulse and warble—from phase shifters to flangers to choruses. Why are they called modulation effects? Well, if we consult a dictionary, we discover that ‘modulate,’ in the electronic world means to “alter the amplitude or frequency of (a wave) by (using) a wave of a lower frequency to carry a signal” (definition courtesy of The Oxford Encyclopedic English Dictionary, Third Edition, thank you very much). That modulating wave is what causes all that swooshing, pulsing, and warbling.

5•7

Select Knob – turn to load a Modulation effect Model.

Speed – directly controls how fast (or slow) the modulating waveform sweeps.

Tap – set this to OFF to have this effect ignore tempo, or pick a note value that you’d like your speed to match; works with the **Tap** button/footswitch and the **Tempo** knob...

Tempo – Shows the tempo that’s been set by **Tap**, and lets you fine tune it.

Mix – controls the ratio of wet (effected) to dry (non-effected) sound that is heard.

Depth – controls the overall amplitude of the modulating wave, which usually determines just how intense the effect will be.

Bass – bass tone control.

Treble – treble tone control.

Config – allows you to choose the position of the Mod pedal in your signal flow: **Pre** (before the amp model), or **Post** (after the amp model).

Reference: Tweaking Tones

Fdbk – adjusts how much of the effected signal is fed back to the input of the effect.

Manual – on Jet Flanger, controls the length of the very short delay that's applied to the sweep to make the flanging effect happen.

Wave – adjusts shape of the waves that drive the Tremolos and Auto Pan.

Tone – overall tone control

Predly – adjusts how long it takes for the effect to kick in.

Q – adjusts tone focus from sharp to broad

Freq – changes the frequency that the effect is focused on

Flut – adjusts the amount of tape-style flutter for Tape Eater

Dist – distortion, baby!

Delay

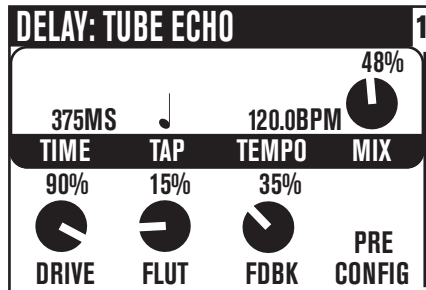

Select Knob – turn to pick a Delay model.

Time – for mono delays, sets the time for the delay line; for stereo delays, sets the time for the left side delay line.

Tap – set this to OFF to have this effect ignore tempo, or pick a note value that you'd like your speed to match; works with the **Tap** button/footswitch and the **Tempo** knob....

Tempo – Shows the tempo that's been set by **Tap**, and lets you fine tune it.

Mix – controls the ratio of wet (effected) to dry (non-effected) sound that is heard.

Bass – bass tone control.

Treble – treble tone control.

Fdbk – adjusts how much of the delayed signal is fed back to the input of the delay.

Config – allows you to choose the position of the Delay pedal in your signal flow: **Pre** (before the amp model), or **Post** (after the amp model).

ModSpd – for delays with modulation, controls how fast (or slow) the modulating waveform sweeps.

Depth – for delays with modulation, controls the overall amplitude of the modulating wave.

Drive – for Tape Delay models, adds some tube warmth.

Flut – for Tape Delay models, adjusts wow-and-flutter, that unique sound of a slipping, dirty capstan.

Heads – for some Tape Delays, enables you to choose from the available combinations of the model's virtual tape heads

Speed – is the speed of the modulation for a modulated Delay Model.

L-Fdbk – for Stereo Delays, controls the left-channel feedback.

R-Fdbk – for Stereo Delays, controls the right-channel feedback.

Offset – for Stereo Delays, sets the time for the right side delay line, as a percentage of the left delay's Time setting.

Spread – for Stereo Delays, sets the stereo spread of the delays from mono to hard-panned left and right.

Tone – overall tone control.

Bits – lets you adjust the delay anywhere from its normal sparklin', pristine 32 bit resolution down to as few as 6 truly nasty bits. Bear in mind that as you turn the knob clockwise, you're reducing the bit resolution, so maximum bit reduction is achieved when the knob is all the way up (think of it as a more control for how many less bits you want). Your direct sound, of course, stays full resolution.

Reverb

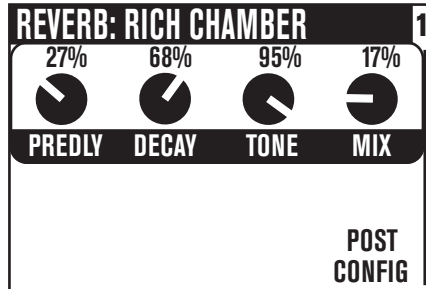

When we set out to create POD X3 and POD X3 Live, we devoted our fanatical modeling technology and energy for innovation to developing no-compromise reverb effects. The collection of reverb models emulate physical environments (rooms and halls), plate reverbs (which traditionally feature a big steel plate with some sort of speaker driving it, and usually multiple pickups to pick up the vibrations of the plate), spring reverbs (the kind guitar players know best), and even a couple of unique new models that you'll have to hear to appreciate.

Select Knob – turn to pick a Reverb model.

Dwell – for Spring reverbs, determines how hard the virtual springs are driven; the harder you drive them, the longer the delay time.

Tone – overall tone control.

Mix – controls the ratio of wet (effected) to dry (non-effected) sound that is heard.

Predly – adjusts how long it takes for the reverb to kick in.

Decay – adjusts how long it takes for the reverb to trail off.

Config – allows you to choose the position of the Reverb in your signal flow: **Pre** (before the Amp Model), or **Post** (after the Amp Model).

Gate

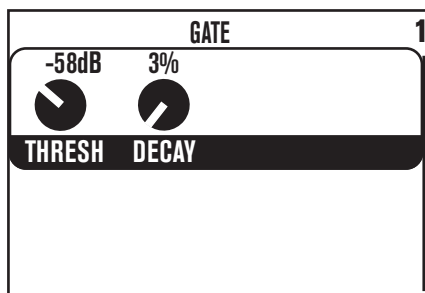

The Gate effect helps eliminate unwanted noise when you're not playing, and can be especially valuable when using high gain sounds. Like a security gate, it's supposed to quickly open to pass the things that you want, and then swing closed to keep out the things that you don't want

5•12

Thresh – determines how loud your playing has to be to open the gate. More negative numbers (where the knob is near its fully-counterclockwise setting) mean that the gate will open and allow sound through even when you are playing quietly, and less negative numbers (where the knob is near its fully-clockwise setting) mean that the gate will only allow sound to pass when you are playing pretty hard. Turn the **Thresh** all the way down to minimum to disable the Gate (**Thresh**'s value will then be “off”).

Decay – determines how fast the gate will swing closed. Like a gate in the real world, a fast decay means the gate might catch your trailing foot as you pass through—in this case, that means the gate will chop off the decay of your notes. And a slow decay means that as the gate swings slowly closed behind you, someone might have time to slip through behind you—in this case, that would be the unwanted noise that you hear as your notes decay. You'll have to experiment with the **Decay** to get just the right happy medium for your particular guitar, playing style, and sound settings.

Compressor

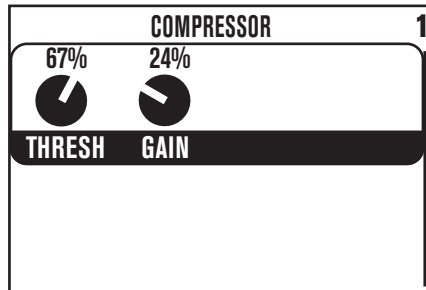

The Compressor effect is just the thing when you want to smooth out your levels the way that you would typically do in a recording studio.

Thresh – determines how aggressive you want the Compressor to be in smoothing things out. More negative numbers make the Compressor more active in taming your levels, so -32dB is a more aggressive setting than -16dB , say.

Gain – controls (what else?) gain, so that even when you're really squashing your signal with an aggressive threshold setting, you'll be able to get good volume levels out of your POD X3.

EQ

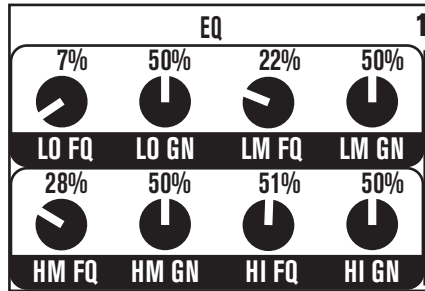

Here's some good, old-fashioned EQ to make your tone sparkle, rattle the neighbor's windows, and everything in-between. You've got (2) bands of shelving EQ and (2) bands of semi-parametric "peaking" EQ to choose from.

Lo Fq – sets the corner frequency of the low-shelf filter, affecting all sound at and below the frequency you select.

Lo Gn – adjusts the gain or cut amount of the low-shelf filter.

Lm Fq – sets the corner frequency of the low-mid peaking filter, affecting all sound at and around the frequency you select.

Lm Gn – adjusts the gain or cut of the low-mid peaking filter.

Hm Fq – sets the corner frequency of the high-mid peaking filter, affecting all sound at and around the frequency you select.

Hm Gn – adjusts the gain or cut of the high-mid peaking filter.

Hi Fq – sets the corner frequency of the high shelf filter, affecting all sound at and above the frequency you select.

Hi Gn – adjusts the gain or cut of the high-shelf filter.

Wah

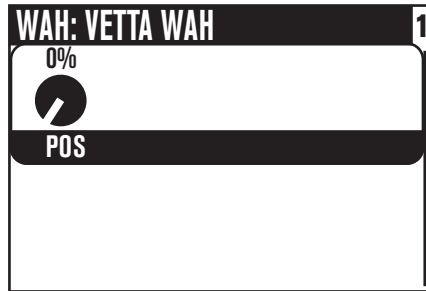

The **Wah** effect is generally expected to be controlled by the pedal built into POD X3 Live or an optional Line 6 FBV foot controller or third-party MIDI controller.

Select Knob – turn to pick a Wah pedal.

Pos – represents the current angle of that pedal, with 0% meaning the pedal is fully heel down, and 100% meaning it's fully toe down. If you don't have a pedal connected, you can still adjust **Pos** to get a “parked wah” sound.

Volume

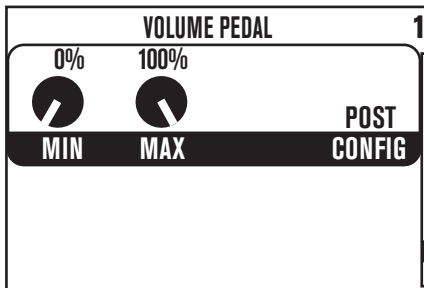

The **Volume** effect is generally expected to be controlled by the pedal built into POD X3 Live or an optional Line 6 FBV foot controller or third-party MIDI controller.

5•16

Min – determines how much volume you’ll hear when the volume pedal is at its minimum (heel down) setting. Set it to 0% to have silence in the heel down position.

Max – determines how much volume you’ll hear when the volume pedal is at its maximum (toe down) setting.

Config – allows you to choose the position of the volume pedal in your signal flow: **Pre** (before the amp model), or **Post** (after the amp model).

Effects Loop (POD X3 Live only)

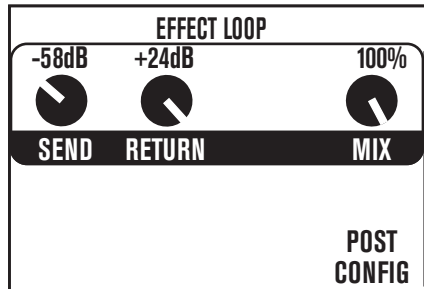

This lets you tweak the settings related to the Tone 1 Effects Loop.

Send – adjusts the gain of the send output from -80 to 0 dB.

Return – adjusts the gain of the return inputs from 0 to +24 dB.

Mix – 0-100%: set this to 100% for parallel-style operation

Config – allows you to place the Effect Loop in two different locations in the POD X3's signal chain:

- **Pre** – after the Stomp block, before the Mod and Delay blocks
- **Post** – before the Mod, Delay and Reverb blocks

REFERENCE: CONFIGURATION & SETUP

Inputs

Press the **Inputs** button to get to the inputs page:

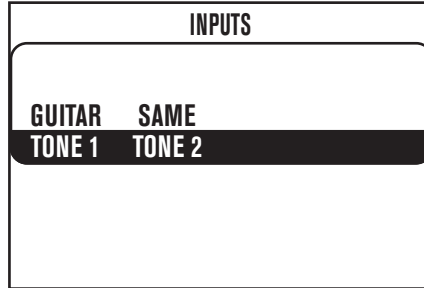

Here, you can route hardware inputs to Tone 1 and Tone 2.

Tone 1 – pick an input to get routed to Tone 1. For POD X3, you can choose Guitar or Microphone. For POD X3 Live, you can also choose Aux, Variax, Guitar + Aux, Guitar + Variax, or Guitar + Variax + Aux.

Tone 2 – pick an input to get routed to Tone 2.

- For POD X3, you can choose Same as Tone 1, Guitar, or Microphone.
- For POD X3 Live, you can also choose Aux, Variax, Guitar + Aux, Guitar + Variax, or Guitar + Variax + Aux.

Outputs

Pressing the **Outputs** button gets you to the first of two Outputs pages:

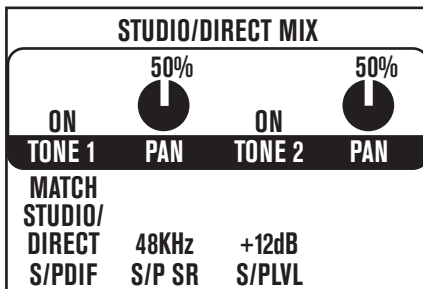

Press the 4-way Nav **Up** and **Down** to move between this and page 2.

OUTPUTS Page 1: Studio/Direct Mix

- This mix provides POD's legendary direct recording sound, ideal for connecting direct to a mixer, recorder, PA, or headphones for "Studio Mode" sound.
- The headphone and USB 1-2 outputs always get this mix.
- For POD X3 Live, this also always feeds the XLR Direct Outs.
- The 1/4-inch outputs can get this mix, too, when desired. (See next page.)

Tone 1 – allows you to either turn On or Mute Tone 1.

Pan – sets the location of Tone 1 in the stereo field.

Tone 2 – allows you to turn On or Mute Tone 2.

Pan – sets the location of Tone 2 in the stereo field.

S/PDIF – sets the signal for the S/PDIF output. There are four options:

- Match Studio/Direct – S/PDIF outputs the Tone and Pan settings as shown.
- Studio/Direct Tone 1 – S/PDIF outputs Tone 1 only, panned center.
- Studio/Direct Tone 2 – S/PDIF outputs Tone 2 only, panned center.

- Dry Inputs – S/PDIF Left outputs the unprocessed input(s) to Tone 1, and S/PDIF right outputs the unprocessed input(s) to Tone 2.

S/P SR – affects the S/PDIF output only, setting the 24-bit S/PDIF signal’s sample rate to 44.1, 48, 88.2 or 96 kHz.

S/P Lvl – affects the S/PDIF output only, adding up to 12 dB of gain. This can be useful to increase the digital output level of sounds that don’t have a lot of Amp Model or stompbox distortion or other settings that are driving their levels up.

OUTPUTS Page 2: 1/4-inch Outputs – this is where you set up the 1/4-inch outputs on both POD X3 and POD X3 Live.

Mode – Turn this knob to pick from:

“Studio” Modes (for direct connections to a mixer, recorder, PA, or headphones)

- Match Studio/Direct – the 1/4-inch jacks output the Studio/Direct Mode Mix set on the first OUTPUTS page.
- Studio/Direct Tone 1 – the 1/4-inch jacks output Tone 1 only, panned center, with Studio Mode processing.
- Studio/Direct Tone 2 – the 1/4-inch jacks output Tone 2 only, panned center, with Studio Mode processing.

“Live” Modes (for feeding a guitar amp, without speaker/mic/room simulation, and with a set of controls for on/mute and pan for Tone 1 and Tone 2 that is independent from the Studio/Direct Mix settings)

- Combo Front – use this to jack into the instrument in of a combo guitar amp.
- Combo Pwramp – use this to jack into the power amp input of a combo guitar amp
- Stack Front – use this to jack into the instrument input of a guitar amp head with separate cab.
- Stck PwrAmp – use this to jack into the power amp input of a guitar amp head with separate cab.

Lows – when Combo Front or Stack Front are chosen for **Mode**, this control appears to let you to lower the overall bass output of POD X3 or POD X3 Live. This helps to counteract any bass boost you may have built into your guitar amp.

Focus – when Combo Front or Stack Front are chosen for **Mode**, this control appears to let you increase the overall midrange output of POD X3 or POD X3 Live. This helps to counteract any mid cut that may be built into your guitar amp.

Highs – when Combo Front or Stack Front are chosen for **Mode**, this control appears to let you lower the overall treble output of POD X3 or POD X3 Live.

Tone 1 – allows you to either turn On or Mute Tone 1, independent of the settings of the Studio/Direct Mix that drive the XLR and other outputs.

Pan – sets the location of Tone 1 in the stereo field, independent of the settings of the Studio/Direct Mix that drive the XLR and other outputs.

Tone 2 – allows you to turn On or Mute Tone 2, independent of the settings of the Studio/Direct Mix that drive the XLR and other outputs.

Pan – sets the location of Tone 2 in the stereo field, independent of the settings of the Studio/Direct Mix that drive the XLR and other outputs.

System

Press and hold the **Outputs / Hold for System** button for 2 seconds to get to the System page:

SYSTEM			
BOTH TONES	1-W/OFF 2-VOL	DLY MIX	COMP
PEDAL	PDL ASS	TWEAK	COMPSW
SETS			
ALL			
1	10	OUTPUTS	
MIDI CH	CONTRST	MSTVOL	

Press the 4-way Nav **Up** and **Down** to move between this and page 2, which shows the firmware version number.

SYSTEM Page 1: Pedal and other settings

The Pedal-related settings here are for the wah/volume/tweak pedal built-in to POD X3 Live, and the pedal on some FBV foot controllers that can be used with POD X3.

Pedal – Use this to have the pedal affect either Tone 1, Tone 2 or Both.

Pdl Ass – The pedal built-in a POD X3 Live and some FBV foot controllers is pedal “1” and the optional external pedal that you can connect to it is pedal “2”. This lets you pick what those pedal(s) control, with these choices:

- 1-W/off 2-Vol – Pedal 1 controls Wah with the toe switch controlling Wah on/off. Pedal 2, if present, controls Volume.
- 1-Twk 2-Vol – Pedal 1 controls whatever is assigned to Tweak below. Pedal 2, if present, controls Volume.
- 1-Wah/Vol 2-Tweak – Pedal 1 controls both Wah and Volume with the toe switch toggling between the two. Pedal 2, if present, controls Tweak, assigned below.

Tweak – If you’ve assigned a pedal to control Tweak, this is where you pick the setting that you want to control. The list of available settings is too long to list here—turn the knob and see what you find!

COMPSW (POD X3 Live only) – Pick which processing block will be controlled by the **Comp (Boost)** footswitch. Your choices are COMP, AMP, or LOOP.

MIDI Ch (POD X3 Live only) – Choose from MIDI Channel 1-16, or select Omni to have POD X3 Live respond to all MIDI channels, while transmitting on Channel 1. When program change messages 0-127 are received, POD X3 Live will recall User Presets 01A-32D, and it will send those same program changes as presets are selected from the POD X3 Live. It also echoes all program change messages it receives, so they can be connected “thru” to another MIDI device.

Contrst – Set the contrast of the POD X3 & POD X3 Live’s display.

MstVol (POD X3 Live only) – Choose whether the Master Volume knob will control 1/4-Live Outputs only, XLR Direct Outputs only, or both (All Outuputs). When playing on stage with a POD X3 Live, you may find it valuable to have the Master Volume affect your 1/4-inch outs only, so you can tweak on-stage levels as needed without altering the levels that you’re sending to the house sound system.

SYSTEM Page 2: Pedal and other settings

From the first SYSTEM page, pressing down on the 4-way Nav takes you to page 2 when the firmware version, USB version, and electronic serial number (ESN) of your unit are displayed.

Commands

Press and hold the **Home / Hold for Commands** button for 2 seconds to get to the Commands page:

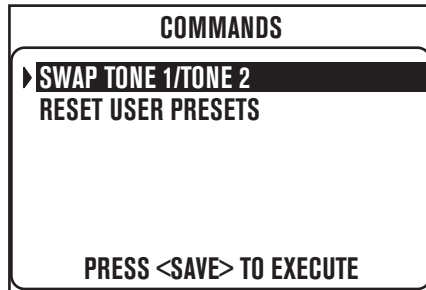

Turn the **Select** knob to choose a Command, then press the **Save** button to execute the Command. Press the **Home** button to exit without executing a command.

6•7

Swap Tone 1 / Tone 2 – Just like the name says, your current Tone 1 and Tone 2 settings will be swapped.

Reset User Presets – This command will reset all 128 User presets to their factory-standard settings. **WARNING: this will destroy any customized settings you may have saved.**

EXAMPLE SETUPS

Need quick instructions for a particular setup? Just follow these easy steps. And like any good recipe, once you've got the hang of things, feel free to add your own tweaks on these recommended settings to spice it up....

Mono or Stereo Recording or Direct to Mixer/PA

1. Connect output(s) to your recorder, mixer or PA:
 - **POD X3:** connect the 1/4-inch outs.
 - **POD X3 Live:** the XLR outputs are recommended for live sound systems, to provide a level that approximately matches a mic'd up amp. You can also use them for recording into mic preamps, or use the 1/4-inch outputs to get hotter, line level outputs.
2. Set the first OUTPUTS page (Studio/Direct Mix):
 - Tone 1: as desired
 - Tone 1 Pan: as desired
 - Tone 2: as desired
 - Tone 2 Pan: as desired
3. When using the 1/4-inch jacks, also set the 1/4-inch OUTPUTS page:
 - Mode: MATCH STUDIO/DIRECT
4. Check your Master Volume.
 - Select the loudest preset/settings you intend to use.
 - Play your instrument and turn Master Volume as high as you can without clipping the system you're feeding.

Recording Tone 1 & 2 to Separate Mono Tracks

1. Connect outputs to your recorder:
 - **POD X3:** connect the 1/4-inch outs.
 - **POD X3 Live:** the XLR outputs are recommended for live sound systems, to provide a level that approximately matches a mic'ed up amp. You can also use them for recording into mic preamps, or use the 1/4-inch outputs to get hotter, line level outputs.
2. Set the first OUTPUTS page (Studio/Direct Mix):
 - Tone 1: On
 - Tone 1 Pan: pan left
 - Tone 2: On
 - Tone 2 Pan: pan right
3. When using the 1/4-inch jacks, also set the second OUTPUTS page (1/4-inch):
 - Mode: MATCH STUDIO/DIRECT
3. In your recording system, assign those outputs to separate recording tracks.

7•2

Recording Tone 1 & 2 to Separate Stereo Tracks (POD X3 Live only)

1. Connect the 1/4-inch left/right outputs to your recorder as the source for the first track, and the XLRleft/right outputs as the source for the second track.
2. Set the first OUTPUTS page (Studio/Direct Mixer):
 - Mode: Studio/Direct
 - Tone 1: Off
 - Tone 2: On (the XLRs will output Tone 2 only)
 - Tone 2 Pan: Center

3. Set the second OUTPUTS page (1/4-inch jacks Outputs):
 - Mode: Studio/Direct Tone 1

Feed One Guitar Amp

1. Connect 1/4-inch output(s) to your amp or speaker system.
2. Set the second OUTPUTS page (1/4-inch Outputs):
 - Mode: Combo Front, Combo Pwramp, Stack Front, or Stack PwrAmp.
 - Lows, Focus, Highs: as desired
 - Tone 1: On
 - Tone 1 Pan: Center
 - Tone 2: On
 - Tone 2 Pan: Center
3. Check your Master Volume.
 - Select the loudest preset/settings you intend to use.
 - Play your instrument and turn Master Volume as high as you can without clipping the amp/speakers you're feeding.

Feed Two Guitar Amps, One for Tone 1 and One for Tone 2

1. Connect the left 1/4-inch output to one amp, and the right 1/4-inch output to the other.
2. Set the second OUTPUTS page (1/4-inch Outputs):
 - Mode: Combo Front, Combo Pwramp, Stack Front, or Stack PwrAmp.
 - Lows, Focus, Highs: as desired
 - Tone 1: On

Example Setups

- Tone 1 Pan: Full Left
 - Tone 2: On
 - Tone 2 Pan: Full Right
3. Check your Master Volume.
 - Select the loudest preset/settings you intend to use.
 - Play your instrument and turn Master Volume as high as you can without clipping the amp/speakers you're feeding.

Feed Two Guitar Amps, One “Wet” and One “Dry”

1. Connect the left 1/4-inch output to one amp, and the right 1/4-inch output to the other.
2. Set the second OUTPUTS page, (1/4-inch Outputs):
 - Mode: Combo Front, Combo Pwramp, Stack Front, or Stck PwrAmp.
 - Lows, Focus, Highs: as desired
 - Tone 1: On
 - Tone 1 Pan: Full Left
 - Tone 2: On
 - Tone 2 Pan: Full Right
3. Check your Master Volume.
 - Select the loudest preset/settings you intend to use for your “dry” sound.
 - Play your instrument and turn Master Volume as high as you can without clipping the amp/speakers that you're using as your dry amp.
4. Set up your “dry” tone.
 - Dial in your dry sound on Tone 1, with little or no “wet” effects,
 - Save your preset.

4. Set up your “wet” tone.
 - From the Home Page, turn the second knob below the display, and begin loading Tone 2 settings.
 - Selecting Tone 1 from the preset you just saved (you’ve copied Tone 1 to Tone 2).
 - Set Tone 2’s Tone Volume low.
 - Add more effects to Tone 2, cranking up the effect mixes, so you hear all or nearly all “wet” signal from Tone 2.
5. Save your preset, using WET in the name of Tone 2, so you’ll remember what it’s for.

Feed a Guitar Amp and Send Separate XLR Direct Outs (POD X3 Live only)

1. Connect 1/4-inch output(s) to your amp or speaker system.
2. Connect XLR output(s) to your recorder, mixer or PA.
3. On first OUTPUTS page (Studio/Direct Mix) set the XLR output signals:
 - Mode: Studio/Direct
 - Tone 1: On
 - Tone 1 Pan: as desired
 - Tone 2: On
 - Tone 2 Pan: as desired
4. On the second OUTPUTS page (1/4-inch Outputs):
 - Mode: Combo Front, Combo Pwramp, Stack Front, or Stck PwrAmp.
 - Lows, Focus, Highs: as desired
 - Tone 1: On
 - Tone 1 Pan: as desired
 - Tone 2: On

Example Setups

- Tone 2 Pan: as desired
5. Check your Master Volume.
 - Select the loudest preset/settings you intend to use.
 - Play your instrument and turn Master Volume as high as you can without clipping the amp/speakers you're feeding.

Electric Guitar to On-Stage Amp & Direct Out + Vocals/Acoustic/etc. to Direct Out Only

1. Connect your electric guitar to Guitar In.
2. Connect your microphone to the Mic in, or your acoustic, etc. to the Aux input.
3. On the INPUTS page:
 - Tone 1: Guitar
 - Tone 2: select the (inputs) you're using for your Mic, acoustic, etc.
4. Connect 1/4-inch output(s) to your amp or speaker system.
5. Connect XLR output(s) to your recorder, mixer or PA.
5. On first OUTPUTS page (Studio/Direct Mix):
 - Mode: Studio/Direct
 - Tone 1: On
 - Tone 1 Pan: Left
 - Tone 2: On
 - Tone 2 Pan: Right
5. On second OUTPUTS page (1/4-inch outputs):
 - Mode: Combo Front, Combo Pwramp, Stack Front, or Stek PwrAmp.
 - Lows, Focus, Highs: as desired

- Tone 1: On
 - Tone 1 Pan: center
 - Tone 2: Mute (so your vocal/acoustic/etc. doesn't go to your on-stage amp)
6. Check your Master Volume.
- Select the loudest preset/settings you intend to use.
 - Play your instrument and turn Master Volume as high as you can without clipping the amp/speakers you're feeding.

USB & COMPUTER SOFTWARE

Updating POD X3 or POD X3 Live's Firmware

Here are step-by-step instructions for making sure your POD X3 or POD X3 Live has the latest firmware installed.

1. From **www.line6.com/monkey**, download and install the latest version of Line 6 Monkey.
2. Run Monkey.
 - If this is the first time you run Monkey, you don't yet have driver software installed, so Monkey won't be able to communicate with your POD X3 or POD X3 Live. (And if you have an older version of Monkey, it also may not show your POD X3 or POD X3 Live in its list of products when it asks you to select your product manually.)
 - If POD X3 or POD X3 Live is not shown as a product selection, **select any TonePort** from the product select menu that Monkey will show as it starts up.
 - Once Monkey finishes start up, login with the user name and password that you use for line6.com, or click the New User button near the top of Monkey's window, create a user name and password for line6.com, and then use it to log in to Monkey.
3. On the Updates tab, look to see if Line 6 Monkey itself is up to date.
 - Monkey is listed under Applications on the Updates tab. A green circle with a checkmark is shown next to its listing if it's up to date. If not, highlight its line in the list of Items, and click the Update button on the right. (Of course, this shouldn't be necessary if you just downloaded the latest!)
4. Once Monkey's up to date, install the latest Line 6 drivers.
 - In the Updates tab, highlight the Driver item, and click the Update button on the right. Monkey will lead you through the process, which requires you to quit Monkey and possibly restart your machine.
5. Once the driver installation completes, run Monkey again.
 - Make sure your POD X3 or POD X3 Live is powered on, and connected to your computer via USB. Monkey should automatically recognize your POD X3 or POD X3 Live and complete its startup.

6. On the Updates tab, look to see if your USB Firmware and Flash Memory are up to date.
 - If either one doesn't show a green circle with a checkmark, highlight Device Firmware and click the Update button to the right. Monkey will lead you through the process.
7. With your Driver and Device Firmware now up to date, you're ready to rock.

Setting Up for USB Recording

1. After getting the latest versions and installing your driver as described above....
2. Start your recording application.
3. Follow its instructions to select POD X3 or POD X3 Live as your audio device.
4. On Windows, you'll probably want to configure POD X3 or POD X3 Live for ASIO operation.
 - For Windows, the POD X3 and POD X3 Live driver control panel is at Programs > Line 6 > Tools > Line 6 Audio-MIDI Devices.
 - For Mac, it's available from the Apple menu, System Preferences > Other > Line 6 Audio-MIDI Devices.
5. With ASIO on Windows, or Core Audio on Mac, POD X3 and POD X3 Live provide 8 audio inputs to your computer:
 - 1-2 is the main signal, configured on POD X3 or POD X3 Live's Outputs page for Digital/XLR Outs.
 - 3-4 is Tone 1 separately in stereo.
 - 5-6 is Tone 2 separately in stereo.
 - 7 is the sum of the inputs you've chosen for Tone 1.
 - 8 is the sum of the inputs you've chosen for Tone 2.

5. The 7 and 8 inputs are perfect as raw sources for plug-in processing.
 - See www.line6.com/gearbox_plugin for info on our POD X3-equivalent plug-in.
6. Connect your headphones or powered speakers directly to POD X3 to hear your computer-generated audio, and well as POD X3's real-time processing.
 - The Monitor level adjustment slider in the control panel lets you turn down the volume of POD X3 or POD X3 Live versus your computer-generated sound.
 - The Master Volume knob on POD X3 or POD X3 Live does NOT affect the USB or S/PDIF output levels.
 - Sample rate and other settings can be made from your recording program, the Line 6 Audio-MIDI Devices control panel, the Windows control panels, and/or Mac OS X's Applications > Utilities > Audio-MIDI Setup. (The Dig SR and DigLvl features on the first OUTPUTS page of POD X3 and POD X3 Live apply to the S/PDIF output only.)

APPENDIX A: MODEL GALLERY

POD X3 and POD X3 Live include the following Models:

- (78) Guitar Amp Models
- (24) Guitar Cab Models
- (4) Guitar Cab Mic Models
- (28) Bass Amp Models
- (22) Bass Cab Models
- (4) Bass Cab Mic Models
- (6) Preamp Models
- (98) Effect Models

The following pages will introduce you to these beauties, and tell you a bit about them.

Guitar Cab Mics

Model Name	Based on*
57 On Axis	Shure SM57 - On Axis
57 Off Axis	Shure SM57 - Off Axis
421 Dynamic	Sennheiser MD 421
67 Condenser	Neumann U67

Bass Cab Mics

Model Name	Based on*
20 Dynamic	EV® RE-20
112 Dynamic	AKG® D-112
Tube 47 close	Neumann® U47 – close mic'd
Tube 47 far	Neumann® U47 – distant mic'd

* All product names used hereon are trademarks of their respective owners, which are in no way associated or affiliated with Line 6. These trademarks of other manufacturers are used solely to identify the products of those manufacturers whose tones and sounds were studied during Line 6's sound model development.

Guitar Amp Models



ANGEL P-Ball: Based on* the 2002 ENGL® Powerball, a four-channel amplifier. We modeled channel 2 (Soft Lead).



1964 Blackface 'Lux: Based on* a Blackface Fender® Deluxe Reverb®, the Holy Grail for many blues, country, and “roots” players.



Blackface Vibro: Based on* the 1963 Fender® Vibroverb 6G16 2x10 – 40 watts of pure heaven.



Bomber Uber: Based on* a 2002 Bogner Uberschall and much like the Bogner Ecstasy, the Uberschall dishes up serious tone for high gain players.



Bomber X-TC: Based on* a 2002 Bogner Ecstasy, this model covers a wide range of tone. It's a really versatile amp from a really great guy.



Brit Bass: Based on* Input I of the 1968 Marshall® Super Bass Plexi head. This is the bottom end you've been searching for.



Brit Gain 18: Based on* the Marshall® 1974X “authentic re-issue” of the famous 1974 18W Combo from the late '60's.



Brit J-2000: Based on* the OD2 channel of a 2003 Marshall® JCM 2000, it captures the modern Marshall tone.

A•2



Brit J-2000 #2: Based on* a 2003 Marshall® JCM2000 with the front end driven by a Prescription Electronics Germ pedal,



1990 Brit J-800: Based on* a 1990 Marshall® JCM-800, one of Marshall®'s most universally-acclaimed modern amps.



Brit J-900 Cln: Based on* the clean channel of a 1992 Marshall® JCM-900, the first true modern high gain amp from Marshall.



Brit J-900 Dist: Based on* the lead channel of a 1992 Marshall® JCM-900. Nice mid tone with lots of gain.

* All product names used hereon are trademarks of their respective owners, which are in no way associated or affiliated with Line 6. These trademarks of other manufacturers are used solely to identify the products of those manufacturers whose tones and sounds were studied during Line 6's sound model development. ENGL is a registered trademark of Beate Ausflug and Edmund Engl. Fender, and Deluxe Reverb are registered trademarks of Fender Musical Instruments Corp. Marshall is a registered trademark of Marshall Amplification Plc.



1996 Brit JM Pre: Based on* Marshall's entry into the rackmount preamp world, the JMP-1, has been a favorite of 'big-hair' metal guitarists.



Brit Major: Based on* Input I of the 1969 Marshall® Major, a LOUD, 200 watt amp which became a favorite of many bassists of the era.



Brit Silver: Based on* the 1987 Marshall® Silver Jubilee, a limited edition tube amp made to commemorate 25 years in the amp business.



1985 Cali Crunch: Based on* the Drive channel of a Mesa Boogie Mark II-C+, truly one of the first modern guitar amplifiers.



Citrus D-30: Based on* a 2005 Orange® AD30TC, a 30 watt, Class A number with a great personality that purrs pure Brit Rock tone.



1960 Class A-15: Based on* Channel 1 of a wonderful Vox® AC-15. The sound is similar to the more famous Vox® AC-30, but this is a smaller amp.



Class A-30 Fawn: Based on* the Normal channel of a Non Top Boost Vox® AC-30. This is definitely a good place to get classic British invasion sounds.



1967 Class A-30 Top Boost: Based on* a Vox® AC-30 Top Boost, the amp made famous by many British invasion bands.



Connor 50: Based on* a 2003 Cornford mk50h, which is a fine, British-made boutique amplifier.



Criminal: Based on* the Lead channel of a 2002 Peavey® 5150 MkII®. This is the tone Eddie Van Halen is known for.



Deity Crunch: Based on* a 2003 Diezel VH4, the Ducati of high performance guitar amplifiers. Our model captures channel 3 on this beauty.



Deity Lead: Based on* Channel 4 of a 2003 Diezel VH4, it has even more gain than Channel 3 (Crunch).

* All product names used hereon are trademarks of their respective owners, which are in no way associated or affiliated with Line 6. These trademarks of other manufacturers are used solely to identify the products of those manufacturers whose tones and sounds were studied during Line 6's sound model development. 5150 II is a registered trademark of E.L.V.H., Inc. Orange is a registered trademark of Orange Personal Communications Services Ltd. Peavey is a registered trademark of Peavey Electronics Corp. Vox is a registered trademark of Vox R&D Ltd.

Appendix A: Model Gallery



Deity's Son: Based on* a 2003 Diezel Herbert, a unique amp that achieves an incredibly wide range of tone on a single channel.



Diamond Plate: Based on* Channel 3 of a Mesa/Boogie® 2001 Triple Rectifier® Solo Head.



Double Show: Based on* a 1967 Fender® Dual Showman®, the rig of choice for many a classic Rock and Roller.



1965 Double Verb: Based on* the classic Blackface Fender® Twin Reverb®. We plugged into Input 1 of the Normal Channel for modeling.



Gibtone Expo: Based on* a 1960 Gibson® Model GA-18T Explorer. 14 watts with a 10-inch Jensen speaker.



1973 Hiway 100: Based on* a Hiwatt® DR-103, this model gives a great, punchy sound that will cut through almost anything.



1987 Jazz Clean: Based on* a Roland® JC-120, the transistor amp known for a strident clean sound and built-in stereo chorus.



1996 Match Chief: Based on* the Matchless Chieftain, a unique-sounding amp that is great for roots-music.



1993 Match D-30: Based on* a Matchless DC-30, the amp that really put Matchless on the map. The DC-30 paid tribute to early Vox® amps.



Mini Double: Based on* the 1996 Fender® Mini-Twin, the little battery powered, dual 2-inch speaker Fender novelty item,



1965 Plexi 45: Based on* a Marshall® JTM-45 'block logo' head, complete with a gold Plexiglas front panel.



1968 Plexi Jump Lead: Based on* a Marshall® 'Plexi' Super Lead with Channel I and Channel II jumpered together.

* All product names used hereon are trademarks of their respective owners, which are in no way associated or affiliated with Line 6. These trademarks of other manufacturers are used solely to identify the products of those manufacturers whose tones and sounds were studied during Line 6's sound model development. Fender, Dual Showman, Twin Reverb are registered trademarks of Fender Musical Instruments Corp. Gibson is a registered trademark of Gibson Guitar Corp. Hiwatt is a registered trademark of Fernandes Company Ltd. Marshall is a registered trademark of Marshall Amplification Plc. Mesa/Boogie and Rectifier are registered trademarks of Mesa/Boogie, Ltd. Roland is a registered trademark of Roland Corp. Vox is a registered trademark of Vox R&D Ltd.



1968 Plexi Lead: Based on* a Marshall® 'Plexi' Super Lead—coveted by tone connoisseurs the world over.



1968 Plexi Variac'd: Based on* a Marshall® 100 watt Super Lead being run at high voltage thanks to a Variable AC Transformer.



Silver Twelve: Based on* the 1967 Silvertone® Twin Twelve head and cabinet combination.



Silverface Bass: Based on* a 1972 Fender® Bassman® Head paired with a 2x15 closed back cab loaded with JBL®'s.



1953 Small Tweed: Based on a "Wide Panel" Fender® Deluxe Reverb®:



1993 Solo 100 Head: Based on* a Soldano SLO-100. While primarily known for its high gain personality, the SLO-100 has a great clean tone as well.



1960s Super O: Based on* the Supro® S6616, the amp probably used by Jimmy Page to record most of the first two Led Zeppelin albums.



Super-O Thunder: Based on* the 1962 Supro® Thunderbolt, a 1x15-inch amp Jimi Hendrix frequently used in the studio.



1960 Tiny Tweed: Based on* a Fender® Tweed Champ®. Many of the classic guitar solos of the 50's were recorded through a Champ®.



2001 Treadplate: Based on* Channel 3 of a Mesa/Boogie® Dual Rectifier® Solo head, one of Boogie's more modern, high gain amps.



1958 Tweed B-Man: Based on* a Fender® Bassman® 4x10 Combo, the amp that started it all — instant rock and roll tone.



1960 Two-Tone: Based on* the Gretsch® 6156, a 1960 1x10 amp made by Valco/Supro.

* All product names used hereon are trademarks of their respective owners, which are in no way associated or affiliated with Line 6. These trademarks of other manufacturers are used solely to identify the products of those manufacturers whose tones and sounds were studied during Line 6's sound model development. Fender, Bassman, Champ, Deluxe Reverb, Dual Showman are registered trademarks of Fender Musical Instruments Corp. Gretsch is a registered trademark of Fred W. Gretsch Enterprises, Ltd. JBL is a registered trademark of Harman International Industries, Inc. Marshall is a registered trademark of Marshall Amplification Plc. Mesa/Boogie and Rectifier are registered trademarks of Mesa/Boogie, Ltd. Silvertone is a registered trademark of Samick Music Corp. Supro is a registered trademark of Zinky Electronics.



2001 Zen Master: Based on* a Budda Twinmaster 2x12 combo, this model has a great, warm, Class A/B, sound.

Line 6 Agro – An aggressive high gain amp with a unique Mid control that will take you through the entire gamut of tone on one knob. How did we do it? The mid knob for this model changes the character of the distortion. When set to minimum the distortion exhibits Fuzz pedal characteristics. When the Mid is set to noon it creates creamy modern high gain amp tones a la Soldano. And when the Mid knob is turned up to Max it's very much reminiscent of that Class A Vox® sound. Of course, then there are all the places in between...

Line 6 Bayou – Another Line 6 original model, this is the result of our quest to capture the fondly remembered tone of a harp player blowing through a beat up old Fender® Deluxe®, as heard in a roadhouse in Baton Rouge, Louisiana.

Line 6 Big Bottom – Just can't seem to get enough bottom end out of your cabinet? Try punishing it with Big Bottom. We crossed a Boogie Triple Rectifier® with a Rivera Los Lobottom sub rig and dialed it in for serious disembowelment. But it's not just about the bass. A super wide midrange control and an extra presence high midrange maintain articulation and power throughout the tonal range of this amp.

Line 6 Boutique #1 – Based on* the POD 2.0 model of the Clean Channel from the Dumble® Overdrive Special. The Dumble® Overdrive Special is one of those incredibly expensive, custom amps that most people never get a chance to actually get close to in this lifetime. Each incarnation of the Dumble® magic is a little bit different, because each of these amps is hand built for a specific customer, and voiced to match their playing and desires. With that in mind, we based this TubeTone Amp Model on the analysis of several different Dumble® Overdrive Specials. Despite this tuning to the individual owner, these amplifiers tend to have a number of features in common; the clean channel is very sensitive to attack, and dynamically responsive, and the drive channel has a thick, liquid, singing sustain that doesn't lose string definition when driven hard. The tone controls on this Amp Model are quite subtle, like those of the Dumble® itself.

* All product names used hereon are trademarks of their respective owners, which are in no way associated or affiliated with Line 6. These trademarks of other manufacturers are used solely to identify the products of those manufacturers whose tones and sounds were studied during Line 6's sound model development. Dumble is a registered trademark of Howard Alexander Dumble. Fender, Deluxe Reverb are registered trademarks of Fender Musical Instruments Corp. Mesa/Boogie and Rectifier are registered trademarks of Mesa/Boogie, Ltd. Vox is a registered trademark of Vox R&D Ltd.

Line 6 Chemical X – Just like those secret ingredients that detergent companies used to crow about (Now with Ingredient X-27!), the Line 6 sound design guys wouldn't tell us anything about the inspiration for this one or who it might have belonged to (no matter what type of bribery we attempted). Suffice to say that it's a very punchy hi-gain sound that also cleans up quite nicely when you roll your volume back.

Line 6 Chunk Chunk – The name says it all. You're guaranteed to feel your pants flapping with this model. Plenty of low end with a tight response. This high gain model has lots of beef so start shredding.

Line 6 Class A – One of the most satisfying tonal experiences as a guitarist is to play through an amp that's driven to the point where the power amp is just starting to distort, but before it achieves full clipping. For many players, this is the coveted 'sweet spot' they look for on an amp. Because we're not limited to physical reality when we're creating amps in the digital world, our goal for this one was to make an amp model that was nothing but sweet spot. One of the great side effects is the ease of coaxing feedback out of this one.

Line 6 Clean – To create this Amp Model, we essentially grafted the preamp and tone stack of a JC120 (Roland®'s popular "Jazz Chorus" solid state combo) onto the power amp and transformer of a classic Marshall® JTM-45 tube head, thereby giving you the crisp and clear front end typical of a solid state amp, but with a rich, satisfying tube amp-style bite as you turn it up.

Line 6 Crunch – Just like a good chef, our Sound Designers are always experimenting with new recipes. They added a pinch of plexi, hardwired four inputs for increased gain, and then rounded it off with a dash of Secret Sauce. The result is this model really cooks. Just turn up the Drive and tweak to taste.

Line 6 Fuzz – Although not technically an amp, we loved the unique tonal qualities of the classic 1960's Arbiter® Fuzz Face enough to base a special amp model on it. This fuzz box used broad frequency, transistor-based clipping. The result is a buzzing kind of distortion that has become popular again with the alternative and grunge set. Jimi Hendrix was among the guitarists to popularize the Fuzz Face in the States, but our model is considerably dirtier than

* All product names used hereon are trademarks of their respective owners, which are in no way associated or affiliated with Line 6. These trademarks of other manufacturers are used solely to identify the products of those manufacturers whose tones and sounds were studied during Line 6's sound model development. Arbiter is a registered trademark of Arbiter Group Plc. Marshall is a registered trademark of Marshall Amplification Plc. Roland is a registered trademark of Roland Corp.

the tones found on “Are You Experienced.” Try playing “Satisfaction” by the Stones, or the lead from “American Woman” by The Guess Who. Liberal use of the Bass, Mid, and Treble controls will let you go beyond the tones that the Fuzz Face could deliver, enabling you to discover your own unique recipe for those elusive fuzz tones in your head. Just a note: when recording Purple Haze, Jimi didn’t even use an amp – he just went straight from a Fuzz Face to an Orange® power amp to a 4x12 cabinet. Which is the same sort of tone you get here…

Line 6 Insane – Our goal here was to provide you with as much input gain distortion as possible short of complete meltdown. You get ridiculous, rich tube drive to shame the distortion of pretty much any amp on the planet (sort of like a Mesa/Boogie® Dual Rectifier® on 10 being used as a preamp for a Soldano), while still retaining tonal definition and character. As a result, you’ll enjoy lots of bottom end and cabinet character with tons of wide-ranging tone shaping. Crank up the Drive and take no prisoners!

Line 6 JTS-45 – Since the design of early Marshall®s was based on the Fender® Tweed Bassman® circuitry, we wondered what it would be like if we took the preamp and tone stack of our JTM 45 and ran it into the power amp and transformer of our ‘58 Tweed Bassman®. What we got was way happening, as JTS-45 will attest. Great grind and nice punch. A tone the whole family can enjoy.

Line 6 Lunatic – High gain with lots of high mids and no mud. Great for layering with other amps to cut through on the high end. A wide range of top is available with the Treble and Presence controls (maybe to the edge of lunacy).

Line 6 Modern Hi Gain – Based on* the POD 2.0 model of the Soldano X88R. The Soldano sound is intensely overdriven, and also has EQ after the preamp distortion. This oversaturated tone is well-suited to thrash metal and grunge bands, but has also been used more subtly by artists like Eric Clapton. This is a good Amp Model to use if you want to get a current Van Halen or Joe Satriani sound. The Modern Hi Gain Amp Model is based on one of Mike Soldano’s rackmount preamps. Talk about high gain preamp tube distortion! The X88R we studied to create this Amp Model would have been the rage for Los Angeles studio use in the late ‘80s.

** All product names used hereon are trademarks of their respective owners, which are in no way associated or affiliated with Line 6. These trademarks of other manufacturers are used solely to identify the products of those manufacturers whose tones and sounds were studied during Line 6’s sound model development. Arbiter is a registered trademark of Arbiter Group Plc. Fender, Bassman are registered trademarks of Fender Musical Instruments Corp. Marshall is a registered trademark of Marshall Amplification Plc. Mesa/Boogie and Rectifier are registered trademarks of Mesa/Boogie, Ltd. Orange is a registered trademark of Orange Personal Communications Services Ltd.*

Line 6 Mood – And here we give you a fantasia tone, based on our memories of grunge guitar tones we have known and loved.

Line 6 Octone – Now here’s something we hope you’ll really like. What would it be like if you built a tube-based Octave Distortion preamp for a Class A power amp? Line 6 Octone provides the answer. You’d get an Octave box that tracks better than anything you’ve ever used, deals with consonant intervals with a degree of panache that just wasn’t possible before, and kicks some major rock and roll butt!

Line 6 Piezacooustic 2 – This one is designed to work with the piezo output of solidbody electrics that have one of those newfangled bridges with the ‘acoustic’ pickup built in. Since you don’t have to worry about the body shaking itself to pieces with feedback on that type of guitar, we’ve cooked up this model with more low-mids and low frequencies.

Line 6 Purge – Like ‘80s shred guitar? Well, then, you’re gonna love Line 6 Purge. We took our model of a Marshall® JMP-1 preamp and hot-rodged it. It was hard work sticking in that digital dual overhead cam and hooking up the virtual glasspacks, but when we were done, we had the ultimate shred machine. Look out world, here you come.

Line 6 Smash – Got an axe to grind? Dial up Smash to take it way over the top with an obscene helping of gain. Smash delivers a tight bottom end, and a serious mid range void that’ll render Hi-Fi, butt-kicking rhythm tone every time.

Line 6 Sparkle – We love tweed Fender®s. We love blackface Fender®s. We love ’em both so much, we can never really decide which one we like more. Luckily, we were able to come up with the perfect way to share the love. We took the preamp and tone stack from our model based on the ’58 Tweed Bassman®, and we wired (in the virtual world) our model of a blackface Bandmaster power amp and transformer onto it. Voilà! Line 6 Sparkle.

Line 6 Sparkle Cln – Need Lots of Sparkle? Need lots of clean? You’ve come to the right place. Plenty of high end zing.

** All product names used hereon are trademarks of their respective owners, which are in no way associated or affiliated with Line 6. These trademarks of other manufacturers are used solely to identify the products of those manufacturers whose tones and sounds were studied during Line 6’s sound model development. Marshall is a registered trademark of Marshall Amplification Plc.*

Line 6 Spinal Puppet – You know how, when you’re playing head-bangin’ music, you look out into the audience and see all those heads bobbing up and down? Those are Spinal Puppets. Need we say more?

Line 6 Super Cln – Forget what you know about how clean or how bright a guitar amplifier can go. Line 6 Super Clean goes farther, adding a lot of brightness. While this model certainly is Clean, it has two other fun tricks up its sleeve as well: Setting the Drive knob at max gives a really broken “small amp on 10 about to die” sound. FUN! And the bass knob has an extreme effect when set to minimum— for sweet AM radio sounding tone.

Caution: Because Super Clean adds so much brightness, it generally won’t work so well with distortion pedals, since they usually add lots of high frequencies, too. The combination may produce unnatural artifacts—or just rip your head off. Plug an undistorted guitar in here, though, and we’re talking super happy shiny bright.

Line 6 SuperSpark – You know how all great amps have a certain sweet spot — a particular setting where they sound magical — dripping with tone? Super Sparkle captures that organic vibe with a new twist: its voiced in the clean/low gain realm where everything usually sounds too clinical or too dark. Super Sparkle is an edgy tone that will sparkle and shimmer if you treat her right. So play nice.

Line 6 Throttle – Pedal to the metal, this Line 6 original is a medium-high gain tone with a nice throaty growl. Grab the Drive knob to give it some gas.

Line 6 Treadplate – The original POD and POD 2.0 had a popular amp model that was our best attempt at the time to make a model based on* the Mesa/Boogie® Rectifier® series of amplifiers. In addition to the Boogie® vibe, that model had some unique qualities that were all its own, and people it liked so much, they asked us to let them get that same sound with the newest generation PODxt. So here it is. In a way, Treadplate marks the first time we’ve actually modeled another Line 6 product! Here is an excerpt from the old POD manual to describe it: “...modeled after* a 1994 Mesa/Boogie® Dual Rectifier Tremoverb®. You can use this Amp Model to get that tight, high gain sound used by bands like Dream Theater or Metallica.”

* All product names used hereon are trademarks of their respective owners, which are in no way associated or affiliated with Line 6. These trademarks of other manufacturers are used solely to identify the products of those manufacturers whose tones and sounds were studied during Line 6’s sound model development. Fender, Bassman are registered trademarks of Fender Musical Instruments Corp.

Line 6 Tube Preamp – This model was created to give POD X3 and POD X3 Live users a solution for plugging the output from an acoustic guitar’s piezo pickup or a bass into POD X3 or POD X3 Live hardware. It can also deliver some tasty tones with a standard electric guitar. With the tone controls at 12 o’clock, the EQ is “flat.”

Adventurous recordists will find that it can even be used to add some tube warmth or distorted grind to just about anything — warming up keyboards, crunching up drums, and fuzzing up vocals the way producers and engineers often do in the studio with vintage tube gear. When you do this stuff, you want to use the Drive control like a mix knob on a reverb to control how much processing you want to hear.

Line 6 Twang – Here’s the flip side of the Sparkle formula. Graft the preamp and tone stack from our model based on a ’65 blackface Deluxe® onto the power amp and transformer based on a ’58 Bassman®. Whaddya know? It ends up being a great roots and rockabilly amp (like we should be surprised).

Line 6 Variax Acoustic – One of the great features of the Variax Digital Modeling Guitars from Line 6 are their models of acoustic instruments. These sounds are best appreciated through a full range monitor or P.A., due to their high frequency content. This Amp Model was created in order to allow the Variax’s acoustic models to sound as full-range as possible through the speakers of typical guitar amps. This can come in handy when you’re using an acoustic model from a Variax, and listening to it through a guitar amp’s speakers. Keep in mind that since this model provides a large amount of high frequency boost (to compensate for the natural roll-off of typical guitar speakers) and overdriving a model playing an acoustic guitar is not usually a desired thing, this model will likely appear softer than most of its compatriots. If you need more gain, the Drive knob can be used to add some tube preamplification.

* All product names used hereon are trademarks of their respective owners, which are in no way associated or affiliated with Line 6. These trademarks of other manufacturers are used solely to identify the products of those manufacturers whose tones and sounds were studied during Line 6’s sound model development. Fender, Bassman, Deluxe Reverb are registered trademarks of Fender Musical Instruments Corp. Mesa/Boogie and Rectifier are registered trademarks of Mesa/Boogie, Ltd.

Guitar Cabinet Models

Model Name	Based on*
1x6 Super O	6x9 Supro S6616
1x8 Tweed	1961 Fender® Tweed Champ®
1x10 Gibtone	1x10 Gibson®
1x10 G-Brand	Gretsch® 6156
1x12 Line 6	Line 6 1x12
1x12 Tweed	1953 Fender® Tweed Deluxe
1x12 Blackface	1964 Fender Blackface Deluxe®
1x12 Class A	1960 Vox® AC-15
1x15 Thunder	1x15 Supro '62 Thunderbolt
2x2 Mini T	2x2" Fender® Mini Twin
2x12 Line 6	Line 6 2x12
2x12 Blackface	1965 Fender® Blackface Twin Reverb®
2x12 Match	1995 Matchless® Chieftain
2x12 Jazz	Roland® JC-120
2x12 Class A	1967 Vox® AC-30
2x12 Wishbook	2x12 Silvertone® '67 Twin Twelve
4x10 Line 6	Line 6 4x10
4x10 Tweed	1959 Fender® Bassman®
4x12 Line 6	Line 6 4x12
4x12 Green 20's	1967 Marshall® Basketweave with Greenbacks
4x12 Green 25's	1968 Marshall® Basketweave with Greenbacks
4x12 Celest T-75	1978 Marshall® with stock 70s
4x12 Celest V-30	1996 Marshall® with Vintage 30s
4x12 Treadplate	4x12 Mesa Boogie®
No Cab	You will probably want to use this Cabinet model with the Tube Preamp model for non-guitar sources. It is selected by default when you pull up the Tube Preamp Amp Model.

* All product names are trademarks of their respective owners, which are in no way associated or affiliated with Line 6. These product names, descriptions and images are provided for the sole purpose of identifying the specific products that were studied during Line 6's sound model development. Fender, Champ, Deluxe Reverb, Twin Reverb, and Bassman are registered trademarks of Fender Musical Instruments Corporation. Gibson is a registered trademark of Gibson Guitar Corp. Vox is a registered trademark of Korg Europe Limited. Matchless is a registered trademark of Matchless, LLC. Roland is a registered trademark of Roland Corporation. Marshall is a registered trademark of Marshall Amplification Plc. Mesa/Boogie is a registered trademark of Mesa/Boogie, Limited. Silvertone is a registered trademark of Samick Music Corporation.

Bass Amp Models



Adam and Eve: Based on* an Eden Traveller WT-300, one of Eden's latter offerings which produces a clean, clear and rich tone.



Alchemist: Based on* an Alembic F-2B preamp, which delivers world-class tone to bassists, engineers and record producers everywhere.



Amp 360: Based on* an early 70's Acoustic 360, as used by Larry Graham, John Paul Jones, and Jaco Pastorius.



Brit Bass: Based on* a 1968 Marshall® Plexi Super Bass. Brighter than the Major, it sounds "fuzzier" with higher Drive settings.



Brit Class A 100: Based on* a Vox® AC-100, the rig Paul McCartney began using in 1965 when he had outgrown his Vox® T-60.



Brit Major: Based on* a Marshall® Major paired with a '76 Marshall® 4x15 cab – a unique and awesome sound.



California: Based on* a Mesa/Boogie® Bass 400+, which has been the mainstay of Boogie's bass line for over a decade.



Double Show: Based on* a 1967 Fender® Dual Showman®, the rig of choice for many a classic Rock and Roller.



Eighties: Based on* a Gallien-Krueger 800RB bass amp, which produces a very scooped sound, and doesn't really distort.



Flip Top: Based on* an Ampeg® B-15 Portaflex®, one of the most popular studio bass amps of all time.



Hiway 100: Based on* a Hiwatt® DR-103, a powerfully clean guitar amp that would often find its way into a bass rig and do the job just fine.



Hiway 200: Based on* a Hiwatt® 200DR. Imagine a brighter Ampeg® SVT® with a little more attack and you've got this monster.

* All product names used hereon are trademarks of their respective owners, which are in no way associated or affiliated with Line 6. These trademarks of other manufacturers are used solely to identify the products of those manufacturers whose tones and sounds were studied during Line 6's sound model development. Aguilar is a registered trademark of David Boonshoft. Ampeg, SVT, and Portaflex are registered trademarks of St. Louis Music, Inc. Fender, Dual Showman are registered trademarks of Fender Musical Instruments Corp. Hiwatt is a registered trademark of Fernandes Company Ltd. Marshall is a registered trademark of Marshall Amplification Plc. Mesa/Boogie is a registered trademark of Mesa/Boogie, Ltd. Vox is a registered trademark of Vox R&D Ltd.

Appendix A: Model Gallery



Jaguar: Based on* an Aguilar® DB750, a super-clean and super-warm amp perfect for players who need to hear it all.



Jazz Tone: Based on* a Polytone Minibrute®, the original 1x15 amp can best be described as intimate and subdued.



Motor City: Based on* a Versatone Pan-O-Flex 1x12 combo that was a hit in the LA Studio scene – in particular, at RCA Studios.



Rock Classic: Based on* a mighty 1974 Ampeg® SVT® with a 70's SVT® 8x10 speaker cabinet.



Silverface Bass: Based on* a 1967 Fender® Bassman® Head paired with a 2x15 closed back cab loaded with JBL®'s.



Stadium: Based on* a Sunn® Coliseum 300—the amplifier that spawned the explosion of power line-ups throughout the 60's and 70's.



Studio Tone: Based on* a SWR® SM-500, one of the most, if not the most, recognizable and popular of all contemporary bass amps.



Tweed B-Man: Based on* a Fender® Bassman® 4x10 Combo, the amp that started it all — instant rock and roll tone.

Line 6 Brit Invader – Since Class A amps overdrive differently than their Class B cousins, we just had to jack our trusty basses into our favorite Vox® AC 30 Top Boost. Out of respect for those ultra-rare blue back speakers (and fear of the repercussions of blowing one of ‘em!) we set our beloved Vox® on top of a Marshall® Major 4x15 cabinet. We happily found this unlikely combination produced a very furry tone that readily responds to any tonal adjustments you may make on your bass or this model. And with a little tweaking we went from a top end that could cut through anything to a pleasurable vintage “woofyness” that would make Joe Meek proud.

Line 6 Classic Jazz – Join us, for a moment, in contemplation of the Roland® JC120. If you think about it, it’s easy to follow our logic – it’s an amp that has a great reputation for cleanliness and accuracy. Now aren’t those two tonal characteristics often sought after by

* All product names used hereon are trademarks of their respective owners, which are in no way associated or affiliated with Line 6. These trademarks of other manufacturers are used solely to identify the products of those manufacturers whose tones and sounds were studied during Line 6’s sound model development. Ampeg and SVT are registered trademarks of St. Louis Music, Inc. Fender, Bassman, Sunn, SWR are registered trademarks of Fender Musical Instruments Corp. JBL is a registered trademark of Harman International Industries, Inc. Marshall is a registered trademark of Marshall Amplification Plc. Minibrute is a registered trademark of Pamco Enterprises, Inc. Roland is a registered trademarks of Roland Corp. Vox is a registered trademark of Vox R&D Ltd.

bassists in every genre? Grab a bass, plus in, and behold—it definitely works for us! Try pairing the Line 6 Classic Jazz Model with the 8 x 10 SVT® cabinet model. You’ll be glad you did.

Line 6 Doppelganger – Loosely based on a Fender® Twin, this original Line 6 creation gives up the low end with a nice, friendly rattle in the high mids. To enhance the Doppelganger and its unique sonic character, choose a speaker cabinet of the open back variety.

Line 6 Ebony Lux – This original creation was inspired by a Fender® black face Deluxe Reverb.® Although not commonly used for bass, plugging a bass into this Holy Grail of guitar tone yields a most pleasurable experience to say the least. Imagine a clear top end, transparent bottom and a nice mid scoop that makes your bass wonderfully unobtrusive. This amp model makes it easy to find the proper space for your bass when accompanying those finicky singer/songwriters who don’t want anything getting in the way of their precious guitar or dainty piano!

Line 6 Frankenstein – Are your dreams filled with warm and fuzzy bass tones with lots of sustain? If so, the sound designers here at Line 6 are in the business of making your dreams come true. We’re not sure what they used to cook up the JTS 400-S, but based on the secret apocryphal codex created by those afore-mentioned sound designers, our guess is that this is one of their Marshall®/Fender® Frankensteins. Could it be the front end of a 100 watt Plexi grafted on to the power section of a Dual Showman®? Or something like that? Whatever this is, our tone wizards (who, by the way, are seen occasionally inside the Line 6 Tone Lab wearing capes and funny hats) concocted it with sweet, fuzzy bass in mind. The first time we plugged in to this dream machine, we, as Captain Beefheart used to be fond of saying, “...hit the lunar note and let it float....” Man, we’re still happy we did.

Line 6 Sub Dub – This fabulous tone was brought to us by Justin Meldal-Johnsen currently in his own band “Ima Robot”, who’s also played bass with Beck, Tori Amos, Air, Macy Gray and other luminaries. When we were creating the original Bass POD, he brought his rack full of esoteric gear into the studio for us to poke and prod and model. The resulting Amp Model was included in the original Bass POD, and has become a particular favorite of the Bass POD faithful. It’s perfect for Hip Hop, Electronica, Trance, Eurodance, Rave and all of your Alternative tone needs. Lower Drive settings produce virtually no clipping (distortion), while higher Drive settings will produce massive square wave distortion (thus giving your synth player tone envy). Dig Justin’s own description...

** All product names used hereon are trademarks of their respective owners, which are in no way associated or affiliated with Line 6. These trademarks of other manufacturers are used solely to identify the products of those manufacturers whose tones and sounds were studied during Line 6’s sound model development. Ampex and SVT are registered trademarks of St. Louis Music, Inc. Fender, Deluxe Reverb, Dual Showman are registered trademarks of Fender Musical Instruments Corp. Marshall is a registered trademark of Marshall Amplification Plc. Roland is a registered trademarks of Roland Corp. Vox is a registered trademark of Vox R&D Ltd.*

“Dark and oh so deep, this is the sound you pull out when it’s time to go lower than low... to hit deeper than the Moog line, to rock harder than the 808 kick. The sound of this model is a particular, well-tuned, fundamental tone which gives you a lot of serious pure “note” without the muddiness you get when you try and make your amp do it. For myself, the sound creates a similar effect to standing in front of a well-executed bass rig with a few 18-inch speakers involved to handle the low parts of the sound spectrum (which is what I do playing live). Inspiration for this sound for me came from everyone from Massive Attack to Dr. Dre, DeAngelo to Aphex Twin, King Tubby to Future Sound of London, and all other champions of the ultra-low.” Thanks Justin – we couldn’t have said it any better!

Line 6 Super Thor – If you were in a roomful of vintage gear, an open back, little ol’ combo amp is probably the last thing you’d choose to play your bass through, right? Well, its one of the first we plugged into, but we like doing the unexpected. Anyway, this tough little cookie we call the Super Thor is based on the Supro® Thunderbolt, the bass-minded love child Line 6 and the infamous Supro® S6616 of early Led Zeppelin fame. Our very reliable sources also tell us that Jimi Hendrix occasionally played through a Supro® Thunderbolt. We figured that if that little amp, mic’d up right in a studio, could churn out big guitar tones for the big Jim’s, maybe a bass-loving cousin could do something similarly huge for us. After you’ve dialed in a tone to your liking, notice that the harder you hit your strings, the more fuzz on the peach! We’ve also found that Super Thor adds a very warm character to the Synth/Filter models.

Line 6 Tube Bass Preamp – The thinking went like this: ‘Once people get this POD thing, it’s gonna be so great that they’re gonna wish they could use it for everything—warming up keyboards, crunching up drums, fuzzing up vocals. We’ve gotta give ’em something to do that with!’ So we did. Tube Preamp lets you warm up any sound source the way producers and engineers often do in the studio with vintage tube gear. With the tone controls at 12 o’clock, the EQ is “flat.”

** All product names used hereon are trademarks of their respective owners, which are in no way associated or affiliated with Line 6. These trademarks of other manufacturers are used solely to identify the products of those manufacturers whose tones and sounds were studied during Line 6’s sound model development. Supro is a registered trademark of Zinky Electronics.*

Bass Cabinet Models

Model Name	Based on*
1x12 Boutique	1x12 Euphonics CXL-112L
1x12 Motor City	1x12 Versatone Pan-O-Flex
1x15 Flip Top	1x15 Ampeg® B-15
1x15 Jazz Tone	1x15 Polytone Minibrute®
1x15 Session	1x15 SWR® Big Ben
1x15 Amp 360	1x18 Acoustic 360
1x18 California	1x18 Mesa/Boogie®
1x18+12 Stadium	1x18+12 Sunn® Coliseum
2x10 Modern UK	2x10 Ashdown ABM 210T
2x15 DoubleShow	2x15 Fender® Dual Showman® D130F
2x15 California	2x15 Mesa/Boogie®
2x15 Class A	2x15 Vox® AC-100
4x10 Line 6	4x10 Line 6 Original Model
4x10 Tweed	4x10 Bassman® Combo w/ new speakers
4x10 Adam Eve	4x10 Bassman® Combo
4x10 SilverCone	4x10 Hartke 410
4x10 Session	4x10 David Eden
4x12 Hiway	4x12 Hiwatt® Bass Cab
4x12 Green 20's	4x12 1967 Marshall® Basketweave with Greenbacks
4x12 Green 25's	4x12 1968 Marshall® Basketweave with Greenbacks
4x15 Big Boy	4x15 Marshall® Major
8x10 Classic	8x10 Ampeg® SVT® Cab
No Cab	You will probably want to use this Cabinet model with the Tube Preamp model for non-guitar sources. It is selected by default when you pull up the Tube Preamp Amp Model.

* All product names are trademarks of their respective owners, which are in no way associated or affiliated with Line 6. These product names, descriptions and images are provided for the sole purpose of identifying the specific products that were studied during Line 6's sound model development. Ampeg and SVT are registered trademarks of St. Louis Music, Inc. SWR, Sunn, Fender, Dual Showman, and Bassman are registered trademarks of Fender Musical Instruments Corporation. Mini-Brute is a registered trademark of Pamco Enterprises, Inc. Mesa/Boogie is a registered trademark of Mesa/Boogie Limited. Vox is a registered trademark of Korg Europe Limited. Hiwatt is a registered trademark of Fernandes Company Ltd. Marshall is a registered trademark of Marshall Amplification PLC.

Preamp Models



American Classic: This model is based on* an API® 512 Mic Pre and API® 550b EQ housed in an API® Lunchbox 500 6-B.



Modern: This model is based on* an Avalon® VT-737, which is an excellent example of a modern tube preamp design.

No photo available

Vintage: Based on* a Requisite Y7 mic pre and incorporates elements of analog tape machines of the day.



Vintage U.K.: Based on* the truly classic 1970's Neve 1073 pre-amp, which became the “Gold Standard” of pre-amps.

Line 6 Console – Here’s our model inspired by solid state console mic pre designs, delivering flat frequency response that is very clean and without the additional personality that the other Preamp Models provide. This is a great choice when you want to capture quality audio without adding color, as you might want to do when recording line level instruments like keyboards.

Line 6 Lo-Fi – Looking for something aggressive, trashy, or just plain interesting? Try the Lo-Fi tip. It gives you tones that are very band passed (meaning there’s little low end or extreme high end), with lots of distortion available from the driver knob. You’ll find it’s just the thing when you want your vocals to sound like they came through a telephone, megaphone or toy microphone.

* All product names used hereon are trademarks of their respective owners, which are in no way associated or affiliated with Line 6. These trademarks of other manufacturers are used solely to identify the products of those manufacturers whose tones and sounds were studied during Line 6’s sound model development. API is a registered trademark of Automated Processes, Inc. dba API.

Modulation Effect Models



Analog Chorus: Based on* the Boss® CE-1 Chorus Ensemble, the original stompbox chorus with big, warm and groovy chorus tones.



Analog Square: Based on* the Boss® CE-1 Chorus Ensemble, but with a square wave sacting as the magical modulator.



Auto Wah: Based on* the Mu-Tron® III envelope follower? Part auto-wah, part triggered filter, it's all about wacky.



Bias Trem: Based on* the 1960 Vox® AC-15 Tremolo, which got its pulse by literally varying the bias of the power amp tubes.



Dingo-Tron: Based on* the Mu-Tron® III (modeled for our Auto Wah model) with the “down” switch on. It's kind of like a reverse auto wah.



Jet Flanger: Based on* the A/DA “studio quiet” Flanger with its signature jet-like sweep.



Opto Tremolo: Based on* the optical tremolo circuit that was used in the blackface Fender® amps, like the '64 Deluxe Reverb®.



Phaser: Based on* the phaser that changed the world—the relatively subtle MXR® Phase 90.



Rotary Drum: Based on* the Fender® Vibratone, Fender's® guitar-specific whirling dervish of a tone machine.



Rotary Drum & Horn: Based on* the Leslie® 145, the tube-driven behemoth with its signature rotate-o-rama.

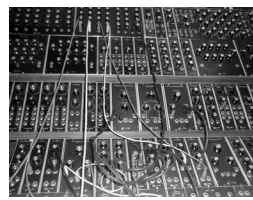

Synth Analog: Based on* Moog and ARP style synth filters. These are great for funky synth guitar (or bass) lines!

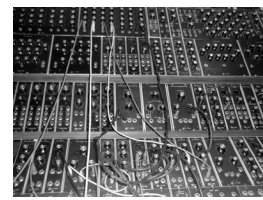

Synth Lead: Based on* the popular analog monophonic synth lead sounds from Moog, ARP and Sequential Circuits.

* All product names used hereon are trademarks of their respective owners, which are in no way associated or affiliated with Line 6. These trademarks of other manufacturers are used solely to identify the products of those manufacturers whose tones and sounds were studied during Line 6's sound model development. MXR is a registered trademark of Dunlop Manufacturing, Inc. Fender, Deluxe Reverb are registered trademarks of Fender Musical Instruments Corp. Leslie is a registered trademark of Suzuki Musical Instrument Manufacturing Co. Ltd. Mu-Tron is a registered trademark of Mark S. Simonsen. Boss is a registered trademark of Roland Corp. Vox is a registered trademark of Vox R&D Ltd.

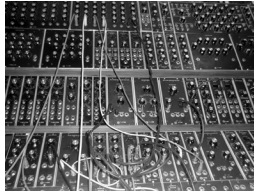

Synth String: Based on* classic string sounds like those found in the ARP Solina String Ensemble and the Elka Synthex.



U-Vibe: Based on* the now-legendary Uni-Vibe®, a four-stage phase shifter, known for its watery texture and sultry tones.

Line 6 Buzz Wave – These are cool combinations of saw and square waves with fast vibrato. The 8 different WAVE parameters offer different vibrato speeds and different pitches.

Line 6 Clean Sweep – This is a wide range sweeping filter with a slow decay. It's similar to Auto Wah, but with a band pass filter shape. Try setting the Decay all the way up, the Sensitivity half way up and the Q all the way down.

Line 6 Double Bass – This effect has two oscillators that track the pitch of your guitar. One square wave tuned one octave down, and one saw tooth wave two octaves down.

Line 6 Expo Chorus – A Line 6 creation, the “Expo” in this Chorus stands for exponential, which is a fancy way of saying that the sweep of the flanging spends extra time in the ‘swooshy’ part of the Chorus.

Line 6 Expo Flange – Here's that exponential sweep we first found in the Expo Chorus, this time applied to a flange effect. The Feedback and Pre-delay knobs on Page 2 can help you keep it in check or make it as strange as you want. We think you know which way we're leaning on that one.

Line 6 Flanger – Cooked up in the Line 6 labs, this creation really shines when you set config to post, letting its stereo sweep offset serve up luscious harmonic shimmer.

Line 6 Hi Talk – The Line 6 tone chefs managed to combine a moog-like filter and a rotary speaker in a touch-sensitive, tap-tempo package. As a result, the Hi Talk can make heads spin with its high-passed filtered frequencies. Try this one to dress up some mean distortion!

* All product names used hereon are trademarks of their respective owners, which are in no way associated or affiliated with Line 6. These trademarks of other manufacturers are used solely to identify the products of those manufacturers whose tones and sounds were studied during Line 6's sound model development. Uni-Vibe is a registered trademark of Dunlop Manufacturing, Inc.

Line 6 Lumpy Phase – A Line 6 original, Lumpy Phase is exactly that—‘lumpy.’ Kinda like a Uni-Vibe, but more radical. It also has some built in overdrive and more of a ‘flange-y’ type of sound due to our clever blending of a short delay into the swept signal. Bass and Treble knobs on page 2 give you extra flexibility.

Line 6 POD Purple X – This is definitely a “sound effect.” We wanted something crazy that had a “broken” sound to it. If played properly you can emulate the sound of a Pod Racer from Star Wars Episode I.

Line 6 Random Chorus – This chorus uses three different modulating filters all running randomly. A very busy chorus sound to be sure.

Line 6 Random Sample and Hold – This has a similar effect as the old Oberheim Voltage Controlled Filter. It creates changes in tone by randomly emphasizing certain frequencies. Try locking this effect to the tap tempo and playing single chords to that tempo. This effect is so inspiring, you’ll probably write a few new tunes based around the effect.

Line 6 Rez Synth – These are all sweeping low pass filter effects with the resonance set high. Resonance is a peak at the frequency of the low pass filter.

Line 6 Saturn 5 Ring Mod – Ring modulators take two signals (one supplied by your guitar, the other supplied by the effect) then adds and subtracts similar frequencies. Electro-Harmonix® makes a ring modulator pedal called the Frequency Analyzer that is a popular guitar effect. The only limiting factor is that the pitch of the signal provided by the effect is constant. Meaning you have to play only in the key of that pitch to be musical.

Line 6 Seismik Synth – This effect has an oscillator that tracks the pitch of your guitar. You can choose between 8 different wave shapes which give you different “flavors” – all of them one or two octaves down from the original pitch. DEATH TO ALL SUBWOOFERS!!

Line 6 Sine Chorus – Your basic digital chorus (as opposed to the analog type vibe of the Analog model), with a sine wave as the modulator. Smooth going down, with bass and treble controls for bassing and trebling.

Line 6 Square Chorus – This one’s a bit smoother than the Analog Square, but the basic vibe is similar, thanks to the square wave modulator at the heart of the effect. You’ll find Bass and Treble controls for a bit of extra tone tweaking when desired.

* All product names used hereon are trademarks of their respective owners, which are in no way associated or affiliated with Line 6. These trademarks of other manufacturers are used solely to identify the products of those manufacturers whose tones and sounds were studied during Line 6’s sound model development. Electro-Harmonix is a registered trademark of New Sensor Corp.

Appendix A: Model Gallery

Line 6 Square Flange – This the same as the Line 6 Flanger, but using a square waveform instead of a sine wave.

Line 6 Sweeper – Imagine having 2 wah pedals on steroids separated in a stereo field that are pulsating in opposite positions and you're close to what you'll hear here. Use the Q and Freq to set the character of the sweep and adjust your depth to go from subtle to full on freak out. Any resemblance to guitar tracks heard in a particular genre of B films is strictly coincidental.

Line 6 Synth FX – These sounds aren't really designed to be musical. These are more “special effects” sounds. You'll hear a lot of these kinds of sounds in movie sound tracks.

Line 6 Synth Harmony – If you loved those big synth leads from 70's era prog bands then you'll love this effect. There are two synth waves at work here. Your first two parameters allow you to choose a pitch interval of your original note played. Your Wave parameter works differently from what you'd expect with the other synth models. Here the Wave parameter controls the gain of the saw wave, while the square wave gain remains constant.

Stompbox Effect Models



Bass Overdrive: Based on* the Tech 21 Bass Sans Amp, with a pleasingly metallic distortion that is a favorite with the Post-Metal crowd.



Blue Comp: Based on* the Boss® CS-1 Compression Sustainer with the treble switch off.



Blue Comp Treb: Based on* the Boss® CS-1 Compression Sustainer with the treble switch on.



Bronze Master: Based on* the Maestro® Bass Brassmaster, considered by many to be the Holy Grail of bass distortion units.



Classic Distortion: Based on* the ProCo Rat, an angry and aggressive distortion box that put teeth into a new breed of metal in the late 70's.



Facial Fuzz: Based on* the Arbiter® Fuzz Face, best known for its famous association with guitar legend Jimi Hendrix.



Fuzz Pi: Based on the Electro-Harmonix® Big Muff Pi®, an American twist on the distortion/fuzz pedal.



Killer Z: Based on* Boss® Metal Zone, the industry standard distortion pedal for metal players since 1989.



Octave Fuzz: Based on the Tycobrahe Octavia, the classic fuzz+octave effect. One pioneering user of this type of effect was Jimi Hendrix.



Red Comp: Based on* the MXR® Dyna Comp, probably the most widely used stompbox compressor.



Screamer: Based on* an Ibanez® Tube Screamer®, the overdrive heard round the world.



Tube Drive: Based on* the Chandler Tube Driver®, delivering the sweet singing sustain craved by guitarists worldwide.

* All product names used hereon are trademarks of their respective owners, which are in no way associated or affiliated with Line 6. These trademarks of other manufacturers are used solely to identify the products of those manufacturers whose tones and sounds were studied during Line 6's sound model development. Arbiter is a registered trademark of Arbiter Group Plc. Big Muff Pi and Electro-Harmonix are registered trademarks of New Sensor Corp. Ibanez is a registered trademark of Hoshino, Inc. Maestro is a registered trademark of Gibson Guitar Corp. Tube Driver is a registered trademark of Butler Audio, Inc. Boss is a registered trademark of Roland Corp. Tube Screamer is a registered trademark of Hoshino Gakki Co Ltd.

Line 6 Auto Pan – Also known as a panner, this effect makes your sound go back and forth between the left and right channels. Sure to keep you up late at night.

Line 6 Auto Swell – This effect is an envelope generator, similar to the Boss SG-1 Slow Gear and other pedals. Each note or chord that you play ramps up. You can dial in the ramp time here to give you the kind of ‘bowed’ attacks that might otherwise require you to have your pinky rolling the volume knob on your guitar with every pick attack. Longer ramp times in combination with delay and reverb can keep you occupied for a pleasant hour or two, seeing what kind of chords you can come up with to blend into each other. You’ve got Ramp time to set over how long the swell takes to happen, plus Depth to determine how much the volume of your attacks is reduced.

Line 6 Bender Pitch Effect – This effect lets you control a change of pitch using the POD X3 Live pedal or an FBV pedal connected to a POD X3. You can set one amount of pitch shift for the heel position of the pedal, and another amount of pitch shift for the toe, then rock on the pedal to change pitch from one setting to another.

Line 6 Boost + EQ – The name pretty much says it all. This is a stompbox compressor that also provides you with some EQ controls so you can further shape the tone. Since this EQ is applied before the amp processing, it has a different tonal effect — especially if you’re using a strongly overdriven Amp Model — than it would if applied with the dedicated EQ block of POD X3 processing. Many players, in fact, rely on stompbox EQ like this to get their specially tailored sound from their amp.

Line 6 Female De-Esser – The Female De-esser should be your first choice when taming the Sss and Shh sounds of female vocalists, although as with all things musical, you may find many uses for it and may find that for some male vocalists it works better than the Male De-Esser. For general information on De-Essers, see the Set the De-Esser topic in the How To section. Technically-savvy users will want to know that this de-esser performs its gain reduction only on the selected frequency band, unlike the more typical insert-style De-Essing of the Male De-Esser.

Line 6 Male De-Esser – The Male De-esser should be your first choice for controlling the Sss and Shh sounds of male vocalists, although as with all things musical, you may find many uses for it and may find that for some female vocalists it works better than the Female De-Esser. For general information on De-Essers, see the Set the De-Esser topic in the How To section. Technically-savvy users will want to know that this is a standard insert-style de-esser, performing gain reduction on the full bandwidth audio signal.

Line 6 Sub Octaves – All bassists know that in just about every musical situation, lower can be better! But we couldn't just let bass players have all the fun, so we've included an Octave device. Your Sub Octave gets you down into booty-shaking territory mighty quick. Use it to create additional voices below what you're playing. Remember, lower can be better, especially when it makes the booty shake!

Line 6 Vetta Comp – This effect is taken from the Vetta II, Line 6's flagship guitar amplifier. A Line 6 original, Vetta Comp has a fixed ratio (2.35:1, in case you're asking) with the threshold (that would be your Sens knob) adjustable from -9dB to -56dB and up to 12dB of gain available at the Level knob. In other words, turn the Sens knob 'til you like the way your signal's compressed, then set the volume with Level.

Line 6 Vetta Juice – A Line 6 original originally created for our flagship Vetta II guitar amplifier, the 'Juice' in Vetta Juice comes from the 30dB of available gain in the Level knob. Holy smokes, this thing's packin' some heat! It's got a fixed threshold of -40dB with the Sens knob varying compression ratio from 1.5: 1 all the way up to 20:1 (which is a whole heck of a lot). This combination of design features gives you the option of cranking the level enough to get some serious gain boost, or setting the gain lower and dialing up a smooth, clean sustain. Take your pick, and dial away.

Delay Models



Analog Delay: Based on* the Boss® DM2 Analog Delay, treasured for the warm, distorted tones it produces.



Analog Delay Modulation: Here's a model based on* the Electro-Harmonix® Deluxe Memory Man, which is an analog delay with chorus.



Echo Platter: The Echo Platter model was inspired by the Binson EchoRec, a magnetic platter echo used by the likes of Pink Floyd.



Multi Head Delay: Based on* the Roland® RE-101 Space Echo, Roland's first venture into the world of effects processing.



Tape Echo: Based on* the solid state Maestro® EP-3 Echoplex, which used transistors instead of tubes for the sound electronics.



Tube Echo: The classic 1963 Maestro® EP-1 that this model is based on* was the first of a series of "Echoplex" designs.

Line 6 Bubble Eko – Bubble Eko has a Sample and Hold filter on the repeats. A Sample and Hold filter, if you haven't run across one before, takes a filter sweep (like the one on Sweep Echo), chops it up into little bits, and rearranges them semi-randomly, so that it sounds like sudden little bits of wah pedal randomly sprinkled about. Crazy, huh? Make sure and get busy with the sweep speed and sweep depth.

Line 6 Digital Delay – This model is a straight up digital delay with bass and treble tone controls. Nothing fancy here, just basic echo-cho-cho. After all, it's good to cleanse the palate every once in a while.

* All product names used hereon are trademarks of their respective owners, which are in no way associated or affiliated with Line 6. These trademarks of other manufacturers are used solely to identify the products of those manufacturers whose tones and sounds were studied during Line 6's sound model development. Electro-Harmonix is a registered trademark of New Sensor Corp. Maestro is a registered trademark of Gibson Guitar Corp. Boss is a registered trademark of Roland Corp.

Line 6 Lo Rez Delay – The first digital delay units were introduced in the early '80s. These pedals and rack boxes took advantage of emerging digital technology to provide guitarists with longer delay times. Unlike the 16 bit digital of today's CDs, and the even higher resolution provided by some audio gear (like the 32 Bit processing of your Vetta), these early digital units generally had only 8 bit resolution. Low bit resolution can create a unique sort of grunge and noise that is sometimes just the sound you're looking for, and that's why these old delays are still used to give a particular shape to the sounds that are run through them. Early model digital samplers are sometimes used in modern-day industrial and electronica to achieve these effects as well. Try this model on a low resolution setting to get that characteristic digital grunge.

The bits knob lets you adjust the delay anywhere from its normal sparklin', pristine 32 bit resolution down to as few as 6 truly nasty bits. Bear in mind that as you turn the knob clockwise, you're reducing the bit resolution, so maximum bit reduction is achieved when the knob is all the way up (think of it as a more control for how many less bits you want). Your direct sound, of course, stays full resolution. Tone control of the delay is also provided, via the appropriately labeled tone knob.

Line 6 Phaze Eko – This is a new-fangled delay dreamed up by the free thinking sound design crew here at Line 6. Starting with the basic tone of our EP-1 tape delay emulation, they've added something very much like a Uni-Vibe® to the delay repeats. The result is an echo unit that gives you unique new creative possibilities for adjusting the tone of your delays with a beautiful, burbling texture. If we do say so ourselves.

Line 6 Ping Pong Delay – The Ping Pong Delay is the one delay that can be run as a Post Delay Effect, but not as a stompbox (since this kind of delay requires a stereo output to do its stuff). It has two separate channels of delay, with the output of each channel flowing into the other, going back and forth like a game of ping pong.

The time knob sets the time for the left side delay line. The offset knob sets the time for the right side delay line, as a percentage of the left delay's time. And spread sets the stereo spread of the delays from mono to hard-panned left and right.

Sound too tricky? Just use the Time knob (or Tap Tempo Button, if you want to set that up) to set the longer delay time you hear, and then turn offset to adjust the shorter delay time. If you set offset straight up at 12 o'clock, your left and right delays are evenly spaced. Then, once

** All product names used hereon are trademarks of their respective owners, which are in no way associated or affiliated with Line 6. These trademarks of other manufacturers are used solely to identify the products of those manufacturers whose tones and sounds were studied during Line 6's sound model development. Uni-Vibe is a registered trademark of Dunlop Manufacturing, Inc.*

you've got your delay times set, use the spread knob to adjust where the delay repeats appear in the stereo field.

Line 6 Reverse Delay – Take a step back in time with your cool new reverse delay. Whatever you play in comes back out at you backwards, delayed by the time you set (up to 2 seconds). To use this little wonder most effectively, try playing a legato lick, ignoring the reverse playback as well as you can. Longer licks can translate into very cool reverse phrases. We've seen Tom Petty guitarist Mike Campbell taking advantage of the Reverse Delay on the Line 6 DM4 Delay Modeler stompbox to play a backwards guitar solo live—on a worldwide TV broadcast, no less.

When using Reverse, try setting the mix knob to full (100% wetness) so all you hear is the reversed sound—instant backwards guitar solo fun.

Line 6 Stereo Delay – Ever asked yourself, “How did The Edge (U2) get that groovy sound on Where the Streets Have No Name”? Stereo delays, my friend. It's the secret to many a U2 song, as well as the “Big L.A. Solo” sound of the late '80s. Set one side as a fast echo with many repeats, and the other as a slow delay with just a few repeats. Voila, you're famous!

Run this effect post in order to hear it in stereo, with one delay on the left, and another on the right. The time parameter sets the left delay's time, while offset sets the right delay time as a percentage of the left. So, if you set time to 500ms, and offset to 50%, your right delay time will be 50% of 500ms—in other words, 250ms. Ignoring the particular value of the left delay time, 50% just means that your right delay happens in half the time. So if you think of the left delay as a quarter note, the right delay is an eighth note. The second page of parameters for this model gives you independent left and right feedback controls, so for instance you can have your left delay feedback set low for a small number of repeats, while the right feedback is set high to give you a large number of repeats.

Line 6 Sweep Echo – This model is a Line 6 original. It first appeared on our DL4 Delay Modeler and has turned out to be a special favorite amongst the many DL4 users that we've spoken to.

The knobs adjust the speed and depth of the sweeping filter part of the effect. sweep speed sets how fast the filter sweeps, and sweep depth sets the range of frequencies that the filter affects, allowing you to create and explore your own shifting landscape of tonal possibilities. There's both subtle texture and serious weirdness to be found in this one. Try assigning one of the FBV pedals to control the Mix, and use a relatively short delay for some fun.

Line 6 Tape Eater – If you’ve ever had a cassette player eat a tape before you’ll know what we’re talking about. After fixing the tape (if you’re lucky!) and reinserting it in to the player it always had a warbled sound on that section of the tape. Now think of your guitar tone being recorded on that section of the tape! That’s the crazy effect we were after. Try this with a slow speed setting and a 100% wet mix.

Line 6 Warble-Matic – This effect is reminiscent of the Sweeper model, but when used subtly it can produce a nice mild phasey sound or with the depth maxed you can simulate the sound of an alien spacecraft landing in one of those old 50’s sci-fi movies!

Reverb Models

Line 6 Brite Room Reverb – A live, bright room to add life to any guitar track.

Line 6 Cavernous Reverb – Okay, so it does get bigger than Large Hall. Fire this verb up and get set for a long night of dandelion dreams.

Line 6 Chamber – Typical of a studio chamber, this reverb goes well with just about anything.

Line 6 Dark Hall – A large concert hall with many reflections. This one is all about size and is great for that huge backdrop of reverb that doesn't get in the way even when turned all the way up.

Line 6 King Spring – A Line 6 original, inspired by the Sealy Posturepedic. If three springs are cool, how about a whole mattress full of Slinkies? Richer, denser, wigglier. A good night sleep is guaranteed, or we'll give you your money back.

Line 6 Large Hall – A very large concert hall. It doesn't get much bigger than this.

Line 6 Large Plate – Well with Large Hall and Cavernous lying around, we just had to dish up a big ol' Plate of goodness. This one makes a great bed of reverb for playing over and washes up real good with soap and water.

Line 6 Lux Spring – The blackface Fender® Deluxe Reverb® amp had a two spring reverb tank, which this model is based on.*

A•30

Line 6 Medium Hall Reverb – A medium sized hall with heavy reflections, this one is meant to be heard.

Line 6 Rich Chamber – A rich chamber great for making that crunch tone even fatter.

Line 6 Slap Plate Reverb – This reverb dishes up the vibe of early rock and roll recordings, like Sam Phillips' great work at Sun Studios. Thank you very much.

** All product names used hereon are trademarks of their respective owners, which are in no way associated or affiliated with Line 6. These trademarks of other manufacturers are used solely to identify the products of those manufacturers whose tones and sounds were studied during Line 6's sound model development. Fender and Deluxe Reverb are registered trademarks of Fender Musical Instruments Corp.*

Line 6 Small Room – As its name implies, this reverb model will give you the kind of sound you’d get when recording an amp that’s mic’d up in a small room. Fortunately, unlike the small rooms that you might have handy at home, say, this room has well-tuned acoustics, no traffic noise coming from the nearby street, and you don’t have to worry about the upstairs neighbors yelling, “Turn it down!”—don’t you hate it when people ruin a good take like that?

Line 6 Standard Spring Reverb – One of the many things that people have loved about the blackface Fender® Twin Reverb® over the years has been its rich, dense reverb sound. The three-spring tank offered a more complex sound than Fender®’s earlier spring reverbs, and its what this model is based on.* Go find yourself a bevy of bikini-clad beauties, wax up your board, and dig in.

Line 6 Tiled Room – Think of this one as recording your guitar in the hall bathroom. All that porcelain has always made for great reverb, and lots of classic recordings were done by making the saxophone player stand in the ‘necessary’ and wail. Or at least that’s what they told them. Sax players can be so naive.

Line 6 Vintage Plate – A classic plate reverb that you won’t forget.

* All product names used hereon are trademarks of their respective owners, which are in no way associated or affiliated with Line 6. These trademarks of other manufacturers are used solely to identify the products of those manufacturers whose tones and sounds were studied during Line 6’s sound model development. Fender and Twin Reverb are registered trademarks of Fender Musical Instruments Corp.

Wah Models

Chrome – Based on* a Vox® V847. This pedal was a reissue of the original 1967 Vox® V846 wah pedal, which was the successor to the original Clyde McCoy wah (Clyde McCoy was a trumpet player who had asked Vox® to make an effect that would make a keyboard sound like you were using a plunger mute on it. Guitar players everywhere thank him).

Chrome Custom – Based on* a modded Vox® V847 that belongs to one of the Line 6 crew. This pedal had the gain staging on the first transistor stage tweaked, a aftermarket Fasel inductor, the Q widened at the top end, and the 100k pot replaced with a 470k pot to better match the original V846 specs.

Colorful – This model is based on* the wah part of a vintage Colorsound® Wah-Fuzz. The Colorsound is different from the other wah pedals here in that it was an inductor-less design. For you non-electronics minded folks, this basically means that it used a different type of circuit to get its frequency resonance and would saturate (distort) in a different manner than the inductor-based designs.

Conductor – Based on* the Maestro® Boomerang - According to the original Maestro advertising material , this was not a ‘wah-wah’ pedal, but a ‘wow-wow’ pedal. Po-tay-to - Po-tah-to. In 1968 or so, Maestro® went to Richard Mintz of All Test Devices, who had first become known for his design of a sustainer for Leslie West, and hired him to redesign most of their effects units. This pedal was Curtis Mayfield’s choice for wah, so it’s perfect for R’n’B ‘wacka-wacka’ retro madness.

Fassel – Based on* a Cry Baby® Super made by Jen Electronics. Jen Electronics in Italy manufactured wah pedals for many companies, including Vox®, Thomas Organ, Arbiter®, and others. This particular pedal has the highly desirable mojo of the Fasel (an Italian manufacturer of electronic components) inductor. Some have credited the unique saturation characteristics of the Fasel inductor to the fact that it was a really cheaply made component. File this one under ‘Irony’.

* All product names used hereon are trademarks of their respective owners, which are in no way associated or affiliated with Line 6. These trademarks of other manufacturers are used solely to identify the products of those manufacturers whose tones and sounds were studied during Line 6’s sound model development. Arbiter is a registered trademark of Arbiter Group Plc. Colorsound is a registered trademark of Sola Sound Ltd. Cry Baby is a registered trademark of Dunlop Manufacturing, Inc. Maestro is a registered trademark of Gibson Guitar Corp. Vox is a registered trademark of Vox R&D Ltd.

Throaty – Based on* the RMC Real McCoy 1. For many guitarists, the original Vox® Clyde McCoy signature (or even rarer, picture) pedal is the ‘holy grail’ of wahs. Geoffrey Teese of RMC did a lot of research, even tracking down a supply of the original ‘stack of dimes’ inductors and having pots that duplicate the taper characteristics of the original ICAR parts to produce a clone of these highly sought-after wahs.

Weeper – Modeled after* an Arbiter® Cry Baby®, this is yet another variation on the original Vox® wah design. The biggest variation between many of these wah pedals is the inductor and the tolerances of the capacitors and resistors that make up the filter circuit. Just like vintage guitar amps, two of them made on the same day, by the same person, from the same parts bin might sound totally different. As always, we went for the best examples we could find.

Line 6 Vetta Wah – This is the original PODxt/Vetta Wah Model, from back in the dark ages when a PODxt and Vetta had only one Wah model.

* All product names used hereon are trademarks of their respective owners, which are in no way associated or affiliated with Line 6. These trademarks of other manufacturers are used solely to identify the products of those manufacturers whose tones and sounds were studied during Line 6’s sound model development. Arbiter is a registered trademark of Arbiter Group Plc. Cry Baby is a registered trademark of Dunlop Manufacturing, Inc. Vox is a registered trademark of Vox R&D Ltd.

Line 6 Compressor – Based on* the Teletronics LA-2A®. The Compressor effect is just the thing when you want to smooth out your levels the way that you would typically do in a recording studio. The thresh (Threshold) knob determines how aggressive you want the Compressor to be in smoothing things out. More negative numbers make the Compressor more active in taming your levels, so -32dB is a more aggressive setting than -16dB, say. The Gain control controls (what else?) gain, so that even when you're really squashing your signal with an aggressive threshold setting, you'll be able to get good volume levels out of your POD X3 or POD X3 Live.

Line 6 Four Band Parametric EQ – The EQ provides four bands of tone control, with frequency select and gain boost/cut for each band.

Line 6 Noise Gate – The Gate effect helps eliminate unwanted noise when you're not playing, and can be especially valuable when using high gain sounds. Like a security gate, it's supposed to quickly open to pass the things that you want, and then swing closed to keep out the things that you don't want. Turn the thresh all the way down to minimum to disable the Gate (thresh's value will then be off, as shown above). The thresh knob determines how loud your playing has to be to open the gate. More negative numbers (where the knob is near its fully-counterclockwise setting) mean that the gate will open and allow sound through even when you are playing quietly, and less negative numbers (where the knob is near its fully-clockwise setting) mean that the gate will only allow sound to pass when you are playing pretty hard. The decay knob determines how fast the gate will swing closed. Like a gate in the real world, a fast decay means the gate might catch your trailing foot as you pass through—in this case, that means the gate will chop off the decay of your notes. And a slow decay means that as the gate swings slowly closed behind you, someone might have time to slip through behind you—in this case, that would be the unwanted noise that you hear as your notes decay. You'll have to experiment with the decay to get just the right happy medium for your particular guitar, playing style, and sound settings.

* All product names used hereon are trademarks of their respective owners, which are in no way associated or affiliated with Line 6. These trademarks of other manufacturers are used solely to identify the products of those manufacturers whose tones and sounds were studied during Line 6's sound model development. LA-2A is a registered trademark of Universal Audio, Inc.

APPENDIX B: SIGNAL FLOW

POD X3 Live

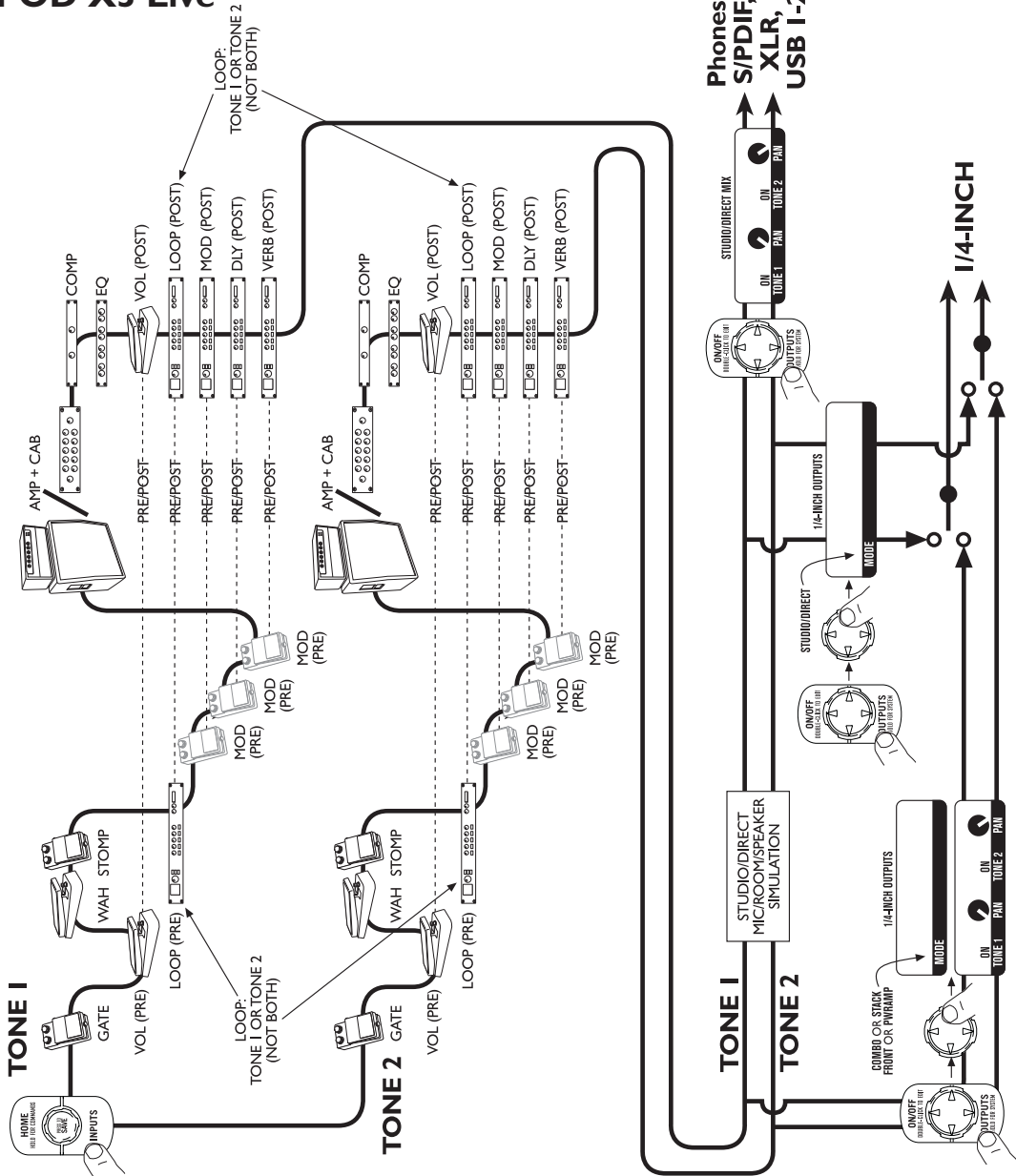

POD X3

