

ECOs INCLUDED ON THIS SCHEMATIC/PCB REVISION		
ECO NO.	DATE	DESCRIPTION
222708	8/15/02	Change Rev C to Rev D
0223404	8/22/02	Change Rev D to Rev E

D

C

B

A

D

C

B

A

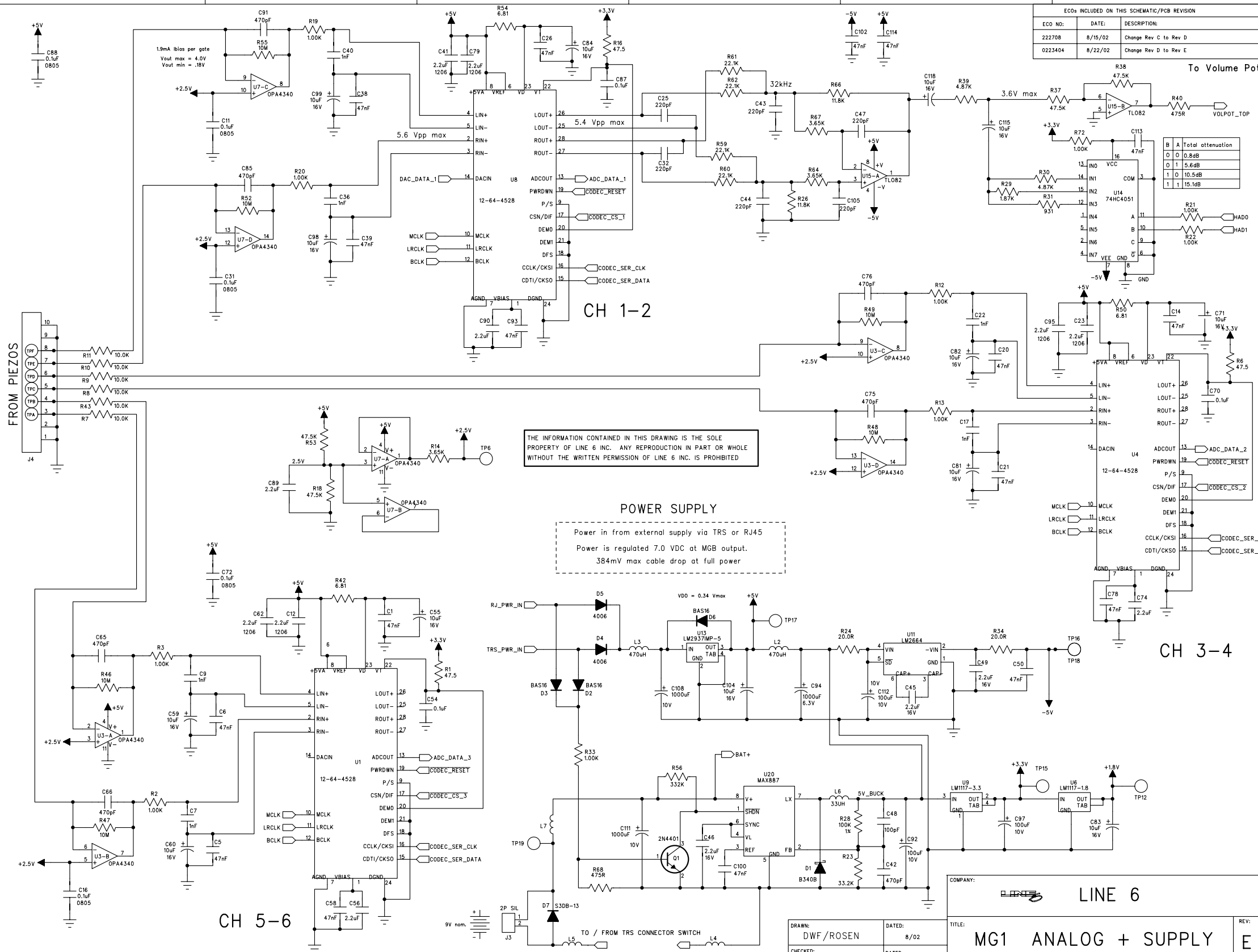

THE INFORMATION CONTAINED IN THIS DRAWING IS THE SOLE PROPERTY OF LINE 6 INC. ANY REPRODUCTION IN PART OR WHOLE WITHOUT THE WRITTEN PERMISSION OF LINE 6 INC. IS PROHIBITED

POWER SUPPLY
 Power in from external supply via TRS or RJ45
 Power is regulated 7.0 VDC at MGB output.
 384mV max cable drop at full power

COMPANY: **LINE 6**

TITLE: **MG1 ANALOG + SUPPLY**

SCALE: 1:1 SIZE: C PART NUMBER: 35-00-0137 SHEET: 1 OF 2

REV: **E**

DRAWN: DWF/ROSEN DATED: 8/02
 CHECKED: XX DATED: X-XX-XX

ECO's INCLUDED ON THIS SCHEMATIC/PCB REVISION		
ECO No:	DATE:	DESCRIPTION:
0223404	8/22/02	Changes Rev D to Rev E

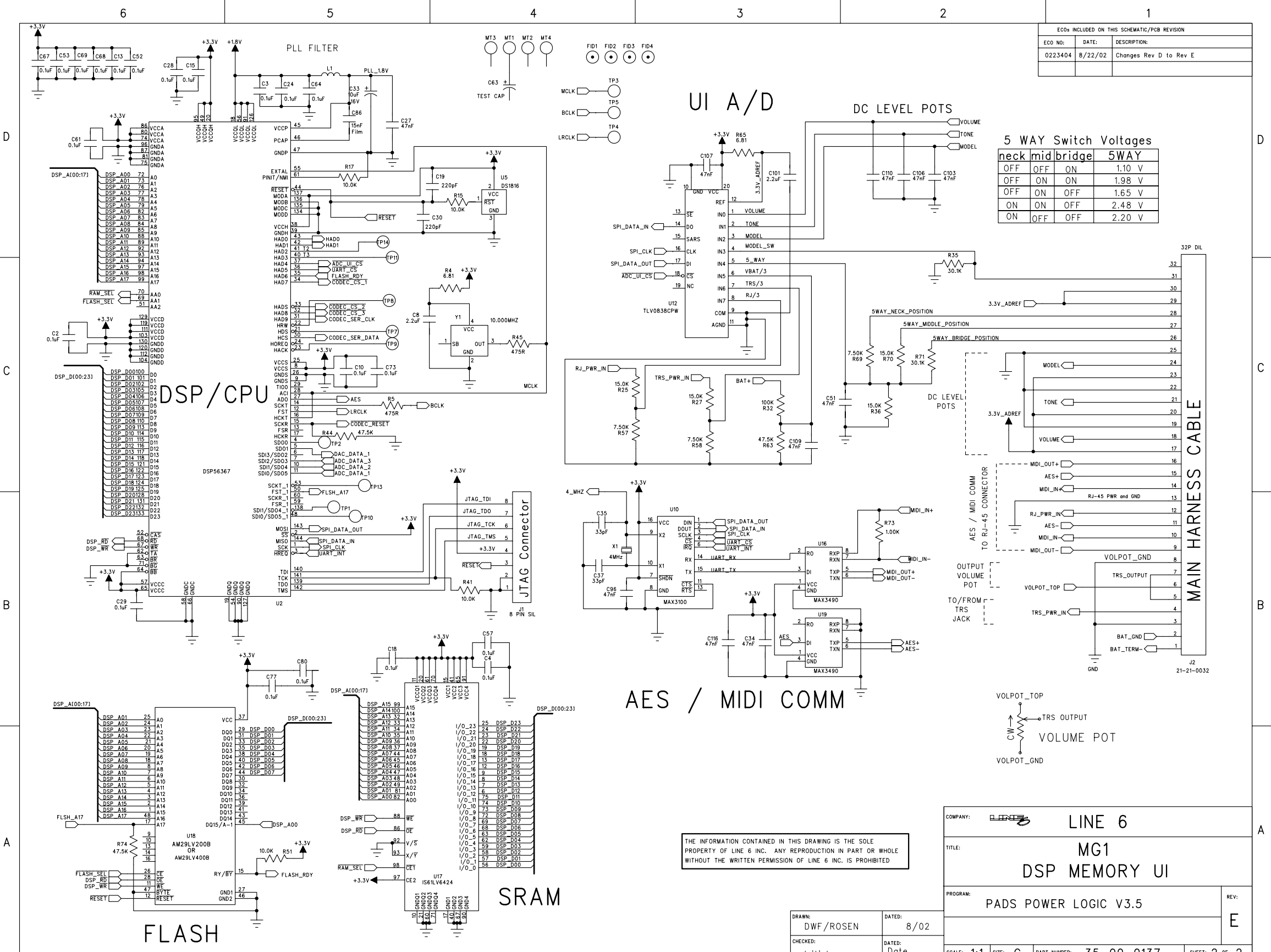

5 WAY Switch Voltages

neck	mid	bridge	5WAY
OFF	OFF	ON	1.10 V
OFF	ON	ON	1.98 V
OFF	ON	OFF	1.65 V
ON	ON	OFF	2.48 V
ON	OFF	OFF	2.20 V

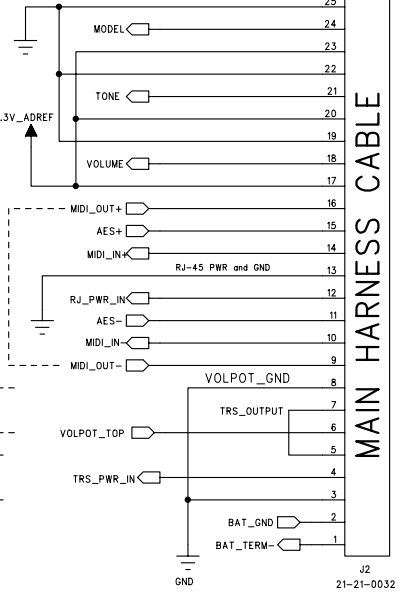

THE INFORMATION CONTAINED IN THIS DRAWING IS THE SOLE PROPERTY OF LINE 6 INC. ANY REPRODUCTION IN PART OR WHOLE WITHOUT THE WRITTEN PERMISSION OF LINE 6 INC. IS PROHIBITED

COMPANY:	LINE 6	
TITLE:	MG1 DSP MEMORY UI	
PROGRAM:	PADS POWER LOGIC V3.5	
REVISION:	E	
DRAWN:	DWF/ROSEN	DATED: 8/02
CHECKED:	Initials	DATED: Date
SCALE:	1:1	SHEET: 2 OF 2
SIZE:	C	PART NUMBER: 35-00-0137

6

5

4

3

2

1

ECOs INCLUDED ON THIS SCHEMATIC/PCB REVISION		
ECO NO:	DATE:	DESCRIPTION:
223103	8/20/02	REV A RELEASE TO PRODUCTION

FROM GUITAR

1/4" OUT SHOWN ACTIVE

1/4" OUT
+8dBV max output

Balanced Output
+19dBu max output

1/4" ACTIVE

Power On Mute Circuit

PHANTOM POWER ACTIVE

XLR ACTIVE

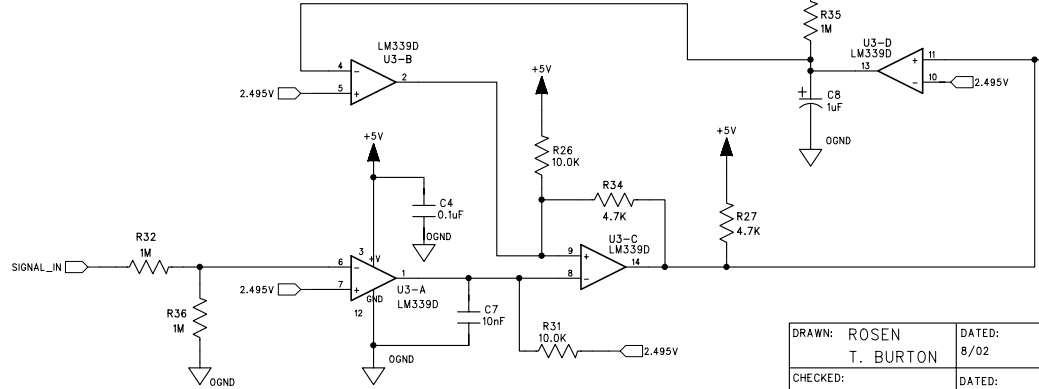
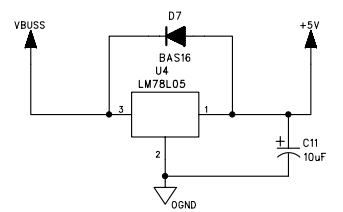
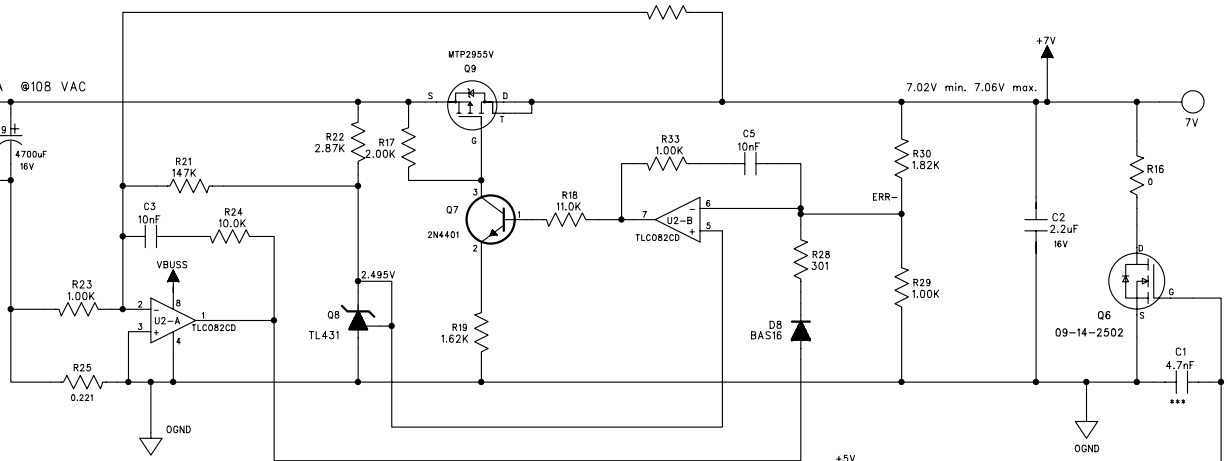
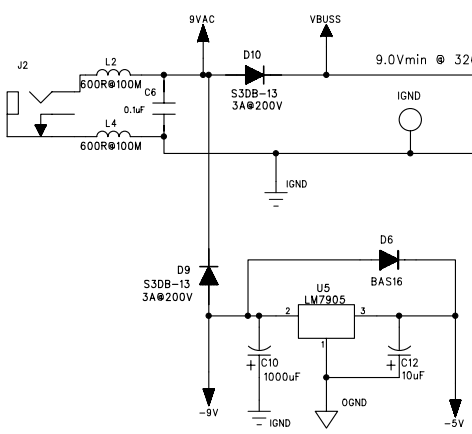

COMPANY: LINE 6	
TITLE: MGB	
PROGRAM: PADS POWER LOGIC V4.0	REV: A
FILENAME: .../Schematic/MGB/Rev A/MGB REV A.sch	
DRAWN: ROSEN	DATED: 8/02
CHECKED: XX	DATED: X-XX-XX
SCALE: 1:1	SIZE: C
PART NUMBER: 35-00-0138	SHEET: 1 OF 1

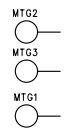

D

C

B

A

D

C

B

A

6

5

4

3

2

1

ECOs INCLUDED ON THIS SCHEMATIC/PCB REVISION		
ECO NO:	DATE:	DESCRIPTION:

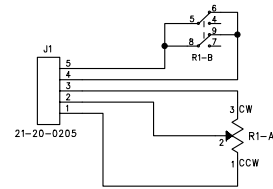

MODEL POT BREAKAWAY

COMPANY:		LINE 6	
TITLE:		MODEL	
PROGRAM:		PADS POWER LOGIC V4.0	REV: A
FILENAME:		MODEL REV A	
DRAWN:	ROSEN	DATED:	9/02
CHECKED:	XX	DATED:	X-XX-XX
SCALE:	1:1	SIZE:	C
PART NUMBER:	35-00-0159	SHEET:	1 OF 1

D

D

C

C

B

B

A

A

6

5

4

3

2

1

REVISION RECORD			
LTR	ECO NO:	APPROVED:	DATE:
B	ECR Number: 0233606	MH	11/27/02
C	0235302/0300301/0300302	MH	01/03/03

GUITAR OUTPUT

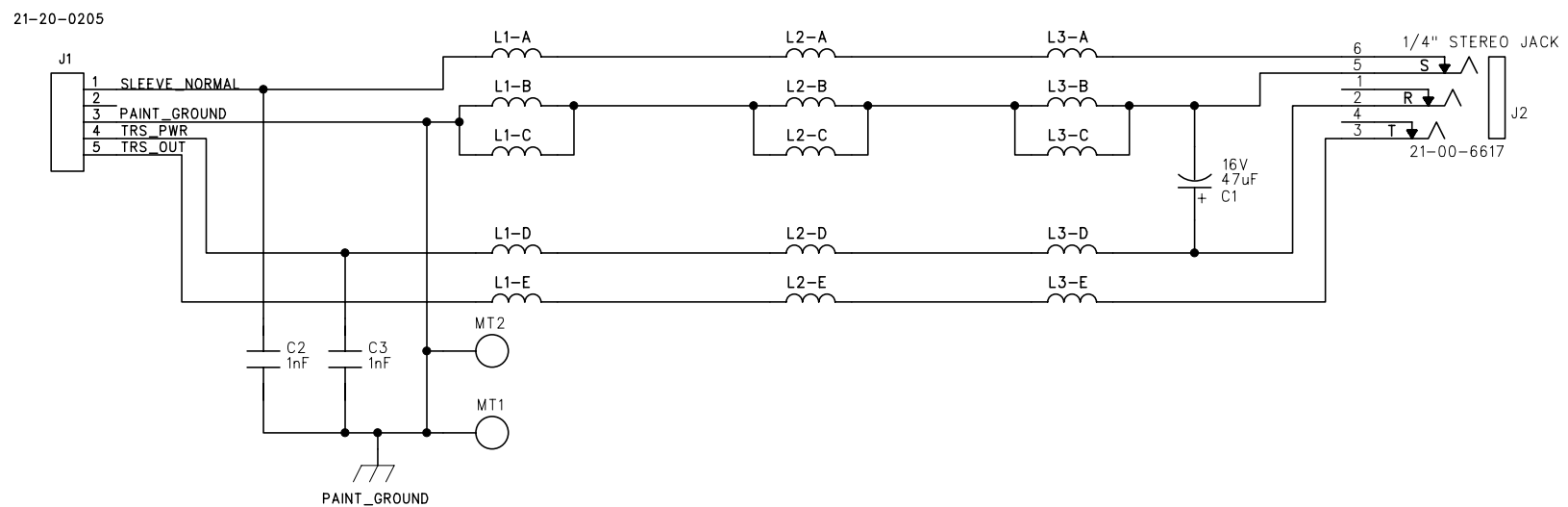

CHGND IS CAVITY PAINT CONNECTION

THE INFORMATION CONTAINED IN THIS DRAWING IS THE SOLE PROPERTY OF LINE 6 INC. ANY REPRODUCTION IN PART OR WHOLE WITHOUT THE WRITTEN PERMISSION OF LINE 6 INC. IS PROHIBITED

COMPANY:  LINE 6	
TITLE: MG-1 OUTPUT	
PROGRAM: PADS POWER LOGIC V5.0	REV: C
FILENAME: Schematics/MG-1 OUTPUT REV C.sch	
SCALE: 1:1 SIZE: B	PART NUMBER: 35-00-0161 SHEET: 1 OF 1

DRAWN: ROSEN	DATED: 12/19/02
CHECKED: Initials	DATED: Date

D

D

C

C

B

B

A

A

6

5

4

3

2

1

ECOs INCLUDED ON THIS SCHEMATIC/PCB REVISION		
ECO NO:	DATE:	DESCRIPTION:

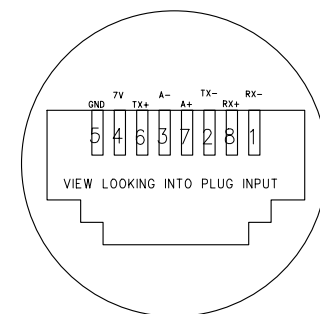
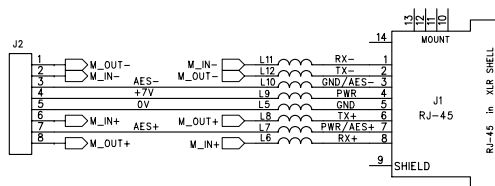

RJ-45 PCB

COMPANY:		LINE 6	
TITLE:		RJ-45 PCB	
PROGRAM:		PADS POWER LOGIC V4.0	REV: A
FILENAME:		RJ45 A	
DRAWN: ROSEN	DATED: 9/02	SCALE: 1:1	SIZE: C
CHECKED: XX	DATED: X-XX-XX	PART NUMBER: 35-00-0160	SHEET: 1 OF 1

6

5

4

3

2

1

ECOs INCLUDED ON THIS SCHEMATIC/PCB REVISION		
ECO NO:	DATE:	DESCRIPTION:

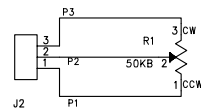

TONE POT BREAKAWAY

COMPANY: LINE 6

TITLE: TONE

PROGRAM: PADS POWER LOGIC V4.0

FILENAME: TONE A

REV: A

DRAWN: ROSEN

DATED: 9/02

CHECKED: XX

DATED: X-XX-XX

SCALE: 1:1 SIZE: C PART NUMBER: 35-00-0158 SHEET: 1 OF 1

6

5

4

3

2

1

ECOs INCLUDED ON THIS SCHEMATIC/PCB REVISION		
ECO NO:	DATE:	DESCRIPTION:

D

D

C

C

B

B

A

A

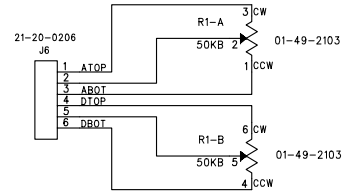

ANALOG
 VOLUME POT BREAKAWAY
 DIGITAL

COMPANY:		LINE 6	
TITLE:		VOLUME	
PROGRAM:		PADS POWER LOGIC V4.0	REV: A
FILENAME:		VOLUME A	
DRAWN: ROSEN	DATED: 9/02	SCALE: 1:1	SIZE: C
CHECKED: XX	DATED: X-XX-XX	PART NUMBER: 35-00-0157	SHEET: 1 OF 1

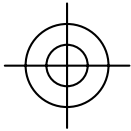
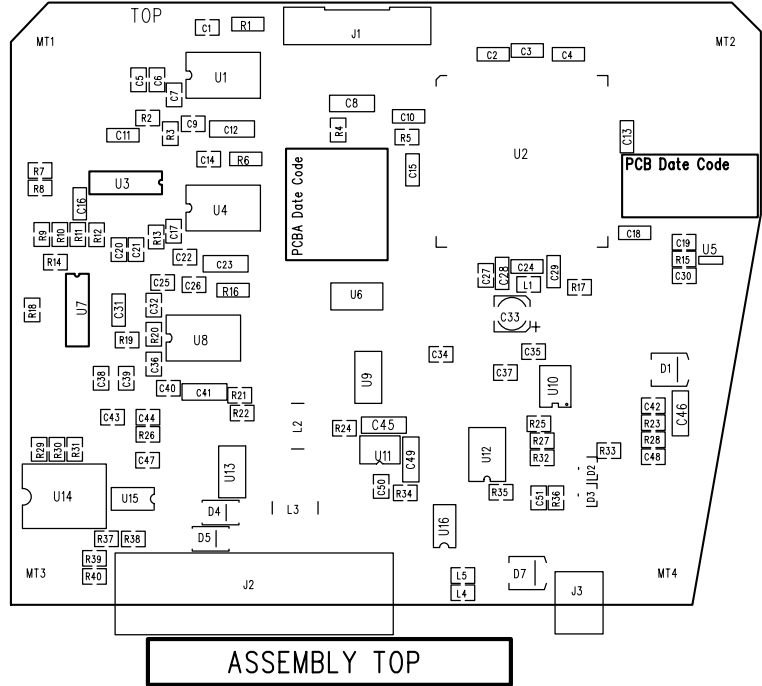
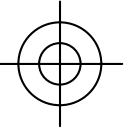
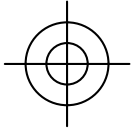

DATE CODE REQUIREMENTS

- 1) Silkscreen date code for bare PCB fabrication in area marked on drawing.
- 2) Place date code stamp or sticker for finished PCBA in area marked on drawing.

THE INFORMATION CONTAINED IN THIS DRAWING IS THE SOLE PROPERTY OF LINE 6 INC. ANY REPRODUCTION IN PART OR WHOLE WITHOUT THE WRITTEN PERMISSION OF LINE 6 INC. IS PROHIBITED

 LINE 6 Inc.		
PROGRAM: PADS POWER PCB 4.0		
FILE: MG1\Electricals\PCB\Main\Rev E\MG-1 Main Rev E.pcb		
SCALE: 1:1	REV: E	DATE: AUGUST 22, 2002
TITLE: MG1 Main PCB PART # 35-00-0137		

ASSEMBLY TOP

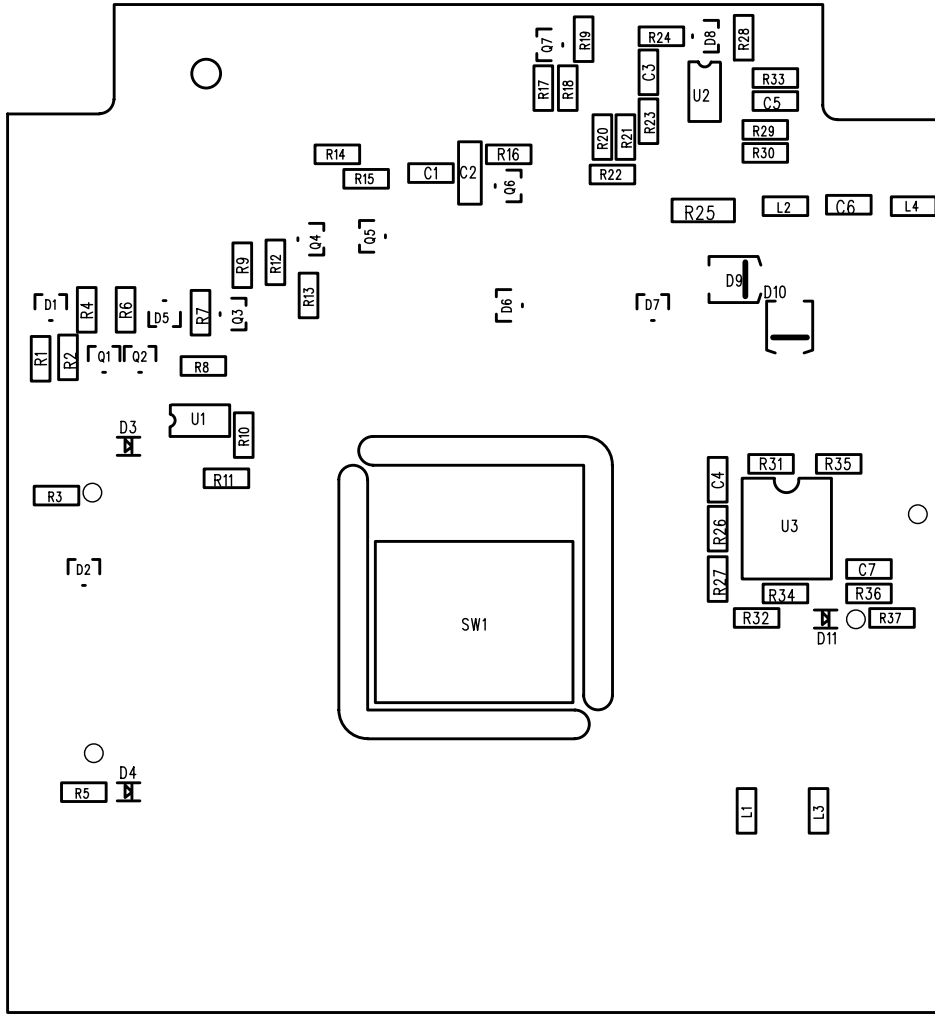

COMPANY:		LINE 6 INC.	
PROGRAM: PADS POWER PCB 4.0			
FILE: ..\MG1 MGB Rev A.pcb			
SCALE: NONE	REV: A	DATE: AUGUST 19, 2002	
TITLE: MG1 MGB		LINE6 PART NO: 35-00-0138	

THE INFORMATION CONTAINED IN THIS DRAWING IS THE SOLE PROPERTY OF LINE 6 INC. ANY REPRODUCTION IN PART OR WHOLE WITHOUT THE WRITTEN PERMISSION OF LINE 6 INC. IS PROHIBITED

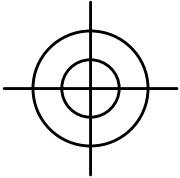
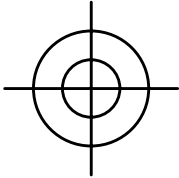

ASSEMBLY BOTTOM

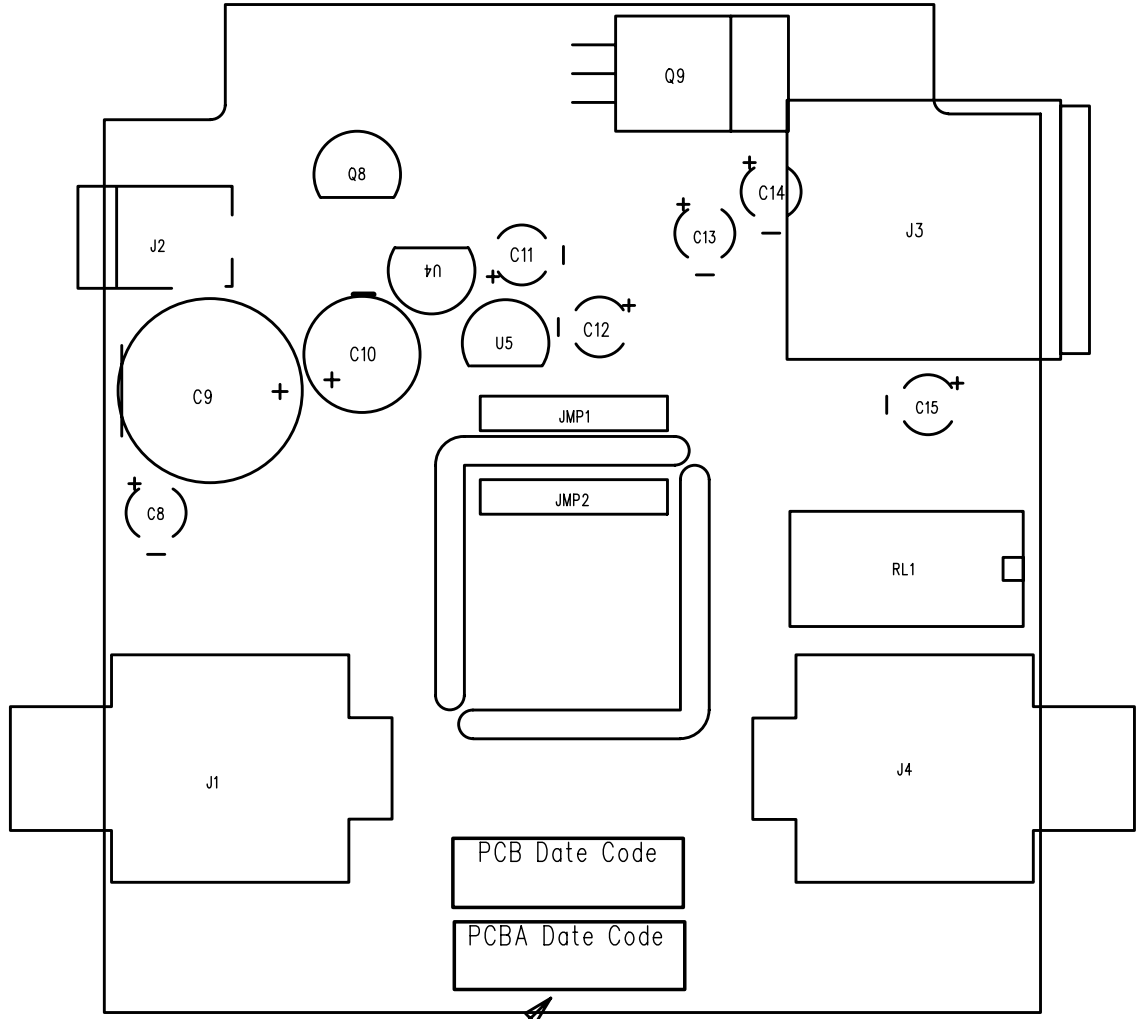

PCBA DATE CODE HERE

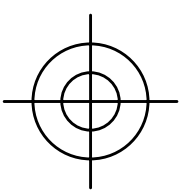

- DATE CODE REQUIREMENTS**
- 1) Silkscreen date code for bare PCB fabrication in area marked on drawing.
 - 2) Place date code stamp or sticker for finished PCBA in area marked on drawing.

COMPANY: LINE 6 INC.	
PROGRAM: PADS POWER PCB 4.0	
FILE: ../MGT MGB Rev A.pcb	
DATE: AUGUST 19, 2002	SCALE: NONE
LINE & PART NO: 32-00-0138	TITLE: MGT MGB
REV: A	

THE INFORMATION CONTAINED IN THIS DRAWING IS THE SOLE PROPERTY OF
 LINE 6 INC. ANY REPRODUCTION IN PART OR WHOLE WITHOUT
 THE WRITTEN PERMISSION OF LINE 6 INC. IS PROHIBITED

LINE 6
Variax Parts List

99-080-0105 -BLACK
99-082-0105 -RED
99-083-0105 -SUNBURST

Seq	Component-Item	Component-Description	Qty-Per-Parent
=====			
Parent Item: 99-080/082/083-0105 VARIAX BLACK/RED/SUNBURST R/H UNITED STATES			
1	10 11-32-0000	XFMR PX2 120VAC/60Hz 9VAC/2A UL 2464 VW-1 6FT. BLK US	1.000000
1	20 21-34-0115	CAB 1/4" TRS 15' GOLD-PLT PLANET-WAVES	1.000000
1	30 40-00-0007	MANUAL USERS MG1	1.000000
1	35 40-00-1031	MANUAL ADDENDUM VARIAX	1.000000
1	40 40-03-2000	CARD REGISTRATION UNIVERSAL	1.000000
1	50 40-10-0028	CARTON GIFT w/ARTWORK MG1	1.000000
1	60 40-10-0029	INSERT CARTON GIFT MG1	1.000000
1	70 40-10-0047	FOAM HEADSTOCK MG1	2.000000
1	80 40-10-0053	INSERT CARTON BOTTOM MG1	1.000000
1	90 40-20-0000	BAG GIG GUITAR BLACK MG1	1.000000
1	100 40-20-0011	BAG PLASTIC 10 x 16 2 mil	1.000000
1	130 40-25-0101	LABEL BAR CODE S/N 2-PNL LTX 16 1125502	1.000000
1	140 50-00-0148	ASSY SELECTOR A/B SWITCH PHANTOM POWER SUPPLY MGB	1.000000
2	7 24-01-0000	SWITCH LATCHING PUSH BUTTON DPDT 6-PIN DIL TH	1.000000
2	10 30-00-1632	SCREW 6-32 x 3/8IN PPB TAP-TITE STL	10.000000

Ref: 5 INPUT ENDCAP 5 OUTPUT ENDCAP

LINE 6
Variax Parts List

2	20 30-00-4250	SCREW SHEET METAL SELF-TAP #4 x .250IN PPB	10 EA	.0	A	Y	N	2.000000
2	30 30-03-0009	Ref: XLR JACK WASHER .623" x .475"x .018" NICKEL	10 EA	.0	A		N	1.000000
2	40 30-03-0014	Ref: FOOT SWITCH WASHER NO.6 FINISHING	10 EA	.0	A	Y	N	3.000000
2	50 30-06-0008	Ref: LIGHT PIPES NUT 4mm PUSH NUT STEEL ZINC	10 EA	.0	A	Y	N	3.000000
2	60 30-15-0004	Ref: LIGHT PIPES SPACER .13THKx.630D NYLON	10 EA	.0	A	Y	N	2.000000
2	70 30-27-0038	Ref: FOOT SWITCH PCBA LT PIPE DIVERG .55IN X .16DIA LEXAN 141 HIGHLY POLISHED	10 EA	.0	A	Y	N	3.000000
2	80 30-27-0046	ENDCAP OUTPUT MG-1 HDPE BLACK	10 EA	.0	A	Y	N	1.000000
2	90 30-27-0047	ENDCAP INPUT MG-1 HDPE BLACK	10 EA	.0	A	Y	N	1.000000
2	100 30-51-0114	EXTRN BRK OUT BOX 5.02x3.15 AL ALY CLR ANDZ	10 EA	.0	A	Y	N	1.000000
2	105 30-63-0010	FOAM w/ADHSV 26.5x 1/4x 1/16IN VOLARAPOLELEFIN	10 EA	.0	A	Y	N	.100000
2	110 30-75-0014	PAD RUBBER w/ADHESIVE SERRATED 3.80 x 2.50 x 3/15" BLACK	10 EA	.0	A	Y	N	1.000000
2	115 30-75-0015	SPACER 3.70 x 2.50 x .03IN PORON	10 EA	.0	A	Y	N	1.000000
2	120 50-00-0138	PCBA MGB MG-1	10 EA	.0	A	Y	N	1.000000
3	10 01-00-0000	RES 0R 5% 0805	0 EA	.0	A	Y	N	1.000000
3	20 01-00-0105	Ref: R16 RES 1M 5% 0805	0 EA	.0	A	Y	N	3.000000
3	30 01-00-0472	Ref: R32,R35-36 RES 4.7K 5% 0805	0 EA	.0	A	Y	N	2.000000
		Ref: R27,R34						

LINE 6
Variax Parts List

3	40 01-00-0473	RES 47K 5% 0805	0 EA	.0	A	Y	N	2.000000
		Ref: R14-15						
3	50 01-12-0102	RES CARBON FILM 1K 1/4W 5% TH	0 EA	.0	A	Y	N	1.000000
3	60 01-12-0105	RES CARBON FILM 1M 1/4W 5% TH	0 EA	.0	A	Y	N	1.000000
3	70 01-24-1001	RES 1.00K 1% 0805	0 EA	.0	A	Y	N	8.000000
		Ref: R3,R5,R12-13,R23,R29,R33,R37						
3	80 01-24-1002	RES 10.0K 1% 0805	0 EA	.0	A	Y	N	8.000000
		Ref: R2,R8-11,R24,R26,R31						
3	90 01-24-1003	RES 100K 1% 0805	0 EA	.0	A	Y	N	1.000000
		Ref: R7						
3	100 01-24-1102	RES 11.0K 1% 0805	0 EA	.0	A	Y	N	1.000000
		Ref: R18						
3	110 01-24-1473	RES 147K 1% 0805	0 EA	.0	A	Y	N	1.000000
		Ref: R21						
3	120 01-24-1621	RES 1.62K 1% 0805	0 EA	.0	A	Y	N	1.000000
		Ref: R19						
3	130 01-24-1821	RES 1.82K 1% 0805	0 EA	.0	A	Y	N	1.000000
		Ref: R30						
3	140 01-24-2001	RES 2.00K 1% 0805	0 EA	.0	A	Y	N	1.000000
		Ref: R17						
3	150 01-24-2002	RES 20.0K 1% 0805	0 EA	.0	A	Y	N	3.000000
		Ref: R1,R4,R6						
3	160 01-24-2871	RES 2.87K 1% 0805	0 EA	.0	A	Y	N	1.000000
		Ref: R22						
3	170 01-24-3010	RES 301R 1% 0805	0 EA	.0	A	Y	N	1.000000
		Ref: R28						
3	180 01-24-9312	RES 93.1K 1% 0805	0 EA	.0	A	Y	N	1.000000
		Ref: R20						

LINE 6
Variax Parts List

3	190 01-28-R221	RES 0.221R 1% 1206	0 EA	.0	A	Y	N	1.000000
3	200 03-12-0108 10/16/5	Ref: R25 CAP ELEC 1000uF 16V 20% RADIAL	0 EA	.0	A	Y	N	1.000000
3	210 03-12-0478 RADIAL 16/25/7.5	Ref: C10 CAP ELEC 4700uF 16V 20%	0 EA	.0	A	Y	N	1.000000
3	220 03-18-0105 5/11/5	Ref: C9 CAP ELEC 1uF 50V 20% RADIAL	0 EA	.0	A	Y	N	1.000000
3	230 03-18-0106 5/11/5	Ref: C8 CAP ELEC 10uF 50V 20% RADIAL	0 EA	.0	A	Y	N	6.000000
3	250 03-46-0225	Ref: C11-15,+1 rework CAP X7R 2.2uF 16V 20% 1206	0 EA	.0	A	Y	N	1.000000
3	260 03-52-0103	Ref: C2 CAP X7R 10nF 50V 20% 0805	0 EA	.0	A	Y	N	1.000000
3	270 03-52-0104	Ref: C3 CAP X7R 0.1uF 50V 20% 0805	0 EA	.0	A	Y	N	2.000000
3	280 03-52-1103	Ref: C4,C6 CAP X7R 10nF 100V 10% 0805	0 EA	.0	A	Y	N	2.000000
3	290 06-28-8451 SOT-23 SM	Ref: C5,C7 DIODE ZENER 5.1V 5% 350mW BZX84C5V1	0 EA	.0	A		N	1.000000
3	300 06-28-8468 SOT-23 SM	Ref: D5 DIODE ZENER 6.8V 5% 350mW BZX84C6V8	0 EA	.0	A	Y	N	1.000000
3	310 06-32-0313 SM S3DB-13	Ref: D1 DIODE RECTIFIER 200V 3A SMB	0 EA	.0	A	Y	N	2.000000
3	320 06-34-0016 6nS SOT-23 SM	Ref: D9-10 DIODE SWITCHING 75V 200mA BAS16LT1	0 EA	.0	A	Y	N	4.000000
3	330 09-06-2955 230mR	Ref: D2,D6-8 TRANS POWER-MOSFET P-CHAN 60V MTP2955V TO-220 TH	0 EA	.0	A	Y	N	1.000000
3	340 09-10-4401 SOT-23 SM	Ref: Q9 TRANS NPN SMALL-SIGNAL MBT4401 Ref: Q1-3,Q7	0 EA	.0	A	Y	N	4.000000

LINE 6
Variax Parts List

3	350	09-14-2502	TRANS MOSFET N-CHAN 20V 3.77A .045R SOT-23 SM VISHAY	0	EA	.0	A	N	1.000000	
			Ref: Q6							
3	360	09-16-4392	TRANS JFET N-CH 30V 60R SOT-23 SM MMBF4392	0	EA	.0	A	Y	N	2.000000
			Ref: Q4-5							
3	370	11-10-2012	FERRITE BEAD 600R@100MHZ 300mA 0805 SM	0	EA	.0	A	Y	N	4.000000
			Ref: L1-4							
3	380	12-00-0431	IC REG ADJ PREC SHUNT <36V TO-226AA(LP) TH TL431	0	EA	.0	A	Y	N	1.000000
			Ref: Q8							
3	390	12-00-7805	IC REG +5V T0-92 TH LM78L05	0	EA	.0	A	Y	N	1.000000
			Ref: U4							
3	400	12-00-7905	IC REG -5V 79L05 100mA TH T0-92	0	EA	.0	A	Y	N	1.000000
			Ref: U1-2							
3	420	12-58-0339	IC COMPARATOR QUAD LM339D SM	0	EA	.0	A	Y	N	1.000000
			Ref: U3							
3	430	18-20-0002	LED RED SUPER SML-LX0805SRC-TR 0805 SM	0	EA	.0	A	Y	N	1.000000
			Ref: D11							
3	440	18-24-0003	LED GREEN SUPER SML-LX0805SGC-TR 0805 SM	0	EA	.0	A	Y	N	2.000000
			Ref: D3-4							
3	450	21-00-0015	JACK BARREL PCB MT 2.5mm DC PWR 3 PIN TH SJS-014A	0	EA	.0	A		N	1.000000
			Ref: J2							
3	460	21-00-6617	JACK 1/4" TRS 6-PIN PCB MT HORIZ TH W/CHROME HRDWARE	0	EA	.0	A	Y	N	2.000000
			Ref: J1,J4							
3	470	21-08-0013	JACK XLR MALE PCB MNT RT ANG TH NEUTRIK-NC3MAH	0	EA	.0	A	Y	N	1.000000
			Ref: J3							
3	480	21-30-0011	CAB RIBBON SIL 6-PIN 2.54mm x 40mm 26 AWG S/T	0	EA	.0	A	Y	N	1.000000
			Ref: JMP1 to JMP2							
3	490	24-01-0000	SWITCH LATCHING PUSH BUTTON DPDT 6-PIN DIL TH						Ref: SW1	1.000000

LINE 6
Variax Parts List

3	500 24-15-0002	RELAY DPDT 2A 12V 288 OHM COIL DIP 8P TH G5V-2-DC12	0 EA	.0	A	Y	N	1.000000
		Ref: RL1						
3	510 30-06-0623	NUT HEX 6-32 w/CPTV STAR-WASHR	0 EA	.0	A	Y	N	1.000000
		Ref: Q9						
3	520 30-12-8418	STANDOFF HEX .250 6-32 M-F 1IN AL	0 EA	.0	A	Y	N	1.000000
		Ref: Q9						
2	130 50-00-0193	ASSY COVER PLATE w/ARTWORK MGB	10 EA	.0	A	Y	N	1.000000
3	10 30-51-0101	COVER PL SW BOX 3.1X2.27 EG STL	10 EA	.0	A	Y	N	1.000000
1	150 50-00-0173	ASSY GUITAR COMPLETE R/H MG1 BLACK	10 EA	.0	A	Y	N	1.000000
2	5 04-06-0001	FERRITE CABLE SLEEVE .70 x.48 x .22"	10 EA	.0	A	Y	N	2.000000
2	16 21-29-0004	WIRE 22AWG 152.40mm INSUL GRN STRND STRIP-TINNED ENDS	10 FT	.0	A	Y	N	1.000000
2	17 21-29-0005	WIRE 22AWG 30mm INSUL GRN STRND STRIP-TINNED ENDS	10 EA	.0	A	Y	N	1.000000
2	20 21-34-0023	CAB ASSY 32-PIN DIL to MULT SIL/MULT LENGTH	10 EA	.0	A	Y	N	1.000000
2	25 21-34-0026	CAB ASSY SIL 2-PIN to BATTERY CLIP 26 AWG	10 EA	.0	A	Y	N	1.000000
2	30 24-03-0005	SWITCH TOGGLE DPTT 5-POSITION 8-PIN OPEN FRAME	10 EA	.0	A	Y	N	1.000000
2	35 30-00-0022	SCREW 6-32 x .250" OVAL HD PHILIPS NICKEL	10 EA	.0	A	Y	N	2.000000
2	40 30-00-0026	SCREW 6-32 x 12.57mm SLOT SST w/RETAINING RING SLOT CUSTOM	10 EA	.0	A	Y	N	1.000000
2	45 30-00-0027	SCREW WOOD #4 x 1/2" FLAT HD PHIL BLK	10 EA	.0	A	Y	N	8.000000
2	50 30-21-0001	HOLDER BATTERY 6-AA CELL SNAP TERMINAL	10 EA	.0	A	Y	N	1.000000
2	55 30-45-0002	KNOB KNURLED .76 DIA x .75 HT BRASS CHROME MG-1						2.000000

LINE 6
Variax Parts List

2	60 30-45-0004	KNOB SWITCH 5-WAY PLASTIC WHITE	10 EA	.0 A Y N	1.000000
2	65 30-51-0099	COVER BATT HOLDER 2.7X2.0 CRS BLK POWDER COAT	10 EA	.0 A Y N	1.000000
2	70 30-51-0100	FRAME BATT HOLDER 2.7X3.4 CRS BLK POWDER COAT	10 EA	.0 A Y N	1.000000
2	50-04-0004	BRIDGE ASSMBLY with Flex Cable 2.95x1.72 LR BAGGS X-BRIDGE CHROME			1.000000
2	80 30-51-0112	INDICATOR MODEL NAME .736 OD x .030THK SST	10 EA	.0 A Y N	1.000000
2	85 30-51-0120	RING E RETAINING .25" OD .105" ID x .025" THK	10 EA	.0 A Y N	1.000000
2	90 30-51-0121	SPRING SELECT KNOB .590 OD .315 ID .010 THK SPRING STEEL	10 EA	.0 A Y N	1.000000
2	95 30-63-0005	FOAM 1.60 x 2.50x.0625 THK	10 EA	.0 A Y N	4.000000
2	100 30-65-0007	TAPE, 3M VHB	10 EA	.0 A Y N	1.000000
2	110 30-75-0013	CAP PROT VINYL .692 ODx.250 HI BLACK	10 EA	.0 A Y N	1.000000
2	115 40-25-0500	STICKER REAR-COVER BATTERY	10 EA	.0 A Y N	1.000000
2	120 40-25-0501	STICKER COVER-REAR MAIN	10 EA	.0 A Y N	1.000000
2	125 50-00-0137	PCBA MAIN MG-1	10 EA	.0 A Y N	1.000000
3	10 01-00-0106	RES 10M 5% 0805	10 EA	.0 A Y N	6.000000
3	20 01-24-47R5	Ref: R46-49,R52,R55 RES 47.5R 1% 0805	10 EA	.0 A Y N	3.000000
3	30 01-25-1001	Ref: R1,R6,R16 RES 1.00K 1% 0603	10 EA	.0 A Y N	11.000000
3	40 01-25-1002	Ref: R2-3,R12-13,R19-22,R33,R72-73 RES 10.0K 1% 0603	10 EA	.0 A Y N	10.000000
3	50 01-25-1003	Ref: R7-11,R15,R17,R41,R43,R51 RES 100K 1% 0603		Ref: R28,R32	2.000000

LINE 6
Variax Parts List

3	60 01-25-1182	RES 11.8K 1% 0603	10 EA	.0 A Y N	2.000000
3	70 01-25-1502	Ref: R26,R66 RES 15.0K 1% 0603	10 EA	.0 A Y N	4.000000
3	80 01-25-1871	Ref: R25,R27,R36,R70 RES 1.87K 1% 0603	10 EA	.0 A Y N	1.000000
3	90 01-25-20R0	Ref: R29 RES 20.0R 1% 0603	10 EA	.0 A Y N	2.000000
3	100 01-25-2212	Ref: R24,R34 RES 22.1K 1% 0603	10 EA	.0 A Y N	4.000000
3	110 01-25-3012	Ref: R59-62 RES 30.1K 1% 0603	10 EA	.0 A Y N	2.000000
3	120 01-25-3322	Ref: R35,R71 RES 33.2K 1% 0603	10 EA	.0 A Y N	1.000000
3	130 01-25-3323	Ref: R23 RES 332K 1% 0603	10 EA	.0 A Y N	1.000000
3	140 01-25-3651	Ref: R56 RES 3.65K 1% 0603	10 EA	.0 A Y N	3.000000
3	150 01-25-4750	Ref: R14,R64,R67 RES 475R 1% 0603	10 EA	.0 A Y N	3.000000
3	160 01-25-4752	Ref: R5,R40,R68 RES 47.5K 1% 0603	10 EA	.0 A Y N	7.000000
3	170 01-25-4871	Ref: R18,R37-38,R44,R53,R63,R74 RES 4.87K 1% 0603	10 EA	.0 A Y N	2.000000
3	180 01-25-6R81	Ref: R30,R39 RES 6.81R 1% 0603	10 EA	.0 A Y N	5.000000
3	190 01-25-68R1	Ref: R4,R42,R50,R54,R65 RES 68.1R 1% 0603	10 EA	.0 A Y N	1.000000

Ref: R45

LINE 6
Variax Parts List

3	200 01-25-7501	RES 7.50K 1% 0603	10 EA	.0 A Y N	3.000000
3	210 01-25-9310	Ref: R57-58,R69 RES 931R 1% 0603	10 EA	.0 A Y N	1.000000
3	215 03-02-0155	Ref: R31 CAP TANT 1.5uF 35V 20% TH 3.5x5.5x2.5	10 EA	.0 A Y N	1.000000
3	220 03-10-1108	CAP ELEC 1000uF 10V 20% RADIAL 10/12.5/5	10 EA	.0 A Y N	2.000000
3	230 03-10-6108	Ref: C108,C111 CAP ELEC 1000uF 6.3V 20% RADIAL 8/11.5/5	10 EA	.0 A Y N	1.000000
3	240 03-45-0153	Ref: C94 CAP FILM 15nF 16V 5% 1206	10 EA	.0 A Y N	1.000000
3	250 03-46-0225	Ref: C86 CAP X7R 2.2uF 16V 20% 1206	10 EA	.0 A Y N	15.000000
3	260 03-52-0104	Ref: C8,C12,C23,C41,C45-46,C49,C56,C62,C74,C79,C89-90,C95,C101 CAP X7R 0.1uF 50V 20% 0805	10 EA	.0 A Y N	29.000000
3	270 03-56-0101	Ref: C2-4,C10-11,C13,C15-16,C18,C24,C28-29,C31,C52-54,C57,C61, C64,C67-70,C72-73,C77,C80,C87-88 CAP NPO 100pF 50V 5% 0603	10 EA	.0 A N	1.000000
3	280 03-56-0102	Ref: C48 CAP NPO 1nF 50V 5% 0603	10 EA	.0 A Y N	6.000000
3	290 03-56-0221	Ref: C7,C9,C17,C22,C36,C40 CAP NPO 220pF 50V 5% 0603	10 EA	.0 A Y N	8.000000
3	300 03-56-0330	Ref: C19,C25,C30,C32,C43-44,C47,C105 CAP NPO 33pF 50V 5% 0603	10 EA	.0 A Y N	2.000000
3	310 03-56-0471	Ref: C35,C37 CAP NPO 470pF 50V 5% 0603	10 EA	.0 A N	6.000000
3	320 03-56-0681	Ref: C42,C65,C75-76,C85,C91 CAP NPO 680pF 50V 5% 0603	10 EA	.0 A Y N	1.000000

LINE 6
Variax Parts List

3	330 03-58-0473	CAP X7R 47nF 25V 20% 0603	10 EA	.0 A Y N	27.000000
		Ref: C1,C5-6,C14,C20-21,C26-27,C34,C38-39,C50-51,C58,C78,C93,C96, C100,C102-103,C106-107,C109-110,C113-114,C116			
3	340 03-80-0107	CAP ELEC 100uF 10V 20% SM 6.3/5.4/7.8	10 EA	.0 A Y N	3.000000
		Ref: C92,C97,C112			
3	350 03-82-0106	CAP ELEC 10uF 16V 20% SM 4/5.4/5.5	10 EA	.0 A Y N	14.000000
		Ref: C33,C55,C59-60,C71,C81-84,C98-99,C104,C115,C118			
3	360 04-01-0330	INDUCTOR DRUM-CORE 33uH@ 2.52MHz 640mA SM GS43	10 EA	.0 A N	1.000000
		Ref: L6			
3	370 04-01-0471	INDUCTOR DRUM-CORE 470uH@ 1KHz 240mA SM GS54	10 EA	.0 A Y N	2.000000
		Ref: L2-3			
3	380 04-05-0001	FERRITE BEAD 1K@1MHz 100mA 0603 SM	10 EA	.0 A Y N	2.000000
		Ref: L1,L7			
3	390 06-32-0313	DIODE RECTIFIER 200V 3A SMB SM S3DB-13	10 EA	.0 A Y N	1.000000
		Ref: D7			
3	400 06-32-0340	DIODE SCHOTTKY 3A 40V SMB SM B340B	10 EA	.0 A Y N	1.000000
		Ref: D1			
3	410 06-32-4006	DIODE RECTIFIER 800V 1A SMA SM MRA4006T3	10 EA	.0 A Y N	2.000000
		Ref: D4-5			
3	420 06-34-0016	DIODE SWITCHING 75V 200mA 6nS SOT-23 SM BAS16LT1	10 EA	.0 A Y N	3.000000
		Ref: D2-3,D6			
3	430 09-10-4401	TRANS NPN SMALL-SIGNAL MBT4401 SOT-23 SM	10 EA	.0 A Y N	1.000000
		Ref: Q1			
3	440 11-00-0001	CRYSTAL 4MHZ 2 PIN METAL CASE HC49 SM HCM49	10 EA	.0 A N	1.000000
		Ref: X1			
3	450 11-01-0001	OSCILLATOR 10MHz 3.3V 4 PIN SMD ECS-3953	10 EA	.0 A Y N	1.000000
		Ref: Y1			
3	460 12-50-1117	IC REG 3.3V LOW-DROP LINEAR 800mA LM117MPX-3.3 SOT-23 SM	10 EA	.0 A Y N	1.000000
		Ref: U9			

LINE 6
Variax Parts List

3	470 12-52-1118	IC REG 1.8V LDO LINEAR 800mA SOT-223 SM LM1117MPX-1.8	10 EA	.0	A	Y	N	1.000000
		Ref: U6						
3	480 12-52-2937	IC REG +5V LDO 0.5A 0.5V SOT-223 SM LM2937	10 EA	.0	A	Y	N	1.000000
		Ref: U13						
3	490 12-54-0082	IC OP AMP DUAL TL082CD SO-8 SM	10 EA	.0	A	Y	N	1.000000
		Ref: U15						
3	500 12-54-4340	IC OP-AMP QUAD 5V SINGLE SPLY RAIL TO RAIL SO-14 SM OPA4340	10 EA	.0	A	Y	N	2.000000
		Ref: U3,U7						
3	510 12-64-1838	IC ADC 8 bit, 8 channel PW20 (TSSOP) SM TLV0838CPW	10 EA	.0	A	Y	N	1.000000
		Ref: U12						
3	520 12-64-4528	IC CONVERTER 24B 48/96KHz AUDIO CODEC SM AK4528	10 EA	.0	A	Y	N	3.000000
		Ref: U1,U4,U8						
3	530 12-70-0887	IC CONVERTER STEP-DOWN PWM DC-DC SO-8 SM	10 EA	.0	A	Y	N	1.000000
		Ref: U20						
3	540 12-70-2664	IC VOLTAGE INVERTER SWITCH CAP LM2664	10 EA	.0	A	Y	N	1.000000
		Ref: U11						
3	550 15-62-4051	IC 74HC4051 8 TO 1 ANALOG MUX/DMUX SM 74HC4051	10 EA	.0	A	Y	N	1.000000
		Ref: U14						
3	560 15-67-3100	IC SPI UART QSOP16 SM MAX3100	10 EA	.0	A	Y	N	1.000000
		Ref: U10						
3	570 15-67-3490	IC RS-488/422 TRANSCEIVER 3.3V SO-8 SM MAX3490	10 EA	.0	A	Y	N	2.000000
		Ref: U16,U19						
3	580 15-72-6424	IC SRAM 64K X 24 3.3V 100TQFP SM IS61LV6424-9TQ or -10TQ	10 EA	.0	A	Y	N	1.000000
		Ref: U17						
3	590 15-86-6367	IC 24-BIT DSP SM LQFP144 DSP56367	10 EA	.0	A	Y	N	1.000000
		Ref: U2						
3	600 15-92-1816	IC RESET 3.3V 5% ACTIVE-LO SM SOT-23 DS1816R-5/T&R	10 EA	.0	A	Y	N	1.000000
		Ref: U5						
3	610 21-20-0008	HDR SIL 8-PIN x 2mm MALE SHRD B8B-PH-K-S					Ref: J1	1.000000

LINE 6
Variax Parts List

3	620 21-20-0102	HDR PCB MT SIL 2-PIN x 2mm MALE SHRD RA MT TH	10 EA	.0	A	Y	N	1.000000
		Ref: J3						
3	630 21-20-3010	HDR PCB MT SIL FLEX 10P X.5MM ROTARY-LOCK ZIF HORIZ MT SM	10 EA	.0	A	Y	N	1.000000
		Ref: J4						
3	640 21-21-0032	HDR PCB MT DIL 32-PIN 2x16x 2mm MALE SHRD RT ANG MT TH	10 EA	.0	A		N	1.000000
		Ref: J2						
3	660 45-02-0005	IC PROGRAMMED FLASH v1.02 c/s=0x5099611 MG-1	10 EA	.0	A	Y	N	1.000000
		Ref: U18						
4	10 15-78-0000	IC FLASH 4Meg 512Kx8/256x16 TSOP-48 SM AM29LV400	10 EA	.0	A	Y	N	1.000000
2	130 50-00-0157	PCBA POT VOLUME MG-1	10 EA	.0	A	Y	N	1.000000
3	10 01-49-2103	POT STEREO 10KB LINEAR 22.5mm MTL KNRLD SHFT HORIZ MNT	10 EA	.0	A	Y	N	1.000000
		Ref: R1						
3	20 21-20-0206	HDR PCB MT SIL 6-PIN x 2mm FEMALE SHRD VERT MT TH	10 EA	.0	A	Y	N	1.000000
		Ref: J6						
2	135 50-00-0158	PCBA POT TONE MG-1	10 EA	.0	A	Y	N	1.000000
3	10 01-48-3503	POT MONO 50KB LINEAR TAPER 22.5mmMTL KNRLDSHFT VERT MT	10 EA	.0	A	Y	N	1.000000
		Ref: R1						
3	20 21-20-0203	HDR PCB MT SIL 3-PIN x 2mm MALE SHRD VERT MT TH	10 EA	.0	A		N	1.000000
		Ref: J2						
2	140 50-00-0159	PCBA POT MODEL SELECT MG-1	10 EA	.0	A	Y	N	1.000000
3	10 01-48-2503	POT MONO 50KB LINEAR w/SWITCH 22.5mmMETAL KNRLD SHFT HOR MT	10 EA	.0	A	Y	N	1.000000
		Ref: R1						
3	20 21-20-0205	HDR PCB MT SIL 5-PIN x 2mm FEMALE SHRD VERT MT TH	10 EA	.0	A	Y	N	1.000000
		Ref: J1						

LINE 6
Variax Parts List

3	10 30-00-0408	SCREW 4-22 x .500 PAN HD PHIL BLK	10 EA	.0	A	Y	N	2.000000
		Ref: JACK PLATE - XLR CONNECTORS						
3	20 30-03-0016	WASHER FINISHING 18-8 0.625 x 0.390 x 0.028IN STAINLESS STL	10 EA	.0	A	Y	N	1.000000
3	25 30-15-0004	SPACER .13THKx.630D NYLON	10 EA	.0	A	Y	N	1.000000
3	30 30-65-0008	TAPE FOIL COPPER w/ADHSV VHB-9 460 5mil 0.200 x 1.25IN 2oz	10 EA	.0	A	Y	N	1.000000
3	40 30-27-0052	PLATE JACK 3.3x1.3 HDPE BLK MG-1	10 EA	.0	A	Y	N	1.000000
3	50 50-00-0160	PCBA RJ45 MG-1	10 EA	.0	A	Y	N	1.000000
4	10 11-10-2012	FERRITE BEAD 600R@100MHZ 300mA 0805 SM	10 EA	.0	A	Y	N	8.000000
		Ref: L5-12						
4	20 21-16-0002	JACK RJ-45 9-PIN IN XLR SHELL PCB-MNT VERT TH	10 EA	.0	A	Y	N	1.000000
		Ref: J1						
4	30 21-20-0008	HDR SIL 8-PIN x 2mm MALE SHRD B8B-PH-K-S	10 EA	.0	A	Y	N	1.000000
		Ref: J2						
3	60 50-00-0161	PCBA OUTPUT GUITAR MG-1	10 EA	.0	A	Y	N	1.000000
4	10 03-12-0476	CAP ELEC 47uF 16V 20% RADIAL 6.3/11.2/5	10 EA	.0	A	Y	N	1.000000
4	40 21-00-6617	JACK 1/4" TRS 6-PIN PCB MT HORIZ TH W/CHROME HRDWARE	10 EA	.0	A	Y	N	1.000000
		Ref: J2						
4	50 21-20-0205	HDR PCB MT SIL 5-PIN x 2mm FEMALE SHRD VERT MT TH	10 EA	.0	A	Y	N	1.000000
		Ref: J1						
2	150 50-00-0203	ASSY KNOB MODEL SELECT w/ARTWORK MG1	10 EA	.0	A	Y	N	1.000000
3	10 30-45-0001	KNOB MODEL NAME .74DIAx.75 METAL	0 EA	.0	A	Y	N	1.000000
2	155 50-00-0270-1	ASSY GUITAR R/H BLACK VARIAX	10 EA	.0	A	Y	N	1.000000
3	10 30-27-0058-0	PICKGUARD PLASTIC LAM POLISH BRIGHT BLACK PEARLOID	0 EA	.0	A		N	1.000000
3	25 30-42-0001	OVERLAY KNOB FUNCTION MG1	0 EA	.0	A	Y	N	1.000000

LINE 6
Variax Parts List

3	30 50-00-0154	ASSY GUITAR BODY WITH NECK RH	0 EA	.0	A	Y	N	1.000000
4	10 21-32-0001	CBL FLEX CIRCUIT 10-COND .5 x 54.30mm VERT EX	10 EA	.0	A	Y	N	1.000000
4	20 30-00-0030	SCREW WOOD #4 x .50 OVAL HD PHIL CHROME	10 EA	.0	A		N	9.000000
4	30 30-00-0031	SCREW 3mm x 7mm OVAL HD PHIL BLK MG1	10 EA	.0	A	Y	N	10.000000
4	40 30-21-0002	PIN STRAP GUITAR MG1	10 EA	.0	A		N	1.000000
4	50 30-27-0057	COVER TRUSS ROD 1.11x1.57 PLASTIC LAM POLISH BRIGHT MG-1	10 EA	.0	A	Y	N	1.000000
2	50-04-0004	BRIDGE ASSMBLY with Flex Cable 2.95x1.72 LR BAGGS X-BRIDGE CHROME						1.000000
4	80 30-51-0109	TUNER GUITAR UPPER CHROME MG-1	10 EA	.0	A	Y	N	1.000000
4	90 30-51-0128	COVER BODY CAVITY PLASTIC BLACK MG1	10 EA	.0	A		N	1.000000
4	100 40-60-0000	STRING NICKEL SOLID E .010	10 EA	.0	A	Y	N	1.000000
4	110 40-60-0001	STRING NICKEL SOLID B .013	10 EA	.0	A	Y	N	1.000000
4	120 40-60-0002	STRING NICKEL SOLID G .017	10 EA	.0	A	Y	N	1.000000
4	130 40-60-0003	STRING NICKEL WOUND D .026	10 EA	.0	A	Y	N	1.000000
4	140 40-60-0004	STRING NICKEL WOUND A .036	10 EA	.0	A	Y	N	1.000000
4	150 40-60-0005	STRING NICKEL WOUND E .046	10 EA	.0	A	Y	N	1.000000

Variax Modeling Guitar Mechanical Assembly Instructions Rev B.

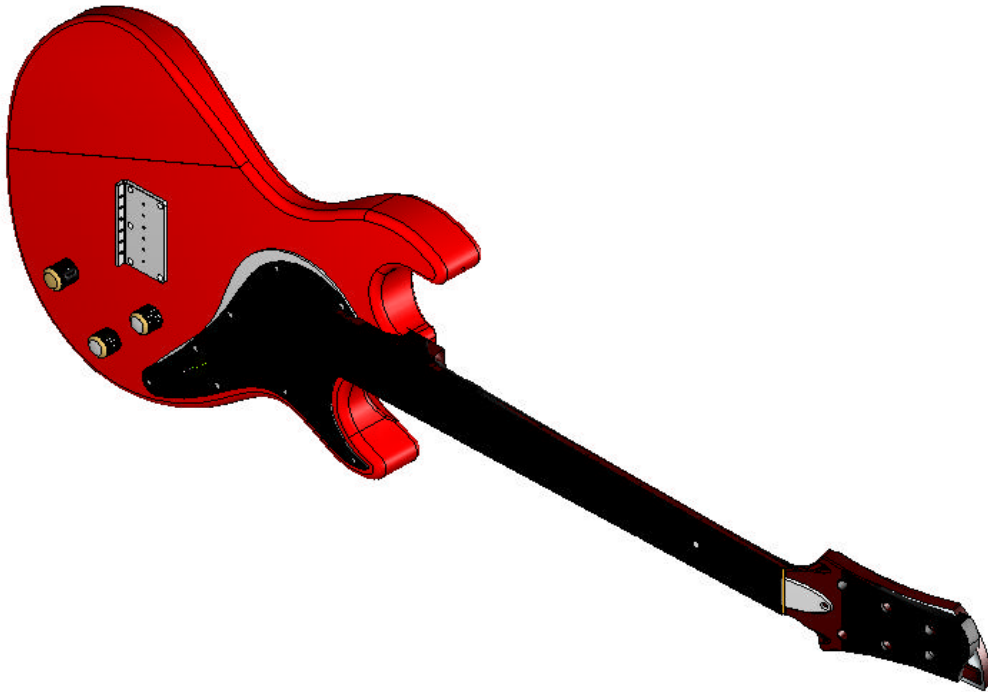

Forward and Notes

The information in this booklet applies to the Variax-Modeling Guitar. It is suggested that the steps for assembly, follow the order presented in these instructions;

This booklet deals with the assembling of the major sub-assemblies, the final product, and quality/inspection considerations. See also the related electrical assembly documentation for major considerations in assembling the electrical components of the PCBs (through the soldering process and preparation of the board for addition of custom components.

A note on the text: The illustrations in the book are for reference only. In some cases, color and geometry of illustrations may not accurately reflect the color or exact geometry of actual parts.

- Unless otherwise noted, all dimensions are in inches.
- Part identifying notes are in this format: Description (Part Number)
- Torque value tolerance +/- .5 in.-lbs. Do not over tighten any components.
- For clarity, not all component details are shown. This is especially true with respect to cable assemblies. They are often omitted from views to provide a clearer picture of the material discussed. Do not be confused by the absence (or unexpected presence) of any component in the illustrations in this book.

Battery Compartment Frame and Cover Mounting

Prior to installing the Battery Frame and Cover onto the battery compartment cavity frame mounting surface, apply the adhesive back foam to the underside of the Cover as shown. Also, apply adhesive back foam to the bottom of the battery compartment with the adhesive side of foam contacting the bottom of the battery compartment.

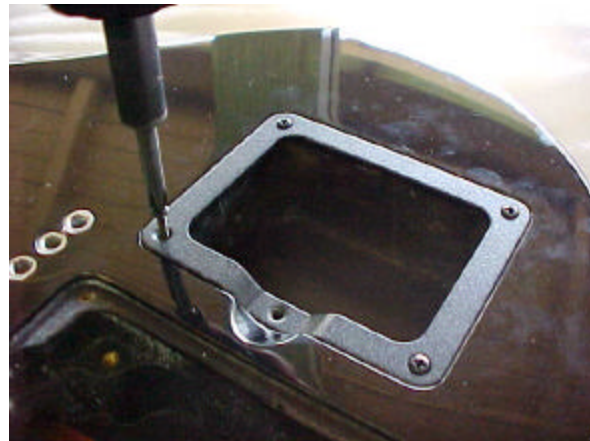
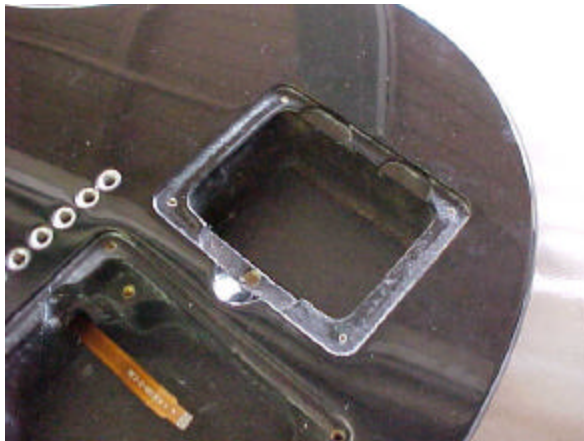
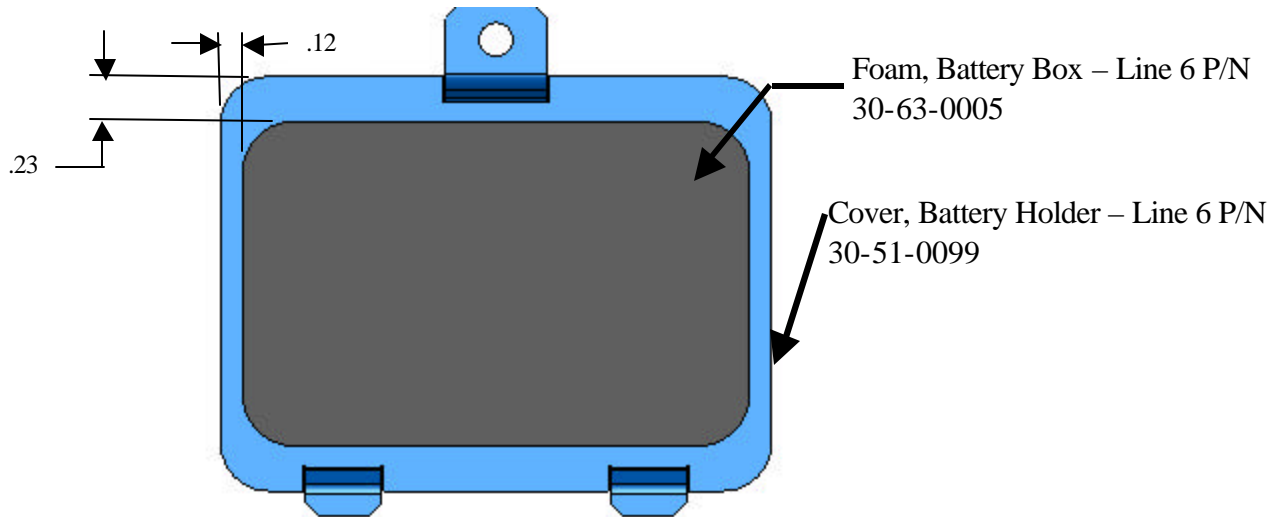

- 1) Place the Battery Frame onto the battery compartment mounting surface as shown. Ensure that the mounting surface is clear of any debris prior to mounting the Frame and Cover assy. Secure with four (4) # 30-00-0027 screws until fully seated.

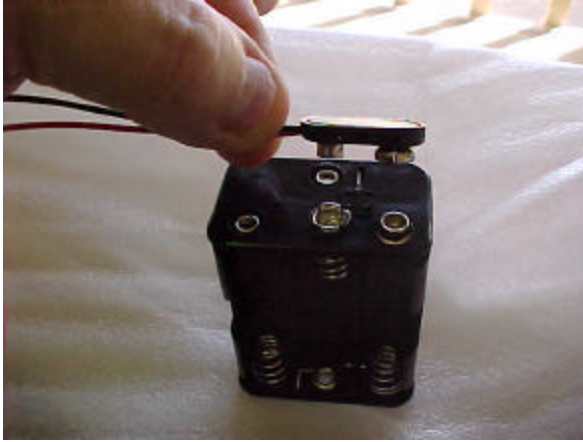

2) CABLE #21-34-0026 SHOULD BE CONNECTED TO THE BATTERY HOLDER #30-21-0001 AS SHOWN.

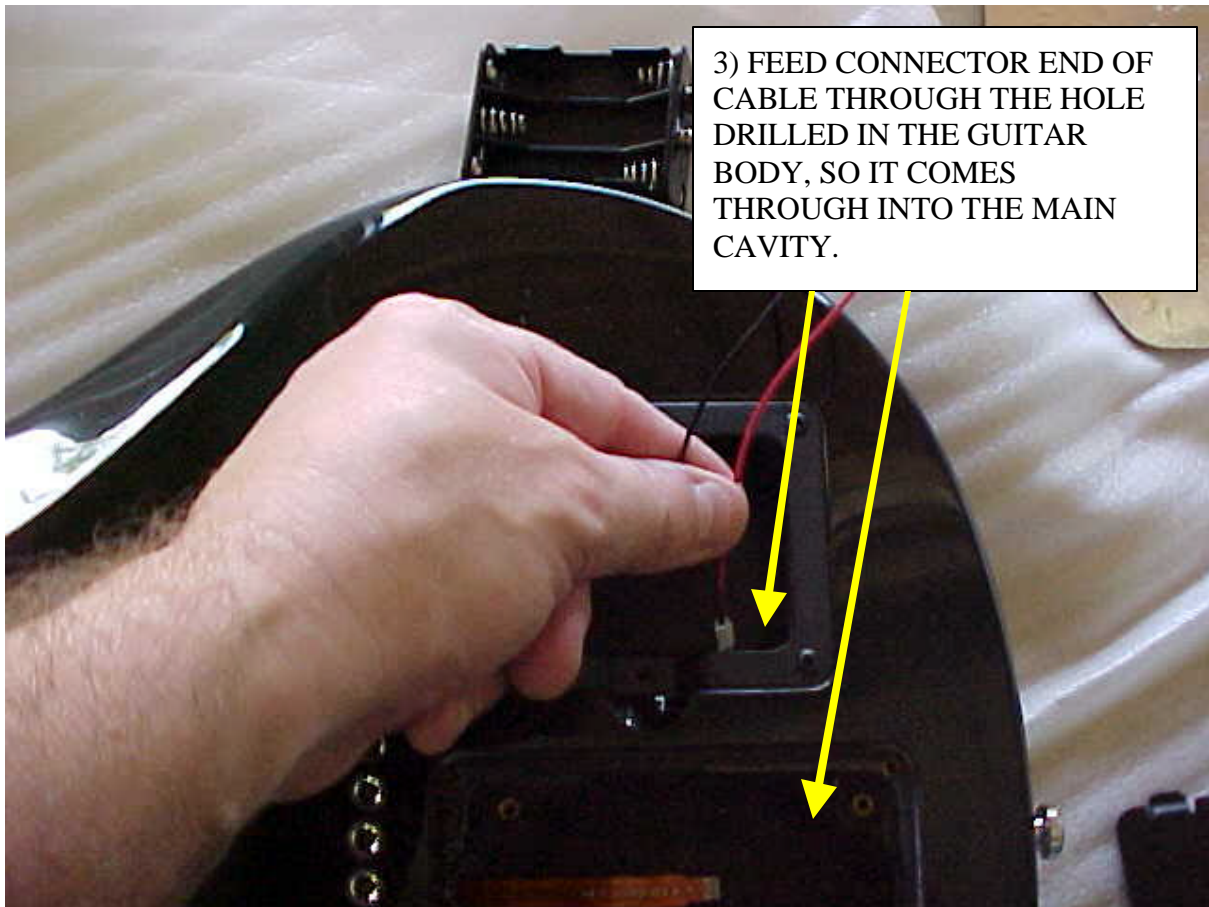

3) FEED CONNECTOR END OF CABLE THROUGH THE HOLE DRILLED IN THE GUITAR BODY, SO IT COMES THROUGH INTO THE MAIN CAVITY.

4) Place Battery holder (30-21-0001) & cable assembly (21-34-0026) in position.

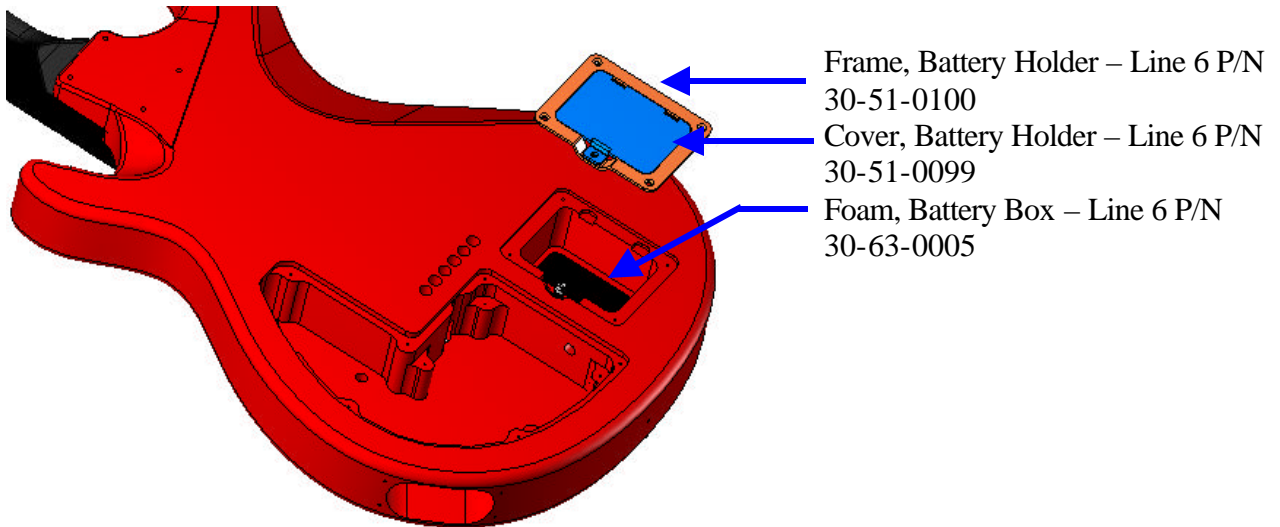

5) A small pair of pliers can be used to clip on the Retaining clip, into the groove of the screw, as shown. The screw should not fall out of the cover.

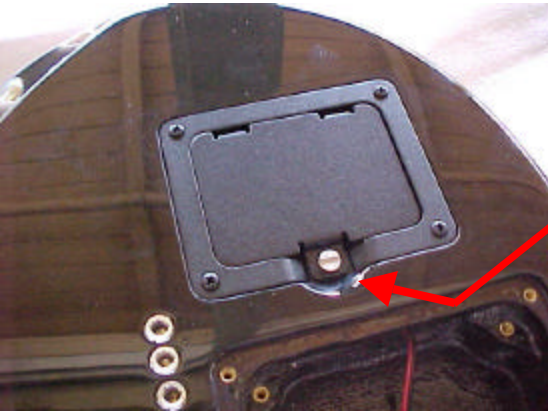

6) Assemble battery cover into frame, and tighten screw to 5 in/lbs.

Main PCB Installation

1) Prior to Main PCB installation, route the flex circuit (part of the bridge assy Line 6 P/N 50-00-0195) and nine volt battery cable approximately as shown. Insure that cables feed through the holes provided. Flex cable shall have slight curvature at top for connecting into the Latch Connector on the Main PCB. Some components not shown for clarity.

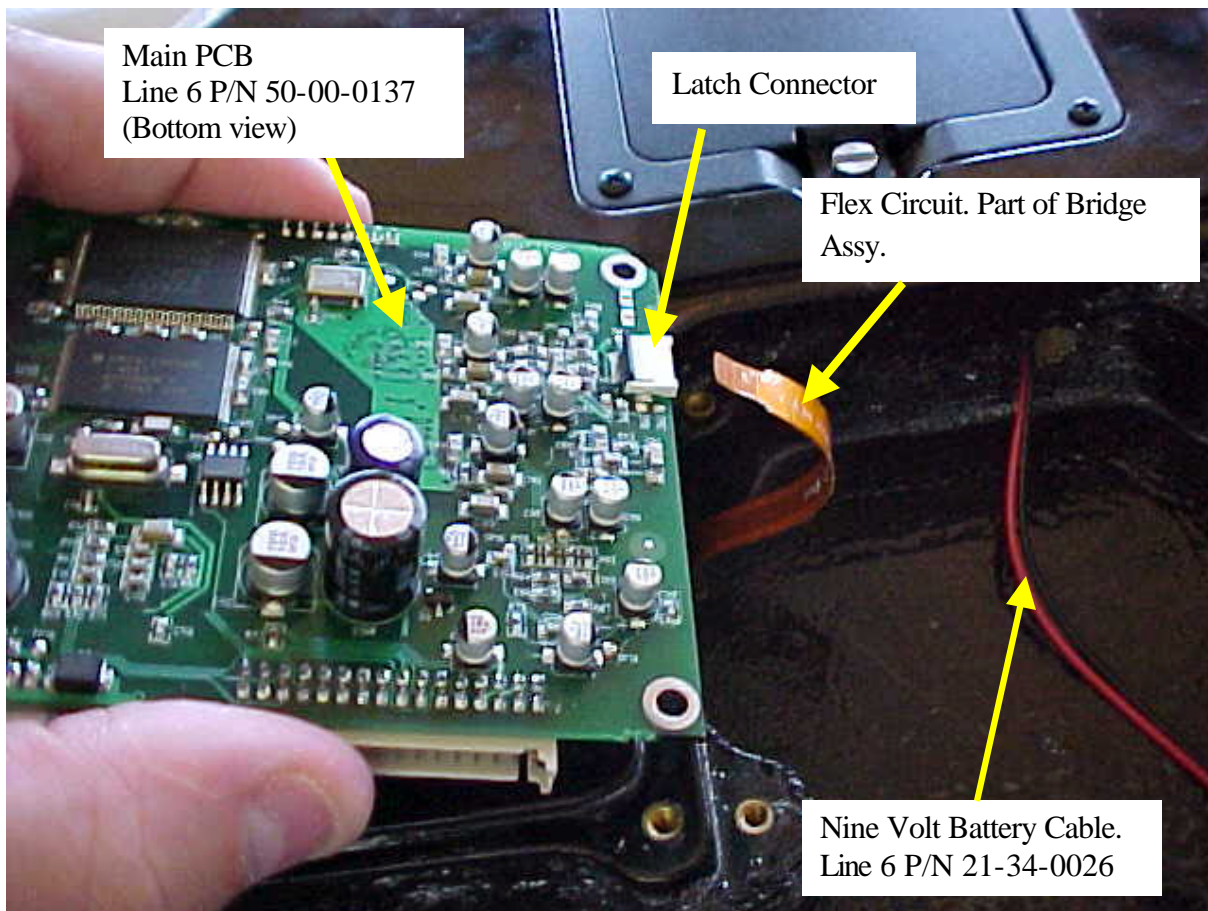

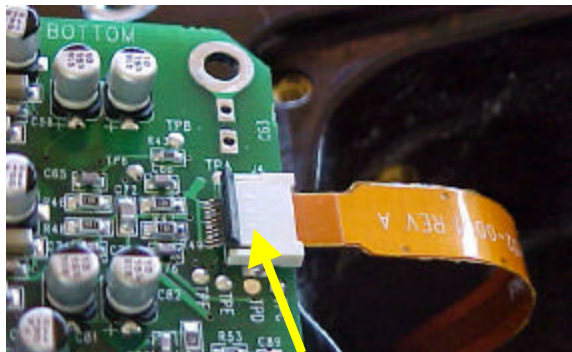

Latch connector shall be in “open” (up) position as shown to receive Flex Circuit. (Bottom view of Main PCB)

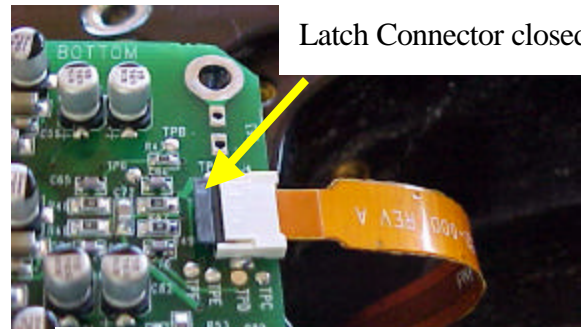

Insert end of Flex circuit into Latch connector on Main PCB as shown. Make certain that Latch connector is in the “open” position when inserting flex cable. Closed position is shown here.

- 2) Insert flex cable into connector (shown above).
- 3) “Close” (down) Latch Connector after fully inserting end of flex cable. Avoid opening and closing the Latch connector after initial connection.

Bottom view of Main PCB and flex circuit connection. Note the curvature of the flex circuit where flex circuit connects to Main PCB.

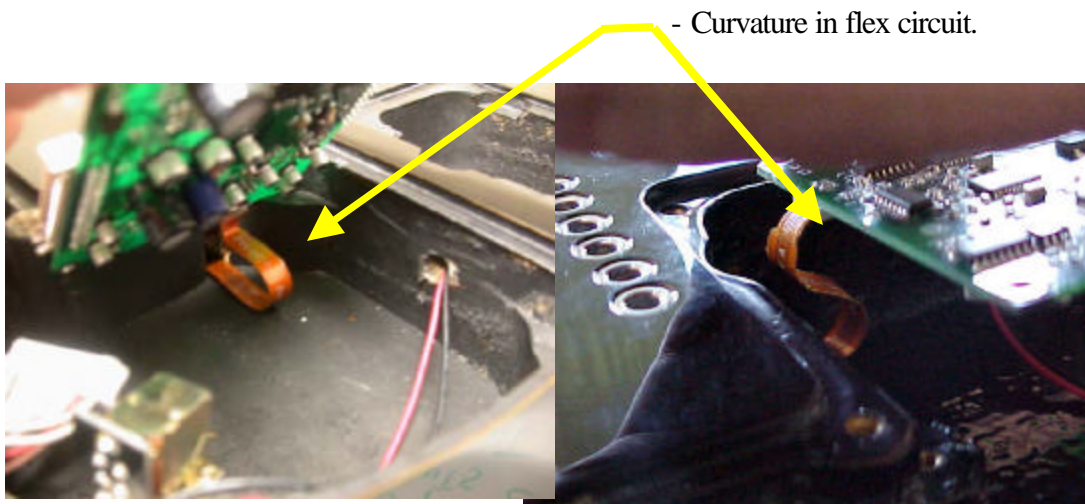

The illustration below shows the bottom view of the flex circuit installed in the Latch Connector on the Main PCB. Note the curvature in the flex circuit. **DO NOT BEND THE FLEX CIRCUIT 90 DEGREES – DAMAGE WILL OCCUR.**

Curvature in the flex circuit.
NOTE : PCBA should not be twisted like this, in case of damage to the flex cable.
Photo is for illustration of the curvature in the flex cable.

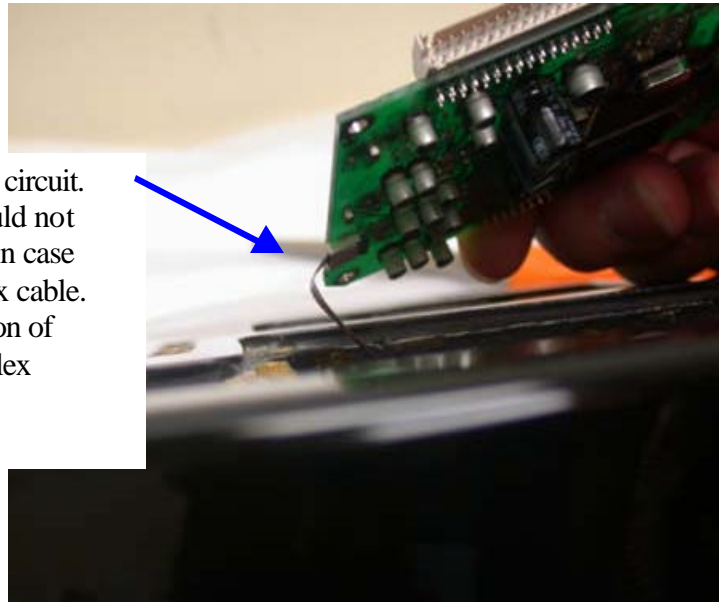

4) Mount the Main PCBA (Line 6 P/N 50-00-0137) onto the four mounting bosses in the guitar body control cavity. Make certain that the surfaces of the mounting bosses are free of any debris prior to mounting the PCBA. Secure with 4 screws provided . – 4 in/lbs torque.

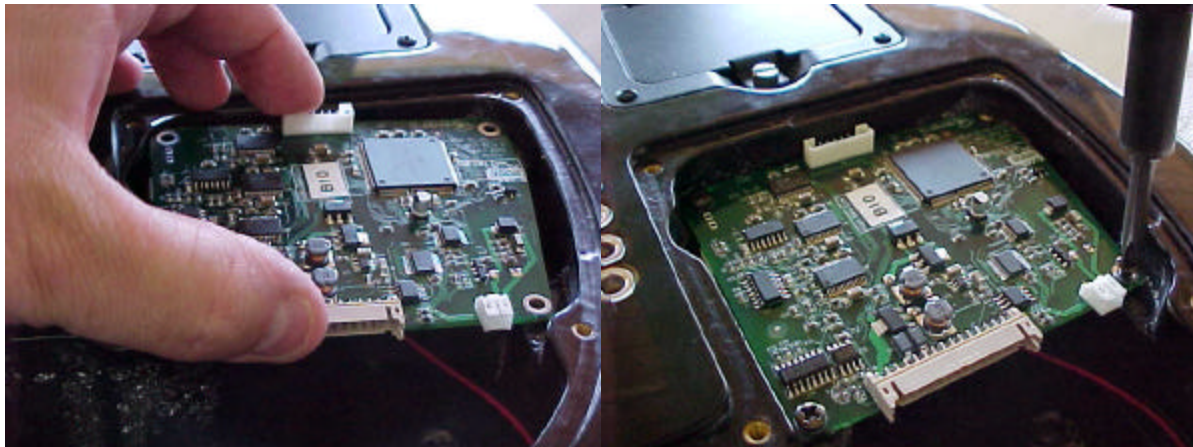

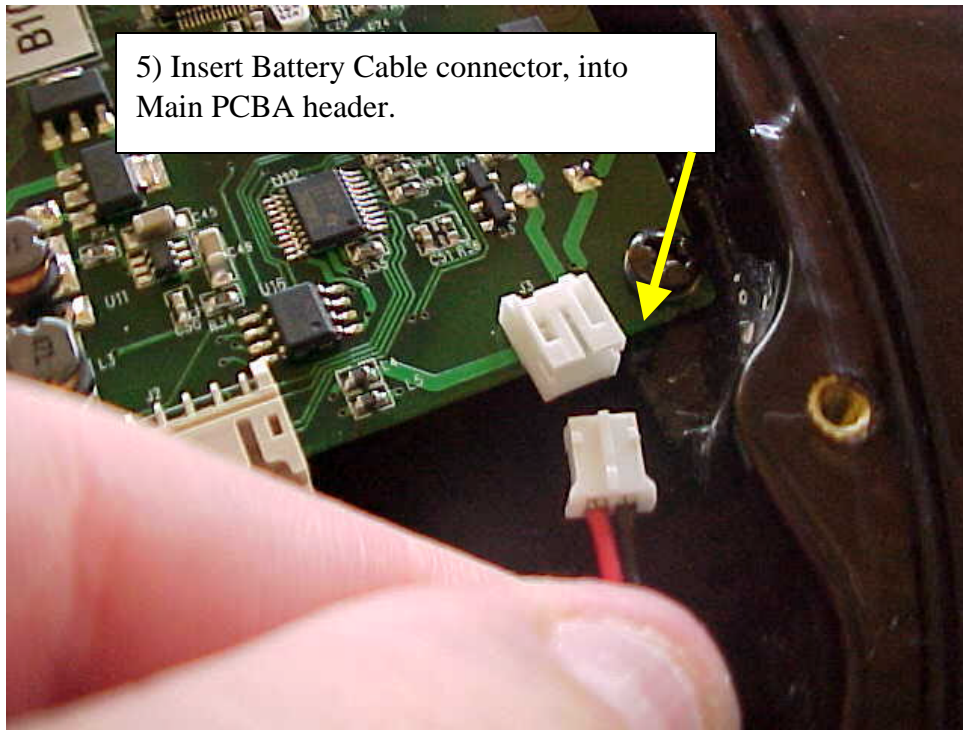

5) Insert Battery Cable connector, into Main PCBA header.

VARIAX GUITAR INPUT JACK ASSEMBLY & CABLE HARNESS ASSEMBLY.

1) Assemble parts as shown below.

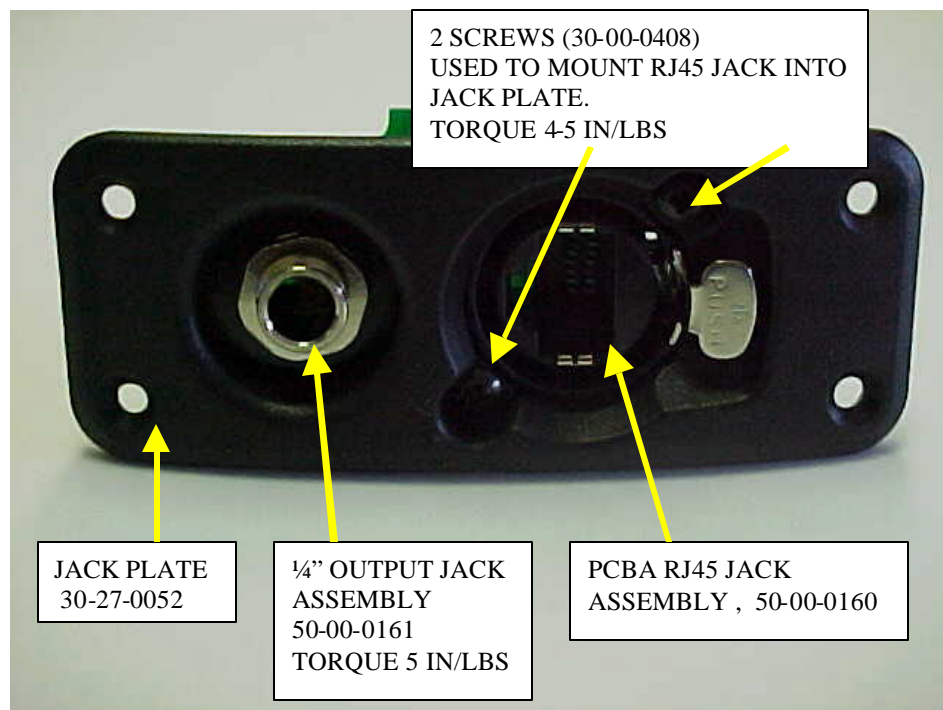

2 SCREWS (30-00-0408)
USED TO MOUNT RJ45 JACK INTO
JACK PLATE.
TORQUE 4-5 IN/LBS

JACK PLATE
30-27-0052

¼" OUTPUT JACK
ASSEMBLY
50-00-0161
TORQUE 5 IN/LBS

PCBA RJ45 JACK
ASSEMBLY , 50-00-0160

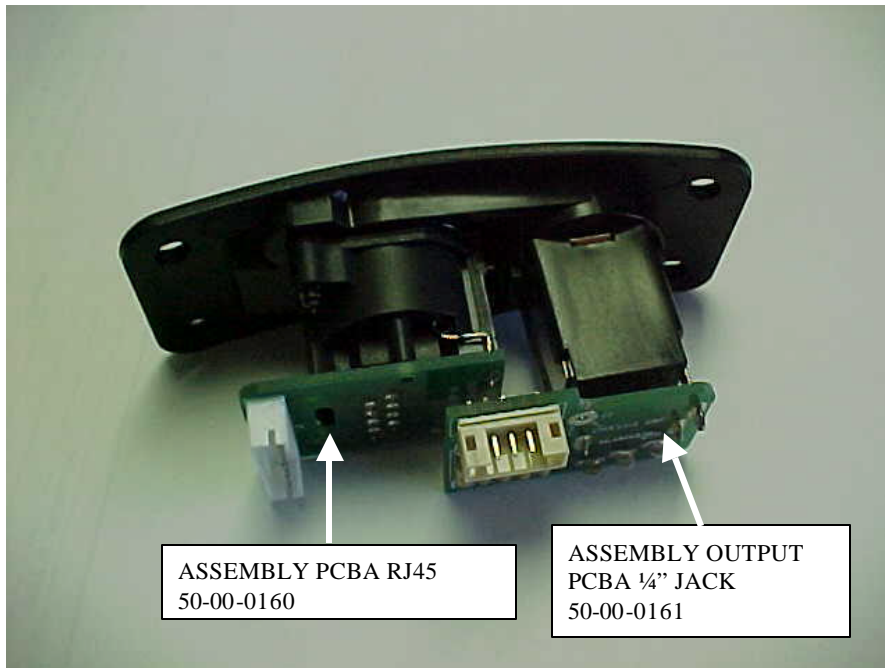

2) **Solder Cable harness (21-34-0023) to 5 Way selector switch (24-03-0005)** as shown :

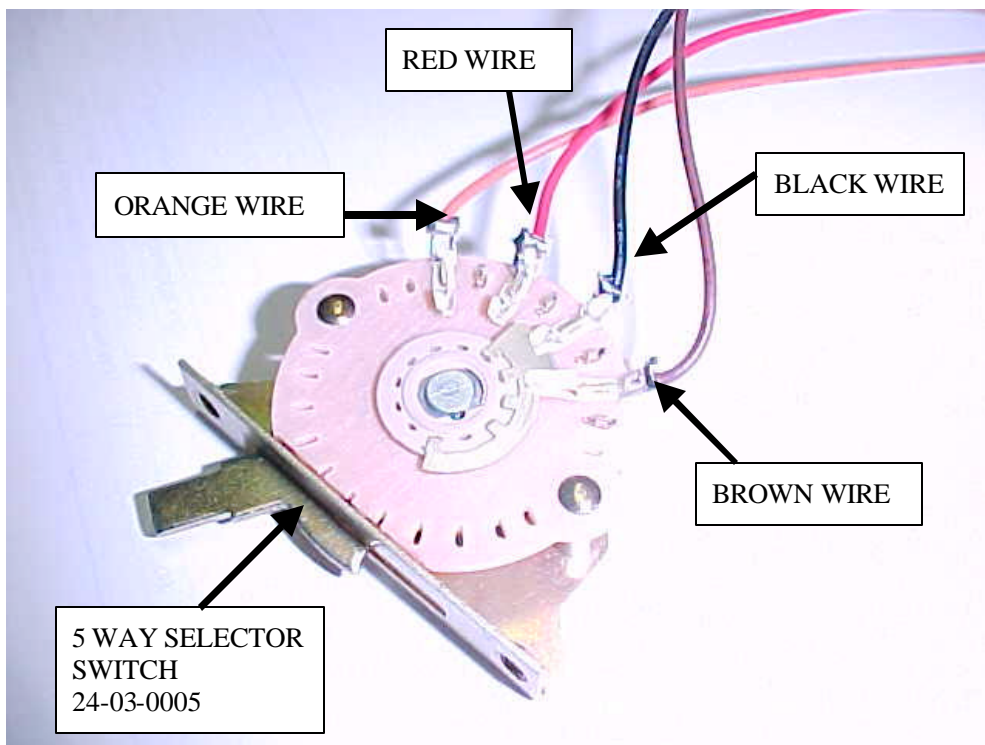

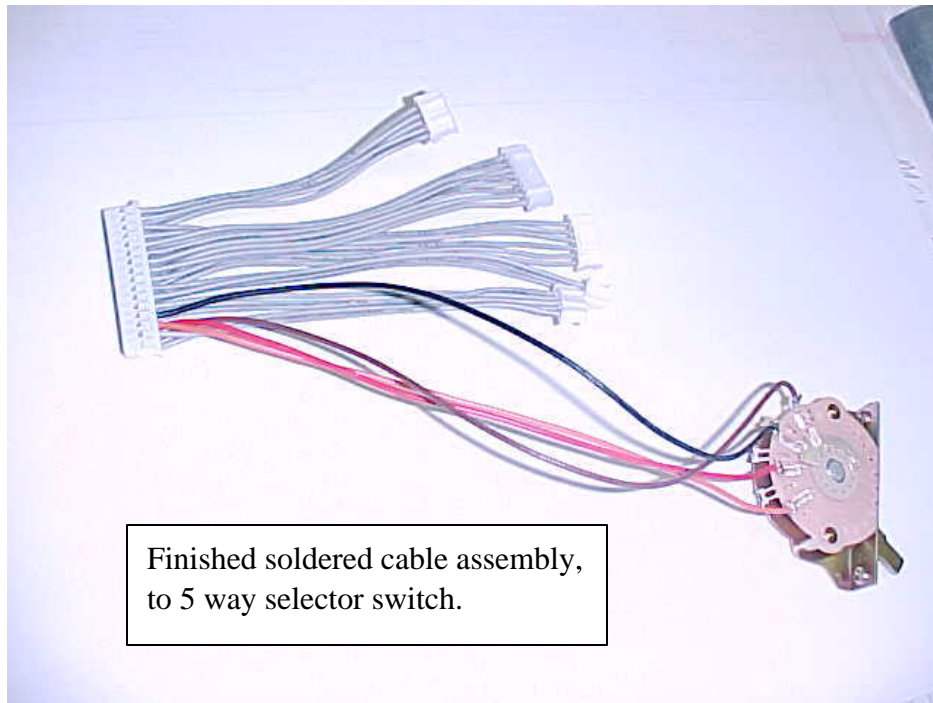

3) Connect Cable assembly to Jack plate assembly, as shown.

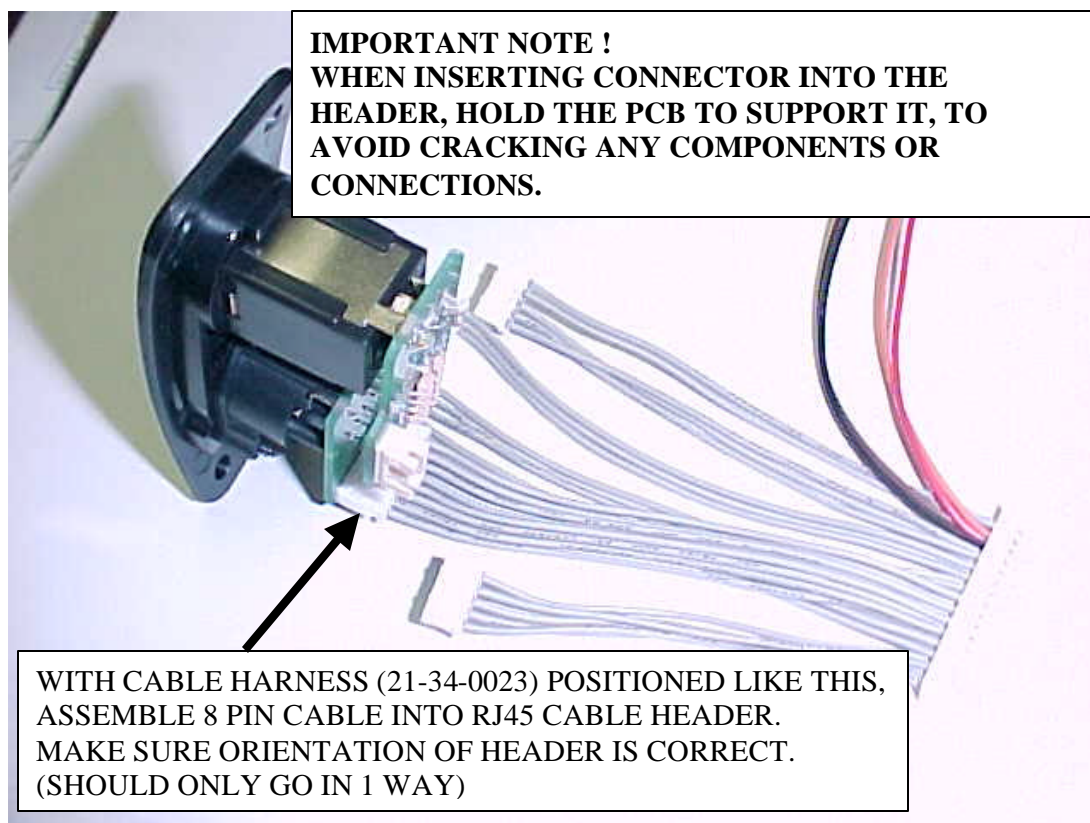

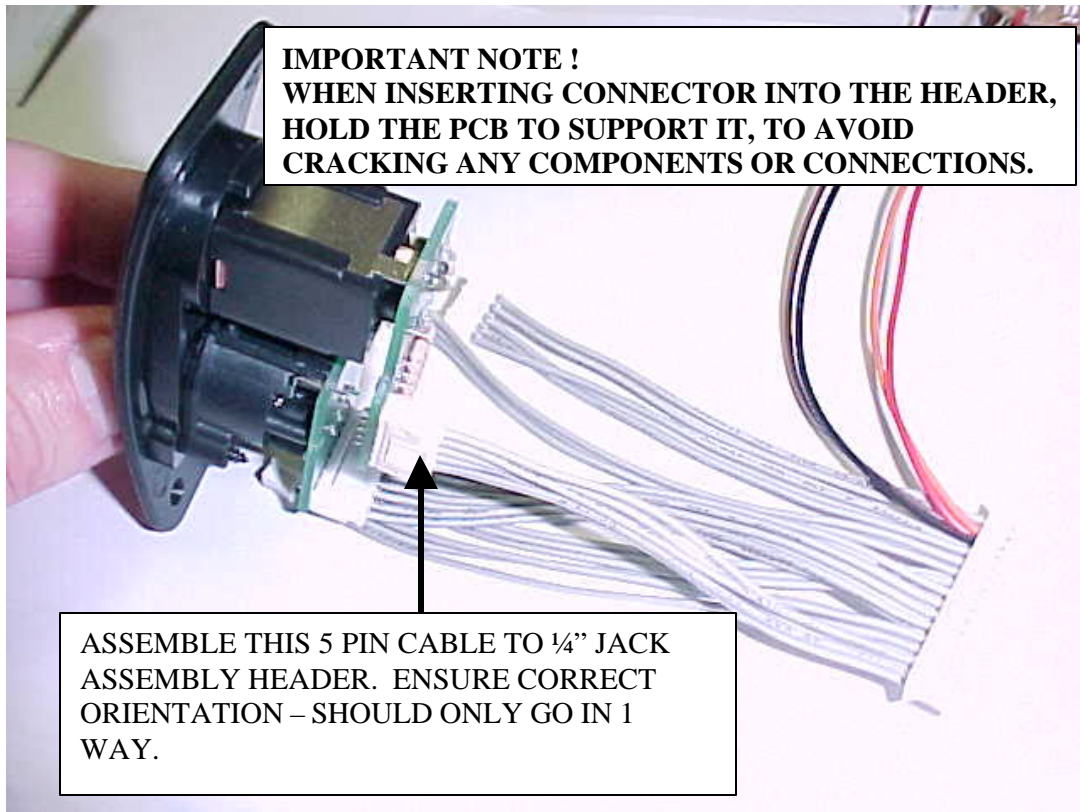

Jack Plate Assembly Installation

- 1) Install the Jack Plate Assembly (Line 6 P/N TBD) into the jack plate cavity on the guitar body as shown. Secure with four (4) 30-00-0027 screws, until flush with jackplate.

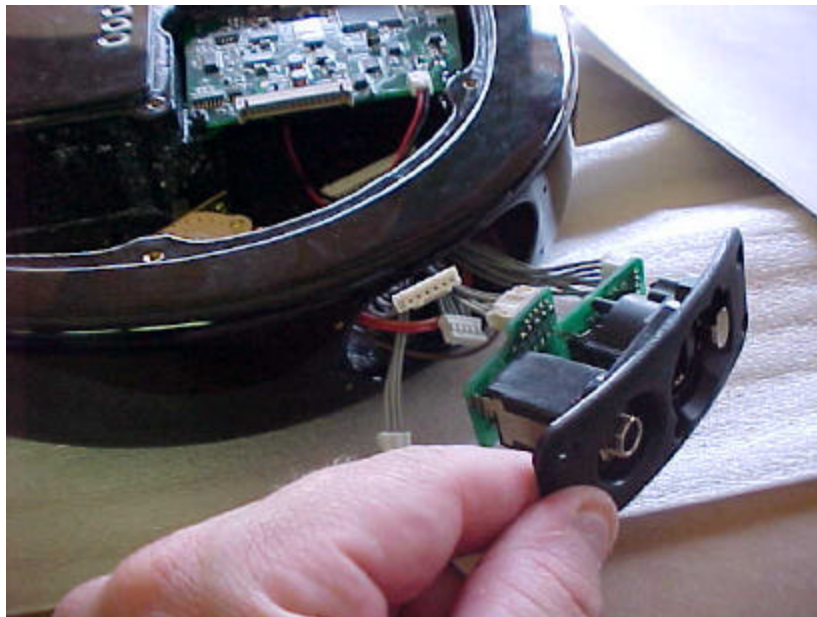

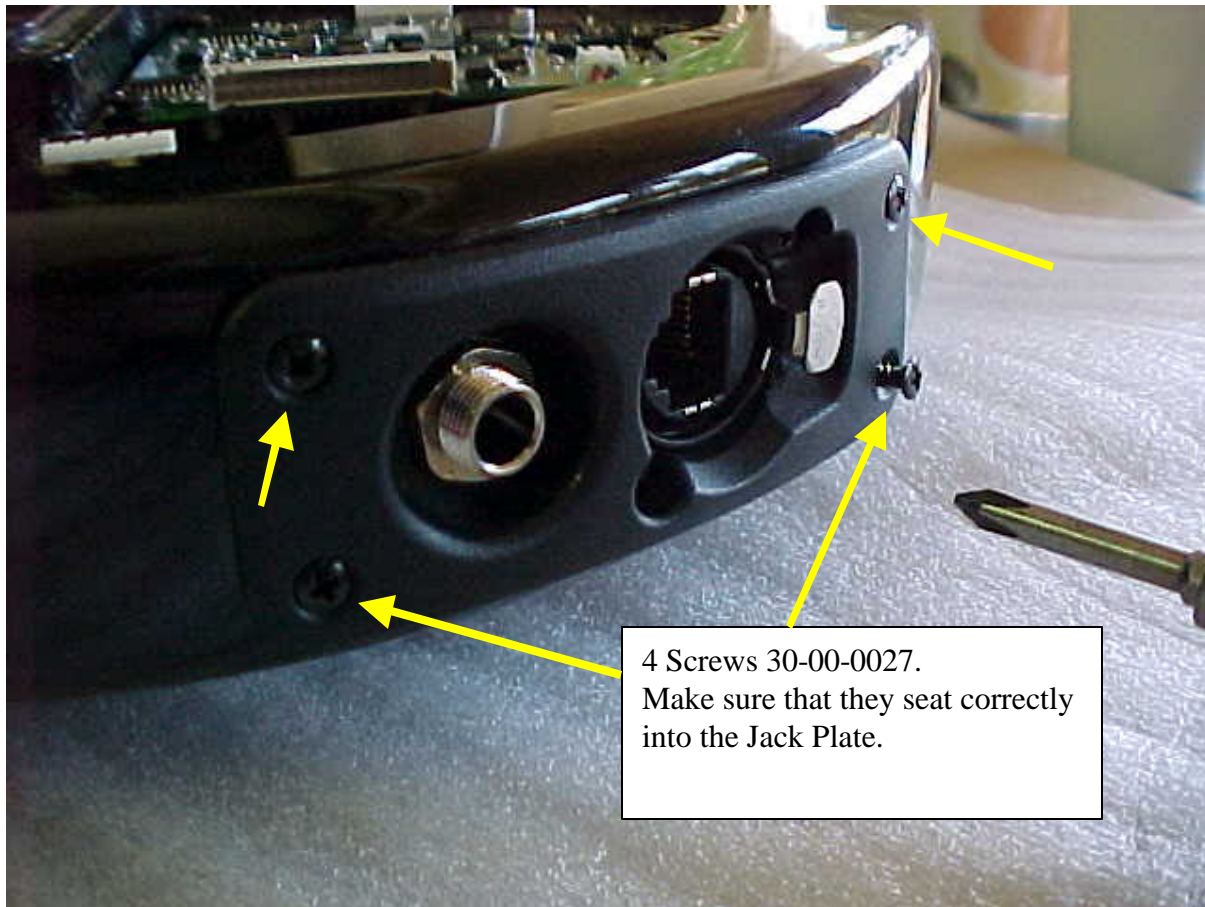

Pots, & 5 Way Switch Installation

1) Position 5 Way Selector switch as shown below, and from the front of the guitar, attach it using 2 #30-00-0022 Screws. (torque to 6 in/lbs).

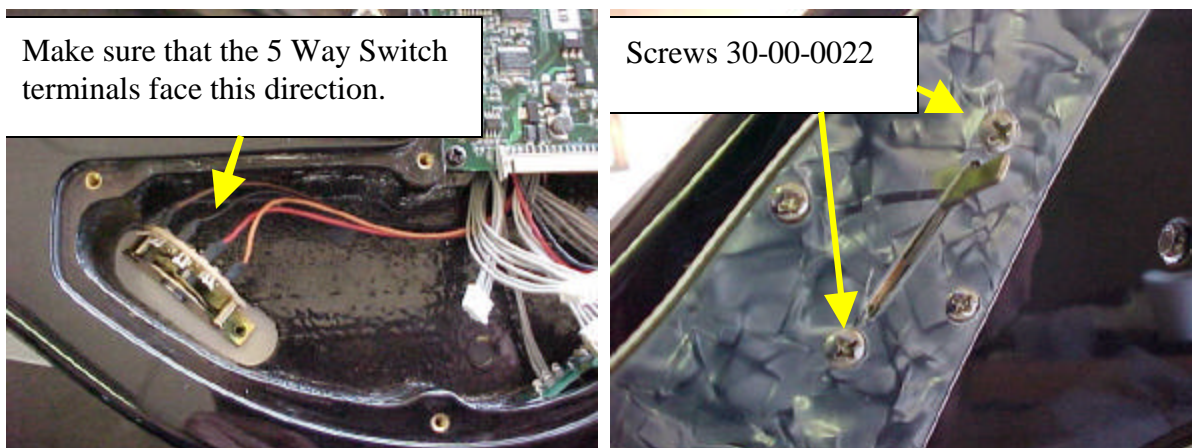

2) Install Pots as shown below.

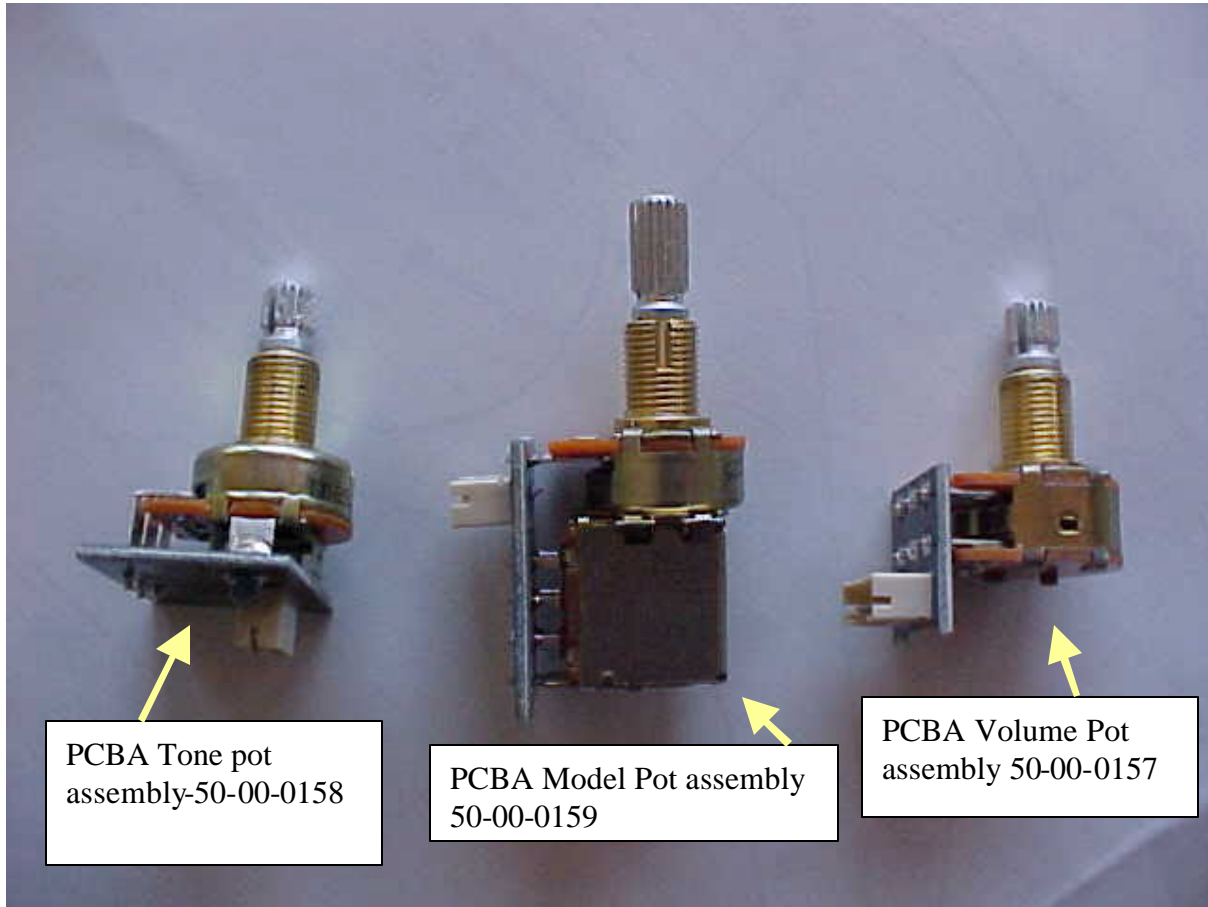

- a) Volume Pot assembly 50-00-0157 – Connect 6 Pin Cable to Header. Support the PCB whilst plugging this in to prevent damage to any components. Fig (1). NOTE: make sure that the cables are not tangled in any way, and that this cable can be dressed correctly.
- b) Assemble into guitar body as shown in Fig (2).

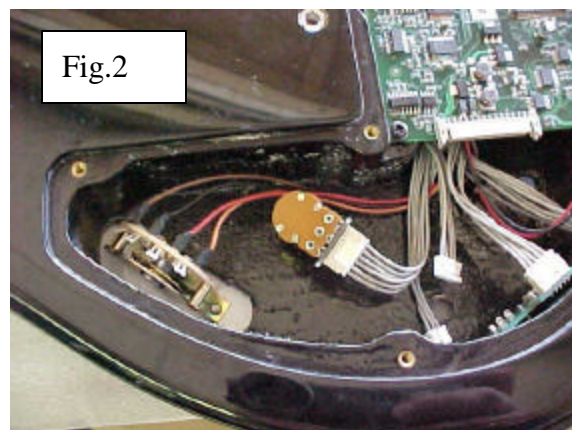
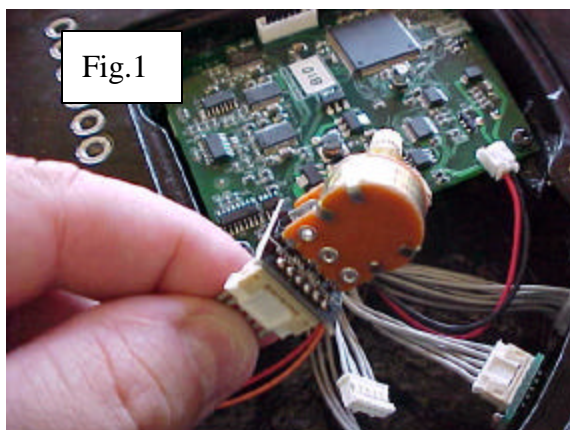

Pots, & 5 Way Switch Installation Cont'd....

- c) Model Selector Pot assembly 50-00-0159 – Connect 5 Pin cable to header. Support the PCB whilst plugging this in to prevent damage to any components. Fig (3). NOTE: make sure that the cables are not tangled in any way, and that this cable can be dressed correctly.
- d) Assemble into guitar body as shown in Fig (4).

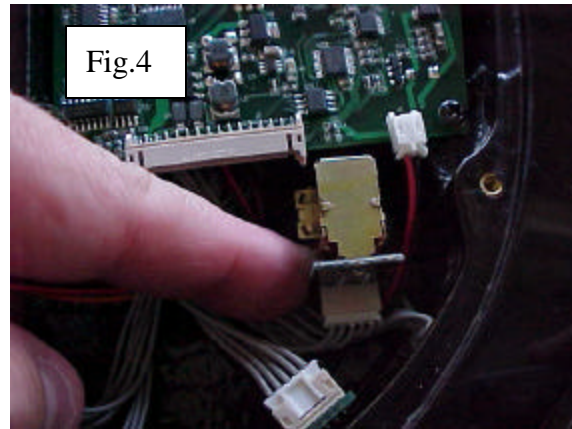
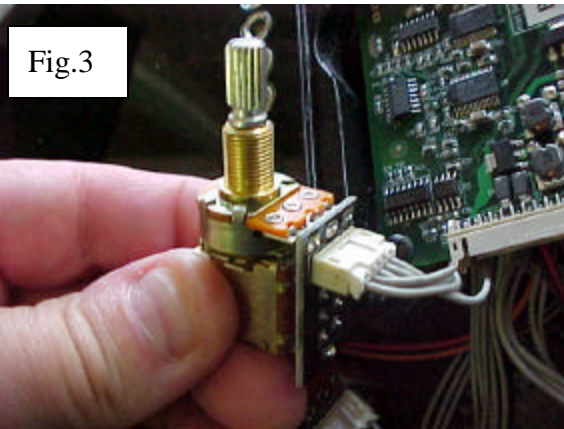

- e) Tone Pot Assembly 50-00-0158 – Connect 3 Pin cable to header. Support the PCB whilst plugging this in to prevent damage to any components. Fig (5). NOTE: make sure that the cables are not tangled in any way, and that this cable can be dressed correctly.
- f) Assemble into guitar body as shown in Fig (6).
- g) Assemble 32 Pin cable header to main PCB (Fig.7).

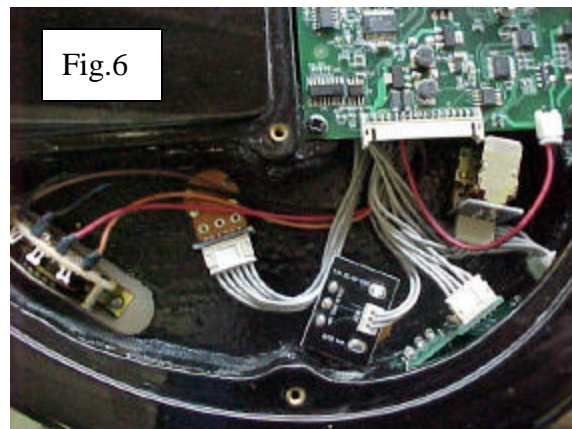
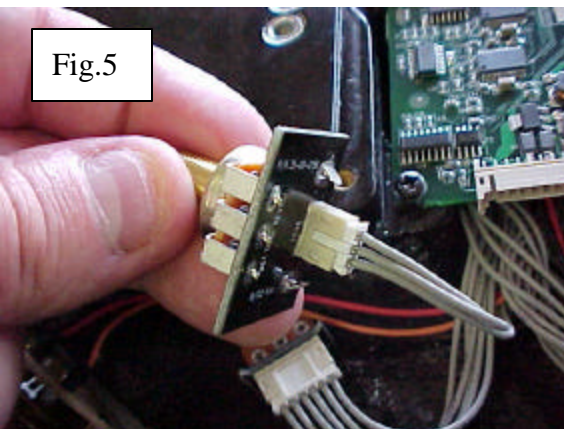

Pot Installation – cont...

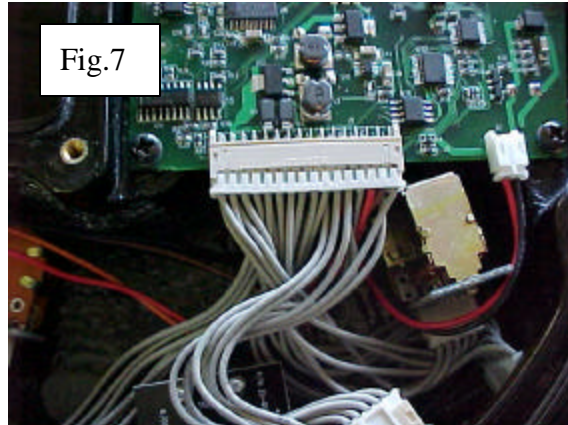

- h) Secure volume pot and tone pot with hex nuts & washers (Supplied with pots). Tighten to 6 in/lbs torque.
- i) Secure Model Select pot (Line 6 P/N 50-00-0159) as shown in illustration below. Use special nut driver, to avoid bending the select spring tabs. Torque 6 in/lbs.

NOTE :

- a) Both Model Indicator (30-51-0112) and Model spring select (30-51-0121) have positioning “keys”, that align them in the Pot thread keyway.
- b) Make sure that there are sufficient threads protruding, after the indicator washer & the select spring washer are in place, for the nut to get sufficient engagement. (ideally 3 threads – see fig.X, fig.Y)

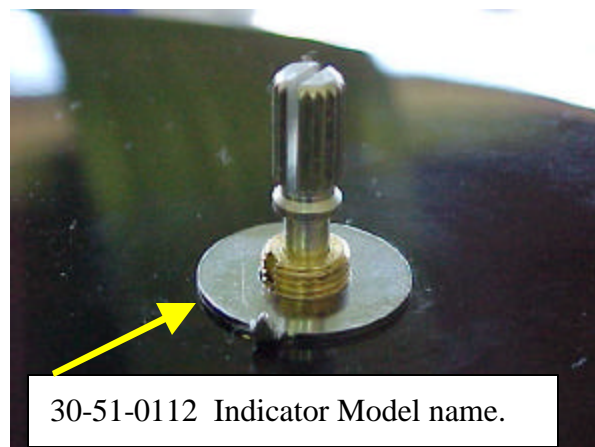

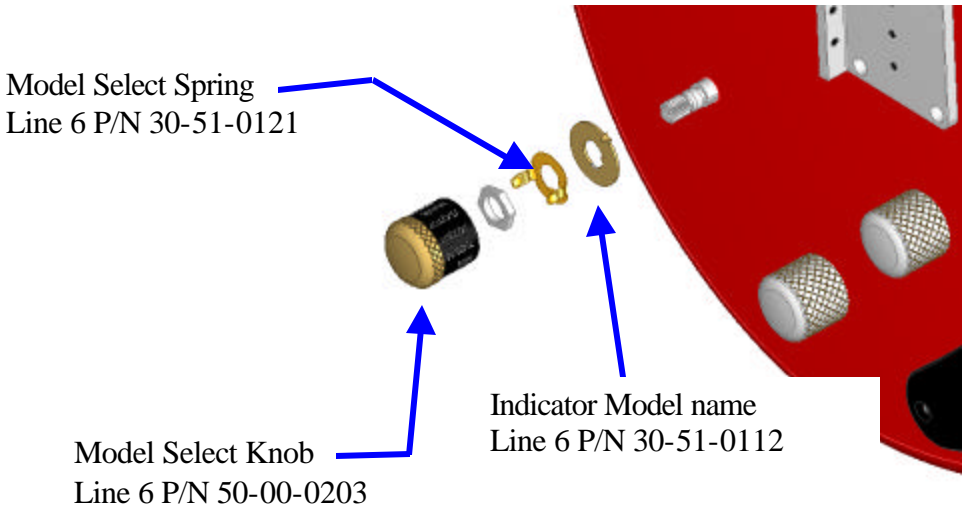
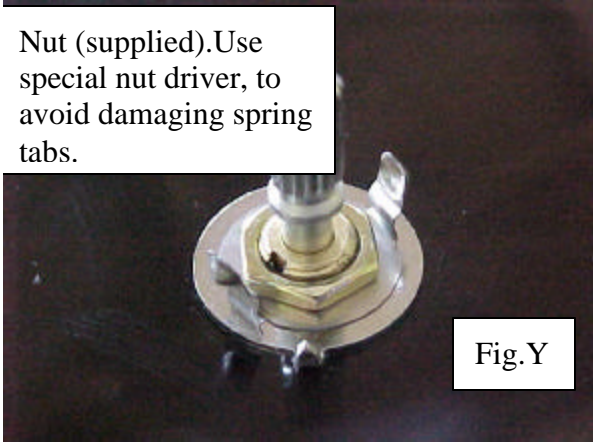
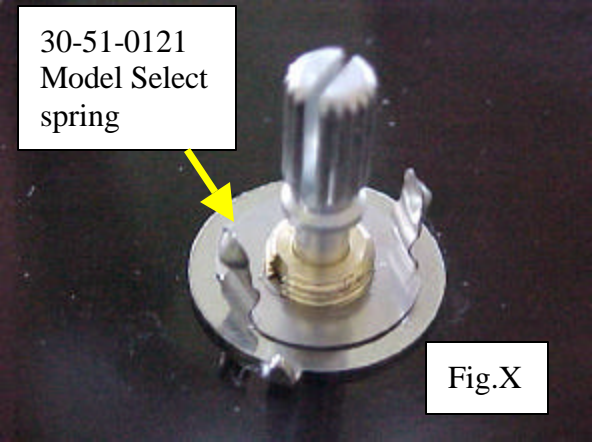

- j) Apply a small amount of lubricant on to the inner “rack” of the knob (50-00-0203). Use “Hasco Brand, Glacier FM Grease” or equivalent, using a Q tip or similar.

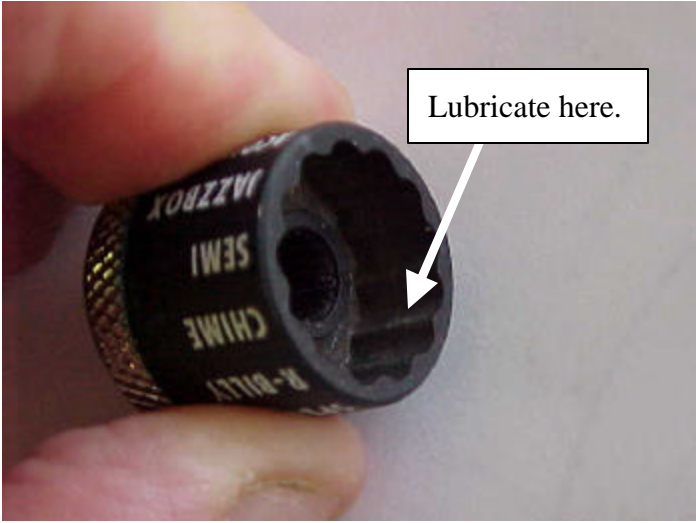

- k) Install Model select knob (50-00-0203), by turning the model pot completely counter-clockwise (until it hits the stop position), and aligning “CUSTOM” position on the knob, with the pointer on the Model name indicator. Therefore, at full counter-clockwise position, the Model reflected should be “CUSTOM”. (See photo below). Push knob onto shaft until fully seated.



- l) Install 5 Way selector switch knob #30-45-0004, onto 5 way Switch actuator, as shown below. Make sure it is pressed on all the way.

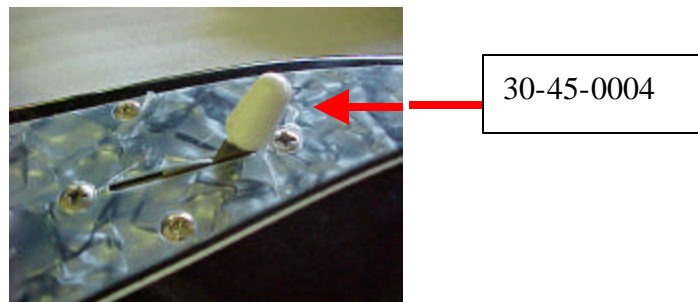

- m) Install Knobs (#30-45-0002). Ensure that they are fully seated on the shaft. When properly installed, there should be approx 0.040” gap between the bottom of the knob, & the guitar body.

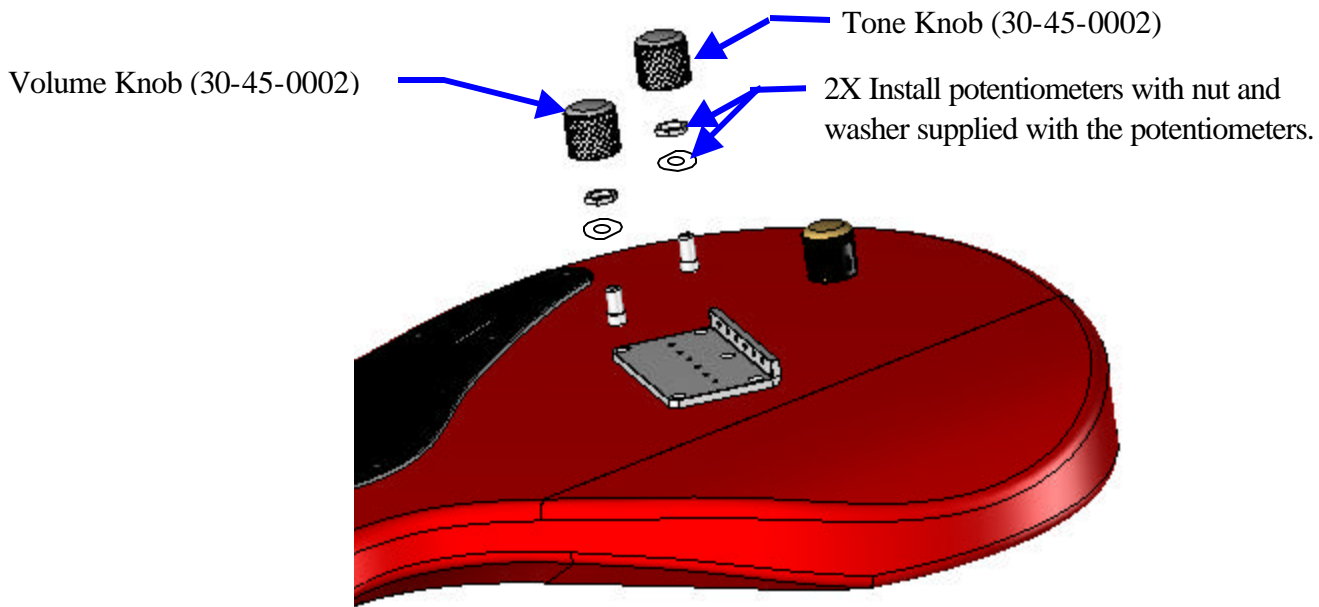

- n) Apply UPC barcode label (40-25-0101), to **inside** surface of cover plate.
- o) Install Cover plate, using 6 Screws (30-00-0031)- Fig.8. Torque 4 in/lbs.

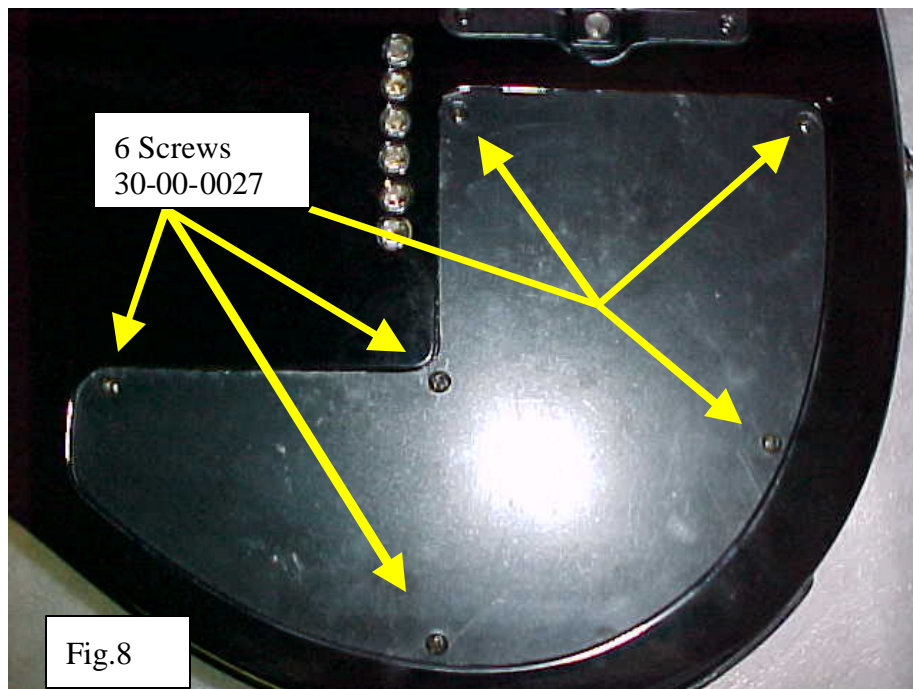

- p) Tape 2nd UPC label (40-25-0101)- leaving backer paper on, to edge of battery cover plate. (This is for the shipping box).
- q) Install Knob function overlay # 30-42-0001 over knobs. This should be applicable & removable without removing the knobs. (picture shows part in place without knobs installed - reference only)



r) Apply Sticker #40-25-0200 to Battery door plate, as shown.

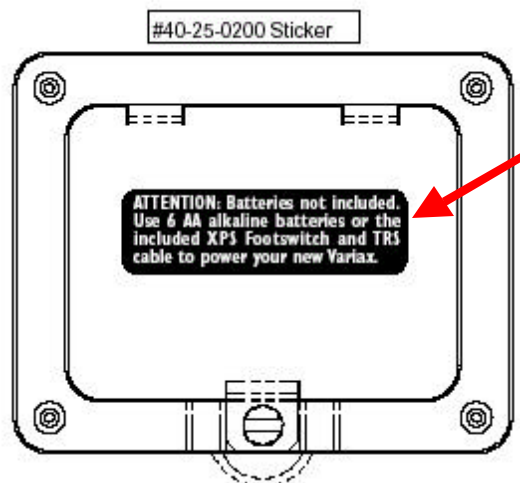

s) Apply Sticker #40-25-0500 on top of the protective film of the back plate, as shown.

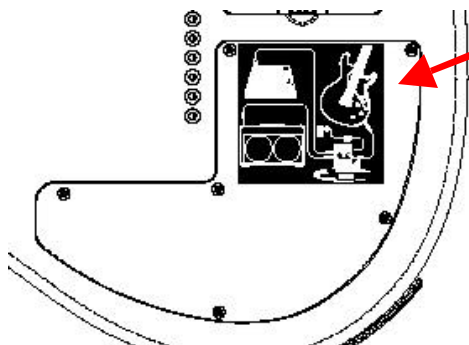

Upload Software.

- 1) Follow software upload & test procedure.
- 2) Install protective cap (Line 6 P/N 30-75-0013) over RJ45 jack after Jack Plate Assembly installation.

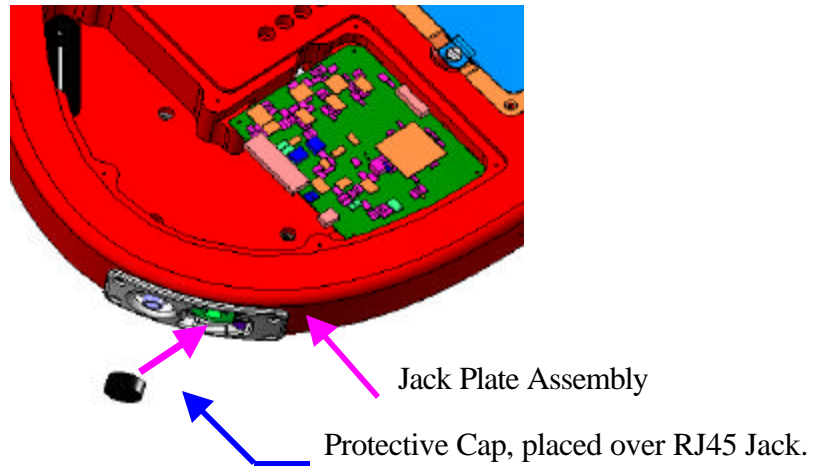

- **Follow *Guitar Set-up Procedure*.**
- **Final Inspection & clean/polish.**
- **Pack into Gigbag #40-20-0000. (Follow packing procedure).**
- **Pack guitar & Accessories. (Follow packing procedure).**

Pack-out list.

- 1) **99-xxx-0105 Variax (color & LH/RH).....1 per.**
- 2) **40-20-0000 Gig Bag Black MG11 per.**
- 3) **11-32-0000 XFMR PX2 120VAC/60Hz US...1 per.**
or **11-32-0004 XFMR PX2 220-240VAC/50-60Hz AU**
or **11-32-0003 XFMR PX2 220-240VAC/50-60Hz EU**
or **11-32-0001 XFMR PX2 100VAC/50-60Hz JA**
or **11-32-0002 XFMR PX2 220-240VAC/50-60Hz UK**
- 4) **21-34-0027 Cable TRS guitar 18ft lg.....1 per.**
- 5) **40-00-0007 Manual users MG11 per.**
- 6) **40-03-2000 Card Registration universal.....1 per.**
- 7) **40-20-0011 bag plastic 10x16 2 mil.....1 per.**
- 8) **40-25-0013 Label, battery specs.....1 per.**
- 9) **40-25-0020 Label inspection quality.....1 per.**
- 10) **40-25-0101 Label Barcode S/N 2 panel.....1 per.**
- 11) **50-00-0148 A/B switch power supply.....1 per.**

THE INFORMATION CONTAINED IN THIS DRAWING IS THE SOLE PROPERTY OF LINE 6, INC. ANY REPRODUCTION IN PART OR WHOLE WITHOUT THE WRITTEN PERMISSION OF LINE 6, INC. IS PROHIBITED.

REVISIONS			
REV.	DESCRIPTION	APPR.	DATE
A	INITIAL RELEASE, SEE ECO 0211310	SGW	2/5/21

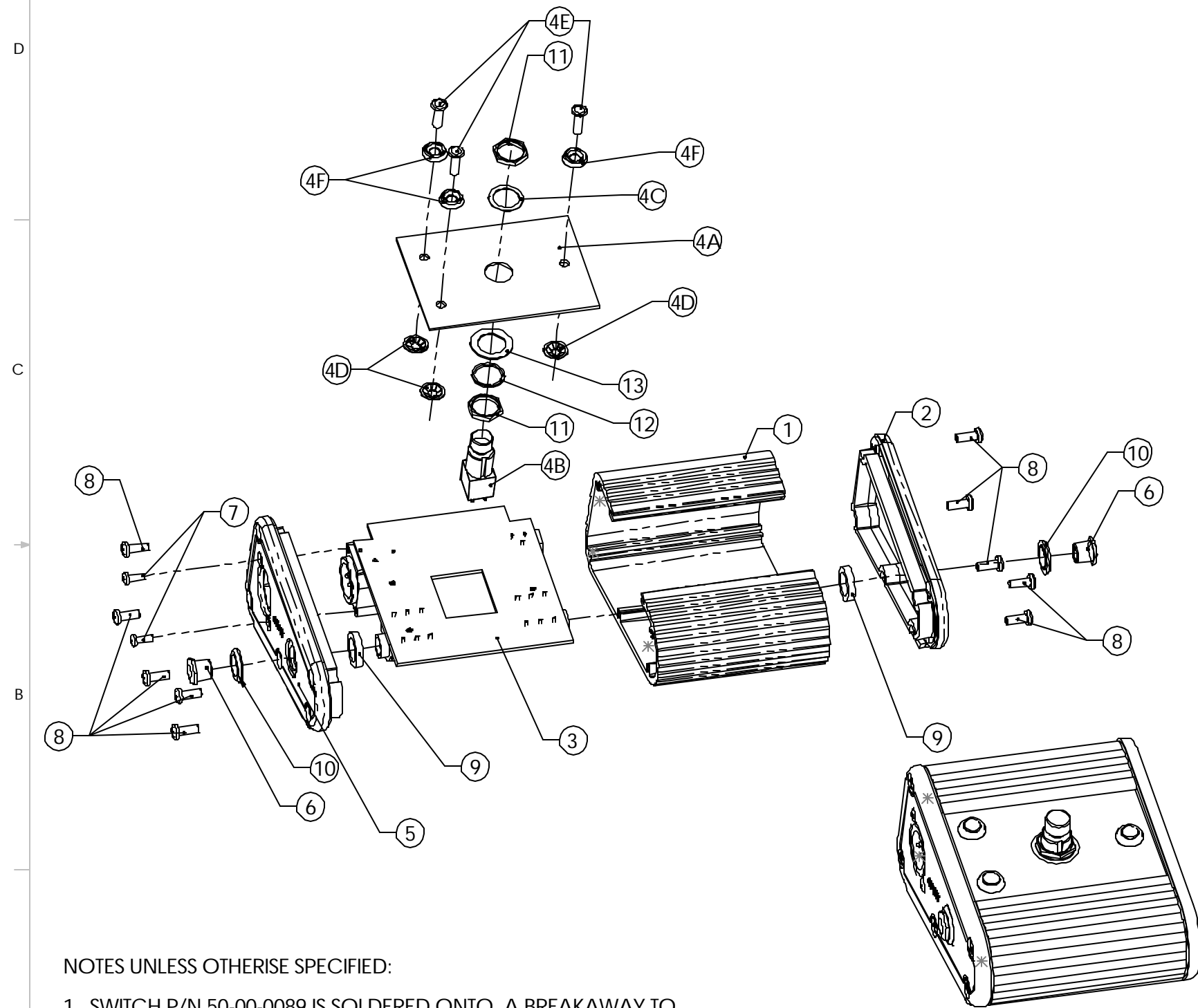

ITEM	QTY	LINE6 PART NO	DESCRIPTION
1	1	30-51-0114	EXTRUSION, BREAK OUT BOX
2	1	30-27-0047	ENDCAP, INPUT
3	1	50-00-0138	PCBA, MG1
4A	1	50-00-0193	ART ASSY, COVER
4B	1	50-00-0089	FOOT SWITCH
4C	1	30-03-0009	WASHER NI .475" X .623" .020"THICK
4D	3	30-06-0008	PUSH RETAINER 4MM SHAFT
4E	3	30-27-0038	LIGHTPIPE DIVERGE
4F	3	30-03-0014	WASHER, FINISHING #6
5	1	30-27-0046	ENDCAP, OUTPUT
6	2	N/A [INCL JACK ASSY]	NUT, FINISHING - 1/4 JACK
7	2	30-00-4250	SCR, SH METAL, PN HD PH #4 X .250
8	10	30-00-1632	SCR 6-32 X 3/8 PNH PHH TAP TITE BLK
9	2	30-15-0004	SPACER, WASHER
10	2	N/A (INCL JACK ASSY)	WASHER, PLASTIC, 1/4 JACK
11	2	N/A (INCL SWITCH ASSY)	NUT, HEX, M1, THIN
12	1	N/A (INCL SWITCH ASSY)	WASHER, LOCK, 12 MM THIN
13	1	N/A (INCL SWITCH ASSY)	WASHER, PLASTIC

NOTES UNLESS OTHERWISE SPECIFIED:

- SWITCH P/N 50-00-0089 IS SOLDERED ONTO A BREAKAWAY TO PCBA P/N 50-00-0138 DURING INITIAL PCBA FABRICATION (BREAKAWAY NOT SHOWN). THIS BREAKAWAY IS ELECTRICALLY CONNECTED TO PCBA P/N 50-00-0138 VIA RIBBON CABLE P/N 21-30-0011 SOLDERED TO THE PCBA ASSY DURING FABRICATION.

COMPLETE ASSEMBLY REFERENCE

SPECIFICATIONS		PARTS LIST	
MATERIAL	SEE BOM	APPROVALS	DATE
MATERIAL COLOR	N/A	DRAWN	01-09-25
FINISH	SEE BOM	CHECKED	2/5/18
FINISH COLOR	N/A	RESP ENG	2/5/18
		EE ENG	--
		MFG ENG	--
UNLESS OTHERWISE SPECIFIED		CAD GENERATED DRAWING, NO MANUAL UPDATES	
A. ALL DIMENSIONS AND TOLERANCES IAW ANSI Y14.5, 1982		PARTS LIST	
B. UNBRACKETED DIMENSIONS ARE MILLIMETERS			
C. BRACKETED DIMENSIONS ([]) ARE INCHES		29501 Agoura Road Agoura Hills, CA 91301 voice: 818-575-3600 fax: 818-575-3607	
D. TOLERANCES ARE MATERIAL DEPENDANT AS LISTED BELOW:		ASSY COMPLETE - BREAKOUT BOX	
METALS AND ELECTRICAL:	.X ± 0.3 [.XX ± .01]	SIZE	PART NUMBER
PLASTICS:	.XX ± 0.13 [.XXX ± .005]	B	50-00-0148
WOOD:	.X ± 0.8 [.XX ± .03]	SCALE	1:1
	.XX ± 0.38 [.XXX ± .015]	DO NOT SCALE DRAWING	REV. A
ANGULAR TOL. (ALL MATERIALS) ± .5°		PROJECT NAME	MG1
THIRD ANGLE		SHEET 1 OF 1	

Variac

Pilot's Handbook

Before using your Variax you should read these Important Safety Instructions. Keep these instructions in a safe place.

1. Obey all warnings in this Pilot's Handbook.
2. Do not place near heat sources, such as radiators, heat registers, or appliances which produce heat.
3. Guard against objects or liquids.
4. Power the XPS Footswitch only with the included PX-2 Power Supply or equivalent.
5. Connect the PX-2 Power Supply only to AC power outlets rated 100-120V or 230V 47-63Hz (depending on the voltage range of the included power supply).
6. Do not step on power cords. Do not place items on top of power cords so that they are pinched or leaned on.
7. Unplug your Variax and XPS Footswitch when not in use for extended periods of time.
8. Do not perform service operations beyond those described in the Variax Pilot's Handbook. Repairs and service operations beyond the scope of those in the Pilot's Handbook should be performed only by qualified service personnel.
9. Prolonged listening at high volume levels may cause irreparable hearing loss and/or damage. Always be sure to practice "safe listening."

Your Variax should include these accessories:

Gigbag, XPS Footswitch, PX-2 Power Supply, TRS Cable, 1.5mm Allen wrench, 4mm Allen wrench

WARNING: To reduce the risk of fire or electric shock, do not expose this appliance to rain or moisture.

CAUTION: No user-serviceable parts inside. Refer servicing to qualified service personnel.

CAUTION: This equipment has been tested and found to comply with the limits for a Class B digital device pursuant to Part 15 of FCC Rules. Operation is subject to the following two conditions: (1) This device may not cause harmful interference, and (2) this device must accept any interference received, including interference that may cause undesired operation.

Please Note:

Line 6, Variax, POD, Vetta and the Line 6 and Variax logo are trademarks of Line 6, Inc. All other product names, trademarks, and artists' names are the property of their respective owners, which are in no way associated or affiliated with Line 6. Product names, images, and artists' names are used solely to identify the products whose tones and sounds were studied during Line 6's sound model development for this product. The use of these products, trademarks, images, and artists' names does not imply any cooperation or endorsement.

Table of Contents

Welcome to Variax 1-2

Basic Operations..... 3-6

Connections

Battery Power

XPS Footswitch Power

XPS Footswitch Direct Out

Controls..... 7-9

Controls

Build a Custom Guitar

The Guitars of Variax..... 10-20

General Notes About the Models

Pickup Numbering

Model Descriptions

Care and Maintenance 21-22

Neck Relief Adjustment

Intonation Adjustment

Action Adjustment

Customer Service 24

Warranty Information..... 25

Welcome to Variax

Thanks for buying a Variax and joining us in our quest to apply the miracle of modern technology to the pursuit of great guitar tone. You now own detailed models of some of the most distinctive electric and acoustic guitars of all time—all wrapped up in a single comfortable and highly-playable instrument with a style all its own.

How does it work?

How do we get all of these sounds in a guitar that doesn't even have any visible pickups? We use piezo bridge pickups to capture each individual string's vibrations, and process the signals through software algorithms that capture the physical and electronic properties of the guitars that we've modeled.

This process dynamically alters Variax's own natural string vibrations to match the modeled instrument's unique tonal characteristics. That means there's no delay caused by having to detect a pitch and turn it into a MIDI note, and there's also no issue with tracking bends, hammer-on's, pull-off's, slides or any other techniques that are a part of your style. Plus, since Variax delivers its uncannily accurate sounds without the use of traditional magnetic pickups, it isn't susceptible to hum from fluorescent lights or computer monitors.

How did we manage to capture the tonal souls of all these classic guitars and spirit them into your Variax? We're glad you asked....

The Dream...

A couple of years before Variax was born, we turned our attention from the PODs, amps, and effects that we had been developing to take a fresh look at the guitar itself. Like all guitarists, we were intimately familiar with the unique pleasures that come from various instruments, and the great tonal variety that the world of electric and acoustic guitars has to offer. We wondered—could it be possible to capture a complete range of this tone in one single instrument? It was a daunting task, but then so was the idea of squeezing a whole collection of amps and effects into one little kidney bean shaped metal box. So we figured, why not give it a go?

What, we asked ourselves, might this marvel do? Well, for one thing, how about giving you access to an unprecedented number of certified classic sounds? How about letting you change from the sound of a 50's solidbody to the sound of a 60's electric 12-string as easily as using a pickup selector switch? How about the round, smoky tone of a hollowbody

archtop or the full-bodied resonance of a dreadnought acoustic? How about the raspy growl of a resonator, or the buzzing drone of a sitar?

The Journey

We knew our sounds would have to be amazingly accurate to meet the needs of discriminating guitarists, so we began an intensive research project into guitar physics. Like Frankenstein's lab, our own R&D facility became the site of round-the-clock investigations of the mysterious secrets of guitars' life force. We systematically examined every factor that contributes to each guitar's tone, and developed ways to measure the complex interactions of vibrating strings, resonant bodies, and magnetic pickups. Equally important, we developed ways to capture these interactions mathematically so we could get the same sounds from our own guitar-in-the-making.

As we refined our measuring and modeling techniques, we perfected a new, powerful hardware platform that could deliver our astoundingly accurate sounds. With the ability to switch sounds in the fraction of a second that it takes to slap a pickup selector switch to the next position. With less noise than a standard humbucker. That could be powered in a variety of ways. And, most importantly, that performs so flawlessly that you can forget it's even there.

Of course, a guitar that delivers such a vast array of tones really needs a look all it's own, so we started developing the look and feel of a guitar that could be used in any musical endeavor. We combined our innovative guitar modeling technology with a deceptively simple control layout and a comfortable, balanced body inspired by the best aspects of many of the guitars we had chosen to model.

With the body and brain of the Variax completed, it was time for us to create the soul. We auditioned a drool-inducing array of vintage instruments to find the ones with the most distinctive voices and personalities. We applied our painstaking measuring techniques to these specimens, and refined our models while constantly referring back to the originals for accuracy. When each model reached the point of not only sounding like the original, but also being as much fun to play, it was done.

The result of our labors? Variax. An entire guitar collection in a single instrument.

Basic Operations

Connections

You may have already noticed that the Variax has two output connectors: a familiar 1/4-inch jack and a second “mystery” jack protected by a rubber cap. This “mystery” connector will be the way you will add future upgrades and additional capabilities to your Variax, but all of the operations described in this manual will use the 1/4-inch output.

Guitar Cable to Amp

The simplest way to use the Variax is to connect it directly to your amplifier (or stompboxes) with a standard mono guitar cable.

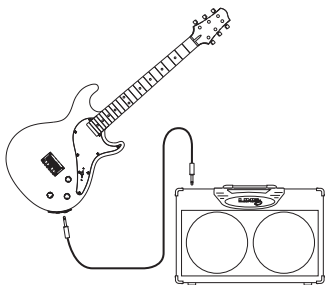

Battery Power

Of course, the electronics of the Variax will need power, so you'll have to install six AA cells in the on-board battery compartment. If you use fresh alkalines, you should get approximately 12 hours of continuous operation.

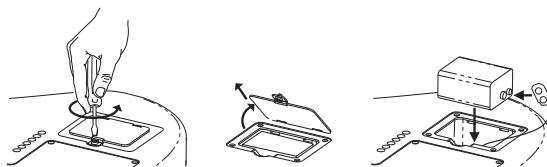

The battery will only be used when a mono cable is connected – the standard cable you'd use for a guitar. For longest battery life, always unplug your Variax when not in use.

NOTE: If you find yourself at a gig with no AA cells, you can unclip the plastic battery holder from the connector and substitute an ordinary 9V battery. This is only an “emergency” alternative, though, as the battery will only last 1 to 2 hours

XPS Footswitch Power

We realize that constantly changing batteries can be a real drag, so we included a more convenient option—the unobtrusive yet capable XPS Footswitch.

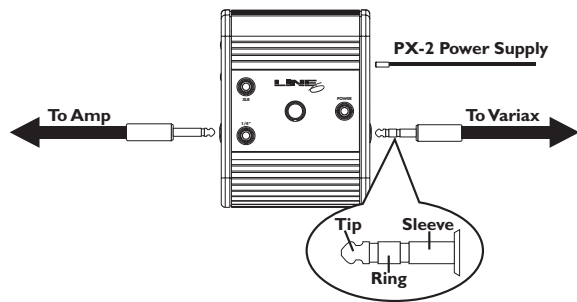

Powering your Variax with the XPS Footswitch is easy. Use the included TRS cable (meaning “tip-ring-sleeve” or also simply known as a “stereo” cable) to connect the Variax to the **INPUT** jack of the XPS Footswitch. Connect the PX-2 power supply to the XPS Footswitch **POWER** jack, and use a standard mono guitar cable to connect the XPS Footswitch’s **1/4" OUTPUT** to your amp or effects.

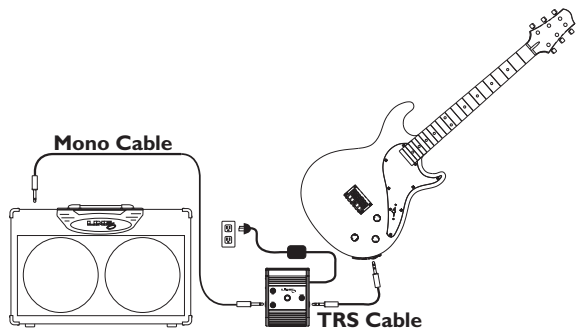

NOTE: If you have batteries installed in your Variax, they will be bypassed when using your XPS Footswitch.

XPS Footswitch Direct Out

But wait—there's more: Not content to merely provide power to the Variax, the eager to please XPS Footswitch also functions as a combination A/B switch and direct box.

Why, you ask? Well, the detailed acoustic models of the Variax may lack something when played through an electric guitar amplifier, because these guitar amps don't have the extended high frequency range of, say, an acoustic guitar amp with a tweeter, or a PA system. To insure that you get that all-important high end shimmer from your acoustic sounds, here's the drill:

Connect your guitar cable from the XPS **1/4" OUTPUT** jack to your amp and/or stompboxes. Connect the (balanced, +4 dBu compatible) **XLR OUTPUT** of your XPS to your PA system or acoustic amplifier with a standard mic cable.

When the **1/4"** indicator light is lit on your XPS Footswitch, you've got your guitar routed to your standard amp. Jump on the switch to light the **XLR** indicator light, and your signal will now be routed to the **XLR OUTPUT**, bathing you in the tonal glory of full frequency range sound!

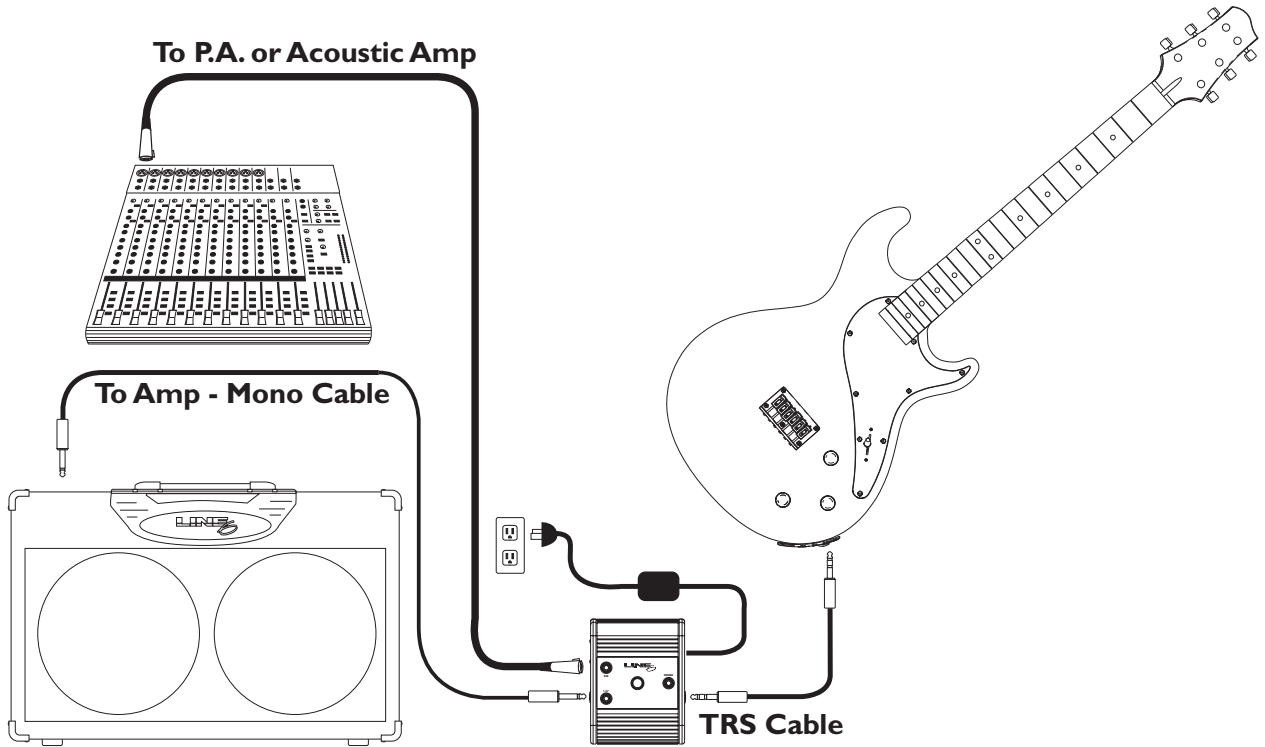

Controls

Let's start simple, and work up to the fancy stuff:

The **Volume Knob**, appropriately enough, controls the volume. You may notice that the taper (how fast you go from minimum to medium to maximum), as well as the volume control's effect on tone, will be slightly different for various models. For electric-based models, volume response and tone interaction duplicate the experience of the modeled instrument—maximizing model authenticity. For acoustic models, the Volume is simply a level control.

The **Tone Knob** controls—you guessed it!—the tone. As with the Volume, the response of this control varies to match the modeled electric instruments. For acoustic models, the Tone Knob will give you variations on the basic instrument sound.

When you get to the **Model Select Knob**, things start to get really interesting. Ten of its positions each offer 5 distinct sounds (representing one, two or even five different guitars), accessed by the Pickup Selector. For specifics on the models and variations available, see “**The Guitars of Variax**”.

The other two positions of the **Model Select Knob**— Custom 1 and Custom 2 save and recall your own custom setups. For the secrets of the Custom positions, see “**Build a Custom Guitar**”.

The **Pickup Selector** will work exactly as you expect it to on the electric models. In a three pickup model, like SPANK, all five positions will duplicate those on the modeled instrument. In more common two pickup models, positions 1, 3, and 5 will give you the characteristic sounds for those instruments— bridge pickup only, both pickups, and neck pickup only. The “in-between” positions (2 and 4) usually offer sounds from related guitars. After all, who can have enough variety?

When it comes to the acoustic models, the **Pickup Selector** offers 5 distinct instrument sounds, all a switch-flick away! The individual model descriptions in “**The Guitars of Variax**” section get down and dirty with the details.

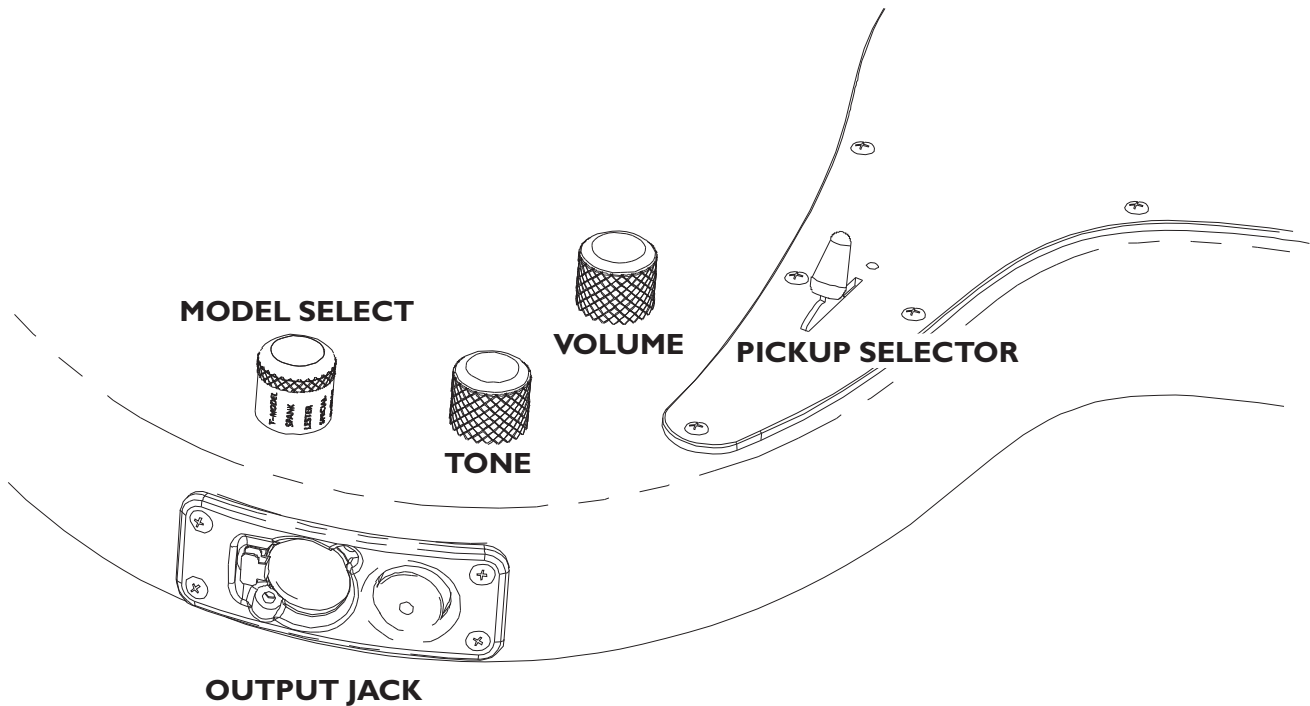

Build a Custom Guitar

To really take advantage of the range and versatility of the Variax, especially when performing, you need immediate access to your essential sounds. Use the custom banks of Variax's model knob to get your ten favorite tones ready for recall with a well-timed flick of your pinky.

You've got **CUSTOM 1** at the beginning of the Model Select rotation, and **CUSTOM 2** at the end. Each of these can store a different set of five of your favorite sounds. You could, for instance, put acoustic sounds in **CUSTOM 1**, and electric sounds in **CUSTOM 2**. Or load one up for your disco band, and the other for your polka gig.

Let's say you found a sound that you know you'll be coming back to again and again. Here's what you do:

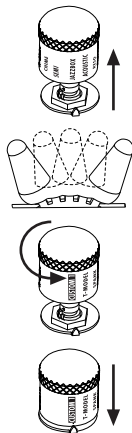

1. Pull up on the **Model Select Knob** to start the Save process
2. Flick the **Pickup Selector** to the position you want to save your sound to. (Moving the Pickup Selector while you're saving won't change the sound, only the save location.)
3. Rotate the **Model Select Knob** to the custom bank of your choice (**CUSTOM 1** or **CUSTOM 2**).
4. Press the **Model Select** knob down.

That's all there is to it. You've saved your sound to the current position of the **Pickup Selector** in the Custom Bank you've chosen. Now that you've got it all down, you can repeat these steps for the remaining nine positions. (Or not, if you like the ones we've already saved there for you.) And if your tastes change, you can Save over any of those ten custom variations as often as you like.

THE GUITARS OF VARIAX

General Notes About the Models

Each Variax model has five different variations available—one at each position of the **Pickup Selector Switch**. These five variations may all be based on the same guitar, two or three similar guitars, or, for the **ACOUSTIC** and **RESO** models, each variation may be based on an entirely different instrument.

For electric models, the **Volume** and **Tone** controls work like the ones found on the instruments we modeled. Rolling off the volume, for instance, will typically result in a darker sound. The output level of each model is based on the modeled instrument. Models with humbucking pickups, for example, will tend to be louder than those with single-coils.

For acoustic models, the **Volume** control acts as a simple level control. Since acoustic guitars don't have tone controls, we got to have some fun with Variax's **Tone** control with the acoustic models. Give it a spin to explore a varying range of tonal flavor for each model. To preserve the full range of the acoustic and resonator guitars, use the XLR output of the XPS Footswitch to send the signal directly to your mixer or acoustic amp.

Pickup Position Numbering

We've numbered the pickup positions in the manual starting with "bridge" (the position toward the bridge) as 1. Moving the pickup selector from there, you go through positions 2, 3 and 4 on your way to the "neck" position (the position toward the neck) which we label as number 5.

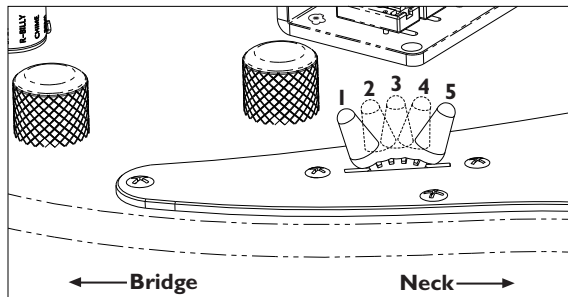

T-MODEL



Based on 1960 Fender Telecaster Custom

Leo Fender's Telecaster, originally known as the Broadcaster, was the first commercially successful solidbody electric guitar and has been in continuous production for over fifty years. A brilliant example of functional, efficient design, the Telecaster has been the guitar of choice for guitarists like Jeff Beck, Roy Buchanan, James Burton, Albert Collins, Danny Gatton, and Keith Richards.

Position 1: Bridge

Position 5: Neck

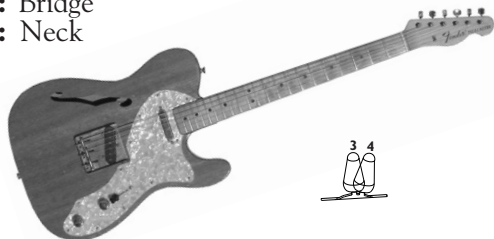

Based on modified 1968 Fender Telecaster

Players looking for more versatility from the workhorse Tele discovered they could get a much more powerful sound by combining the two pickups in series (as on a humbucking pickup).

Based on 1968 Fender Telecaster Thinline

Faced with the difficulty of obtaining lightweight ash, Fender introduced the Thinline model in 1967. The chambered body reduced the weight to about half that of a typical Tele of the time, while the traditional electronics were retained to deliver a variation of the trademark Tele sound.

Position 3: Bridge+Neck

Position 4: Neck

SPANK



Based on 1959 Fender Stratocaster

The curvaceous Stratocaster is further evidence of the genius of Leo Fender. Considered a radical departure at its introduction in 1954, the Strat soon eclipsed the popularity of its older sibling and became one of the most visible instruments in the formative years of rock and roll. The Stratocaster influenced electric guitar design more than any other single instrument and its distinctive comfort-contoured body, bolt-on neck, and versatile electronics have become industry standard features.

Our model takes one slight liberty; unlike the modeled instrument, the tone control works on the Bridge pickup, too. We trust that Leo won't mind.

- Position 1:** Bridge
- Position 2:** Bridge+Middle
- Position 3:** Middle
- Position 4:** Neck+Middle
- Position 5:** Neck

LESTER

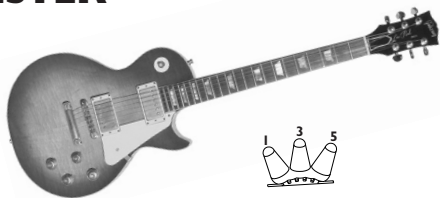

Based on 1958 Gibson Les Paul Standard

Gibson's first solidbody electric design was a collaboration with popular guitarist and recording pioneer Les Paul. Unlike the easy-to-manufacture Fender designs, the Les Paul retains the carved top and set neck construction of their hollowbody models. The original series was a commercial failure, however, and was discontinued in 1961. Influential musicians like Mike Bloomfield and Eric Clapton discovered the sweet sustain of a Les Paul through an overdriven amp. The resulting resurgence of popular interest led to its reintroduction in 1968.

We've modeled a 1958 version that features the coveted "P.A.F." pickups.

Position 1: Bridge

Position 3: Bridge+Neck

Position 5: Neck



Based on 1952 Gibson Les Paul "Goldtop"

The "Goldtop", nicknamed for its metallic gold finish, was the first model of the Les Paul series. Our version features a P-90 pickup in the bridge position.



Based on 1961 Gibson Les Paul Custom

In addition to its sophisticated ornamentation, this particular incarnation of the Les Paul Custom offers three P.A.F.'s. We've modeled the combination of bridge and middle pickups that set this Paul apart.

SPECIAL



Based on 1956 Gibson Les Paul Junior

The Les Paul Junior was introduced in 1954 as the budget member of the Les Paul Series. The body is a flat mahogany slab, and the electronics are simplified to include only a single P-90 in the bridge position. The meaty tone, light weight, and uncompromised playability made the Junior a favorite of Mountain's Leslie West.

Based on 1955 Gibson Les Paul Special

The Special was added to the Les Paul line in 1955 as an intermediate step between the utilitarian Junior and more luxurious Standard. The greater tonal options made possible by the second P-90 helped make the Special a favorite of reggae legend Bob Marley. Our model is based on the original single cutaway version.

Position 3: Bridge+Neck

Position 5: Neck



Based on 1976 Gibson Firebird V

The Firebird, introduced in 1963, was created with the help of Detroit automobile designer Ray Dietrich. Neck-through construction and Epiphone-style mini-humbuckers gave the Firebird a unique combination of good sustain and a biting, trebly sound—characteristics which made it a favorite of blues slide guitar legend Johnny Winter.

Position 2: Bridge

Position 4: Neck

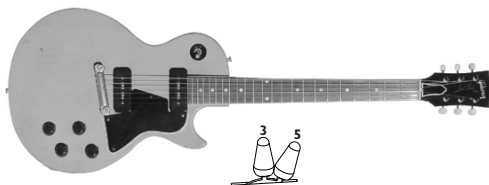

R-BILLY

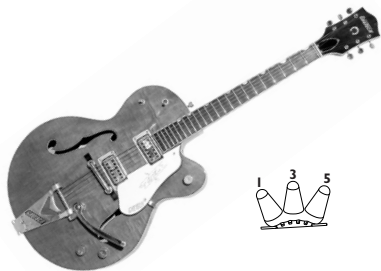

Based on 1959 Gretsch 6120

The 6120 was the first of several models that Gretsch developed with country guitar whiz Chet Atkins. The 6120 is usually associated with the “twangy” sounds of players like Duane Eddy, Eddie Cochran, and Brian Setzer, but Pete Townshend found his 6120 perfect for the crushing power chords of “Who’s Next.” This particular specimen is equipped with Filter’tron hum-canceling pickups designed by Ray Butts.

Position 1: Bridge

Position 3: Bridge+Neck

Position 5: Neck

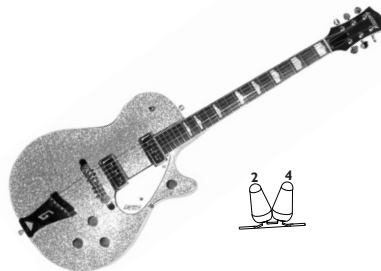

Based on 1956 Gretsch Silver Jet

Gretsch introduced a series of so-called Solid Body guitars in 1955 that included the Jet Fire Bird with a red top, the Duo-Jet with a black top, and the Silver Jet with — you guessed it — a silver top. Though called a solidbody by Gretsch, the Jet series actually has internal hollow chambers that contribute to its light weight and resonant tone. The black version (the Duo-Jet) was the favorite instrument of Cliff Gallup, original lead guitarist for Gene Vincent’s Blue Caps. The guitar we modeled had DeArmond pickups and a Melita bridge.

Position 2: Bridge

Position 4: Neck

CHIME

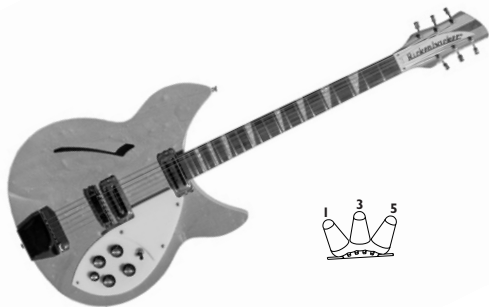

Based on 1968 Rickenbacker 360

Though overshadowed by the success of the 12 string, the 6 string versions of Rickenbacker's stylish models continue to be popular with players looking for something a bit out of the ordinary, like Ed O'Brien of Radiohead.

Position 1: Bridge

Position 3: Bridge+Neck

Position 5: Neck

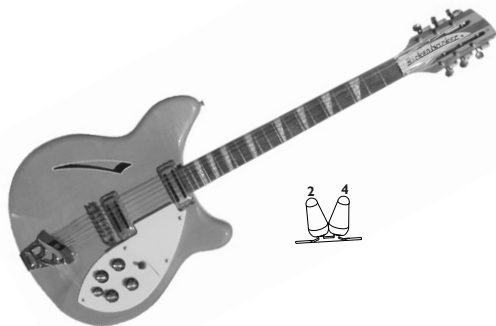

Based on 1966 Rickenbacker 360-12

Popularized by George Harrison in the Beatles and Roger McGuinn in the Byrds, the distinctive jangle of 12 string Rickenbackers was a significant part of the 60's rock sound. Our Ricky has the original "toaster" pickups.

Position 2: Bridge

Position 4: Neck

SEMI



Based on 1961 Gibson ES-335

The Semi-hollow Gibsons were conceived as a blend of the tone and sustain of a solidbody with the balance and aesthetics of a hollowbody. The “woody” tone of these guitars made them popular with Jazz artists like Larry Carlton and Blues greats like B. B. and Albert King. Our model is based on a 1961 dot neck, with P.A.F.’s and a stop tailpiece.

Position 1: Bridge

Position 3: Bridge+Neck

Position 5: Neck



Based on 1967 Epiphone Casino

Gibson acquired former rival Epiphone in 1957 and began producing Epiphone guitars in its Kalamazoo factory. Some of the models developed for Epiphone were variations on then-current Gibson models. The Casino, for example, was essentially a Gibson ES-330. John Lennon was particularly fond of the Casino, and continued to record with it long after the breakup of the Beatles.

Position 2: Bridge

Position 4: Neck

JAZZBOX



Based on 1957 Gibson ES-175

Gibson added a sharp “Venetian” cutaway and a slightly fancier fingerboard to the budget ES-125 model to create the ES-175 in 1949. With the addition of a second pickup in 1953, and humbucking pickups in 1957, the ES-175 quickly became a popular and enduring choice for electric jazz guitarists.

Position 1: Bridge

Position 3: Bridge+Neck

Position 5: Neck



Based on 1953 Gibson Super 400

By the end of the 1940's, changing musical styles found premium archtops like the L-5 and Super 400 to be lacking in volume. By simply adding the pickups and controls developed for its early electric guitars, Gibson created the electric version of the Super 400 in 1951. Our model is based on the early version with P-90's. Check out Scotty Moore (and Elvis) playing a Super 400 in the '68 Comeback Special.

Position 2: Bridge

Position 4: Neck

ACOUSTIC



Based on 1959 Martin D-28

The D-28 is generally considered the definitive Martin flat-top. The Dreadnought (or “D”) body combined with rosewood back and sides produces a full sound ideal for flatpicking.



Based on 1970 Martin D12-28

In 1970, Martin added 6 more strings to the successful D-28 to capitalize on then-current folk music trends.



Based on 1967 Martin O-18

The smaller “parlor” sized body with mahogany back and sides has a balanced tone ideal for fingerstyle playing.



Based on 1966 Guild F212

Guild’s Jumbo-bodied 12-strings offered players the elusive combination of volume and clarity. We’ve modeled one of the simpler models in the line, the F212 with mahogany back and rims.



Based on 1995 Gibson J-200

Easily identified by its impressive size and ornamentation, the J-200 was often seen played by flashy country and western artists and was a later favorite of Elvis Presley.

RESO



Based on 1935 Dobro Model 32

Though most Dobros were wood-body instruments, a few were made from other materials. This model is based on an unusual specimen with an all-aluminum body that emphasizes midrange.



Inspired by the Coral Sitar

Designed in conjunction with session guitarist and electronics experimenter Vinnie Bell, the Coral Sitar offered guitarists the ability to get the buzz and drone of a sitar without having to learn a new instrument. On this model, the tone control changes the level of the drone strings.



Based on 1965 Danelectro 3021

Danelectro managed to make great sounding guitars from Masonite and lipstick tubes. Our model is based on a 3021 (Jimmy Page's favorite Dano) with both pickups active.



Inspired by the Gibson Mastertone Banjo

The Mastertone series was introduced in 1925 and quickly became the definitive Bluegrass banjo, due in no small measure to a long-standing association with virtuoso Earl Scruggs.



Based on 1928 National Tricone

The first National guitar was the Tricone (or "Tri-Plate") introduced in 1926. The Tricone used three 6-inch cones mechanically coupled to the bridge to amplify string vibrations. The Tricone has a smoother sound than later, single-cone resonators and was the primary instrument of Sol Hoopii, influential Hawaiian steel guitarist.

Care and Maintenance

Only a few simple measures are required to keep your Variax looking and performing like new.

- After playing, wipe down the guitar and strings with a clean, soft cloth.
- Change strings when they become discolored or the guitar begins to sound dull.
- Occasionally clean the fingerboard surface with lemon oil and the painted surfaces with guitar or furniture polish.

Neck Relief Adjustment

Depending on where you live, seasonal temperature and humidity variations may make it necessary to adjust the neck relief of the Variax. If you find that your Variax suddenly starts buzzing or is generally difficult to play, it may be time for this kind of adjustment. To check the neck relief, press the high E string to the first fret with your left hand, and press the same string to the last fret with your right hand. While holding the string at both points, check the point where the E string passes over the 10th fret. If the string is touching the fret, or if there is more space under the string than the thickness of a thin pick, it's time to adjust the neck.

If you are familiar with this kind of adjustment, remove the truss rod cover and use the supplied Allen wrench to adjust the truss rod. If the string was touching at the 10th fret (too little relief), turn the rod counterclockwise. If the gap was too great (too much relief), turn the rod clockwise. In both cases, make small adjustments and check the relief as you go. Never force the rod to turn—excessive tightening can damage your Variax. If you are unfamiliar or uncomfortable with this kind of adjustment, ask your local guitar shop to refer you to a qualified guitar tech.

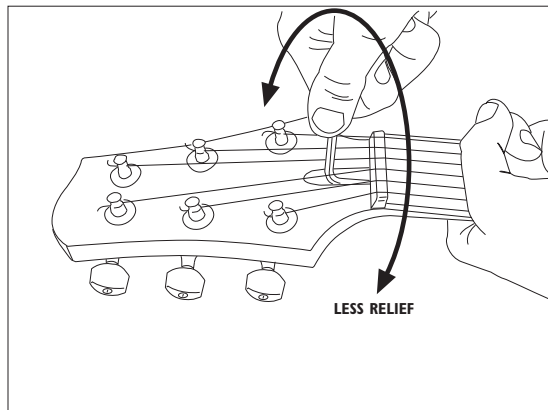

Intonation Adjustment

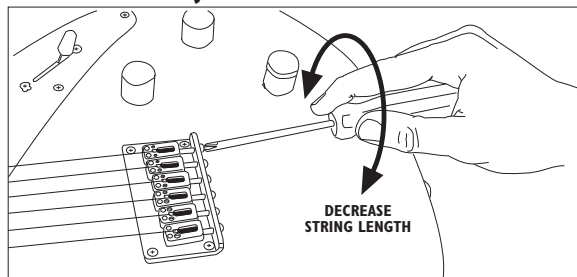

Intonation is adjusted by changing the position of the bridge saddles, which changes the length of the vibrating strings. The saddle position of each Variax is adjusted before it leaves the factory, but changing string brand, gauge, or action can change the intonation. To adjust the intonation, you will need an accurate tuner and a screwdriver. For each string, tune the open string as close as possible to correct pitch, then fret that string at the 12th fret and check the pitch. (Make this adjustment while holding the guitar in playing position.) If the fretted note is sharp, the string length is too short—turn the adjust screw clockwise. If the fretted note is flat, the string length is too long. Turn the adjust screw counterclockwise. Make small adjustments and retune and check the pitch as you go.

Important Note: Never attempt to remove the bridge saddles. If any of the wires attached to the piezo elements are broken or damaged, the Variax will not function properly.

Action Adjustment

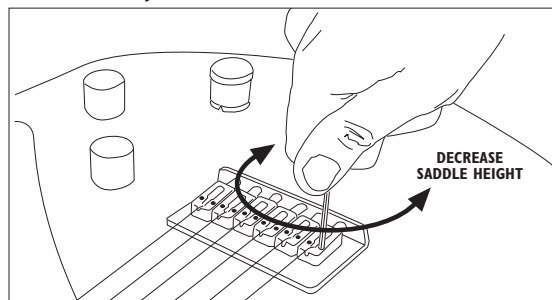

The Variax leaves the factory adjusted for playability across a wide range of playing styles. The bridge saddle height can be adjusted to optimize playability for a particular style. If you are familiar with this kind of adjustment, use the supplied Allen wrench to raise or lower the bridge saddle screws as shown. As with neck adjustment, if you are unfamiliar with this kind of adjustment, ask your local guitar shop to refer you to a qualified guitar tech.

Customer Service

Before contacting the Line 6 Customer Service team, please take the time to look through this publication to see if it can answer your questions. Additional helpful information is on the Support page of the Line 6 web site (www.line6.com), including the searchable FAQTRAQ system which is often the fastest and easiest way to get answers.

If you need to talk to an actual human on the Line 6 Customer Service team by phone, it will generally help to take some notes for yourself before you call, to insure that you remember everything you want to ask about. In the USA or Canada, you can contact Line 6 at (818) 575-3600, 8AM to 5PM Monday through Friday (Pacific Time). Outside the USA and Canada, please contact your distributor directly to arrange service. The list of Line 6 distributors is available on the Internet at www.line6.com.

To obtain factory service:

If a member of the Line 6 Customer Service Team determines that your Variax needs to be sent to Line 6 for service, you will be given a return authorization (RA) number. Products returned without an RA number will be returned to you at your sole expense. Pack the product in its original shipping carton and attach a description of the problem along with your name and a phone number where Line 6 can contact you if necessary. Ship the product insured and freight prepaid to:

Line 6 Customer Service
6033 De Soto Avenue
Woodland Hills, CA 91367

Line 6 Warranty Policy

Line 6, Inc. (hereinafter "Line 6") warrants that your new Line 6 instrument shall be free of defects in workmanship and materials for the lifetime of the product and that the electronics contained within the instrument (printed circuit boards, piezo saddles, potentiometers, etc.) shall be free from defects in workmanship and materials for a period of one (1) year from the original date of purchase. In addition, the accessories (carrying case, power supply, and footswitch) shall be free of defects in workmanship and materials for a period of one (1) year from the original purchase date. This warranty is extended to the original retail purchaser only and may not be transferred or assigned to subsequent owners. In order to validate your warranty, and as a condition precedent to warranty coverage hereunder, a copy of the original sales receipt must accompany all warranty requests. This warranty policy is valid only when a new Line 6 instrument is purchased from an Authorized Line 6 dealer. This warranty is subject to the following exceptions and/or limitations:

This warranty does NOT cover:

1. Any instrument that has been altered or modified so that the serial number, name, identification numbers or logos have been tampered with or are missing.
2. Instruments or accessories not purchased from an Authorized Line 6 dealer.
3. Standard maintenance and adjustment of the instrument, electronics and action. Standard adjustments and maintenance are the sole responsibility of the owner.
4. Any defects in the instrument or accessories that are caused by or are the result of a lack of maintenance or adjustment.
5. Any instrument or accessory that has been repaired, altered or modified by a repair facility that is not authorized by Line 6, or any repairs, alterations, or modifications, regardless of the origin, that Line 6 has not approved.
6. Any damages to the instrument or accessory that is a result of abuse, accident or misuse, as determined by Line 6 in its sole discretion.
7. Any issues regarding the tonal aspects of the instrument. Tone is a product of perception and therefore cannot be warranted. Issues regarding the authenticity or interpretation of the models used also cannot be warranted.
8. Damages (due to shipping or otherwise) to the instrument or accessories that relate to improper storage or transportation.
9. Any failures to either the instrument or accessories that are a result of exposure to extreme conditions (including, without limitation, humidity, sunlight, bodily fluids, unapproved cleaning solutions or solvents, temperature and/or adhesives).
10. Any failures to either the instrument or accessories that are a result of normal "wear and tear" (including, without limitation, strings, fret wear, finish damage, potentiometers and connectors, pick guard, bridge, machine heads, finger board and carrying case).

If you feel that you have a warranty issue, please contact Line 6 or your authorized Line 6 dealer or distributor. Line 6 may issue a Return or Repair authorization as needed. No instrument or accessory will be accepted at the Line 6 facility for repair without (i) prior receipt of your original sales receipt, (ii) proper authorization by Line 6 or an authorized Line 6 dealer or distributor, and (iii) a Return Authorization number. Line 6 will refuse shipment of any instrument that is received without the foregoing three (3) prerequisites. Line 6 will repair or replace your instrument at its sole discretion. Parts that are replaced under this warranty are warranted for ninety (90) days or the remainder of the warranty period, whichever is longer. Line 6 reserves the right to use reconditioned parts and assemblies as warranty replacements for authorized repairs. All shipping charges to any repair facility are the sole responsibility of the owner of the instrument or accessory. Line 6 reserves the right to update any unit returned for repair, and reserves the right to change or improve the design of the product at any time without notice. This is your sole warranty. Line 6 does not authorize any third party, including any dealer or sales representative, to assume any liability on behalf of Line 6 or to make any warranty for Line 6.

DISCLAIMER AND LIMITATION OF WARRANTY: THE FOREGOING WARRANTY IS THE ONLY WARRANTY GIVEN BY LINE 6 AND IS IN LIEU OF ALL OTHER WARRANTIES. ALL IMPLIED WARRANTIES, INCLUDING WARRANTIES OF MERCHANTABILITY AND FITNESS FOR ANY PARTICULAR PURPOSE, EXCEEDING THE SPECIFIC PROVISIONS OF THIS WARRANTY ARE HEREBY DISCLAIMED AND EXCLUDED FROM THIS WARRANTY. UPON EXPIRATION OF THE APPLICABLE EXPRESSED WARRANTY PERIOD (1 YEAR), LINE 6 SHALL HAVE NO FURTHER WARRANTY OBLIGATION OF ANY KIND, EXPRESS OR IMPLIED. LINE 6 SHALL IN NO EVENT BE LIABLE FOR ANY SPECIAL, INCIDENTAL OR CONSEQUENTIAL DAMAGES SUFFERED BY THE PURCHASER, OR ANY THIRD PARTY, INCLUDING, WITHOUT LIMITATION, DAMAGES FOR LOSS OF PROFITS OR BUSINESS, OR DAMAGES RESULTING FROM USE OR PERFORMANCE OF THE INSTRUMENT, WHETHER IN CONTRACT OR IN TORT. LINE 6 SHALL NOT BE LIABLE FOR ANY EXPENSES, CLAIMS, OR SUITS ARISING OUT OF OR RELATING TO ANY OF THE FOREGOING. Some states do not allow the exclusion or limitation of implied warranties so some of the above limitation and exclusions may not apply to you. This warranty only applies to products sold and used in the United States of America and Canada. Line 6 shall not be liable for damages or loss resulting from the negligent or intentional acts of the shipper or his contract affiliates. You should contact the shipper for proper claims procedures in the event of damage or loss resulting from shipment.