

JC-50 SERVICE NOTES

ERRATA & SUPPLEMENT is attached at the end of the page.
最終頁に正誤表 & 追加情報があります。

Second Edition

This Service Notes makes First Edition (Printed FEB. 1, 1979) obsolete and includes its contents in PART2 of this edition.

APPLICABLE TO JC-50 MODELS with Serial Numbers
PART1 (PP.1 thru 3) 258400 and up (except USA)
251100 and up (USA only)
PART2 (PP.5 thru 8) up to 248399
up to 241099 (USA only)

SPECIFICATIONS

Output	50 W (rms)	Dimensions	548(W) x 506(H) x 239(D) mm
Speaker	30 cm x 1		21-5/8" x 19-7/8" x 9-3/8"
Power Consumption	150 VA	Weight	18 kg, 40 lbs

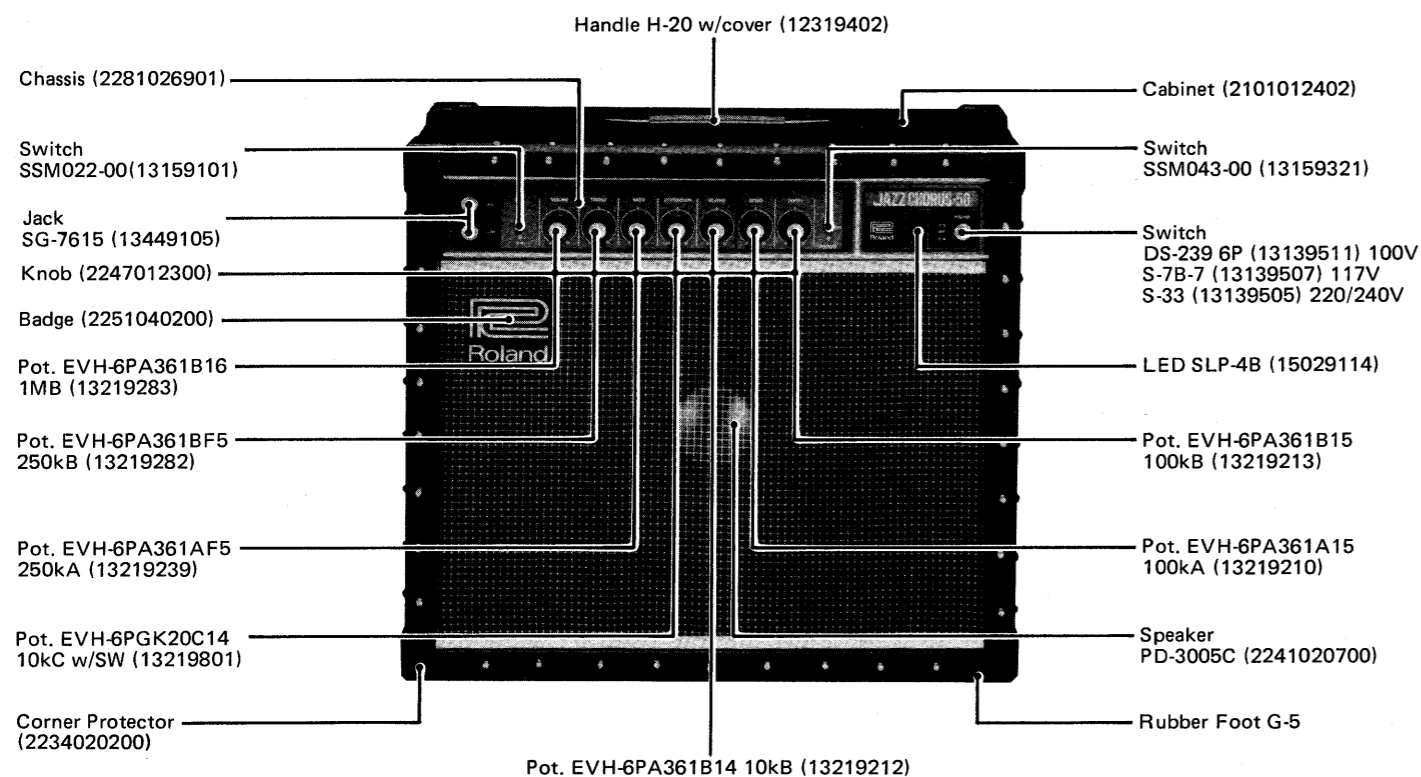

REAR

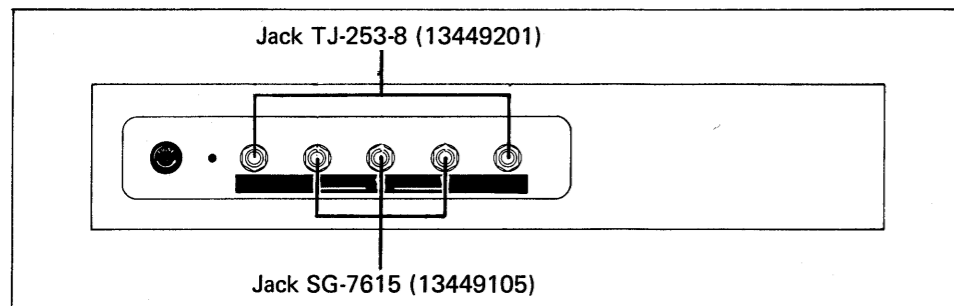

Chassis Removal Screw
5 x 35 mm truss BC

Back Board Removal Screw
Tapping 4 x 25mm A1 truss

PARTS LIST

Parts marked with • are the same as those on early model.
Only part numbers changed.

2101012402	Cabinet Assembly (Including Handle, Badge, Corner Protector, Rubber Feet and Baffle Board)	IC	15189102	NJM4558DD
2281026901	Chassis	15219205	MN-3007	BBD
2247012300	Knob	15169504	MN-3101	CLOCK GENERATOR/ DRIVER
SPEAKER		TRANSISTOR		
• 2241020700	PD-3005C	15119111	2SA970-GR	
SWITCH		15119602	2SB647-C	
13139511	DS-239 6P POWER 100V	15129114	2SC1815-GR	
• 13139507	S-7B-7 POWER 117V	15129120	3SC2240-GR	
13139505	S-33 POWER 220/240V	15129601	2SD666-C	
13159321	SSM043-00 CHORUS/VIB.	15129602	2SD667-C	
• 13159101	SSM022-00 BRIGHT	15129820	2SD313-E or 2SD526, 2SD1624, 2SD880	
		15129825	2SD718-O or R or 2SC3182, 2SD588	
JACK		FET		
13449105	SG-7615	• 15139106	2SK117-GR	
13449201	TJ-253-8	15139112	2SK246-GR	
POWER TRANSFORMER		DIODE		
22450144N1	100/117V	15019103	1S2473	
22450145D0	220/240V	15019205	1N4003 or S5500G	
REVERB UNIT		• 15019210	1R5BZ61 rectifier	
• 12389104	HS-700W	15019560	RD16EB2 zener	
FUSE		15019582	RD30EB4 zener	
• 12559117	MGC 3A pri. 100/117V	15029114	SLP-4B LED	
• 12559521	CEE T1.6A pri. 220/240V	CAPACITOR		
• 12559109	SGA 4A sec. 100/117V	13639942S0	50MV 1NP 1μF/50V	
• 12559517	CEE T4A sec. 220/240V	13639922M0	electro. bi-polar	
FUSE HOLDER		13549625M0	ECEA1CN100S 10μF/16V	
• 12199514	SN-2059 pri. 100/117V	13549625M0	electro. bi-polar	
	or FH-032	• 13549871M0	ECQM2103KZ 0.01μF/200V	
12199515	SN-2250 pri. 220/240V	• 13549883M0	polypropylene	
	or FH-033		ECQM6472MZ 0.0047μF/600V	
12199519	TF-758 sec.		polypropylene	
			ECQM6473MZ 0.047μF/600V	
PCB ASSEMBLY		RESISTOR		
		13869301	0.33Ω 5W cement	
		13829254F0	330Ω 2W metal oxide film	
		12559702	FRNB 10Ω ½W fusible	
		12559704	FRNB 100Ω ½W fusible	
		13829802M0	ERD-50FJ 27Ω ½W	
			metal oxide film non-flammable	
POTENTIOMETER				
13219212	EVH-6PA361B14 10kΩ			
	REVERB			
13219210	EVH-6PA361A15 100kΩ			
	VIB. SPEED			
13219213	EVH-6PA361B15 100kΩ			
	VIB. DEPTH			
13219239	EVH-6PA361AF5 250kΩ			
	BASS			
13219282	EVH-6PA361BF5 250kΩ			
	TREBLE			
13219283	EVH-6PA361B16 1MB			
	VOLUME			
13219801	EVH-6PGK20C14 10kΩ w/SW			
	DISTORTION			

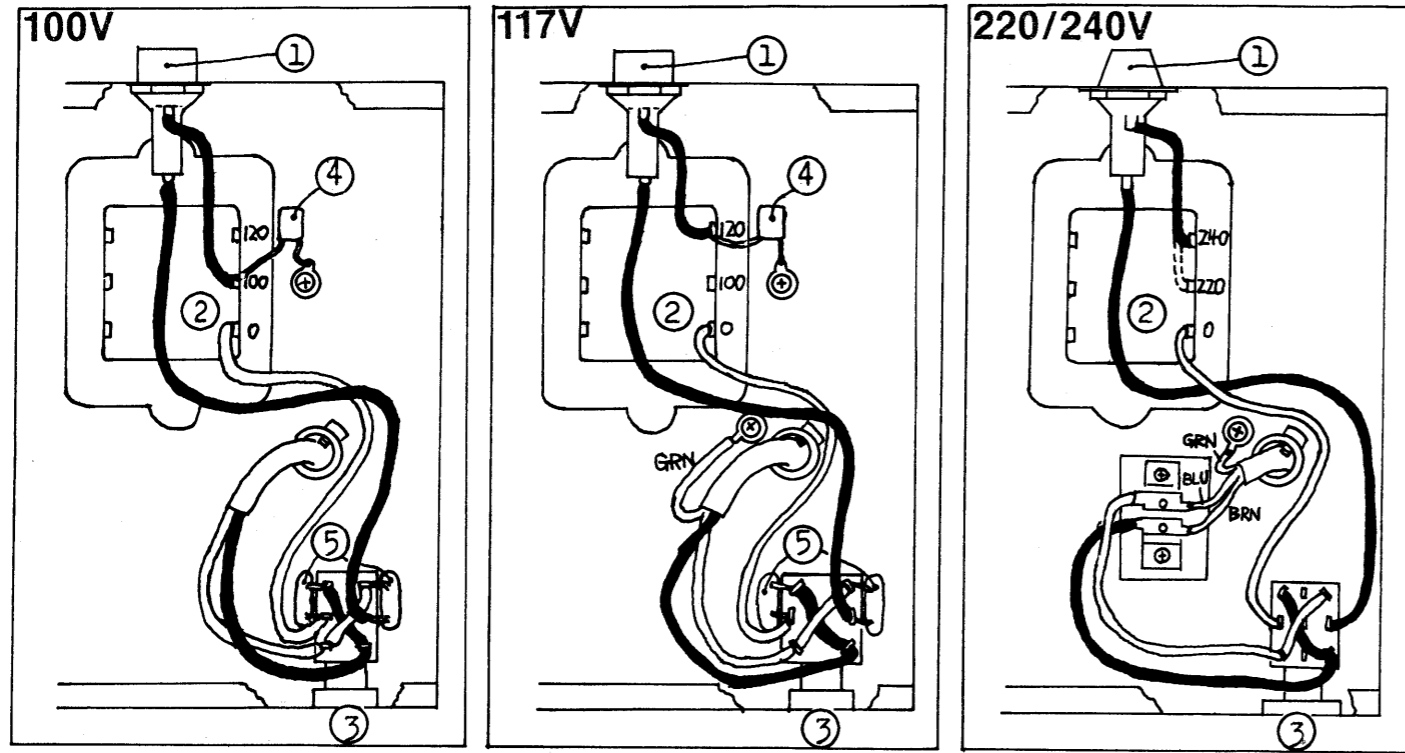

	100/117V	220/240V
1. PRI. FUSE FUSE HOLDER	MGC 3A SN-2059 or FH-032	CEE T1.6A SN-2250 or FH-033
SEC. FUSE FUSE HOLDER	SGA 4A TF-758	CEE T4A TF-758
2. TRANSFORMER	(22450144N1)	(22450145D0)
3. POWER SWITCH	DS-239 6P (100V) S-7B-7 (117V)	S-33
4. Line Cap	ECQM6472MZ	
5. Line Cap	ECQM6473MZ	

WHEN SUBSTITUTING THIS BOARD FOR ITS PREDECESSOR, FOLLOW THE PROCEDURE BELOW:

- Prepare new CH/VIB SW, SSM043-00, and interwire PCB and SW terminals of the same number – 30 thru 37.
- VR9 on the rear panel becomes obsolete.
- Remove the resistor from BRIGHT SW and rewire the lead from terminal No.2.
- Terminal pads, marked A or B, should be left unconnected.

PCB ASSEMBLY
(70113260)
(pcb 2291018801)

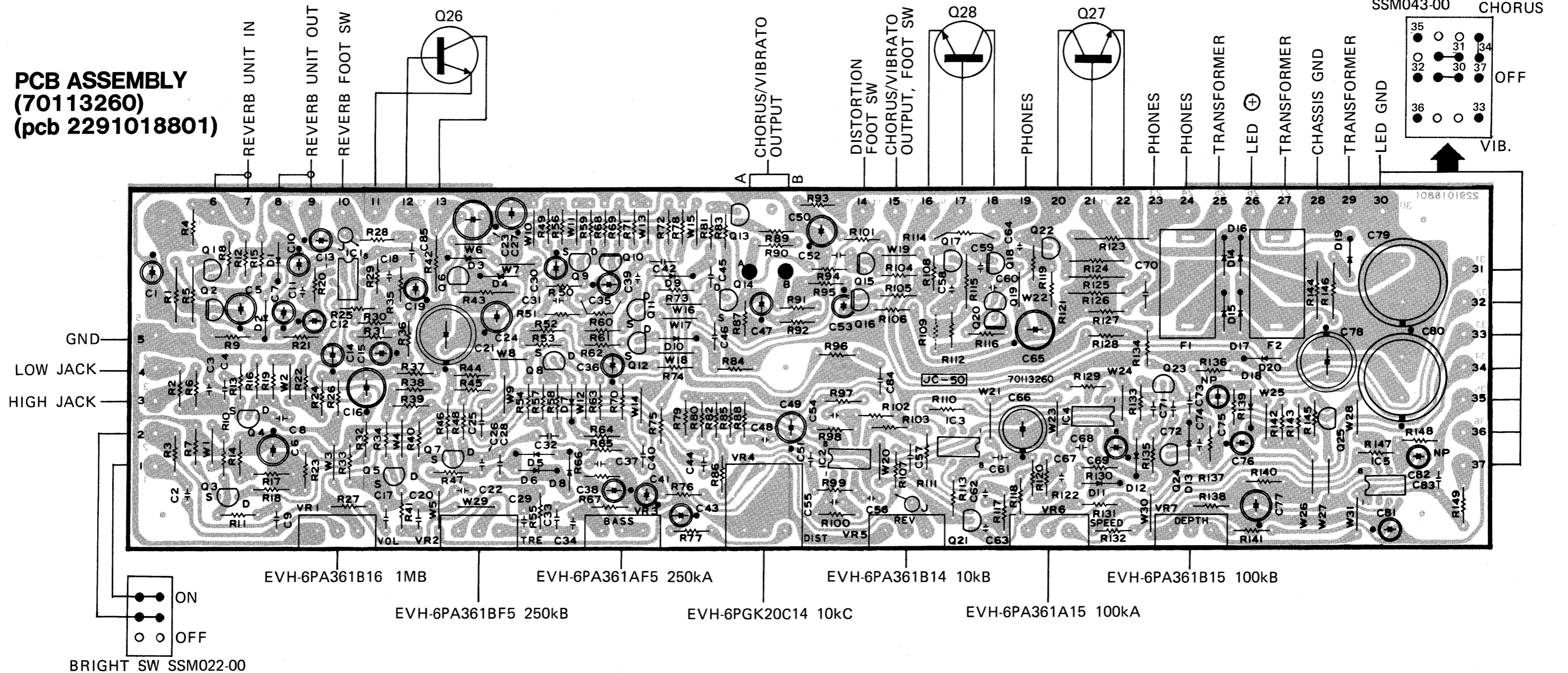

1 2 3 4 5 6 7 8 9 10 11 12 13 14 15 16 17 18 19 20 21 22 23 24 25 26 27 28 29 30 31 32 33 34 35 36 37 38 39 40

A
B
C
D
E
F
G
H
I
J
K
L
M
N
O
P
Q
R
S
T
U
V

JC-50

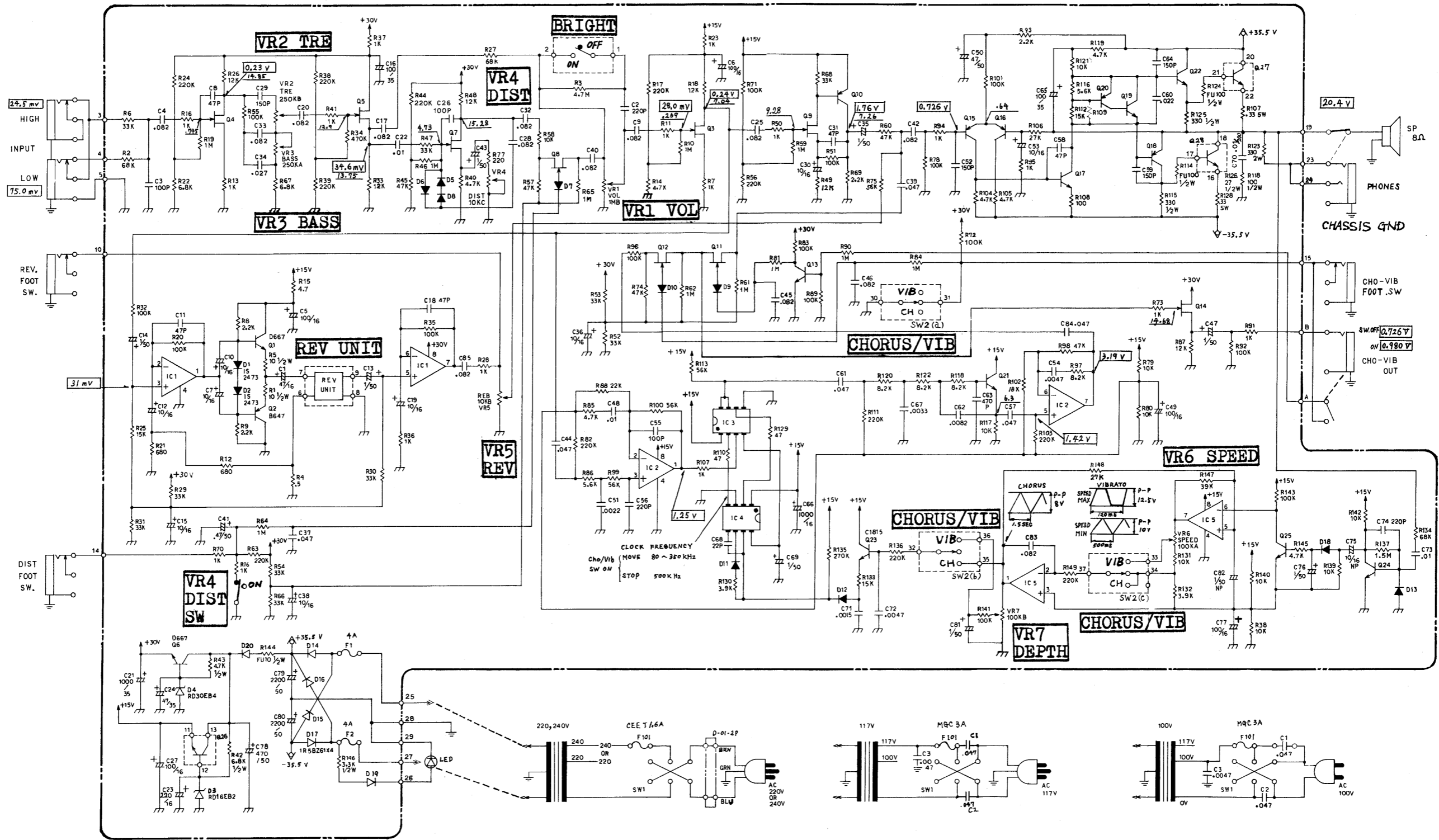

IC1, 2, 5	: NJM4558DD	Q10, 15, 16	: 2SA970-GR	D1, 2, 5-13, 18	: 1S2473
IC3	: MN3007	Q13, 21, 23-25	: 2SC1815-GR	D3	: RD16EB2
IC4	: MN3101	Q17	: 2SD666-C	D4	: RD30EB4
		Q19	: 2SC2240-GR	D14-17	: 1R5BZ61
		Q20	: 2SA970-GR	D19, 20	: 1N4003
Q1, 6, 22	: 2SD667-C	Q26	: 2SD313-E		or S5500G
Q2, 18	: 2SB647-C		or 2SD526, 2SD1624, 2SD880		
Q3-5, 7, 9, 14	: 2SK117-GR	Q27, 28	: 2SD718-O or R		
Q8, 11, 12	: 2SK246-GR		or 2SC3182, 2SD558		

Signal Voltages Taken Under Conditions:
 Input 1kHz sine
 Tone controls BASS-FCW
 TRE -FCW

JACKS COLD terminals not connected to PCB terminals are to chassis.

Secondary Winding Ratings (DC)
 35.5V x 2 @ 1.3A
 2200μF INPUT

JC-50

SERVICE NOTES

APPLICABLE TO SERIAL NUMBERS

Up to 248399, Up to 241099 (USA only)

SPECIFICATIONS

Output ----- 50W rms into 8-ohm
 Speaker ----- 30cm x 1
 Input Jack --- High/Low
 Controls ----- Volume, Treble, Bass,
 Distortion, Reverb,
 Vibrato Speed,
 Vibrato Depth,
 Chorus/Vibrato Select,
 Bright ON/OFF

Foot Switch -- Reverb, Distortion,
 Jack Chorus/Vibrato
 Output Jack -- Headphones
 Power Consumption -- 150VA
 Weight ----- 18Kg
 Accessory supplied -- Vinyl Cover

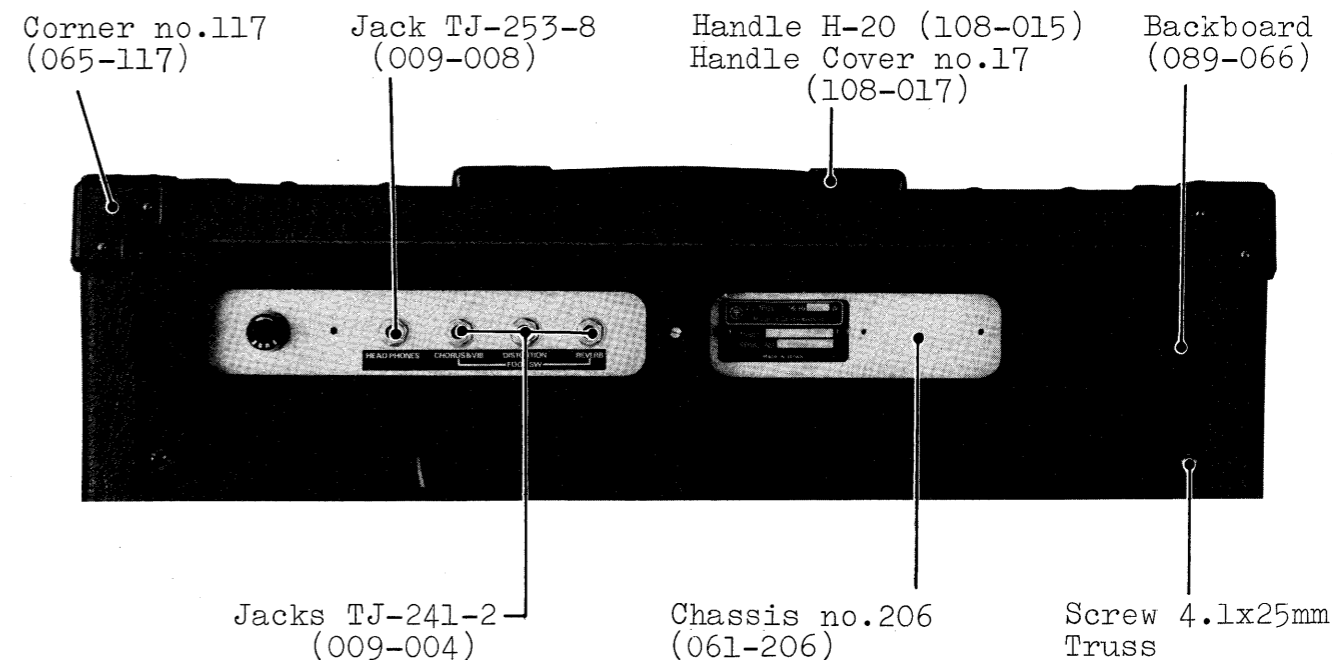
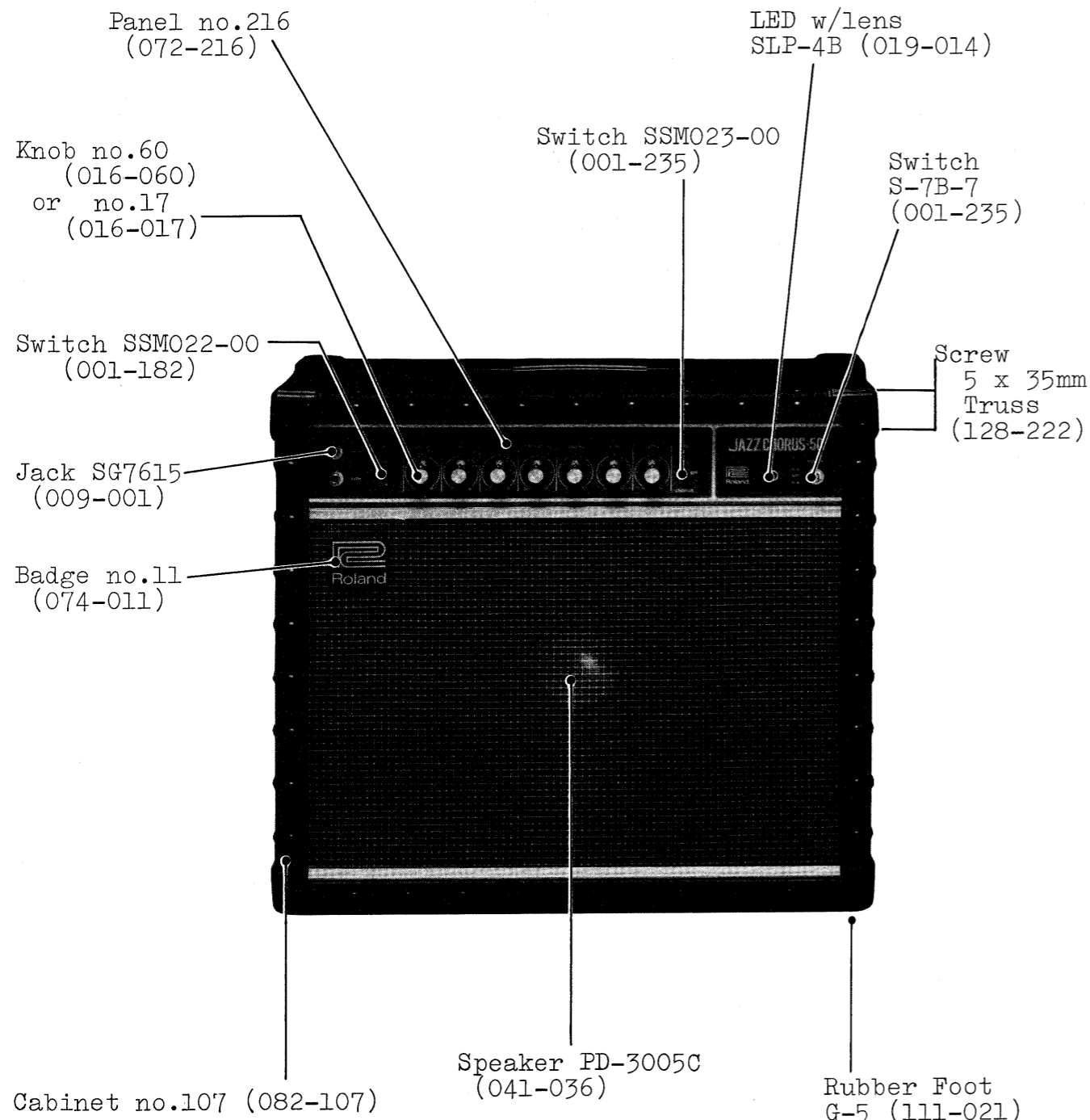

Power Supply Parts Layout

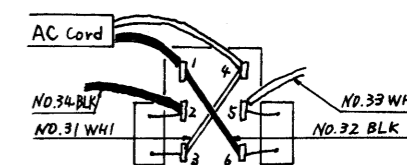
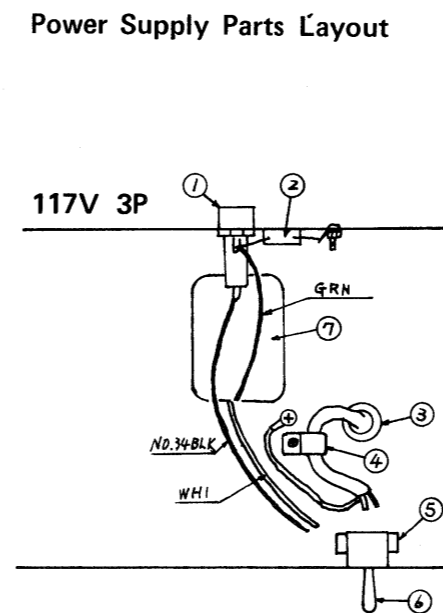

1. Fuse Holder SN-2059 (012-020)
 Fuse primary MGC 3A (008-159)
2. Line Capacitor ECQ-1A472MC (035-107)
3. Strain Relief EA-5 (047-025)
4. Clamp HP-5N (047-006)
5. Line Capacitor ECQ-1A473MC (035-108)
6. Power Switch S-7B-7 (001-235)
7. Power Transformer (022-111C)

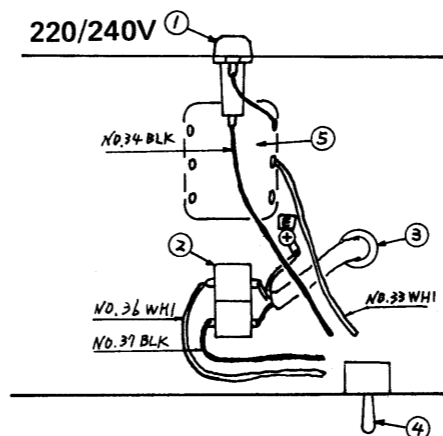

1. Fuse Holder SN-2250 (012-019)
 Fuse prim. CEE 1.6AT (008-069)
2. Terminal Block D-01-2P (042-032)
3. Strain Relief EA-5 (047-025)
4. Power Switch S-7B-7 (001-235)
5. Power Transformer (022-111D)

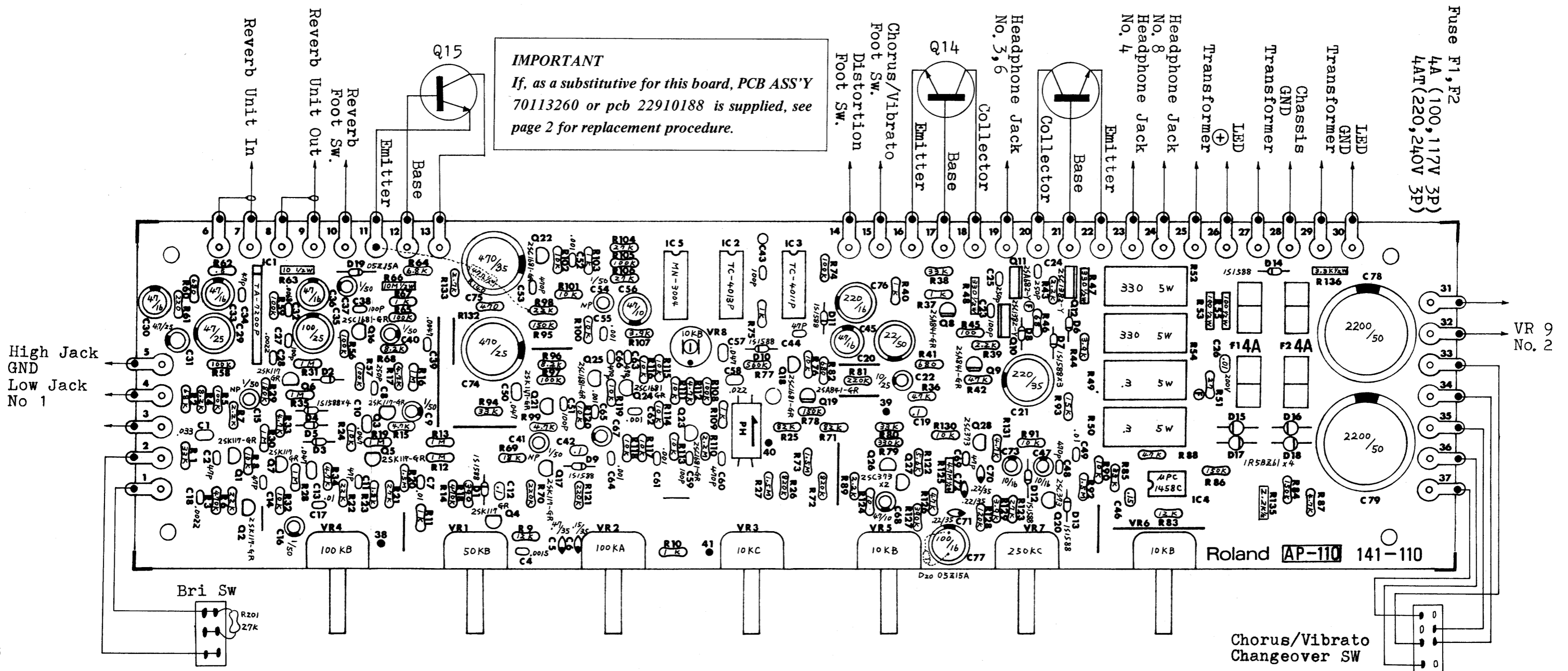
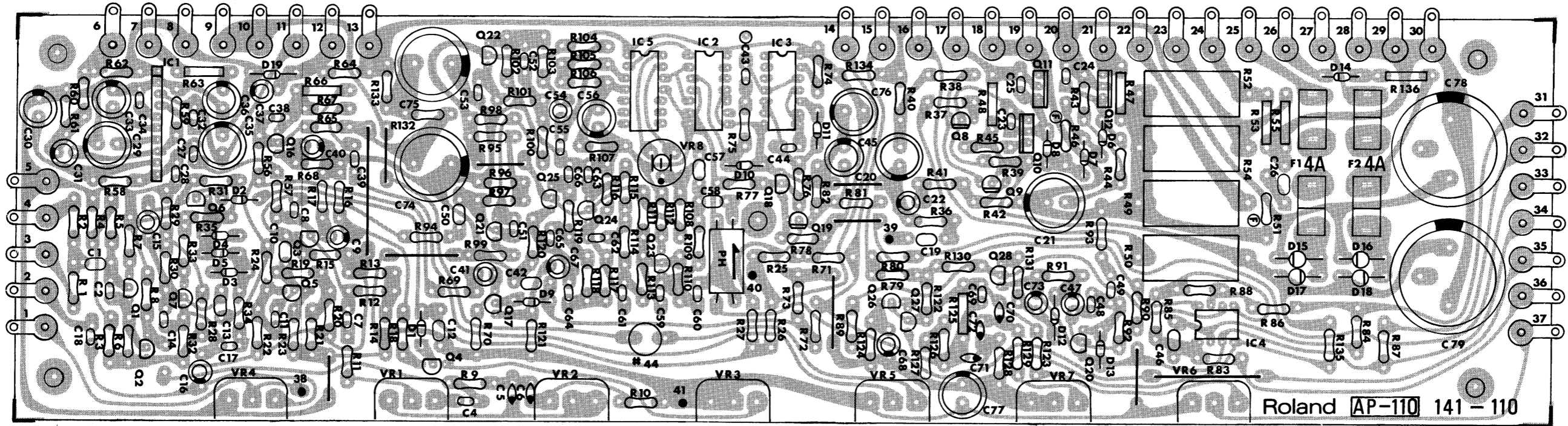

IMPORTANT
 If, as a substitutive for this board, PCB ASS'Y 70113260 or pcb 22910188 is supplied, see page 2 for replacement procedure.

High Jack GND
 Low Jack No 1

Fuse F1, F2
 4A (100, 117V 3P)
 4AT (220, 240V 3P)

VR 9
 No. 2

Chorus/Vibrato
 Changeover SW

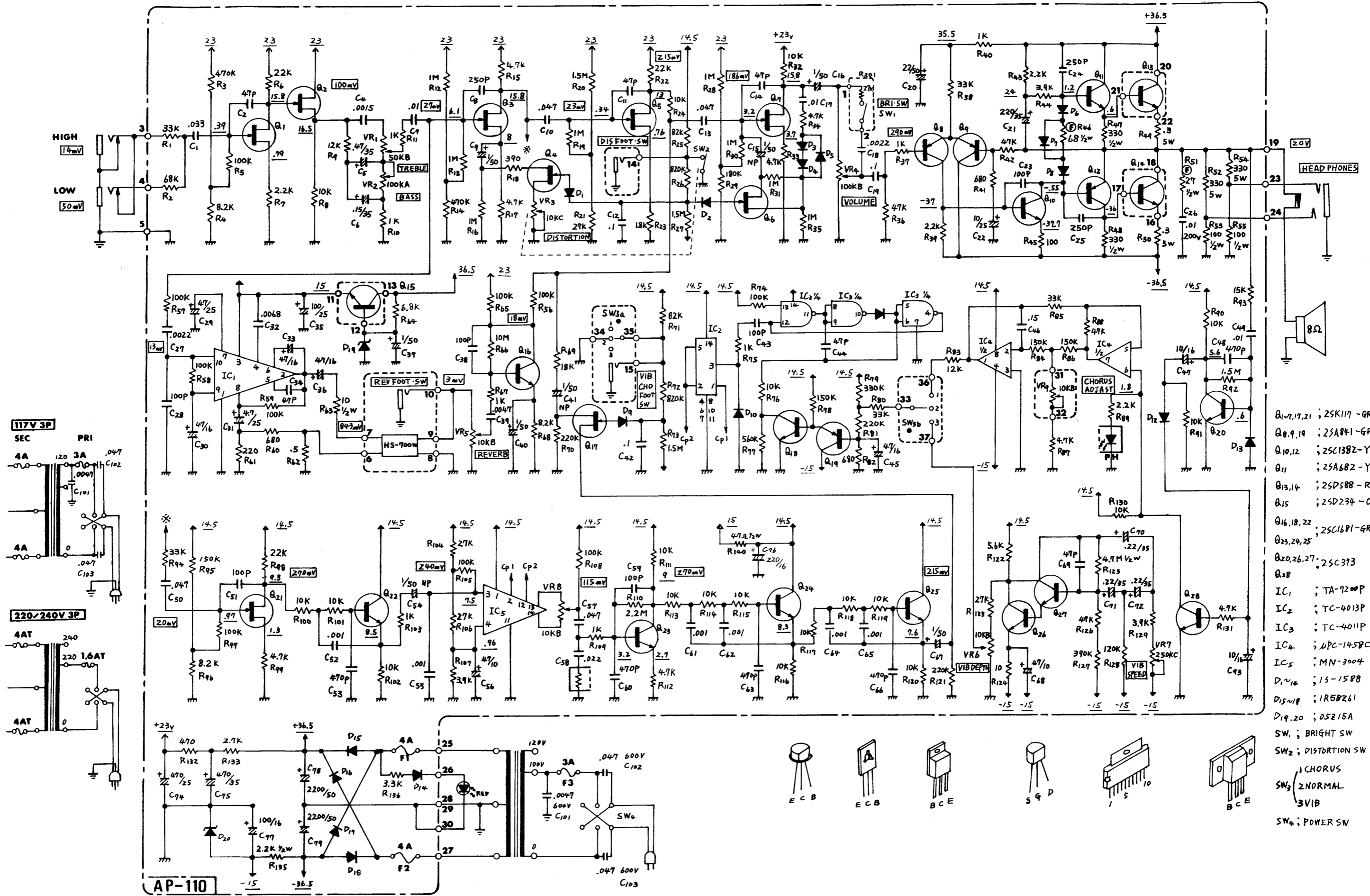

- Q1,7,17,21 ; 2SK117 -GR
- Q8,9,19 ; 2SA841 -GR
- Q10,12 ; 2SC138Z-Y
- Q11 ; 2SA68Z-Y
- Q13,14 ; 2SD588-R
- Q15 ; 2SD234-O
- Q16,18,22 ; 2SC1681-GR
- Q23,24,25
- Q20,26,27 ; 2SC373
- Q28
- IC1 ; TA-7200P
- IC2 ; TC-4013P
- IC3 ; TC-4011P
- IC4 ; 4PC-1458C
- IC5 ; MN-3004
- D1,14 ; 1S-1588
- D15-18 ; 1R5B261
- D19,20 ; 05Z15A
- SW1 ; BRIGHT SW
- SW2 ; DISTORTION SW
- SW3 ; 1CHORUS
2NORMAL
3VIB
- SW4 ; POWER SW

AP-110

PARTS LIST Please read new Parts List on P.1 for reference.

JC-50

FEB. 1, 1979

131-105	Vinyl Cover	no.105	
130-209	Carton	no.209	
001-182	Switch	SSM-022-00	slide Bright
001-235	Switch	SSM-023-00	slide Vib/Cho
022-111	Power Transformer	no.111 (C - 117V, D - 220/240V)	
040-004	Reverb Unit	HS-700W	
012-029	Fuse Holder	SN-5054	sec.
008-158	Fuse	MGC 4A	sec. 117V
008-074	Fuse	CEE 4AT	sec. 220/240V
048-055	Heat Sink	no.55	power transistors
053-166	Connector Assy	no.166	
053-235	Connector Assy	no.235	

PCB

141-110 AP-110 (052-396)

TRANSISTORS

DIODES

ICS

017-069	2SA-841-GR	Transistor	
017-034	2SA-682-Y	Transistor	
017-062	2SC-1681-GR	Transistor	
017-011	2SC-373	Transistor	
017-035	2SC-1382-Y	Transistor	
017-010	2SD-234-O	Transistor	
017-102	2SD-588-R	Transistor	power
017-103	2SK-117-GR	FET	
018-059	1S1588	Diode	
018-061	1R5BZ61	Diode	rectifier
018-066	05Z20A	Zener	
019-014	SLP-24B	LED	
019-006	P873-G350-380	Photocoupler	
020-028	TA-7200P	IC	
020-062	uPC1458C	IC	
020-040	TC-4011P	IC	
020-041	TC-4013P	IC	
020-063	MN-3004	BBD	
030-465	SR-19R	B10K trimmer	BBD Adj.
028-983	EVH-8MA S10	B10K	Chorus/Vibrato
028-481	EVH-6PA K20	B10K	Reverb/Vibrato
028-483	EVH-6PA K20	B50K	Treble
028-484	EVH-6PA K20	B100K	Volume
028-474	EVH-6PA K20	A100K	Bass
028-501	EVH-6PA K20	C250K	Vibrato Speed
028-502	EVH-6PG K20	C10K w/sw	Distortion

CAPACITORS

032-092	0.15 μ F	35V	tantalum
032-093	0.22 μ F	35V	tantalum
032-095	0.47 μ F	35V	tantalum
032-047	CEO4D1H010	1 μ F	50V electro. Bi-Polar
035-103	ECQM2103KZ	0.01 μ F	200V polyester
035-101	ECQM6472MZ	0.0047 μ F	600V

RESISTORS

044-258	MS-5	0.3-ohm	5W	wire wound
044-289	MS-5	330-ohm	5W	wire wound
044-398	ERD-12FJ	27-ohm	$\frac{1}{2}$ W	noninflammable
044-403	ERD-12FJ	68-ohm	$\frac{1}{2}$ W	noninflammable

*Resistors of $\frac{1}{4}$ W $\pm 5\%$, mylar, ceramic, and ordinary electrolytic capacitors are omitted.

* For other parts not listed above, see pictorial.

ADJUSTMENT

Set Vol. Tre. Bass at maximum.
 Rev. Dist. Vib-Spped, -Depth at minimum.
 Set Input Signal for the JC-50's maximum output (onset of clipping) -- approx. 20V rms.
 Connect oscilloscope lead to PH lead on AP-110. -- Fig.1

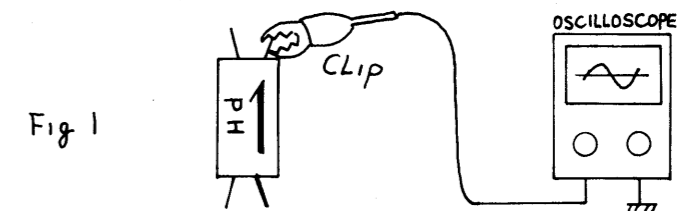

BBD OUTPUT WAVE ADJUSTMENT

Adjust VR-8 for Fig.2.

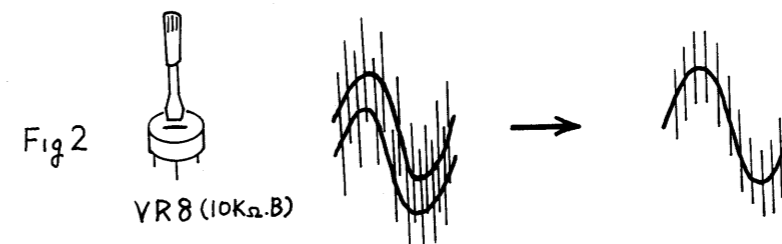

CHORUS ADJUSTMENT

Connect oscilloscope to no.36 terminal on AP-110.
 Adjust VR-9 for Fig.3.

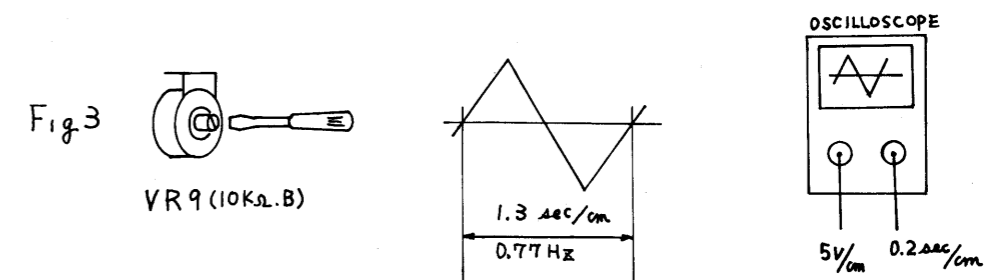

JC-50 (2nd) SERVICE NOTES 1991.05.27
 ERRATA & SUPPLEMENT 正誤表 & 追加情報
 (Small errors are ignored. 重要でないエラーは無視します。)

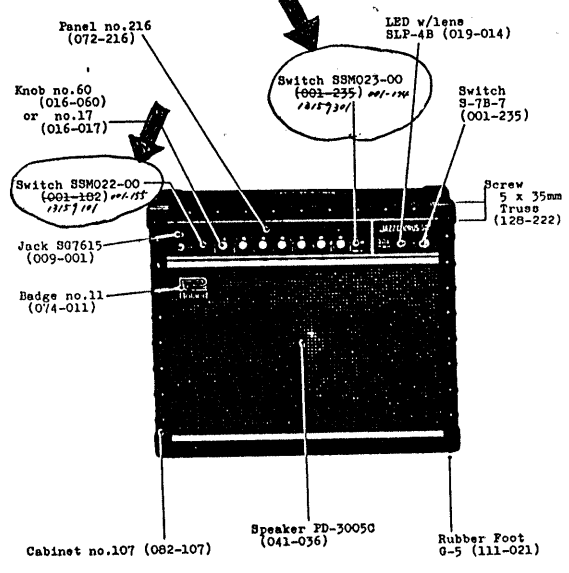
Page	WRONG 誤 →	CORRECT 正
5	<p>JC-50 SECOND EDITION JC-50 up to 248399/以前 up to 241099(USA only) PART NUMBER ERROR ハ°-ツコト”誤記訂正 * Switch SSM023-00 (001-235) * Switch SSM022-00 (001-182)</p>	<p>* Switch SSM023-00 (<u>13159301</u>) * Switch SSM022-00 (<u>13159101</u>)</p>
8	<p>PARTS LIST</p> <hr/> <p>001-182 Switch SSM-022-00 slide Bright</p> <p>001-235 Switch SSM-023-00 slide Vib/Cho</p>	<p>JC-50 SERVICE NOTES APPLICABLE TO SERIAL NUMBERS Up to 248399, Up to 241099 (USA only)</p> <p>SPECIFICATIONS Output ----- 50W rms into 8-ohm Speaker ----- 30cm x 1 Input Jack --- High/Low Controls ----- Volume, Treble, Bass, Distortion, Reverb, Vibrato Speed, Vibrato Depth, Chorus/Vibrato Select, Bright ON/OFF</p> <p>Foot Switch -- Reverb, Distortion, Jack Chorus/Vibrato Output Jack -- Headphones Power Consumption -- 150VA Weight ----- 18Kg Accessory supplied -- Vinyl Cover</p>  <p>Roland Printed in Japan BC 2 5</p> <p>PARTS LIST</p> <hr/> <p><u>13159101</u> Switch SSM-022-00 slide Bright</p> <p><u>13159301</u> Switch SSM-023-00 slide Vib/Cho</p> <p>* Please amend all existing service notes as above. * 該当サービスノートを上記のように修正して下さい。</p>