

SYNTHESIZER











SH-7 SERVICE NOTES

CONTENTS

SPECIFICATIONS	1
DISASSEMBLY	3
CIRCUIT DESCRIPTION	4
BLOCK DIAGRAM	8
CONTROL BOARD C (OPH-35)	8
KEY CONTROL VOLTAGE BOARD (CVH-1)	9
OPH-35/CVH-1 CIRCUIT	10
VCO-1 BOARD (VCOH-1)	11
VCO-1 CIRCUIT	12
VCO-2 BOARD (VCOH-2)	13
VCO-2 CIRCUIT	14
LFO BOARD (LFOH-1)	15
LFO CIRCUIT	16
VCF/VCA BOARD (OPH-14)	17
OPH-14 CIRCUIT	18
CONTROL BOARD A (OPH-33)	19
OPH-33 CIRCUIT	20
CONTROL BOARD B (OPH-34)	21
OPH-34 CIRCUIT	22
CONNECTION PANEL - SUB-CHASSIS	23
POWER SUPPLY BOARD (PSH-13/14) / CIRCUIT	24
POWER SUPPLY WIRING	25
ADJUSTMENT	26
PARTS	33
PARTS LIST	36
KEYBOARD PARTS	

SPECIFICATIONS

- A. KEYBOARD: 44 Keys
- B. INPUT MODE: EXT CV Gate(S/H)/Two Note/One Note
- C. CONTROLLER
1. Portamento Mode: Down/Normal/Up
 - Portamento Time: 0-3sec
 2. Transpose: Low/Medium/High(1 Oct Step)
 3. Bender Lever: -35° - $+35^{\circ}$
 - a. VCO
 - Mode: LFO/OFF/CV
 - Sensitivity: LFO: ± 10 Notes max CV: ± 15 Notes max
 - b. VCF
 - Mode: LFO/OFF/CV
 - Sensitivity: 0-10
 - c. VCA
 - Mode: LFO/OFF/CV
 - Sensitivity: LFO: -20dB - $+15\text{dB}$ max CV: -30dB - $+20\text{dB}$ max
 4. Autobend
 - Time: 20ms-700ms
 - Polarity: \curvearrowright (+) / \curvearrowleft (-)
 5. Total Tuning: ± 3.5 Notes
 6. VCO-2 Tuning: ± 7.5 Notes
- D. VCO-1(A) MIXER
- | | | | |
|--------|------|---|--------------------------|
| □ 2': | 0-10 | } | Mixing Level
+6dB max |
| □ 4': | 0-10 | | |
| □ 8': | 0-10 | | |
| □ 16': | 0-10 | | |
| □ 32': | 0-10 | | |
- E. VCO-1(B)
1. Range: $2'/4'/8'/16'/32'$
 2. Waveform: $\wedge / \nearrow / \square / \square$
 3. PWM
 - a. Modulation: 0(50%)-10(min)
 - b. Mode: LFO(\wedge)/Manual/ENV-1(\curvearrowleft)
 4. Control
 - a. LFO: 0-10
 - b. Autobend: 0-10
 - c. S & H: 0-10
- F. VCO-2
1. Range: $2'/4'/8'/16'/32'$
 2. Waveform: $\wedge / \nearrow / \square / \square$
 3. PWM
 - a. Modulation: 0(50%)-10(min)
 - b. Mode: LFO(\wedge)/Manual/ENV-1(\curvearrowleft)
 4. Control
 - a. LFO: 0-10
 - b. Autobend: 0-10
 - c. S & H: 0-10
 5. Synchro(with VCO-1): ON/OFF
- G. AUDIO MIXER
1. VCO-1(A): 0-10
 2. VCO-1(B): 0-10
 3. VCO-2: 0-10
 4. Noise: 0-10
 5. RING, EXT SIG: RING/EXT SIG
 - RING, EXT SIG: 0-10
 6. Overload Indicator: LED
- H. HPF
- Cutoff Frequency: 10Hz-20KHz

- I. VCF
1. Cutoff Frequency: 5Hz-20KHz
 2. Resonance: Min - Self Oscillation
 3. Control
 - a. ENV-1:  / 
 - ENV-1: 0-10
 - b. LFO, S&H: LFO/S&H
 - LFO, S&H: 0-10
 - c. KYBD, PEDAL: KYBD/PEDAL
 - KYBD, PEDAL: 0-10
 - d. VCO-2, NOISE: VCO-2/NOISE
 - VCO-2, NOISE: 0-10
 - e. ENV FOL'R:  / 
 - ENV FOL'R: 0-10
 4. EXT SIG Indicator: LED
- J. VCA
1. Hold: 0-10
 2. Control
 - a. LFO: 0-10
 - b. ENV-1, ENV-2: ENV-1/ENV-2
- K. SAMPLE & HOLD
1. Mode:  /  / Random
 2. Sample Time: 13ms-2s
 3. Output Lag: 0-2s
- L. LFO
1. Waveform:  /  / 
 2. Rate: 0.15Hz-25Hz
 3.  Delay Time: 0-3s
 4. KYBD TRIG: ON/OFF
- M. RING MODULATOR
- Input Mode: VCO-2/EXT SIG
- N. NOISE GENERATOR
- Output Mode: WHITE/PINK
- O. ENV-1
1. Trigger Mode: KYBD GATE+TRIG/KYBD GATE/LFO
 2. Attack Time: 1ms-4s
 3. Decay Time: 1ms-8s
 4. Sustain Level: 0-100%
 5. Release Time: 1ms-8s
- P. ENV-2
1. Trigger Mode: KYBD GATE+TRIG/KYBD GATE/LFO
 2. Attack Time: 1ms-4s
 3. Decay Time: 1ms-8s
 4. Sustain Level: 0-100%
 5. Release Time: 1ms-8s
- Q. INPUT
1. CV Input: 1 Volt/1 Oct
 2. GATE Input: $V_g > 7V$
 3. TRIG Input: $V_t > 5V, T_t > 0.1ms$
 4. EXT SIG Input
EXT SIG Input Level: L(-43dB)/M(-18dB)/H(0dB)
 5. VCF PEDAL CONT Input:
- R. OUTPUT
1. CV Output: 1V/1 Oct.
 2. GATE output: $V_g = 14V$
 3. PHONES Output:
PHONES Output Level: L(-24dB)/M(-12dB)/H(0dB)
 4. Signal Output:
Signal Output Level: L(-18dB)/M(-6dB)/H(+6dB)

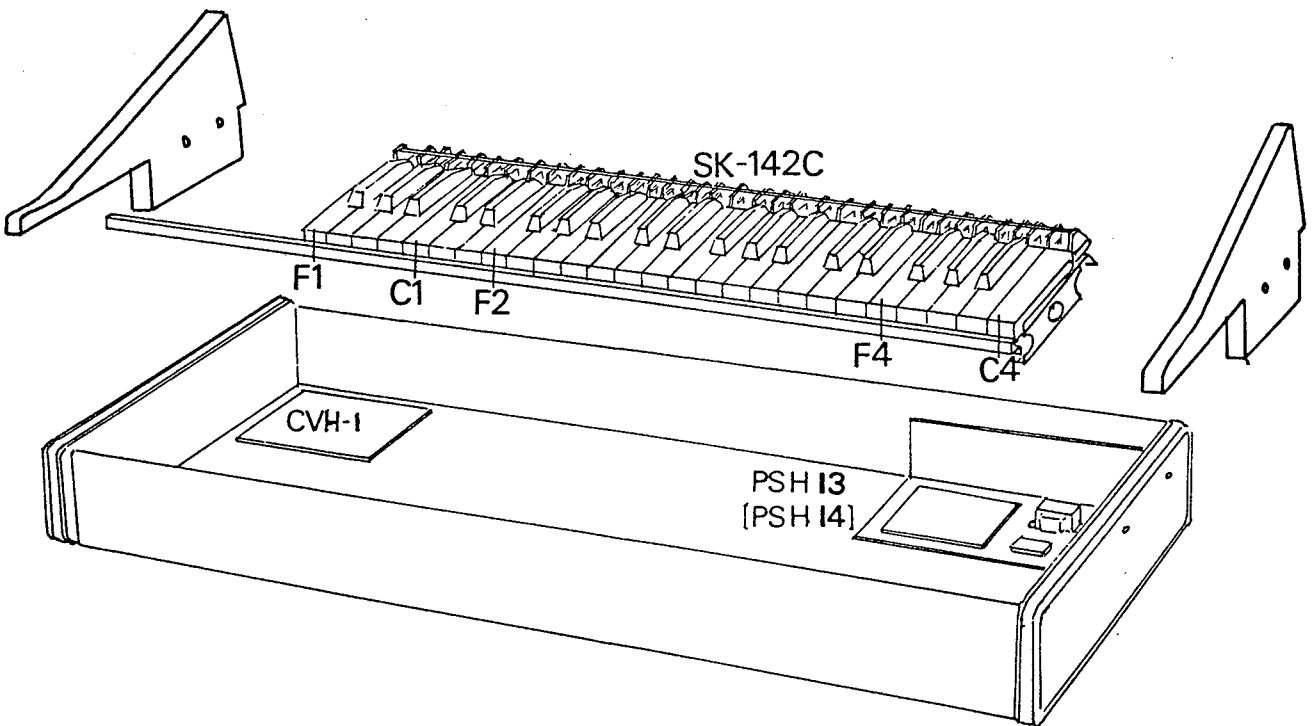
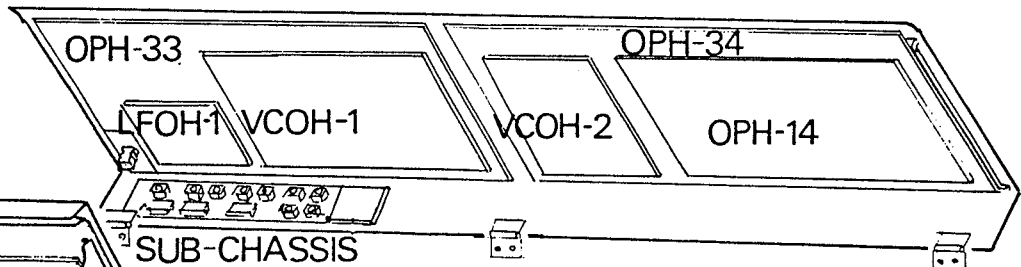
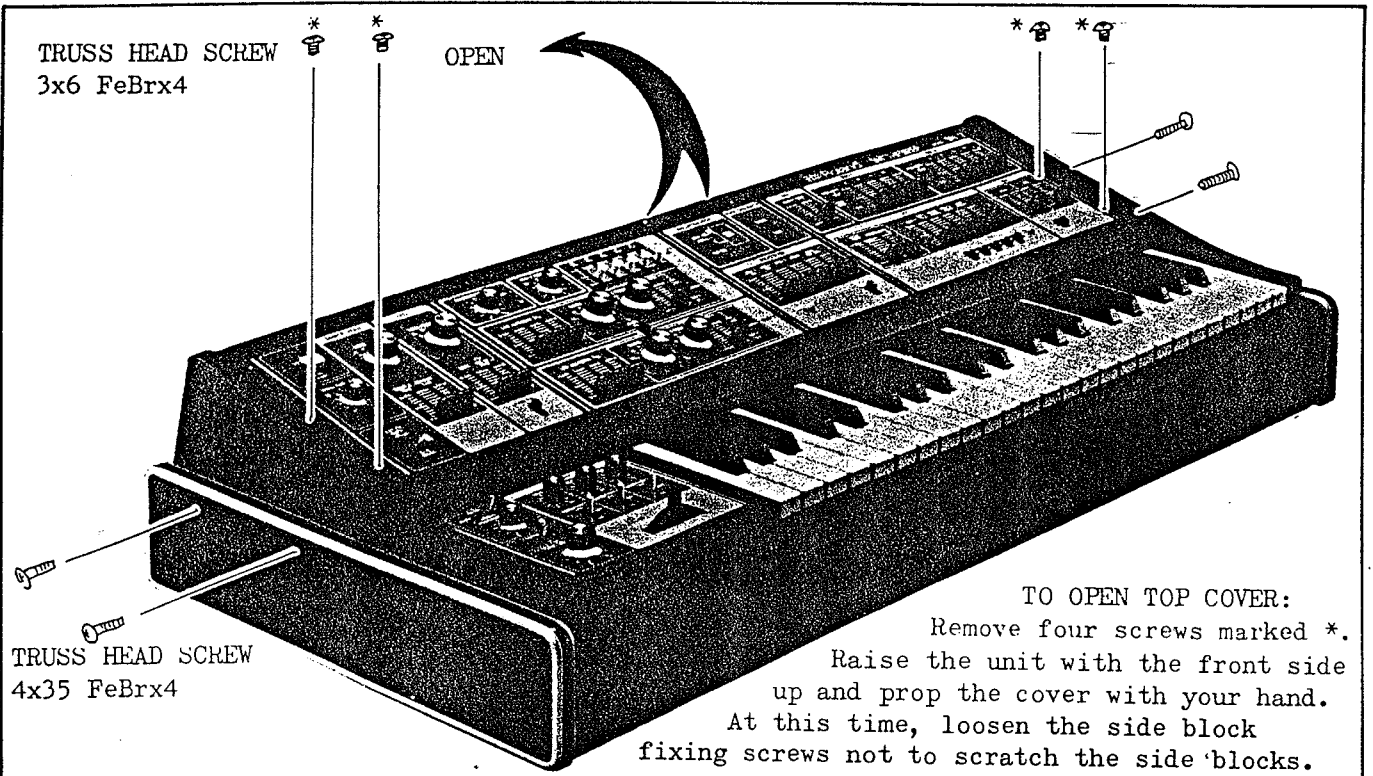

CIRCUIT DESCRIPTION

1. KEYBOARD ASSEMBLY SK-142C

The keyboard has 44 keys which actuate the KCV circuit.

2. KCV BOARD CVH-1

CVH-1 includes the following circuits: CV, GATE, EXT GATE, RETRIGGER, BENDER, PHONES.

2. 1. Control Voltage Circuit

The SH-7 uses the relation of 1 volt/1 octave. When a key is depressed, the corresponding voltage develops across the resistor chain, which is held at the sample and hold circuit by the gate signals. This is the key control voltage.

To get two KCV's, one for the higher note and the other for lower note, two KCV circuits are provided at the both ends of the resistor chain. The two KCV's are sent to the portamento circuit to add portamento effect.

2. 2. Gate Circuit

The gate signal is generated when a key is depressed. It is used to sample the keyboard control voltage and to trigger the Retrigger, Autobend, LFO, ENV-1, and ENV-2 circuits.

2. 3. External Gate Circuit

The external gate input is shaped to a fixed form of gate signal. This circuit is activated with the external input level of +7 volts or over.

2. 4. Retrigger Circuit

With the Gate Trigger Selector Switch at the KYBD GATE+TRIG position, depress a key and the gate voltage develops to trigger the Envelope Generator. Next, with holding the key down, depress a new key and the Envelope Generator is retriggered.

(The change in key control voltage is detected and a pulse is generated, which retriggers the Envelope Generator.)

When using EXT TRIG input, the Retrigger circuit is activated with the external input level of +7 volts or over and the pulse width of 0.1 msec or over.

2. 5. Bender Circuit

The +DC voltage developed by the Bender unit is used as the Bender Control Voltage. The voltage is also used to control the gain of the LFO, which results in Bender LFO output.

2. 6. Phones Circuit

This circuit amplifies the VCA output to drive the headphones. The output level of this circuit is independent of TOTAL VOLUME.

3. CONTROL BOARD ASSEMBLY OPH-35

Switches and controls for the functions described in 2. above, and TOTAL VOLUME control are mounted on this board.

4. BENDER UNIT PB-4

The Bender Control Voltage to control the VCO, VCF, and VCA is varied manually with the BENDER lever of the Bender Unit.

5. VCO-1 BOARD ASSEMBLY VCOH-1

This assembly includes the VCO-1 and AUTOBEND circuits.

5. 1. VCO-1

The VCO is an oscillator whose frequency is controlled by voltage. With the SH-7, the voltages include: keyboard control voltage, external control voltage, and other modulation voltage.

All voltages applied to the VCO are summed together and the linear relation between voltage and frequency is changed to anti-log relation by the anti-log converter.

Pulse wave with the frequency corresponding to the voltage is produced. It is sent to a frequency divider to obtain five square waves of feet series (2', 4', 8', 16', 32'). The VCO-1(A) is obtained by the feet series, either singly or by free mixing.

Selected feet series passes the shaping circuit to give the VCO-1(B) output

(\wedge , \nearrow , \square , \square). EXT CV or KCV (higher note) is applied to the VCO-1.

Pulse is also produced to synchronize the VCO-2 with the VCO-1.

5. 2. Autobend

Input gate signals are differentiated to give Autobend output. The autobend time is variable by controlling the discharge time of the capacitor which is charged with the pulse generated by differentiation. The output is applied to the VCO to bring characteristic effects by momentarily moving the frequency, at the instant a key is depressed.

6. VCO-2 BOARD ASSEMBLY VCOH-2

The VCO-2 works the same way as the VCO-1 except that VCO-2 does not contain output of mixed feet series. EXT CV, higher key voltage or lower key voltage is applied to control the VCO-2, depending on the Key Mode setting. The synchronization circuit is provided to synchronize the VCO-2 with the VCO-1.

7. LFO BOARD ASSEMBLY LFOH-1

This assembly contains the S & H and LFO circuits.

7. 1. S & H

LFO output (\wedge , \nearrow) or Random Noise is applied to the S & H input. The input is sampled at the rate of sampling time. The resulting output is a sampled stepwise or random wave. When the lag time (R/C circuit time constant) is increased, each step of the stepwise waveform is rounded.

7. 2. LFO

The LFO is a low frequency oscillator which generates sawtooth, square, and sine waves for controlling or modulating the related circuits.

The waveforms include: (1) sawtooth, square, and sine waves for modulating VCO/VCF/VCA; (2) triangular and sawtooth wave for S & H; (3) triangular wave for PWM, and (4) square wave for triggering the Envelope Generator.

The delay time is adjustable. When the DELAY TIME control is raised, pressing a key on the keyboard will produce a delayed entry of a sine wave.

8. VCF/VCA BOARD ASSEMBLY OPH-14

This assembly includes Ring Modulator, Envelope Follower, EXT AMP, Audio Mixer, Noise Generator, ENV-1, ENV-2, HPF, VCF, and VCA circuits.

8. 1. Ring Modulator

The inputs for the Ring Modulator consisting of the balanced modulator IC are carrier input and signal input. When two different frequencies are given to the two inputs, the sum and difference frequencies of the two appear as the output. This circuit is used to obtain peculiar sounds like bells, gongs, and others.

8. 2. Envelope Follower

External signal is amplified by the external signal amplifier, full-wave rectified, and then filtered to obtain an envelope of the external signal.

When the envelope is applied as the control voltage of VCF, tone color and resonance are varied while the external signal passes through VCF. Thus synthesizer effects are added to the external signal from microphone or electric guitar.

8. 3. EXT AMP

This circuit amplifies low level signals from external sources by about +53dB to the level of the VCO signals.

8. 4. Audio Mixer

This circuit mixes outputs of the VCO-1(A), VCO-1(B), VCO-2, Noise Generator, Ring Modulator, and the external input signal. The indicator circuit works to light the lamp when the combination of mixing levels is excessively high.

8. 5. Noise Generator

Junction noise from a reversely biased transistor is used as the signal source and processed at the amplifier and filter to obtain white and pink noises.

8. 6. ENV-1

The ENV-1 generates an envelope for controlling the VCF to vary the tone color, the VCA to give loudness contour, and pulse width modulation of VCO.

The attack time, decay time, sustain level, and release time can be varied to synthesize sounds of instruments and effects.

Three trigger modes are available; GATE+TRIG, GATE, and GATE+LFO.

8. 7. ENV-2

The ENV-2 generates an envelope for controlling the VCA to give loudness contour. The operation is the same with the ENV-1.

8. 8. HPF

The HPF blocks lower frequencies than the cutoff frequency and passes higher frequencies only. Signals from the mixer passes through the HPF and the tone color is varied. The cutoff frequency is moved by changing the time constant with the slider.

8. 9. VCF

The VCF is a low pass filter whose cutoff frequency is controlled by means of a control voltage. It consists of the four-stage low pass filter of -6dB/oct, a feedback circuit which controls resonance, and a circuit which adds input control vol-

tages and converts the sum to anti-log current.

The OTA (Operational Transconductance Amplifier) is used for each stage of the low pass filter and the cutoff point is moved by changing the integration time constant with the control current.

Increasing the amount of feedback boosts the frequencies around the cutoff point. Further increasing it causes the VCF to self-oscillate. This oscillating frequency, independent of input signals, is controlled by the control voltage and works like a VCO.

When key voltage is applied as the control voltage, the cutoff point follows the change in the note scale. Thus the tone color is kept constant. The cutoff point is also controlled by the LFO, ENV, etc. to add effects sound to the tone.

8.10. VCA

The VCA is an amplifier whose gain is controlled by a control voltage. Control voltages from the ENV-1, ENV-2, LFO, Bender, etc. are applied to give various loudness contours.

9. CONTROL BOARD ASSEMBLY OPH-33

10. CONTROL BOARD ASSEMBLY OPH-34

Switches and pots for the control panel are mounted on the OPH-33 and OPH-34.

11. CONNECTION BOARD (Sub Board)

Input and output jacks, level selector switches, and trimmer pots for fine adjustment of VCO frequency and width are mounted.

12. POWER SUPPLY BOARD ASSEMBLY PSH-13/PSH-14

Either PSH-13 (AC 100-117V) or PSH-14 (AC 220-240V) is mounted.

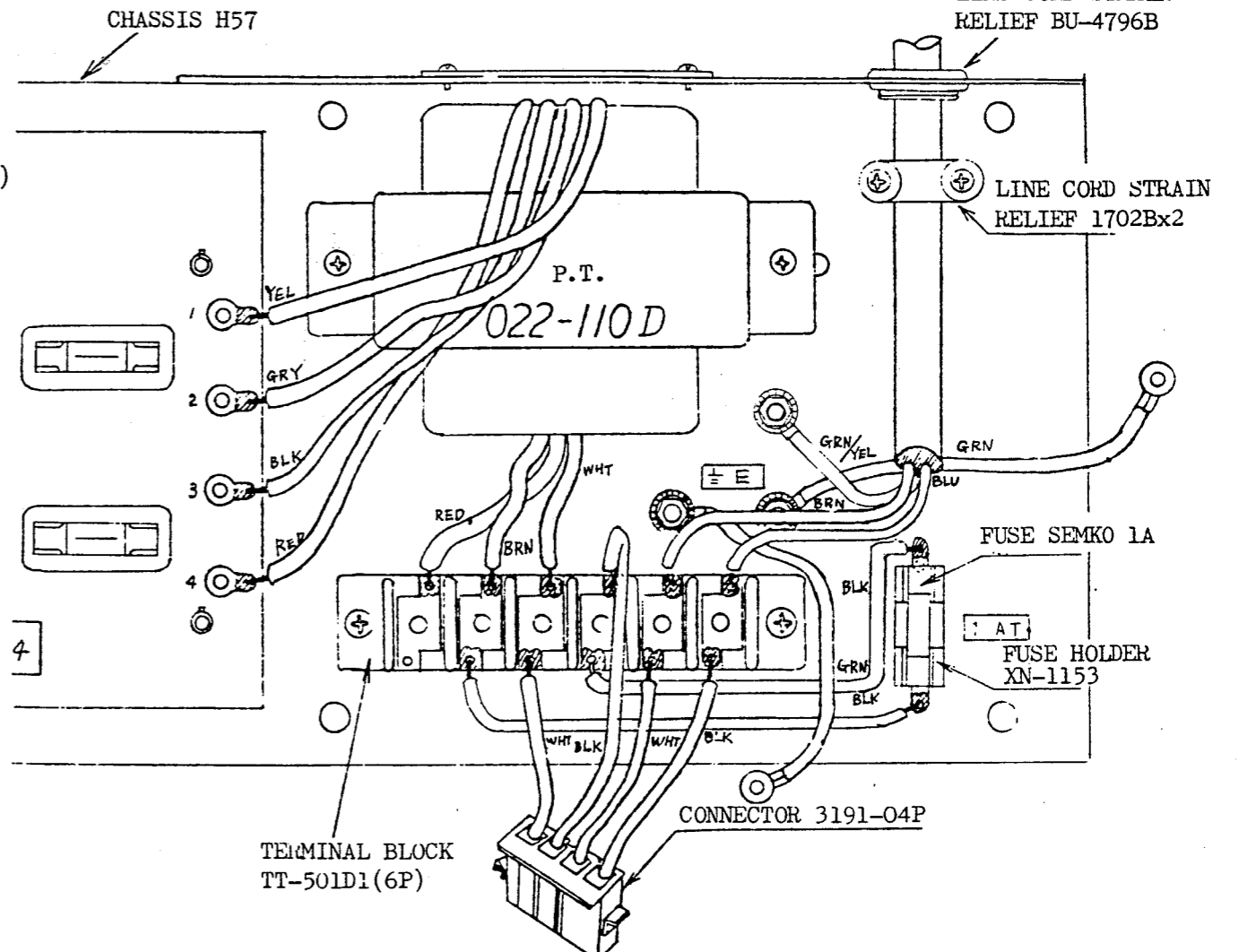
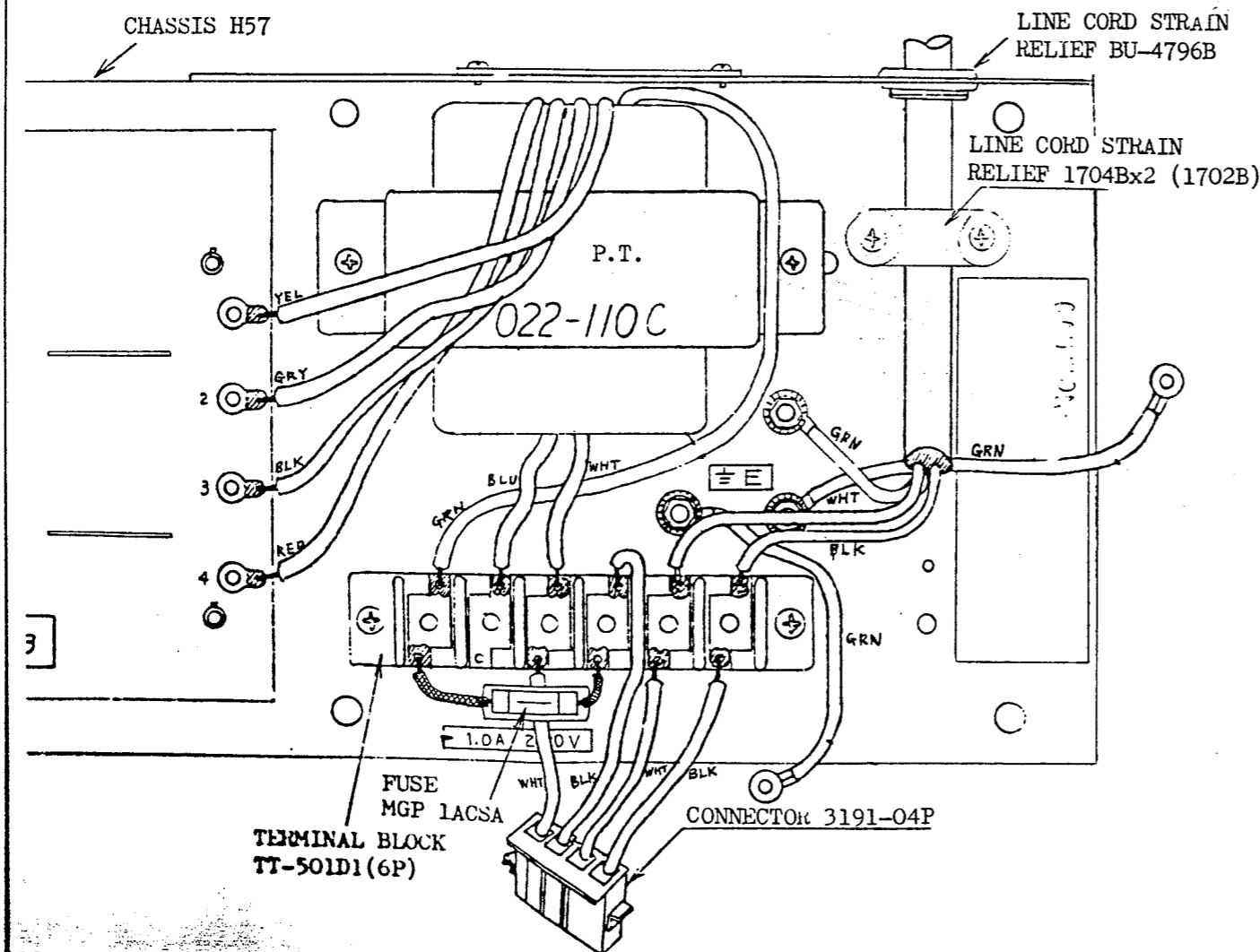
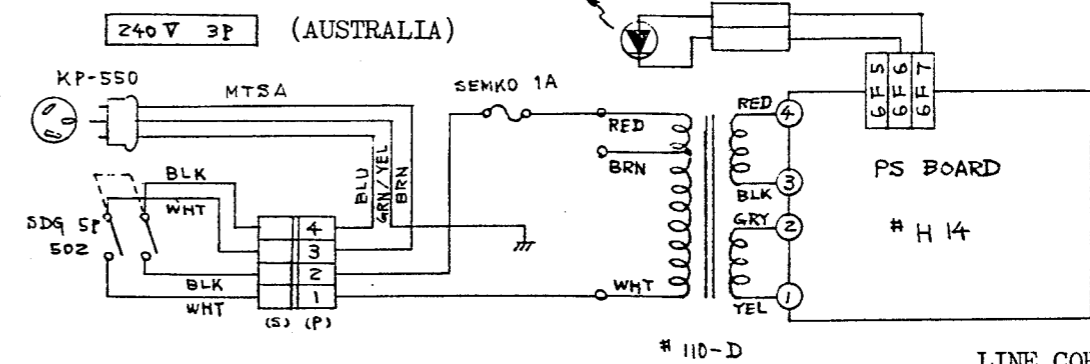
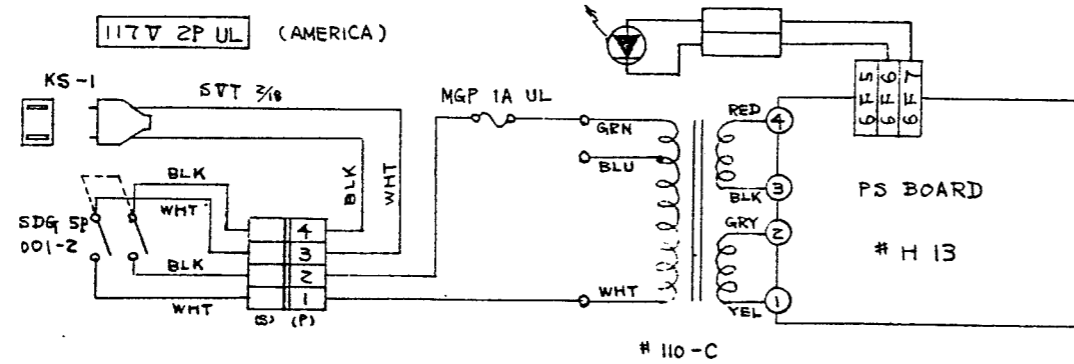
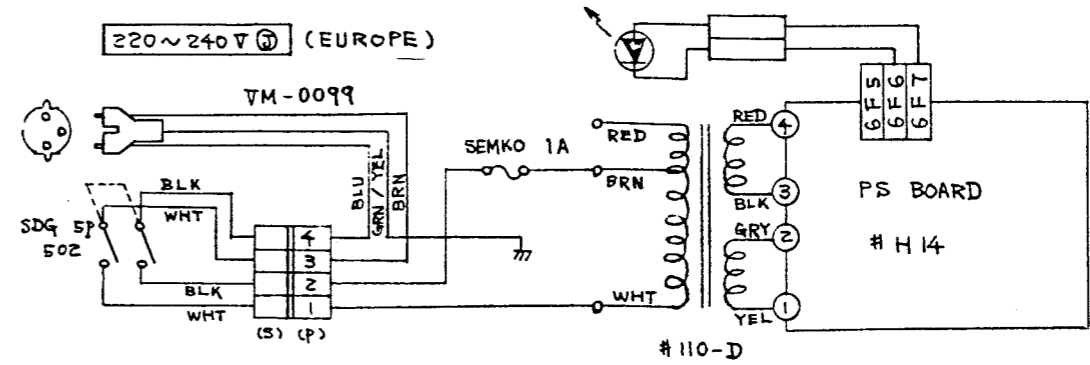
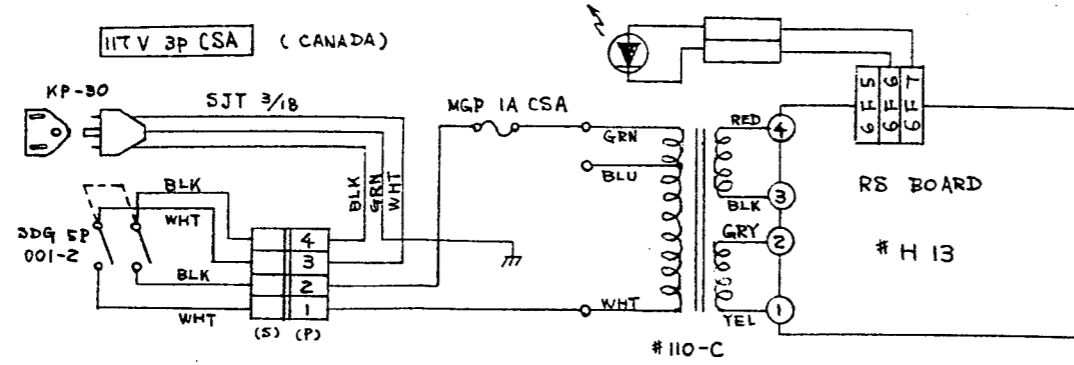

PSH-13A (146H013A) 100/117V
 PSH-14A (146H014A) 220/240V

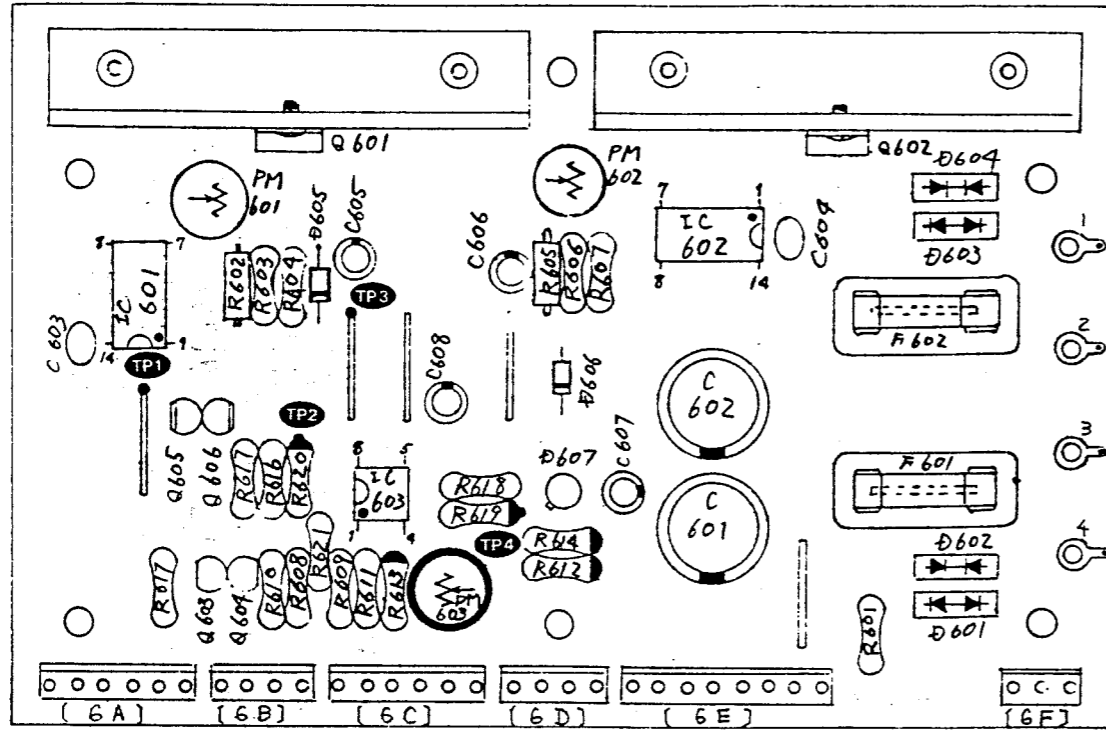

PSH-13/14 - PARTS ON THE FOIL SIDE (SERIAL NO. UP TO 710749)

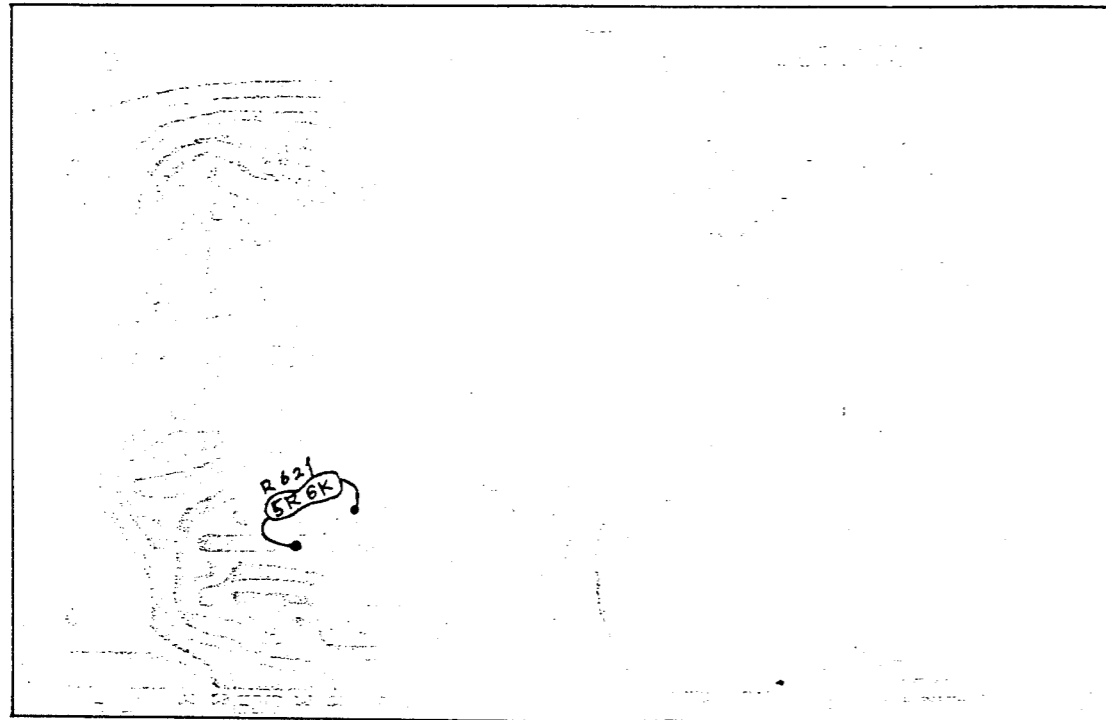

PM601 (1KB): +15V ADJ
 PM602 (1KB): -15V ADJ
 PM603 (1KB): +10V ADJ

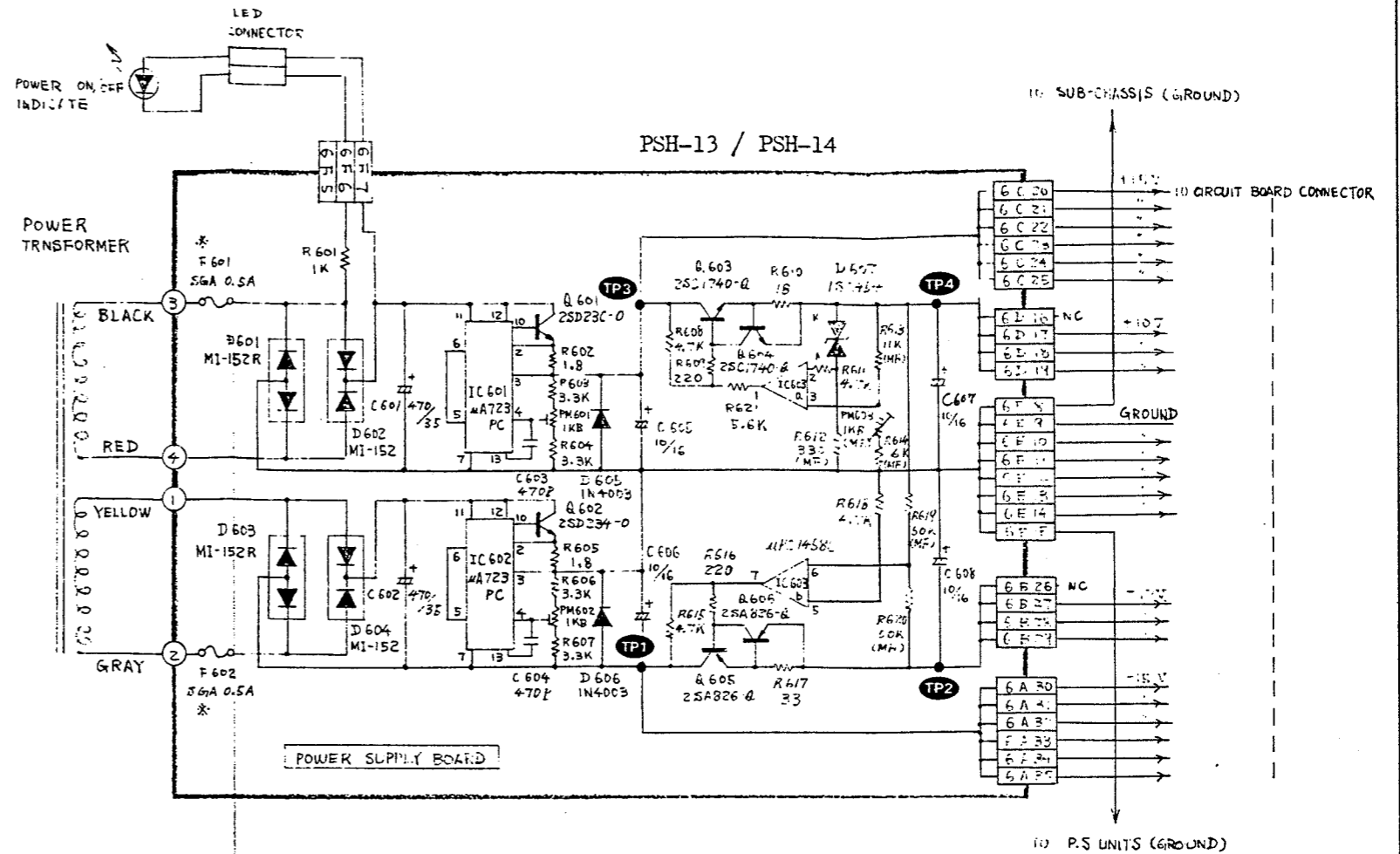

*PSH-13 for 100/117V does not contain FUSE (F601/602), which is the sole difference.

- Resistor CRB1/4FX
- Resistor 1/4RJ
- Resistor R50J
- Mylar 50V-V-K
- Electrolytic ECEA
- Tr 2SC1740-Q
- Tr 2SA733-Q
- Di 1N4003
- Trimmer Pot PNBO4
- Trimmer Pot SR19R

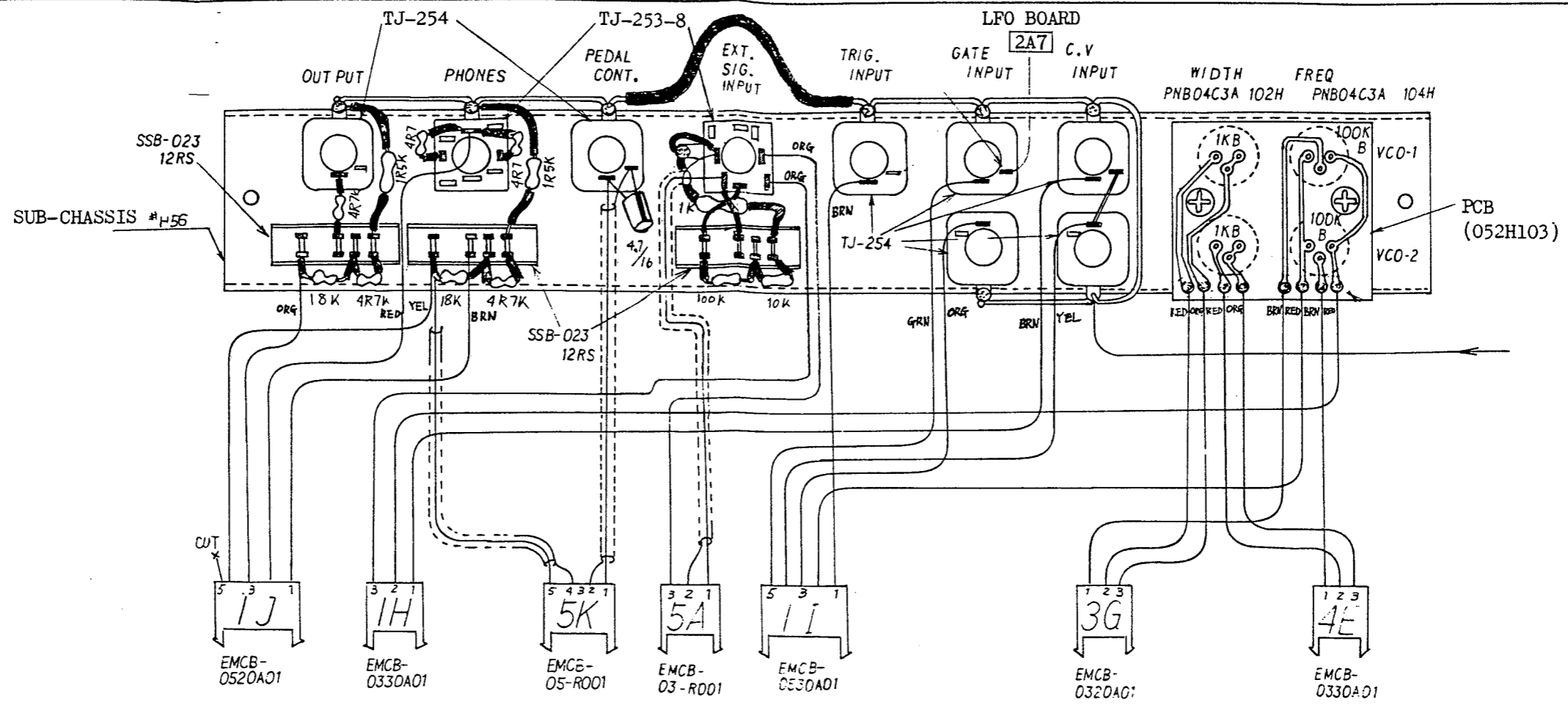

REAR PANEL

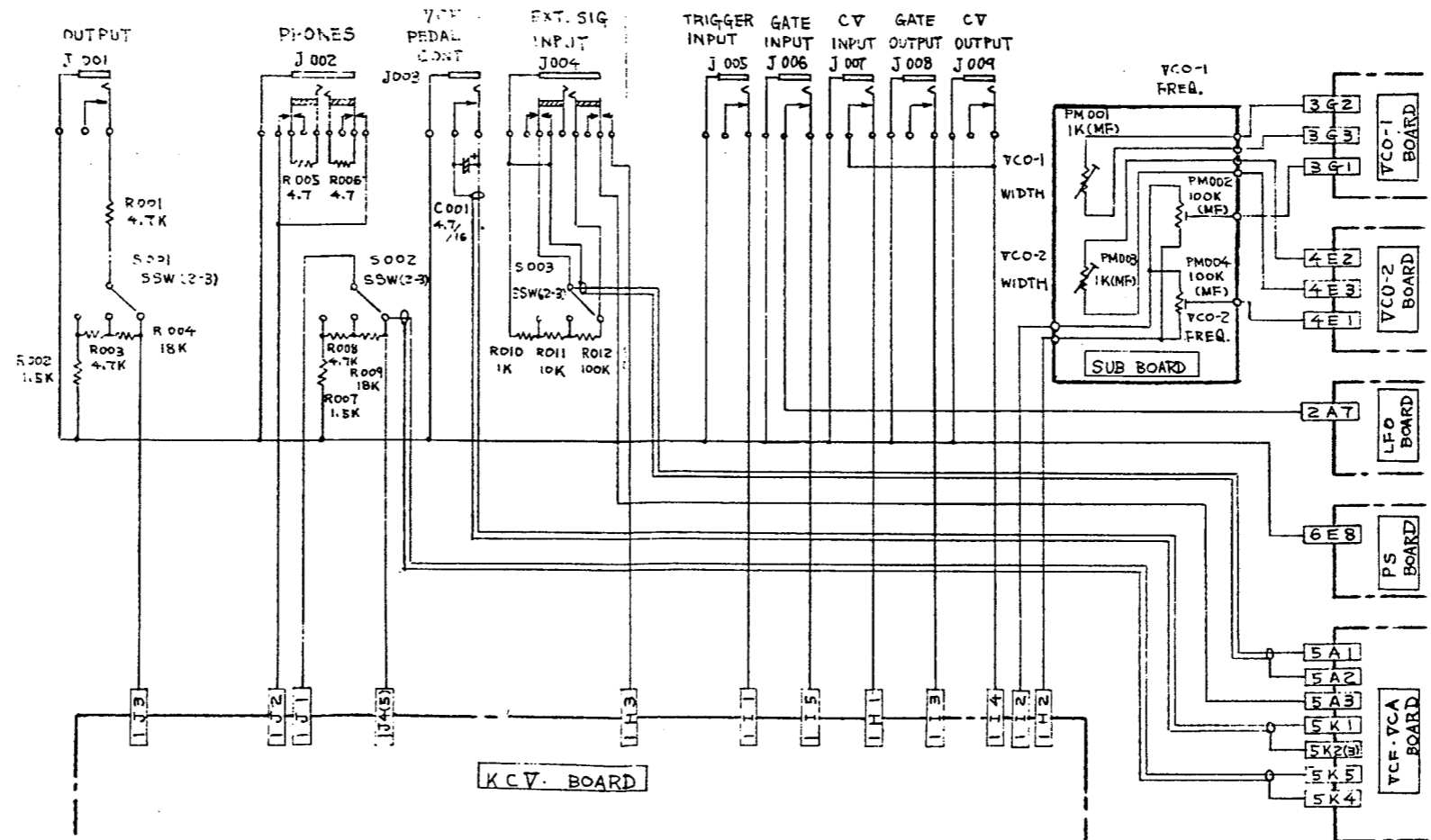

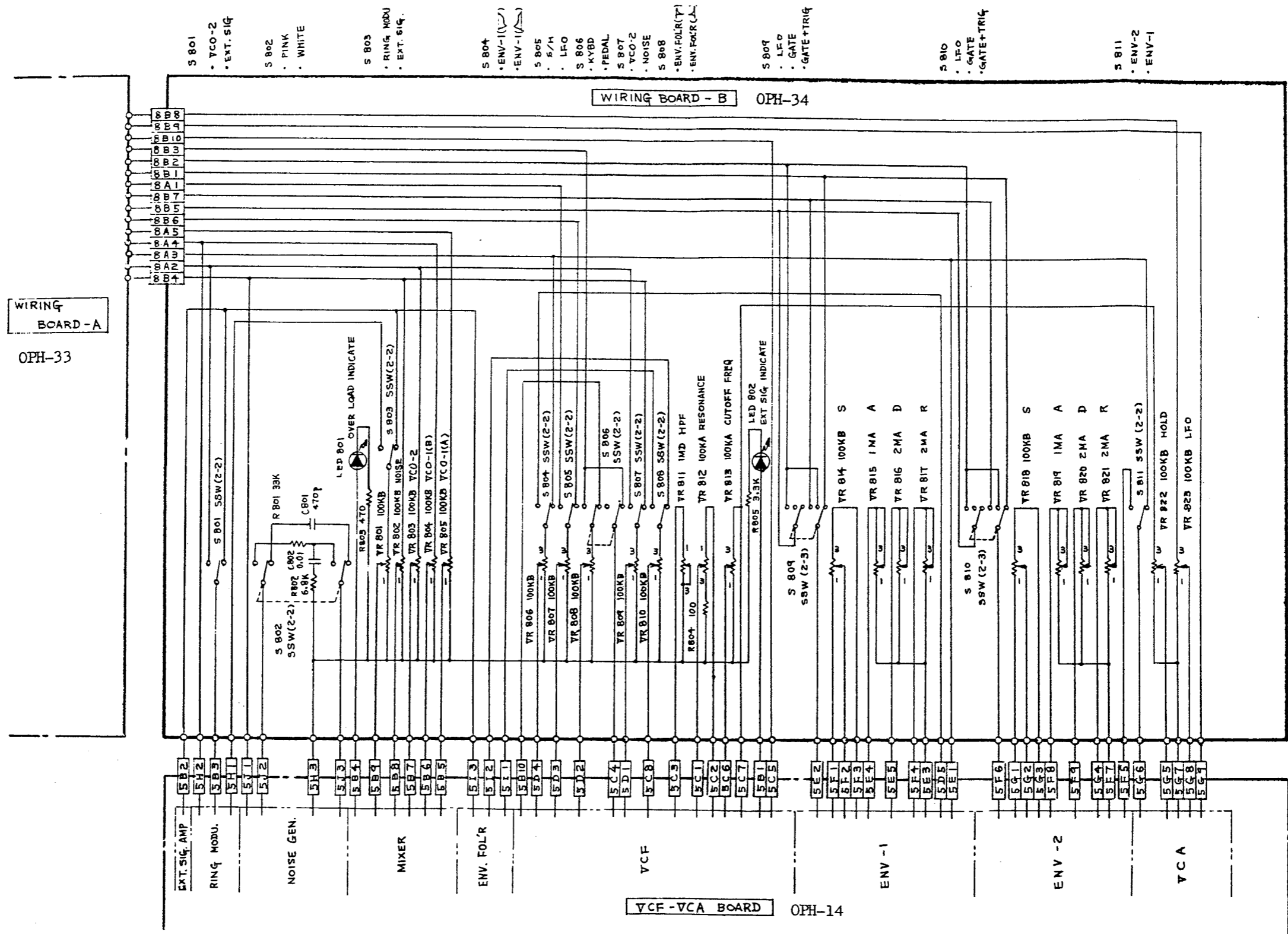

NOTES;
 VR.....30mm Slide Type Potentiometer
 SSW(2-2).....Slide Switch (2 Poles 2 Positions)
 SSW(2-3).....Slide Switch (2 Poles 3 Positions)
 LED.....LR0601R

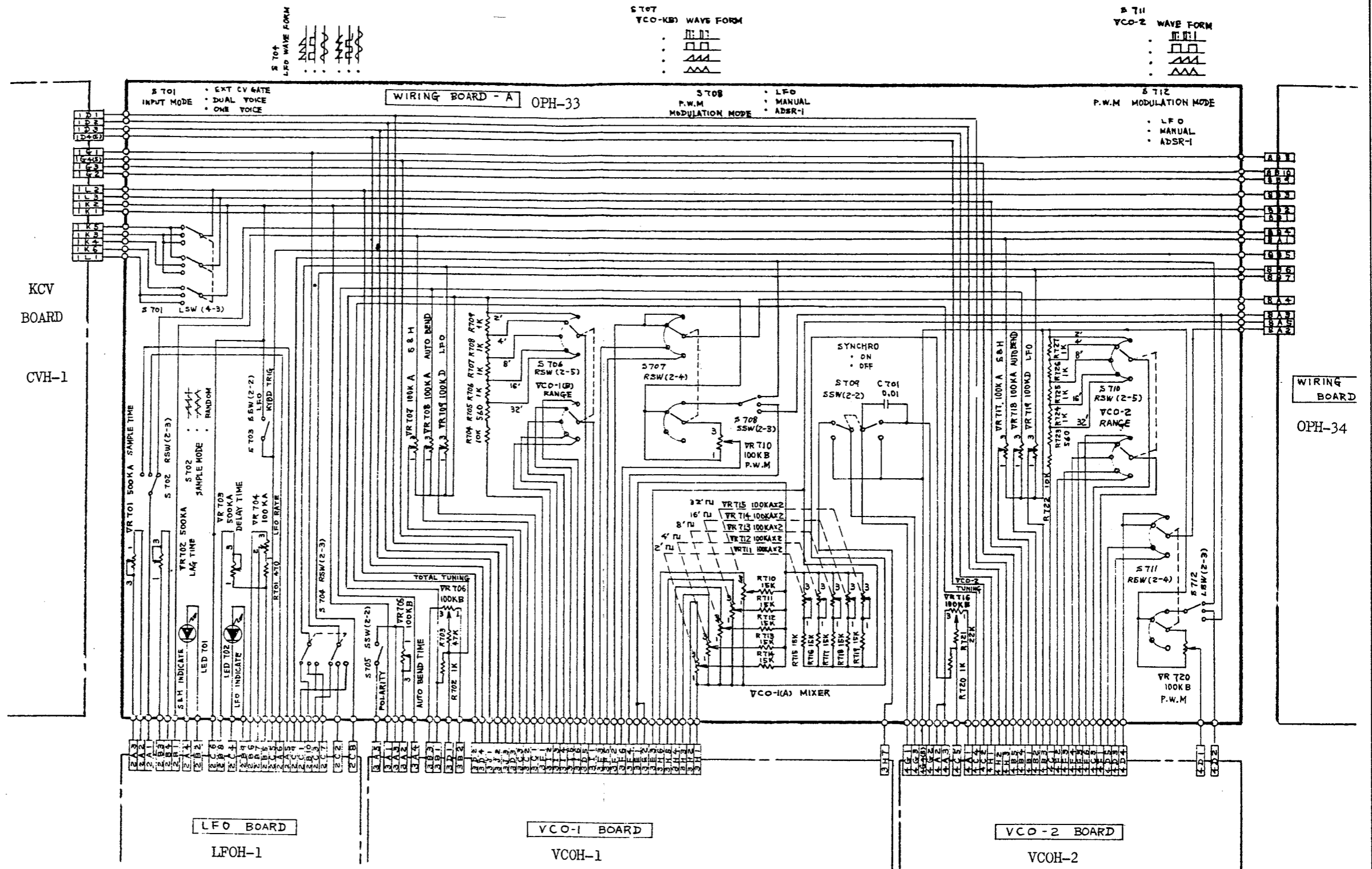

NOTES;
 VR701, 702, 703, 704, 707, 708, 709, 710, 717, 718, 719, 720.....30mm Slide Type Potentiometer
 VR705, 706, 716.....16 ϕ Rotary Type Potentiometer
 VR711, 712, 713, 714, 715.....20mm Dual, Slide Type Potentiometer

LSW.....Lever Switch
 (2-3).....2Poles (Circuits), 3Positions
 RSW.....Rotary Switch
 SSW.....Slide Switch
 LED701, 702.....LRO601R

- S801 (SSB022-12PN): RING MODULATOR
- S802 (SSB022-12PN): NOISE GENERATOR
- S803 (SSB022-12PN): RING/EXT SIG
- S804 (SSB022-12PN): POLARITY (ENV-1)
- S805 (SSB022-12PN): LFO
- S806 (SSB022-12PN): PEDAL/KYBD
- S807 (SSB022-12PN): NOISE/VCO-2
- S808 (SSB022-12PN): POLARITY (ENV FOL'R)
- S809 (SSB023-12PN): GATE+TRIG/GATE/LFO (ENV-1)
- S810 (SSB023-12PN): GATE+TRIG/GATE/LFO (ENV-2)
- S811 (SSB022-12PN): ENV-1/ENV-2

- VR801 (EVA-QOAC16B15 100KB): RING/EXT SIG
- VR802 (EVA-QOAC16B15 100KB): NOISE
- VR803 (EVA-QOAC16B15 100KB): VCO-2
- VR804 (EVA-QOAC16B15 100KB): VCO-1(B)
- VR805 (EVA-QOAC16B15 100KB): VCO-1(A)
- VR806 (EVA-QOAC16B15 100KB): ENV-1
- VR807 (EVA-QOAC16B15 100KB): LFO/S&H
- VR808 (EVA-QOAC16B15 100KB): KYBD/PEDAL
- VR809 (EVA-QOAC16B15 100KB): VCO-2/NOISE
- VR810 (EVA-QOAC16B15 100KB): ENV FOL'R
- VR811 (EVA-QOAC16D16 1MD): HPP
- VR812 (EVA-QOAC16A15 100KA): RESONANCE

- VR813 (EVA-QOAC16B15 100KB): CUTOFF FREQ
- VR814 (EVA-QOAC16B15 100KB): SUSTAIN (ENV-1)
- VR815 (EVA-QOAC16A16 1MA): ATTACK (ENV-1)
- VR816 (EVA-QOAC16A26 2MA): DECAY (ENV-1)
- VR817 (EVA-QOAC16A26 2MA): RELEASE (ENV-1)
- VR818 (EVA-QOAC16B15 100KB): SUSTAIN (VCO-2)
- VR819 (EVA-QOAC16A16 1MA): ATTACK (ENV-2)
- VR820 (EVA-QOAC16A26 2MA): DECAY (ENV-2)
- VR821 (EVA-QOAC16A26 2MA): RELEASE (ENV-2)
- VR822 (EVA-QOAC16B15 100KB): HOLD
- VR823 (EVA-QOAC16B15 100KB): LFO

OPH-34 (149H034)

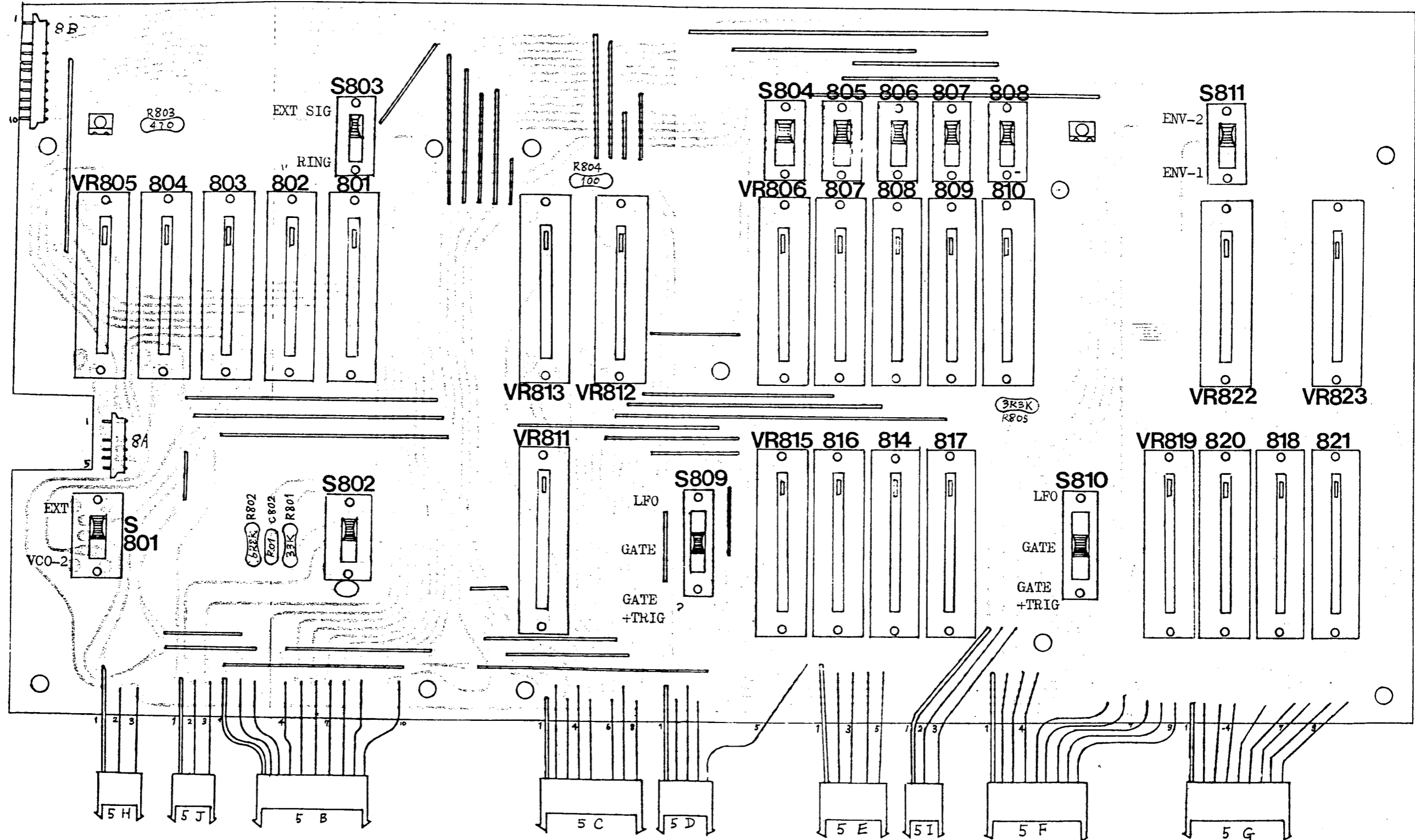

S701 (SLE643-18P): INPUT MODE
 S702 (SRN1023N-K25): SAMPLE MODE

S703 (SSB022-12PN): KYBD TRIG
 S704 (SRN1023N-K25): WAVEFORM
 S705 (SSB022-12PN): POLARITY
 S706 (SRN1025N-K25): RANGE (VCO-1)
 S707 (SRN1024N-K25): WAVEFORM (VCO-1)
 S708 (SSB023-12PN): PWM MODE (VCO-1)
 S709 (SSB022-12PN): SYNC
 S710 (SRN1025N-K25): RANGE (VCO-2)
 S711 (SRN1024N-K25): WAVEFORM (VCO-2)
 S712 (SSB023-12PN): PWM MODE (VCO-2)

VR701 (EVA-QOAC16A55 500KA): SAMPLE TIME
 VR702 (EVA-QOAC16A55 500KA): LAG TIME
 VR703 (EVA-QOAC16A55 500KA): DELAY TIME
 VR704 (EVA-QOAC16A15 100KA): LFO RATE
 VR705 (VM10R-K15B15 100KB): AUTOBEND TIME
 VR706 (VM10R-K15B15 100KB): TOTAL TUNING
 VR707 (EVA-QOAC16A15 100KA): S&H (VCO-1)
 VR708 (EVA-QOAC16A15 100KA): AUTOBEND (VCO-1)
 VR709 (EVA-QOAC16D15 100KD): LFO (VCO-1)
 VR710 (EVA-QOAC16B15 100KB): PWM (VCO-1)

VR711 (EVB-LOAC16A15 100KA x 2): 2' (VCO-1)
 VR712 (EVB-LOAC16A15 100KA x 2): 4' (VCO-1)
 VR713 (EVB-LOAC16A15 100KA x 2): 8' (VCO-1)
 VR714 (EVB-LOAC16A15 100KA x 2): 16' (VCO-1)
 VR715 (EVB-LOAC16A15 100KA x 2): 32' (VCO-1)
 VR716 (VM10R-K15B15 100KB): VCO-2 TUNING
 VR717 (EVA-QOAC16A15 100KA): S&H (VCO-2)
 VR718 (EVA-QOAC16A15 100KA): AUTOBEND (VCO-2)
 VR719 (EVA-QOAC16D15 100KD): LFO (VCO-2)
 VR720 (EVA-QOAC16B15 100KB): PWM (VCO-2)

OPH-33 (149H033)

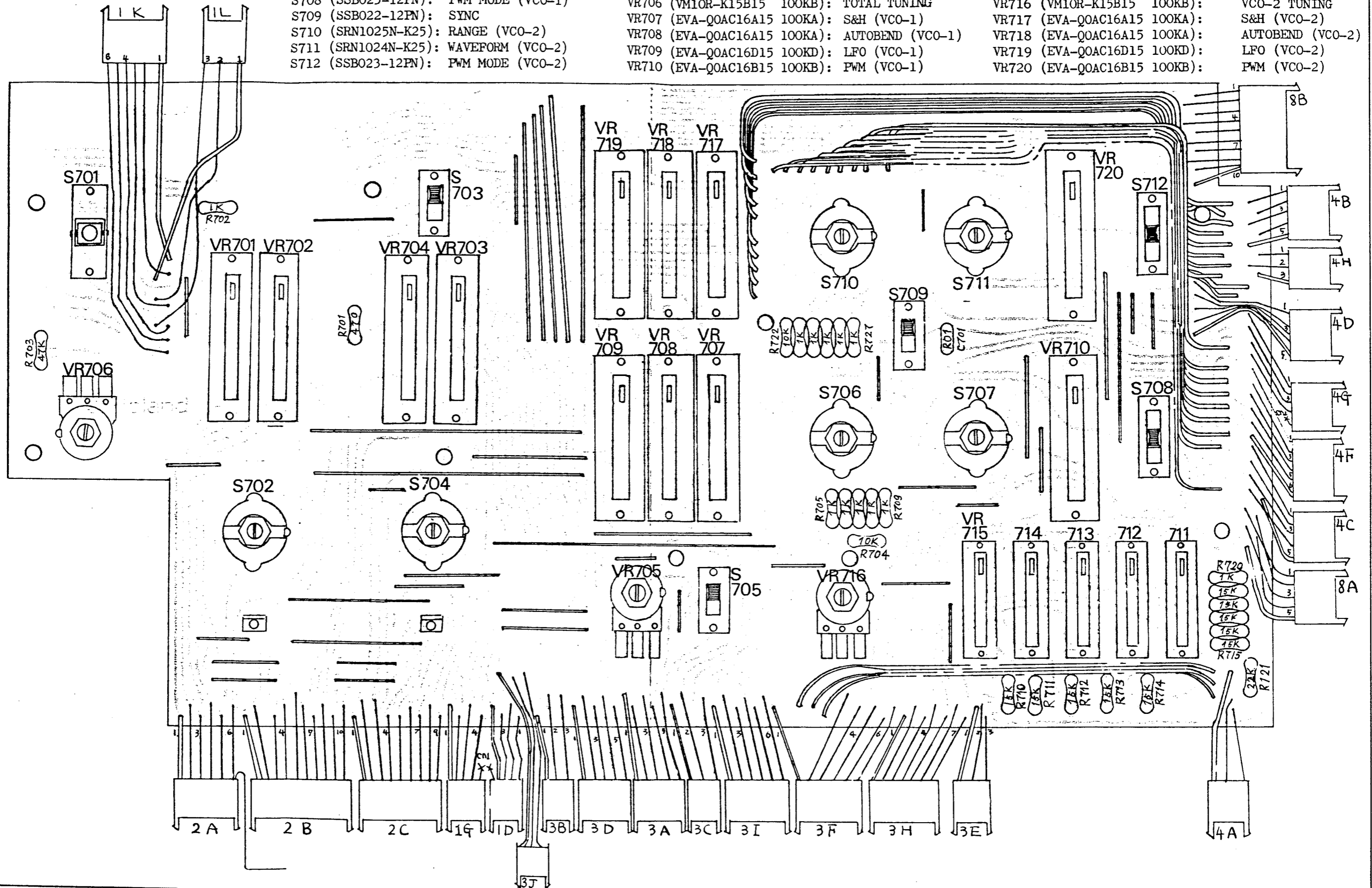

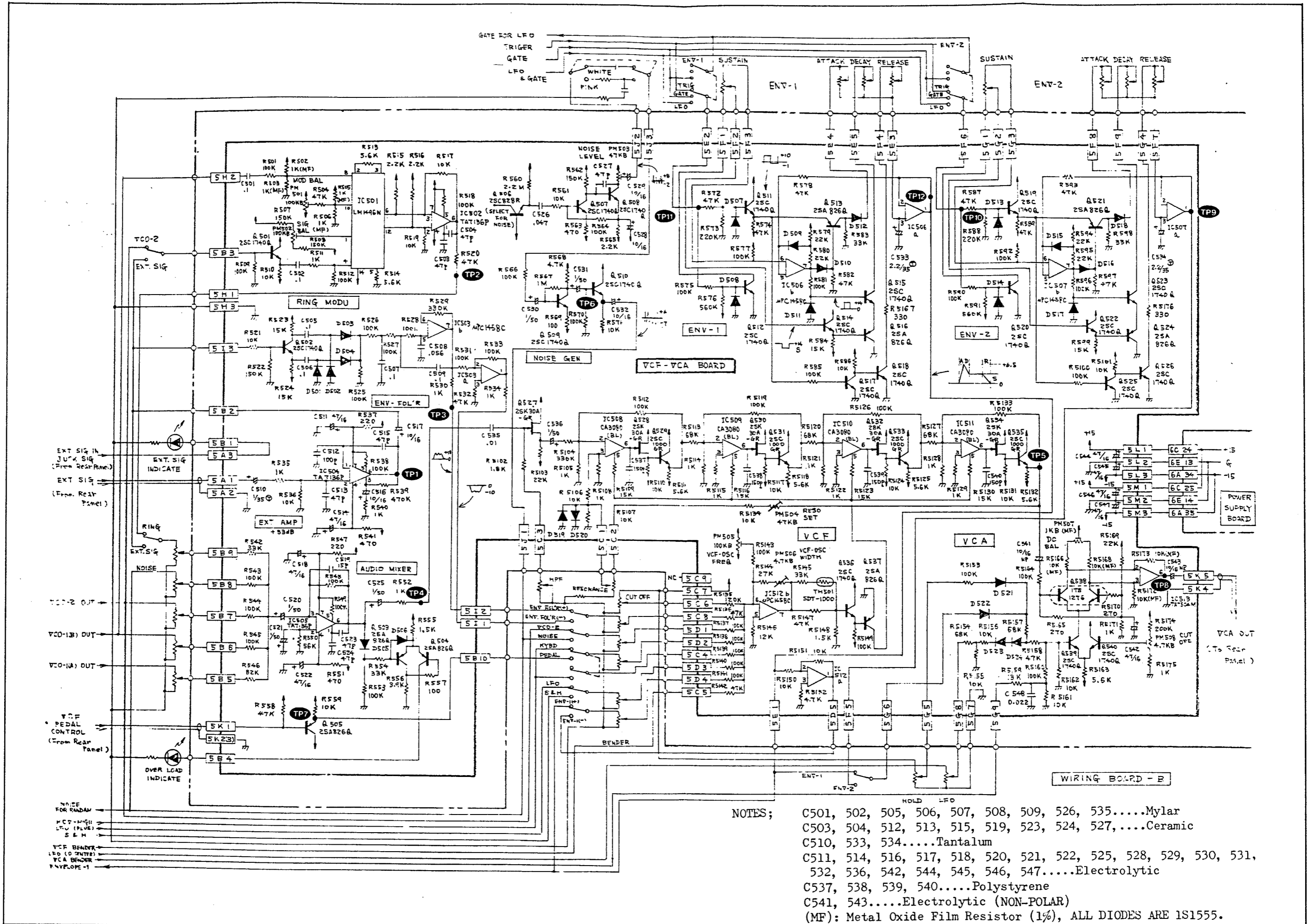

OPH-14 (149H014) (SERIAL NO. UP TO 710749)

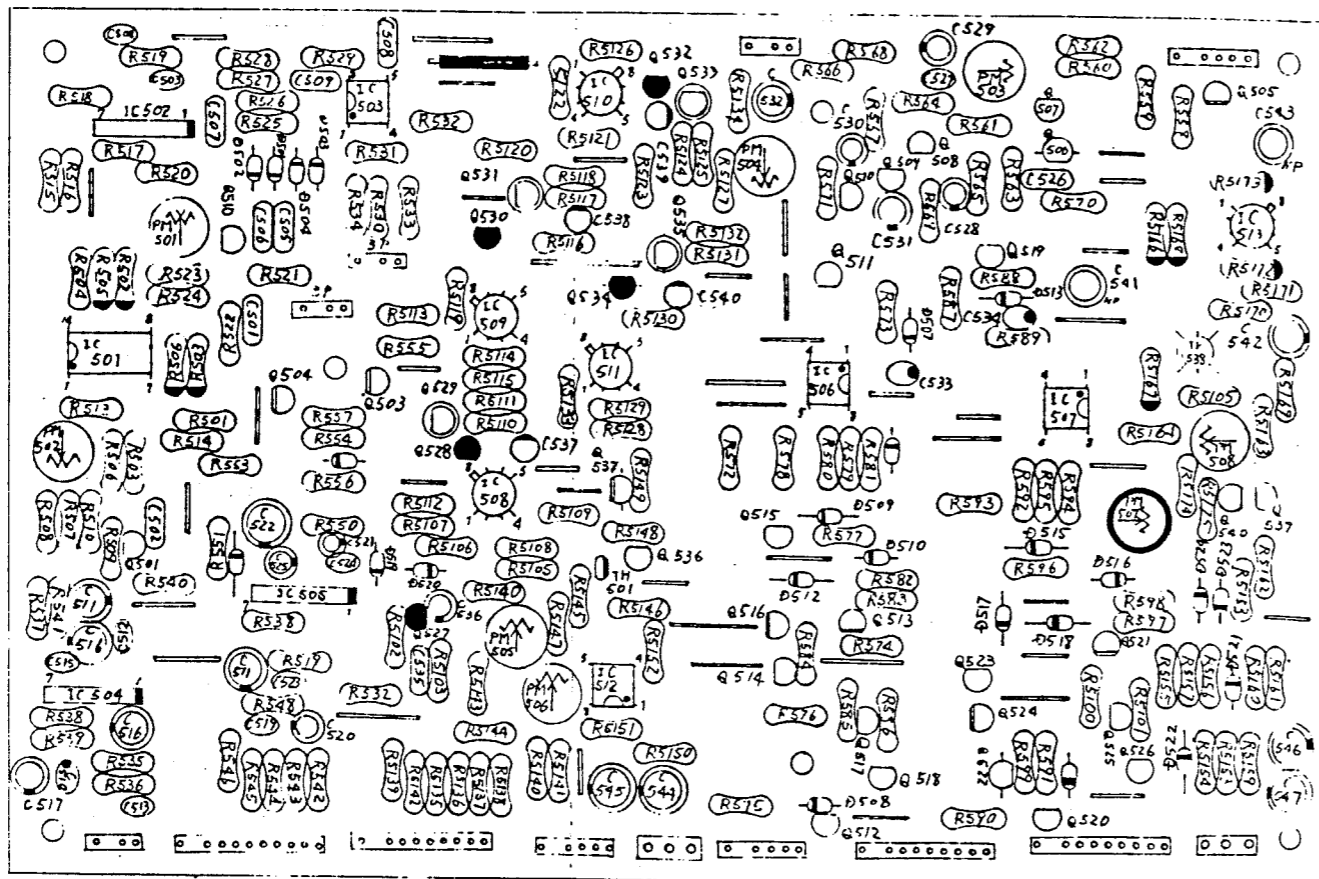

OPH-14 - PARTS ON THE FOIL SIDE

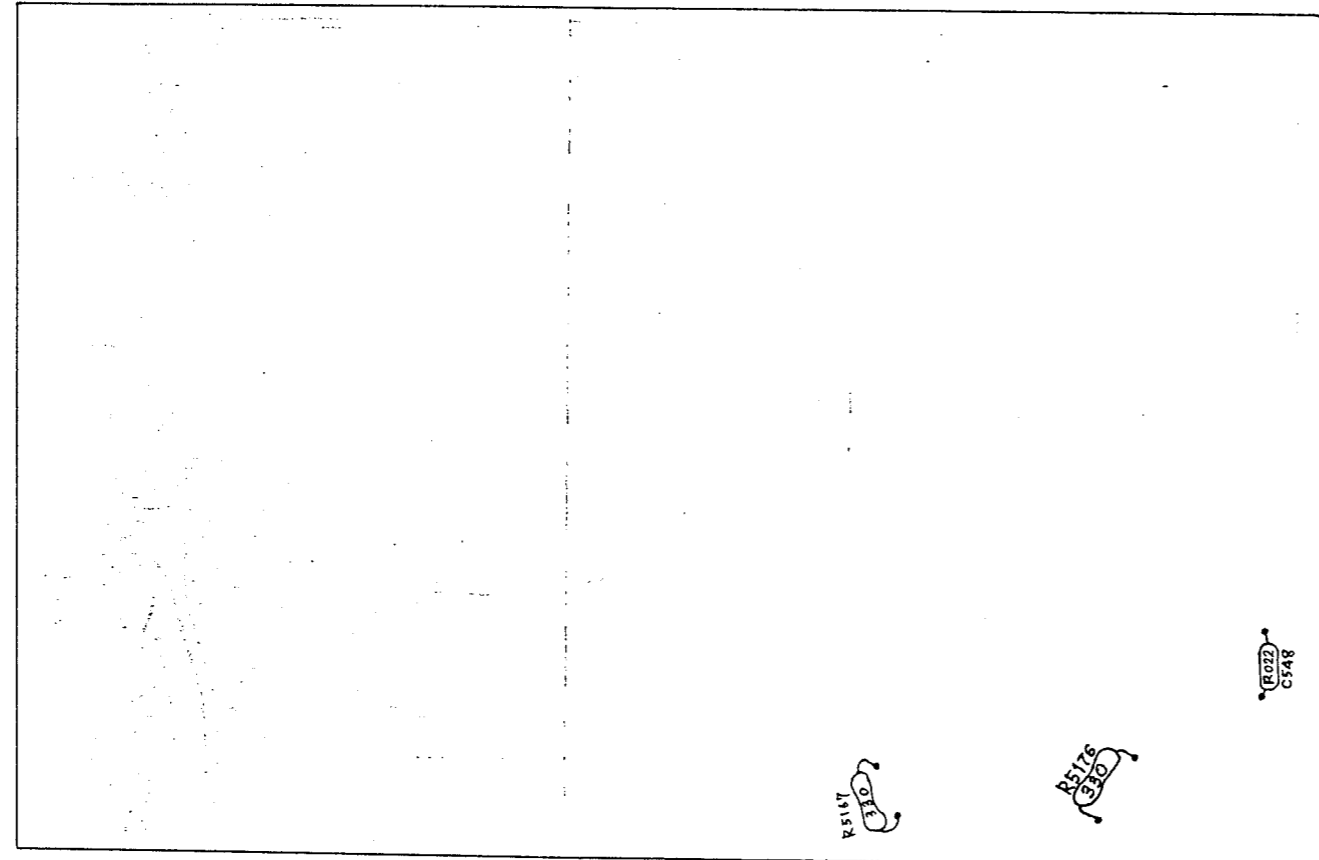

OPH-14A (149H014A) (SERIAL NO. 720750 AND HIGHER)

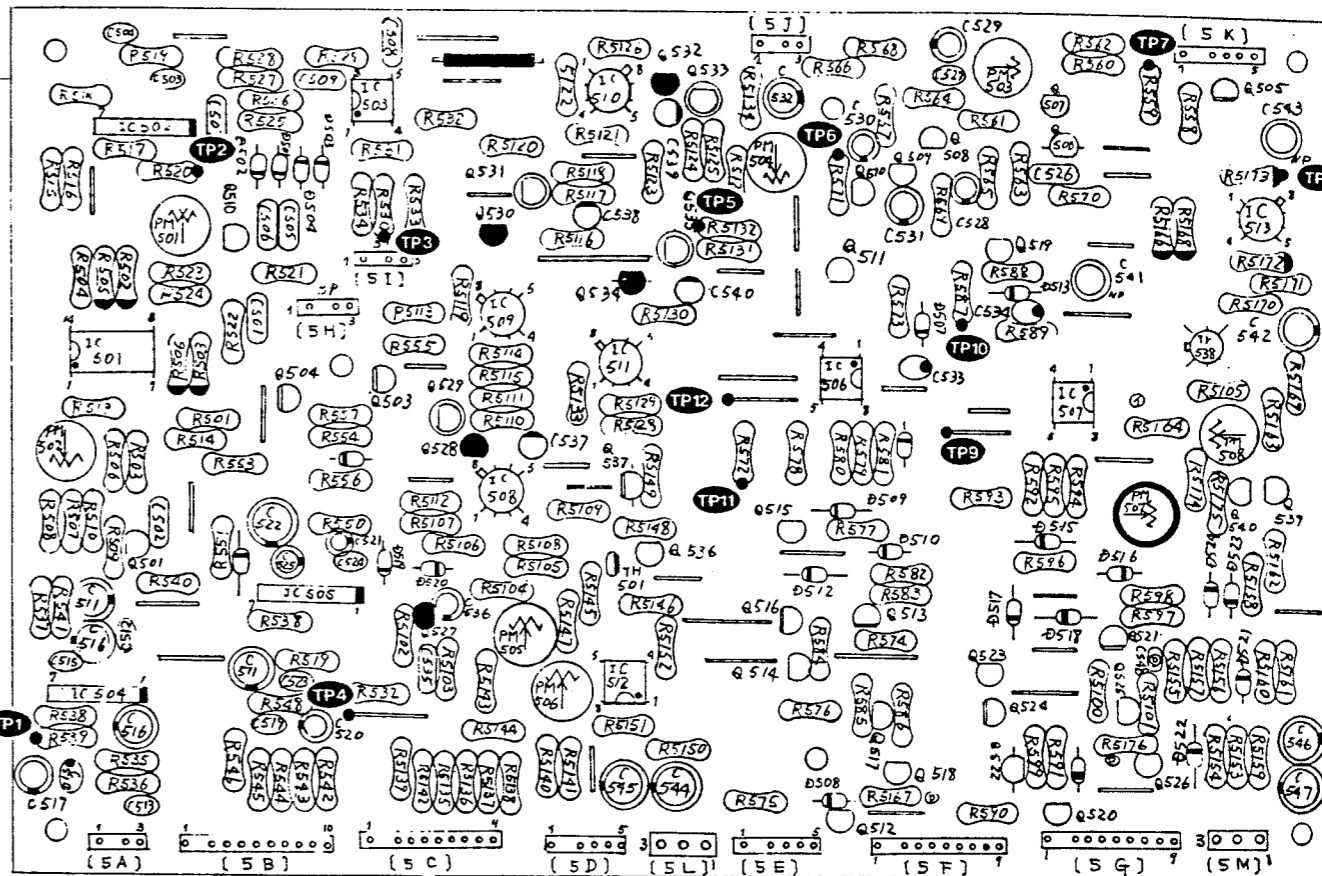

OPH-14A

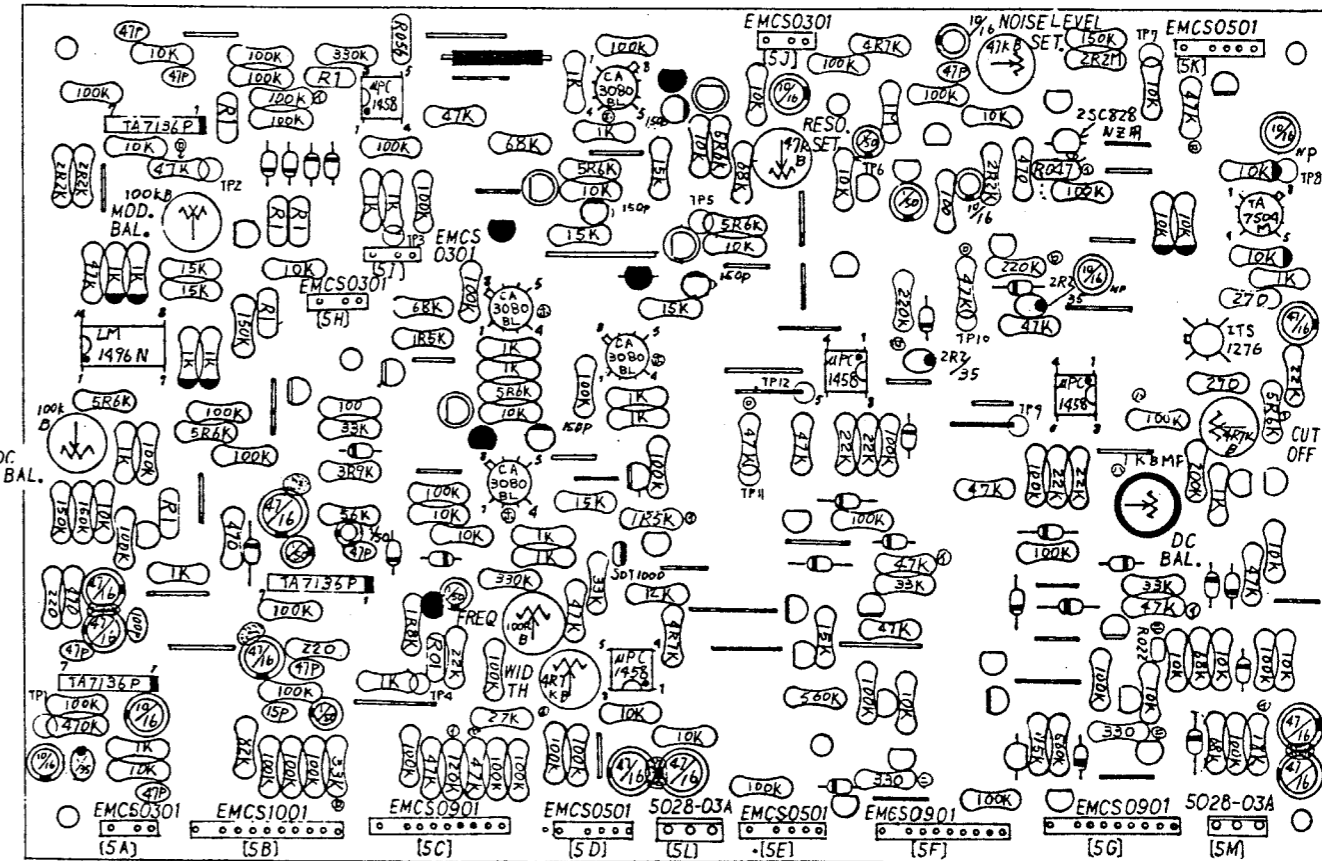

- Resistor CRB1/4FX
- Resistor 1/4RJ
- Mylar 50V-V-K
- Ceramic 50V-V-K
- Electrolytic ECEA
- Styrol 125V-V-K
- Tantalum 35V-V-K
- Thermistor SDT1000
- FET 2SK30A-GR
- Tr 2SC 1000-GR
- Tr 2SC 1740-Q
- Tr 2SA826-Q
- Di 1S1555
- Trimmer Pot SR19R
- Trimmer Pot PNB04

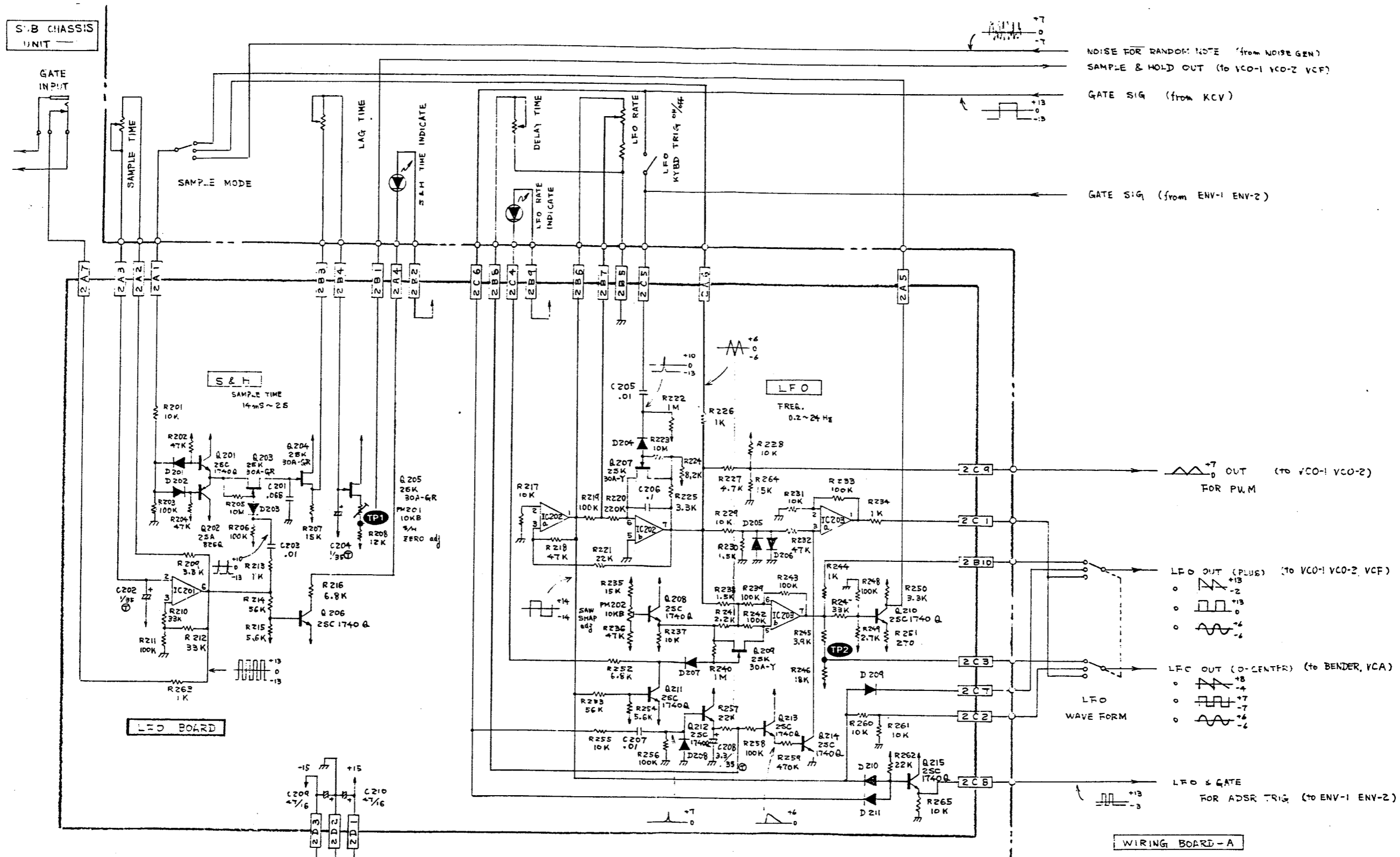

- NOTES:
- IC201.....TA7504M
 - IC202, 203..... μ PC1458C
 - C201, 203, 205, 206, 207.....Mylar
 - C202, 204, 208.....Tantalum
 - C209, 210.....Electrolytic (MF) ; Metal Oxide Film Resistor (1%)
 - ALL DIODES ARE 1S1555.



WIRING BOARD-A

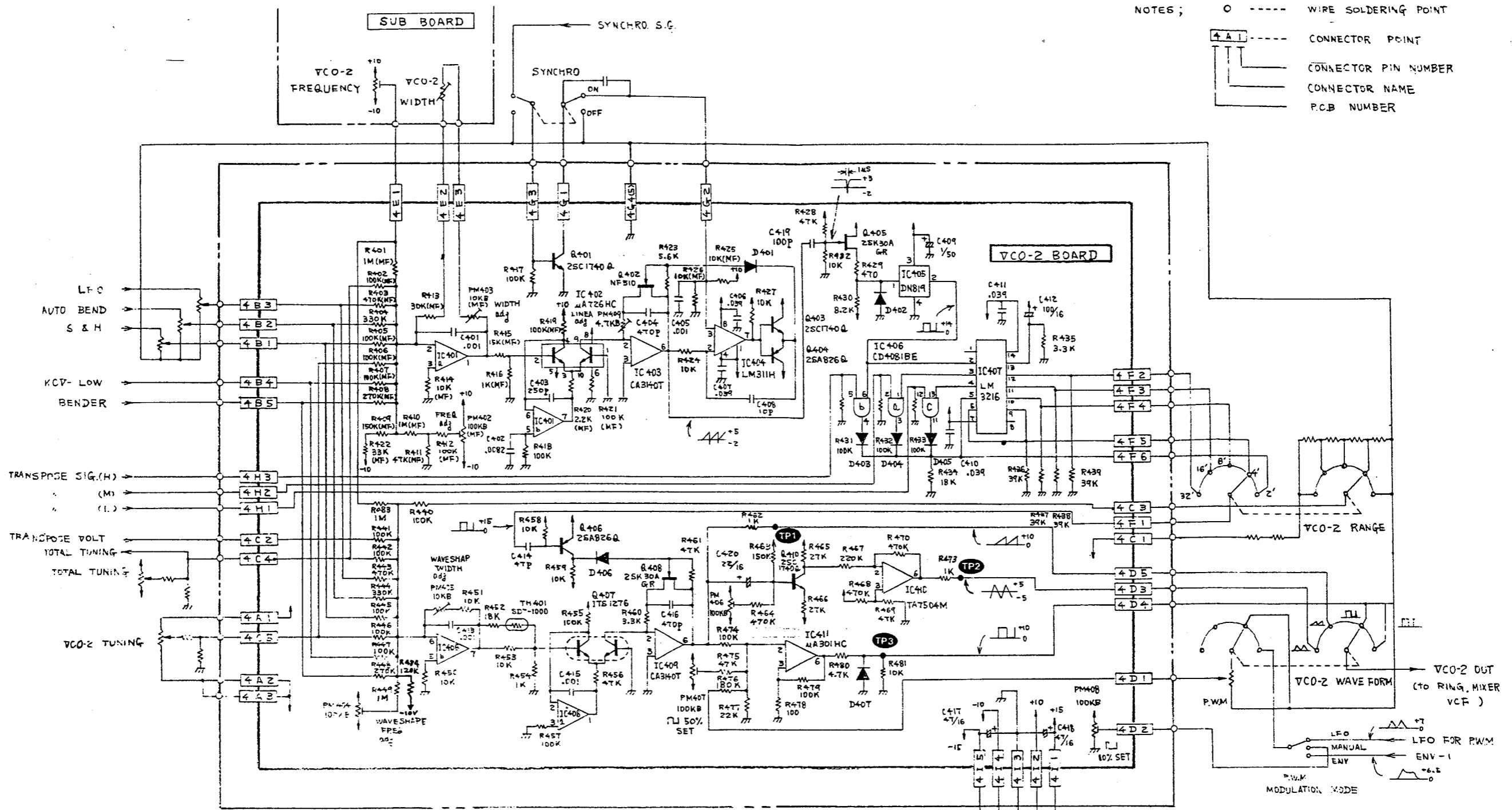

NOTES; ○ ----- WIRE SOLDERING POINT
 [---] ----- CONNECTOR POINT
 [---] ----- CONNECTOR PIN NUMBER
 [---] ----- CONNECTOR NAME
 [---] ----- P.C.B NUMBER

NOTES;
 IC401, 408.....µPC1458C
 C401, 402, 405, 406, 407, 410, 411, 413, 415.....Mylar
 C403, 408, 414, 419.....Ceramic
 C404, 416.....Polystyrene
 C409, 412, 417, 418.....Electrolytic
 (MF) ; Metal Oxide Film Resistor (1%)
 ALL DIODES ARE 1S1555.

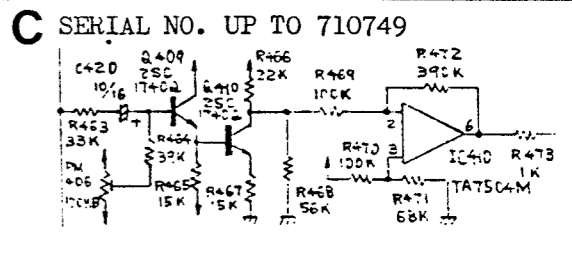
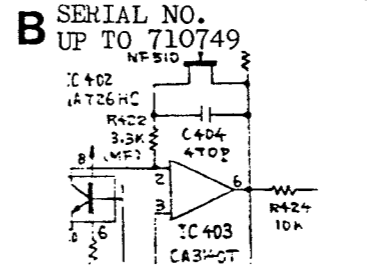
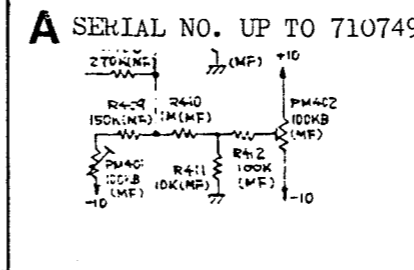
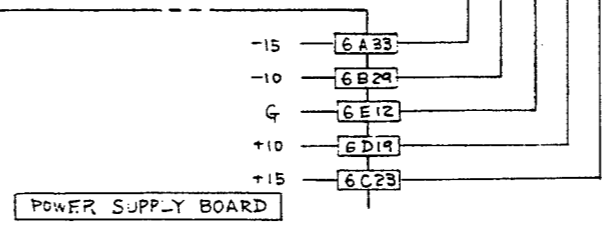

VCOH-2 (152H002) (SERIAL NO. UP TO 670199)

VCOH-2A (152H002A) (SERIAL NO. 680200-710749)

VCOH-2B (152H002B) (SERIAL NO. 720750 AND HIGHER)

PM403:
WIDTH
PM402:
FREQ
(FINE)
PM401:
FREQ

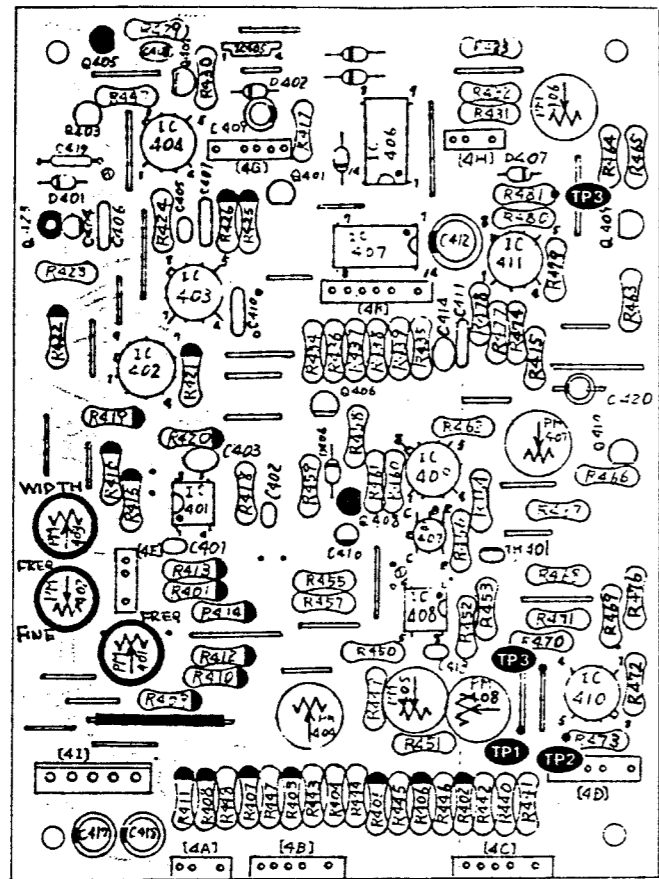

PM403:
WIDTH
PM402:
FREQ
(FINE)
PM401:
FREQ

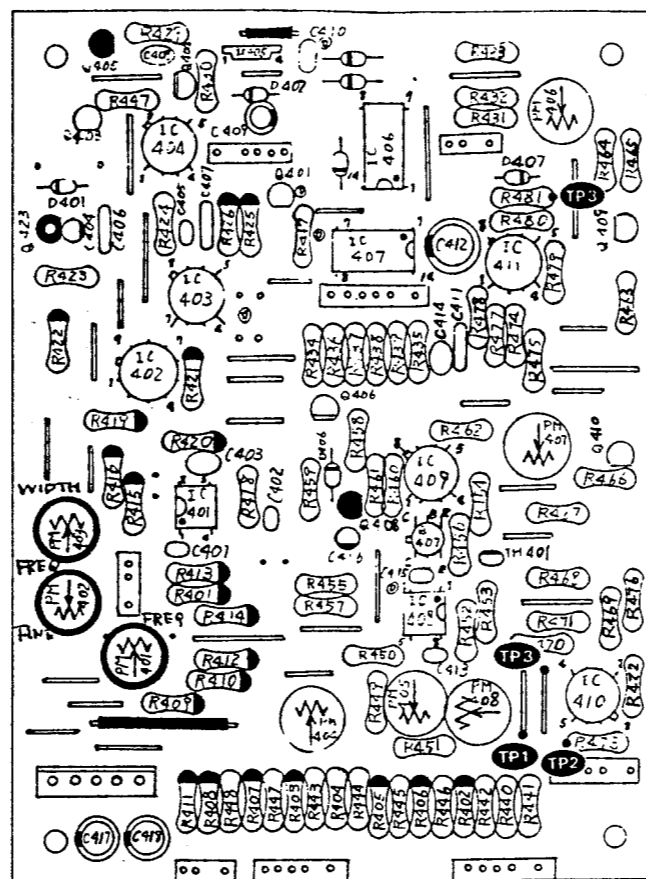

PM409:
LINEARITY
PM403:
WIDTH
PM402:
FREQ

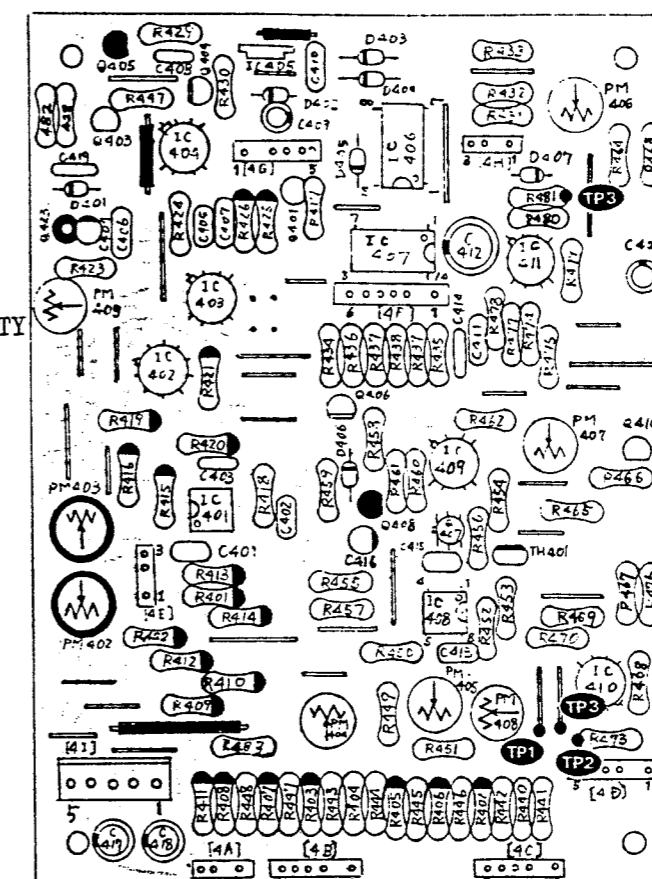

- Resistor CRB1/4FX
- Resistor 1/4RJ
- Mylar 50V-V-K
- Ceramic 50V-V-K
- Electrolytic ECEA
- Styrol 125V-V-K
- Thermistor SDT-1000
- Tr 2SC1740-Q
- Tr 2SA826-Q
- FET 2SK30A-GR
- FET NF-510
- Di 1S155
- Trimmer Pot FNBO4
- Trimmer Pot SR19R

VCOH-2 - PARTS ON THE FOIL SIDE

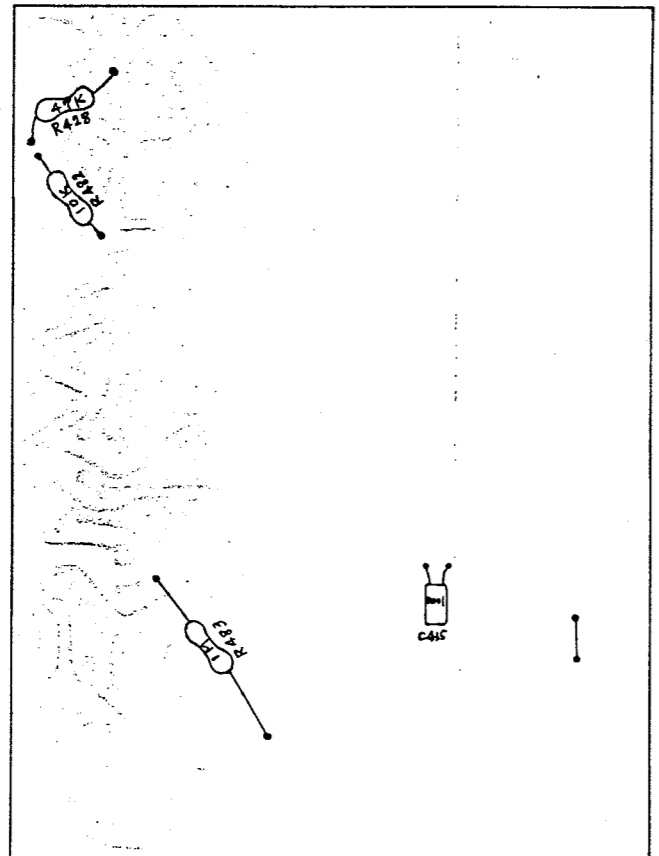

VCOH-2A - PARTS ON THE FOIL SIDE

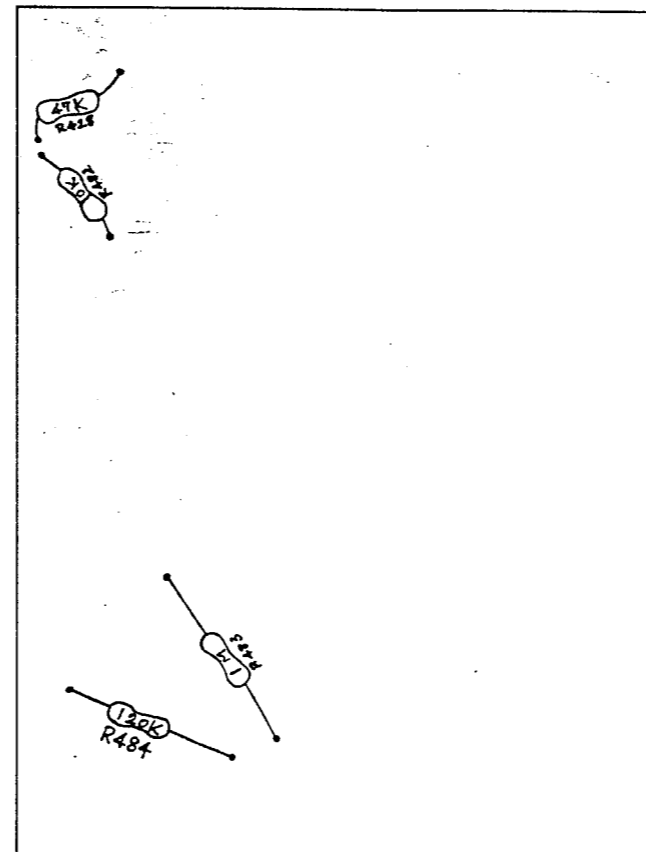

VCOH-2B

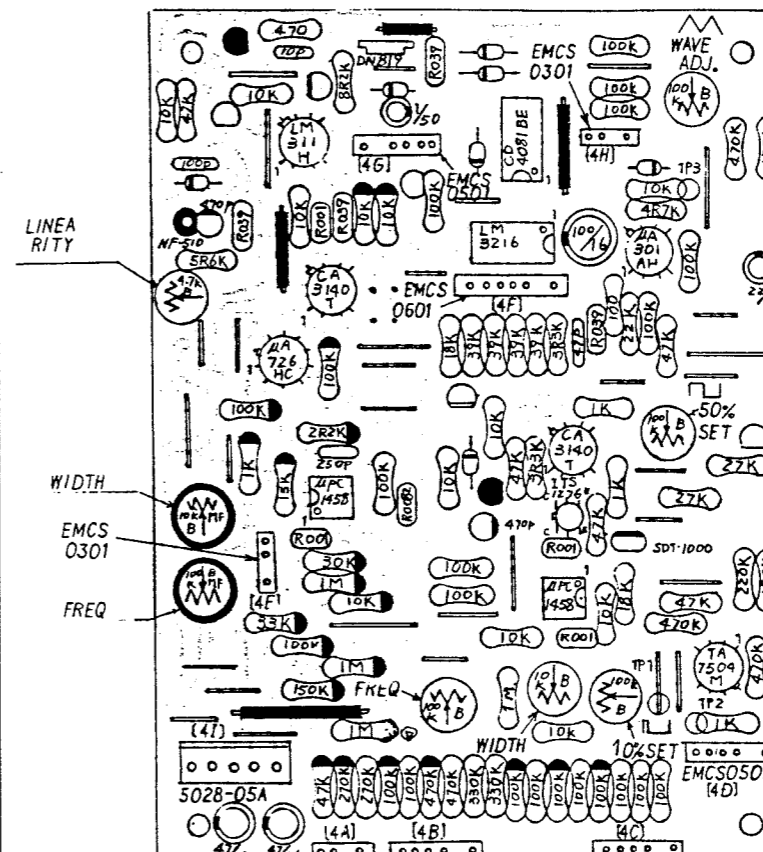

* R484 mounted on the foil side of VCOH-2B.

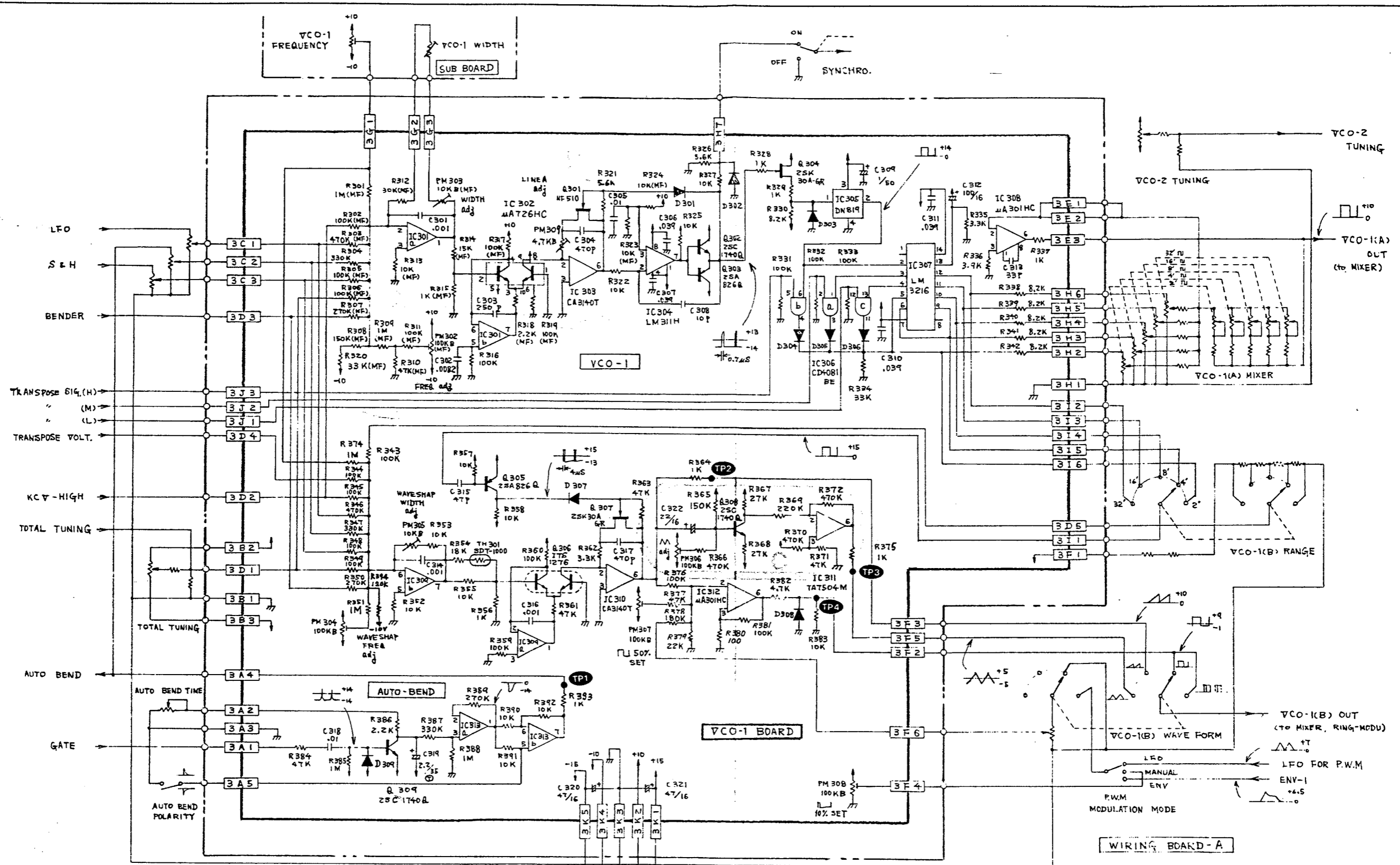

NOTES;
 IC301, 309, 313..... μ PC1458C
 C301, 302, 305, 306, 307, 310, 311,
 314, 316, 318.....Mylar
 C303, 308, 313, 315.....Ceramic
 C304, 317.....Polystyrene
 C309, 312, 320, 321.....Electrolytic
 C319.....Tantalum
 (MF) ; Metal Oxide Film Resistor (1%)
 ALL DIODES ARE 1S1555.

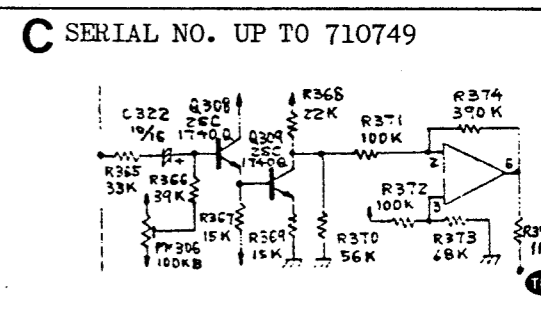
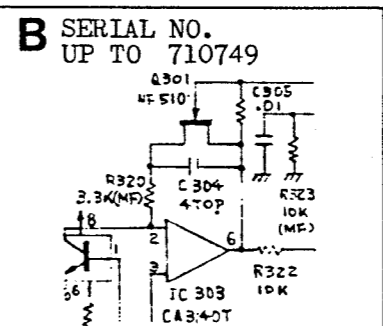
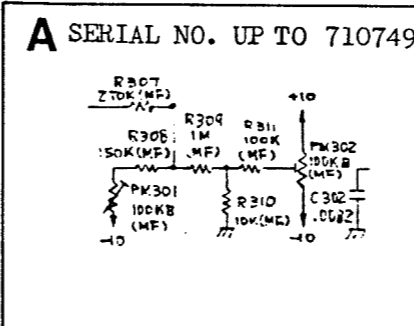
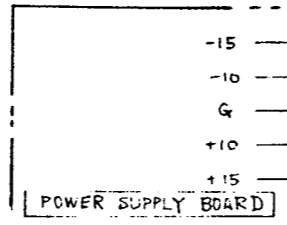

VCOH-1 (152H001) (SERIAL NO. UP TO 710749)

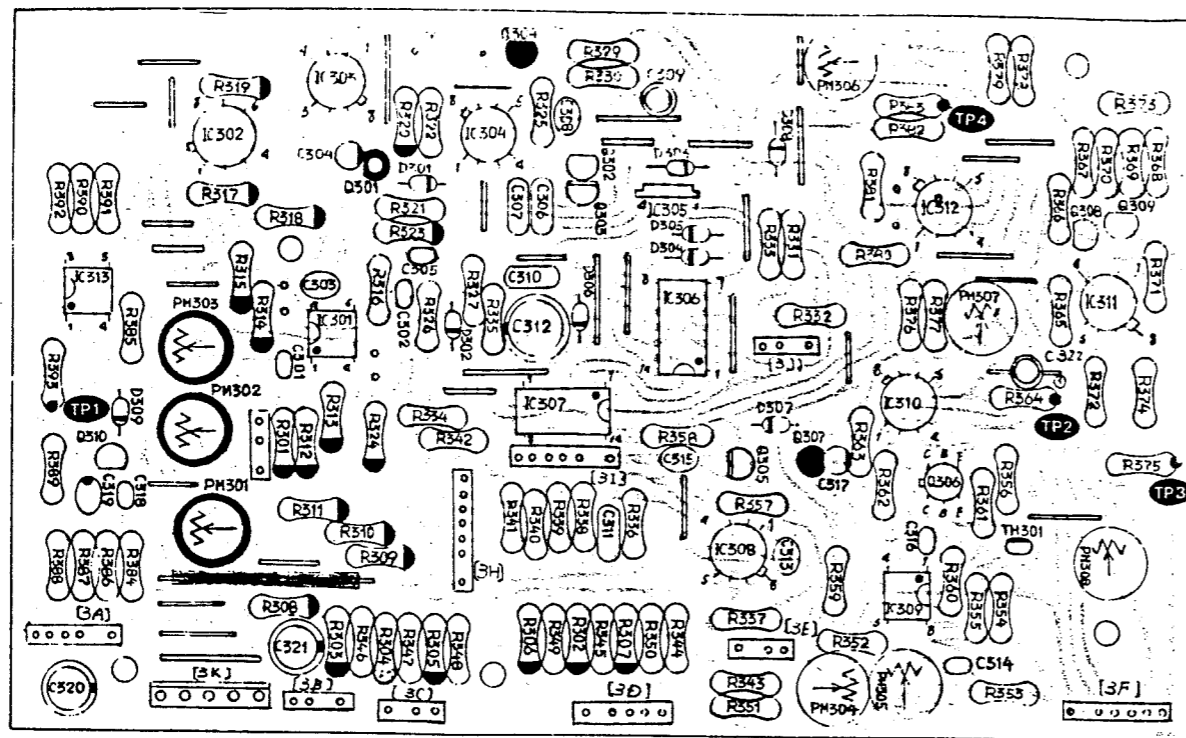

VCOH-1A(152H001A) (SERIAL NO. 720750 AND HIGHER)

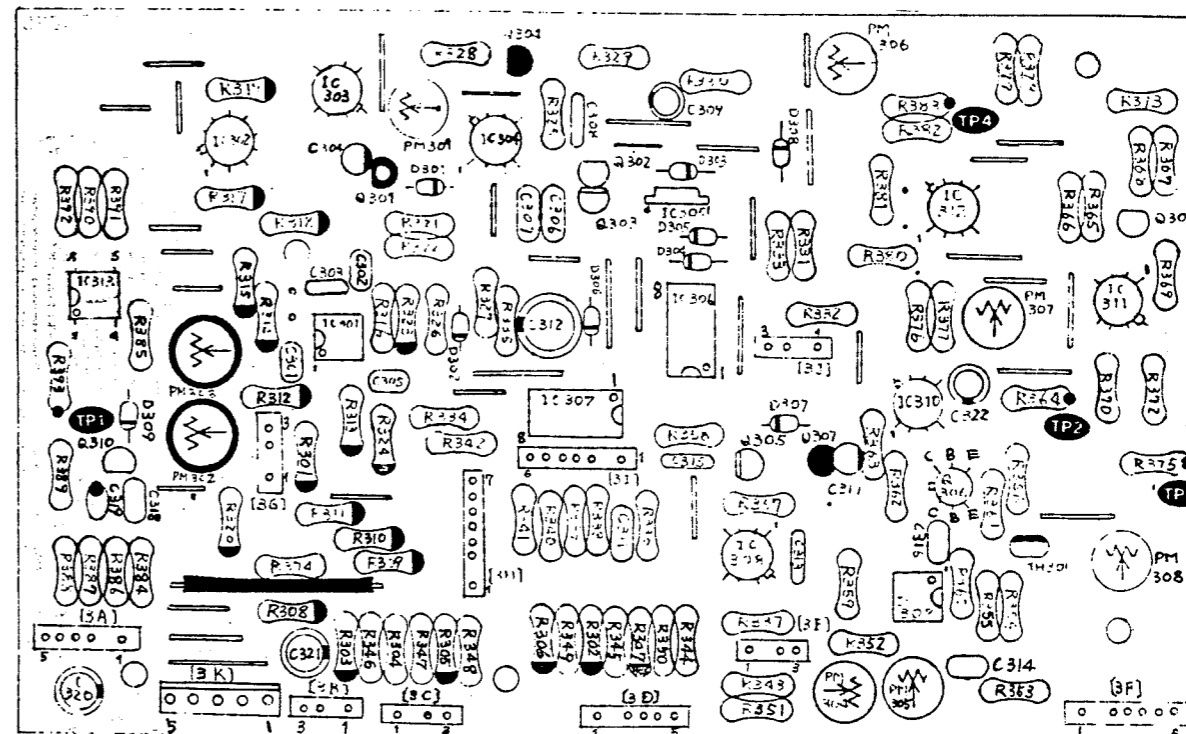

VCOH-1 - PARTS ON THE FOIL SIDE

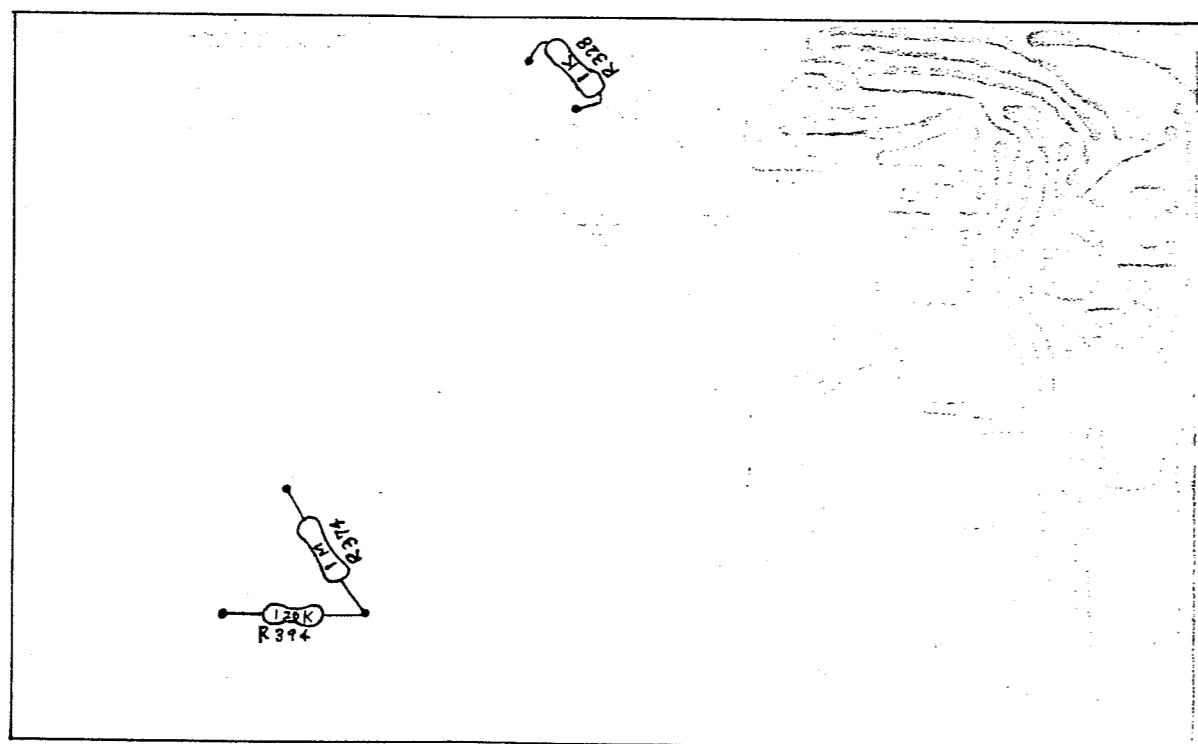

VCOH-1A

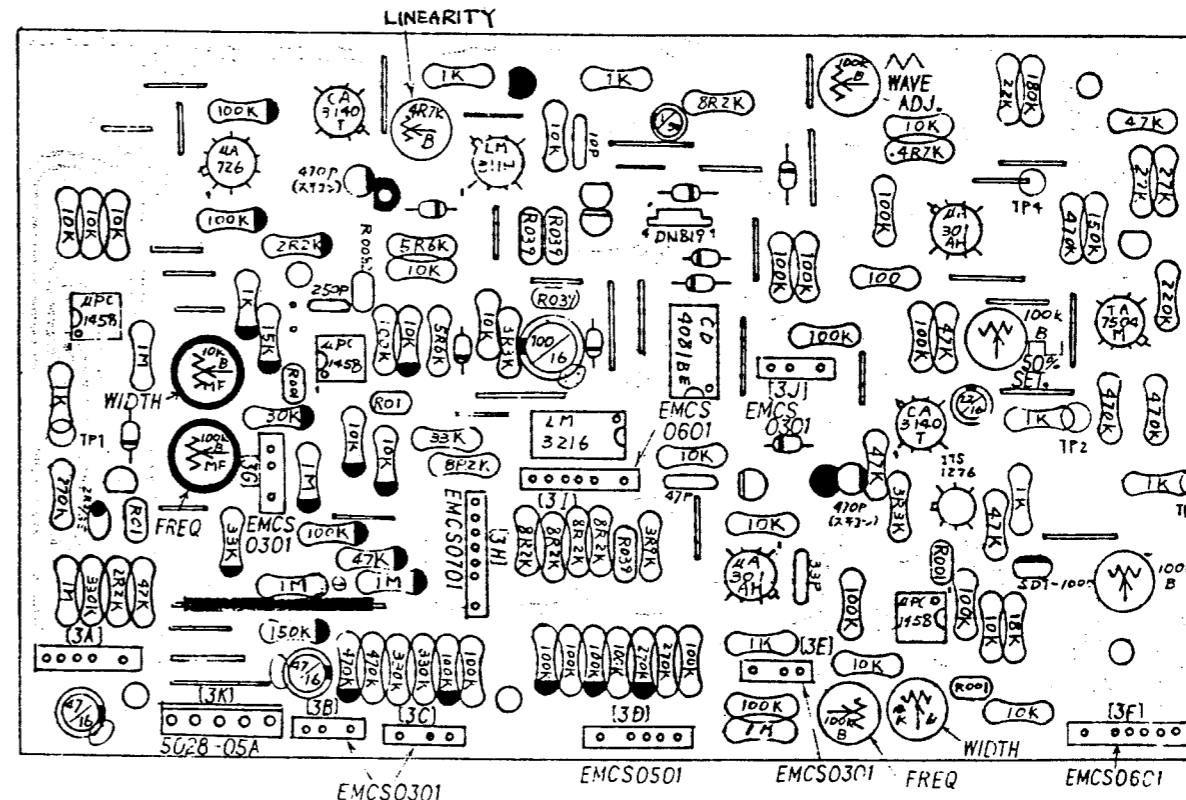

10% SET.

* R394 mounted on the foil side of VCOH-1A.

- Resistor CRB1/4FX
- Resistor 1/4RJ
- Mylar 50V-V-K
- Ceramic 50V-V-K
- Tantalum 35V-V-K
- Electrolytic ECEA
- Styrol 125V-V-K
- Tr 2SC1740-Q
- Tr 2SA826-Q
- FET 2SK30A-GR
- FET NF-510
- Di 1S155
- Thermistor SDT1000
- Trimmer Pot SR19R
- Trimmer Pot PNBO4

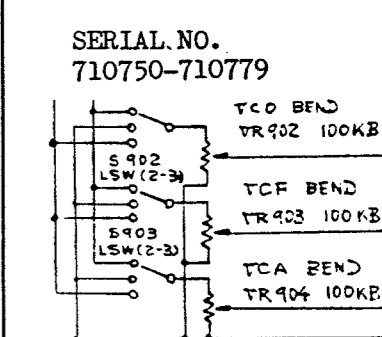
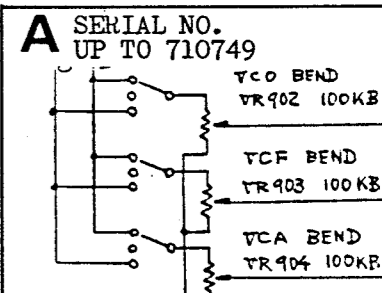
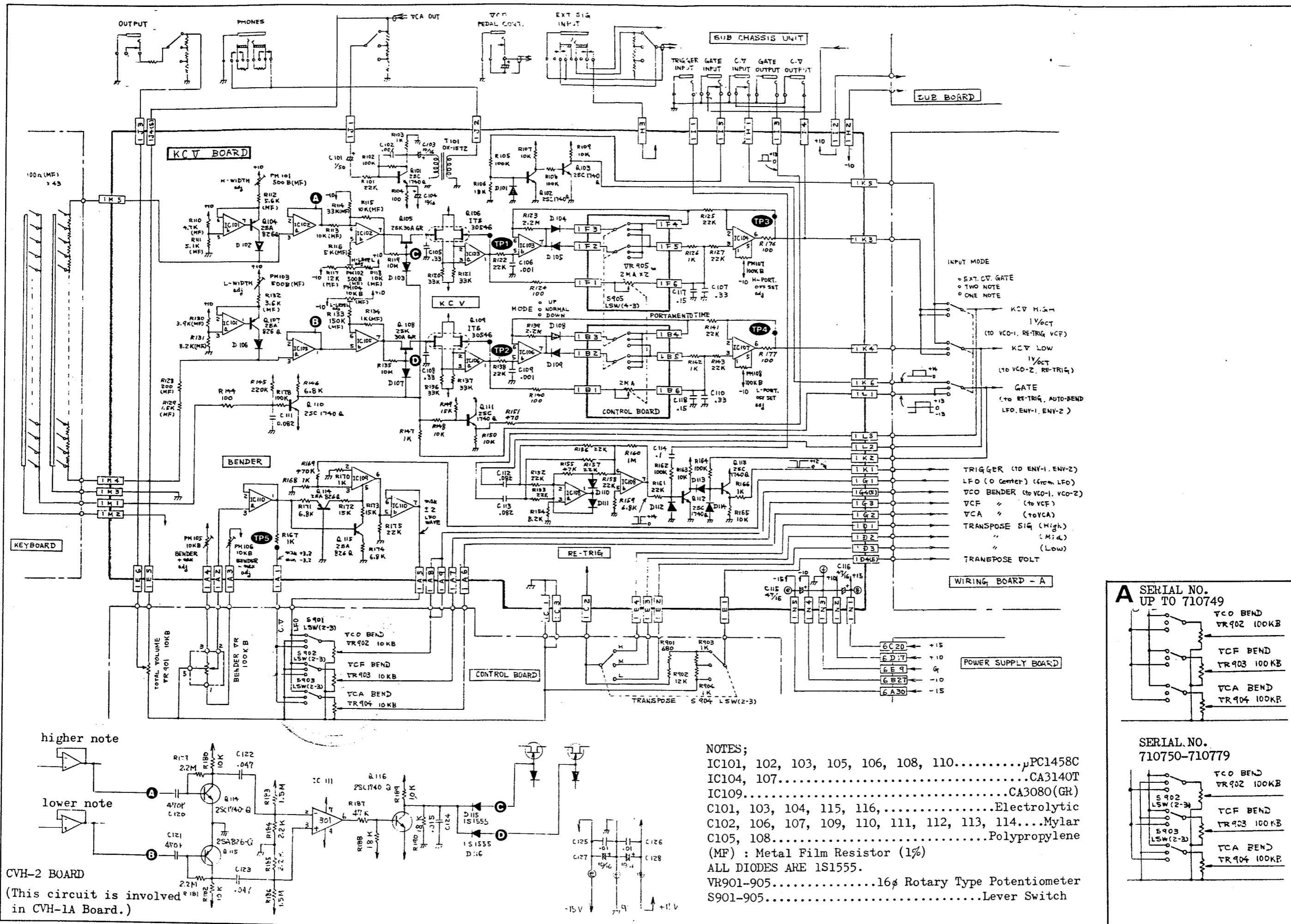

CVH-1 (159H001)
(SERIAL NO. UP TO 700549)

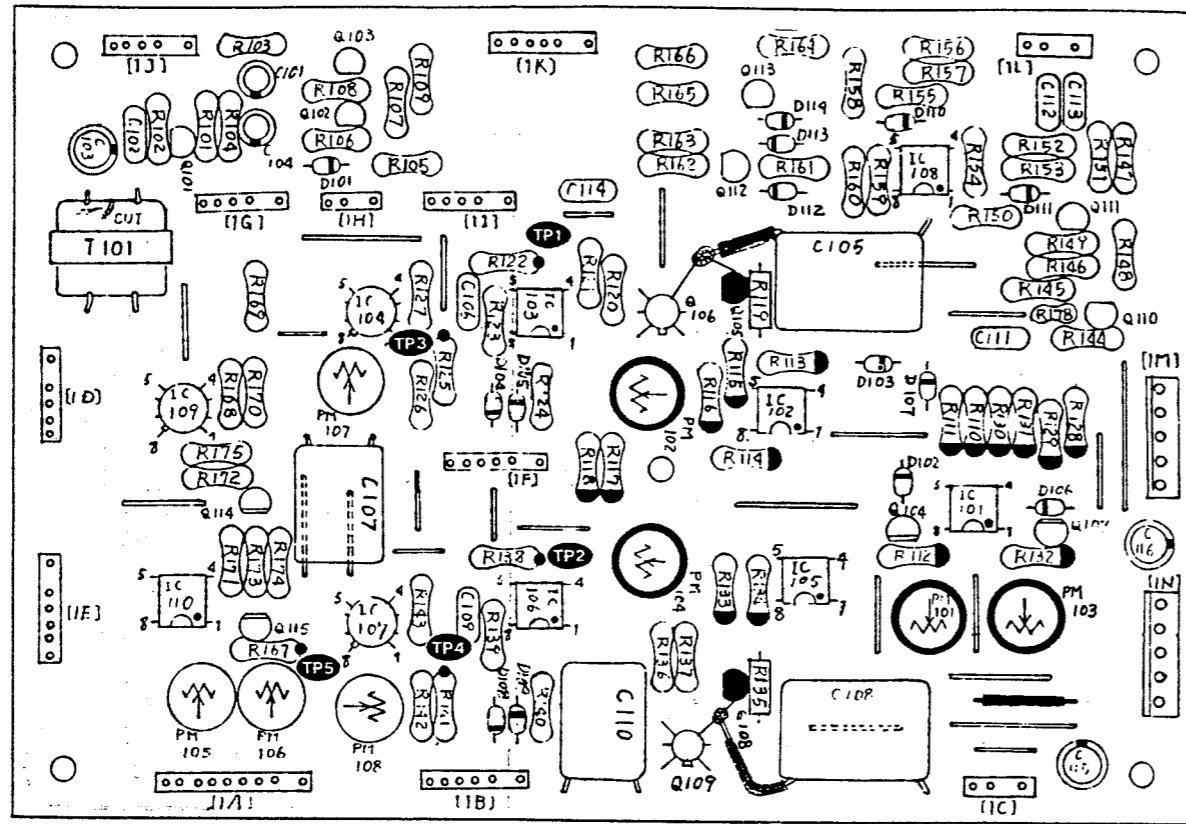

CVH-1A (159H001A)
(SERIAL NO. 700550 AND HIGHER)

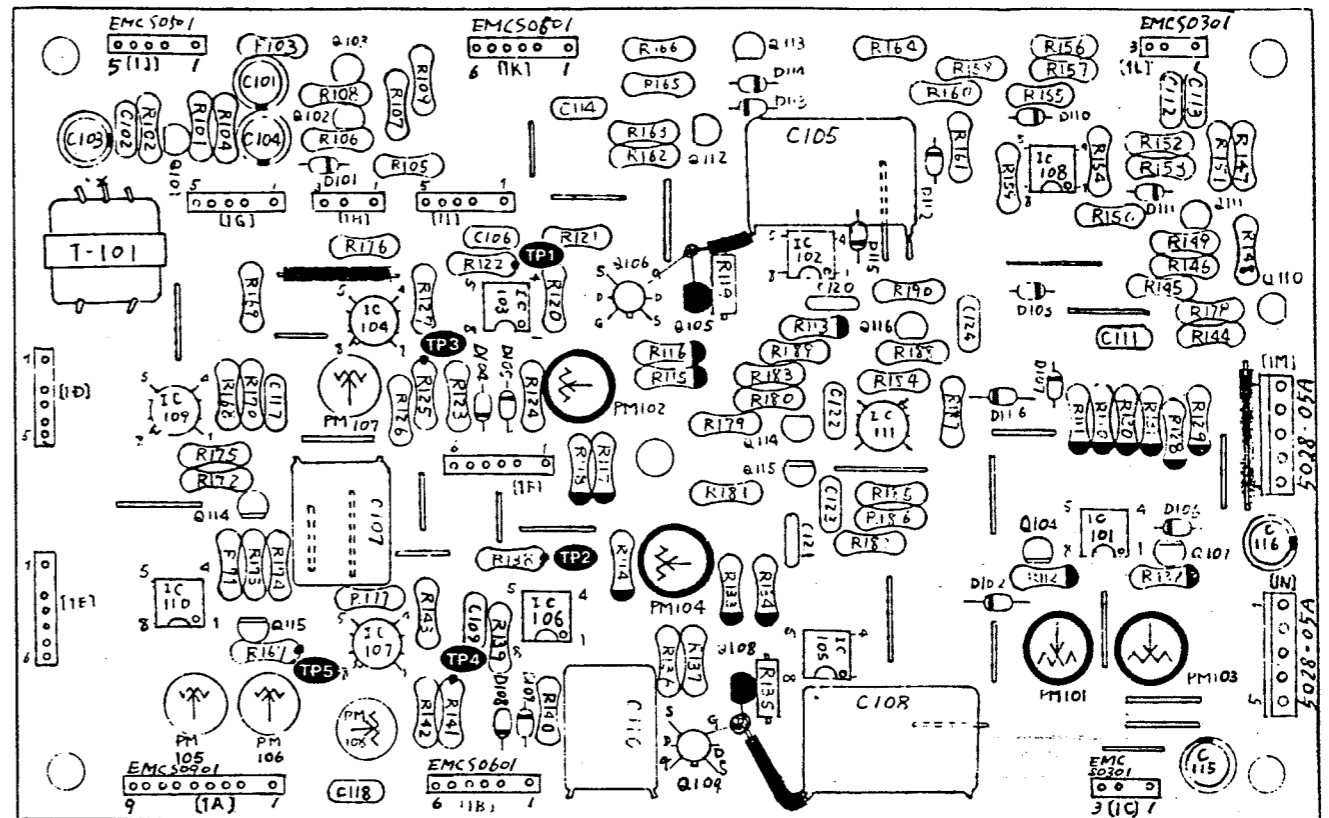

CVH-1 - PARTS ON THE FOIL SIDE

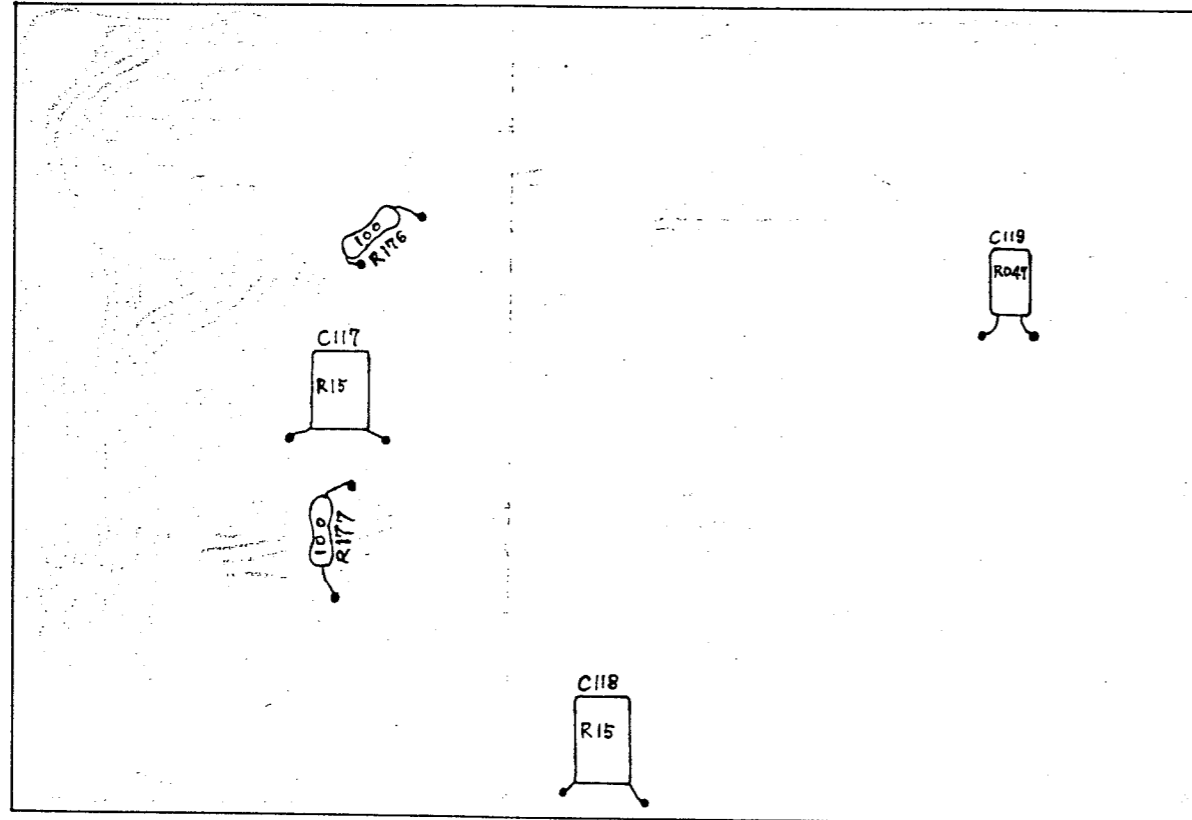

CVH-2 (159H002)

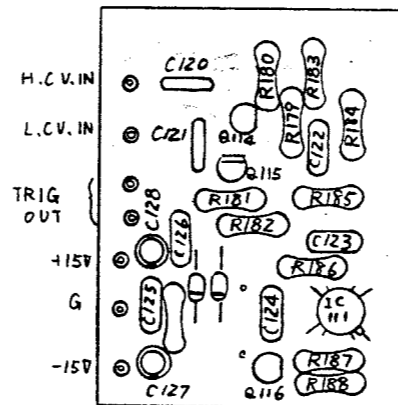

PARTS ON THE FOIL SIDE

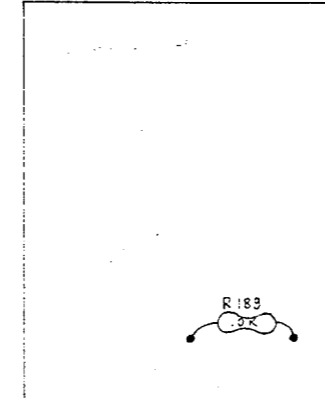

The CVH-2 Board is used with CVH-1 (serial no. up to 700549). CVH-1A (serial no. 700550 and higher) contains the part within itself.

- PM101 (500B): H KCV WIDTH ADJ
- PM102 (500B): H KCV ADJ
- PM103 (500B): L KCV WIDTH ADJ
- PM104 (10KB): L KCV ADJ
- PM105 (10KB): BENDER OFFSET - H
- PM106 (10KB): BENDER OFFSET - L
- PM107 (100KB): PORTAMENTO OFFSET - H
- PM108 (100KB): PORTAMENTO OFFSET - L

- Resistor R50J
- Resistor CRB1/4FX
- Resistor 1/4RJ
- Mylar 50V-V-K
- Ceramic 50V-V-K
- Electrolytic ECEA
- Tr 2SC1740-Q
- Tr 2SA826-Q
- FET 2SK30A-GR
- Di 1S1555
- Trimmer Pot SR19R
- Trimmer Pot PN04

BLOCK DIAGRAM

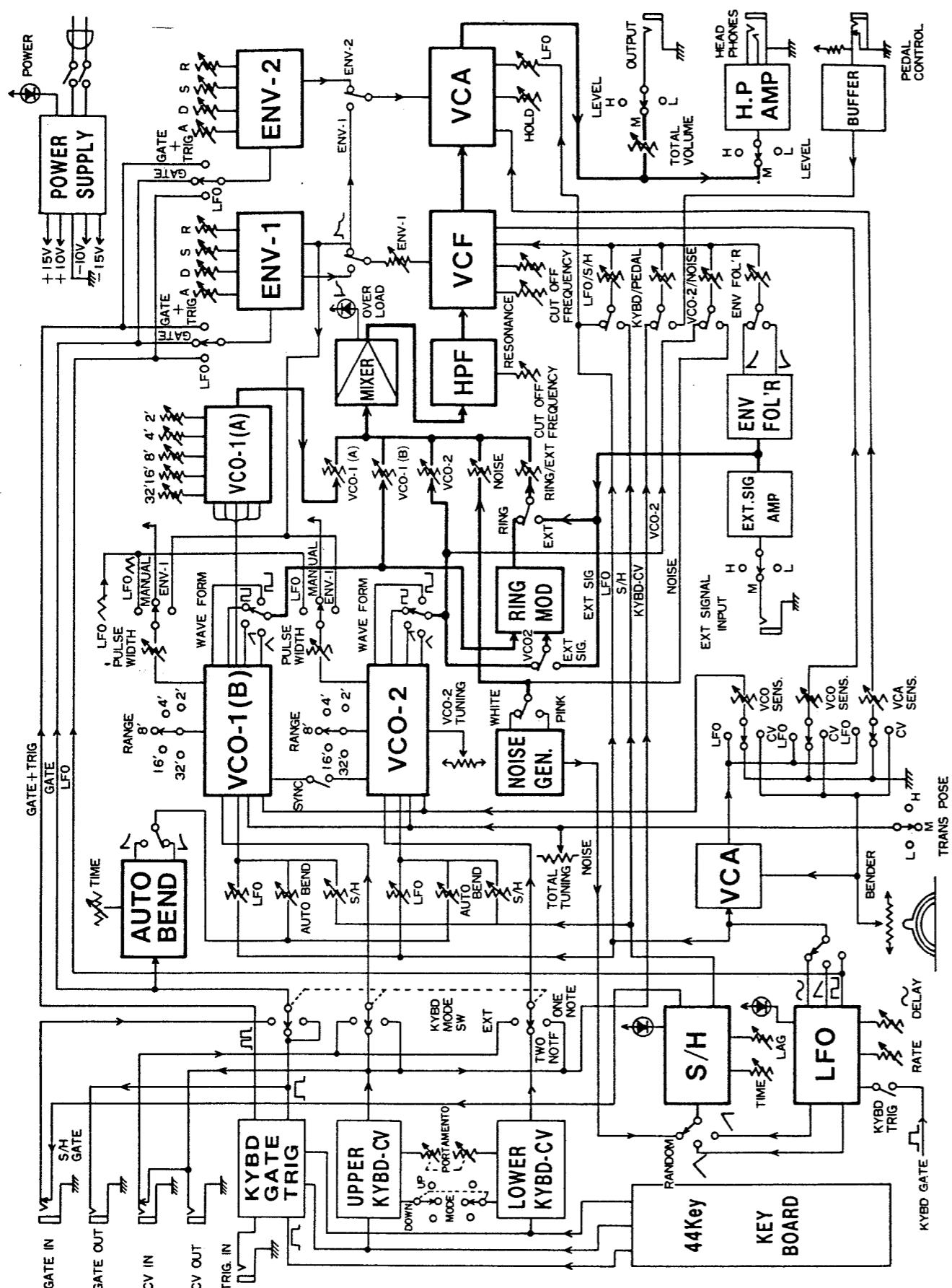

PARTS ON THE FOIL SIDE

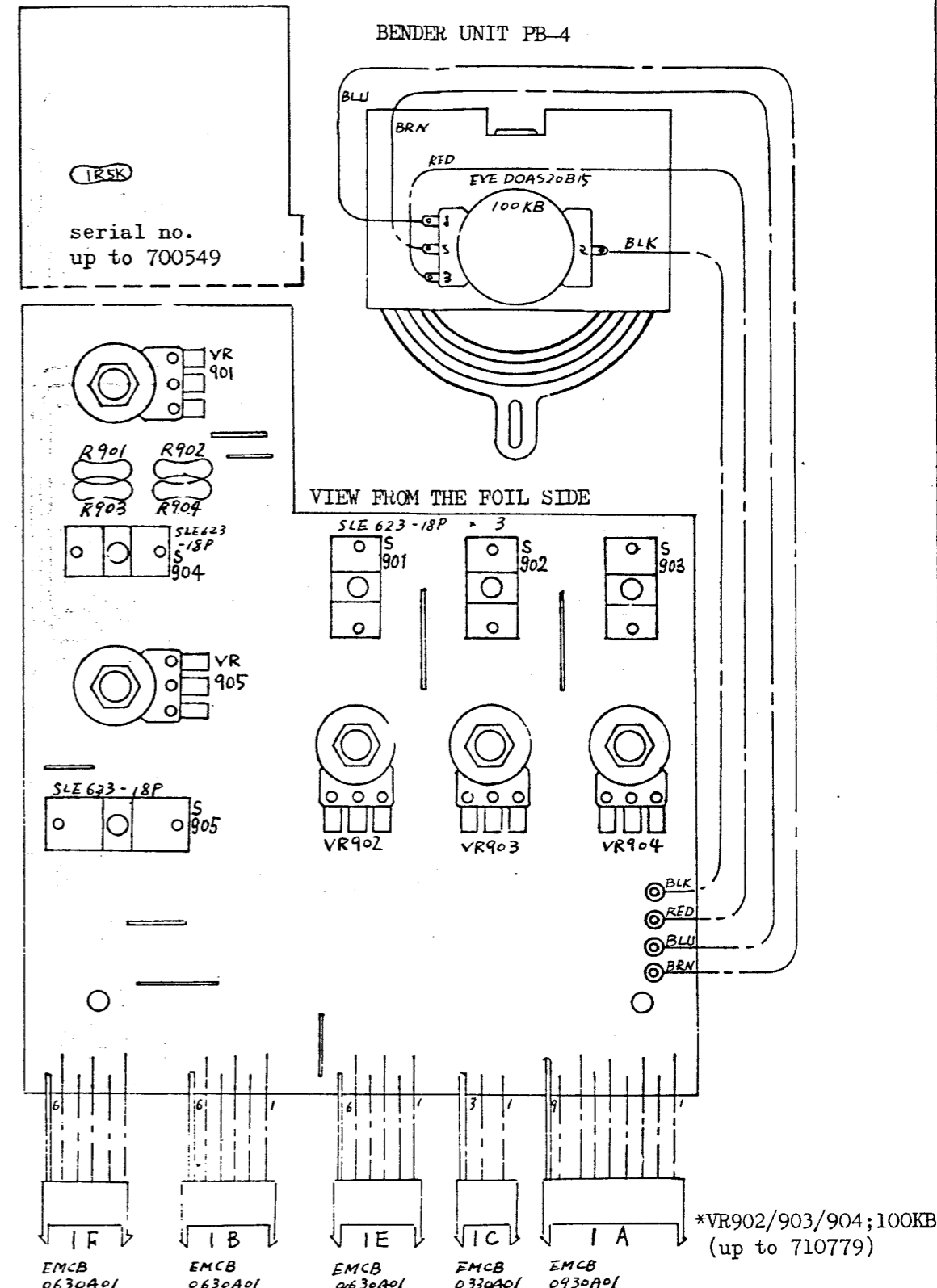

- VR901 (VM10R-K20B14 10KB) TOTAL VOLUME
- VR902 (VM10R-S15B15 10KB*) VCO
- VR903 (VM10R-S15B15 10KB*) VCF
- VR904 (VM10R-S15B15 10KB*) VCA
- VR905 (GM70R-K15A26 2MA x 2) .. PORTAMENTO
- S901: VCO
- S902: VCF
- S903: VCA
- S904: TRANSPOSE
- S905: PORTAMENTO

ADJUSTMENT

1. POWER SUPPLY

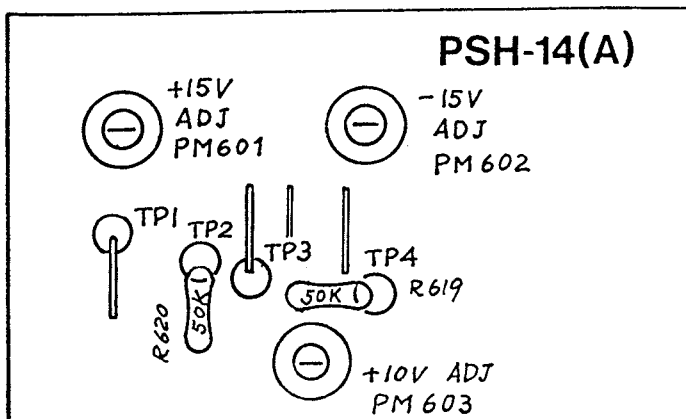

Make adjustment under temperatures where the SH-7 is usually used.
Allow at least 5 minutes as a warm-up period.

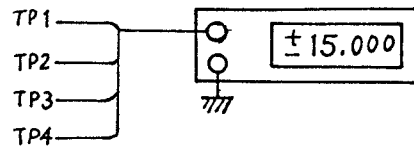

Adjust PM601 to set the TP3 voltage at +15.000V.

Adjust PM602 to set the TP1 voltage at -15.000V.

Adjust PM603 to set the TP4 voltage at +10.000V.

Note: When +10.000V is correctly set, -10.000V is expected to be correct. If -10.000V is not attained, distribute the error as shown below.

$$\left. \begin{matrix} +10.000V \\ -9.994V \end{matrix} \right\} 6mV \text{ error} \left\{ \begin{matrix} 3mV \\ 3mV \end{matrix} \right. \Rightarrow \left. \begin{matrix} +10.003V \\ -9.997V \end{matrix} \right.$$

2. KCV BOARD

First, depress F1. Set Portamento Time at maximum.

Adjust PM107 ((KCV-H, TP3) and PM108 (KCV-L, TP4) so that the key voltage is constant when Portamento Mode is switched to "UP" and "DOWN".

CAUTION

*Do not depress any other key.

*During this adjustment, check to see that no abnormal oscillation is caused (using an oscilloscope, etc.).

Set Portamento Time at minimum and proceed to the following.

CV(H)

Connect a digital voltmeter to TP3.

Adjust PM102 to set the voltage at 4.417V with F4 down. Adjust PM101 to set the voltage at 1.417V with F1 down. Repeat the above steps to obtain correct readings.

CV(L)

Connect a digital voltmeter to TP4.

Adjust PM103 to set the voltage at 4.417V with F4 down. Adjust PM104 to set the voltage at 1.417V with F1 down. Repeat the above steps to obtain correct readings.

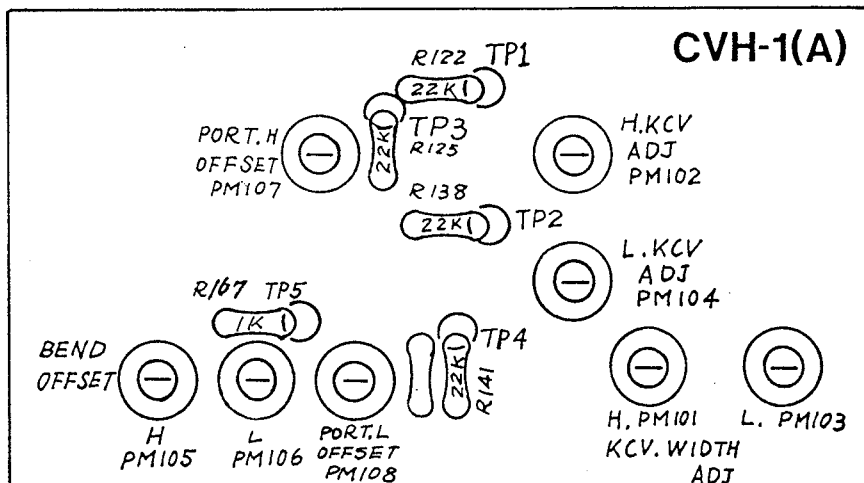

Bender Offset

Connect a digital voltmeter to TP5.

Keep Bender Lever at full + position and adjust PM105 to set the voltage at +3.200V. Then keep Bender Lever at full - position and adjust PM106 to set the voltage at -3.200V. If $\pm 3.200V$ is not achieved, adjust so that + and - voltages are equal.

3. LFO BOARD

3. a. LFO Waveform

Connect an oscilloscope to TP2.

Adjust PM202 to obtain exact continuation of the sawtooth waveform.

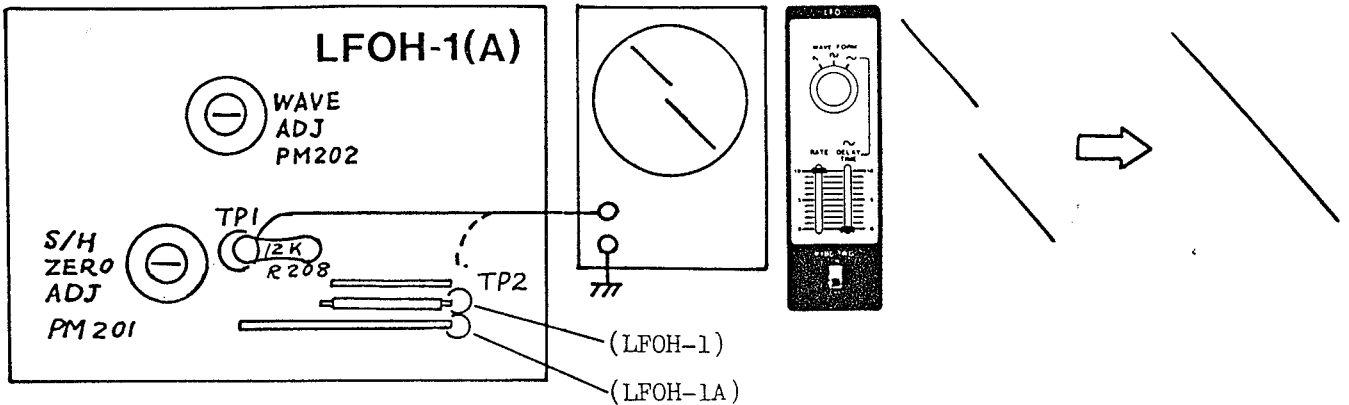

3. b. S & H

Connect an oscilloscope to TP1.

Adjust PM201 so that the waveform deflects equally in + and - directions from the zero level.

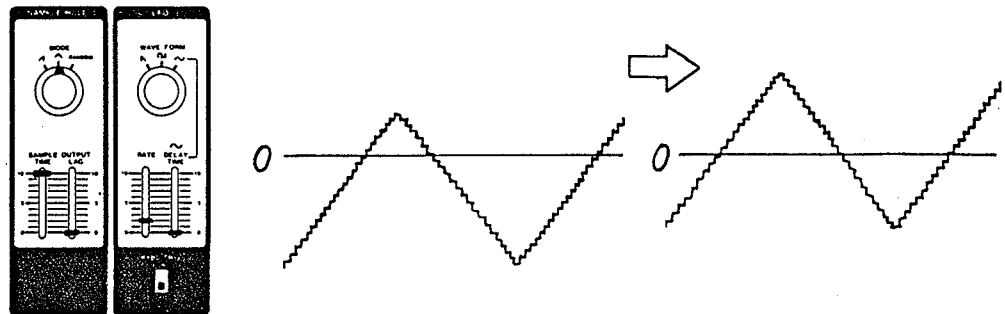

4. VCO-1, VCO-2

Set FREQ and WIDTH controls of VCO-1 and VCO-2 on the rear panel at the middle positions.

Set TOTAL TUNING control and VCO-2 TUNING control at the middle positions.

Set RANGE control at "8", both MOD sliders at "0", and SYNC switch at "OFF".

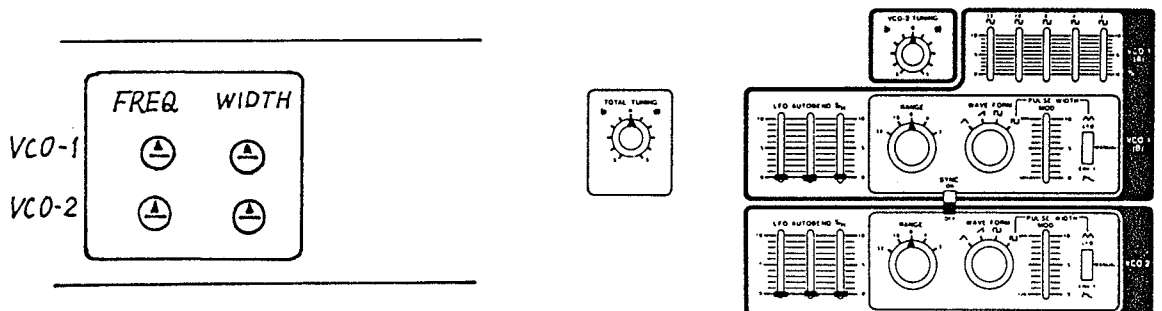

4. a. VCO-1 WIDTH and FREQ

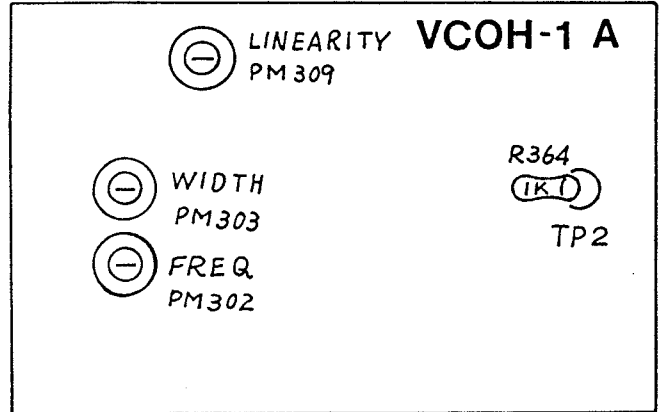
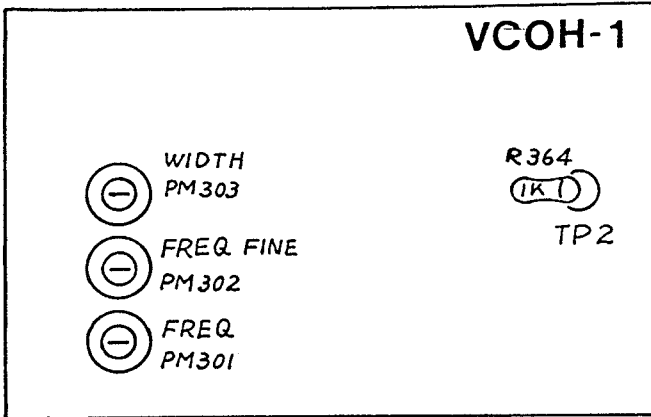

For the adjustment that follows, use a completely tuned electronic instrument or a tuning meter. Adjustment can be made either by checking for the beat sound or by consulting the Lissajous figure on the oscilloscope.

VCO-1	VCO-1A
Adjust PM303 to set F1 at 174.61Hz. *1	Adjust PM303 to set F1 at 174.61Hz. *1
Adjust PM301 to set F2 at 349.22Hz.	Adjust PM302 to set F2 at 349.22Hz.
Repeat above steps until the two are adjusted roughly. *2	
Adjust PM301 to set F3 at 698.44Hz.	Adjust PM302 to set F3 at 698.44Hz.
Adjust PM303 to set F1 at 174.61Hz.	Adjust PM303 to set F1 at 174.61Hz.
Repeat above steps until the two are adjusted roughly.	
Adjust PM301 to set F4 at 1396.88Hz.	Adjust PM302 to set F4 at 1396.88Hz.
Adjust PM303 to set F1 at 174.61Hz.	Adjust PM303 to set F1 at 174.61Hz.
Adjust PM302 to set F4 at 1396.88Hz.	Repeat the above steps.
Repeat the two preceding steps.	Adjust PM309 to set C4 at 2093.0Hz.
*1) If 174.61Hz is not attained by adjusting PM303 only, adjust PM301 also.	*1) If 174.61Hz is not attained by adjusting PM303 only, adjust PM302 also.
*2) The need for repetition arises from close interrelation between PMs' setting.	

4. b. VCO-1 Waveform

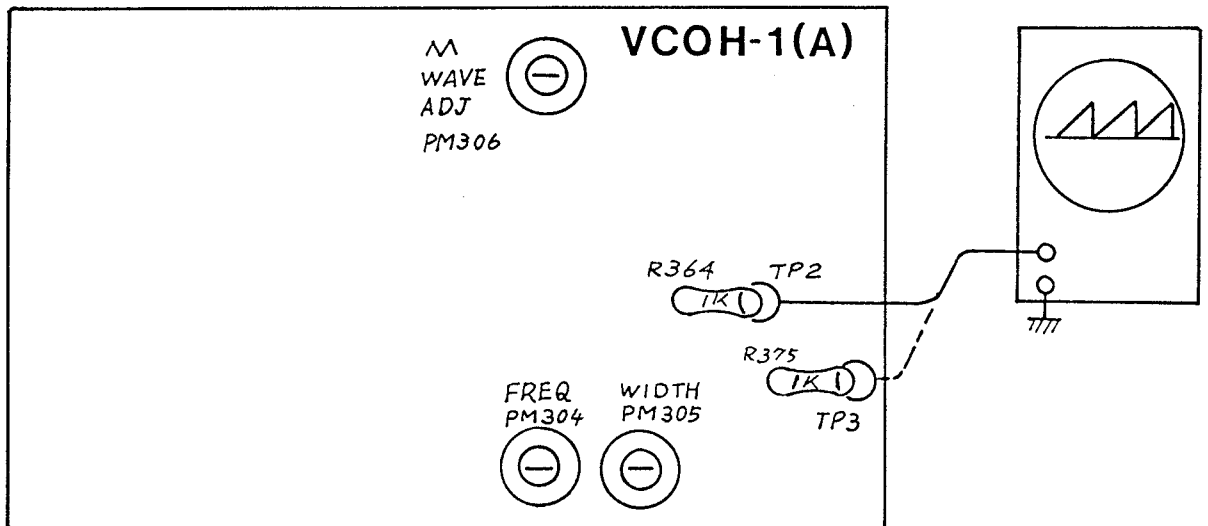

Sawtooth Waveform

Connect an oscilloscope to TP2.

Depress F1 and adjust PM305 to obtain the sawtooth wave of 10Vp-p.

Then depress C4 and adjust PM304 to obtain the sawtooth wave of 10Vp-p.

Repeat the above steps until the specified voltages are obtained.

THE POINT FOR ADJUSTMENT

If F1 voltage is higher than 10Vp-p, set it a little below 10Vp-p with PM305 and if it is lower than 10Vp-p, set it a little above 10Vp-p before adjusting PM304.

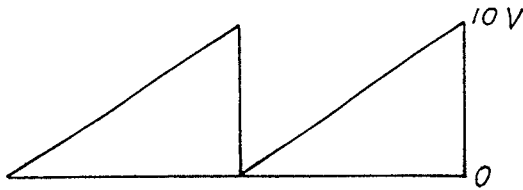

Good

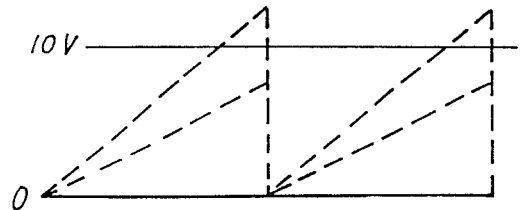

No Good

Triangular Waveform

Connect an oscilloscope to TP3.

Depress F1 and adjust PM306 to obtain correctly matched waveform.

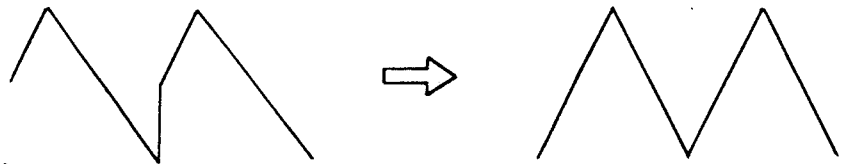

4. c. VCO-1 PWM Pulse Width

With PWM slider at 50% position ("0" position), depress F1 and adjust PM307 to obtain 50% wave. Then with PWM slider at MIN ("10") position, adjust PM308 to obtain 10% wave.

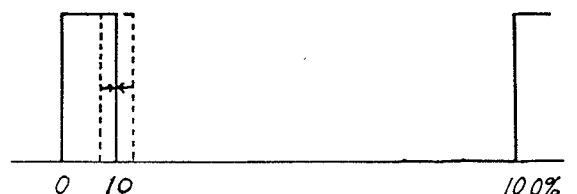
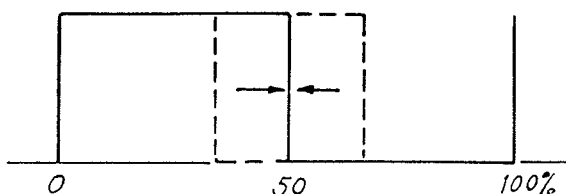
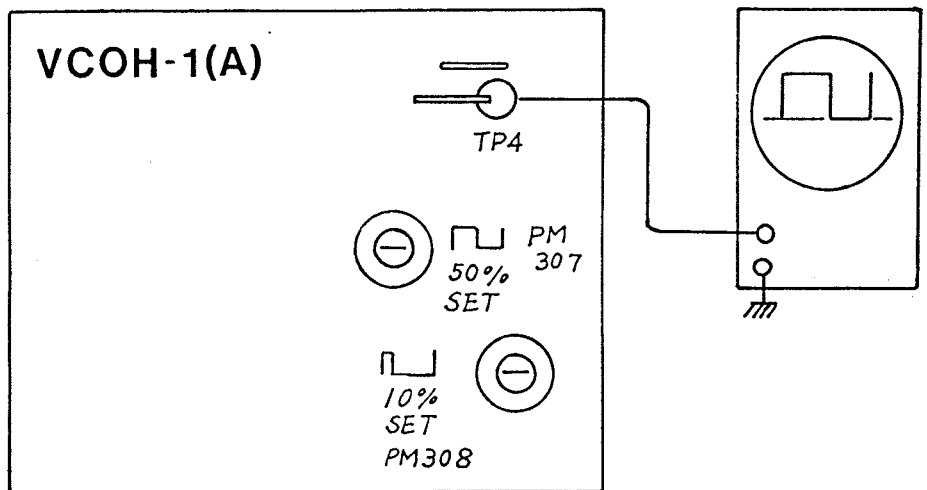
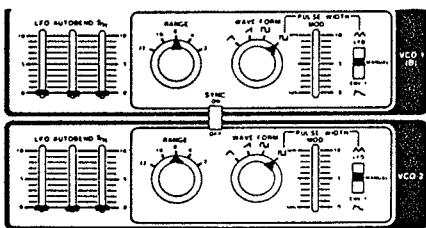

4. d. VCO-2 PWM Pulse Width

Follow the adjustment for VCO-1.

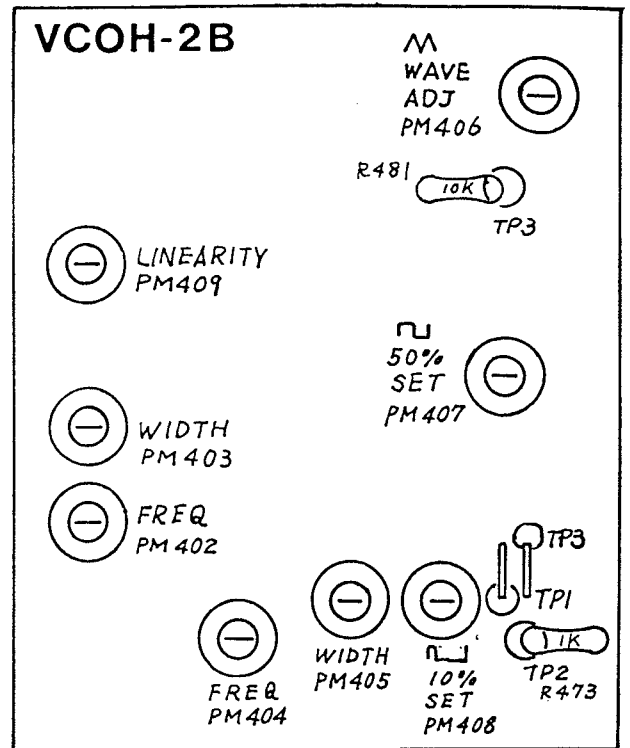
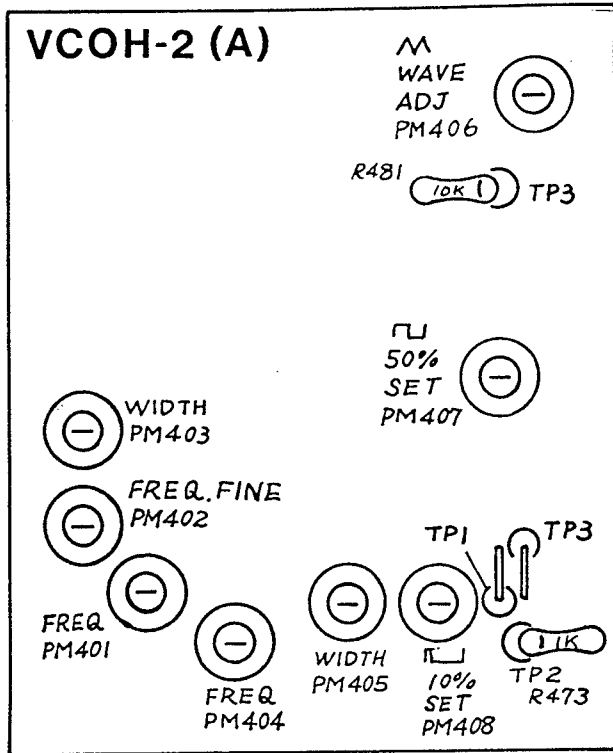

5. VCF and VCA BOARD

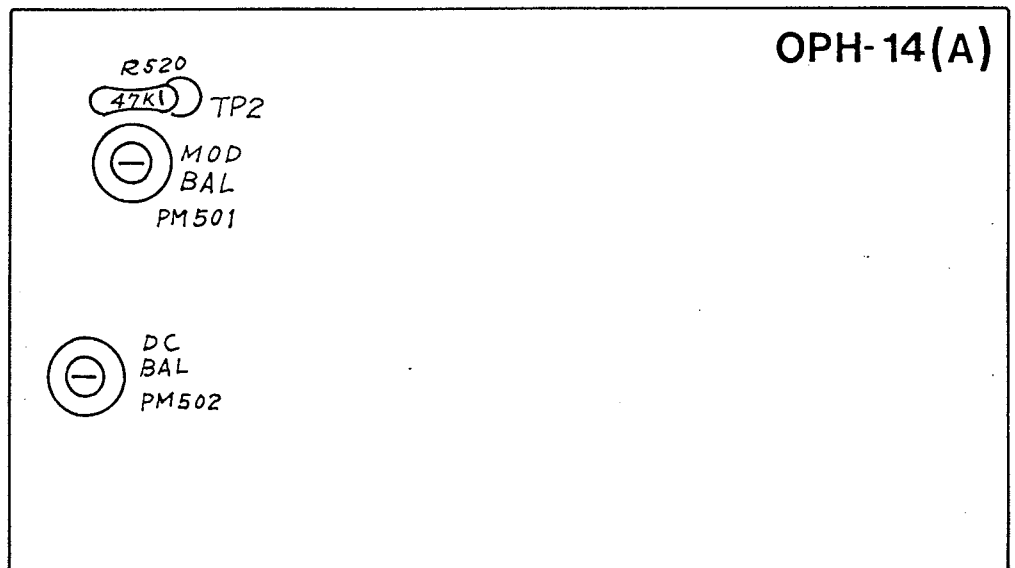
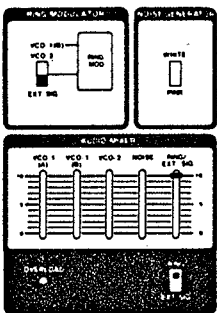

5. a. Ring Modulator

Signal Balance

Connect an oscilloscope to TP2. Set the oscilloscope gain at the maximum in the AC range. Adjust PM502 so that signal is minimized.

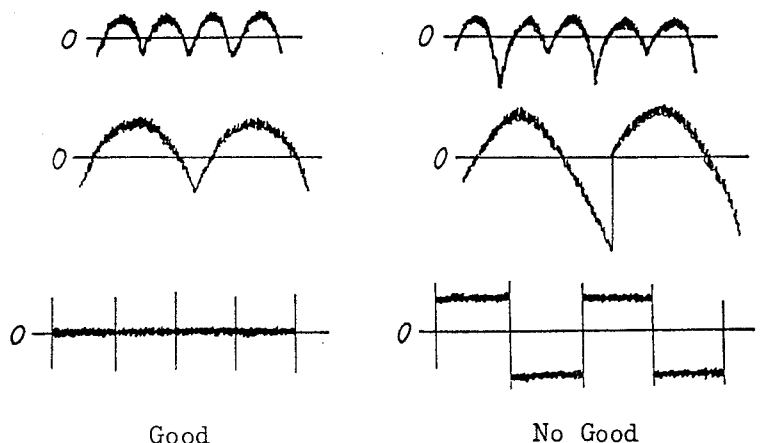

5. b. Modulation Balance

Connect an oscilloscope to TP2.
Adjust PM501 to level the peak values of Ring Modulator output waveform.

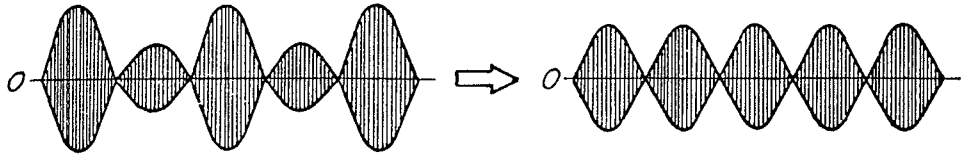
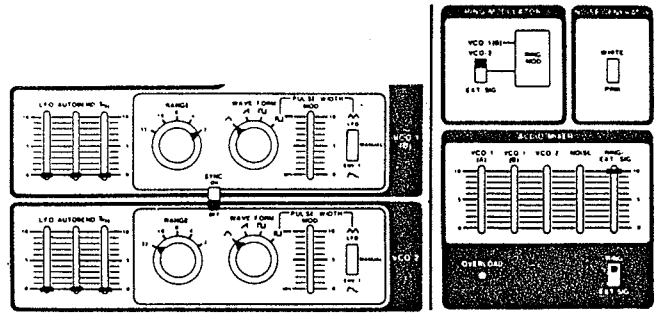

5. c. VCF

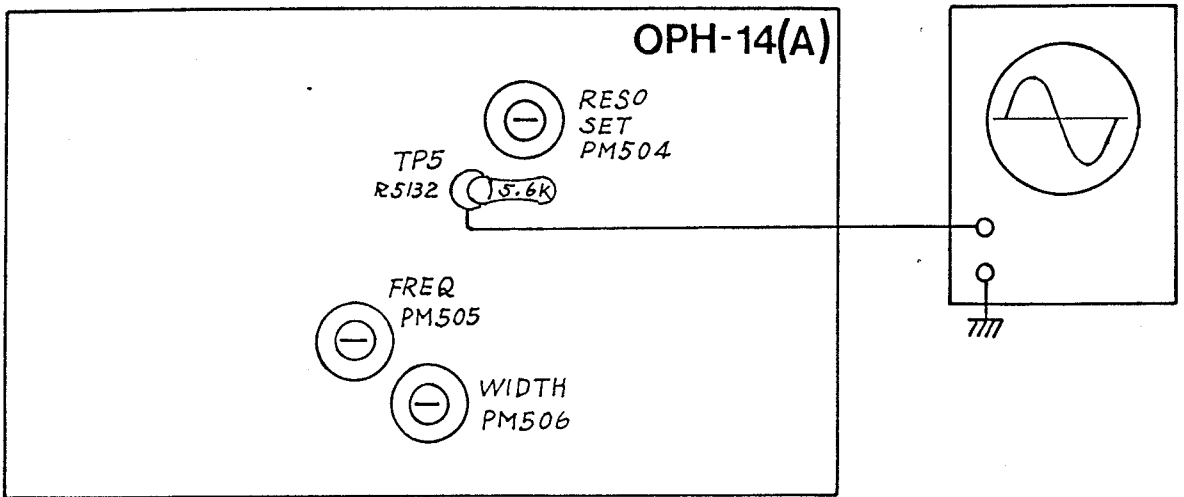

Self-oscillation Point

Connect an oscilloscope to TP5.
Adjust PM504 so that VCF is at the onset of self-oscillating.
(See the setting on the right.)

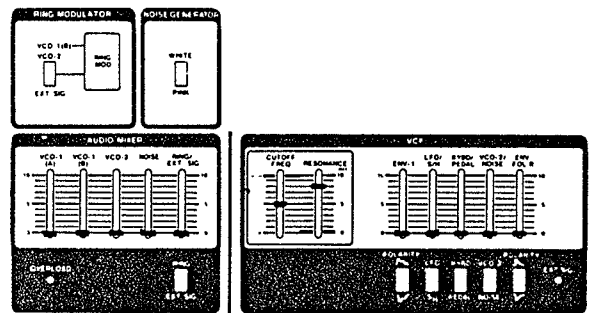

Frequency

Depress F1 and adjust PM505 to set the oscillating frequency at 20KHz(50usec).
(See the setting on the right.)

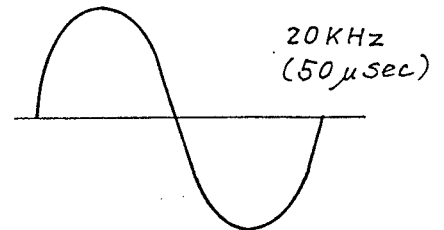
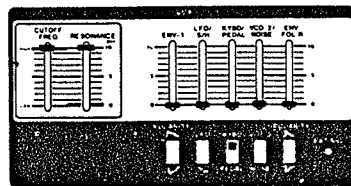

Width

Adjust PM506 to obtain correct octave relationship between F2 and F3.

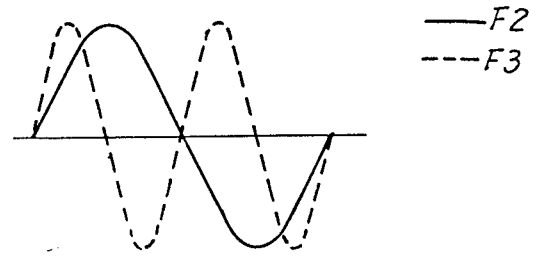
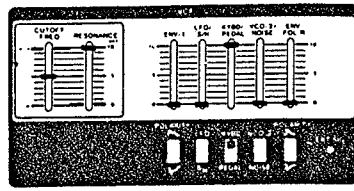

Make sure F1 remains 20KHz.

5. d. Noise Level

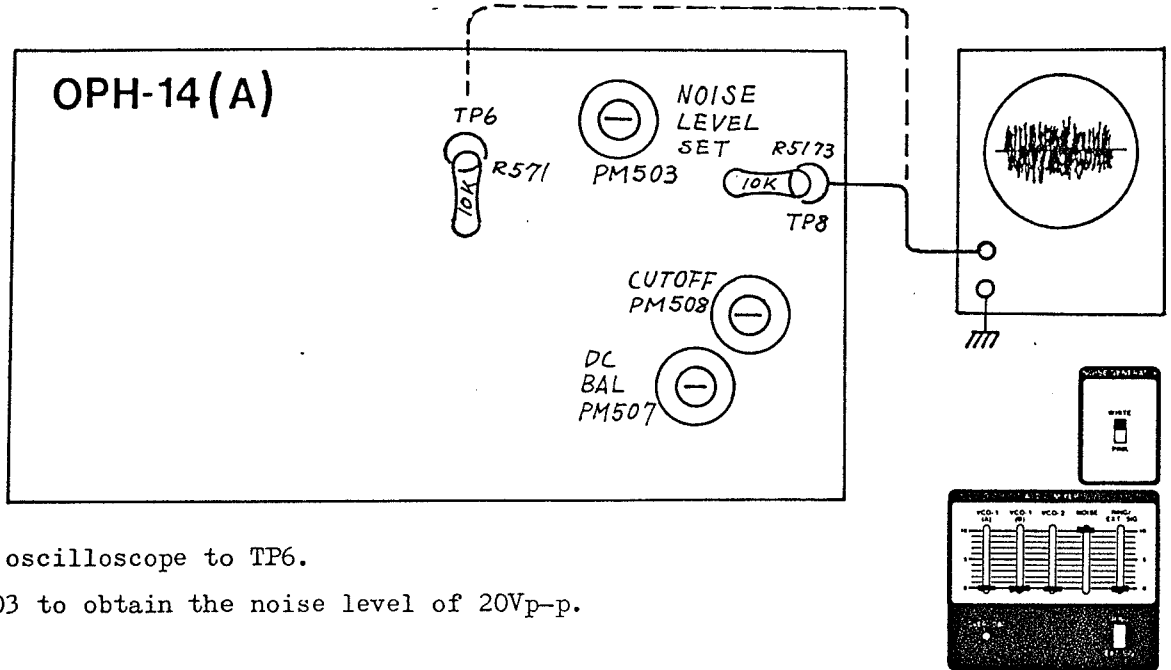

Connect an oscilloscope to TP6.
Adjust PM503 to obtain the noise level of 20Vp-p.

5. e. VCA

VCA DC Balance

Connect an oscilloscope to TP8.

With A, D, S, R sliders at 0 and no input signals, adjust PM507 so that output signal is minimized.

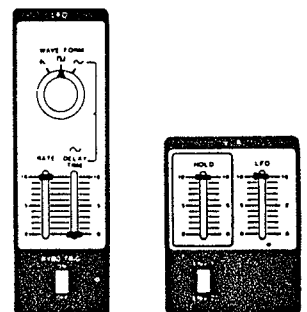
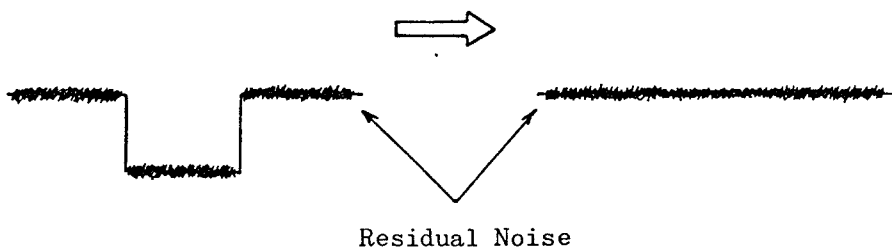

VCA Cutoff

Feed VCO-1 signal set at maximum and adjust PM508 so that output is about to come out.

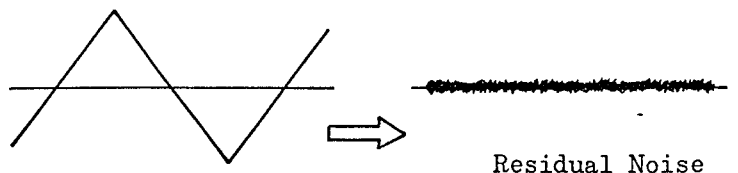
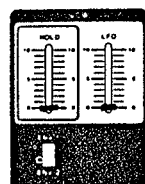

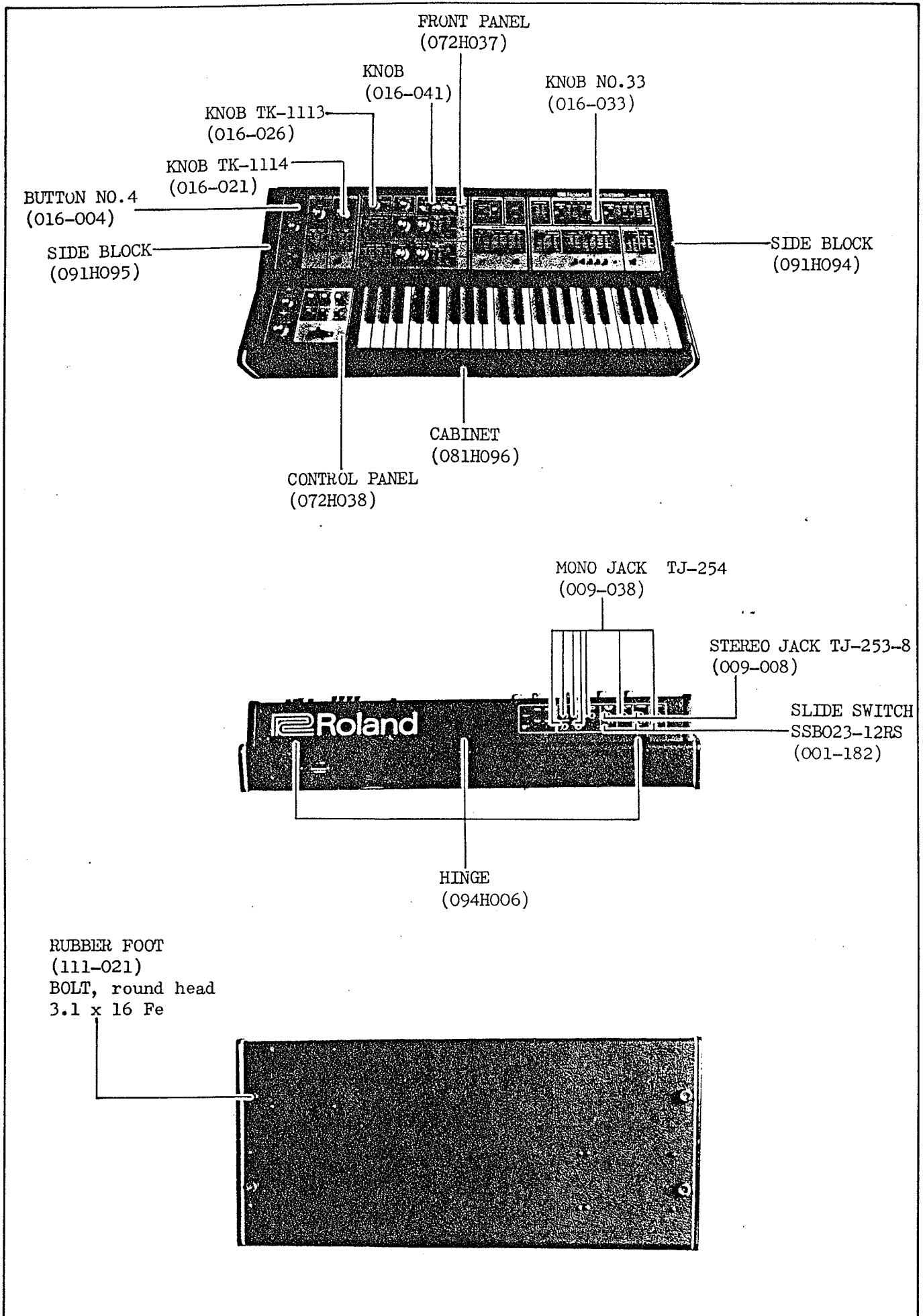

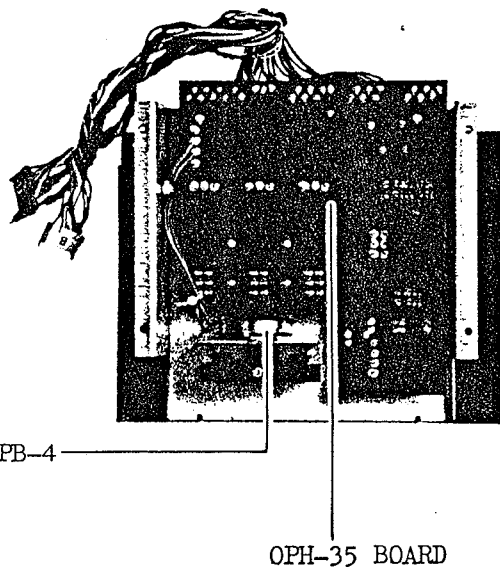
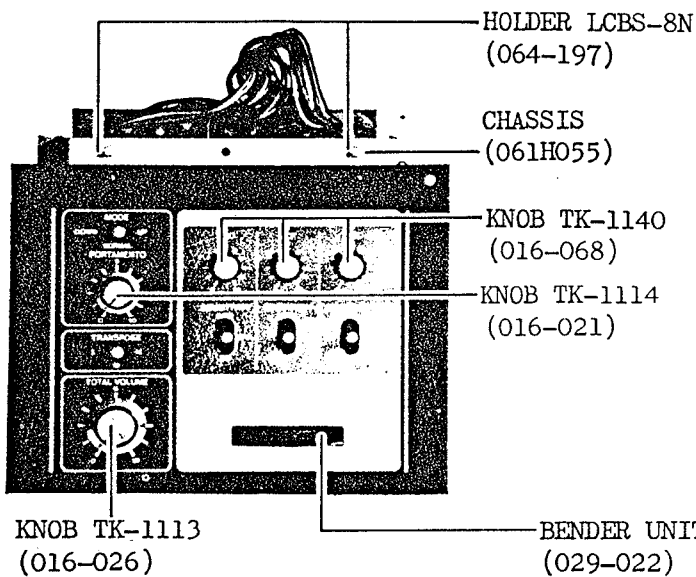
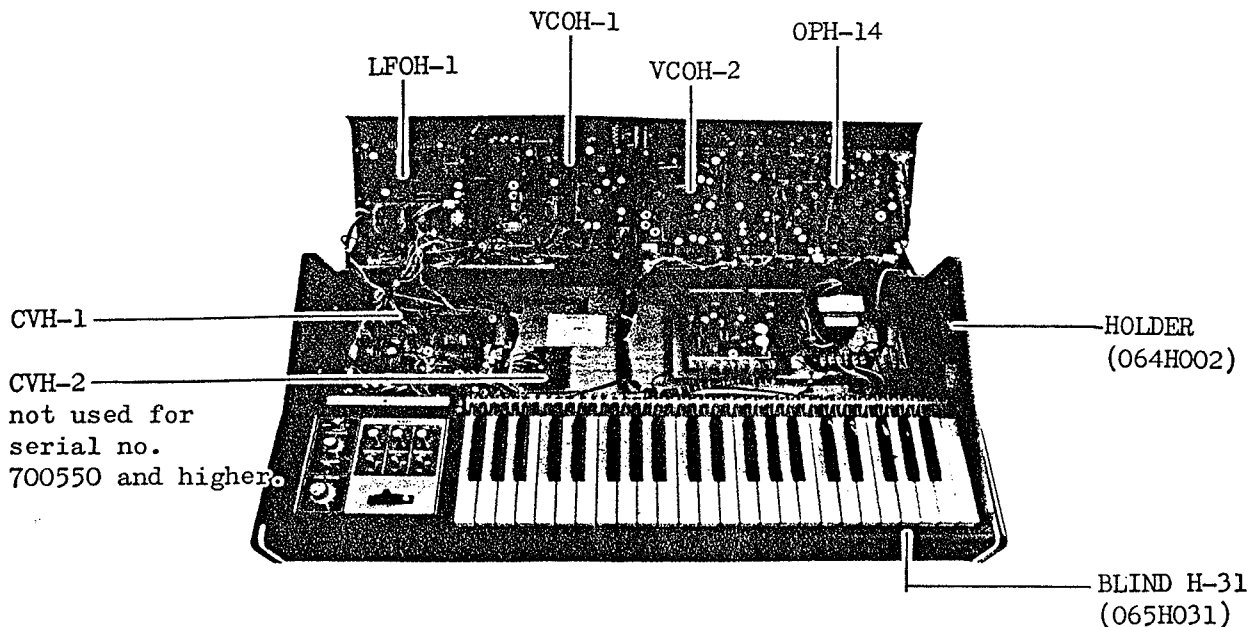

POWER SWITCH
 100V: SDG5P001-1 (001-215)
 117V: SDG5P001-2 (001-216)
 220/240V: SDG5P502 (001-217)

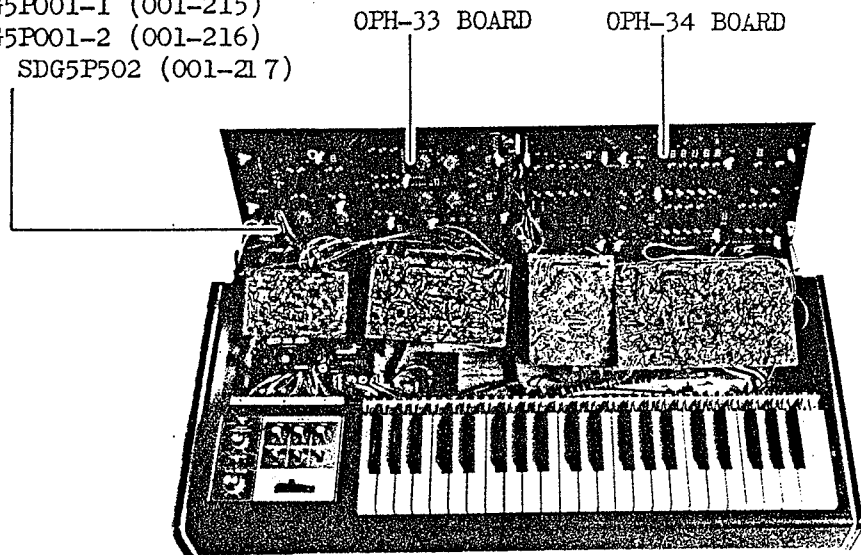

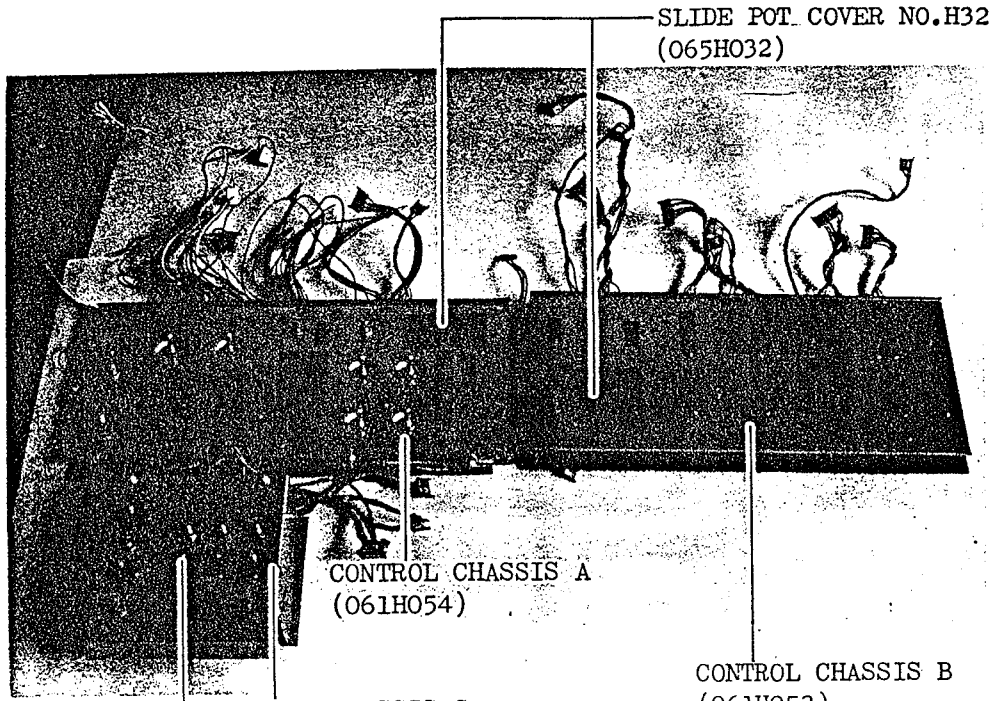

SWITCH COVER NO.H33
(065H033)

POWER TRANSFORMER
022-110C (100/120V)
022-110D (220/240V)

HEAT SINK
(048-052)

LINE CORD STRAIN RELIEF
BU-4796-B
(047-036)

PSH-13 BOARD (100/120V)
PSH-14 BOARD (220/240V)

PCB HOLDER
LCBS-4N
(064-033)

LINE CORD STRAIN RELI
1702B (047-022)
1704B (047-037)

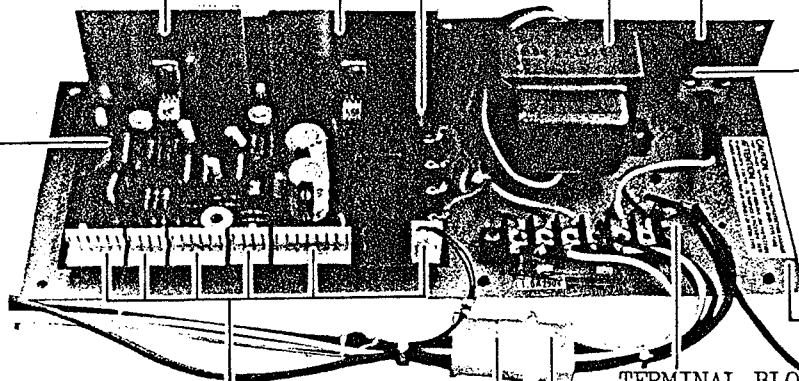

WAFER TERMINAL
3P: 5028-03A (010-106)
4P: 5028-04A (010-107)
6P: 5028-06A (010-109)
8P: 5028-08A (010-111)

TERMINAL BLOCK
TT-501D1 6P
(042-044)

CONNECTOR 3191-04P
(010-167)

CONNECTOR 3191-04R
(010-168)
TERMINAL PIN 1381TL
(042-043)

TERMINAL PIN 1381ATL
(042-042)

PART NO.	PART AND DESCRIPTION
081H096	Cabinet
091H094	Side Block, right
091H095	Side-Block, left
111H021	Rubber Foot G-5
064H002	Holder, side block
072H037	Front Panel
072H038	Control Panel
064H046	Holder, front panel
094H006	Hinge
016-004	Button No.4, power switch
016-021	Knob TK-1114, small for rotary pot
016-026	Knob TK-1113, large for rotary pot
016-068	Knob TK-1140, mini for rotary pot
016-033	Knob No.33, for slide pot
016-041	Knob No.41, for slide pot(white)
061H053	Chassis B, control
061H054	Chassis A, control
061H055	Chassis C, control
061H056	Sub-chassis
061H057	Power Supply Chassis
068H020	Cover, LED
065H032	Cover, slide pot
065H033	Cover, switch
064H045	Holder, power switch
064-033	Holder LCBS-4N, PCB
064-147	Holder LCBS-6N, PCB (serial no. up to 700599)
064-200	Holder DLCBS-6N, PCB (serial no. 700600 and higher)
064-197	Holder LCBS-8N, PCB
064-194	Collar Bush, inner NB-300
064-194	Collar Bush, outer NA-310
012-018	Fuse Holder XN1153 (220/240V)
012-003	Fuse Holder TF753 (220/240V)
008-041	Fuse MGP 1A (100/117V)
008-066	Fuse SEMKO 1A (220/240V)
008-024	Fuse SGA 0.5A, midget(220/240V)
068-020	Bush No.20
068-005	Insulating Bush, jack
001-201	Lever Switch SLE-623-18P
001-202	Lever Switch SLE-643-18P
001-207	Rotary Switch SRN-1025N-K25
001-208	Rotary Switch SRN-1024N-K25
001-209	Rotary Switch SRN-1023N-K25
001-182	Slide Switch SSB022-12FN
001-183	Slide Switch SSB023-12FN
001-215	Power Switch SDG5P001-1 (100V)
001-216	Power Switch SDG5P001-2 (117V)
001-217	Power Switch SDG5P502 (220/240V)
009-038	Jack TJ-254 (mono)
009-008	Jack TJ-253-8 (stereo)
029-022	Bender Unit PB-4

PART NO.	PART AND DESCRIPTION
Use the following PCB's, for replacement for the predecessors.	
159H001A	CVH-1A (700550 and higher)
052H101A	CVH-1A PCB less parts
152H001A	VCOH-1A (700600 and higher)
052H098B	VCOH-1A PCB less parts
152H002B	VCOH-2B (700650 and higher)
052H099D	VCOH-2B PCB less parts
158H001A	LFOH-1A (700460 and higher)
052H097B	LFOH-1A PCB less parts
149H014A	OPH-14A (700650 and higher)
052H100B	OPH-14A PCB less parts
149H033	OPH-33
052H094A	OPH-33 PCB less parts
149H034	OPH-34
052H095A	OPH-34 PCB less parts
149H035	OPH-35
052H096A	OPH-35 PCB less parts (700650 and higher)
052H103	Sub-Chassis PCB less parts
146-013A	PSH-13A
146-014A	PSH-14A
052H102A	PSH-13/14A PCB less parts (700650 and higher)
010-051	Connector 3024-02C, LED
010-166	Connector 3024-03C, Tr
010-112	Connector Housing EMCB 0312A01
010-114	Connector Housing EMCB 0320A01
010-115	Connector Housing EMCB 0330A01
010-154	Connector Housing EMCB 03-RO01
010-159	Connector Housing EMCB 03-RO02
010-161	Connector Housing EMCB 0510A01
010-117	Connector Housing EMCB 0512A01
010-118	Connector Housing EMCB 0516A01
010-119	Connector Housing EMCB 0520A01
010-120	Connector Housing EMCB 0530A01
010-155	Connector Housing EMCB 05-RO01
010-123	Connector Housing EMCB 0616A01
010-124	Connector Housing EMCB 0620A01
010-125	Connector Housing EMCB 0630A01
010-128	Connector Housing EMCB 0716A01
010-132	Connector Housing EMCB 0912A01
010-133	Connector Housing EMCB 0916A01
010-135	Connector Housing EMCB 0930A01
010-165	Connector Housing EMCB 1010A01
010-138	Connector Housing EMCB 1016A01
010-139	Connector Housing EMCB 1020A01
010-142	I-type PLUG EMC-S0301
010-143	I-type PLUG EMC-S0501
010-144	I-type PLUG EMC-S0601
010-145	I-type PLUG EMC-S0701
010-146	I-type PLUG EMC-S0901
010-147	I-type PLUG EMC-S1001
010-149	L-type PLUG EMC-S0501L
010-153	L-type PLUG EMC S1001L
010-106	Wafer Terminal 5028-03A
010-107	Wafer Terminal 5028-04A

PART NO.	PART AND DESCRIPTION
010-108	Wafer Terminal 5028-05A
010-109	Wafer Terminal 5028-06A
010-111	Wafer Terminal 5028-08A
017-003	Tr 2SC1000-GR
017-010	Tr 2SD234-0
017-016	Tr 2SK30A-GR
017-036	Tr E-412 (ITS 30546)
017-039	Tr NF510
017-046	Tr 2SA828-R, noise generator
017-071	Tr 2SK30A-Y FET
017-097	Tr 2SA826-Q
017-118	Tr 2SC1740-Q
018-005	Diode 1S1555
018-015	Diode SDT1000 (thermistor)
018-018	Diode 1N4003
018-062	MI152 (rectifier)
018-063	MI152R (rectifier)
018-079	Diode 1S2454
019-009	LED LRO601R IC's
020-007	LM3216
020-010	TA7504M
020-015	CA3080-GR (CVH-1)
020-015	CA3080-BL (OPH-14)
020-021	ITS1276
020-024	uA301HC
020-026	LM1496N
020-027	TA7136P
020-032	uA726HC
020-039	DN819
020-054	LM311H
020-062	uPC1458C
020-104	CD4081BE
020-105	CA3140T
	SLIDE POT
028-036	EVA-QOAC16A15 100KA
028-025	EVA-QOAC16B15 100KB
029-094	EVA-QOAC16D15 100KD
028-038	EVA-QOAC16A55 500KA
028-039	EVA-QOAC16A16 1MA
029-097	EVA-QOAC16D16 1MD
028-040	EVA-QOAC16A26 2MA
029-295	EVB-LOAC16A15 100KA x 2
	ROTARY POT
028-794	VM10R-S15B14 10KB
028-76C	VM10R-K20B14 10KB
028-727	VM10R-K15B15 100KB
028-797	VM10R-S15B15 100KB
028-857	GM70R-K15A26 2MA x 2
	TRIMMER POT
029-103	PNBO4C3A 501H 500B (metal film)
029-104	PNBO4C3A 102H 1KB (metal film)
029-106	PNBO4C3A 103H 10KB (metal film)
029-109	PNBO4C3A 104H 100KB (metal film)
029-463	SR19R-4.7KB (carbon film)
029-465	SR19R-10KB (carbon film)
029-461	SR19R-47KB (carbon film)
029-471	SR19R-100KB (carbon film)

PART NO.	PART AND DESCRIPTION
	RESISTOR
	All CRB1/4FX resistors are ±1% tolerance.
044-823	200 CRB1/4FX
044-907	330 CRB1/4FX
044-830	1K CRB1/4FX
044-831	1.5K CRB1/4FX
044-832	2.2K CRB1/4FX
044-833	3.3K CRB1/4FX
044-910	3.6K CRB1/4FX
044-834	3.9K CRB1/4FX
044-911	4.7K CRB1/4FX
044-864	5K CRB1/4FX
044-912	5.6K CRB1/4FX
044-835	6K CRB1/4FX
044-837	8.2K CRB1/4FX
044-838	10K CRB1/4FX
044-914	11K CRB1/4FX
044-915	12K CRB1/4FX
044-839	15K CRB1/4FX
044-887	20K CRB1/4FX
044-916	27K CRB1/4FX
044-895	30K CRB1/4FX
044-841	33K CRB1/4FX
044-842	47K CRB1/4FX
044-917	50K CRB1/4FX
044-843	56K CRB1/4FX
044-846	100K CRB1/4FX
044-848	150K CRB1/4FX
044-852	270K CRB1/4FX
044-845	330K CRB1/4FX
044-856	470K CRB1/4FX
044-860	1M CRB1/4FX
	CAPACITOR
035-156	150p 50V-V-J (styrole)
035-168	470p 50V-V-J (styrole)
032-191	10u 16V ECEA16N10 (non-polar)
035-091	0.33u ECQF2334M (polypropylene)
032-099	1u 35V-V-K (tantalum)
032-226	2.2u 35V-V-K (tantalum)
032-227	3.3u 35V-V-K (tantalum)

Carbon resistors, and electrolytic, mylar and ceramic capacitors are omitted.

PARTS ORDERING INFORMATION

Name of part number of some of the parts is changed from those printed on previously issued parts list. When ordering replacement parts, be sure to follow the description on the present issue.

When ordering parts, be sure to include the following information:

1. Model and Serial Number
2. Part Number
3. A Description of the Part

This parts list includes all standard stock replacement parts. No attempt has been made to include every nut, bolt and screw. If the necessity for a non-listed part arises, please write describing the parts location and function as well as model and serial number of the unit.

KEYBOARD PARTS

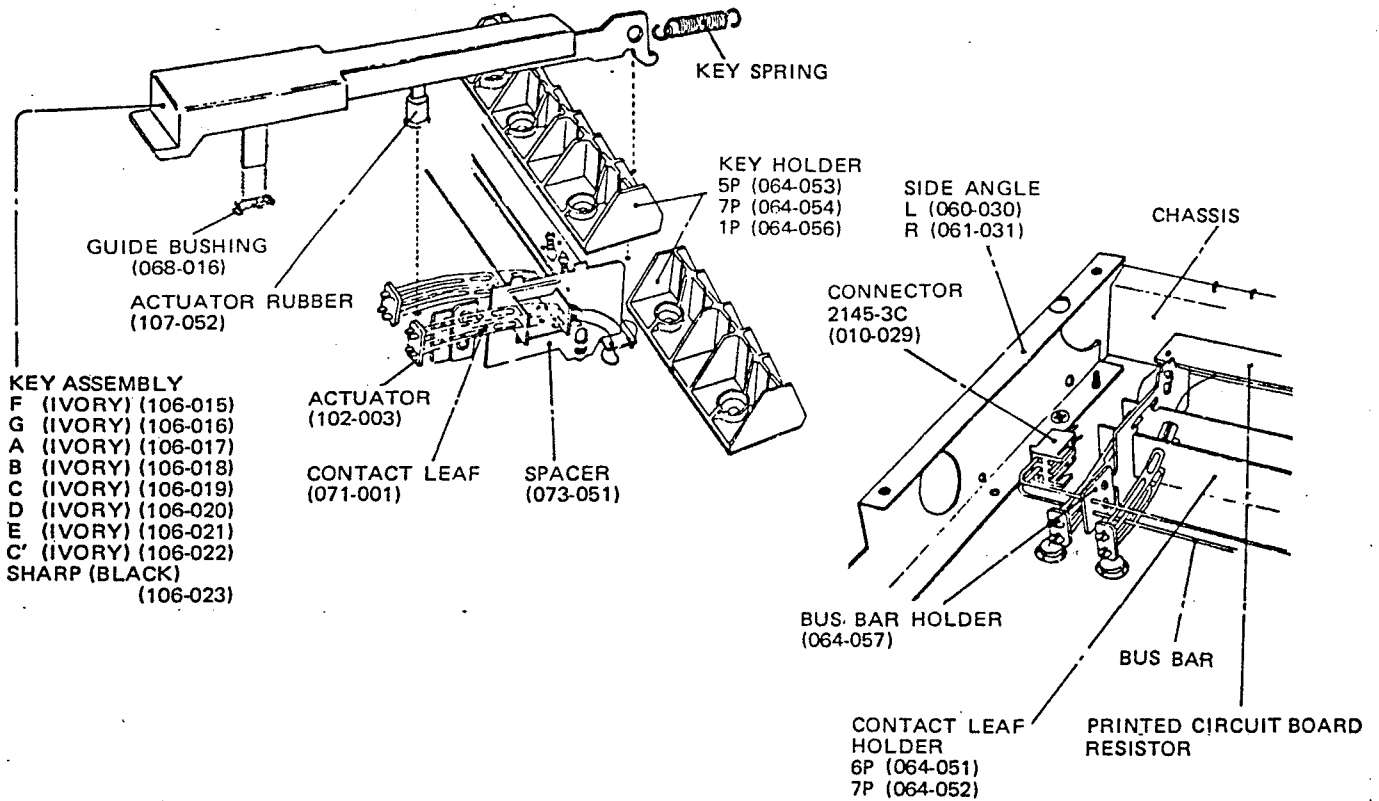

INSTRUMENT MODEL	NO. OF KEYS	KEYBOARD MODEL	KEY SPRING	BUS BAR	PCB		RESISTOR
					6P	7P	
SH-1	32	SK-132-D	070-052	071H034	052-066	052-067	100 1/4W $\pm 1\%$ CRB1/4FX
SH-3A	44	SK-142-A	070-052	071-008	052-066	052-067	100 1/4W $\pm 1\%$ CRB1/4FX
SH-5	44	SK-142-B	070-052	071-008	052-066	052-067	100 1/4W $\pm 1\%$ CRB1/4FX
SH-7	44	SK-142-C	070-052	071-008	052-066	052-067	100 1/4W $\pm 1\%$ CRB1/4FX
SH-1000	37	SK-132-A	070-052	071-006	052-066	052-067	1K 1/4W $\pm 2\%$
SH-2000	37	SK-132-B	070-052	071-006	052-066	052-067	1K 1/4W $\pm 2\%$ SELECTED
SYSTEM-100	37	SK-132-C	070-052	071-006	052-066	052-067	100 1/4W $\pm 1\%$ CRB1/4FX
SYSTEM-700	61	SK-162-C	070-058	071-007	052-066	052-067	100 1/4W $\pm 1\%$ CRA1/4FX
RS-101	61	SK-161-A	070-058	071-007	052-081	052-082	
RS-202	61	SK-161-A	070-058	071-007	052-081	052-082	
EP-10	61	SK-162-A	070-058	071-007			
EP-20	61	SK-162-A	070-058	071-007			
EP-30	61	SK-162B	070-058	071-007	052-081	052-082	