

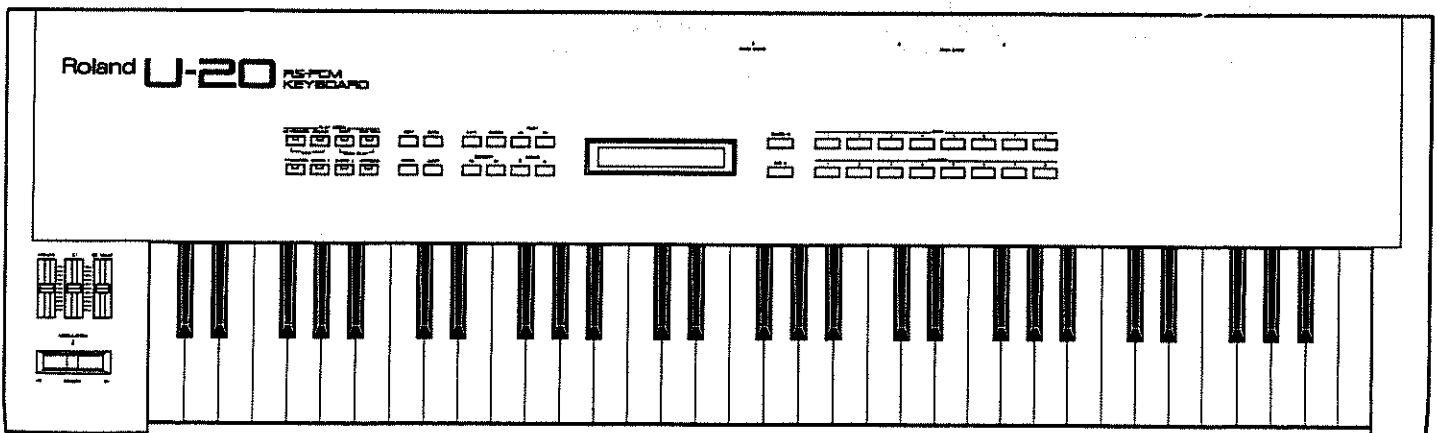

Roland

RS-PCM KEYBOARD

U-20

OWNER'S MANUAL



	CAUTION RISK OF ELECTRIC SHOCK DO NOT OPEN	
ATTENTION : RISQUE DE CHOC ELECTRIQUE NE PAS OUVRIR		
CAUTION: TO REDUCE THE RISK OF ELECTRIC SHOCK, DO NOT REMOVE COVER (OR BACK). NO USER-SERVICEABLE PARTS INSIDE. REFER SERVICING TO QUALIFIED SERVICE PERSONNEL.		



The lightning flash with arrowhead symbol, within an equilateral triangle, is intended to alert the user to the presence of un-insulated "dangerous voltage" within the product's enclosure that may be of sufficient magnitude to constitute a risk of electric shock to persons.



The exclamation point within an equilateral triangle is intended to alert the user to the presence of important operating and maintenance (servicing) instructions in the literature accompanying the product.

INSTRUCTIONS PERTAINING TO A RISK OF FIRE, ELECTRIC SHOCK, OR INJURY TO PERSONS.

IMPORTANT SAFETY INSTRUCTIONS

WARNING — When using electric products, basic precautions should always be followed, including the following:

1. Read all the instructions before using the product.
2. Do not use this product near water — for example, near a bathtub, washbowl, kitchen sink, in a wet basement, or near a swimming pool, or the like.
3. This product should be used only with a cart or stand that is recommended by the manufacturer.
4. This product, either alone or in combination with an amplifier and headphones or speakers, may be capable of producing sound levels that could cause permanent hearing loss. Do not operate for a long period of time at a high volume level or at a level that is uncomfortable. If you experience any hearing loss or ringing in the ears, you should consult an audiologist.
5. The product should be located so that its location or position does not interfere with its proper ventilation.
6. The product should be located away from heat sources such as radiators, heat registers, or other products that produce heat.
7. Avoid using the product where it may be affected by dust.
8. The product should be connected to a power supply only of the type described in the operating instructions or as marked on the product.
9. The power-supply cord of the product should be unplugged from the outlet when left unused for a long period of time.
10. Do not tread on the power-supply cord.
11. Do not pull the cord but hold the plug when unplugging.
12. When setting up with any other instruments, the procedure should be followed in accordance with instruction manual.
13. Care should be taken so that objects do not fall and liquids are not spilled into the enclosure through openings.
14. The product should be serviced by qualified service personnel when:
 - A. The power-supply cord or the plug has been damaged; or
 - B. Objects have fallen, or liquid has been spilled into the product; or
 - C. The product has been exposed to rain; or
 - D. The product does not appear to operate normally or exhibits a marked change in performance; or
 - E. The product has been dropped, or the enclosure damaged.
15. Do not attempt to service the product beyond that described in the user-maintenance instructions. All other servicing should be referred to qualified service personnel.

SAVE THESE INSTRUCTIONS

For the U.K.

WARNING: THIS APPARATUS MUST BE EARTHED

IMPORTANT: THE WIRES IN THIS MAINS LEAD ARE COLOURED IN ACCORDANCE WITH THE FOLLOWING CODE.
GREEN-AND-YELLOW: EARTH, BLUE: NEUTRAL, BROWN: LIVE

As the colours of the wires in the mains lead of this apparatus may not correspond with the coloured markings identifying the terminals in your plug proceed as follows:

The wire which is coloured GREEN-AND-YELLOW must be connected to the terminal in the plug which is marked by the letter E or by the safety earth symbol  or coloured GREEN or GREEN-AND-YELLOW.

The wire which is coloured BLUE must be connected to the terminal which is marked with the letter N or coloured BLACK.

The wire which is coloured BROWN must be connected to the terminal which is marked with the letter L or coloured RED.

The product which is equipped with a THREE WIRE GROUNDING TYPE AC PLUG must be grounded.

Thank you for purchasing the U-20 RS-PCM keyboard. The U-20 contains high-quality digital sounds, and can be used as a multi-timbral sound generator. It also functions as a MIDI keyboard controller, for a wide range of applications both on stage and in the studio. To take full advantage of the U-20's potential and ensure long and trouble-free use, please read this owner's manual carefully.

How to use this Manual

This owners manual consists of the following five sections.

Section 0 "Playing : step1":

This tells how to hear the ROM play (the demo performance), and explains the basic organization of the U-20. Next, you will learn how to select and play the various sounds.

Section I "Playing : step2":

This explains the performance functions of the U-20, and how they can be used to enhance your playing.

Section II "Editing":

This section explains basic procedures for creating sounds and making settings. Read this section when you want to create your own sounds.

Section III "System Setups":

This section explains basic concepts of MIDI that are important when using the U-20, and how to take advantage of the U-20's MIDI functions. If you will be connecting the U-20 with other MIDI devices, be sure to read this section.

Section IV "Summary":

This section summarizes the operations of each mode, explains the overall organization of editing operations, and how to store and manage data.

*You do not need to know about MIDI in order to use the functions explained up to section II.

CONTENTS

FEATURES	5
IMPORTANT NOTES	6
FRONT AND REAR PANEL	7

SECTION 0

Playing : step 1

1 BEFORE YOU PLAY	10
1.Connections	10
2.Turn the Power On.....	11
2 LISTEN TO THE ROM SONGS	12
3 INTRODUCING THE U-20	13
4 TRY OUT THE SOUNDS	18
1.Select and Play sounds in Link Play Mode	18
2.Play the Sounds (Part Play Mode) ..	19
3.Play the Rhythm Sounds (Rhythm Play Mode)	21
■Checking the Selected Parts	22
■Master Tuning.....	23
■Editing procedure using the Jump function	24

SECTION I

Playing : step 2

1 USING AND SETTING THE PERFORMANCE FUNCTIONS	26
1.How To Use the Play Functions	26
a.Keyboard control functions	26
b.Panel control functions	27
c.Pedal control functions	28
d.Useful performance functions.....	29
2.Write the Edited Performance Function Settings	36
a.Name	36
b.Write	37
2 CREATING A CHORD SET	39
a.Editing a chord set	39
b.Chord set name.....	42
c.Writing a chord set into memory.....	43
■Adjusting the Display Contrast	44

SECTION II

EDITING

1 BEFORE YOU CREATE YOUR OWN SOUNDS	46
1.Tones	46
2.About the Multi-timbral Sound Generator	47
3.Sound Creating Procedure	48

Section U
Section I
Section II
Section III
Section IV

2	SOUND PATCH SETTINGS	49
1.	Editing a Sound Patch	49
a.	Settings for each Part (1—6)	50
b.	Rhythm part settings	52
c.	Effect settings	53
d.	Name	56
2.	Storing a Sound Patch (Writing Procedure)	57
3	EDIT THE TIMBRE SETTINGS	58
1.	Timbre Editing	58
a.	Tone select	59
b.	Level	61
c.	Pitch	63
d.	Vibrato	65
e.	Timbre name	67
2.	Storing Timbres (Write Procedure)	68
4	RHYTHM SET SETTINGS	69
1.	Settings for Each Key	70
a.	Selecting tones	71
b.	Level	72
c.	Pitch	74
d.	Output	76
2.	Other Settings	77
3.	Storing a Rhythm Set (Writing Procedure)	79

SECTION III

SYSTEM SETUPS

1	ABOUT MIDI	82
1.	How MIDI Data is Transmitted and Received	82
a.	Connections	82
b.	MIDI channels	84
2.	MIDI Data Used by the U-20	85
2	HOW THE U-20 USES MIDI	88
1.	Editing the MIDI Parameters	88
a.	Editing procedure	88
b.	MIDI parameters	89
2.	Musical Performance Data	91
a.	Keyboard Patch	91
b.	Setup (keyboard)	93
c.	Sound Patch (part 1—6, rhythm part)	94
3.	Program Change	96
a.	Selecting Patches and Timbres from an external MIDI device	97
b.	Transmitting program changes from a Keyboard Patch	99
4.	Using Controllers	101
5.	Exclusive Messages	107
■	Local Control Switch (Off, On)	108
■	Tx Active Sensing Switch (Off, On)	108
■	Writing Procedure for MIDI Settings	108
■	MIDI Settings of Factory Settings	109

3	TAKING FULL ADVANTAGE OF THE U-20	110
1.	Using the U-20 by itself	110
2.	Using a Sequencer	113
■	Velocity Offset and Sensitivity	115
3.	Using External Sound Generators	116
■	Voice Reserve	117

SECTION IV

SUMMARY

1	PLAY MODE OPERATIONS AND FUNCTIONS	120
a.	Playing functions	120
b.	The three Play modes that use Patches	122
c.	Part Play mode/Rhythm Play mode	123
2	EDIT MODE OPERATIONS	124
1.	Edit Procedure	124
2.	The Jump Function	125
3	DATA MODE OPERATIONS	128
1.	Using a RAM Card	128
2.	Write Operations	131
a.	Writing a patch	133
b.	Writing a timbre	136
c.	Writing chord sets/rhythm sets	139
3.	Saving/Loading Data	142
4.	Data Transfer Using MIDI (Dump)	143
a.	Data transmission by group (bulk dump)	145
b.	Patch Dump	146
c.	Transmitting data of the specified parameter (parameter dump)	146
5.	Utilities	147
a.	Initialize (Data/Util/Initialize)	147
b.	MIDI Monitor (Data/Util/MIDI Monitor)	149

SUPPLEMENTARY MATERIAL

1.	Error and other Messages	152
2.	Troubleshooting	154
3.	Operation Map	156
4.	Parameter List	158
5.	Factory Setting	162
6.	Preset Tone List	166
7.	Initialized Settings	170
8.	Blank Charts	173
	MIDI Implementation	178
	Main Specifications	193
	Index	194

Copyright ©1989 by ROLAND CORPORATION

All rights reserved. No part of this publication may be reproduced
in any form without the permission of ROLAND CORPORATION.

FEATURES

The U-20 has features such as ;

●High-quality RS-PCM Sound Generation

The U-20 contains 128 types of high-quality sound, ranging from piano to instruments appropriate for a classical or jazz ensemble, and synth sounds for rock or fusion. Parameters (elements of sound) for pitch and level can be used for detailed control over the nuances of each tone (sound).

In addition to the built-in tones, tones from PCM cards (sound library SN-U110 series) sold for the U-110 can also be used.

●Multi-timbral

The U-20 contains a multi-timbral sound generator that can handle 6 parts and an additional rhythm part. The sounds (timbres) and effects of each part can be stored in 64 different settings as sound patches. When using a MIDI sequencer, a single U-20 can fill the role of an entire ensemble.

For the rhythm part, tone assignments and settings can be stored as one of four rhythm sets.

●Flexible Control Functions

Settings determining how controllers affect performance can be stored as one of 64 keyboard patches, allowing you to modify sounds as you play, or control different types of external tone generator.

●Built-in Digital Effect

A digital reverb/chorus effect is built in, providing a spacious feeling of stereo depth. Each sound patch has its own effect settings.

●Chord Play Function

A chord can be assigned to each key, allowing you to play chords with a single finger. Since a different chord can be assigned to each key C, C# — B, you can perform using diatonic chords or harmonies in thirds. Eight sets of chords can be stored in the U-20 (one set includes C, C# — B). While playing, you can instantly switch between any two previously specified sets of chords.

●Arpeggio Play Function

A chord you hold down can be automatically arpeggiated. An arpeggiation pattern can be set for each keyboard patch, allowing you to use the musically appropriate pattern for each situation. Arpeggio can be switched on/off using a button, and can be used in conjunction with the chord play function.

●Jump Function

The jump function allows you to instantly jump to a specified screen. In addition to the pre-defined screens, you may also define your own. Using the jump function can make the editing process more efficient.

●RAM Card for Convenient Data Storage

A separately sold RAM card (M-256E) can store the entire settings of the U-20. Patches stored in a RAM card can instantly be recalled for use.

IMPORTANT NOTES

In addition to the safety instructions on page 2, please note the following points.

Concerning the Power Supply

- Whenever you make any connections with other devices, always turn off the power to all equipment first. This will help in preventing malfunction, and damage to speakers.
- Do not connect the unit to the same power outlet as one used for distortion producing devices (such as motors, variable lighting devices). Be sure to use a separate power outlet.

Concerning Placement

- Should the unit be operated nearby television or radio receivers, TV pictures may show signs of interference, and static might be heard on radios. In such cases, move the unit out of proximity with such devices.

Maintenance

- For everyday cleaning, wipe the unit with a soft dry cloth, or one that is dampened slightly. To remove dirt that is more stubborn, wipe using a mild, neutral detergent. Afterwards, make sure to wipe thoroughly with a soft cloth.
- Never apply benzene, thinners, alcohol or any like agents, to avoid the risk of discoloration and deformation.

Other Precautions

- Protect the unit from strong impact.
- Avoid getting any foreign objects (coins, wire, etc.), or liquids (water, drinks, etc.) into the unit.
- A certain small amount of heat will be radiated from the unit, and this should not be considered a malfunction.

- Before using the unit in a foreign country, check first with your local Roland Service Station.

Concerning Memory Backup

- The unit contains a battery which maintains the contents of memory while the main power is off. The normal life of this battery is 5 years or more, but it is strongly recommended that you change it every 5 years as a rule. When it is time to change the battery, contact a Roland Service Station.
 - * The first time you need to change the battery could occur before 5 years have passed.
- When the battery gets weak the following will appear in the display. By this time, it is possible that the contents of memory have already been lost. "Internal Battery Low!"
- Please be aware that the contents of memory may at times be lost; when sent for repairs or when by some chance a malfunction has occurred. Important data should be saved on RAM Card, or written down on paper. During repairs, due care is taken to avoid the loss of data, however, in certain cases, such as when circuitry related to memory itself is out of order, we regret that it may be impossible to restore the data.

FRONT AND REAR PANEL

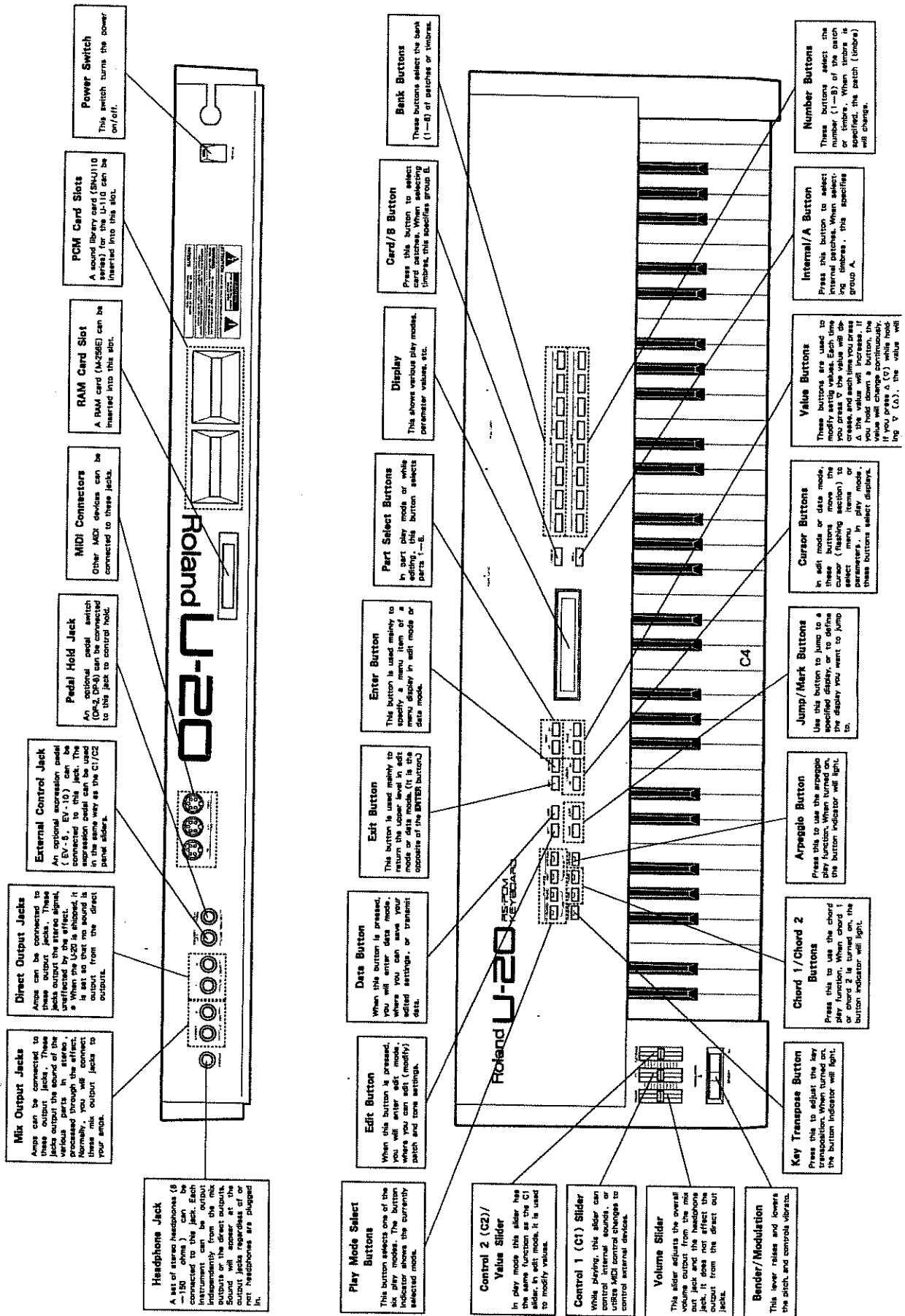

SECTION 0

Playing : step 1

— Listen to the sounds ! —

The U-20 contains two demo songs which take advantage of its multi-timbral capability (the ROM Play function). In section 0, after telling you how to make connections, we will explain about ROM play. Next we will explain the basic organization of the U-20, and its play modes. This section will be very important in helping you to understand the U-20's functions, so please be sure to read it carefully. Finally, play the keyboard to make sure that sound is being produced.

1	BEFORE YOU PLAY	10
	1.Connections	10
	2.Turn the Power On	11
2	LISTEN TO THE ROM SONGS	12
3	INTRODUCING THE U-20	13
4	TRY OUT THE SOUNDS	18
	1.Select and Play sounds in	
	Link Play Mode	18
	2.Play the Sounds (Part Play Mode)	19
	3.Play the Rhythm Sounds	
	(Rhythm Play Mode)	21
	■ Checking the Selected Parts	22
	■ Master Tuning	23
	■ Editing procedure using the	
	Jump function	24

1 BEFORE YOU PLAY

1. Connections

Connect the rear panel MIX OUT jacks to the input jacks of a keyboard amp or mixer. When playing in stereo, use the L and R jacks. When playing in mono, use only the L (MONO) jack. Before making connections, make sure that the power switches of the U-20 and the amp are off. When using headphones, insert the headphone plug into the PHONES jack.

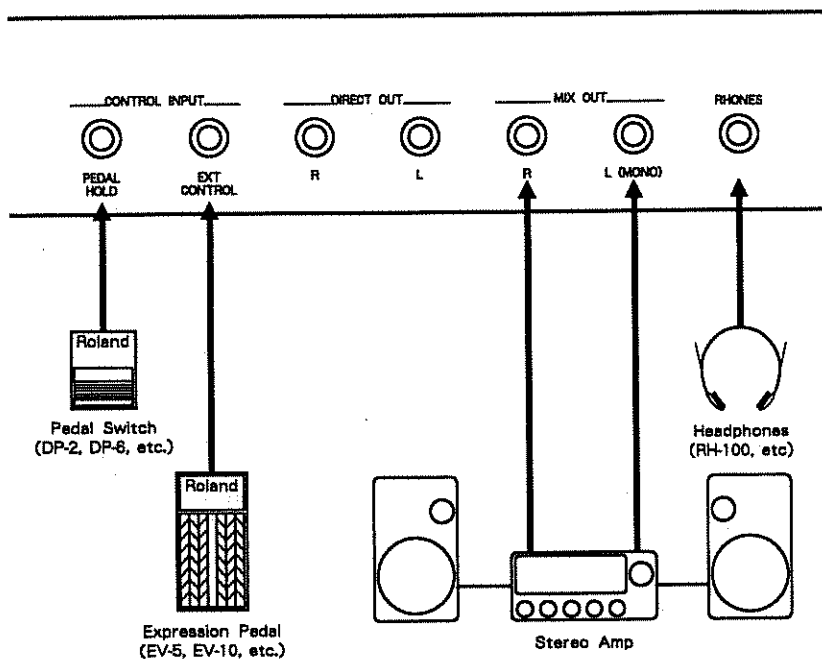

- * The U-20 does not contain a built-in power amp or speaker, and will not make sound by itself.
- * When shipped, the U-20 is set so that no sound appears at the DIRECT OUT jacks.
- * When connecting the U-20 directly to a stereo system, be careful of the output level. Excessively high levels can damage the speakers etc. of the stereo system.
- * To take full advantage of the U-20, we suggest that you play it in stereo.

2. Turn the power on

① Check that connections for power and external equipment (amplifiers, etc.) are correct.

② Turn the power switch of the U-20 on.

In a short time the following message will appear.



```
RS-PCM Keyboard  
Roland U-20
```

Then the play mode indicator will light, and the patch name will be displayed.

```
I-11 #001 : Standard  
I-11 #001 : Acoust Piano
```

③ Turn the power of the external equipment (amplifiers, etc.) on.

Now you are ready to play.

* After the power is turned on, the U-20's protection circuit inserts a short delay before operation begins.

2 LISTEN TO THE ROM SONGS

The U-20 contains 2 demo songs that demonstrate its multi-timbral capabilities. ROM play mode automatically plays these songs.

* When using the ROM play function, we suggest that you connect a stereo amp system or listen through headphones in order to get the full benefit of the U-20's multi-timbral capabilities.

① Simultaneously press the **PART** and **RHYTHM** buttons to enter ROM play mode.

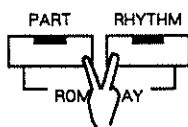

Song #1 HYPER JAZZ
Press [ENTER] to Start

④ To stop playback, press **EXIT**.

③ Press **ENTER** and playback will begin.

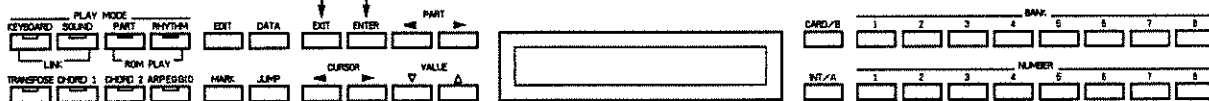

1	HYPER JAZZ	Music by Amin Bhatia ©1989 by Amin Bhatia
2	U - ROCK	Music by S. Nakamura ©1989 by Roland Corp.

② Use the **NUMBER** **1**, **2** buttons to specify the song. Songs will be played successively, starting with the selected song. If you do not specify a song, playback will begin with song 1.

VOLUME

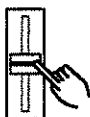

Use the **VOLUME** slider to adjust the volume.

- * It is often convenient to check connections and volume while using ROM play.
- * To use the U-20 to play songs as in ROM play, you will need a separate MIDI sequencer.
- * The keyboard and bender will not function during ROM play.
- * The notes and other musical data being ROM played will not be transmitted from MIDI OUT.

3 INTRODUCING THE U-20

■ How the U-20 is organized

The U-20 consists of a keyboard controller section and a multi-timbral sound generator section.

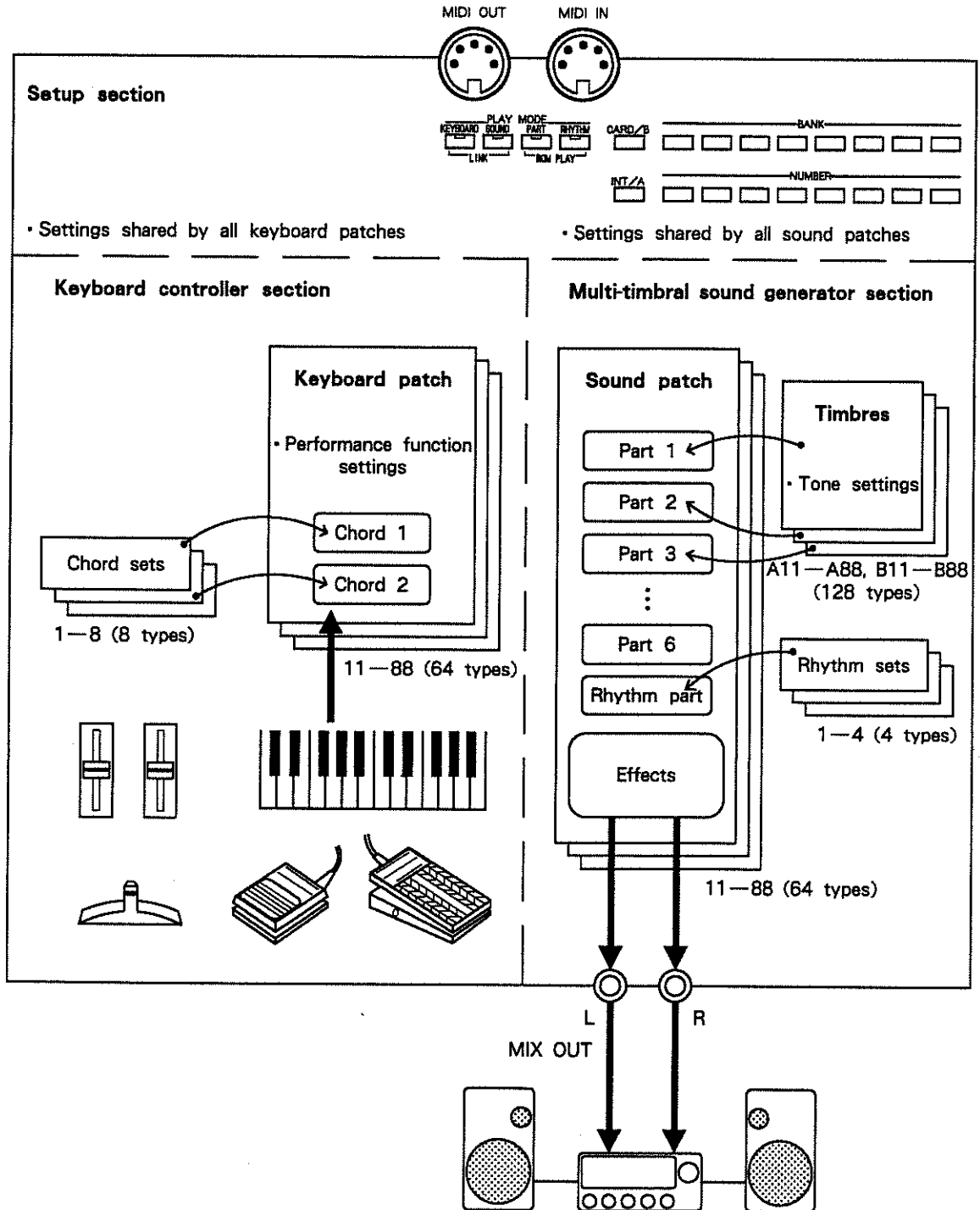

● **Multi-timbral Sound Generator Section**

The multi-timbral sound generator can store 64 Sound Patches. Each Sound Patch consists of Parts 1—6 and a Rhythm part.

Each part corresponds to a musician. For example, part 1 might be a pianist, part 2 might be a bassist, etc. It goes without saying that the rhythm part is the drummer. The instrument (timbre) used by each musician can be freely selected, and changed even while playing. The rhythm part can select from four types of drum/percussion sets (rhythm sets). In addition, each Sound Patch can specify the volume of each instrument (level), the position of each instrument (pan), and the ambience of the performing environment (effect). Also, the sounds of two or more Parts can be combined to make even richer, more complex sounds. In this way, you can create Sound Patches with various combinations of instruments, and instantly change to an entirely different instrumental ensemble simply by selecting a Sound Patch.

● **Keyboard Controller Section**

The controller section sends playing instructions to the musicians. When you play the keyboard, the instrument of the specified part will sound. Use the bender lever to add vibrato or pitch change. Controller section settings can be stored as one of 64 keyboard patches.

When using a MIDI sequencer etc., you can use the keyboard to play along with the sequence.

The U-20 can also be used as a keyboard controller to control external sound generator modules.

■ **The Modes of the U-20**

The U-20 operates in

Play mode,

Edit mode, in which you modify or edit various settings, and

Data mode, in which you can store the results of your editing, and transfer data.

● **Play Mode**

The U-20 has 6 play modes.

In Link Play mode, Keyboard Patch mode, and Sound Patch mode, you can select Patches from the front panel.

In Part Play mode, you can select one of the six Parts, and play it from the keyboard.

In Rhythm Play mode, you can use the Rhythm Part to play rhythm sounds from the keyboard.

In ROM Play mode you can listen to the U-20's demonstration songs.

Play mode	Part played by the keyboard	Selected by the BANK and NUMBER buttons
Link Play mode	Parts specified by the Keyboard Patch	Keyboard Patch and Sound Patch
Keyboard Patch mode		Keyboard Patch
Sound Patch mode		Sound Patch
Part Play mode	Part selected from Parts 1—6 (use the panel buttons)	Timbre
Rhythm Play mode	Rhythm Part	Rhythm Set
ROM Play mode	Keyboard is inactive	ROM Play song

● **Edit Mode**

In this mode you can edit (change or modify) various control settings and tone settings. With a few exceptions, edited settings are temporary. If you want to keep your edited settings, use data mode operations to store them into internal memory or a separately sold RAM card.

● **Data Mode**

In this mode you can store edited settings into internal memory or a separately sold RAM card, or transmit data via MIDI.

● **Link Play mode (simultaneously selecting a Keyboard Patch and Sound Patch)**

Example : selecting Patch I-33

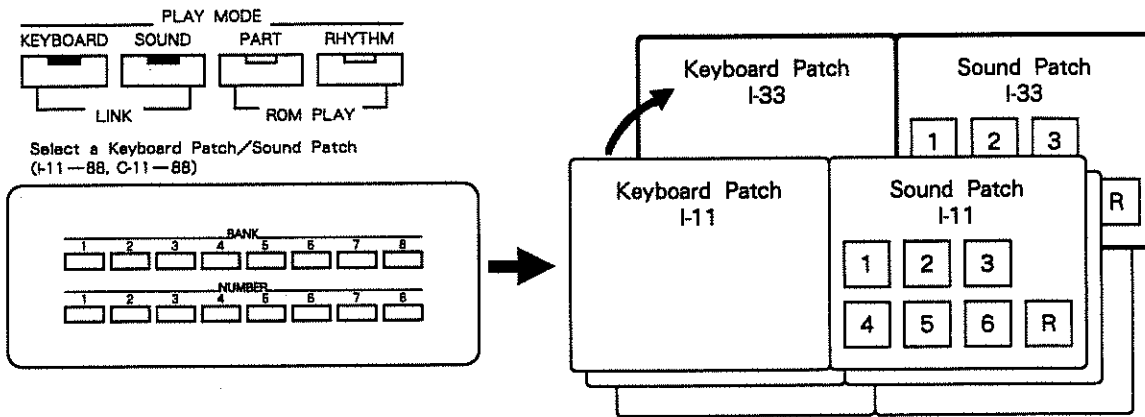

● **Keyboard Patch mode (selecting only a Keyboard Patch)**

Example : selecting Keyboard Patch I-33

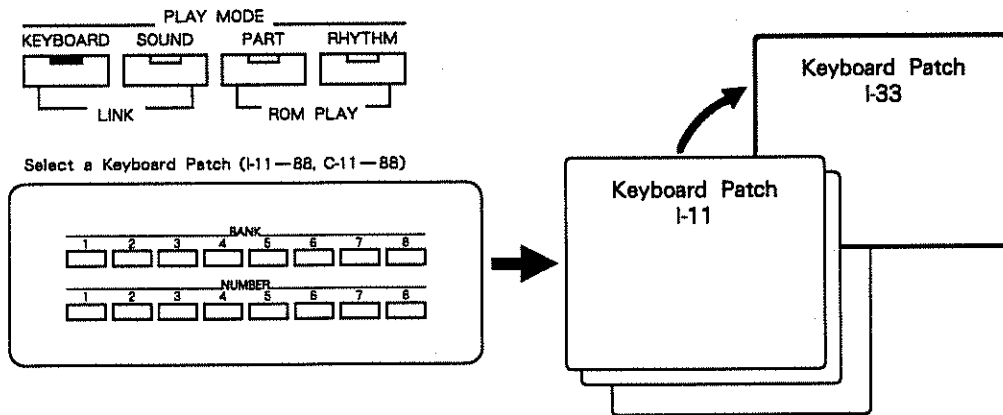

● **Sound Patch mode (selecting only a Sound Patch)**

Example : selecting Sound Patch I-33

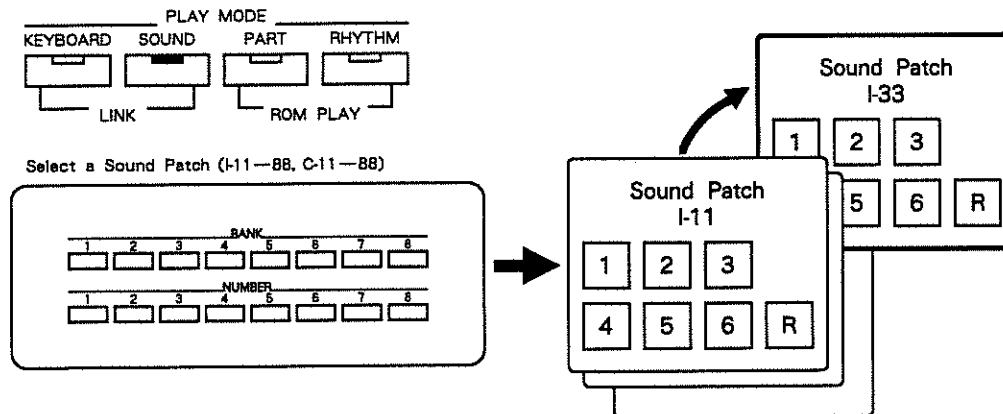

●Part Play mode (selecting a Timbre)

Example : selecting Timbre A33 for Part 1

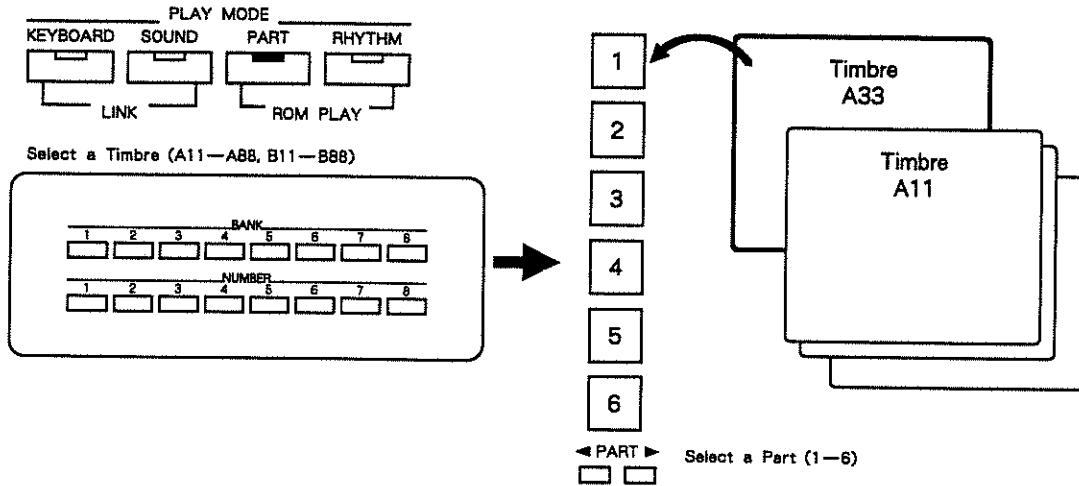

●Rhythm Play mode (selecting a Rhythm Set)

Example : selecting Rhythm Set 3 for the Rhythm Part

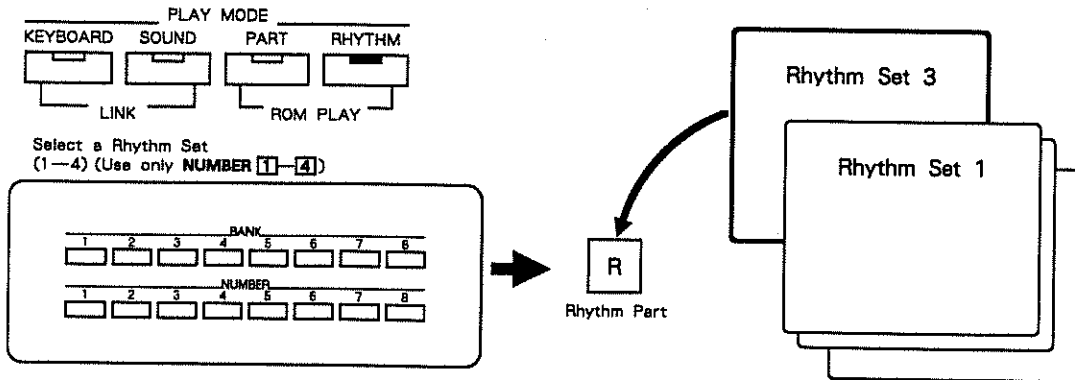

●ROM Play mode (selecting the ROM Play song)

Example : selecting ROM Play song 2 "U-ROCK"

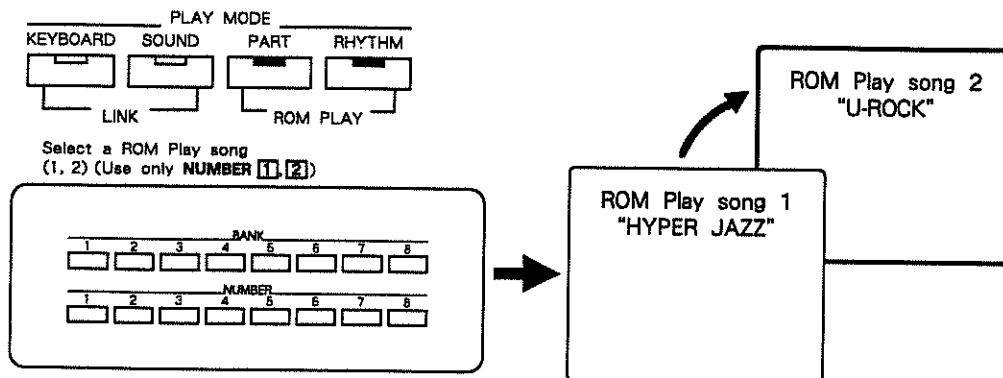

4 TRY OUT THE SOUNDS

Here we will explain how to select play sounds in each of the play modes.

1. Select and Play sounds in Link Play Mode

In Link Play mode, pressing panel buttons will simultaneously select a Keyboard Patch (determining how the sounds are played) and a Sound Patch (determining which sounds are played). When shipped from the factory, the memory contains data intended to be played in Link Play mode.

By selecting a bank 1—8 and a number 1—8, you can select from 64 Patches.

Enter Link Play mode.

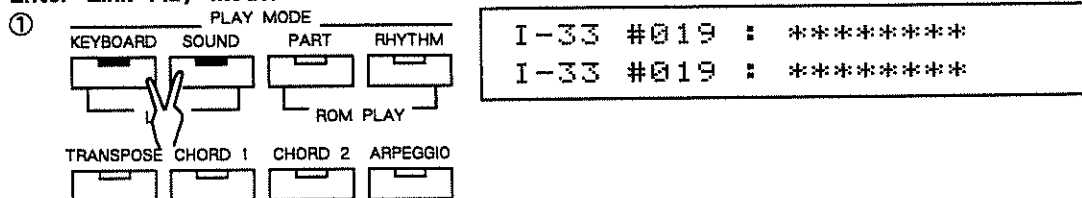

Use BANK 1—8 and NUMBER 1—8 to select Patches.

For example, here's how to select I-11.

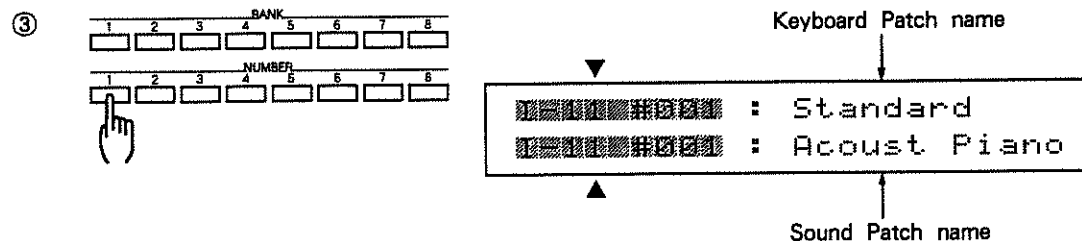
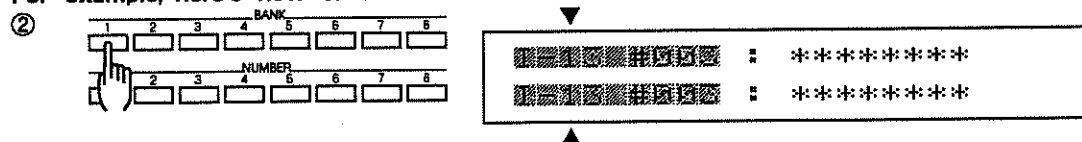

The display will show the number and name of the selected Patch.

Play the keyboard to hear the sound you have selected, and then select and play other Patches. The included sound patch chart shows the Patches available.

- * The Patch will change when you select the number. Simply selecting the bank will not change the Patch.
- * You can use ∇ VALUE Δ to step through the Patches one by one.

2. Play the Sounds (Part Play mode)

In part play mode you can use the Keyboard to select and play various sounds (Timbres) using a single Part of the selected Sound Patch (select from Part 1—6). Part play mode is convenient when checking the settings of each Part, or when editing sounds.

You can select from 128 Timbres, organized as group A/B, bank 1—8, and number 1—8.

Enter Part Play Mode.

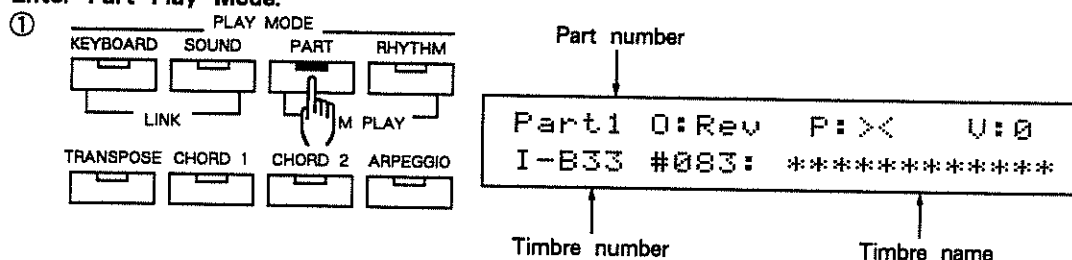

Select and play Parts, noticing the various sounds assigned to each Part.

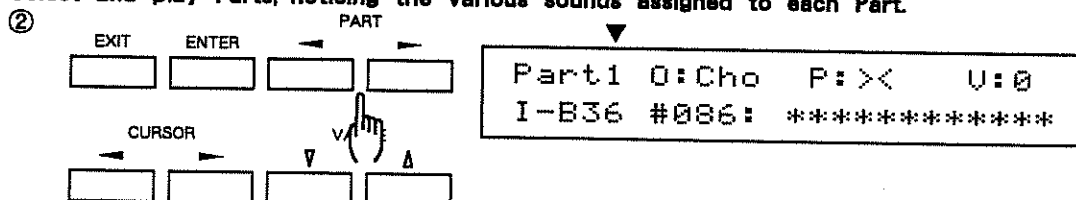

Play the keyboard to hear the displayed Timbre.

Next, select a different Timbre. Use group (A/B), bank (1—8) and number (1—8) to select a Timbre.

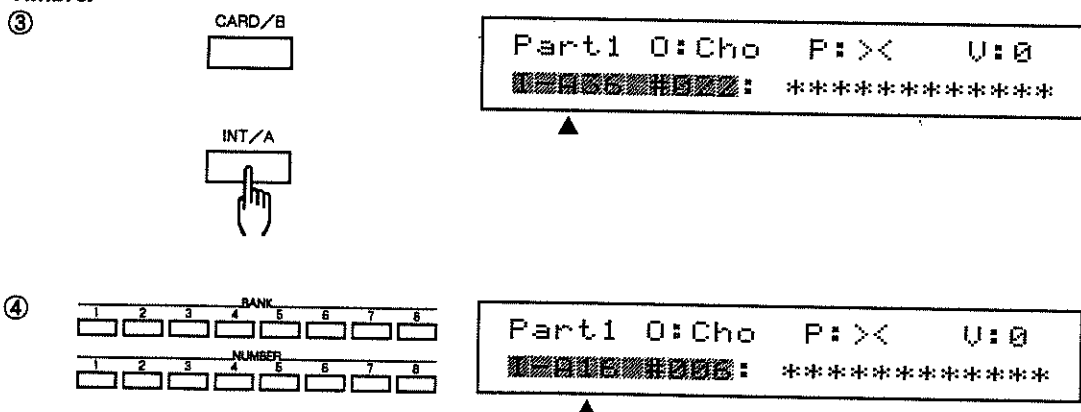



The included “Timbre Chart” lists the available timbres.

- * The sound will change when you specify the number. Simply selecting a group or bank will not make the sound change.
- * Press ∇ VALUE Δ to step through the sounds.
- * In part play mode, notes you play will not be transmitted from MIDI OUT.
- * Depending on the settings of the selected sound patch (key range, velocity range, see page 95), the resulting sound may not be what you expect.

Keyboard Patch mode

When you want to select only the Keyboard Patch, press **KEYBOARD**. When you press panel buttons to select a patch, only the Keyboard Patch will change.

Sound Patch mode

When you want to select only the Sound Patch, press **SOUND**. When you press panel buttons to select a patch, only the Sound Patch will change.

3. Play the Rhythm Sounds (Rhythm Play Mode)

To play the rhythm sounds from the keyboard, enter rhythm play mode. Rhythm play mode is useful when checking a rhythm set, or when editing sounds.

Enter rhythm play mode.

①

PLAY MODE			
KEYBOARD	SOUND	PART	RHYTHM
<input type="checkbox"/>	<input type="checkbox"/>	<input type="checkbox"/>	<input checked="" type="checkbox"/>
LINK		ROM PLAY	
TRANSPOSE	CHORD 1	CHORD 2	ARPEGGIO
<input type="checkbox"/>	<input type="checkbox"/>	<input type="checkbox"/>	<input type="checkbox"/>

I-R1: Standard Set U:0
C2 : I-128 So:C2 Mu:Off

When you play the keyboard, the rhythm sound corresponding to each key will sound. The display will show the note name etc. of the key you pressed. For the factory settings, refer to the table at the end of this manual.

②



I-R1: Standard Set U:0
D2 : I-128 So:D2 Mu:Off

Use NUMBER 1—4 to select another rhythm set.

③

BANK							
1	2	3	4	5	6	7	8
<input type="checkbox"/>	<input type="checkbox"/>	<input type="checkbox"/>	<input type="checkbox"/>	<input type="checkbox"/>	<input type="checkbox"/>	<input type="checkbox"/>	<input type="checkbox"/>
NUMBER							
1	2	3	4	5	6	7	8
<input type="checkbox"/>	<input checked="" type="checkbox"/>	<input type="checkbox"/>	<input type="checkbox"/>	<input type="checkbox"/>	<input type="checkbox"/>	<input type="checkbox"/>	<input type="checkbox"/>

I-R2: Dry Set U:0
D2 : I-128 So:D2 Mu:Off

* Press VALUE to step through the rhythm sets.

* In rhythm play mode, notes you play will not be transmitted from MIDI OUT.

About Rhythm Sets

A rhythm set is an arrangement of rhythm sounds assigned to each key (note). A different sound can be assigned to each of the U-20's 64 keys B1—D7. Internal memory can store four rhythm sets. A rhythm set can be selected for a rhythm part.

■ Checking the Selected Parts

The U-20's multi-timbral sound generator has 6 Parts and a Rhythm Part. In play modes which select Patches, such as Link Play mode, the Parts specified by the Keyboard Patch will determine which Parts are used. Here's how to see which Parts are currently being used.

Enter Sound Patch mode.

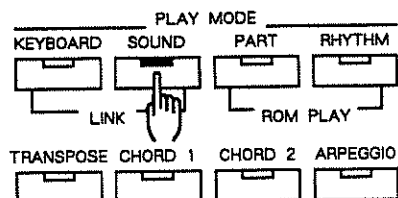

```
I-11 #001 : Standard
I-11 #001 : Acoust Piano
```

Press CURSOR . (If you press CURSOR you will return to the previous display.)

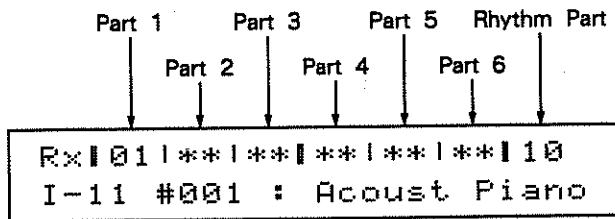
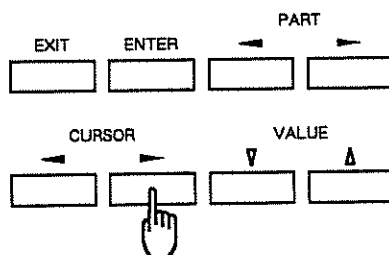

*The upper line of the display shows the Rx channel of each Part.

The Rx channel of the Part specified by the Keyboard Patch will be shown as an symbol. (With the factory settings, Parts specified "01" are used.)



```
Rx|  |**|**|**|**|**|10
I-11 #001 : Acoust Piano
```



■ Master Tuning

When you need to modify the overall pitch of the U-20, use the following procedure to make fine adjustments in pitch (tuning).

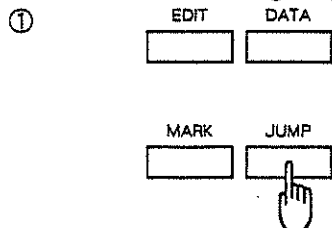
Get the master tuning display.

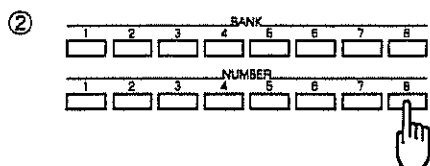

```
Part1 0:Rev P:>< U:0
JUMP: Select Switch.
```



```
Edit/Setup/M.Tune
Master Tune=440.000Hz
```

Use ∇ VALUE Δ or the VALUE slider to adjust the pitch.

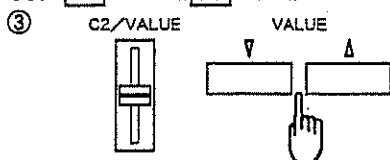

```
Edit/Setup/M.Tune
Master Tune=440.000Hz
```

When you are finished, return to play mode.

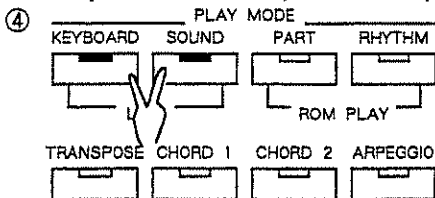







```
I-11 #001 : Standard
I-11 #001 : Acoust Piano
```

- *The displayed value shows the approximate frequency of the pitch of the A4 key.
- *The master tuning setting will be remembered even when the power is turned off.

■ Editing procedure using the Jump function

The U-20's jump function allows you to quickly move to a desired display. You can use the jump function for more efficient editing. The owner's manual will explain procedures for efficient use of the jump function.

Editing procedure using the jump function is as follows.

- ① Use the jump function to jump to the desired parameter display (menu display).
- ② In a menu display, use  CURSOR  to select the parameter group, and press  (a parameter display appears).
- ③ In a parameter display, use  CURSOR  to select the parameter.
- ④ Use  VALUE  or the VALUE slider to modify the value.
- ⑤ When finished, press the play mode select button to return to play mode.

* For details of the editing procedure, see "Edit Mode Operations" (→ page 122).

* Some of the jump destinations can be re-defined by you, to fit your needs better. If you are using the U-20 for the first time, and the jump destinations are different than those explained in the manual, you can use the following procedure to reset the jump destinations to their factory settings.

The diagram illustrates the sequence of button presses to initialize the jump page function. It shows three stages of the process:

- Stage 1:** A menu with **EDIT** and **DATA** buttons. A hand points to the **JUMP** button. A text box displays: `Jump: Select Switch.`
- Stage 2:** A menu with **EDIT** and **DATA** buttons. A hand points to the **MARK** button. A text box displays: `Initialize Jump Page Sure? [ENTER] / [EXIT]`
- Stage 3:** A menu with **EXIT**, **ENTER**, and **PART** buttons. A hand points to the **ENTER** button. A text box displays: `Initialize Jump Page Function Complete.`

Below the third stage, a row of buttons labeled **CURSOR** and **VALUE** is shown, with a hand pointing to the **VALUE** button. A final text box states: `The jump destinations will be reset to their factory settings, and you will return to the previous display.`

SECTION I

Playing : step 2

In section I, we will explain how to use the performance functions to enhance your playing. Try out the operations explained here for yourself, and see how they sound.

1 USING AND SETTING THE PERFORMANCE FUNCTIONS	26
1. How To Use the Play Functions	26
a. Keyboard control functions	26
b. Panel control functions	27
c. Pedal control functions	28
d. Useful performance functions	29
2. Write the Edited Performance	
Function Settings	36
a. Name	36
b. Write	37
2 CREATING A CHORD SET	39
a. Editing a chord set	39
b. Chord set name	42
c. Writing a chord set into memory	43
■ Adjusting the Display Contrast	44

1 USING AND SETTING THE PERFORMANCE FUNCTIONS

1. How To Use the Play Functions

Here we will explain how to use and set the performance functions, and simple settings for them. The resulting effect of these play functions is determined by each sound. Depending on the selected sound, the play functions may have a different effect, or no effect at all.

In section 0, you listened to the sounds using each of the Play modes. To follow the explanation in this section, please enter Link Play mode.

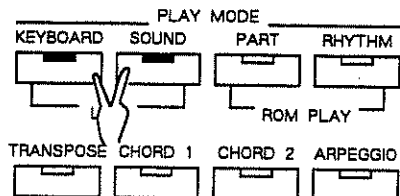

```
I-11 #001 : Standard  
I-11 #001 : Acoust Piano
```

a. Keyboard control functions

The sound can be affected by how you play the keyboard.

●Velocity

The force (speed) with which you play a key is known as the "velocity". The velocity can modify the volume.

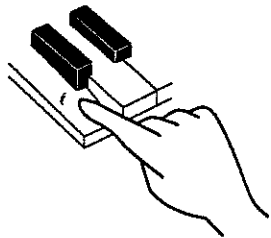

When you press a key slowly, a quiet sound is produced.

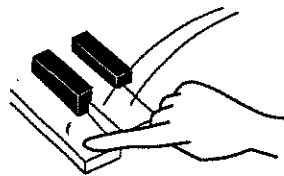

When you press a key quickly, a loud sound is produced.

●Aftertouch

Pressing down on a key after playing it can modify the pitch/vibrato/volume. This is known as "aftertouch".

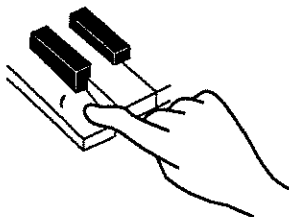

Press down firmly.

* For some sounds of the factory settings, aftertouch will have no effect.

b. Panel control functions

The front panel provides the following functions to use while playing.

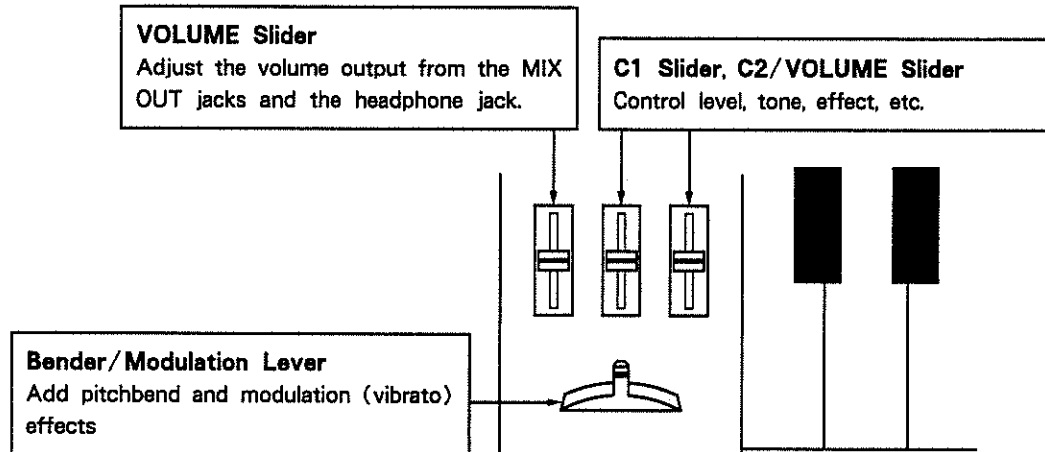

● Bender/Modulation Lever

The position of the bender/modulation lever can affect the pitch or vibrato as follows.

Vibrato (pitch modulation) becomes deeper.

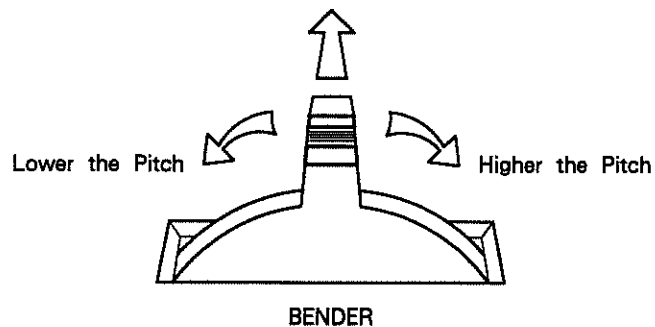

● C1 Slider, C2/VALUE Slider

The C1 and C2 sliders can be used to control internal sounds or to control external sound generators. Each slider can be assigned to control something different. With the factory settings, C1 and C2 are not assigned to control internal sounds.

* The control functions correspond to MIDI control changes.

* To set the function of the control sliders, see "Using Controllers" (page 101).

c. Pedal control functions

Pedals connected to the rear panel jacks can perform the following control functions.

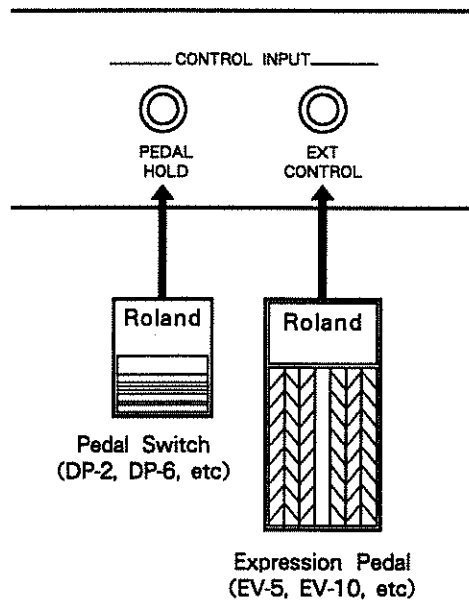

● Hold

A separately sold pedal switch (DP-2, DP-6, etc.) can be used to control hold. The hold function sustains the sound as long as the pedal is pressed.

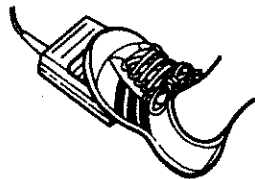

Hold as long as the pedal is pressed

* The hold function will not affect non-sustaining sounds such as rhythm sounds.

● External Control

A separately sold expression pedal (EV-5, EV-10, etc.) can be used in the same way as the C1 and C2 sliders on the front panel to control internal sounds or external sound generators. With the factory settings, External control is not assigned to control internal sounds.

* The control functions correspond to MIDI control changes.

* To make control function settings, see "Using Controllers" (page 101).

d. Useful performance functions

The U-20 includes various functions that are especially useful for live performance; key transpose, chord play, and arpeggio play. By defining how these functions will work, you can turn them on/off at the touch of a button.

* Edited settings are temporary. If you want to save your edited settings, be sure to write them into memory (☞ page 37).

■ Key Transpose

Key transpose shifts the keyboard range in half-steps, allowing you to play in a different key while using the same fingering. You can transpose over a range of ± 3 octaves.

Each time you press **TRANSPOSE**, key transpose will be switched on/off. When on, the button indicator will light. With the factory settings, this will lower the pitch one octave.

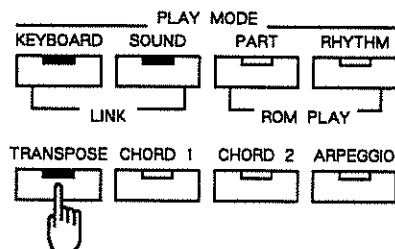

Use the following procedure to change the key transpose setting.

Jump to the key transpose setting display.

①

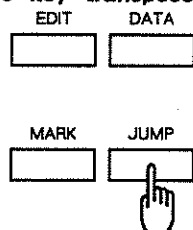

```
I-11 #001 : Standard
JUMP: Select Switch.
```

1. How To Use the Play Functions

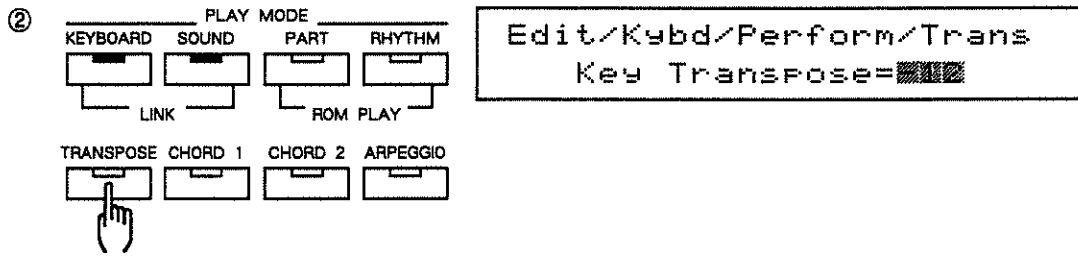

Use ∇ VALUE Δ or the VALUE slider to set the amount of transposition (-36—+36 in semitone steps).

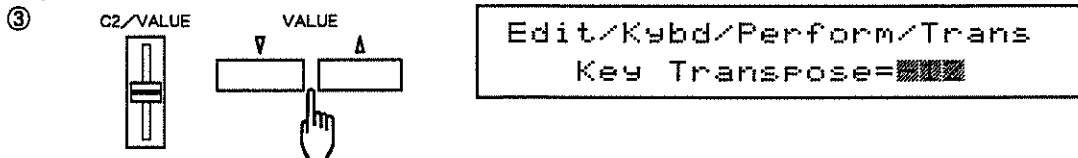

When you finish making settings, return to play mode.

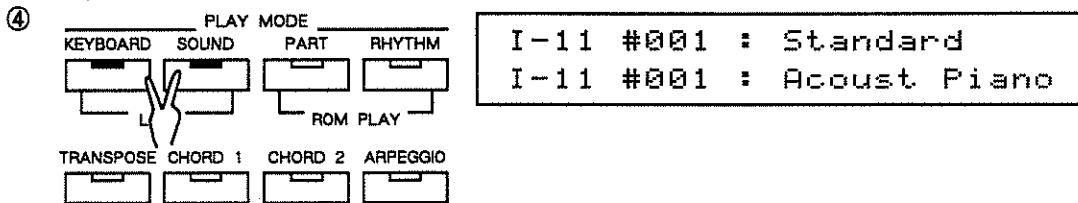

■ Chord Play

Chord play allows you to play a chord by pressing a single key. Try it out using the pre-defined set of chords.

Chord Set

A different chord can be set for each of the 12 notes C, C#—B. Chord settings for each of the 12 notes can be stored as a Chord Set. Internal memory holds eight different Chord Sets. For details of these settings, refer to "Creating a Chord Set" (page 39).

While playing, you can instantly select from the chord sets defined for the **CHORD 1** and **CHORD 2** buttons.

Press **CHORD 1**. The button indicator will light, and you can play the chords of **CHORD 1**.

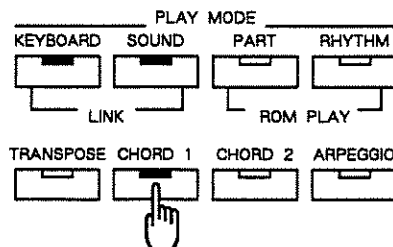

Press each key in succession. The chord assigned to each key will sound. When more than one key is pressed, the chord of the last-pressed key will sound.

Press **CHORD 1** again to return to normal playing (the indicator goes out).

Select **CHORD 2** in the same way. To switch directly from **CHORD 1** to **CHORD 2**, simply press **CHORD 2**, and vice versa.

Settings for Key Offset and Retrigger Mode allow you to specify how the chord set assigned to each button will be used.

Key Offset: The chord set can be transposed over a range of 0–11 (semitone steps). Use this when you want to use the same set of chords to play a song in a different key.

Retrigger Mode: If more than one key is pressed and a chord is sounding, this determines which chord will be sounded when the key producing the currently sounded chord is released. Retrigger mode can be set to Off, Low, or Hi. The velocity of a retriggered chord will be determined by the speed at which you release the key.

Example: When several keys are being pressed and the chord assigned to E key is sounding, here's what happens when you release the E key.



Retrigger Mode : Off



No sound

Retrigger Mode : Low



The chord of the lowest key will sound

Retrigger Mode : Hi



The chord of the highest key will sound

●Chord Set Assign and other Settings

CHORD 1 and **CHORD 2** can each use one of the 8 chord sets. To select a chord set or make settings for key offset or reregister mode, use the following procedure.

Jump to the chord set assign display.

①

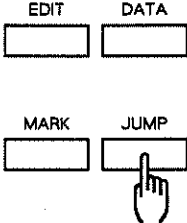

I-11 #001 : Standard
 Jump: Select Switch.

②

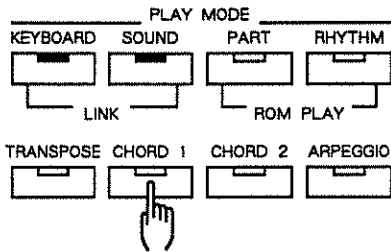

Edit/Kybd/Perform/Chord1
 Chord=#00: Diatonic ▶

Press **CHORD 1** or **CHORD 2** to select the button for which you want to select a chord set.

③

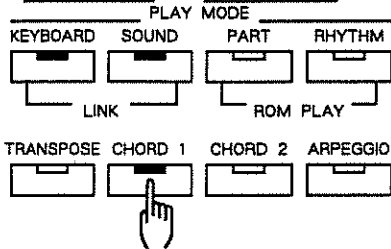

Edit/Kybd/Perform/Chord1
 Chord=#00: Diatonic ▶

Select a chord set (1—8).

④

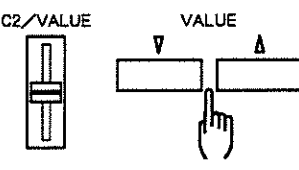

Edit/Kybd/Perform/Chord1
 Chord=#04: Sus4 ▶

↑
Chord Set number

If desired, set the key offset and retrigger mode.

Press **CURSOR**  to make the key offset value blink.

⑤

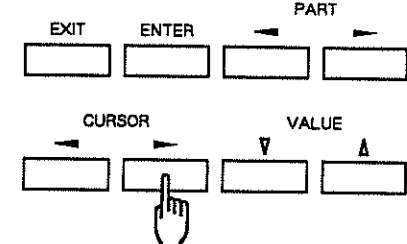

EXIT ENTER PART

Cursor VALUE

Edit/Kybd/Perform/Chord1
KeyOffset=0 Retrig=Hi

Set the key offset.

⑥



C2/VALUE VALUE

Edit/Kybd/Perform/Chord1
KeyOffset=0 Retrig=Hi

Press **CURSOR**  to make the retrigger mode value blink.

⑦

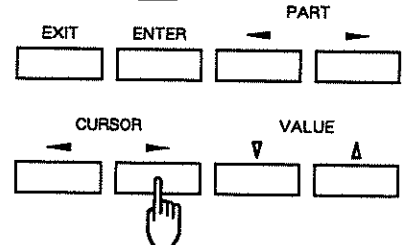

EXIT ENTER PART

Cursor VALUE

Edit/Kybd/Perform/Chord1
KeyOffset=0 Retrig=0

Select the retrigger mode.

⑧



C2/VALUE VALUE

Edit/Kybd/Perform/Chord1
KeyOffset=0 Retrig=0

When you finish making settings, return to play mode.

⑨

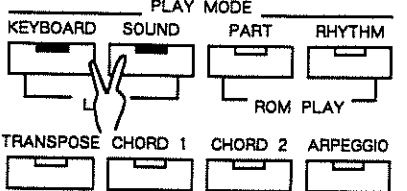

PLAY MODE

KEYBOARD SOUND PART RHYTHM

ROM PLAY

TRANSPOSE CHORD 1 CHORD 2 ARPEGGIO

I-11 #001 : Standard
I-11 #001 : Acoust Piano

■ Arpeggio Play

Arpeggio play allows you to play an arpeggio of the chord being pressed. The arpeggiation pattern can also be set.

Pressing **ARPEGGIO** will turn arpeggio play on/off. When turned on, the button indicator will light. When you play a chord on the keyboard, it will be arpeggiated.

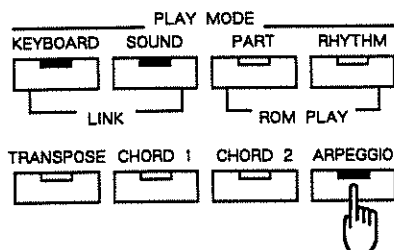

Four types of arpeggio are available. The selected type will determine how the notes of the chord will be played.

Type	Sound
Up	Notes being pressed will sound from low to high.
Down	Notes being pressed will sound from high to low.
Up & Down	Notes being pressed will sound from low to high and back to low.
Random	Notes being pressed will sound at random.

In addition to the arpeggio type, you can also specify the speed (rate) at which the notes will be arpeggiated.

●Arpeggio Type and Rate Settings

Here's how to change the arpeggio type and rate.

Jump to the arpeggio setting display.

①

EDIT DATA

I-11 #001 : Standard
JUMP: Select Switch.

MARK JUMP

②

PLAY MODE

KEYBOARD	SOUND	PART	RHYTHM
LINK	ROM PLAY		
TRANSPOSE	CHORD 1	CHORD 2	ARPEGGIO

Edit/Kybd/Perform/Arpe
Type=~~Up&Down~~ Rate=100

↑ Type
↑ Rate

First select the Type.

③

C2/VALUE

VALUE

Edit/Kybd/Perform/Arpe
Type=~~Up&Down~~ Rate=100

Press CURSOR to make the rate value blink.

④

EXIT ENTER PART

Edit/Kybd/Perform/Arpe
Type=Up&Down Rate=~~100~~

CURSOR VALUE

Set the rate. Higher settings will result in faster arpeggiation.

⑤

C2/VALUE

VALUE

Edit/Kybd/Perform/Arpe
Type=Up&Down Rate=~~100~~

When you finish making settings, return to play mode.

⑥

PLAY MODE

KEYBOARD	SOUND	PART	RHYTHM
LINK	ROM PLAY		
TRANSPOSE	CHORD 1	CHORD 2	ARPEGGIO

I-11 #001 : Standard
I-11 #001 : Acoust Piano

2. Write the Edited Performance Function Settings

The settings we have edited so far (key transpose, chord, arpeggio) can be stored together as a keyboard patch. Here we will explain how to write these edited settings into memory along with a patch name.

* For details of keyboard patches, see section III.

a. Name

Here's how to change the name of a keyboard patch.

Select the patch name display.

①

I-11 #001 : Standard
 Jump: Select Switch.

②

Edit/Kybd/Name
 Patch Name=*****

Move the cursor (underline) to the character you want to change, and select a different character.

③④

Edit/Kybd/Name
 Patch Name=*****

Edit/Kybd/Name
 Patch Name=N*****

:

Edit/Kybd/Name
 Patch Name=New KeyPatch

* The following characters can be used ;

(space) A—Z a—z 0—9 - / + * . , ; = ! " # \$ % & ' () < > { } [] _ ? ♪

* Pressing **NUMBER** [1] will insert a space. Pressing **NUMBER** [2] will delete the character at the cursor, and move the remaining characters forward.

After changing the name, continue to the following write operation.

b. Write

Now let's store all the edited performance function settings we edited. Here we will explain how to write the edited keyboard patch settings into the same patch number.

- * The On/Off setting for each performance function is also memorized. The indicator of each button shows the condition.
- * It is not necessary to write data into memory each time you edit a performance function.
- * To store edited keyboard patch settings into a different patch number, see "Data Mode Operations" (page 128).

Use the following procedure while editing a performance function. Jump to the keyboard patch write display.

Jump to the write display.

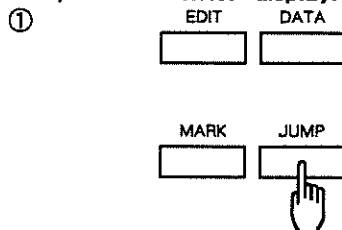

```

Edit/Kybd/Name
JUMP:  Select Switch.
    
```

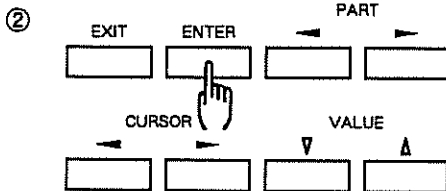

```

Data/Write/Kybd
Write      Temp:I11 →I11
    
```

Press **ENTER** once again.

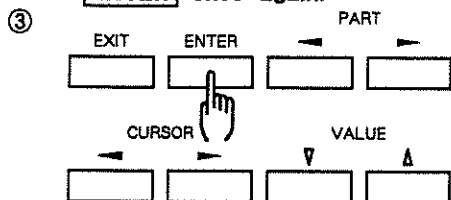

```

Data/Write/Kybd
Sure?  [VALUE▲] / [EXIT]
    
```

2. Write the Edited Performance Function Settings

If you are sure you want to store, press VALUE Δ . (To quit without storing, press EXIT to return to the display of step ②.)

④

EXIT	ENTER	PART		Data/Write/Kybd Function Complete.
<input type="text"/>	<input type="text"/>	<input type="text"/>	<input type="text"/>	
CURSOR		VALUE		↓ and in a short time.
<input type="text"/>	<input type="text"/>	<input type="text"/>	<input type="text"/>	Data/Write/Kybd Write Temp: I11 → I11



This completes the writing operation. Return to play mode.

⑤

PLAY MODE				I-11 #001 : New KeyPatch I-11 #001 : Acoust Piano
KEYBOARD	SOUND	PART	RHYTHM	
<input type="text"/>	<input type="text"/>	<input type="text"/>	<input type="text"/>	
ROM PLAY				
TRANSPOSE	CHORD 1	CHORD 2	ARPEGGIO	
<input type="text"/>	<input type="text"/>	<input type="text"/>	<input type="text"/>	



2 CREATING A CHORD SET

In "Useful the Performance Functions", we explained how to select pre-defined Chord Sets and how to use the Chord Play function. Here we will explain how to create a Chord Set suitable for the song you are playing.

■ Creating A Chord Set

Here's how to create a chord set.

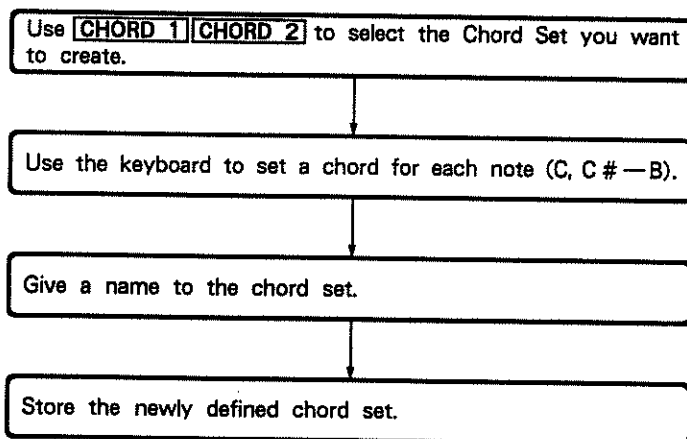

a. Editing a chord set

Select either of the chord sets assigned to the keyboard patch, and edit the chord for each note.

Enter edit mode.

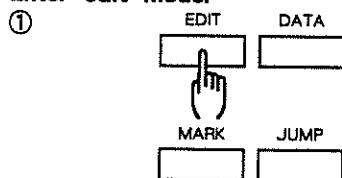

```
Edit          |■■■■■| Kybd  
Chord| Sound| Timbre| Rythm
```

Select "Chord".

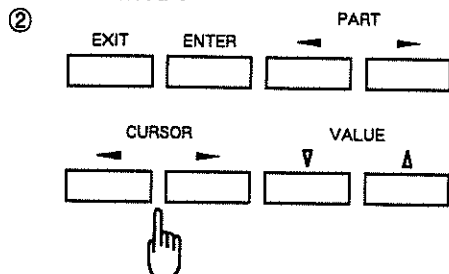

```
Edit          | Setup | Kybd  
■■■■■| Sound| Timbre| Rythm
```

2 CREATING A CHORD SET

③

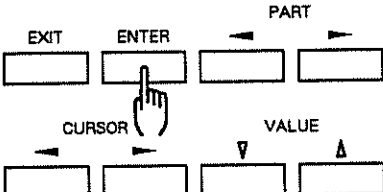

Edit/Chord[2]
 ■■■■| Note

Select the button of the chord set you want to edit (the button indicator will light).

④

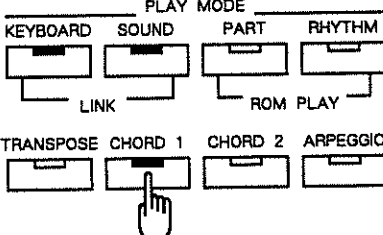

Edit/Chord[1]
 ■■■■| Note

Select "Note".

⑤

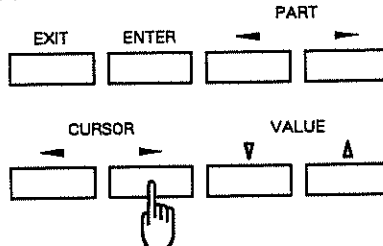

Edit/Chord[1]
 Name|■■■■

⑥

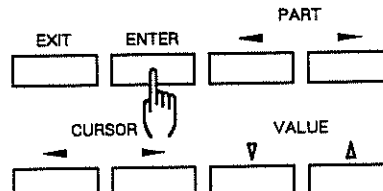

Edit/Chord[1]/Note
 ■ : Note=fff

This is the chord setting display. Select the note (C, C#-B) for which to define a chord.

⑦

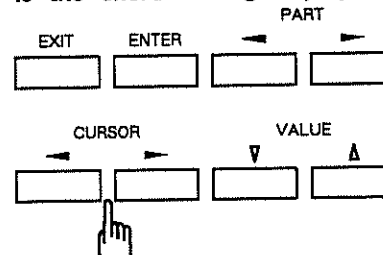

Edit/Chord[1]/Note
 ■ : Note=fff

Play a chord on the keyboard. The chord will be defined when you remove your hand from the keyboard.

⑧ Playing a D major chord.



Edit/Chord[1]/Note
 ■ : Note=fff

If you want to define a chord for another note, repeat steps ⑦-⑧.

When finished, press **EXIT** to return to the display of step ④.

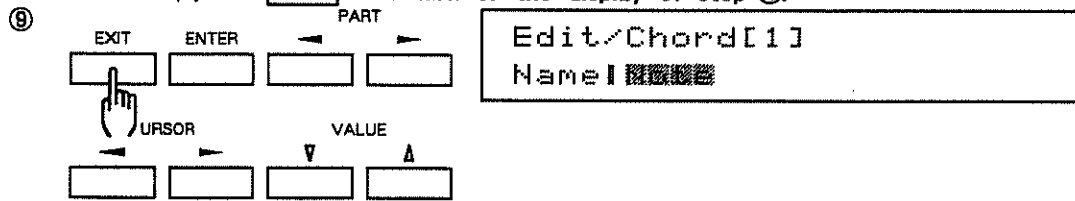

If you want to change the name of the chord set, follow the procedure explained below.

- * The ♯ characters in the display indicate the number of notes in the chord.
- * To re-do the settings of step ③, release all the keys, and play a chord again.
- * In step ③, you may continue to add notes as long as a key is still being pressed.
- * Each chord may contain up to 8 notes.
- * You are free to set any type of chord for each key. For example, a C major chord can be assigned to the D key.
- * You may use the keyboard to specify a chord at any time in the chord setting display.

b. Chord set name

Here's how to change the name of a chord set.

Select "Name".

①

②

Move the cursor (underline) to the character you want to change, and select a different character.

③④

* The following characters can be used ;

(space) A—Z a—z 0—9 - / + * . , ; = ! " # \$ % & ' () < > { } [] _ ? ♪

* Pressing **NUMBER** 1 will insert a space. Pressing **NUMBER** 2 will delete the character at the cursor, and move the remaining characters forward.

After changing the name, continue to the following write operation.

c. Writing a chord set into memory

Now let's store the chord set we edited into its original chord set number.

From the chord set editing display, jump to the write display.

①

EDIT	DATA
<input type="text"/>	<input type="text"/>
MARK	JUMP
<input type="text"/>	<input type="text"/>

Hand icon pointing to the JUMP button.

Edit/Chord[1]/Name
 JUMP: Select Switch.

②

EXIT	ENTER	PART	
<input type="text"/>	<input type="text"/>	<input type="text"/>	<input type="text"/>
CURSOR		VALUE	
<input type="text"/>	<input type="text"/>	<input type="text"/>	<input type="text"/>

Hand icon pointing to the ENTER button.

Data/Write/Chord[1]
 ██████████ Temp: I1 → I1

Press **ENTER** once again. (To cancel the operation, press **EXIT** to return to the step ② display.)

③

EXIT	ENTER	PART	
<input type="text"/>	<input type="text"/>	<input type="text"/>	<input type="text"/>
CURSOR		VALUE	
<input type="text"/>	<input type="text"/>	<input type="text"/>	<input type="text"/>

Hand icon pointing to the ENTER button.

Data/Write/Chord[1]
 Sure? [VALUE▲] / [EXIT]

If you are sure you want to store the chord set into memory, press **VALUE** **▲**.

④

EXIT	ENTER	PART	
<input type="text"/>	<input type="text"/>	<input type="text"/>	<input type="text"/>
CURSOR		VALUE	
<input type="text"/>	<input type="text"/>	<input type="text"/>	<input type="text"/>

Hand icon pointing to the VALUE button.

Data/Write/Chord[1]
 Function Complete.

↓ and in a short time,

Data/Write/Chord[1]
 ██████████ Temp: I1 → I1

This completes the writing operation. Now return to play mode.

⑤

PLAY MODE			
KEYBOARD	SOUND	PART	RHYTHM
<input type="text"/>	<input type="text"/>	<input type="text"/>	<input type="text"/>
ROM PLAY			
TRANSPOSE	CHORD 1	CHORD 2	ARPEGGIO
<input type="text"/>	<input type="text"/>	<input type="text"/>	<input type="text"/>

Hand icon pointing to the SOUND button.

I-11 #001 : Standard
 I-11 #001 : Acoust Piano

■ Adjusting the Display Contrast

At some angles, it may be difficult to read the characters in the U-20's display. In such cases, use the following procedure to adjust the contrast (brightness) of the display.

① Press **EDIT**.

```

Edit          | Setup | Kbd
■■■■■ | Sound | Timbre | Rthm
    
```

② Press **◀** **CURSOR** several times to select **Setup** (blinking).

```

Edit          | ■■■■■ | Kbd
Chord | Sound | Timbre | Rthm
    
```

③ Press **ENTER**.

```

Edit/Setup
■■■■■ | Effect | LCD | MIDI
    
```

④ Use **◀** **CURSOR** **▶** to select **LCD** (blinking).

```

Edit/Setup
M. Tune | Effect | ■■■■ | MIDI
    
```

⑤ Press **ENTER**.

```

Edit/Setup/LCD
LCD Contrast = ■■■
    
```

This allows you to adjust the display contrast.

⑥ Use the **VALUE** slider or **▽** **VALUE** **△** to adjust the contrast (0—15).

```

Edit/Setup/LCD
LCD Contrast = ■■■
    
```

⑦ When you are finished, return to play mode.

* The contrast setting will be remembered even when the power is turned off.

SECTION II

Editing

— Create your own sounds —

In section II you will learn how to modify the U-20's sounds (Sound Patches, Timbres) to create your own original sounds.

I BEFORE YOU CREATE YOUR OWN SOUNDS	46
1. Tones	46
2. About the Multi-timbral Sound Generator	47
3. Sound Creating Procedure	48
II SOUND PATCH SETTINGS	49
1. Editing a Sound Patch	49
a. Settings for each Part (1—6)	50
b. Rhythm part settings	52
c. Effect settings	53
d. Name	56
2. Storing a Sound Patch (Writing Procedure)	57
III EDIT THE TIMBRE SETTINGS	58
1. Timbre Editing	58
a. Tone select	59
b. Level	61
c. Pitch	63
d. Vibrato	65
e. Timbre name	67
2. Storing Timbres (Write Procedure)	68
IV RHYTHM SET SETTINGS	69
1. Settings for Each Key	70
a. Selecting tones	71
b. Level	72
c. Pitch	74
d. Output	76
2. Other Settings	77
3. Storing a Rhythm Set (Writing Procedure)	79

1 BEFORE YOU CREATE YOUR OWN SOUNDS

Before you begin creating your own sounds, read this section to learn how the sound generator in the U-20 creates sounds.

1. Tones

Here we will explain the features of the U-20's RS-PCM sound generator.

●RS-PCM Sound Generators

RS-PCM stands for ReSynthesized Pulse Code Modulation. PCM is a method of storing a sound waveform as a digital sound recording. However, simply recording and playing back the sound of an instrument does not always give musically appropriate results.

RS-PCM uses Roland's unique technology to analyze, modify, and "resynthesize" the PCM recorded instrumental sound. This results in a realistic sound that can be controlled in musically appropriate ways.

The basic sound of the RS-PCM sound generator is the "Tone". Internal memory contains 128 Tones. PCM cards (sound library cards (SN-U110 series) for the U-110) can also be used, providing even more sounds.

The U-20 does not simply use the Tones as they are, but allows you to modify the way in which volume and pitch change, or how vibrato is applied. This lets you easily create your own sounds.

●Types of Tone and Simultaneous Polyphony

The U-20 can produce up to 30 sounds (voices) at once, but this will depend on the type of Tones being used. Tones which consist of a single voice can play up to 30 notes. Tones which consist of two voices can play up to 15 notes. (☐ Refer to page 59, "Tone select".)

●Pitch Range

Tones have an upper limit beyond which they cannot produce sound.

Each acoustic instrument has a different sound-producing range, and the sound-producing ranges of the U-20's sounds are based on these ranges.

2. About the Multi-timbral Sound Generator

Here we will give a simple explanation of the multi-timbral sound generator.

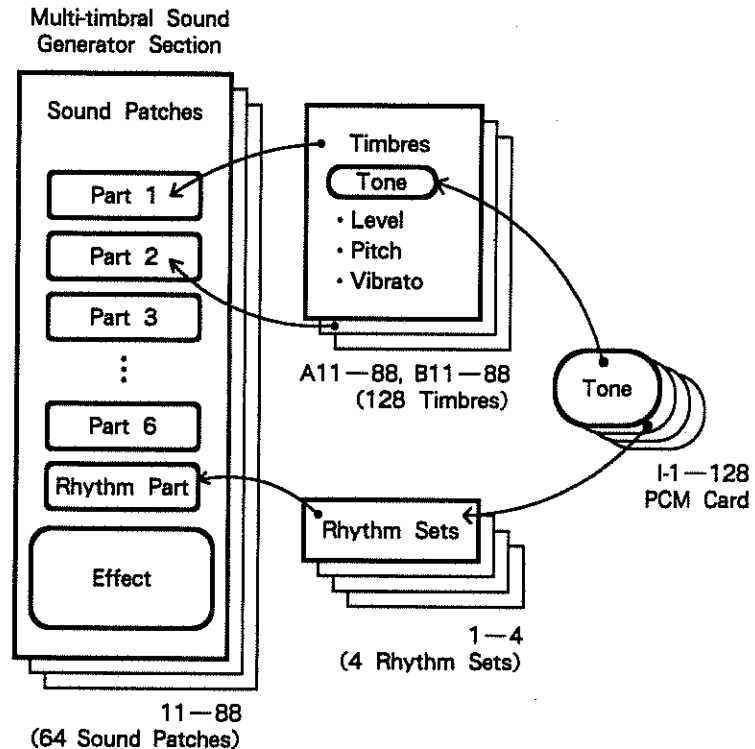

● Timbres

Timbres are the basic unit of sound which you will play. 128 different Timbres can be created. Each Timbre has settings which determine the level, pitch and vibrato of the tone and parameters which determine how the tone will be affected by velocity, aftertouch, and the bender lever.

● Rhythm Set

A different tone can be assigned to each key to create a drum/percussion set. 4 sets can be stored in the U-20's internal memory.

● Parts

One part corresponds to a single conventional sound generator module. The U-20 has 6 parts and a rhythm part.

Timbres are assigned to parts 1-6, and a rhythm set is assigned to the rhythm part. Volume and pan can be adjusted and an effect can be selected for each part.

● Sound Patches

A Sound Patch is a collection of part settings and effect settings; i.e., the Sound Patch determines the instrumental ensemble. 64 Sound Patches can be stored in the U-20's internal memory.

3. Sound Creating Procedure

Here we will explain how to create your own Sound Patches, Timbres, and Rhythm Sets.

■ Creating a Sound Patch

A Sound Patch consists of 6 Parts and a Rhythm Part, but playing the keyboard will not necessarily sound all of the Parts. Settings of the Keyboard Patch and Sound Patch will determine which Parts are played by the keyboard.

The factory settings include Sound Patches for which the keyboard will play only Part 1, and also Sound Patches which use two or more Parts (Timbres) to create a sound. A musically appropriate effect such as reverb or chorus is assigned to each Sound Patch.

In this way, a Sound Patch consists of settings which determine the overall sound; the Timbre used by each Part, and the effect applied to the sound.

By specifying a Keyboard Patch performance function appropriate for the corresponding Sound Patch, Link Play mode can be used even more effectively.

* To create sounds using two or more Parts, refer to section III.

■ Creating a Timbre

A Timbre determines how sound is produced. Internal memory contains 128 Timbres. If you want to change certain aspects of the sound, such as deepening the vibrato or making a faster attack, you must "edit" the Timbre. Editing a U-20 Timbre is much simpler than editing a synthesizer sound, and creating your own sounds is quick and easy.

Sounds can be created using Tones from a PCM card (optional) in addition to internal Tones, for even greater possibilities.

■ Creating a Rhythm Set

The U-20 lets you create and store 4 Rhythm Sets.

As you learned when you played the keyboard in Rhythm Play mode, each Rhythm Set consists of a rhythm sound assigned to each of the keys. Rhythm Set settings allow you to change the sound assigned to each key, and adjust its pan or level to an appropriate balance. As with Timbres, you can also create the sound that will be used. Make these settings when using the U-20 to play rhythms under the control of an external rhythm machine or sequencer.

* A separately sold RAM card (M-256E) can be used to increase the number of available Patches and Timbres. To use a RAM card, see "Using a RAM Card" (☞ page 128.).

2 SOUND PATCH SETTINGS

Here we will edit the settings of a Sound Patch, and determine how the effect and various Parts will be used.

1. Editing a Sound Patch

Here we will explain how to set the basic parameters of a Sound Patch.

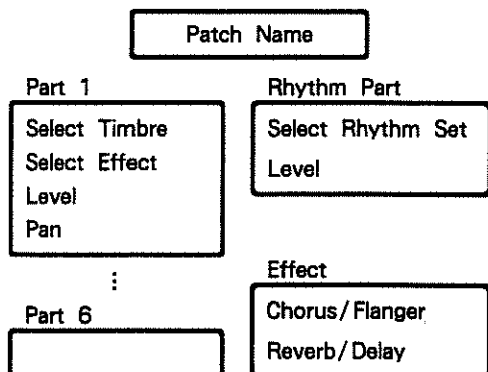

For each Part 1—6, you can select a different Timbre and make settings for volume, pan, etc. For the Rhythm Part, you can specify which rhythm set is to be used. In addition, you can store effect settings (chorus, reverb) as part of a Sound Patch.

■ Basic Editing Procedure

While in Sound Patch mode or Link Play mode, select the Sound Patch you want to edit, and use the following procedure.

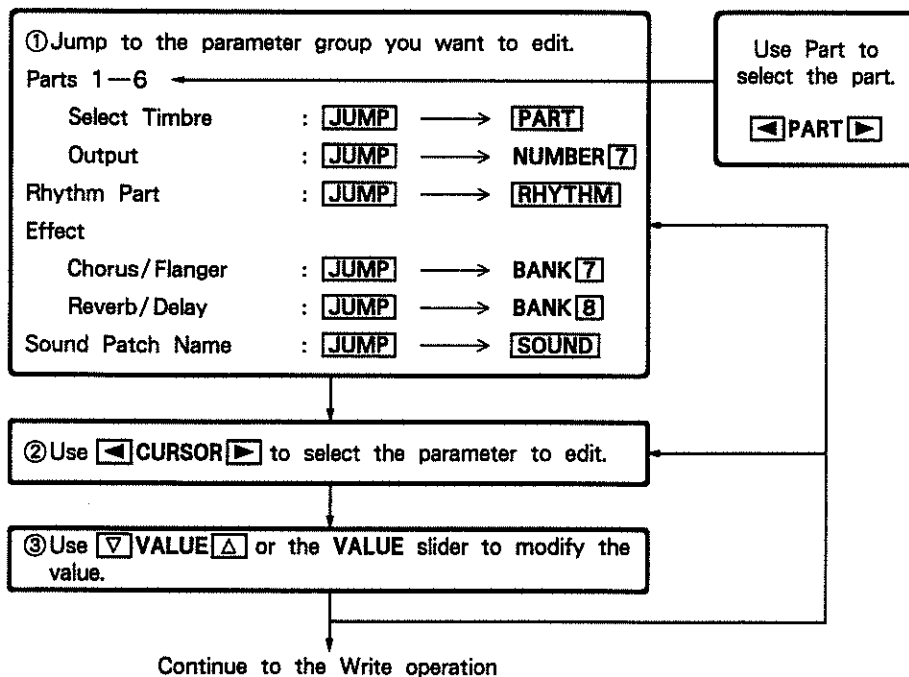

- * Timbres for Parts 1—6 can also be selected in Part Play mode.
- * The rhythm set for the Rhythm Part can also be selected in Rhythm Play mode.
- * The jumps using the BANK and NUMBER buttons explained here apply to the factory settings.
- * Edited settings are temporary. To store your edits, write them into a Sound Patch memory (→page 57).

a. Settings for each Part (1—6)

For each Part, you can specify the Timbres to be used when the Sound Patch is selected, the effect to be used, and settings for pan and level.

■ **Timbre (A11—B88)** This specifies the timbre which will be used for each Part when the Sound Patch is selected.

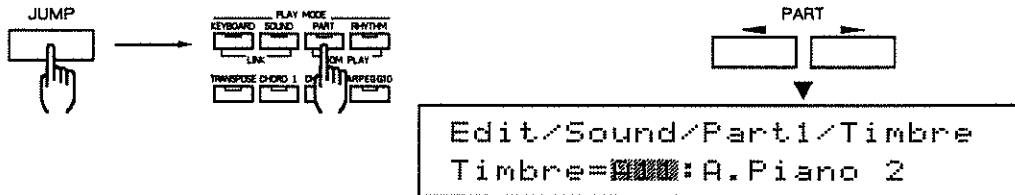

* Timbres can also be selected using **INT/A**, **CARD/B**, **BANK 1—8**, and **NUMBER 1—8**.

■ Output

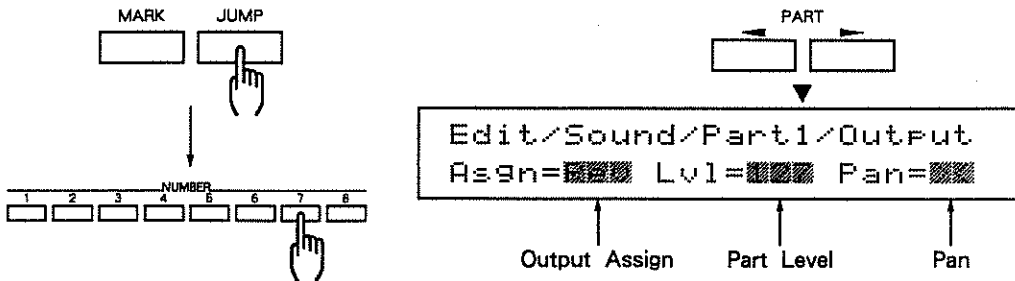

● Output Assign (Dry, Rev, Cho, Dir)

Edit/Sound/Part1/Output
Asgn= Lvl=127 Pan=><

This specifies the effect (chorus, reverb) to be used by each Part. As specified by the effect chorus out mode (☐ page 53), effects can be connected in two ways, PreRev and PostRev. (The factory setting is PreRev.)

Output Mode	Effect	Output Jacks
Dry	No effect is used	MIX OUT
Rev	Only Reverb	
Cho	Pre Rev : Chorus and Reverb Post Rev : Only Chorus	
Dir	No effect is used	DIRECT OUT

* If the DIRECT OUT jacks are not being used, the signal from the DIRECT OUT jacks will be sent from the MIX OUT jacks.

●Part Level (0—127)

```
Edit/Sound/Part1/Output
As9n=Rev Lvl=███ Pan=><
```

This determines the volume of each Part, allowing you to adjust the volume balance between Parts.

●Pan (7 >—><—< 7, Rnd)

```
Edit/Sound/Part1/Output
As9n=Rev Lvl=127 Pan=███
```

This determines the pan position (stereo location) of each Part. When Rnd is selected, the sound will be moved to a random location each time it is played.

```
Left      Center      Right
7> ..... >< ..... <7
```

■Chorus and Reverb Effect Switch

In addition to the output assign specified for each Sound Patch, you may specify a whether the chorus or reverb effect is to be On or Off for all Sound Patches. (This setting is shared by all Sound Patches.)

```

                Select Setup      Select Effect
[EDIT] → [◀CURSOR] → [ENTER] → [▶CURSOR] → [ENTER]
Edit/Setup/Effect
Chorus=███ Reverb=███
```

*The chorus/reverb effect switch setting is preserved even when a Patch is changed or the power is turned off.

b. Rhythm part settings

For the Rhythm Part, you can specify the rhythm set and the overall volume of the Rhythm Part. To modify the pan, output assign, sound, and volume settings of each rhythm sound, edit the Rhythm Set (☞ "Rhythm Set Settings", page 69).

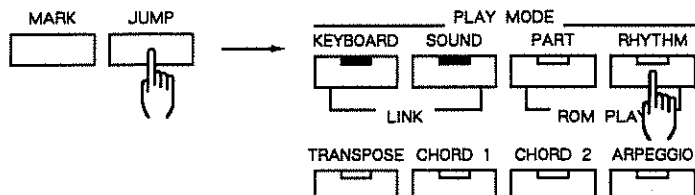

Button	Parameter	Display
CURSOR CURSOR 	Rhythm Set	Edit/Sound/R.Part Rhythm=#█:Standard Set▶
	:	:
	Rhythm Part Level Level Boost Switch	Edit/Sound/R.Part ◀ Level=#█ Boost=#█▶

● Select Rhythm Set (1—4)

Edit/Sound/R.Part
 Rhythm=#█:Standard Set▶

Select one of the four rhythm sets.

● Rhythm Part Level (0—127)

Edit/Sound/R.Part
 ◀ Level=#█ Boost=Off ▶

This determines the overall volume of the Rhythm Part.

● Level Boost Switch (Off, On)

Edit/Sound/R.Part
 ◀ Level=127 Boost=#█▶

When set to On, the value will be greater than the specified value.

c. Effect settings

Make settings for the chorus and reverb effects.

■ Chorus/Flanger

Chorus adds spaciousness and warmth to the sound. These settings determine how chorus and reverb are connected, and how the Chorus/Flanger effect is applied.

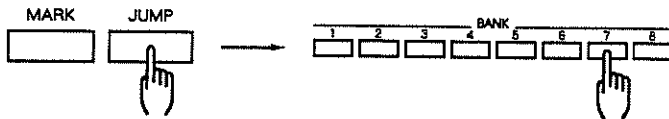

Button	Parameter	Display
CURSOR ← [] ↑	Chorus/Flanger Type	Edit/Sound/Effect/Chorus Type= [] ▶
↕	Output Mode Chorus/Flanger Level	Edit/Sound/Effect/Chorus ◀ Out= [] Level= [] ▶
↓	Delay Time Chorus/Flanger Rate	Edit/Sound/Effect/Chorus ◀ Delay Time= [] Rate= [] ▶
CURSOR [] ▶	Chorus/Flanger Depth Feedback	Edit/Sound/Effect/Chorus ◀ Depth= [] Feedback= [] ▶

● Chorus/Flanger type (Chorus1, 2, FB-Chorus, Flanger, Short Delay)

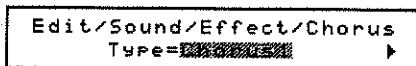

This selects the effects such as chorus, flanger, and short delay.

Chorus 1	Rich spacious effect.
Chorus 2	Deep ensemble effect, especially effective for layered strings.
FB-Chorus	An effect midway between chorus and flanger.
Flanger	An effect of strongly emphasized shifting overtones, especially effective on sounds with a strong overtone structure such as HEAVY.EG.
Short Delay	A delay repeated in a short time.

● Output Mode (Pre Rev, Post Rev)

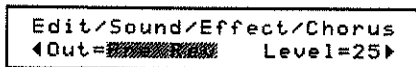

This determines how chorus and reverb are connected. The output assign setting for each Part (☞ page 50) will determine which effect is used.

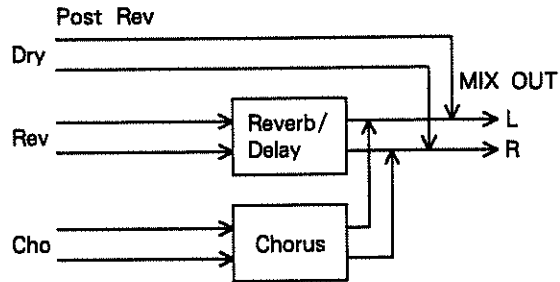
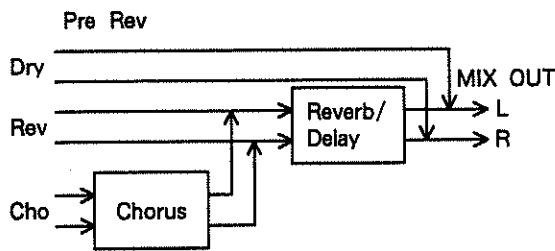

●Chorus/Flanger Level (0—31)

Edit/Sound/Effect/Chorus
 ◀Out=Pre Rev Level=██▶

This determines the volume of the effect, allowing you to adjust the balance of the processed and unprocessed sound.

●Delay Time (0—31)

Edit/Sound/Effect/Chorus
 ◀Delay Time=██ Rate=25▶

This adjusts the delay time used by the chorus/flanger.

For Chorus 1, 2 and FB-Chorus, higher settings will result in a more spacious effect.

For Flanger, lower settings will result in a stronger flanging effect, and higher settings will result in a more chorus-like effect.

For Short Delay, this adjusts the time delay between repeats.

●Chorus/Flanger Rate (0—31)

Edit/Sound/Effect/Chorus
 ◀Delay Time=12 Rate=██▶

This adjusts the cycle time of the chorus/flanger. It has no effect when Short Delay is selected.

↑ 31 Fastest cycle
 ↓ 0 Modulation becomes slower

●Chorus/Flanger Depth (0—31)

Edit/Sound/Effect/Chorus
 ◀ Depth=██ Feedback=±0

This adjusts the depth of the chorus or flanger effect. It has no effect when Short Delay is selected.

●Feedback (- 31 — + 31)

Edit/Sound/Effect/Chorus
 ◀ Depth=0 Feedback=██

This adjusts the amount of feedback for the flanger or delay. The phase will be reversed depending on the “+” or “-” setting, which will also change the resulting sound. For Flanger and FB-Chorus, this will modify the tonal quality of the sound. For Short Delay, this will determine the number of repeats. For Chorus 1, 2, this setting has no effect.

■ Reverb/Delay

Reverb or delay adds acoustic reflections that give depth and spaciousness to the sound.

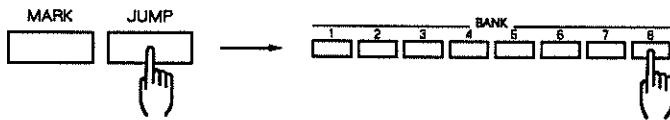

Button	Parameter	Display
CURSOR ─ <input type="text"/> ↑ ↓ CURSOR ─ <input type="text"/>	Reverb/Delay Type Reverb/Delay Time	Edit/Sound/Effect/Reverb Type=██████████ Time=██ ▶
CURSOR ─ <input type="text"/>	Reverb/Delay Level Feedback (Delay only)	Edit/Sound/Effect/Reverb ◀Level=██ Delay FB=██

● Reverb/Delay Type (Room 1—3, Hall 1, 2, Gate, Delay, Cross Delay)

Select the type of reverb or delay.

Room 1—3	Sharply-defined reverb with a broad spread
Hall 1, 2	Smooth reverb, with greater depth than Room
Gate	A sharply muted reverb: i.e., "gated" to produce an artificially fast decay
Delay	Standard delay effect
Cross Delay	Delay repeats pan to left and right

● Reverb/Delay Time (0—31)

This determines the length of the reverberant sound. When Delay or Cross Delay is selected, this determines the delay time.

● Reverb/Delay Level (0—31)

This determines the volume of the reverb (delay).

● Feedback (0—31)

This determines the number of times the delay is repeated. It is meaningful only when Delay or Cross Delay is selected.

d. Name

You can give a 12-character name to each Sound Patch.

Get the Sound Patch name display.

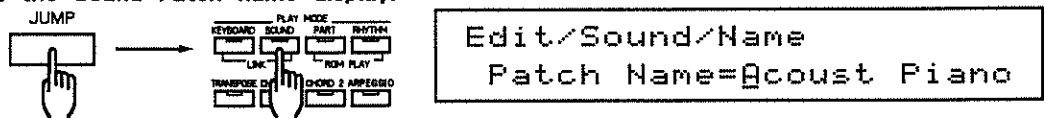

Move the cursor (underline) to the character you want to change, and select a new character.

* The following characters can be used ;

(space) A—Z a—z 0—9 - / + * . , ; = ! " # \$ % & ' () < > { } [] _ ? ♪

* Pressing **NUMBER 1** will insert a space. Pressing **NUMBER 2** will delete the character at the cursor, and move the remaining characters forward.

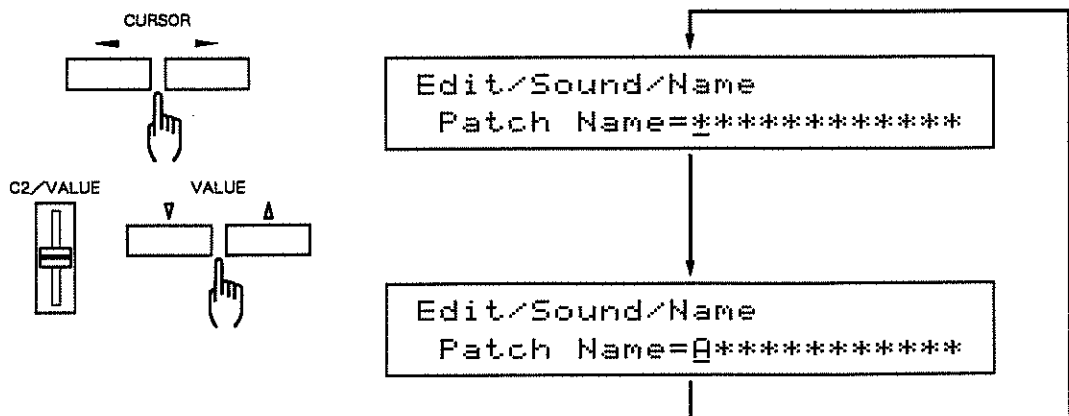

2. Storing a Sound Patch (Writing Procedure)

The various Sound Patch settings you edit are stored together as a Sound Patch. Here we will explain how to write the edited Sound Patch settings into the Sound Patch memory they originally occupied.

* To write a Sound Patch into a different Sound Patch memory, refer to "Writing a Patch" (page 133).

From the Sound Patch editing display, jump to the Sound Patch write display.



* The display will show the numbers of the edited Sound Patch and the writing destination Sound Patch.

Press **ENTER** once again.

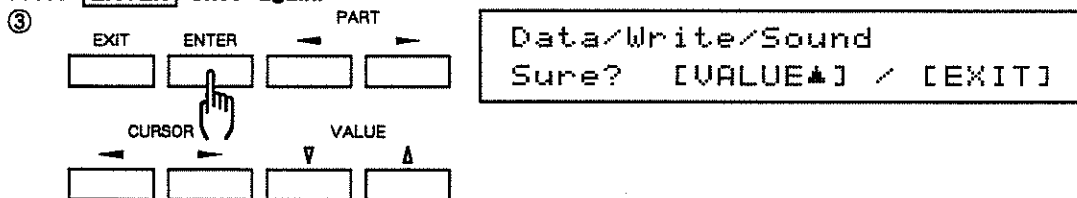

If you are sure you want to write the data into the Sound Patch memory, press **VALUE** Δ . (To cancel the operation, press **EXIT** to return to the display of step ②.)

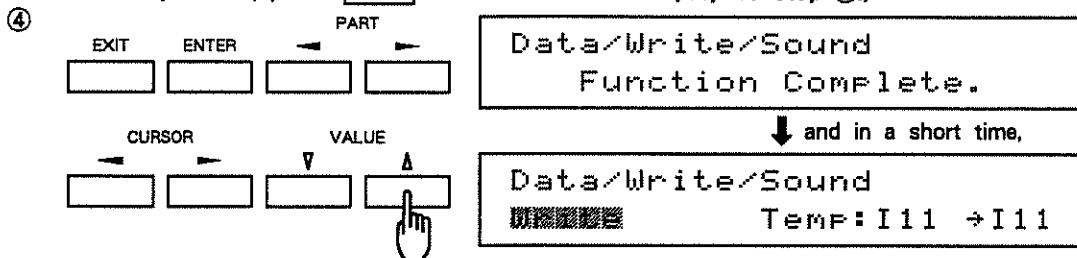

This completes the writing operation. Return to play mode.

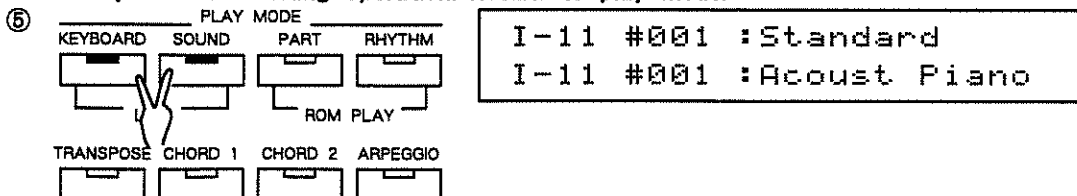

3 EDIT THE TIMBRE SETTINGS

Here we will edit Timbre settings to create a new sound.

1. Timbre Editing

Here we will explain how the Timbre parameters function, and the editing procedure.

Tone Select

Timbre Name

Level	Pitch	Vibrato
Timbre Level Velocity Sensitivity Channel Aftertouch Sensitivity Envelope (Attack Rate Decay Rate Sustain Level Release Rate)	Pitch Shift (Coarse Fine) Bender Range (Bend Down Bend Up) Channel Aftertouch Sensitivity Polyphonic Aftertouch Sensitivity Auto Bend Depth Auto Bend Rate Detune Depth	Rate Waveform Depth Delay Time Rise Time Modulation Lever Depth Channel Aftertouch Sensitivity Polyphonic Aftertouch Sensitivity

* Polyphonic aftertouch refers to aftertouch which can be controlled independently by each key. Make these settings when controlling the U-20 from a MIDI device which is able to transmit polyphonic aftertouch data. The U-20 is not able to transmit polyphonic aftertouch data.

■ Basic Editing Procedure

Since you will want to listen to the Timbre while editing it, first enter Part Play mode and select the Timbre to be edited. You can select a Timbre for any Part, but in this example select Part 1.

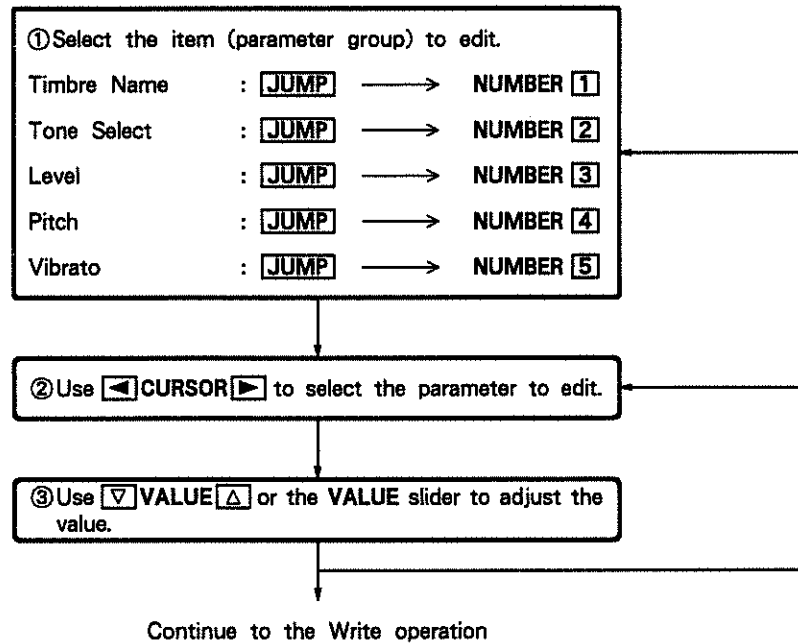

- * This chart shows the factory-set jump destinations.
- * Edited settings are temporary. If you want to keep your edits, you must write them into memory (☞ page 68).

a. Tone select

Select the basic Tone for the Timbre. You can select from the 128 internal Tones, or from Tones in a separately sold PCM card.

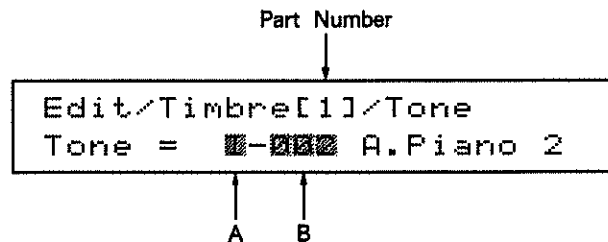
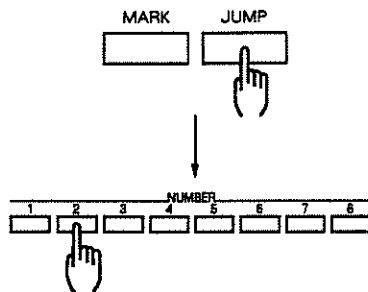

- A: When using internal Tones, select I. When using Tones from a PCM card (optional), select the card number.
- B: Specify the number of the Tone (1—128) you want to use.

Tones can be divided into the following types. Refer to the Tone Chart to see the type of each Tone.

Tone Type	Number of Voices	
Single	1	A Tone consisting of a single sound
Velocity Switch	1	A Tone which switches between two sounds according to on the key velocity
Dual	2	A Tone consisting of two different sounds
Detune	2	A Tone consisting of two sounds of different pitch
Velocity mix	2	A Tone which mixes two sounds according to the key velocity

■ Using a Separately Sold PCM Card (SN-U110 Series)

Each card is numbered by type, 01, 02, ... Check the number of the card, and insert it firmly into the rear panel PCM CARD slot. You may insert a card into either the right or left slot. Up to two types of card can be used at once.

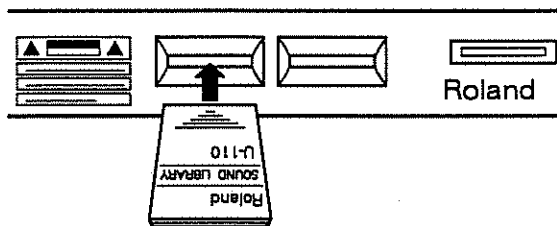

Use Tone Select to select the number of the inserted card, and the number of the Tone you want to use. Each card will have a different number of Tones.

When a PCM card is inserted or removed, operation will briefly stop while the following display appears. This is not a malfunction, and operation will resume in a short time.

```
Checking PCM Card...
```

While playing, the PCM card being used should be left inserted.

If you have selected a card Tone but have not inserted the specified card, the following display will appear, and there will be no sound.

```
Edit/Timbre[1]/Tone
Tone = 01-003 No Card!
```

b. Level

These settings determine the volume of the Timbre, and how the volume is controlled.

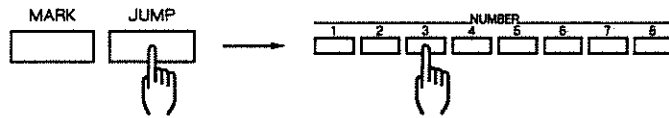

Button	Parameter	Display
CURSOR CURSOR 	Timbre Level Velocity Sensitivity	Edit/Timbre[1]/Level Level=███ Velo Sens=███ ▶
	Channel Aftertouch Sensitivity	Edit/Timbre[1]/Level ◀ Ch After Sens=███ ▶
	Env Attack Rate Env Decay Rate Env Sustain Level Env Release Rate	Edit/Timbre[1]/Level ◀ Env A=███ D=███ S=███ R=███

● Timbre Level (0—127)

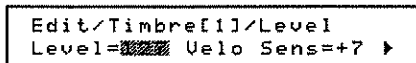

This adjusts the volume of the Timbre.

● Velocity Sensitivity (-7—+7)

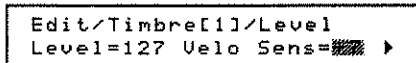

This determines how velocity will affect volume.

- ↑ +7 Strongly played notes will be louder
- ±0 Velocity will not affect volume
- ↓ -7 Strongly played notes will be softer

Volume change when Level = 100

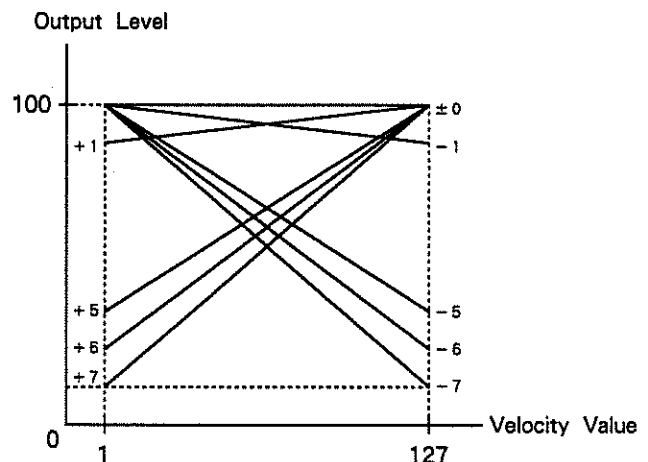

● Channel Aftertouch Sensitivity (-7-+7)

```
Edit/Timbre[1]/Level
< Ch After Sens=0000 >
```

This determines how channel aftertouch will affect volume.

- ↑ +7 Stronger aftertouch will increase the volume
- ± 0 Aftertouch will not affect volume
- ↓ -7 Stronger aftertouch will decrease the volume

● Envelope (Env)

```
Edit/Timbre[1]/Level
< Env A=000 D=000 S=000 R=000 >
```

Attack Rate Decay Rate Sustain Level Release Rate

Each parameter determines how the volume will change over time.

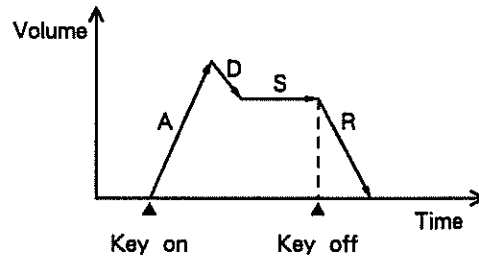

- A : Attack Rate (-7-+7) the rate at which the sound begins
- D : Decay Rate (-7-+7) the rate at which the sustain level is reached
- S : Sustain Level (-7-+7) the volume level at which the sound is sustained
- R : Release Rate (-7-+7) the rate at which the volume disappears

Attack Rate, Decay Rate, Release Rate

- ↑ +7 Changes more rapidly
- ↓ -7 Changes more slowly

Sustain Level

- ↑ +7 Increased volume
- ↓ -7 Decreased volume

* These envelope settings have a relative effect on the envelope settings of the Tone itself ; i.e., they "modify" the standard settings of the envelope generator. Unlike the envelopes found on synthesizers, they are not "absolute" settings. Depending on the selected Tone, identical settings of these values may have different results.

c. Pitch

These settings determine the basic pitch, and how the pitch is controlled.

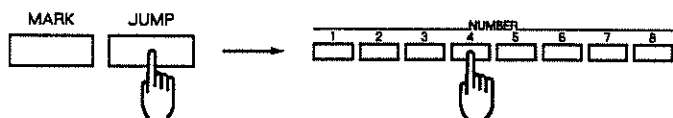

Button	Parameter	Display
CURSOR CURSOR 	Pitch Shift Coarse Pitch Shift Fine	Edit/Timbre[1]/Pitch Coarse= Fine= ▶
	Bender Range (Bend Down) Bender Range (Bend Up)	Edit/Timbre[1]/Pitch ◀ Bender Range= ▶
	Channel Aftertouch Sensitivity	Edit/Timbre[1]/Pitch ◀ Ch After Sens= ▶
	Polyphonic Aftertouch Sensitivity	Edit/Timbre[1]/Pitch ◀ Poly After Sens= ▶
	Auto Bend Depth	Edit/Timbre[1]/Pitch ◀ Auto Bend Depth= ▶
	Auto Bend Rate	Edit/Timbre[1]/Pitch ◀ Auto Bend Rate= ▶
	Detune Depth	Edit/Timbre[1]/Pitch ◀ Detune Depth= ▶

● Pitch Shift

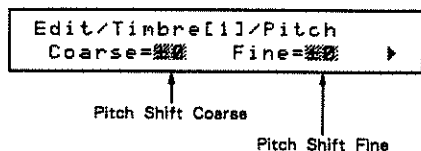

This shifts the basic pitch of the Tone.

Pitch shift coarse (-24—+24):

semitone steps (±2 octaves)

Pitch shift fine (-50—+50):

units of 1 cent (±50 cents)

● Bender Range

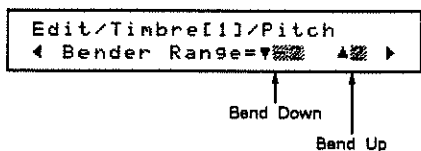

This determines the range of the change in pitch when the bender lever is moved left (bend down) or right (bend up).

Bend down (-36, -24, -12—0):

-3, -2 octaves, semitone steps (-1—0 octaves)

Bend up (0—12): semitone steps (0—1 octave)

● Channel Aftertouch Sensitivity (-36, -24, -12—+12)

Edit/Timbre[1]/Pitch
 ◀ Ch After Sens= [value] ▶

This determines how channel aftertouch will affect the pitch.

In units of -3, -2 octave, semitone steps (-1—+1 octave).

- ↑ +12 Stronger aftertouch will raise the pitch
- ±0 Aftertouch will not affect pitch
- ↓ -36 Stronger aftertouch will lower the pitch

● Polyphonic Aftertouch Sensitivity (-36, -24, -12—+12)

Edit/Timbre[1]/Pitch
 ◀ Poly After Sens= [value] ▶

This determined how polyphonic aftertouch will affect the pitch.

In units of -3, -2 octave, semitone steps (-1—+1 octave).

* Polyphonic aftertouch can be received, but cannot be transmitted by the U-20.

● Auto Bend

Auto Bend Depth

Edit/Timbre[1]/Pitch
 ◀ Auto Bend Depth= [value] ▶

Auto bend is an effect which causes an automatic pitch-bend each time a note is played.

Auto Bend Rate

Edit/Timbre[1]/Pitch
 ◀ Auto Bend Rate= [value] ▶

Depth (-36, -24, -12—+12): Amount of pitch change
 -3, -2 octave, semitone steps (-1—+1 octaves)

Rate (0—15): Rate of pitch change

- ↑ 15 Rapid change in pitch
- ↓ 0 Slow change in pitch

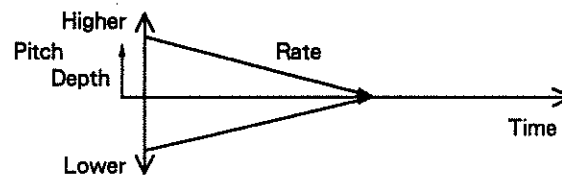

● Detune Depth (0—15)

Edit/Timbre[1]/Pitch
 ◀ Detune Depth= [value] ▶

This determines how detune-type Tones are detuned. This parameter is meaningful only when a detune-type Tone is selected.

d. Vibrato

These settings determine how vibrato (repetitive change in pitch) is applied and controlled.

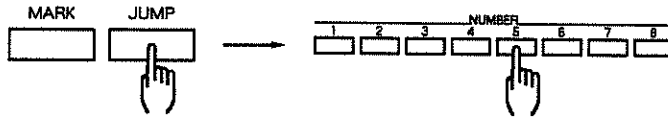

Button	Parameter	Display
CURSOR ← []	Rate Waveform	Edit/Timbre[1]/Vibrato Rate=[] Waveform=[] ▶
↑	Depth Delay Time	Edit/Timbre[1]/Vibrato ◀Depth=[] Delay Time=[] ▶
↑	Rise Time	Edit/Timbre[1]/Vibrato ◀ Rise Time=[] ▶
↑	Modulation Lever Depth	Edit/Timbre[1]/Vibrato ◀ Modulation Depth=[] ▶
↑	Channel Aftertouch Sensitivity	Edit/Timbre[1]/Vibrato ◀ Ch After Sens=[] ▶
↓	Polyphonic Aftertouch Sensitivity	Edit/Timbre[1]/Vibrato ◀ Poly After Sens=[] ▶
CURSOR [] →		

●Rate (0—63)

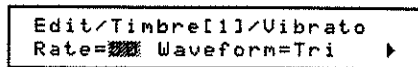

This determines the speed of the vibrato.

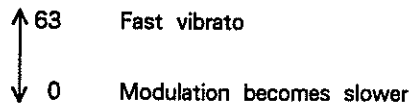

●Waveform (Tri, Sine, Square, SawUp, SawDwn, Trill 1, 2, Randm 1—4)

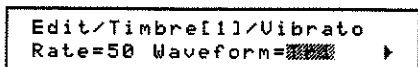

This selects the waveform of the vibrato LFO.

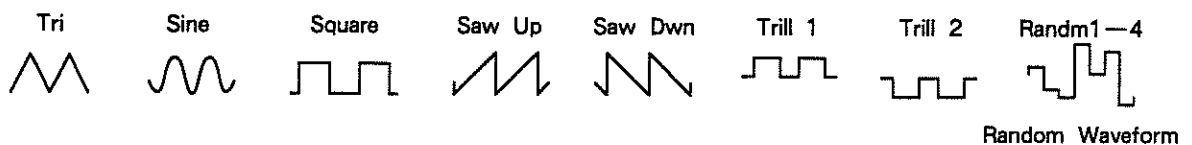

●Depth (0—15)

```
Edit/Timbre[1]/Vibrato  
◀Depth=0 Delay Time=0 ▶
```

This determines the depth of the vibrato.

●Delay Time (0—15)

```
Edit/Timbre[1]/Vibrato  
◀Depth=0 Delay Time=0 ▶
```

This determines the time delay from when the sound is played to when the vibrato begins.

●Rise Time (0—15)

```
Edit/Timbre[1]/Vibrato  
◀ Rise Time=0 ▶
```

This determines the time from when the vibrato begins to when the vibrato depth reaches the specified value.

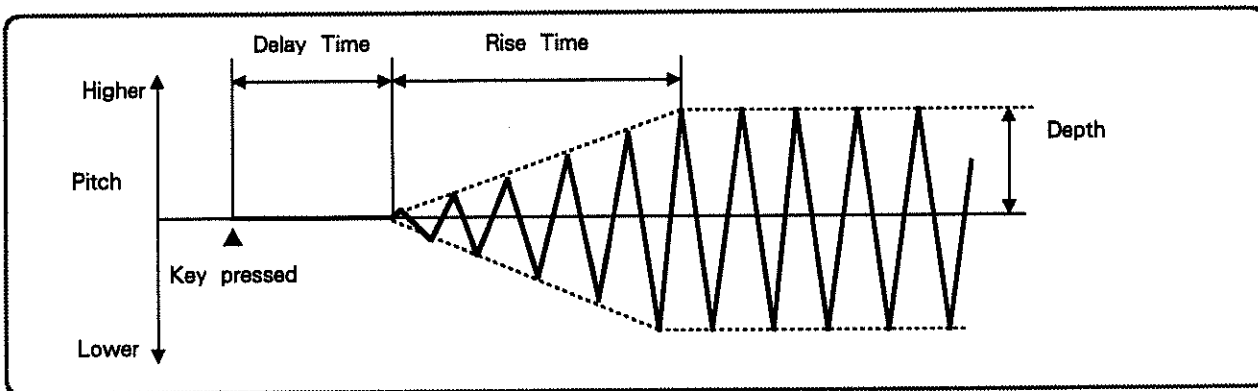

●Modulation Lever Depth (0—15)

```
Edit/Timbre[1]/Vibrato  
◀ Modulation Depth=0 ▶
```

This determines how greatly the bender/modulation lever will affect the vibrato depth.

●Channel Aftertouch Sensitivity (0—15)

```
Edit/Timbre[1]/Vibrato  
◀ Ch After Sens=0 ▶
```

This determines how channel aftertouch will control the amount of vibrato.

●Polyphonic Aftertouch Sensitivity (0—15)

```
Edit/Timbre[1]/Vibrato  
◀ Poly After Sens=0 ▶
```

This determines how polyphonic aftertouch will control the amount of vibrato.

* Polyphonic aftertouch can be received, but cannot be transmitted by the U-20.

e. Timbre name

You can give each Timbre a 12-character name.

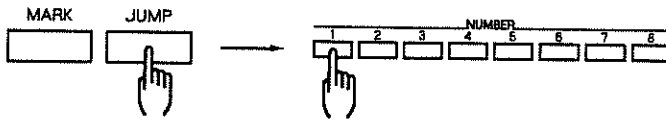

Move the cursor (underline) to the character you want to change, and select a character.

* The following characters can be used ;

(space) A—Z a—z 0—9 - / + * . , ; = ! " # \$ % & ' () < > { } [] _ ? ♪

* Pressing **NUMBER** 1 will insert a space. Pressing **NUMBER** 2 will delete the character at the cursor, and move the remaining characters forward.

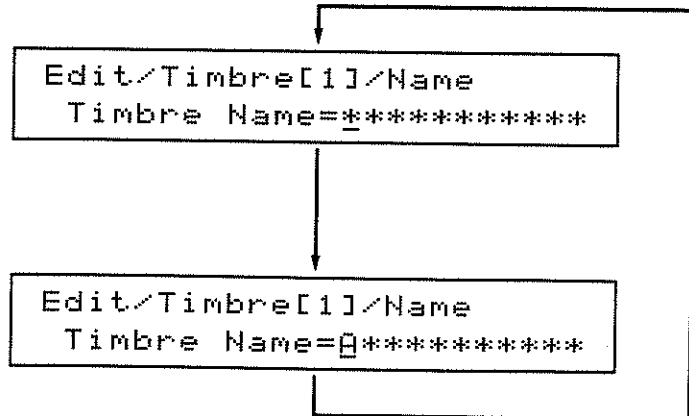
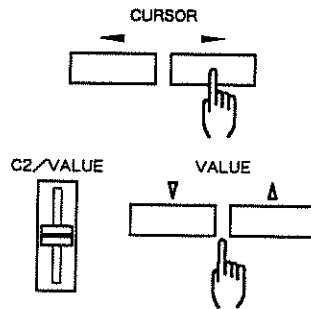

2. Storing Timbres (Write Procedure)

The various Timbre settings you edit are stored together as a Timbre. Here we will explain how to write the edited Timbre settings into the Timbre memory they originally occupied.

* To write a Timbre into a different Timbre memory, refer to "Writing a Timbre" (page 136).

From the Timbre editing display, jump to the Timbre write display.

①②

Diagram showing the transition from the Timbre editing display to the Timbre write display. A hand presses the JUMP button, which leads to the ENTER button. The resulting display shows "Data/Write/Timbre[1]" and "Temp: IA11→IA11".

* The display will show the numbers of the edited Timbre and the writing destination Timbre.

Press **ENTER** once again.

③

Diagram showing the Timbre write display with a confirmation prompt. A hand presses the ENTER button. The display shows "Data/Write/Timbre[1]" and "Sure? [VALUE▲] / [EXIT]". Below the buttons, a hand is shown pressing the VALUE button.

If you are sure you want to write the data into the Timbre memory, press **VALUE** . (To cancel the operation, press **EXIT** to return to the step ② display.)

④

Diagram showing the completion of the writing operation. A hand presses the VALUE button. The display shows "Data/Write/Timbre[1]" and "Function Complete.". Below this, a hand is shown pressing the VALUE button again. The final display shows "Data/Write/Timbre[1]" and "Temp: IA11→IA11".

This completes the writing operation. Return to play mode.

4 RHYTHM SET SETTINGS

The U-20's Rhythm Part can use one of the four Rhythm Sets you create. Here we will explain how to create a Rhythm Set.

In a Rhythm Set, you can assign any desired Tone to each key. Usually you will use the drum Tone (I-128) of the internal memory, but you are free to use any other internal Tones, or Tones from a PCM card (optional). You can also edit the sound for each key, in the same way as for Timbres.

Rhythm Set Name	Bender Range (Bend Up Bend Down)
-----------------	-------------------------------------

Instrument (B1—D7)

Tone Tone Select ★ Source key Mute	Level Level ★ Velocity sensitivity ★ Envelope mode Envelope (A.D.R) ★	Pitch Pitch Shift (Pitch Coarse ★ Pitch Fine ★) Channel Aftertouch Sensitivity ★ Polyphonic Aftertouch Sensitivity ★ Pitch Randomize Auto Bend Depth ★ Auto Bend Rate ★ Detune Depth ★	Output Output Assign ★ Pan ★
--	--	---	---

★ : Functions in the same way as with Timbre parameters.

☆ : Functions in the same way as for Part 1—6 parameters.

1. Settings for Each Key

Here's how to edit the sound for each key B1—D7.

Basic Editing Procedure

Before you begin editing, select Rhythm Play mode and use the following procedure so that you will be able to hear the sound of each key while you edit.

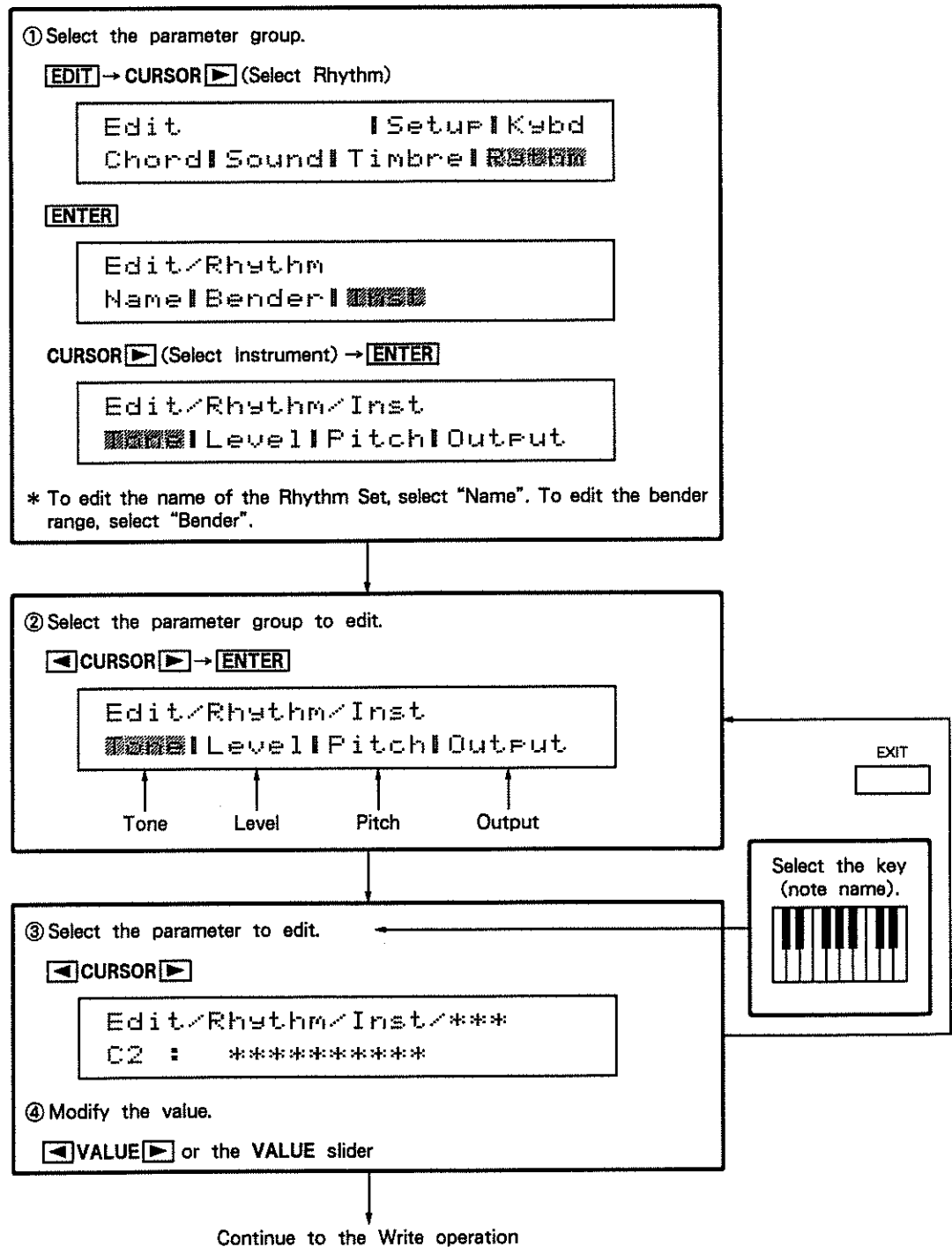

● Use the keyboard to select the key to edit

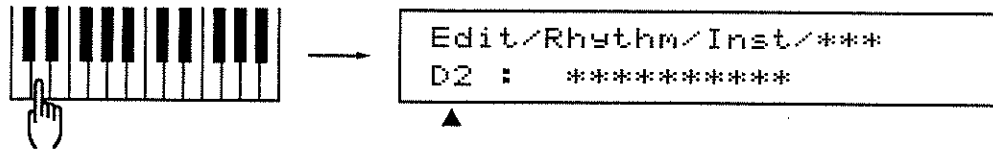

* To select the B1, C # 7 or D7 keys, you must first use key transpose to move the keyboard range.

* Edited settings are temporary. If you want to store your edits, you must use the Rhythm Set writing procedure (☞ page 79).

a. Selecting tones

Here's how to select a Tone to assign to the Rhythm Set.

Select a parameter from the tone parameter group.

Button	Parameter	Display
CURSOR CURSOR 	Tone Select	
	Source Key Mute	

● Tone Select

Select the Tone that each key will sound. You may also select a Tone other than the drum Tone (I-128).

A : When using internal Tones, select I.

When using PCM card Tones, select the card number (1, 2, ...).

B : Select the Tone number (1—128).

- **Source Key (B1—D7)** Determine which key of the selected Tone will be used.
 Example : Assign the sound of the A # 3 key of the selected Tone to the E2 key of the Rhythm Set.

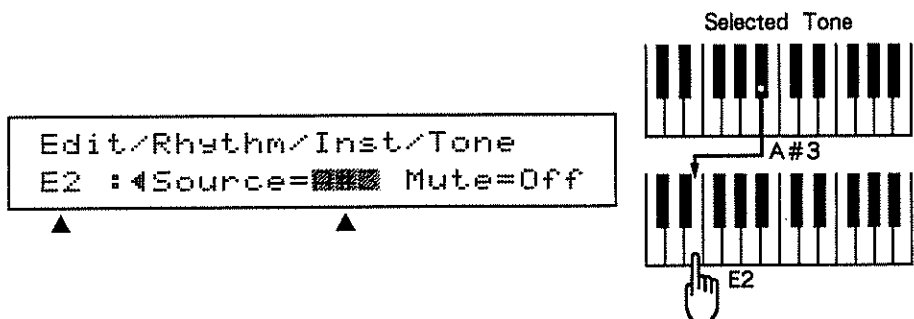

* The chart on page 167 shows the rhythm sound played by each key of the drums Tone (I-128).

- **Mute (Off, B1—D7)** This allows you to mute the sound of a selected key ... especially useful for hi-hat or cymbal.
 Example : Sound the closed hi-hat (F # 2 key) and mute the open hi-hat (A # 2 key).

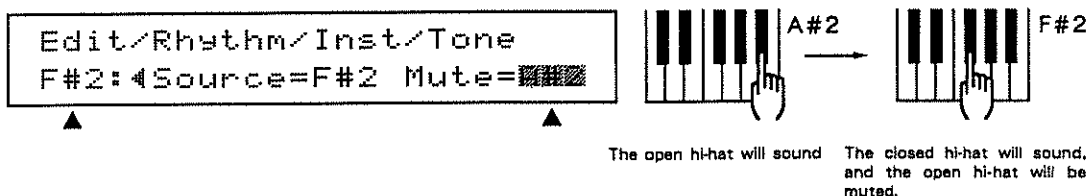

b. Level

Set the volume of each key, and determine how the volume will change.

Select a parameter from the level parameter group.

Button	Parameter	Display
CURSOR CURSOR 	Level Velocity Sensitivity	Edit/Rhythm/Inst/Level C2 : Level=[██████] U.Sens=[██████▶]
	Envelope Mode	Edit/Rhythm/Inst/Level C2 : Env Mode=[████████████████████▶]
	Env Attack Rate Env Decay Rate Env Release Rate	Edit/Rhythm/Inst/Level C2 : Env A=[██████] D=[██████] R=[██████]

● **Level (0—31)**

This adjusts the volume of each key, allowing you to balance the volumes of the rhythm sounds.

● **Velocity Sensitivity (-7—+7)**

This determines how velocity will affect the volume.

- ↑ +7 Strongly played notes will be louder
- ±0 Velocity will not affect volume
- ↓ -7 Strongly played notes will be softer

Volume change when Level = 100

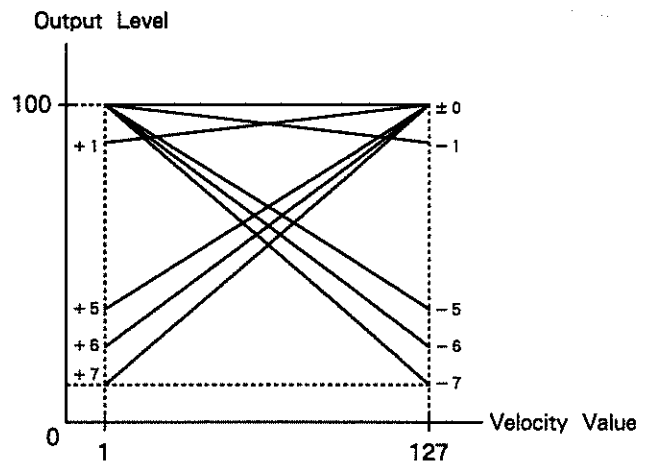

● **Envelope Mode (Sustain, NoSustain)**

Sustain : receive note off messages

NoSustain : ignore note off messages

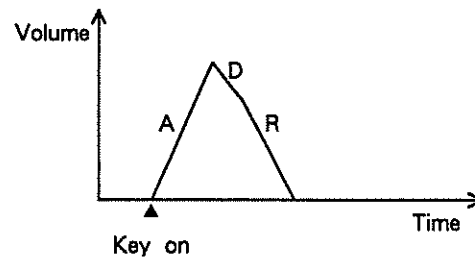
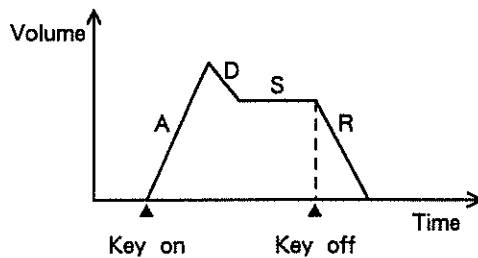

When using a sequencer or rhythm machine to play the U-20's rhythm sounds, be sure to select NoSustain.

● **Envelope**

These settings make adjustments to the change in volume over time (the envelope).

- A : Attack Rate (-7—+7)
- D : Decay Rate (-7—+7)
- R : Release Rate (-7—+7)

- ↑ +7 Faster change
- ↓ -7 Slower change

* These settings are relative to the envelope settings of the Tone. The same settings will have different results when used on different Tones.

c. Pitch

These settings determine the pitch of each key, and how the pitch will change.

Select a parameter from the pitch parameter group.

Button	Parameter	Display
CURSOR ← <input type="text"/> ↑ ↓ CURSOR → <input type="text"/>	Pitch Shift Coarse Pitch Shift Fine	Edit/Rhythm/Inst/Pitch C2 : Course= <input type="text"/> Fine= <input type="text"/> ▶
	Channel Aftertouch Sensitivity	Edit/Rhythm/Inst/Pitch C2 : ◀ Ch After Sens= <input type="text"/> ▶
	Polyphonic Aftertouch Sensitivity	Edit/Rhythm/Inst/Pitch C2 : ◀ Poly Aft Sens= <input type="text"/> ▶
	Pitch Randomize	Edit/Rhythm/Inst/Pitch C2 : ◀ Pitch Randomize= <input type="text"/> ▶
	Auto Bend Depth	Edit/Rhythm/Inst/Pitch C2 : ◀ Auto Bend Dpth= <input type="text"/> ▶
	Auto Bend Rate	Edit/Rhythm/Inst/Pitch C2 : ◀ Auto Bend Rate= <input type="text"/> ▶
	Detune Depth	Edit/Rhythm/Inst/Pitch C2 : ◀ Detune Depth= <input type="text"/>

● Pitch Shift

This adjusts the pitch.

Pitch Shift Coarse (-36, -24, -12—+12):

-3, -2, -1—+1 octave (in semitone steps)

Pitch Shift Fine (-50—+50): in steps of 1 cent

● Channel Aftertouch Sensitivity (-36, -24, -12—+12)

This determines how channel aftertouch will affect the pitch.

↑ +12 Stronger aftertouch will raise the pitch
 ±0 Aftertouch will not affect the pitch
 ↓ -36 Stronger aftertouch will lower the pitch

● **Polyphonic Aftertouch Sensitivity (-36, -24, -12—+12)**

This determines how polyphonic aftertouch will affect the pitch.

* The U-20 can receive, but not transmit polyphonic aftertouch control data.

● **Pitch Randomize (0—15)**

This randomly varies the pitch each time the note is played.

↑ 15 Much random pitch change
 ↓ 0 No random pitch change

● **Auto Bend**

This effect adds an automatic pitch bend each time the note is played.

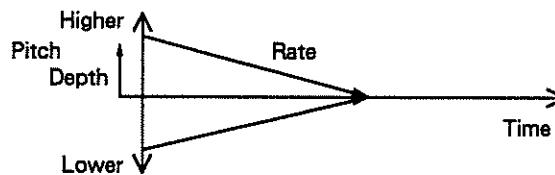

Depth (-36, -24, -12—+12):

amount of pitch change (-3, -2, -1—+1 octave)

Rate (0—15): speed of pitch change

↑ 15 Rapid pitch change
 ↓ 0 Slow pitch change



● **Detune Depth (0—15)**

This determines how detune-type Tones will be detuned. This setting is effective only when detune-type Tones are selected. (☐ Refer to page 166, "Preset Tone List".)

d. Output

For each key, you can make pan settings and determine whether to use an effect.

Select a parameter from the output parameter group.

Button	Parameter	Display
CURSOR   CURSOR	Output Assign Pan	

● **Output Assign (Dry, Rev, Cho, Dir)**

Select the effect to use for each key. For the chorus effect, the result will depend on the chorus out mode (sound patch) setting (☞ page 53).

Output Mode	Effect	Output Jacks
Dry	No effect is used	MIX OUT
Rev	Only Reverb	
Cho	Pre Rev : Chorus and Reverb Post Rev : Only Chorus	DIRECT OUT
Dir	No effect is used	

* If nothing is plugged in to the DIRECT OUT jacks, the signal from the DIRECT OUT jacks will be output from the MIX OUT jacks.

● **Pan (7 > — < < — < 7, Rnd)**

This determines the pan setting (stereo placement). When Rnd is selected, the stereo position will randomly change each time the sound is played.

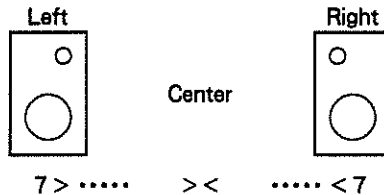

2. Other Settings

In addition to the various settings for each key, you can set the bender range, and give a name to the Rhythm Set.

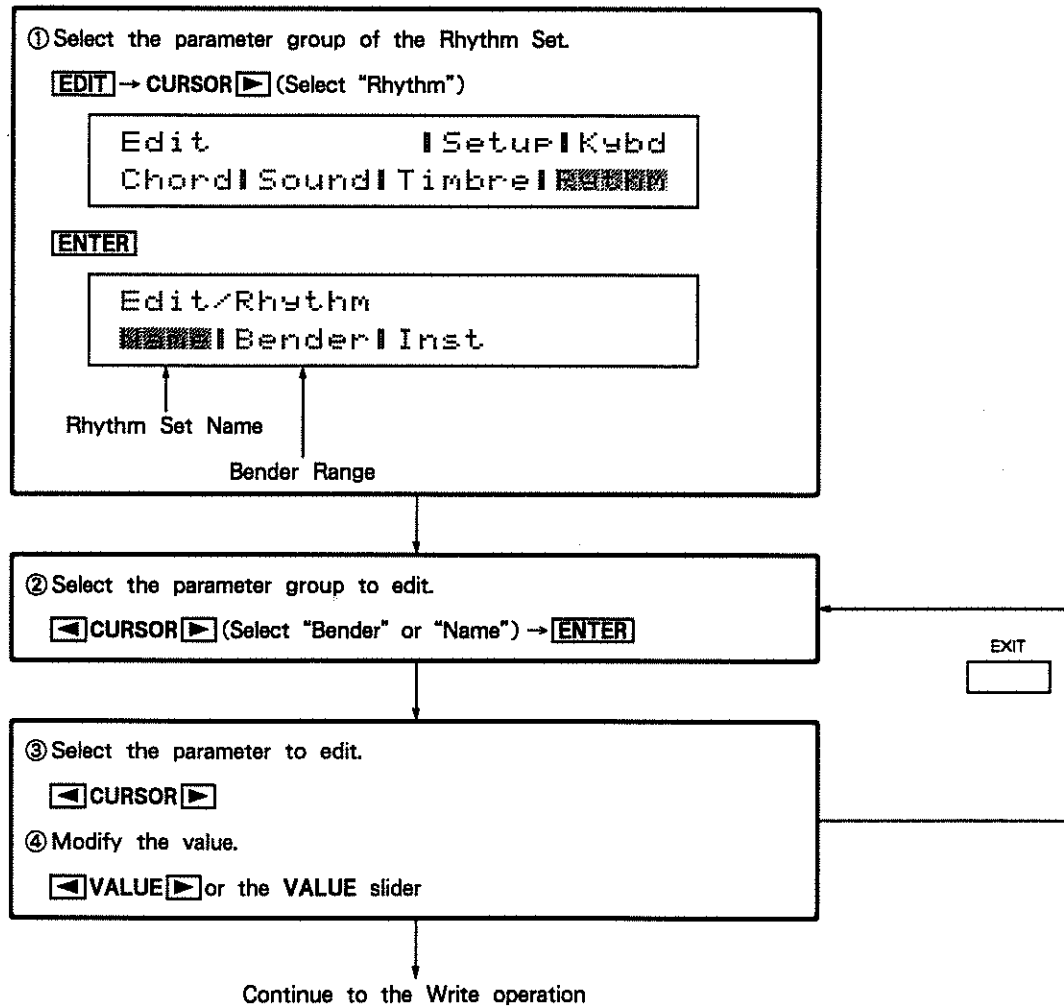

■ Bender Range

```
Edit/Rhythm/Bender
Bender Range=▼■■■■▲12
```

This determines the amount of pitch change that occurs when you bend down (move the lever to the left) or bend up (move the lever to the right).

Bend down (-36, -24, -12-±0): -3, -2, -1-0 octaves

Bend up (0-12): in semitone steps (0-1 octave)

■ Rhythm Set Name

```
Edit/Rhythm/Name
Rhythm Name=Standard Set
```

You can give each Rhythm Set a 12-character name. Move the cursor (underline) to the character you want to modify, and select a new character.

* Selectable characters :

(space) A-Z a-z 0-9 - / + * . , ; = ! " # \$ % & '

() < > { } [] _ ? ♪

* Pressing **NUMBER**1 will insert a space. Pressing **NUMBER**2 will delete the character at the cursor, and move the remaining characters forward.

3. Storing a Rhythm Set (Writing Procedure)

Here we will explain how to store an edited Rhythm Set back into the memory number it originally occupied.

* If you want to store it into a different memory, refer to "Writing Chord Sets/Rhythm Sets" (page 139).

From the Rhythm Set editing display, jump to the Rhythm Set writing display.

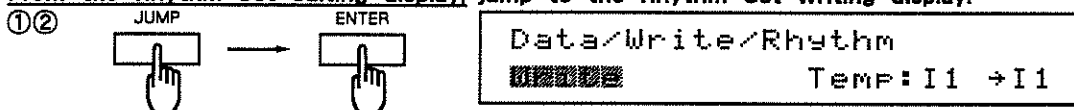

* The display will show the number of the edited Rhythm Set, and the number of the Rhythm Set into which the data will be written.

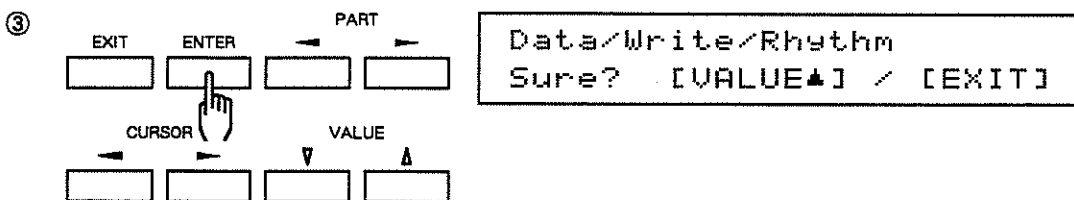

If you are sure you want to store the data into memory, press VALUE Δ . (To quit without writing, press EXIT.)

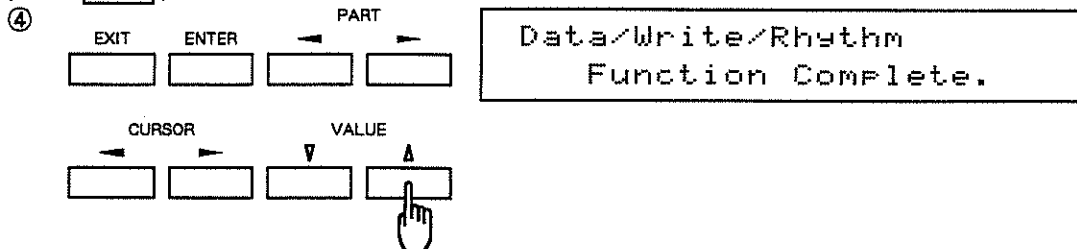

This completes the writing operation. Return to play mode.



MEMO

SECTION III

SYSTEM SETUPS

— Using the U-20 with MIDI —

Connections between the U-20's internal sound generator and keyboard follow the same concepts as MIDI. The explanations in this section will help you make effective use of the U-20 when using it as part of a MIDI system, and also when using the U-20 by itself.

I ABOUT MIDI	82
1. How MIDI Data is Transmitted and Received	82
a. Connections	82
b. MIDI channels	84
2. MIDI Data Used by the U-20	85
II HOW THE U-20 USES MIDI	88
1. Editing the MIDI Parameters	88
a. Editing procedure	88
b. MIDI parameters	89
2. Musical Performance Data	91
a. Keyboard Patch	91
b. Setup (keyboard)	93
c. Sound Patch (part 1—6, rhythm part)	94
3. Program Change	96
a. Selecting Patches and Timbres from an external MIDI device	97
b. Transmitting program changes from a Keyboard Patch	99
4. Using Controllers	101
5. Exclusive Messages	107
■ Local Control Switch (Off, On)	108
■ Tx Active Sensing Switch (Off, On)	108
■ Writing Procedure for MIDI Settings	108
■ MIDI Settings of Factory Settings	109
III TAKING FULL ADVANTAGE OF THE U-20	110
1. Using the U-20 by itself	110
2. Using a Sequencer	113
■ Velocity Offset and Sensitivity	115
3. Using External Sound Generators	116
■ Voice Reserve	117

1 ABOUT MIDI

Here we will explain the MIDI concepts that you will need to understand when using the U-20. Please be sure to read this explanation before using MIDI.

MIDI (Musical Instrument Digital Interface) is a world-wide standard for sending and receiving musical data such as notes and controller movements. If a device has MIDI, it can be connected to any other MIDI device (even of a different type or manufacturer) to exchange musical data.

MIDI transmits various types of musical data ; for example, data indicating that a key has been pressed/released, or that a controller has been moved, etc. When you play a MIDI-equipped instrument, it transmits MIDI data to indicate the notes that are being played. Another MIDI device that receives this data will produce sound just as though it were the instrument being played.

1. How MIDI Data is Transmitted and Received

Here is how MIDI data is transmitted and received.

a. Connections

MIDI-equipped devices usually have three connectors ; IN, OUT, and THRU. Use a MIDI cable to connect these connectors to other devices as needed.

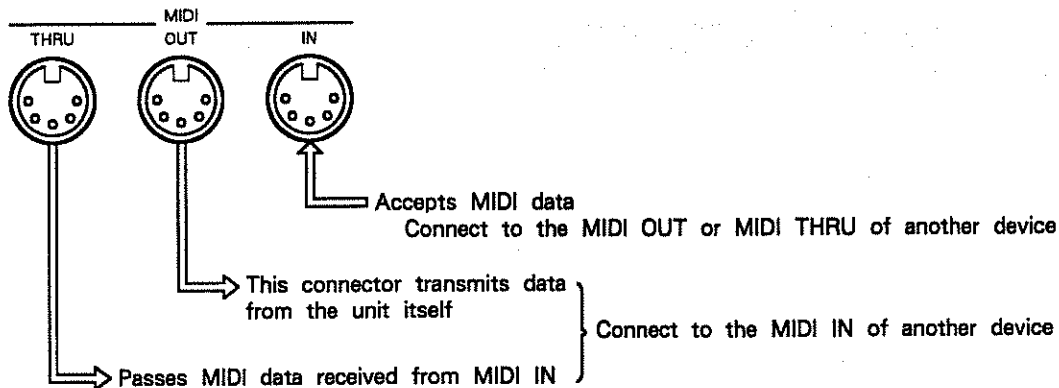

●Using the U-20 to control external sound generators

When using the U-20 to control other sound generator modules or synthesizers, make connections as follows.

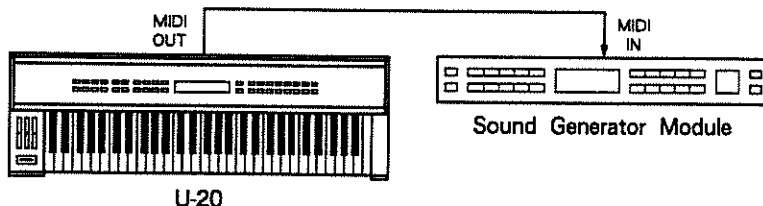

●Controlling the U-20 from external devices

When using an external sequencer or MIDI keyboard to control the U-20, make connections as follows.

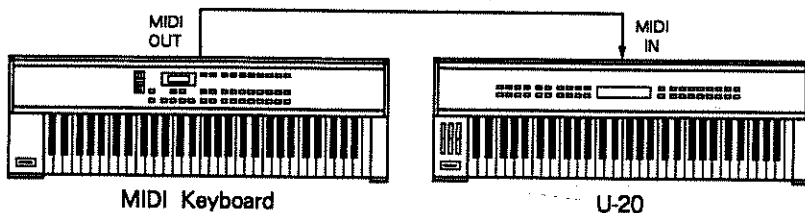

●Using MIDI THRU

By using MIDI THRU, you can connect two or more devices.

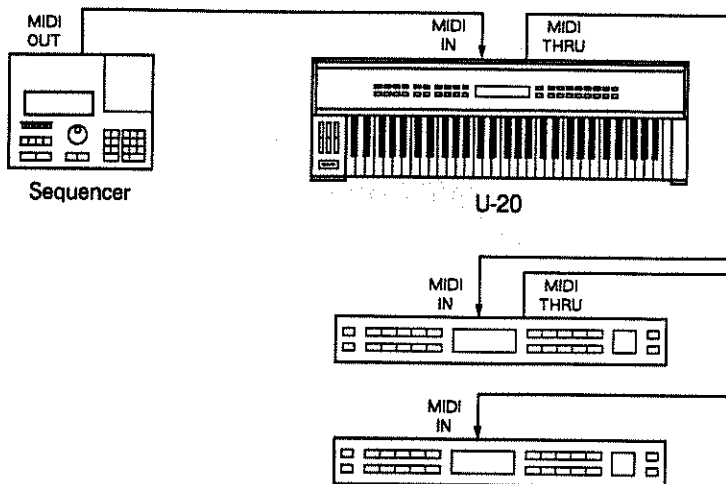

* It is theoretically possible to use MIDI THRU to connect as many devices as you like, but in practice, four or five units is the limit. Running a MIDI signal through six or more THRU's can result in garbled data transmit.

b. MIDI channels

Using "channels", MIDI can transmit data independently to multiple devices over a single cable.

You may think of MIDI channels as being similar to television channels. By switching channels on a television receiver, you can receive many different broadcasts. When the channel of the transmitter matches the channel of the receiver, the data of that channel is received.

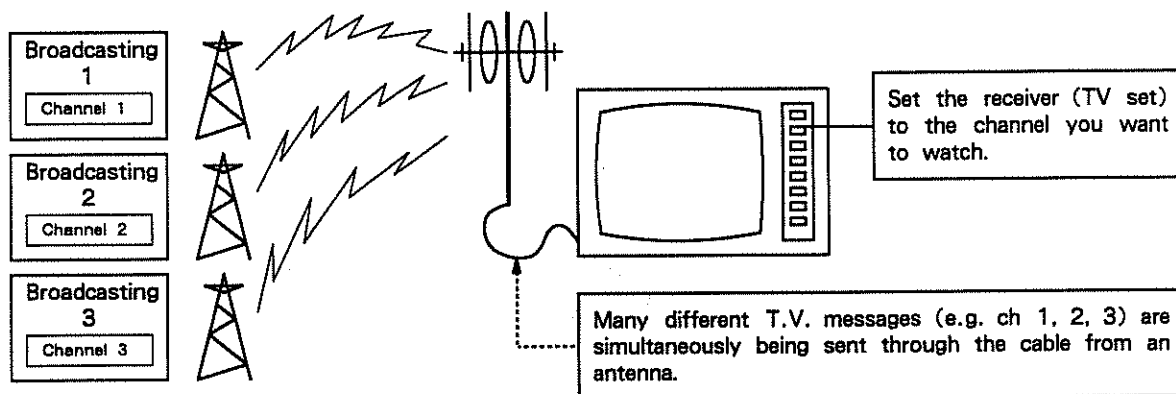

MIDI has sixteen channels, numbered 1–16. When the MIDI channel of the receiving device matches the MIDI channel of the transmitting device, the data arriving on that channel is received.

Sounds

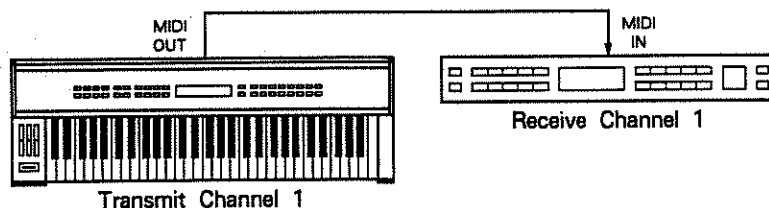

Does not sound

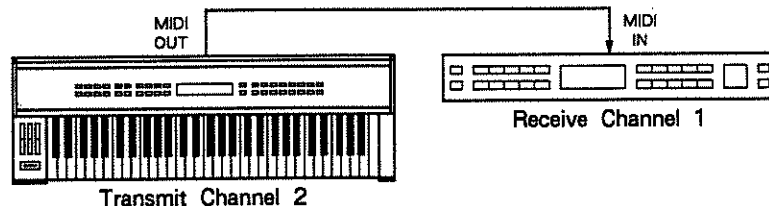

Only Sound Generator Module B Sounds

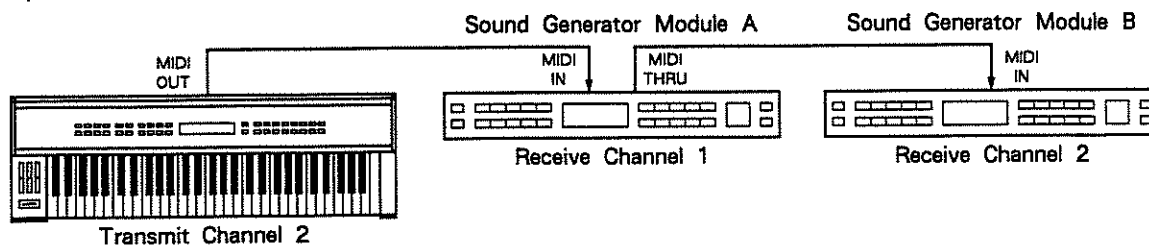

2. MIDI Data Used by the U-20

MIDI uses various types of "message" to transmit data. The U-20 uses the following types of MIDI message.

Channel Voice Messages	Note Data Program Change Control Change Pitch Bender Aftertouch
System Messages	Exclusive Messages etc.

■ Channel Voice Messages

Channel voice messages are transmitted and received on a specific MIDI channel. These messages include basic types of musical data.

● Note : messages from the keyboard

Note messages tell how the keyboard is being played. They indicate which key (the note number) was played, and how strongly (the velocity). Similar messages are transmitted when a key is released. For the U-20's Rhythm Part and most other rhythm machines, each note number will play a different rhythm sound.

● Program Change : data that selects sounds

Program change messages are used mainly to select sounds. The U-20 uses program change messages to switch Keyboard Patches, Sound Patches, Timbres, and Rhythm Setups. Devices made by different manufacturers will respond in different ways to program change messages. Check the manuals for your equipment.

● Control Change : data for musical expression

Control change messages control musical expressions such as vibrato, hold, volume, and pan. In addition to its bender lever (modulation) and hold pedal, the U-20 can transmit control change messages using three other controllers (EXT, C1, C2). These control change messages can control not only Timbre and Effect parameters for the U-20's own internal sound generator, but can also control external MIDI devices. Devices made by different manufacturers may transmit and receive different types of control change message, and respond in different ways to these messages. Consult the MIDI implementation charts of your equipment to see which control change messages are transmitted and received.

● **Pitch Bender**

Pitch bender messages transmit the position of the pitch bender lever. Only the position of the lever is transmitted, meaning that the actual pitch change (bend range) will depend on the settings of the sound generator. In the U-20, the pitch bend range is determined by a Timbre or Rhythm Set parameter.

● **Aftertouch**

Aftertouch data transmits the force with which you press down on the keyboard after playing a note. The effect this will have depends on the settings of the sound generator. Aftertouch is divided into "channel aftertouch" and "polyphonic aftertouch".

Channel aftertouch transmits a single aftertouch value telling the pressure of the key being pressed most strongly, and affects the entire MIDI channel.

Polyphonic aftertouch transmits an aftertouch value for each key, telling how strongly each key is being pressed. This allows you to individually control the sound of each note being pressed, even within a single MIDI channel. The U-20's sound generator responds to both types of aftertouch, but only channel aftertouch can be controlled from the U-20's keyboard.

■ **System Messages**

System messages are used to control all devices in the entire MIDI-connected system, regardless of their channel number. In addition to exclusive messages (explained below), system messages include various types of message used by sequencers, and messages that help the system keep running properly.

● **Exclusive Messages**

Exclusive messages carry data unique to each device, such as data for a device's internal memory. Normally, they are transmitted and received only between devices of the same type made by the same manufacturer. For example, you can use exclusive messages to transmit U-20 Timbre or Patch data to another U-20, or to store U-20 Timbre or Patch data in a sequencer.

■ About the MIDI Implementation Chart

MIDI is able to transmit and receive data between various types of device, but not all devices are able to transmit and receive the same types of data. The owners manual of each MIDI device has a "MIDI Implementation Chart" which shows the types of data that the device is able to transmit and receive. (→ page 191)

All implementation charts are a standard size, so that you can place two charts side by side to see how two devices will be able to communicate with each other.

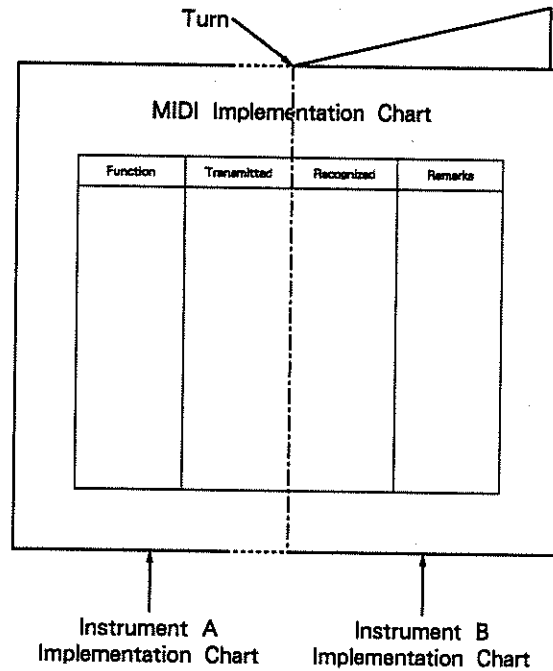

2 HOW THE U-20 USES MIDI

The U-20's MIDI functions allow it to act as a multi-timbral sound generator and also as a keyboard controller. Here, after explaining how the U-20's MIDI system is organized, we will explain the U-20's MIDI functions and settings that apply to each type of MIDI data. (For details, refer to "MIDI Implementation" (☞ page 178).)

1. Editing the MIDI Parameters

Here we will explain how the U-20's MIDI parameters are organized, and how to edit them.

a. Editing procedure

Editing procedure for MIDI parameters is essentially the same as when editing Patches or Timbres. The various MIDI parameters are related in many ways. Before you make settings, make sure that you understand how the U-20 is organized, and what you want to accomplish with your settings.

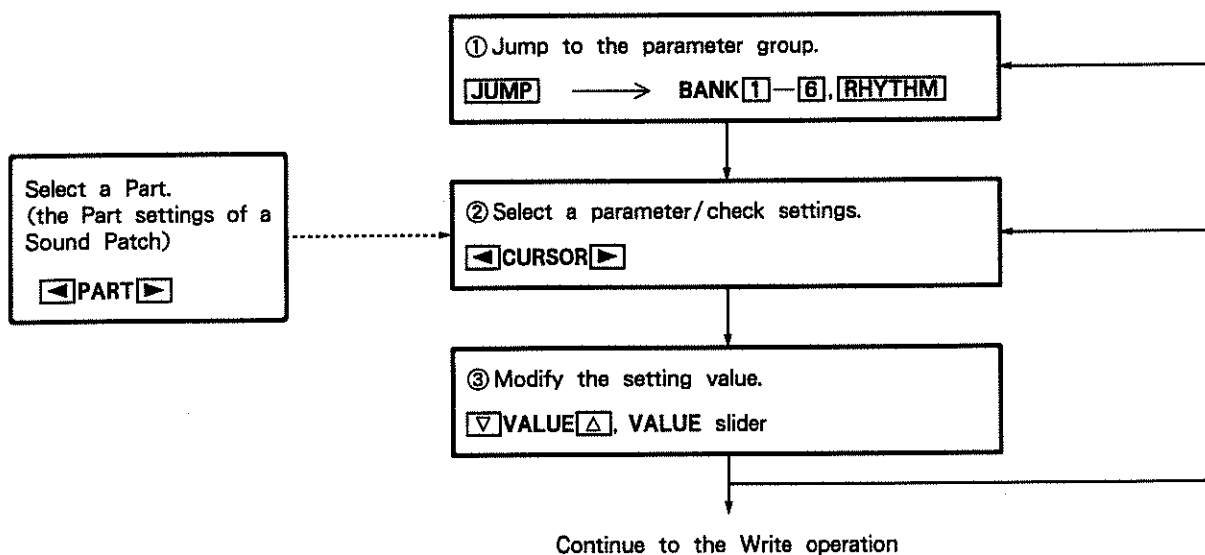

* Edits for parameters settable for each Keyboard Patch or Sound Patch are temporary. If you want to keep your edited settings, write them into memory (☞ page 133).

There is no need to write setup parameters into memory.

b. MIDI parameters

The U-20 has the following MIDI parameters. These parameters are effective in Link Play mode, Keyboard Patch mode, and Sound Patch mode. In other play modes, only some of these parameters will be effective.

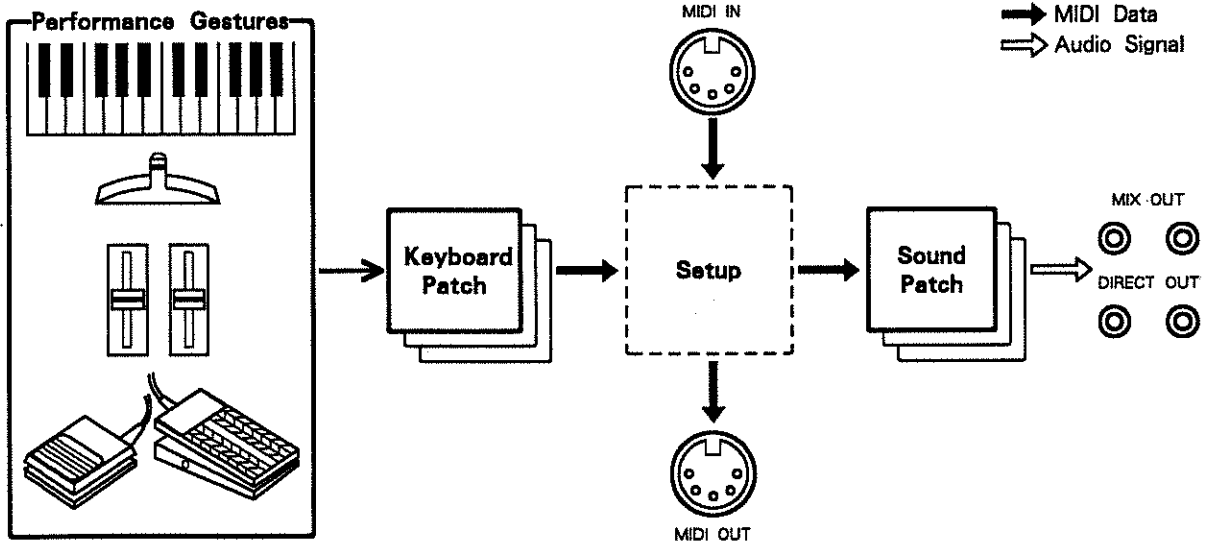

Setup (shared by all Patches)

- Common
 - Local Control Switch
 - Device ID
 - Patch Dump Switch
 - Rx System Exclusive Switch
- Keyboard
 - Rx Control Channel
 - Tx Setup Channel
 - Tx Control Change Switch
 - Tx Program Change Switch
 - Tx Channel Aftertouch Switch
 - Tx Active Sensing Switch
- Sound
 - Rx Control Channel
 - Rx Timbre Change Switch

Keyboard Patch (specified for each Patch)

- Tx Channel
- Tx Arpeggio Channel
- Tx Control Channel
- Tx Program Number
- EXT/C1/C2 Controller
(Channel
Control Number)

Sound Patch (specified for each Patch)

- Parts 1—6
 - Rx Channel
 - Key Range
 - Velocity Range
 - Rx Volume Switch
 - Rx Pan Switch
 - Rx Hold Switch
- Rhythm Part
 - Rx Channel
 - Rx Volume Switch
 - Rx Hold Switch
- Control
 - Parameter 1—3
(Control Number
Parameter Select)

Here's how to jump to each parameter group. The parameter group will be indicated in the upper line of the display.

■ Setup

These settings include parameters related to exclusive messages, and settings shared by all Keyboard Patches and Sound Patches. Since edited values are directly stored, there is no need to write them into memory.

● Common

JUMP → **BANK 1** Edit/Setup/MIDI/Common

These settings turn local control on/off, and determine how exclusive messages are handled.

● Kybd

JUMP → **BANK 2** Edit/Setup/MIDI/Kybd

These settings are shared by all keyboard patches; the Rx control channel that selects keyboard patches, and the transmit switch for control change and aftertouch messages.

● Sound

JUMP → **BANK 3** Edit/Setup/MIDI/Sound

These parameters are shared by all Sound Patches; the Rx control channel that selects Sound Patches, and the Timbre change receive switch.

■ Kybd

JUMP → **BANK 4** Edit/Kybd/MIDI

These parameters are set for each Keyboard Patch. Edited settings will be stored into memory by the Keyboard Patch writing operation.

■ Sound

These parameters are set for each Sound Patch. Edited settings will be stored into memory by the Sound Patch writing operation.

● Part 1—6

JUMP → **BANK 5** Edit/Sound/Part1/MIDI

These settings determine the Rx channel, key range, and velocity range of each Part. Use **◀PART▶** to select Parts.

● R.Part (Rhythm Part)

JUMP → **RHYTHM** → **CURSOR ▶** (press twice)

Edit/Sound/R.Part

This determines the Rx channel of the Rhythm Part.

● Ctrl (Control)

JUMP → **BANK 6** Edit/Sound/Ctrl

These determine the Sound Patch parameters which will be affected by control change messages from external MIDI devices or from the Keyboard Patch.

2. Musical Performance Data

Here we will explain the settings that determine how musical performance data is handled ... data from the keyboard, pitch bender, or modulation.

The following diagram shows how musical performance data is handled.

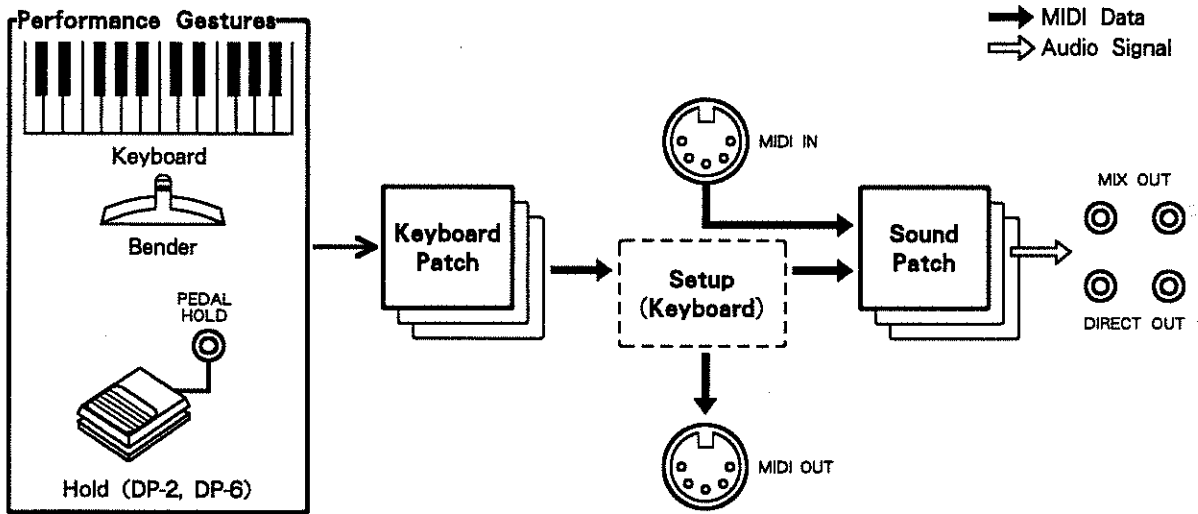

a. Keyboard Patch

When you play the U-20, the Keyboard Patch converts your playing into MIDI data. Each Keyboard Patch includes the following settings.

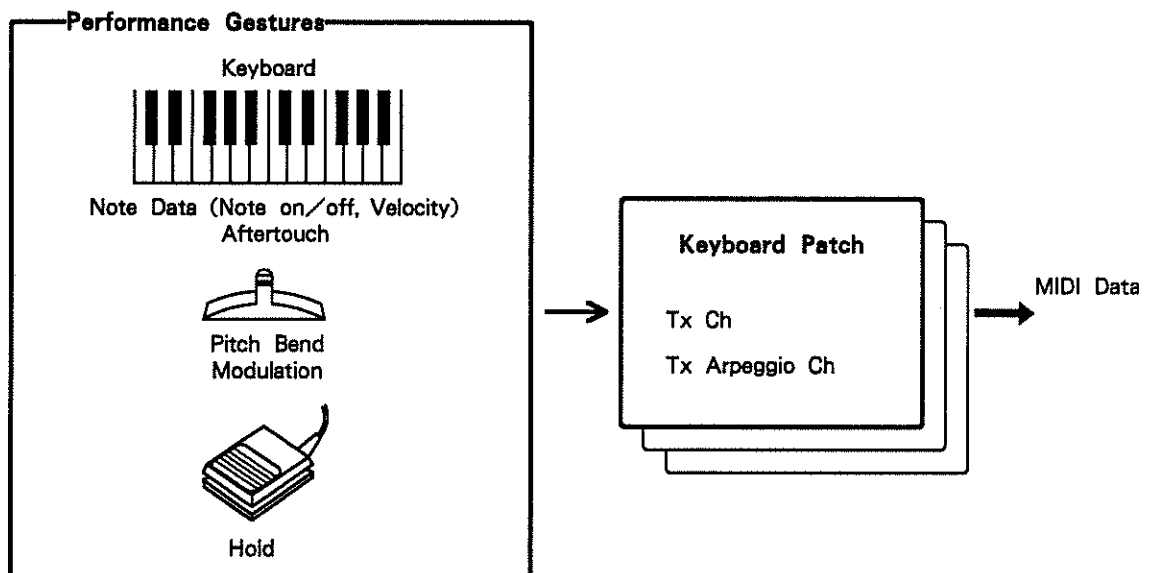

Select a Parameter

JUMP → BANK 4 → CURSOR

Tx Channel, Tx Arpeggio Channel

Edit/Kybd/MIDI

Tx Ch=███ Tx Arp Ch=███ ▶

●Tx Ch : Tx Channel (1—16, Set)

Notes you play on the keyboard and control change data that results when you use the bender lever, hold pedal, etc. will be transmitted on this channel. If this is set to Set, data will be transmitted on the Tx setup ch (☞ page 93).

For example if the Tx setup ch is “1” and the keyboard patch Tx ch is “Set”, note data will be transmitted on channel 1. By setting the Tx ch of several Keyboard Patches to “Set”, you will be able to change the Tx ch of all these Keyboard Patches by simply changing the Tx setup ch.

●Tx Arp Ch : Tx Arpeggio Channel (1—16, Set, Tx)

When using the arpeggio play function, it is possible to send the arpeggiated notes on a different MIDI channel. If this is set to Tx, the Tx ch will be used. If this is set to Set, the Tx setup ch will be used. These settings will have the following results.

Tx Arp Ch	During Arpeggio Play		Note Data during Normal Playing
	Notes you Play	Notes of the Arpeggio	
When specified channel is different than Tx ch	Tx Ch	Tx Arp Ch	Tx Ch
When specified channel is “Tx” or the same as Tx ch	Not Output	Tx Ch	Tx Ch

b. Setup (keyboard)

Setup (keyboard) determines the Tx setup ch and whether or not to transmit aftertouch data. These settings are shared by each Keyboard Patch.

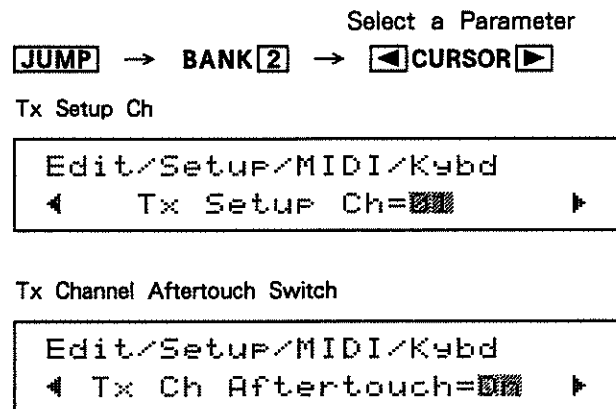
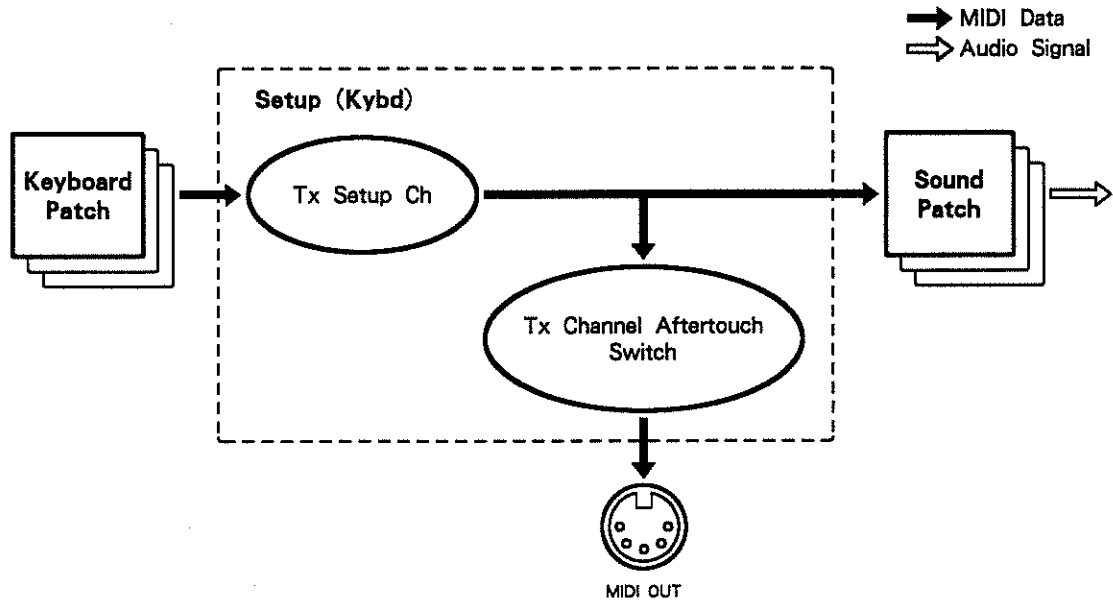

●Tx Setup Channel (1—16)

Use this when you want to transmit the performance data of each Keyboard Patch on the same channel. If you specify “Set” for the Tx ch (page 92) of each Keyboard Patch, each Keyboard Patch will transmit on the Tx setup ch specified here.

●Tx Channel Aftertouch Switch (Off, On)

This determines whether or not to transmit channel aftertouch data from MIDI OUT.

c. Sound Patch (part 1—6, rhythm part)

In a Sound Patch, data from the Keyboard Patch and from external MIDI devices is received by each Part on its own Rx channel. These settings determine the Rx channel for each Part.

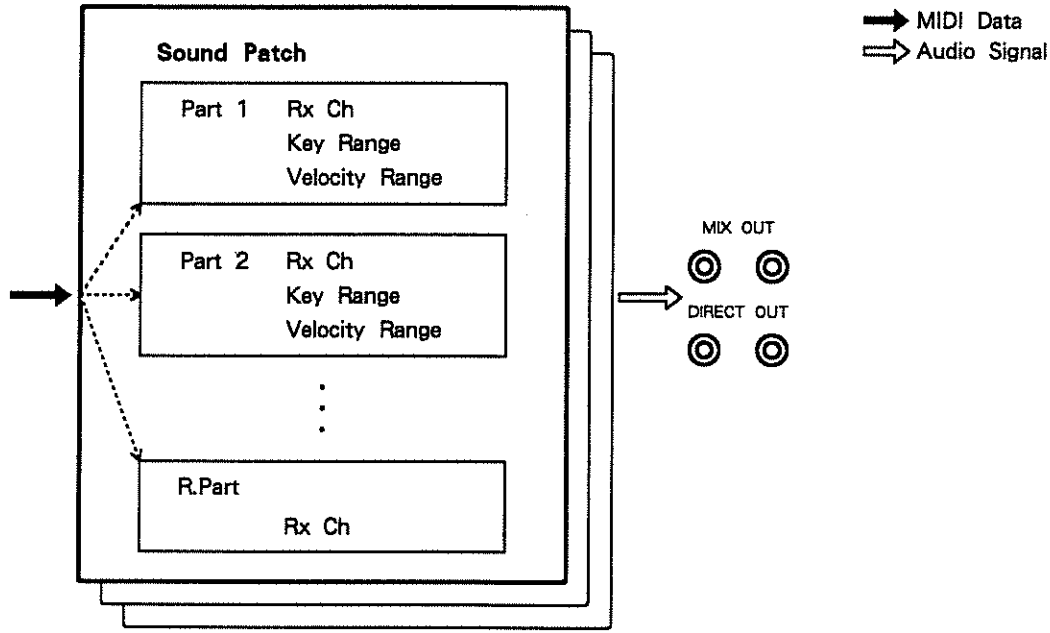

Part 1—6

JUMP → **BANK** [5] → **CURSOR** (Select a Parameter) (Select a Part) **PART**

Rx Ch

```

Edit/Sound/Part1/MIDI
Rx Ch=███ ▶
    
```

Key Range

```

Edit/Sound/Part1/MIDI
◀ Key Range ███ - ███ ▶
    
```

Velocity Range

```

Edit/Sound/Part1/MIDI
◀ Velo Range ███ - ████ ▶
    
```

Rhythm Part

JUMP → **RHYTHM** → **CURSOR** (press twice)

Rx Ch

```

Edit/Sound/R.Part
◀ Rx Ch=███ ▶
    
```

●Part Rx Ch (1—16, Off)

This determines the receive channel for each Part. When playing the U-20's keyboard, make sure that the Rx ch of the part you want to play matches the Tx ch of the keyboard. By setting two or more Parts to the same Rx ch, you can play them in unison from the keyboard. Set unused Parts to "Off".

When using a sequencer to play the U-20's sound generator, set the Rx ch of each Part to match the channel of the incoming data from the sequencer. Set the Rx channel for the Rhythm Part in the same way.

●Key Range (C-1—G9)

This determines the range over which note data will be received by each Part. Key range is specified using note names. By setting two or more Parts to the same Rx ch and setting different key ranges for each Part, you can play different sounds from different areas of the keyboard. Middle C is C4. (☞ Refer to page 7, "Front and Rear Panel".)

Example : Split bass and brass sounds around the C4 key

	Part 1	Part 2
Rx Ch	1	1
Key Range	C-1 - B3	C4 - G9
Timbre	Bass Sound	Brass Sound

* Keyboard Tx Ch : 1

●Velocity Range (1—127)

This determines the velocity range which will be received by each Part. By setting two or more Parts to the same Rx ch and setting different velocity ranges for each Part, you can play different sounds by changing the force (velocity) of your playing.

Example : Softly played notes sound a fingered bass,
strongly played notes sound a slap bass.

	Part 1	Part 2
Rx Ch	1	1
Velocity Range	1 - 99	100 - 127
Timbre	Fingered Bass Sound	Slap Bass Sound

* Keyboard Tx Ch : 1

3. Program Change

Program change data can select the U-20's Patches and Timbres.

Keyboard Patches, Sound Patches, and Timbres correspond to program changes as follows.

Keyboard Patch/Sound Patch

	Patch Number	Program Change Number
Internal Patch	I-11—I-88	1—64
Card Patch	C-11—C-88	65—128

Timbre

	Timbre Number	Program Change Number
A Group	A11—A88	1—64
B Group	B11—B88	65—128

The play mode displays allow you to check the program change number corresponding to the selected Patch or Timbre.

Program Change Number of Keyboard Patch

```

I-11 #001 : Standard
I-11 #001 : Acoust Piano
    
```

Program Change Number of Sound Patch

a. Selecting Patches and Timbres from an external MIDI device

To switch U-20 Keyboard Patches, Sound Patches, and Timbres from an external MIDI device, set the following parameters.

* Program change data received from external devices will have the same result in all play modes (except ROM play mode).

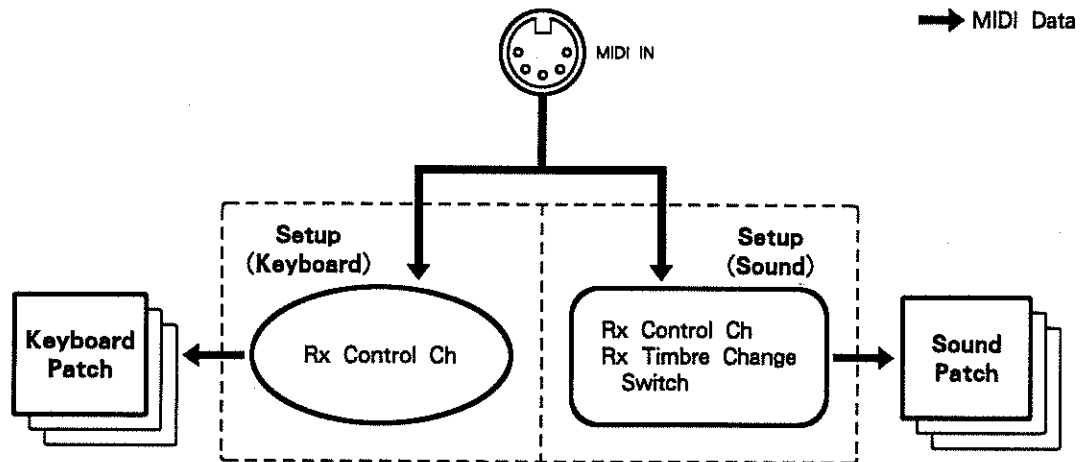

Setup (Keyboard)

JUMP → **BANK 2**

Rx Control Ch

```

Edit/Setup/MIDI/Kybd
Rx Control Ch=████▶
    
```

Setup (Sound)

Select a Parameter

JUMP → **BANK 3** → **◀CURSOR▶**

Rx Control Ch

```

Edit/Setup/MIDI/Sound
Rx Control Ch=██▶
    
```

Rx Timbre Change Switch

```

Edit/Setup/MIDI/Sound
◀ Rx Timbre Change=████
    
```

● **Keyboard Patch Rx Control Ch (1—16, Off)**

Program changes received on this channel will select Keyboard Patches. When set to Off, patches will not be selected.

● **Sound Patch Rx Control Ch (1—16, Off)**

Program changes received on this channel will select Sound Patches. When set to Off, patches will not be selected.

● **Rx Timbre Change Switch (Off, On)**

When “On” is selected, program changes from an external device or from the keyboard patch will switch the Timbre of the specified Part.

Example of channel settings for switching Patches and/or Timbres

Example		To select only the Keyboard Patch	To select only the Sound Patch	To simultaneously select the Keyboard Patch and the Sound Patch	To select the Timbre of Part 1 (Part 1 Rx Ch=1)	
Channel on which program change data is transmitted		16	16	16	1	
Setup	Kybd	Rx Control Ch	16	Off, or other than 16	16	Off, or other than 1
	Sound	Rx Control Ch	Off, or other than 16	16	16	Off, or other than 1
		Rx Timbre Change	-----	-----	-----	On

b. Transmitting program changes from a Keyboard Patch

It is possible to transmit a program change whenever you press a front panel button to select a Keyboard Patch. You can use this to select a desired Sound Patch, or to select sounds on an external MIDI sound generator or effects device.

Program change transmit will differ depending on the play mode.

Keyboard Patch Mode	The same program change data is transmitted to the Sound Patch and to external MIDI devices.
Link Play Mode	Program change data is transmitted only to external MIDI devices. The Sound Patch of the same number as the keyboard patch will always be selected.

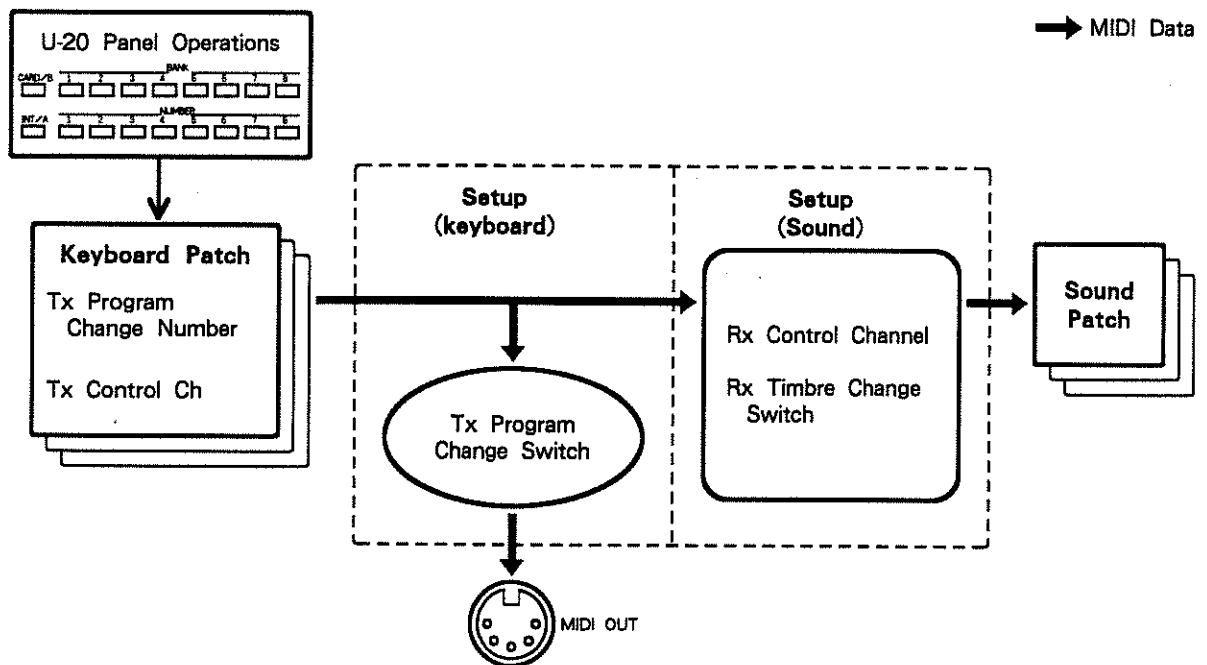

Keyboard Patch

Select a Parameter

JUMP → **BANK 4** → **CURSOR**

Tx Control Ch, Tx Program Number

```

Edit/Keyboard/MIDI
◀Tx Ctrl Ch=███ Prog#███▶
    
```

Setup (Keyboard)

Select a Parameter

JUMP → BANK 2 → ◀ CURSOR ▶

Tx Program Change Switch

```
Edit/Setup/MIDI/Kybd
◀Tx Program Change=██▶
```

●Tx Control Ch (1—16, Set, Tx)

This determines the channel on which program change data will be transmitted from a Keyboard Patch. It can be set independently for each Keyboard Patch. If this is set to Set, data will be transmitted on the Tx setup ch. If this is set to Tx, data will be transmitted on the same channel as the Tx Ch.

●Tx Program Change Number (1—128, P.N., Off)

A program change number to be transmitted can be set independently for each Keyboard Patch. If this is set to P.N., the transmitted program change message will have the same number as the Keyboard Patch. If this is set to Off, program change data will not be transmitted.

●Tx Program Change Switch (Off, On)

When you do not want a Keyboard Patch to transmit program change data from MIDI OUT, set this to Off.

* When you want program change data from a Keyboard Patch to select the Sound Patch or Timbre, make settings for Rx control ch and Rx Timbre change switch of Setup (sound).

(☞ Refer to "Selecting Patches or Timbres from an external MIDI device", page 97.)

4. Using Controllers

While playing, you can use the EXT, C1 and C2 controllers to adjust the value of timbre and effect parameters.

The Keyboard Patch will convert controller movements into MIDI control change data. For each Sound Patch, you can specify three control change numbers, and specify the parameter to be controlled by each.

It is also possible to use these controllers to control external MIDI devices, or to control Timbre and Effect parameters from an external MIDI device.

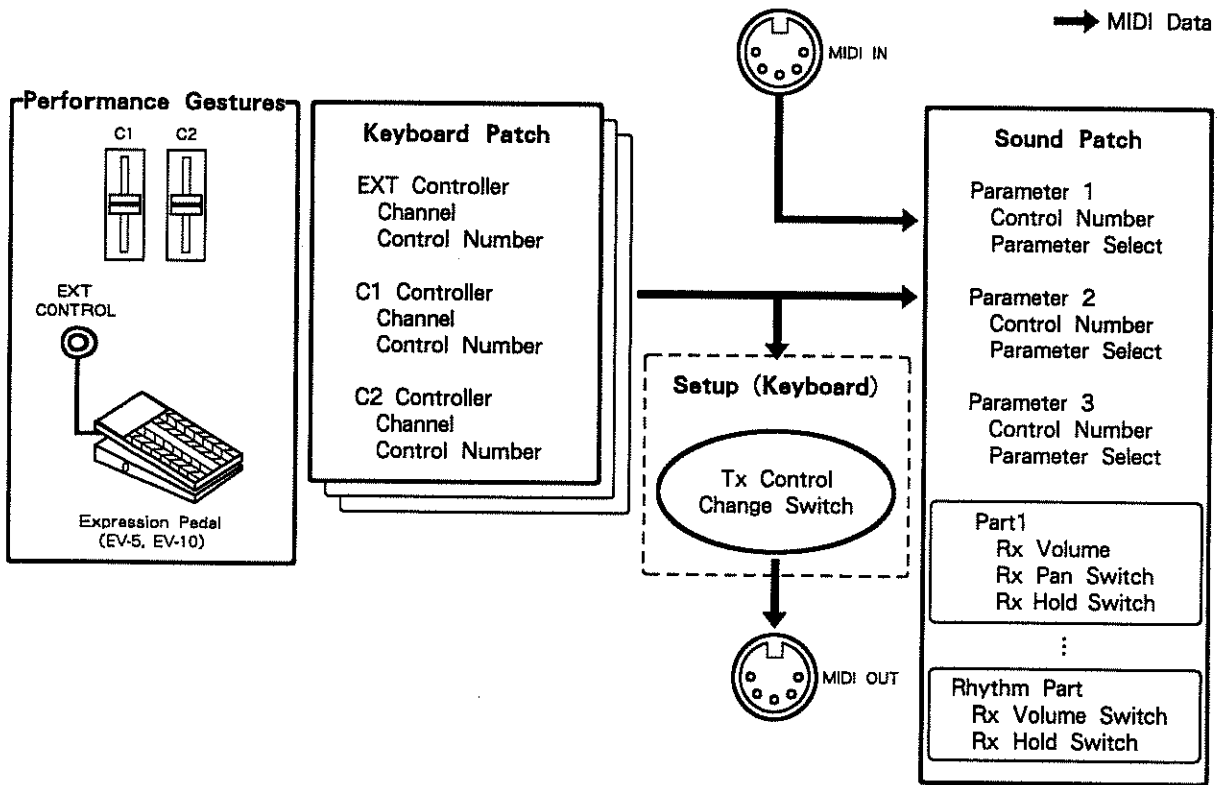

Keyboard Patch

Select a Parameter

JUMP → **BANK 4** → **CURSOR**

EXT Controller (Channel, Control Number)

```

Edit/Kybd/MIDI
◀EXT: Ch=##### ######▶
    
```

C1 Slider (Channel, Control Number)

```

Edit/Kybd/MIDI
◀C1: Ch=##### ######▶
    
```

C2 Slider (Channel, Control Number)

```

Edit/Kybd/MIDI
◀C2: Ch=##### ######▶
    
```

Setup (Keyboard)

Select a Parameter

JUMP → **BANK 2** → **CURSOR**

Tx Control Change Switch

```

Edit/Setup/MIDI/Kybd
◀Tx Control Change=#####▶
    
```

Sound Patch

Parameter 1—3

Select a Parameter

JUMP → **BANK 6** → **CURSOR**

Parameter 1 (Control Number, Parameter select)

```

Edit/Sound/Ctrl
Prm1=######
    
```

Parameter 2 (Control Number, Parameter select)

```

Edit/Sound/Ctrl
◀Prm2=######
    
```

Parameter 3 (Control Number, Parameter select)

```

Edit/Sound/Ctrl
◀Prm3=######
    
```

Part 1—6

JUMP → **BANK** **5** → **◀** **CURSOR** **▶** (Select a Part) **◀** **PART** **▶**

Rx Volume Switch (Part Level)

```

Edit/Sound/Part1/MIDI
◀ Rx Volume=███ ▶

```

Rx Pan Switch

```

Edit/Sound/Part1/MIDI
◀ Rx Pan=███ ▶

```

Rx Hold Switch

```

Edit/Sound/Part1/MIDI
◀ Rx Hold=███ ▶

```

Rhythm Part

JUMP → **RHYTHM** → **◀** **CURSOR** **▶** (Select a Parameter)

Rx Volume Switch (Part Level)

```

Edit/Sound/R.Part
◀ Rx Volume=███ ▶

```

Rx Hold Switch

```

Edit/Sound/R.Part
◀ Rx Hold=███ ▶

```

■ Keyboard Patch Settings

These determine the control functions of the C1 and C2 control sliders and a expression pedal connected to the rear panel EXT CONTROL jack. Specify functions and settings for each controller in the same way.

* During editing, the C2 control slider modifies the value being set, and cannot be used as a controller.

● Channel (Tx Ch, Tx Ctrl Ch)

Select the transmit channel on which each controller will transmit control change data.

Tx Ch : transmit on the note data transmit channel (☞ page 92)

Tx Ctrl Ch : transmit on the program change data transmit channel (☞ page 100)

When controlling Timbre parameters, be sure to select "Tx Ch".

When controlling Effect parameters, make sure that the Tx control ch of the Keyboard Patch matches the Rx control ch of the setup (sound), and select "Tx Ctrl Ch".

Setting Example

Parameter		When Controlling Timbre Parameters	When Controlling Effect Parameters
Setup (Sound)	Rx Control Ch	-----	16
Keyboard Patch	Tx Ctrl Ch	-----	16
	EXT, C1, C2 Ch	Tx Ch	Tx Ctrl Ch

● Control Number (0—5, 7—31, 64—95, Off)

This determines the control change number transmitted by each controller. When "Off" is selected, no data is transmitted. The U-20 has the following pre-defined control functions. When using these, select the appropriate control number.

# 1	Modulation
# 7	Part Level
# 10	Pan
# 64	Hold

When controlling Timbre or Effect parameters, make settings in the Sound Patch to specify control numbers for the parameters. Be sure to use control numbers other than the three shown above. When controlling external MIDI devices, remember that the control numbers that can be received (and the result they will have) will differ for each device. Consult the MIDI implementation chart for each device.

■ Setup (Keyboard) Settings

● Tx Control Change Switch (Off, On)

This determines whether or not control change data from the Keyboard Patch is transmitted from MIDI OUT. This affects not only control change data from the controllers, but also turns transmit On/Off for control change data from the bender lever (modulation) and hold pedal.

■ **Sound Patch Settings** For each Sound Patch, you can specify up to three parameters to be controlled by control change data. In addition, you can specify for each Part whether or not control change messages for Volume (Part Level), Pan, and Hold will be received. (For the Rhythm Part, you can specify reception for Volume and Hold.)

● Control Number (0—5, 7—31, 64—95, Off)

Set this to match the control number you specified for the Keyboard Patch. When controlling the U-20 from an external MIDI device, set this to match the control number transmitted by that device. When this not used, select "Off".

● Parameter Select

Select the parameter you want to control. When selecting Timbre parameters, make sure that the control change data transmit channel of the Keyboard Patch is the same as the Rx channel of the Part. When selecting Effect parameters, make sure that the control change data transmit channel of the Keyboard Patch is the same as the Rx control ch of the Setup (sound).

Selectable Parameters

	Display	Parameter
Timbre Parameters	Timbre Level	Timbre Level
	Env Attack	Env Attack Rate
	Env Decay	Env Decay Rate
	Env Sustain	Env Sustain Level
	Env Release	Env Release Rate
	A.Bend Depth	Auto Bend Depth
	A.Bend Rate	Auto Bend Rate
	Detune Depth	Detune Depth
	Vib Rate	Vibrato Rate
	Vib Waveform	Vibrato Waveform
	Vib Depth	Vibrato Depth
	Vib Delay	Vibrato Delay
	Vib RiseTime	Vibrato Rise Time
	Vib ModDepth	Vibrato Modulation Depth
Effect Parameters	Chrs Level	Chorus Level
	Chrs Rate	Chorus Rate
	ChrsFeedback	Chorus Feedback
	Rev Level	Reverb Level
	DlayFeedback	Delay Feedback

● Rx Volume Switch (Part Level) (Off, On)

Rx Pan Switch (Off, On)

Rx Hold Switch (Off, On)

For each Part, you can specify whether or not control change messages for Volume (Part Level), Pan, and Hold will be received. For the Rhythm Part, you can make settings for Volume (Part Level) and Hold. Normally you will leave all these On.

■ Setting Example

When using the keyboard to play Part 1, this example shows how you could use the EXT controller to adjust the part level and the C1 slider to adjust the reverb level.

Parameter			Setting	
Setup	Kybd	Tx Setup Ch	1	
		Tx Control Change	On	
	Sound	Rx Control Ch	16	
Keyboard Patch	Tx Ch		Set (1)	
	Tx Ctrl Ch		16	
	EXT :	Ch	Tx Ch	
		Ctrl #	7	
	C1 :	Ch	Tx Ctrl Ch	
		Ctrl #	31	
Sound Patch	Part	Part1	Rx Ch	
			Rx Volume	
	Ctrl	Prm1	#	31
			Parameter	Rev Level

5. Exclusive Messages

The U-20 can transmit and receive Timbre and Patch settings as exclusive messages. This allows you to use a sequencer to store data, or to transfer data between two U-20s. Here we will explain the settings related to exclusive message transmit and receive. The actual transmit/receive procedure is explained in "Data Transfer Using MIDI" (page 143).

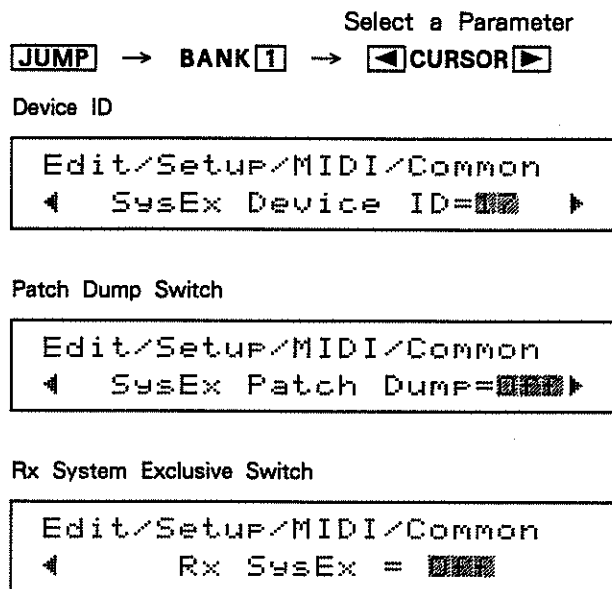

● **Device ID (1—32)** When transferring data, the device IDs of the transmitting and receiving devices must match.

● **Patch Dump Switch (Off, On)**

The patch dump function transmits Patch data as a system exclusive message. When this is set "On", an exclusive message will be transmitted every time you press a front panel button to select a Keyboard Patch or Sound Patch.

* When this is set "On", patch selection will be a bit slower due to the exclusive message being transmitted each time a Patch is selected. Normally you will leave this "Off".

● **Rx System Exclusive Switch (Off, On)**

This determines whether or not exclusive messages will be received.

■ Local Control Switch (Off, On)

This turns on/off the MIDI connection between the Keyboard Patch and the Sound Patch. When local is "Off", playing the keyboard will not sound the internal sound generator, but note data will be transmitted from MIDI OUT. Incoming data from external MIDI devices will play the U-20 sound generator regardless of this "Local on/off" setting. Normally you will leave this "On".

Setup (Common)

JUMP → **BANK 1**

```
Edit/Setup/MIDI/Common
Local Control=███ ▶
```

■ Tx Active Sensing Switch (Off, On)

Active sensing is MIDI data which is transmitted from MIDI OUT for the purpose of making sure that the MIDI connection has not been broken. Normally you will leave this "On".

Setup (Keyboard)

JUMP → **BANK 2** → **CURSOR** ▶ (Select a Parameter)

```
Edit/Setup/MIDI/Kybd
◀ Tx Active Sensing=███
```

■ Writing Procedure for MIDI Settings

MIDI parameters settable for each Keyboard Patch are written into memory by the Keyboard Patch writing operation. MIDI parameters settable for each Sound Patch are written into memory by the Sound Patch writing operation. I.e., these MIDI parameters are handled in the same way as other individual Patch parameters.

Here we will briefly explain the procedure for writing a Keyboard Patch into memory. The procedure is the same for Sound Patches.

From the Keyboard Patch (Sound Patch) edit display, jump to the write display.

① **JUMP** → **ENTER**

```
Data/Write/Kybd
██████ Temp: I11 → I11
```

② **ENTER**

```
Data/Write/Kybd
Sure? [VALUE▲] / [EXIT]
```

③ If you are sure you want to write the data into memory, press **VALUE** ▲. To cancel the operation, press **EXIT**.

```
Data/Write/Kybd
Function Complete.
```

*MIDI parameters in Setup do not need to be written into memory. The edited value is remembered.

*Details of the writing procedure are explained in "Data Mode Operations" (☞ page 128).

■ MIDI Settings of Factory Settings

Parameter Group		Parameter		Setting	
Setup	Common	Local Control		On	
		SysEx Device ID		17	
		SysEx Patch Dump		Off	
		Rx SysEx		Off	
	Kybd	Rx Control Ch		Off	
		Tx Setup Ch		1	
		Tx Control Change		On	
		Tx Program Change		On	
		Tx Ch Aftertouch		On	
		Tx Active Sensing		On	
	Sound	Rx Control Ch		16	
		Rx Timbre Change		Off	
Keyboard Patch		Tx Ch		Set	
		Tx Arpeggio Ch		Tx	
		Tx Control Ch		Tx	
		Tx Program Change #		P.N	
		EXT	Ch	Tx Ch	
			Ctrl #	Off	
		C1	Ch	Tx Ch	
			Ctrl #	Off	
		C2	Ch	Tx Ch	
			Ctrl #	Off	
Sound Patch	Part	1	Rx Ch	1	
			Key Range	C-1 – G9	
			Velocity Range	1 – 127	
	R.Part	2—6	Rx Ch		Off
			Rx Ch		10
	Ctrl	Prm1	Ctrl #	Off	
			Parameter	Timbre Level	
		Prm2	Ctrl #	Off	
			Parameter	Timbre Level	
		Prm3	Ctrl #	Off	
Parameter			Timbre Level		

* The values of parameters which can be set for each Part in a Sound Patch (Rx channel, etc.) will differ for each Sound Patch. This table shows the setting values for Sound Patch I-11 : Acoust Piano.

3 TAKING FULL ADVANTAGE OF THE U-20

Here we will explain some ways in which MIDI can help you take full advantage of the three play modes that use Patches (Link Play mode, Keyboard Patch mode, Sound Patch mode).

Functions in each play mode are as follows. Use the mode most appropriate for your musical situation.

Play mode	Part played from the keyboard	Selected by INT/A, CARD/B, BANK, NUMBER	How program change data transmitted from the Keyboard Patch is handled	Musical data received at MIDI IN
Link Play mode	Parts with a Rx channel that matches the Tx ch of the Keyboard Patch	Keyboard Patch and Sound Patch	Transmitted from MIDI OUT	Received as a multi-timbral sound generator
Keyboard Patch mode		Keyboard Patch	Transmitted to the Sound Patch which transmits from MIDI OUT	
Sound Patch mode		Sound Patch	Not transmitted	

1. Using the U-20 by itself

The U-20 can be connected with various MIDI devices and used in many different ways, but MIDI provides many possibilities even when using the U-20 by itself. Here we will explain some examples of creative ways to use a single U-20.

■ Link Play Mode

When using the U-20 by itself, Link Play mode is especially convenient.

In Link Play mode, panel buttons will select Keyboard Patches and Sound Patches together. If you set up a Sound Patch for each Keyboard Patch, the keyboard settings will always be appropriate for the sound you are playing. Or, you can use program change data transmitted from the Keyboard Patch to select memories on an external MIDI Sound generator or effects device.

■ Combining Parts

Set the channel and key range for each Part, and try out various combinations of Parts.

● Basic Setting : use only Part 1

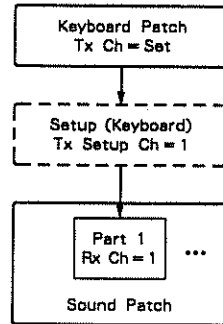

Parameter Group		Parameter		Setting
Setup	Kybd	Tx Setup Ch		1
Keyboard Patch		Tx Ch		Set
		Tx Arp Ch		Tx
Sound Patch	Part	1	Rx Ch	1

● Play two Timbres at once

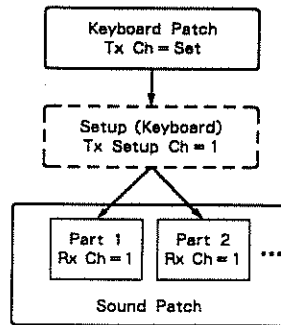

Parameter Group		Parameter		Setting
Setup	Kybd	Tx Setup Ch		1
Keyboard Patch		Tx Ch		Set
		Tx Arp Ch		Tx
Sound Patch	Part	1	Rx Ch	1
		2	Rx Ch	1

● Key Split : play two different Parts split around the C4 key

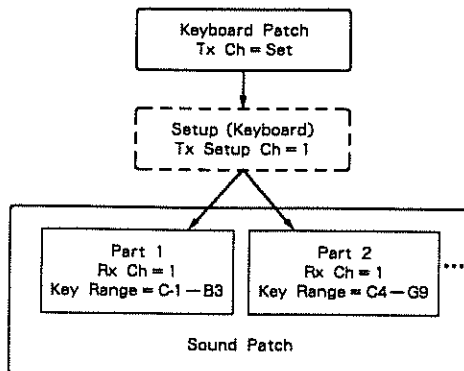

Parameter Group		Parameter		Setting
Setup	Kybd	Tx Setup Ch		1
Keyboard Patch		Tx Ch		Set
		Tx Arp Ch		Tx
Sound Patch	Part	1	Rx Ch	1
			Key Range	C-1 - B3
		2	Rx Ch	1
			Key Range	C4 - G9

●Velocity Switch : switch Parts by playing dynamics
 (softly played notes play part 1, strongly played notes play part 2)

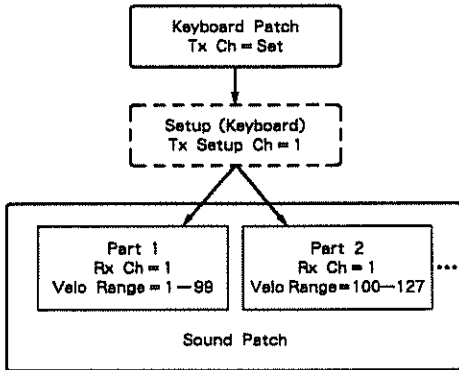

Parameter Group		Parameter	Setting	
Setup	Kybd	Tx Setup Ch	1	
Keyboard Patch		Tx Ch	Set	
		Tx Arp Ch	Tx	
Sound Patch	Part	1	Rx Ch	1
			Velo Range	1 - 99
		2	Rx Ch	1
			Velo Range	100 - 127

●Arpeggio Play : changing the arpeggio Part
 (Arpeggiated notes use part 2)

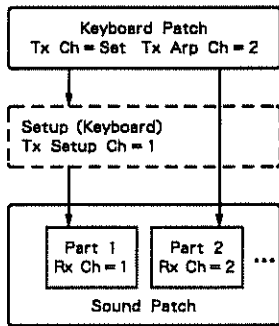

Parameter Group		Parameter	Setting	
Setup	Kybd	Tx Setup Ch	1	
Keyboard Patch		Tx Ch	Set	
		Tx Arp Ch	2	
Sound Patch	Part	1	Rx Ch	1
		2	Rx Ch	2

2. Using a Sequencer

Here's how to use the U-20's keyboard to record data into a sequencer, and playback the recorded sequence data to play the U-20's sound generator.

●Connections and Settings

Connect the U-20 and the sequencer as shown. Set the soft THRU of the sequencer "On", and the U-20 to "Local off". If the sequencer has no soft THRU function, set the U-20 to "Local on".

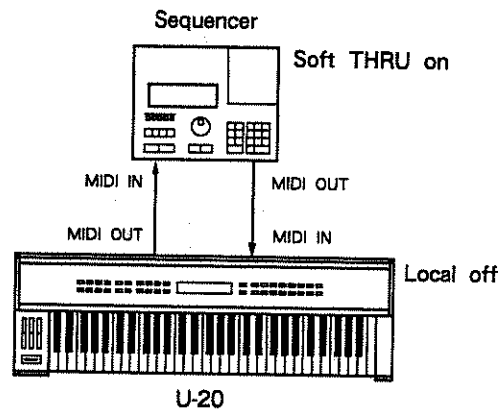

* The "soft thru" function of a sequencer allows data received at MIDI IN to be re-transmitted from MIDI OUT.

●Recording

Keeping in mind the Rx channel and sound you will use for each part, create several Keyboard Patches for use when recording. Record each part separately into the sequencer. You can also use the Arpeggio play and Chord play functions.

Example : a Keyboard Patch for recording part 1 (Rx Ch = 1)

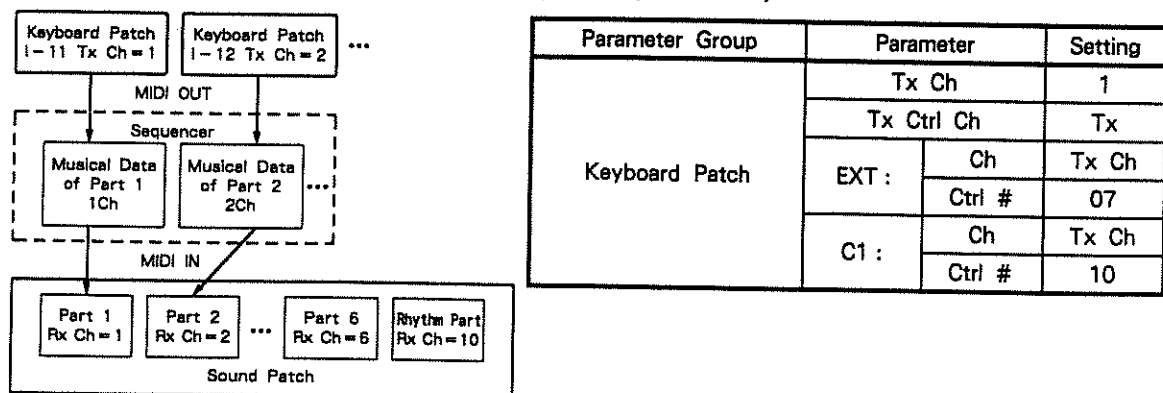

Parameter Group	Parameter	Setting	
Keyboard Patch	Tx Ch	1	
	Tx Ctrl Ch	Tx	
	EXT :	Ch	Tx Ch
		Ctrl #	07
	C1 :	Ch	Tx Ch
		Ctrl #	10

By recording program change data (patch changes) and control change data (produced by the lever, slider and pedal controllers) in addition to musical data from the keyboard, you can add musical expressiveness to your recording.

● **Sequencer Playback**

Now let's playback the data you recorded into the sequencer, to make the U-20 produce sound. If you will be playing back sequence data that you originally recorded using another synthesizer or sound generator, make sure that the U-20's Timbre and Rhythm settings are appropriate for the sequence data.

If you want to play the keyboard during sequence playback, make Keyboard Patch settings to select a Part that will not be used by the sequencer.

* The U-20 always responds to data received at its MIDI IN in the same way, regardless of the play mode (except for ROM Play mode).

Setting example : Sound Patch MIDI settings when using 6 Parts and the Rhythm Part

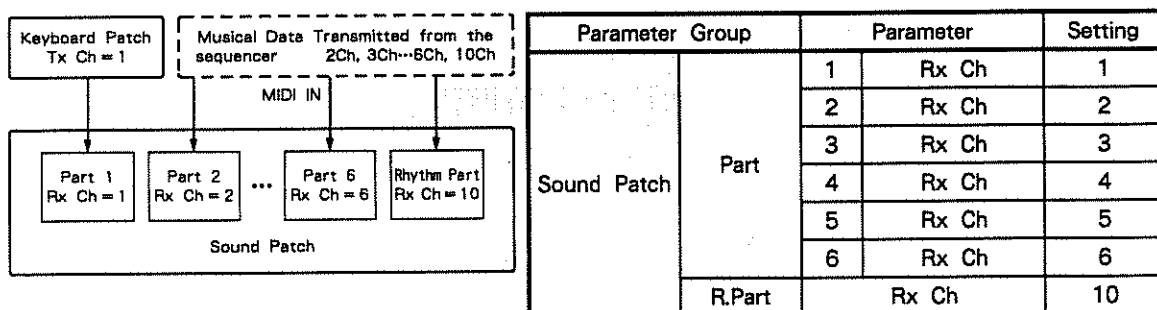

● **Using Exclusive Messages**

You can use the U-20's Patch dump function to transmit the data for the selected Patch as an exclusive message from MIDI OUT. This data can be recorded into a sequencer along with the musical data (notes, etc.). When the recorded sequence data is played back, the data for the Patch will be transmitted along with the musical data (notes, etc.), meaning that the music will be played with the exact sound (U-20 Patch) that was used to record it. In other words, the sequencer can be used to set up sounds as well as control them.

It is also possible to use the bulk dump function to transmit the entire contents of the U-20's memory to a sequencer for storage. This is explained in "Data Transfer Using MIDI" (☞ page 143).

■ About Sequencer

A sequencer is a device uses MIDI to record and play back music. Sequencers can record (store) many types of MIDI data. Unlike tape recorders which record the "sound" of an instrument, sequencer records a musical performance as change the instrumentation or speed of a musical performance recorded as MIDI data. Furthermore, sequence recording gives you many editing possibilities, such as allowing you to correct individual notes of the recorded data.

■ Velocity Offset and Sensitivity

Each Keyboard Patch includes a setting that allows you to limit the velocity produced by the keyboard. For example when using the U-20 keyboard to record a bass part, this function can be used to keep the velocity consistent, resulting in a smoother performance.

① **EDIT** → **CURSOR** (Select Kybd)

```

Edit          | Setup | ██████
Chord | Sound | Timbre | Rythm
    
```

② **ENTER** → **CURSOR** (Select Perform)

```

Edit/Kybd
Name | MIDI | ██████████
    
```

③ **ENTER** → **CURSOR** (Select Velo)

```

Edit/Kybd/Perform
██████ | Trans | Chord | Arpe
    
```

④ **ENTER** → **CURSOR** (Select the offset or sensitivity value)

```

Edit/Kybd/Perform/Velo
Offset=  1  Sens=126
    
```



⑤ Use **VALUE** or the VALUE slider to modify the value.

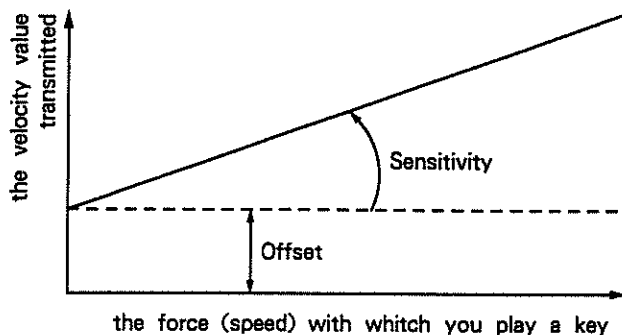

*Normally you will leave this set at offset : 1, sensitivity : 126.

*Velocity offset and sensitivity can be set independently for each keyboard patch.

3. Using External Sound Generators

Connecting external synthesizers or sound generators such as the D-110 will provide even greater possibilities.

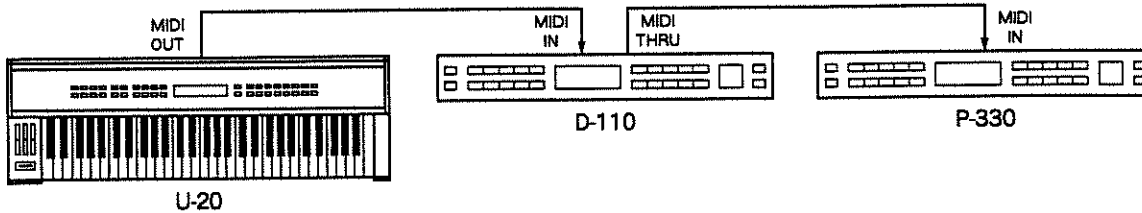

Set the each receive channel of the external sound generators by confirming the Rx channels of all U-20 parts.

In Link Play mode, program change data transmitted from the Keyboard Patch can be used to select memories on external Sound generators whenever a Sound Patch is selected.

Setting example : Layering the U-20's Parts 1 and 2 with the D-110's Part 1

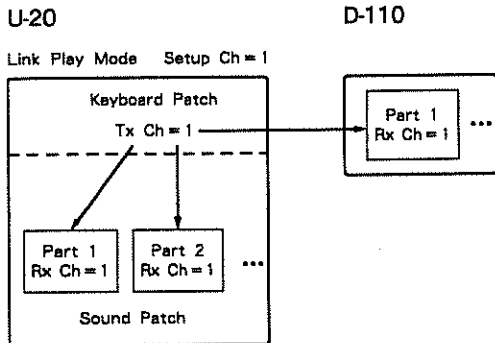

Parameter Group		Parameter	Setting
Setup	Kybd	Tx Setup Ch	1
		Tx Control Change	On
Keyboard Patch		Tx Ch	Set
		Tx Ctrl Ch	Tx
		Pgm #	***
Sound Patch	Part	1 Rx Ch	1
		2 Rx Ch	1

D-110

Parameter Group	Parameter	Setting
Part1	Rx Ch	1

* Different devices may interpret incoming MIDI data in different ways. Refer to the MIDI implementation chart for each device.

■ Voice Reserve

The voice reserve parameter is effective when using the U-20 as a multi-timbral sound generator. The U-20 can simultaneously play up to 30 voices. Until the total number of sounding parts reaches 30 voices, each Part can sound as many notes as necessary. When the number exceeds 30 voices, the oldest notes will be turned off, meaning that the sound may break off unnaturally. Voice reserve allows you to specify a minimum number of voices that will be reserved for each Part, so that even when the limit of maximum simultaneous voices is exceeded, musically important Parts will not be unnaturally cut off.

Voice reserve can be set independently for each Part. It is not possible to make voice reserve settings that would result in a total of more than 30 voices for all Parts. While you make this setting, be aware of the remaining number of unreserved voices. For unused Parts, set the voice reserve number to 0.

As shown below, get the voice reserve display and use ∇ VALUE Δ or the VALUE slider to edit the settings.

● Parts 1—6

JUMP → **NUMBER** **6**

◀PART▶

Edit/Sound/Part1/U.Rsv
Voice Reserve= ∇ [30]

Number of voices to reserve
Remaining number of unreserved voices

● Rhythm Part

JUMP → **RHYTHM** → **◀CURSOR▶** (Select the parameter)

Edit/Sound/R.Part
◀ Voice Reserve= ∇ [30] ▶

Number of voices to reserve
Remaining number of unreserved voices

*Edited settings are temporary. If you want to keep your edited settings, use the Sound Patch writing procedure to store them into memory.

MEMO

SECTION IV

SUMMARY

This section will summarize the procedures and functions in each mode of the U-20.

1	PLAY MODE OPERATIONS AND FUNCTIONS	120
	a. Playing functions	120
	b. The three Play modes that use Patches	122
	c. Part Play mode/Rhythm Play mode	123
2	EDIT MODE OPERATIONS	124
	1. Edit Procedure	124
	2. The Jump Function	125
3	DATA MODE OPERATIONS	128
	1. Using a RAM Card	128
	2. Write Operations	131
	a. Writing a patch	133
	b. Writing a timbre	136
	c. Writing chord sets/rhythm sets	139
	3. Saving/Loading Data	142
	4. Data Transfer Using MIDI (Dump)	143
	a. Data transmission by group (bulk dump)	145
	b. Patch Dump	146
	c. Transmitting data of the specified parameter (parameter dump)	146
	5. Utilities	147
	a. Initialize (Data/Utl/Initialize)	147
	b. MIDI Monitor (Data/Utl/MIDI Monitor)	149

1 PLAY MODE OPERATIONS AND FUNCTIONS

Here we will explain the functions and operations of the Play modes.

a. Playing functions

Playing functions are as follows.

■ Keyboard Touch

● Velocity

The force (velocity) with which you play a key can control volume. Timbre settings will determine the effect of Velocity.

● Channel Aftertouch

By pressing down on a key after playing it, you can control pitch, vibrato and volume. Timbre settings will determine the effect of Aftertouch.

■ Control Panel

● VOLUME Slider

This slider adjusts the volume output from the MIX OUT jacks and the PHONES jack.

● C1/C2 Sliders

These sliders can control Timbre and Effect parameters of a Sound Patch. Since Control Change data is transmitted from MIDI OUT, you can also control external MIDI devices.

In the Keyboard Patch, set the Control Change number; and in the Sound Patch, set the Timbre and Effect parameters to be controlled.

● Bender/Modulation Lever

This lever is used to Pitch Bend (up/down) and to add Vibrato. Timbre settings will determine the effect of this Bender/Modulation lever.

■ Pedal Controls

● HOLD Jack

A pedal switch (DP-2, DP-6, optional) can be connected to control Hold.

● EXT CONTROL Jack

An expression pedal (EV-5, EV-10, optional) can be connected to function in the same way as the C1/C2 sliders.

■ Performance Functions (turned on/off from the panel while playing)

- Key Transpose This function shifts the range of the keyboard. The Key Transpose setting is part of the Keyboard Patch.
- Chord Play This function allows you to play chords by pressing a single note. A different chord can be assigned to each note C, C #, —B. From 8 previously created Chord Sets, you can select 2 for use in a Keyboard Patch.
- Arpeggio Play This function arpeggiates the keys you hold. Arpeggio Type and Rate settings are part of the Keyboard Patch.

■ MIDI

- MIDI IN This connector receives MIDI data from MIDI devices such as sequencers. The U-20 will function as a multi-timbral sound generator in any Play mode (except for ROM Play).
- MIDI OUT This connector transmits MIDI data. In Part Play mode, Rhythm Play mode, and ROM Play mode, MIDI data is not transmitted.
- MIDI THRU This connector re-transmits the MIDI data received at MIDI IN, without changing it in any way. This allows you to transmit the same data to several devices.

■ Program Changes Transmitted from a Keyboard Patch

For each keyboard patch, you can specify a program change number to be transmitted. When you select a keyboard patch from the front panel, this program change number will be transmitted from MIDI OUT. In keyboard patch mode, this program change data can also select sound patches or timbres.

■ Patch Dump

The patch dump function allows you to transmit patch data as an exclusive message from MIDI OUT. If you select a patch while the patch dump switch (setup) is on, the data for the selected patch will be transmitted. (☐ For details, refer to page 146, "Patch Dump".)

b. The three Play modes that use Patches

Here we will explain the operations and displays for Link Play mode, Keyboard Patch mode, and Sound Patch mode.

Panel Operations

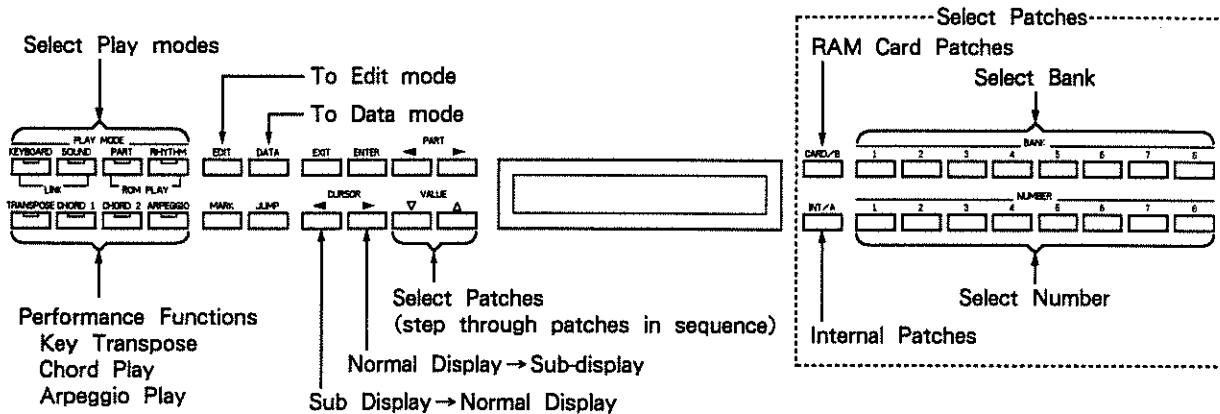

Displays

● Normal Displays (common to link play mode, keyboard patch mode, and sound patch mode)

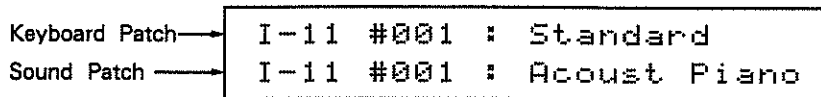

● Keyboard Patch mode Sub-display

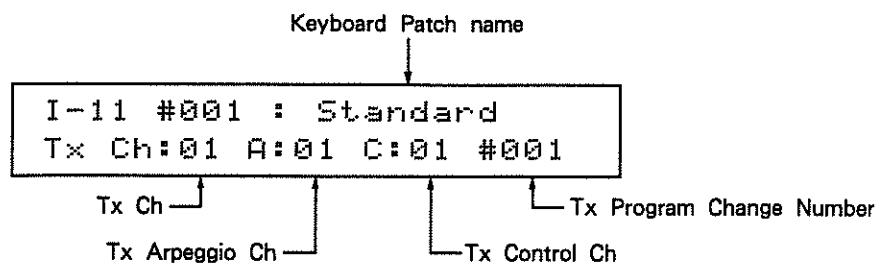

● Sound Patch mode Sub-display

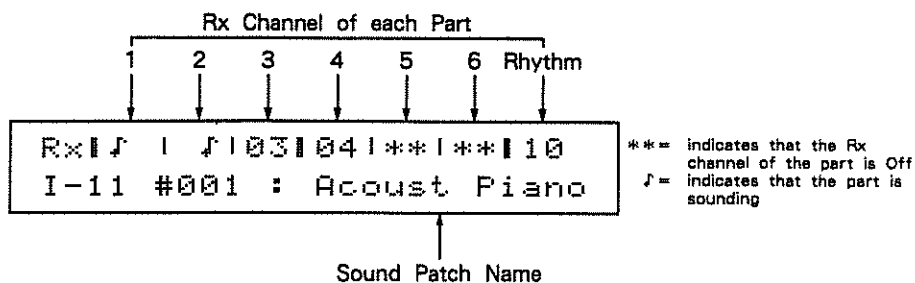

c. Part Play mode / Rhythm Play mode

In part play mode and rhythm play mode you can play the part selected from the front panel, regardless of the Tx channel of the keyboard patch. In these play modes, your playing will not be transmitted from MIDI OUT as data.

Panel Operations in Part Play mode

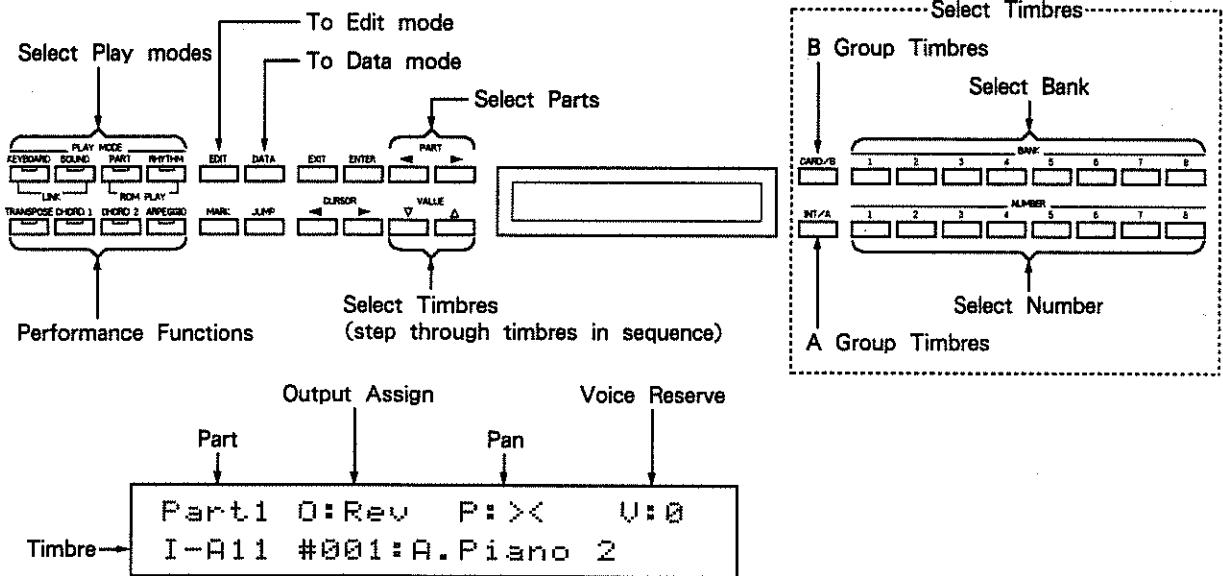

Panel Operations in Rhythm Play mode

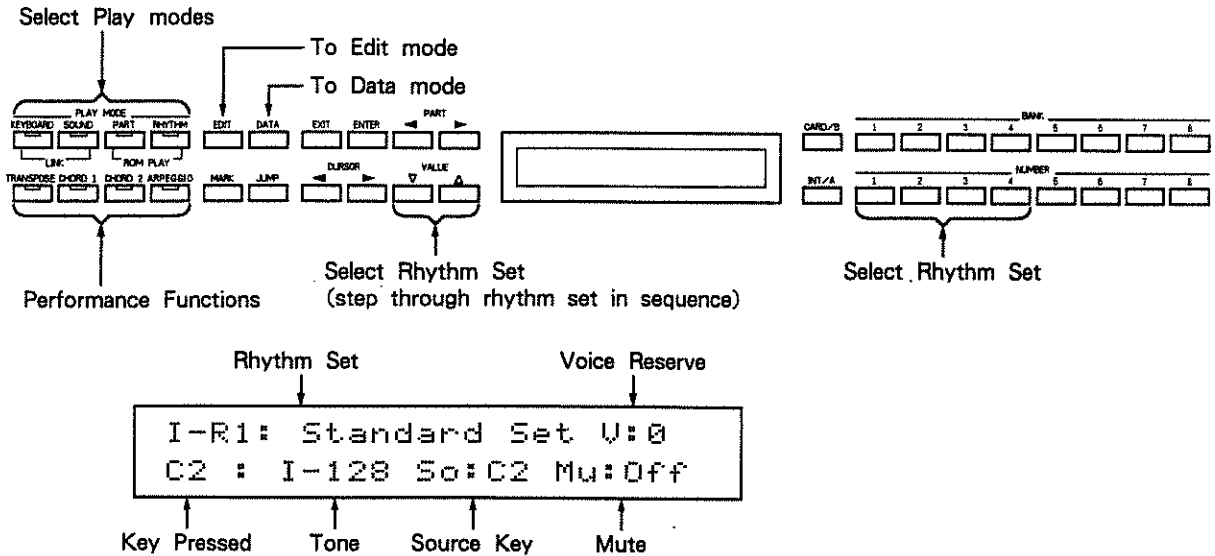

2 EDIT MODE OPERATIONS

The U-20's many parameters allow you to control the sound in various ways. To modify these parameters, you must enter edit mode. Here we will explain the various operations of edit mode, and also explain how the jump function can help you to edit more efficiently.

1. Edit Procedure

The many parameters in edit mode are organized into groups. Each group is organized as a many-branched tree.

There are two types of display in edit mode; menu displays that allow you to select the parameter group, and parameter displays that allow you to modify parameter values. Select the parameter group for the parameter you want to edit, and get the parameter display. Next, select the parameter to edit, and modify the value.

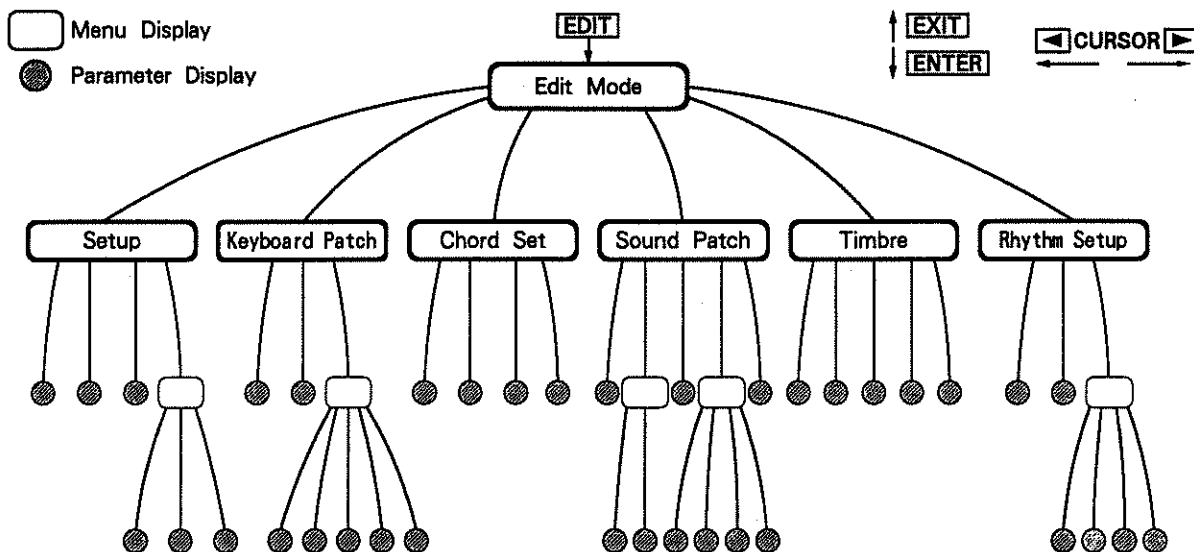

- 1 Press **EDIT** to enter edit mode (the menu display appears).
- 2 Use **← CURSOR →** to move the cursor (blinking) to the parameter group you want to edit.
- 3 Press **ENTER**, and you will move to the first level (one level below) of the selected parameter group.
- 4 Repeat steps 2 and 3 until you reach the parameter display.
- 5 Use **← CURSOR →** to move the cursor (blinking) to the parameter value you want to edit.
- 6 Use **▽ VALUE ▲** or the VALUE slider to modify the value.
- 7 Press **EXIT** to return to the previous upper level.

The upper line of the display will tell you which parameter group you are now in.

```
▶ Edit/Setup/MIDI/Common
  Local Control=On ▶
```

* To move from edit mode to play mode, simply press a play mode select button.

2. The Jump Function

The Jump function lets you to edit more efficiently, by allowing you to jump directly to a desired display instead of working your way through the tree structure. Some jump destinations are factory-defined presets, and you can define others to meet your own needs. (The jump function cannot be used in ROM Play mode.)

■ Jump Procedure

The Jump function assigns a jump destination to each of the U-20's buttons. Press **JUMP**, and then press the button to which the desired destination has been assigned.

* If after pressing **JUMP** you decide not to jump, press **JUMP** once again.

■ Defining Jump Destinations (Mark Page)

You can assign any jump destination to each of the **BANK 1-8** and **NUMBER 1-8** buttons, using the following procedure.

- ① First select the display for the desired jump destination. The position of the cursor (blinking) will also be remembered.

Example : define the master tune display as a jump destination

```
Edit/Setup/M.Tune
Master Tune=██████Hz
```

- ② Press **MARK**.

```
Edit/Setup/M.Tune
Mark: Select Switch.
```

- ③ Press the button (**BANK 1-8**, **NUMBER 1-8**) that will be used to jump to that display.

```
Edit/Setup/M.Tune
Mark: Page Memorized.
```

* To return to the factory settings, press **JUMP** → **MARK**.
(☞ Refer to page 24, "Editing Procedure using the Jump function".)

●Preset Jumps

The following jump destinations have been pre-defined for the following keys.

<p>JUMP → KEYBOARD</p> <p>JUMP → SOUND</p> <p>JUMP → PART</p> <p>JUMP → RHYTHM</p>	<p>Name a Keyboard Patch</p> <pre>Edit/Kybd/Name Patch Name= *****</pre> <p>Name a Sound Patch</p> <pre>Edit/Sound/Name Patch Name= *****</pre> <p>Select a Timbre for Parts 1-6</p> <pre>Edit/Sound/Part*/Timbre Timbre=#####: *****</pre> <p>Select a Rhythm Set for the Rhythm Part</p> <pre>Edit/Sound/R.Part Rhythm=##: *****▶</pre>
<p>JUMP → TRANPOSE</p> <p>JUMP → CHORD1</p> <p>JUMP → CHORD2</p> <p>JUMP → ARPEGGIO</p>	<p>Set the Key Transpose</p> <pre>Edit/Kybd/Perform/Trans Key Transpose=#####</pre> <p>Select a Chord Set (Chord 1)</p> <pre>Edit/Kybd/Perform/Chord1 Chord=##: *****▶</pre> <p>Select a Chord Set (Chord 2)</p> <pre>Edit/Kybd/Perform/Chord2 Chord=##: *****▶</pre> <p>Make Arpeggio Settings</p> <pre>Edit/Kybd/Perform/Arpe Type=##### Rate=***</pre>
<p>JUMP → EDIT</p> <p>JUMP → DATA</p>	<p>The edit mode display where you last were</p> <p>The data mode display where you last were</p>
<p>JUMP → EXIT</p> <p>JUMP → ENTER</p> <p>JUMP → ◀PART</p> <p>JUMP → PART▶</p>	<p>RAM Card Save/Load</p> <pre>Data/Save-Load ##### Int**Card</pre> <p>Write the parameter group you are currently editing</p> <pre>Data/Write/**** ##### Temp:*** →***</pre> <p>* You can jump here only from edit mode, but not when editing a setup parameter which does not need to be written into memory.</p> <p>Back up through the previously selected displays (up to 32 displays)</p> <p>After backing up, advance one display.</p>
<p>JUMP → ◀CURSOR</p> <p>JUMP → CURSOR▶</p>	<p>Move to the next parameter group (same effect as EXIT → ◀CURSOR → ENTER)</p> <p>Move to the next parameter group (same effect as EXIT → CURSOR▶ → ENTER)</p>

- **User-definable Jumps** With the factory settings, jump destinations are assigned to these buttons as follows.

JUMP → BANK 1	Edit/Setup/MIDI/Common Local Control=
JUMP → BANK 2	Edit/Setup/MIDI/Kybd Rx Control Ch=
JUMP → BANK 3	Edit/Setup/MIDI/Sound Rx Control Ch=
JUMP → BANK 4	Edit/Kybd/MIDI Tx Ch= Tx Arp Ch=***
JUMP → BANK 5	Edit/Sound/Part*/MIDI Rx Ch=
JUMP → BANK 6	Edit/Sound/Ctrl Prm1=# *****
JUMP → BANK 7	Edit/Sound/Effect/Chorus Type=
JUMP → BANK 8	Edit/Sound/Effect/Reverb Type= Time=**
JUMP → NUMBER 1	Edit/Timbre[*]/Name Timbre Name=*****
JUMP → NUMBER 2	Edit/Timbre[*]/Tone Tone = *-*****
JUMP → NUMBER 3	Edit/Timbre[*]/Level Level= Velo Sens=**
JUMP → NUMBER 4	Edit/Timbre[*]/Pitch Coarse= Fine=**
JUMP → NUMBER 5	Edit/Timbre[*]/Vibrato Rate= Waveform=***
JUMP → NUMBER 6	Edit/Sound/Part*/U.Rsv Voice Reserve= [**]
JUMP → NUMBER 7	Edit/Sound/Part*/Output Asgn= Lvl=** Pan=**
JUMP → NUMBER 8	Edit/Setup/M.Tune Master Tune= Hz

3 DATA MODE OPERATIONS

Data mode is where you store edited settings and manage data. It includes Write functions that store your edited patch and timbre settings, Save/Load functions for RAM cards, and MIDI Dump functions.

* The "data" handled in Data mode consists of the setting values of the various parameters.

1. Using a RAM Card

Here we will explain how to use a RAM card, and the preparations necessary before using a newly purchased RAM card. Be sure to read this section before using a RAM card. (The jump function cannot be used in ROM Play mode.)

● **What is a RAM Card?** A RAM card is a memory card which can be read and written. Data on a RAM card can be modified as many times as you want. A RAM card can be used to store edited patch and timbre data. The U-20 uses M-256E memory cards (sold separately).

* RAM cards contain a battery to preserve the data. Before using a RAM card, be sure to install the battery as explained in the instructions for the RAM card.

● Inserting a RAM Card

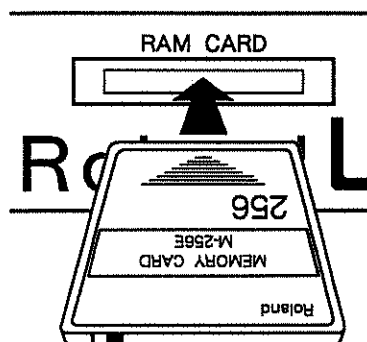

Insert a RAM card into the RAM card slot in the rear panel. Be sure that the RAM card is oriented correctly, and press it firmly into the slot.

* Never insert a RAM card into the PCM card slot. Leaving it inserted will cause malfunction.

* The sound may momentarily stop if you remove or insert a RAM card while playing, but this is not a malfunction.

● RAM Card Protect Switch

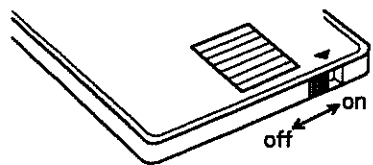

RAM cards have a Protect switch to ensure that the data in the RAM card is not accidentally erased. Normally you will leave this On. When storing data, switch protect On/Off with the card inserted the RAM card slot.

■ Initializing a RAM Card

Before you use a newly purchased RAM card, you must initialize (format) it to accept U-20 data. When you initialize a RAM card, all of the U-20's internal data will be copied into the RAM card.

* This operation must also be performed for a RAM card which you have previously used for a device other than the U-20.

- ① Insert the new RAM card into the RAM card slot, and the following message will appear. Set the RAM card Protect switch to OFF, and press **ENTER**.

```
It's a New RAM Card.
Initialize it? [ENTER]
```

- ② Press **ENTER** once again, and the card will be initialized.

```
It's a New RAM Card.
Function Complete.
```

When RAM card initialization is complete, you will return to the previous display.

■ Using a RAM Card while Playing

● Selecting RAM Card Patches (Keyboard Patches, Sound Patches)

To select RAM card Patches, press **CARD/B**, and then select a patch using **BANK 1-8** and **NUMBER 1-8**. As when selecting internal patches, the patch or timbre will change to the RAM card selection when you specify **NUMBER**.

● Selecting RAM Card Timbres

To select RAM card Timbres, you must first select a RAM card sound patch. RAM card timbres cannot be selected for an internal sound patch. Internal timbres cannot be selected for a RAM card sound patch.

In the same way, when using RAM card chord sets and rhythm sets, you must select RAM card keyboard patches or sound patches.

* RAM card keyboard patches and sound patches cannot use internal chord sets, timbres, or rhythm sets.

* Even if a RAM card patch is selected, internal setup settings will be used. To use RAM card setup settings, you must first load them into internal memory (☞ Refer to page 142, "Saving/Loading Data").

■ **Error Messages**

If an error or other unexpected condition occurs while using a RAM card, one of the following messages will appear. Take the indicated action to correct the problem.

```
Illegal PCM Card!  
Please, take it out.
```

Problem: A RAM card is mistakenly inserted into the PCM card slot.
Action: Immediately remove the RAM card from the PCM card slot.

```
Data/*****  
RAM Card Protected.
```

Problem: Since the RAM card protect switch is ON, data cannot be written.
Action: Turn the RAM card protect switch OFF, and try again.

```
Data/*****  
Card Not Ready.
```

Problem: The RAM card is not correctly inserted into the RAM card slot.
Action: Check that the RAM card is correctly inserted all the way.

```
*****  
RAM Card Verify Error!
```

Problem: When you tried to write or save RAM card data, the data was incorrectly stored.
Action: The RAM card is not correctly inserted into the RAM card slot. Re-insert the RAM card, and try the operation again.

```
It's a New RAM Card.  
Initialize it? [ENTER]
```

Problem: This message will be displayed if a new RAM card is inserted, or if the card has been used by another device, or if the card is an incorrect type.
Action: Remove the card.

```
*****  
RAM Card Battery Low!
```

Problem: The battery in the RAM card is low.
Action: Change the RAM card battery.

2. Write Operations

The various Write operations are used to store edited settings by parameter group into internal or RAM card memory. To make data management easier, Exchange and Copy operations are also provided.

●Parameter groups for writing

The following groups of parameters can be written independently into memory.

Display	Parameter Group	Number of Internal Memories	Number of RAM Card Memories
Kybd	Keyboard Patches	64(I11—I88)	64(C11—C88)
Chord	Chord Sets	8(I1—I8)	8(C1—C8)
Sound	Sound Patches	64(I11—I88)	64(C11—C88)
Timbre	Timbres	128(A11—A88 B11—B88)	128(CA11—CA88, CB11—CB88)
Rhythm	Rhythm Sets	4(I1—I4)	4(C1—C4)

* There is no need to write setup settings into memory.

●Types of Write Operation

Write (Write)	Write the edited parameter group or the data of the currently selected parameter group into the specified memory number.
Write+Ren (Write + Renumber)	Write and Renumber chord sets, timbres, or rhythm sets.
Exchange (Exchange)	Exchange the edited parameter group or the currently selected parameter group with the data of the specified memory number.
Copy (Copy)	Data which has already been stored can be Copied into the specified memory number. You can perform multiple copies at once.
Copy+Ren (Copy + Renumber)	Copy and Renumber chord sets, timbres, or rhythm sets.

The Renumber function

Each sound patch specifies a timbre number for each part 1—6. This means that when an edited timbre is written into another timbre number, you may need to re-specify new timbre numbers for any sound patches which use those timbres.

When an edited timbre is written into another timbre number, the Renumber function will automatically modify (renumber) the corresponding timbre numbers specified in each sound patch. If you use the renumber function, you will not have to re-specify timbres for each sound patch that happens to use the timbre you wrote into a new location.

Example : When you edit internal memory timbre A11 and Write + Renumber it into B63, the edited timbre will first be written into B63. Next, all internal sound patches will be searched to see if any of them specify timbre A11 for a part, and if so, they will be renumbered to B63.

The renumber function can also be used when timbre numbers change as a result of copying.

* When writing (copying) internal timbres, internal sound patches will be renumbered. For RAM card timbres, RAM card sound patches will be renumbered.

It is not possible to write (copy) + renumber between internal and RAM card memories.

In the same way, if you write (copy) + renumber a chord set or rhythm set, the chord set number and rhythm set number specified by each keyboard patch or sound patch will be modified after the data is written (copied).

■ Basic Writing Procedure

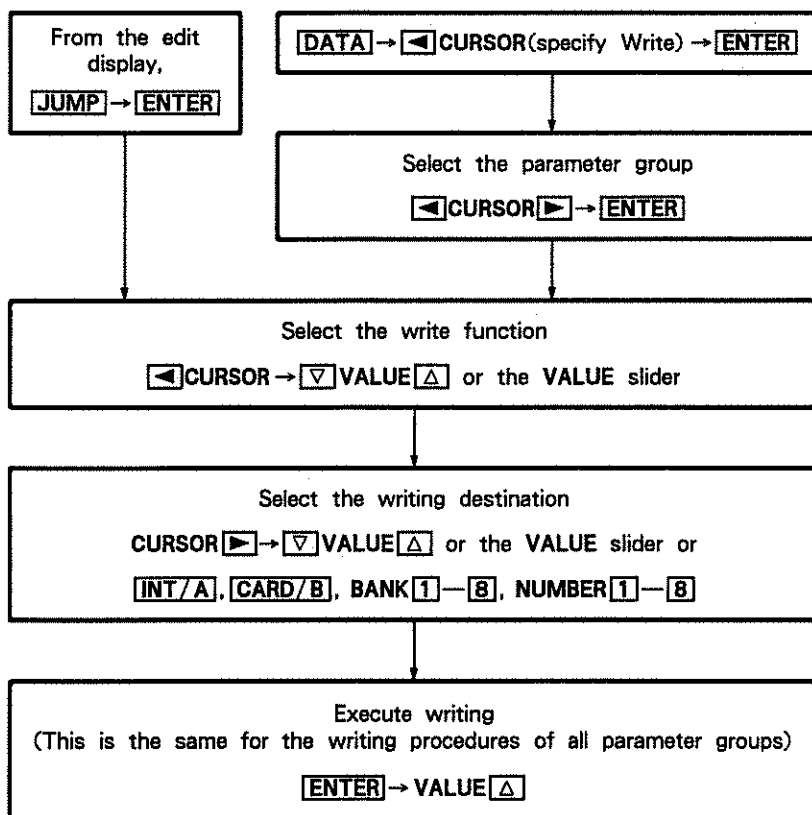

a. Writing a patch

Here we will explain how to Write a keyboard patch or sound patch into memory, and also explain the Exchange and Copy functions. The writing procedure for keyboard patches and sound patches differs only in the parameter group selection. A Part Copy function is also provided for sound patches.

■ Patch Writing Procedure

To write an edited patch into memory, use the following procedure.

* While editing a patch, you can press **JUMP** → **ENTER** to jump directly to step ④.

- ① Press **DATA** to enter data mode, and press **CURSOR** to make Write blink.

```
Data
██████| Save-Load| Bulk| Ut1
```

- ② Press **ENTER**.

```
Data/Write
██████| Chrd| Sound| Tmbr| Rhy
```

Keyboard Patch Parameter Group Sound Patch Parameter Group

- ③ Use **CURSOR** to make Kybd or Sound blink.

- ④ Press **ENTER**.

```
Data/Write/Kybd
██████      Temp: I11 → I33
```

Write Function Current Patch Number Destination Patch Number

- ⑤ Use **CURSOR** to make the Write function blink, and use **VALUE** or the VALUE slider to specify Write.

- ⑥ Use **CURSOR** to make the Destination patch number blink, and use **VALUE** or the VALUE slider to specify a patch number.

* As in play mode, the panel buttons can also be used to specify a patch number.

⑦ Press **ENTER**.

```

Data/Write/Kybd
Sure? [VALUE▲] / [EXIT]
    
```

⑧ Press **VALUE** **▲** and writing will be executed. (To quit without writing, press **EXIT**.)

```

Data/Write/Kybd
Function Complete.
    
```

⑨ Press a play mode button to return to play mode.

■ Patch Exchange

This function exchanges the settings of the currently edited patch number with the settings of the specified destination patch number.

The Exchange function can be used to check the settings of the destination patch number. Also, by specifying the same patch number as the destination, you can compare the edited and unedited sounds.

To exchange memories, select Exchange in step ⑤ (previous page) of the patch writing procedure. Next, select the destination patch number and press **ENTER** to execute the writing operation.

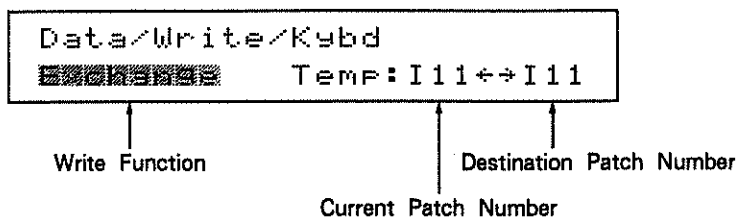

■ Patch Copy





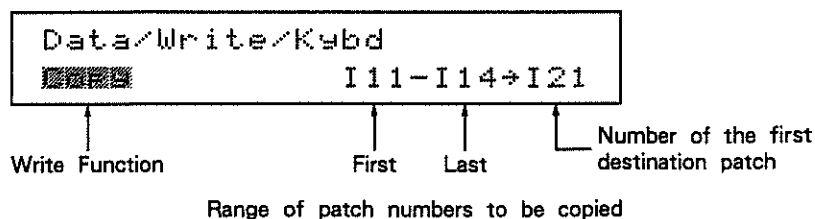

This function copies the settings of a specified range of patches into other patch numbers.

To copy memories, select Copy in step ⑤ (previous page) of the patch writing procedure. Next, select the first and last of the patch numbers you want to copy, specify the number of the first destination patch, and press **ENTER** to execute the writing operation.



■ Part Copy for a Sound Patch

The sound patch write functions also include a part copy function. This function copies the settings from a Part to another Part in the currently selected sound patch. This is useful when creating several Parts that have the same settings.

To use the part copy function, select Part Copy in step (5) of the sound patch writing procedure (see page 133). Next use **CURSOR**  to make the "copy destination part" blink, and use  **VALUE**  to select the part. Execute the copy operation with **ENTER**  **VALUE** . To quit without copying, press **EXIT** .

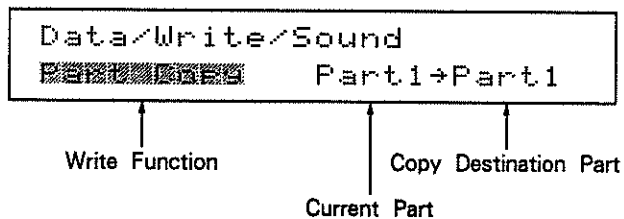

* Use **PART**  to select the currently selected part.

* Copied part settings are temporary. If you want to keep the copied settings, write the sound patch into memory.

b. Writing a timbre

Here we will explain how to Write a timbre into memory, and the procedure for Exchange and Copy. The steps are essentially the same as when writing a patch.

■ Timbre Writing Procedure

To write an edited timbre into memory, use the following procedure.

* While editing a timbre, you can press **JUMP** → **ENTER** to jump directly to step ③.

① Press **DATA** to enter data mode, and press **CURSOR** to make Write blink.

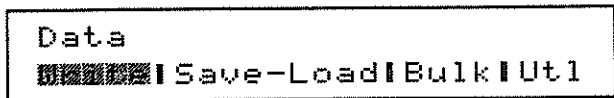

② Press **ENTER**.



↑
Timbre Parameter Group

③ Use **CURSOR** to make Tmbr blink, and press **ENTER**.

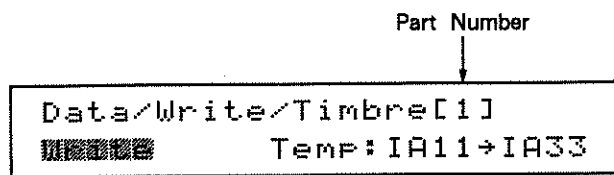

↑
Write Function

Part Number
↓

↑
Destination Timbre Number

↑
Edited Timbre Number

④ Use **CURSOR** to make the Write function blink, and use **VALUE** or the VALUE slider to specify Write.

⑤ Use **PART** to specify the part whose timbres you want to write.

⑥ Use **CURSOR** to make the Destination timbre number blink, and use **VALUE** or the VALUE slider to specify a timbre number.

* As when in play mode, a timbre number can also be specified using the panel buttons.

⑦ Press **ENTER**.

```
Data/Write/Timbre[1]
Sure? [VALUE▲] / [EXIT]
```

⑧ Press **VALUE** **▲** and writing will be executed. (To quit without writing, press **EXIT**.)

```
Data/Write/Timbre[1]
Function Complete.
```

⑨ Press a play mode button to return to play mode.

■ Timbre Exchange

This function exchanges the currently edited timbre settings with the settings of a specified destination timbre. The Exchange function can be used to check the settings of the destination timbre number. Also, by specifying the same timbre number as the destination, you can compare the edited and unedited timbres.

When exchanging, select Exchange in step ④ (previous page) of the timbre writing procedure. Next, select the destination timbre number and press **ENTER** to execute the writing operation.

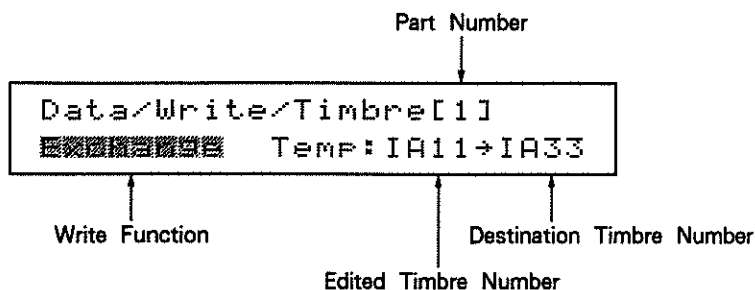

■ Timbre Copy

This function copies the settings of a specified range of timbres into other timbre numbers.

When copying, select Copy in step ④ (previous page) of the timbre writing procedure. Next, select the first and last of the timbre numbers you want to copy, specify the number of the first destination timbre. Press **ENTER** to execute the writing operation.

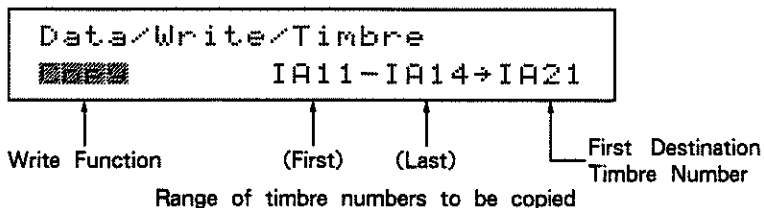

■ Write + Renumber / Copy + Renumber

The Renumber functions allow you automatically renumber the timbres used by each sound patch at the same time that you store an edited timbre into another timbre number.

This is very convenient when you want to renumber the timbre numbers specified in each sound patch so that the newly written timbres will be used.

It is also possible to automatically renumber when Copying.

To write and renumber, select Write + Ren in step ④ of the timbre write procedure. The remaining steps are the same as when writing.

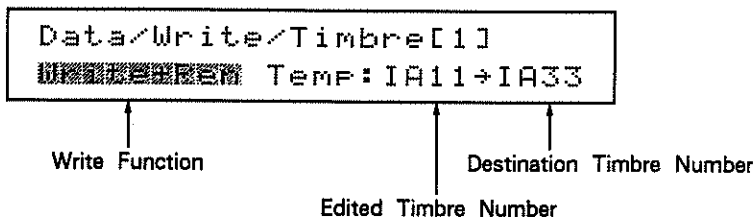

To copy and renumber, select Copy + Ren. The remaining steps are the same as when copying.

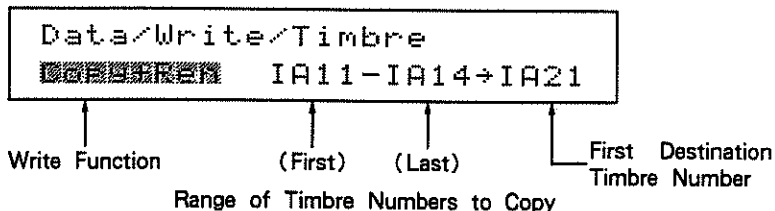

* When writing (copying) internal timbres, internal sound patches will be renumbered. When writing (copying) RAM card timbres, RAM card sound patches will be renumbered.

It is not possible to write (copy) + renumber data between internal and RAM card memory.

c. Writing chord sets/rhythm sets

Here we will explain the writing procedure for chord sets and rhythm sets, and the exchange and copy functions. The procedure is essentially the same as for timbre writing.

■ Chord Set/Rhythm Set Write Procedure

To store edited chord sets/rhythm sets, use the following procedure.

* While editing a chord set/rhythm set, you can press **JUMP** → **ENTER** to jump directly to the display of step ③.

① Press **DATA** to enter data mode, and use **CURSOR** to select Write.

```

Data
████████| Save-Load| Bulk| Ut1
  
```

② Press **ENTER**.

```

Data/Write
Kbdl|██████| Sound| Tmbr| Rhy
      ↑                ↑
    Chord Set        Rhythm Set
  
```

③ Use **CURSOR** to select either Chrd or Rhy, and press **ENTER**.

When Writing a Chord Set

Number of Button Selecting the Chord Set

```

Data/Write/Chord[1]
████████          Temp: I1 → I3
      ↑                ↑
    Write Function    Edited Chord Set Number
                    Destination Chord Set Number
  
```

Use **CHORD 1** or **CHORD 2** to specify the button whose chord set you want to store.

When Writing a Rhythm Set

```

Data/Write/Rhythm
████████          Temp: I1 → I3
      ↑                ↑
    Write Function    Edited Rhythm Set Number
                    Destination Rhythm Set Number
  
```

2. Write Operations

- ④ Use **CURSOR** to make the Write function blink, and use **VALUE** or the VALUE slider to specify Write.
- ⑤ Use **CURSOR** to make the Destination number blink, and use **VALUE** or the VALUE slider to select a number.
(Chord set : I1—I8, C1—C8 Rhythm set : I1—I4, C1—C4)

* You can also use **INT/A**, **CARD/B**, **NUMBER 1—8** (**NUMBER 1—4** for rhythm sets) to select.

- ⑥ Press **ENTER**.

```
Data/Write/*****
Sure? [VALUE▲] / [EXIT]
```

- ⑦ Press **VALUE**, and writing will be executed. (To quit without writing, press **EXIT**.)

```
Data/Write/*****
Function Complete.
```

- ⑧ Press a play mode button to return to play mode.

■ Exchange Chord Set/Rhythm Set

This function exchanges the settings of the currently edited chord (rhythm) set number with the settings of the specified destination chord set number.

This Exchange function can be used to check the settings of the destination chord (rhythm) set number. Also, by specifying the same chord set number as the destination, you can compare the edited and unedited chord (rhythm) sets.

When exchanging, select Exchange in step ④ writing procedure explained above. Next, select the destination chord (rhythm) set number and press **ENTER** execute the writing operation.

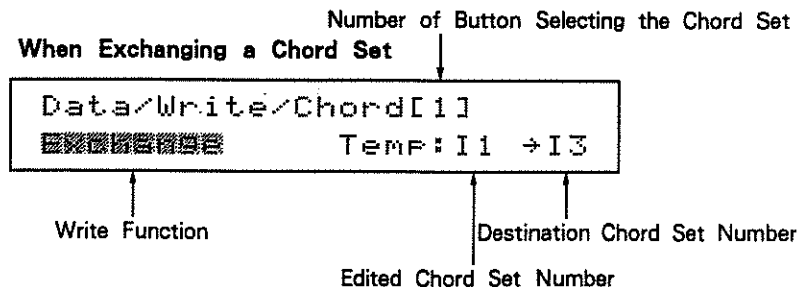

■ Copy Chord Set/Rhythm Set

This function will Copy a chord (rhythm) set from memory into another chord (rhythm) set number. The same is possible for a rhythm set.

To copy, select Copy in step ④ of the writing procedure (previous page). Next, select the chord (rhythm) set to be copied, and the copy destination chord (rhythm) set number. Press **ENTER** to write the data into memory.

When Copying a Chord Set

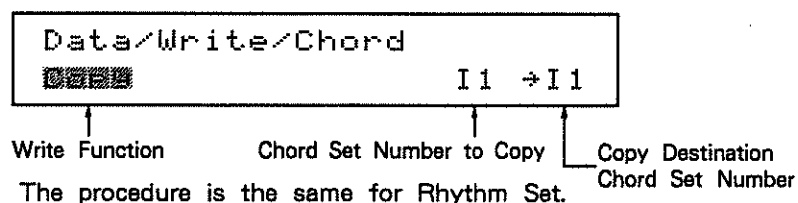

■ Write + Renumber/Copy + Renumber

When the Renumber + Write function is used, the currently edited chord set will be written into another chord set number, and at the same time, each Keyboard Patch which uses that Chord Set will be renumbered to use the newly written Chord Set.

This function is convenient when you want to rewrite the chord set numbers of each patch along with chord set settings. This Renumber function can also be used with the Copy operation.

Using the Renumber + Write function to write a rhythm set will cause the Sound Patch numbers to be renumbered.

When renumbering with the Write operation, select Write + Ren in step ④ of the chord (rhythm) set writing procedure. The remaining steps are the same as when using the Write operation.

When Renumbering a Chord Set

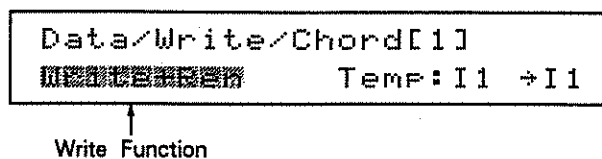

When renumbering with the Copy operation, select Copy + Ren. The remaining steps are the same as when using the Copy operation.

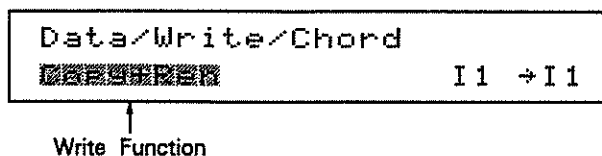

* When you Write (Copy) + Renumber an internal chord set, internal keyboard patches will be renumbered. For RAM card chord sets, RAM card keyboard patches will be renumbered. It is not possible to Write (Copy) + Renumber data between internal and RAM card memory.

3. Saving/Loading Data

Save and Load functions are used to transfer groups of data between internal memory and a RAM card.

●Data Groups for Saving/Loading

Display	Save/Load
All	All data in memory (setup, 64 keyboard patches, 8 chord sets, 64 sound patches, 128 timbres, 4 rhythm sets)
Setup	All setup data
Kybd+Chord	64 keyboard patches, 8 chord sets
Chord	8 chord sets
Sound+Tmbr+Rhy	64 sound patches, 128 timbres, 4 rhythm sets
Timbre	128 timbres
Rhythm Set	4 rhythm sets

●Save/Load Data Transfer

Display	Save/Load
Int←Card	Copy RAM card data to internal memory (Load)
Int→Card	Copy internal memory data to RAM card (Save)
Int↔Card	Exchange internal memory data and RAM card data (Exchange)

■ Save/Load Procedure

① **JUMP** → **EXIT**

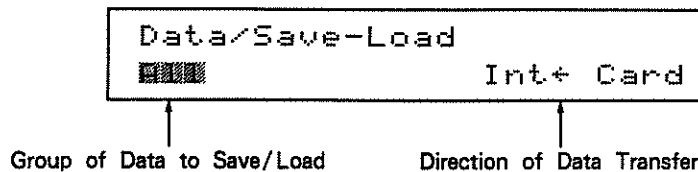

② Use **CURSOR** to select the item, and use **VALUE** or the VALUE slider to specify the parameter group, and how the data will be saved or loaded.

③ **ENTER**

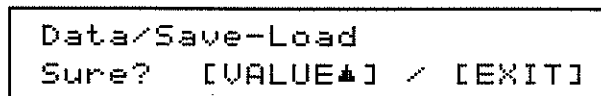

④ If you are sure you want to save or load the data, press **VALUE**. (To quit without saving or loading, press **EXIT**.)

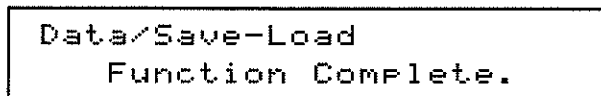

⑤ Press a play mode select button to return to play mode.

4. Data Transfer Using MIDI (Dump)

The Dump function allows you to transmit U-20 memory data as a MIDI System Exclusive message that can be received and stored by another MIDI device.

Using the Dump function, you can store U-20 data into a sequencer, or transfer identical memory settings into another U-20. By recording U-20 data into a sequencer as part of a sequence recording, the memory data will be transmitted as part of the sequence playback, so that the U-20 being controlled by the sequencer will use the same memory settings as when the sequencer recording was made.

● Transmission

Transmission Method	Transmitted Data	Transmitted in which Mode
Bulk Dump	Transmit Internal or RAM Card Data by Individual Group	Data Mode
Patch Dump	Transmit All Data of the Selected Patch	Play Mode
Parameter Dump	Transmit the Data Indicated by the Blinking	Edit Mode

* The Patch Dump function cannot be used in Part Play mode, Rhythm Play mode, or ROM Play mode.

■ Connections

Data is transmitted in one direction (one-way transmission)
Make MIDI connections as follows.

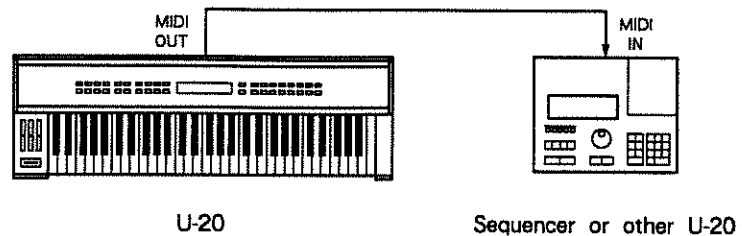

■ Device ID

When receiving and transmitting Exclusive messages, the Device IDs of the two devices must match (→ page 178, "MIDI Implementation"). If the device ID of the incoming message does not match the device ID of the receiving device, the incoming message will be ignored.

- ① **JUMP** → **BANK 1** → **CURSOR** (select the next display)

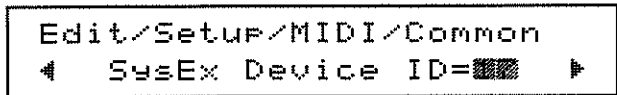

- ② Use **VALUE** or the **VALUE** slider to set the Device ID.

- ③ Press one of the play mode select buttons to return to play mode.

■ When Receiving Exclusive Messages

For exclusive messages to be received, the Exclusive Reception switch must be On. If the Exclusive Reception switch is On, exclusive messages can be received at any time.

- ① **JUMP** → **BANK 1** → **CURSOR** (select the next display)

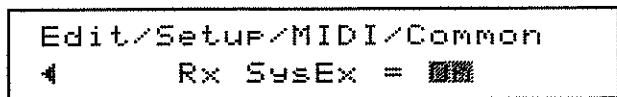

- ② Use **VALUE** or the **VALUE** slider to turn the Exclusive Reception switch On.

While an exclusive message is being received, the following display will appear. (If the received exclusive message is very short, the display will not appear.)

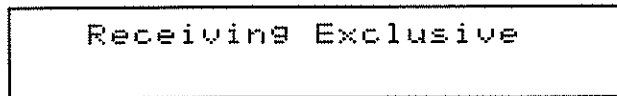

*While an exclusive message is being received, other operations will be slowed down. For this reason, you will normally leave this setting Off.

a. Data transmission by group (bulk dump)

The Bulk Dump function can be used to transmit selected groups of data from internal memory or RAM card to an external device such as a sequencer or another U-20.

● Data Groups for Transmission

Type of Data	Data Group	Transmitted Data
Temp (all currently selected data)	All	All currently selected data (keyboard patch, chord 1/2, sound patch, timbres assigned to parts 1—6, rhythm set)
	Keyboard Patch Chord[1] Chord[2] Sound Patch Timbre[1] : Timbre[6] Timbre[1-6] Rhythm Set	The currently selected keyboard patch The chord set of chord 1 The chord set of chord 2 The currently selected sound patch The timbre assigned to part 1 : The timbre assigned to part 6 The timbres assigned to parts 1—6 The rhythm set assigned to the rhythm part
Internal (data in internal memory)	All	All data in internal memory (setup, 64 keyboard patches, 8 chord sets, 64 sound patches, 128 timbres, 4 rhythm sets)
	Setup Keyboard Patch Chord Sound Patch Timbre Rhythm Set	Setup 64 keyboard patches 8 chord sets 64 sound patches 128 timbres 4 rhythm sets
RAM Card	Card All	All data in the RAM card

■ Bulk Dump Procedure

- ① **DATA** → **CURSOR** (select Bulk) → **ENTER**

```

Data/Bulk
████████ Internal RAM Card

```

- ② **CURSOR** (select the type of data to transmit) → **ENTER**

```

Data/Bulk/Temp
Bulk Dump ████████

```

- ③ Use **VALUE** or the VALUE slider to select the data group to transmit.

- ④ Press **ENTER** and the data will be transmitted. (If the transmitted exclusive message is very short, no display will appear.)

- ⑤ Press a play mode select button to return to play mode.

b. Patch Dump

When the Patch Dump switch is On, selecting a patch from the front panel (**INT/A**, **CARD/B**, **BANK 1–8**, **NUMBER 1–8**) will transmit the data of the selected patch.

● Transmitted Data

Play Mode	Transmitted Data
Keyboard Patch Mode	Keyboard patch, chord sets assigned to chords 1 and 2
Sound Patch Mode	Sound patch, timbres assigned to parts 1–6, rhythm set assigned to the rhythm part
Link Play Mode	Both keyboard patch and sound patch data (including the assigned chord set, timbres, and rhythm set)

■ Patch Dump Procedure

- ① **JUMP** → **BANK 1** → **CURSOR** (select the next display)

```

Edit/Setup/MIDI/Common
◀ SysEx Patch Dump=00 ▶

```

- ② Press **VALUE** to turn the Patch Dump switch On.

- ③ Return to play mode.

- ④ When you select a patch from the front panel, the data of the selected patch will be transmitted.

- * Patch data will not be transmitted when a patch is selected in response to a program change message from an external device, or when you use **VALUE** to select patches.
- * When Patch Dump is used, patch selection will be slightly slower. For this reason, you should normally leave the Patch Dump switch Off.
- * Data will not be transmitted in part play mode, rhythm play mode, or ROM play mode.

c. Transmitting data of the specified parameter (parameter dump)

While editing, you can press **ENTER** to transmit the value of the currently selected (blinking) parameter.

(Example)

```

Edit/Sound/Part1/Output
Asgn=Rev Lvl=127 Pan=><

```

For example, if you press **ENTER** from this display, the volume level of part 1 (127) will be transmitted.

5. Utilities

In addition to the Write and Data Transfer functions already explained, data mode includes Initialization and MIDI Monitor functions.

a. Initialize (Data/Utl/Initialize)

This function initializes (restores to a basic setting) the currently selected data.

- * Only the currently selected keyboard patch or sound patch will be initialized. Data already written into internal memory or RAM card will not be affected.
- * The initialized values of each parameter group are shown in the supplementary material at the end of this manual.

●Data Groups for Initialization

Display	Initialized Data
All	All currently selected data (page memory, setup, keyboard patch, chord 1/2, sound patch, timbre assigned to parts 1—6, rhythm set)
Jump Page	The jump destination displays assigned to the BANK and NUMBER buttons
Setup	All setup data
Keyboard Patch	All data of the currently selected keyboard patch
Chord[1]	The chord set assigned to chord 1
Chord[2]	The chord set assigned to chord 2
Sound Patch	All data of the currently selected sound
Part1	All data of part 1
:	:
Part6	All data of part 6
Rhythm Part	All data of rhythm part
Timbre[1]	The timbre assigned to part 1
:	:
Timbre[6]	The timbre assigned to part 6
Timbre[1—6]	The timbres assigned to parts 1—6
Rhythm Set	The rhythm set assigned to the rhythm part

■ Initialization Procedure

① **DATA** → **CURSOR** (select Utl)

② **ENTER** → **CURSOR** (select Initialize)

③ **ENTER**

```
Data/Utl/Initialize
Initialize █
```

④ Use **VALUE** to select the data group to initialize (refer to the following chart).

⑤ **ENTER**

```
Data/Utl/Initialize
Sure? [VALUE*] / [EXIT]
```

⑥ If you are sure you want to initialize the data, press **VALUE**. (To quit without initializing, press **EXIT**.)

```
Data/Utl/Initialize
Function Complete.
```

↓ and in a short time,

```
Data/Utl/Initialize
Initialize █
```

⑥ Press any play mode select button to return to play mode.

b. MIDI Monitor (Data/Ut1/MIDI Monitor)

The MIDI Monitor function allows you to view data transmission/reception between the U-20 and external MIDI devices.

The MIDI Monitor puts the data received from MIDI IN or the data transmitted from MIDI OUT into a monitoring buffer, and displays it in hexadecimal form. The buffer can hold 256 bytes, and new data will overwrite the old data.

- ① **DATA** → **CURSOR** (select Utl)
- ② **ENTER** → **CURSOR** (select MIDI Monitor)
- ③ **ENTER** (the MIDI Monitor display appears)

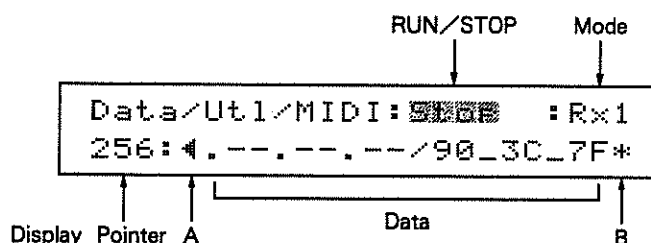

In the MIDI Monitor display, the following parameters will determine how MIDI data is monitored.

● **RUN/STOP**

While this is set to RUN, data will be received into the monitor buffer, and will continue to be received even if you move to another display. When this is set to STOP, data reception will stop.

- ④ Use **LEFT CURSOR** to make the RUN/STOP indication blink.
- ⑤ Press **VALUE** **UP** for RUN, press **VALUE** **DOWN** for STOP.

● **Mode (Rx1, Rx2, Tx)**

This determines how data will be received into the monitor buffer.

Rx1 : All incoming MIDI data will be monitored

Rx2 : All incoming MIDI data except for realtime messages will be monitored

Tx : All transmitted MIDI data will be monitored

- ④ Use **CURSOR** to make the mode indication blink.
- ⑤ Use **VALUE** **DOWN** **VALUE** **UP** to select the monitoring mode.

* When you change the monitoring mode, all data in the buffer will be cleared.

* Realtime messages are used mainly to synchronize sequencers and rhythm machines. Active sensing is included in realtime messages.

SUPPLEMENTARY MATERIAL

1. Error and other Messages	152
2. Troubleshooting	154
3. Operation Map	156
4. Parameter List	158
5. Factory Setting	162
6. Preset Tone List	166
7. Initialized Settings	170
8. Blank Charts	173
MIDI Implementation	178
Main Specifications	193
Index	194

1. Error and other Messages

If there has been some mistake in operation, or if it was not possible to correctly execute the specified operation, an error message will appear in the display. A message will also appear on other occasions when some unusual condition occurs. Determine what the problem is, and take the appropriate action.

●When the power is turned on

Internal Battery Low!

Problem :

The internal backup battery has run down.

Action :

Contact a Roland service station.

●When using a RAM card or PCM card

Checking PCM Card...

When you insert or remove a PCM card, this message will appear and operation will briefly halt. (This is normal.)

It's a New RAM Card.
Initialize it? [ENTER]

Problem :

The RAM card inserted into the RAM card slot has not been initialized for use by the U-20.

Action 1 :

If the RAM card is new or if you want to use a RAM card from another device for the U-20, press **[ENTER]**. The RAM card will be initialized, and internal memory data will be written into it. Please use M-256E RAM cards.

Action 2 :

If you have mistakenly inserted the wrong card, remove it immediately.

Data/*****
RAM Card Protected.

Problem :

The protect switch of the RAM card is On, and writing is not possible.

Action :

Turn the protect switch of the RAM card Off, and try the operation again.

Data/*****
Card Not Ready.

Problem :

When writing, saving or loading, the data was not correctly written into the RAM card.

Action :

Make sure that the RAM card is correctly inserted, and try the operation again.

Data/*****
RAM Card Verify Error!

RAM Card Battery Low!

Problem :

The battery of the RAM card has run down.

Action :

Replace the battery according to the instructions in the RAM card manual.

Illegal PCM Card!
Please, take it out.

Problem :

The card inserted into the PCM card slot is not a PCM card.

Action :

Immediately remove the card from the PCM card slot.

●When using external MIDI devices

Receiving Exclusive.

Cause :

Exclusive data is being received. (If the exclusive data being received is very short, this message will not appear.)

Action :

Wait until reception ends.

Transmitting Exclusive.

Cause :

Exclusive data is being transmitted. (If the exclusive data being transmitted is very short, this message will not appear.)

Action :

When transmission ends, the display will show "Function Complete", and then return to the previous display.

SysEx Check Sum Error!

Problem :

System exclusive data was incorrectly received.

Action :

Check MIDI cables and the message that was transmitted, and try the operation again.

SysEx Data Length Error!

●When in Data Mode (other than the above)

Data/*****
Sure? [VALUE▲] / [EXIT]

Cause :

This message will always be displayed when you write data into internal memory or a RAM card.

Action 1 :

If you are sure you want to write the data into memory, press **VALUE** .

Action 2 :

To quit without writing data into memory, press **EXIT**.

Data/*****
Function Complete.

Cause :

The write, save, or load operation has been completed.

Action :

Wait for a short time until the previous display appears.

2. Troubleshooting

■ No sound or not enough volume

● No sound or not enough volume in ROM play mode

- Is **VOLUME** too low?

Adjust the volume settings of the U-20 and the mixer/amp system.

- Are the outputs connected correctly?

If you hear sound in the headphones, the problem is probably in the amp or cable. Check the connections.

● No sound or not enough volume in modes other than ROM play

- Are the key range and velocity range settings correct for each Part?

(☞ page 95)

- Are the Part or Timbre levels too low?

(☞ page 51, 61)

- Has control change data been received from external MIDI devices or controllers, causing Part level or Timbre level settings to be lowered?

Select (or re-select) a Sound Patch.

- Is the PCM card containing the specified tone inserted correctly?

(☞ page 60)

● No sound or not enough volume in Link Play, Keyboard Patch, or Sound Patch modes

- Does the Tx channel of the keyboard match the Tx channel of each Part?

Check these settings in the sub-display of Sound Patch mode.

(☞ page 122)

- Is local control turned Off?

(☞ page 108)

■ Pitch is incorrect

- Is the keyboard transposed?
(☞ page 29)
- Is the master tuning incorrect?
(☞ page 23)
- Is the pitch shift setting for each Timbre incorrect?
(☞ page 63)
- Has pitch bender data been received, leaving the pitch “hanging” at some non-zero value?
Move the bender lever slight, and the pitch will return to normal.

■ Sounds are not selected as you expect

- Is the correct play mode selected?
To select Sound Patches, you must be in Link Play mode or Sound Patch mode. To select Timbres, you must be in Part Play mode.
- Are you in Edit mode or Data mode?
Press a play mode select button to enter play mode.
- Is the Patch Dump switch On?
If the Patch Dump switch is On, Patch changes will be slightly slower. Normally you will leave this switch Off.
(☞ page 107)

■ MIDI data from a sequencer is not received correctly

- Is the Rx channel of each Part set correctly?
Check these settings in the sub-display of Sound Patch mode.
(☞ page 122)
- Are the key range and velocity range of each Part set correctly?
(☞ page 95)
- Is the voice reserve function set appropriately?
(☞ page 117)

3. Operation Map

■ Edit Mode

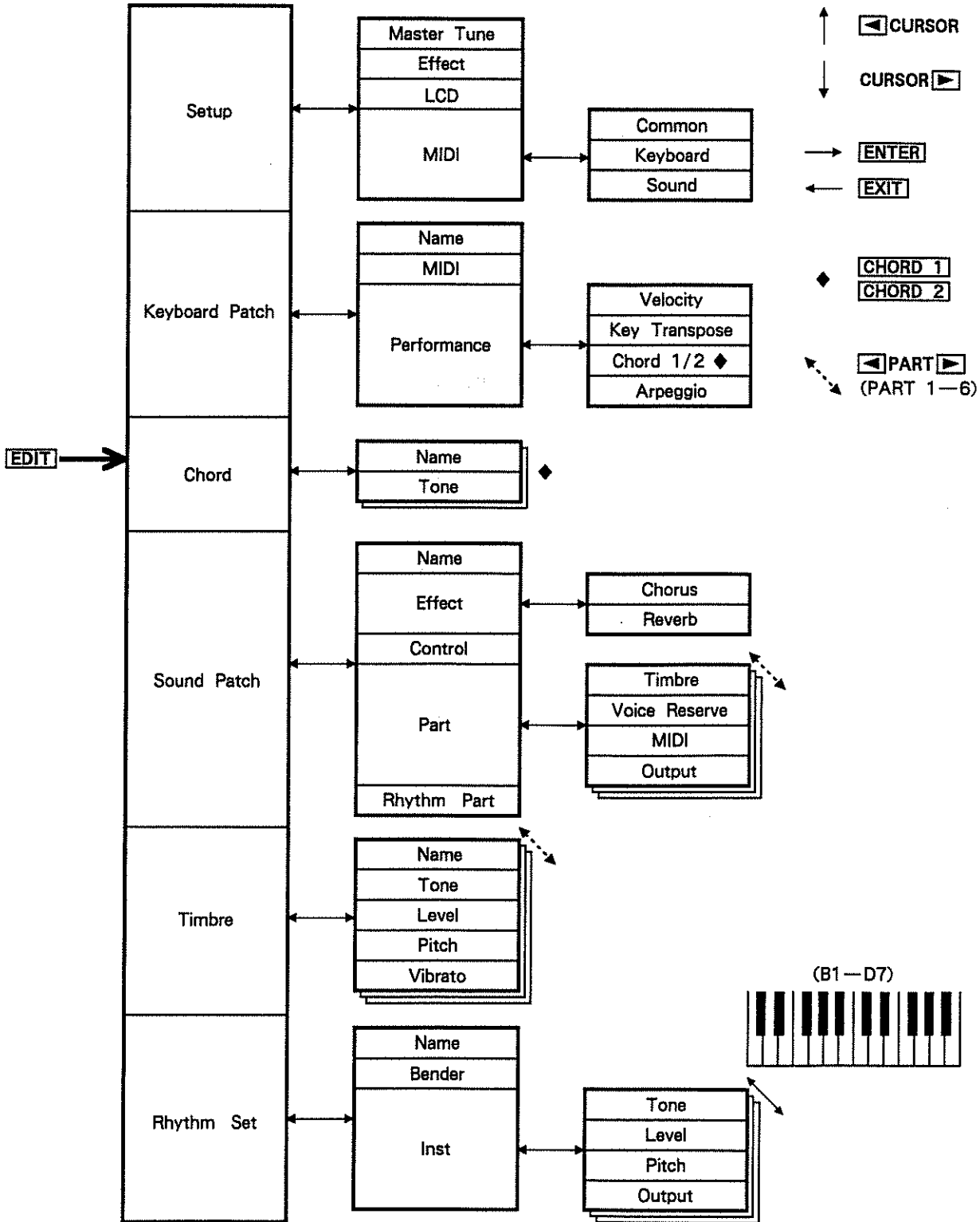

■ Data Mode

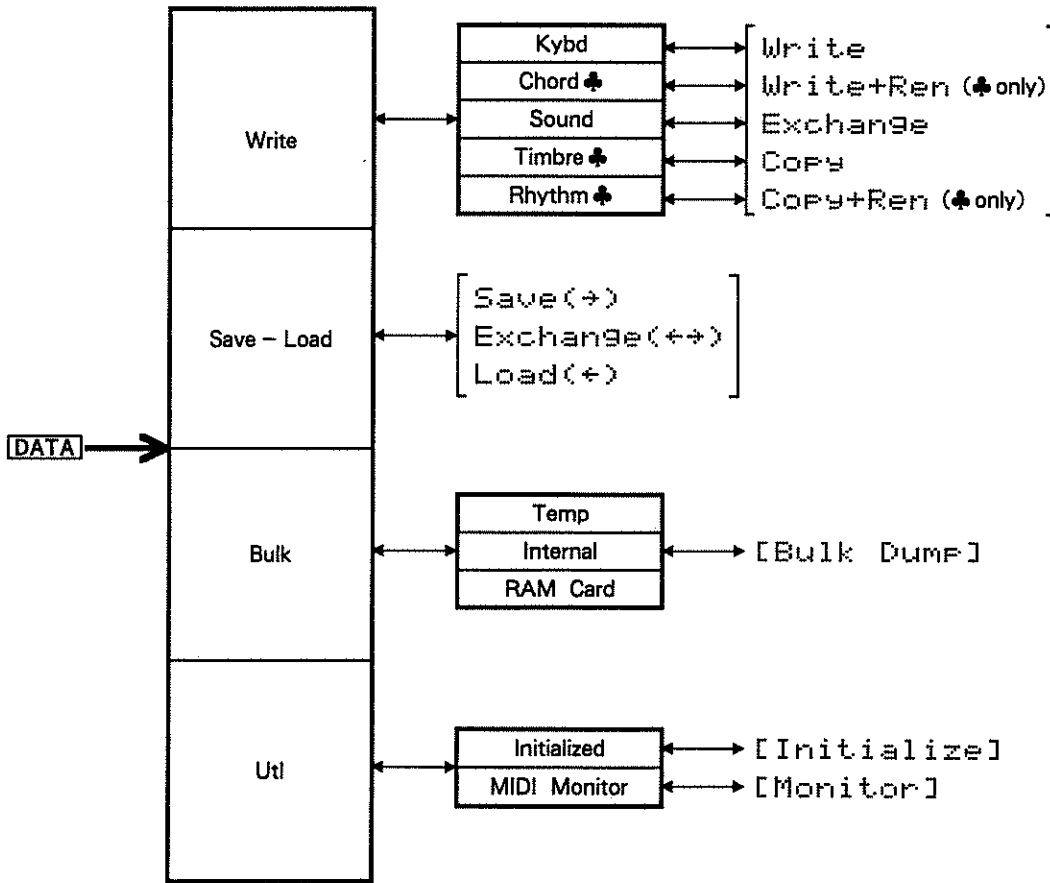
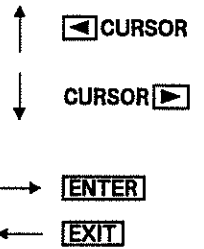

Execute : [ENTER] → VALUE []

Quit : [EXIT]

4. Parameter List

■ Setup

Parameter Group		Parameter	Setting Range
M.Tune		Master Tuning	427.4—452.9 Hz
Effect		Chorus Switch	Off, On
		Reverb Switch	Off, On
LCD		LCD Contrast	0—15
MIDI	Common	Local Control	Off, On
		Device ID	1—32
		Patch Dump Switch	Off, On
		Rx Exclusive Switch	Off, On
	Kybd	Rx Control Channel	1—16, Off
		Tx Setup Channel	1—16
		Tx Control Change Switch	Off, On
		Tx Program Change Switch	Off, On
		Tx Channel Aftertouch Switch	Off, On
	Sound	Tx Active Sensing Switch	Off, On
		Rx Control Channel	1—16, Off
	Rx Timbre Change Switch	Off, On	

■ Keyboard Patch

Parameter Group		Parameter	Setting Range	
Name		Keyboard Patch Name (12 Characters)	(space) A-Z a~z 0-9 - / + * . : ; = ! " # \$ % & ' () < > { } [] _ ? ♪	
MIDI	Tx Channel		1—16, Set	
	Tx Arpeggio Channel		1—16, Set, Tx	
	Tx Control Channel		1—16, Set, Tx	
	Tx Program Change Number		1—128, P.N, Off	
	EXT Control	Channel	Tx Ch, Tx Ctrl Ch	
		Control Number	0—5, 7—31, 64—95, Off	
	C1 Control	Channel	Tx Ch, Tx Ctrl Ch	
		Control Number	0—5, 7—31, 64—95, Off	
	C2 Control	Channel	Tx Ch, Tx Ctrl Ch	
		Control Number	0—5, 7—31, 64—95, Off	
Perform	Velo	Offset	1—127	
		Sensitivity	0—127	
	Trans ♣	Key Transpose	-36—+36	
	Chord ♣	Chord (1/2)	Chord Set Select	1—8
			Key Offset	0—11
			Retrigger Mode	Off, Low, Hi
	Arpe ♣	Arpeggio Type	Up, Down, Up & Down, Random	
Arpeggio Rate		0—127		

♣ : Can be turned on/off by panel buttons, and memorized.

■ Sound Patch

Parameter Group		Parameter	Setting Range
Name		Sound Patch Name (12 Characters)	(space) A~Z a~z 0~9 - / + * . , ; = ! " # \$ % & ' () < > { } [] _ ? ♪
Effect	Chorus	Chorus/Flanger Type	Chorus1, Chorus2, FB-Chorus, Flanger, Short Delay
		Output Mode	Pre Rev, Post Rev
		Chorus/Flanger Level ♥	0—31
		Delay Time	0—31
		Chorus/Flanger Rate ♥	0—31
		Chorus/Flanger Depth	0—31
		Feedback ♥	- 31 — + 31
	Reverb	Reverb/Delay Type	Room1—3, Hall1, 2 Gate, Delay, Cross Delay
		Reverb/Delay Time	0—31
		Reverb/Delay Level ♥	0—31
Feedback ♥		0—31	
Ctrl	Prm1	Control Number	0—5, 7—31, 64—95, Off
		Parameter Select	See * 1
	Prm2	Control Number	0—5, 7—31, 64—95, Off
		Parameter Select	See * 1
	Prm3	Control Number	0—5, 7—31, 64—95, Off
		Parameter Select	See * 1
Part1—6	Timbre	Timbre Select	A11—A88, B11—B88
	V.Rsv	Voice Reserve	0—30 See * 2
	MIDI	Rx Channel	1—16, Off
		Key Range	C-1—G9
		Velocity Range	1—127
		Rx Volume Switch	Off, On
		Rx Pan Switch	Off, On
		Rx Hold Switch	Off, On
	Output	Output Assign	Dry, Rev, Cho, Dir
		Part Level	0—127
Pan		7 > — > < — < 7, Rnd	
R.Part	Rhythm Set Select	1—4	
	Voice Reserve	0—30	
	Rx Channel	1—16, Off	
	Part Level	0—127	
	Level Boost Switch	Off, On	
	Rx Volume Switch	Off, On	
	Rx Hold Switch	Off, On	

* 1 Parameters (Sound Patch, Timbre) indicated by ♥ can be controlled.

* 2 Voice reserve settings for Parts 1—6 and the Rhythm Part must total 30 or less.

4. Parameter List

■ Timbre

Parameter Group	Parameter	Setting Range
Name	Timbre Name (12 Characters)	(space) A-Z a-z 0-9 - / + * . , : = ! " # \$ % & ' () () [] _ ? `
Tone	Tone Select	1, 1—31 — 1—128
Level	Timbre Level ♥	0—127
	Velocity Sensitivity	-7—+7
	Channel Aftertouch Sensitivity	-7—+7
	Env Attack Rate ♥	-7—+7
	Env Decay Rate ♥	-7—+7
	Env Sustain Level ♥	-7—+7
	Env Release Rate ♥	-7—+7
Pitch	Pitch Shift Coarse	-24—+24
	Pitch Shift Fine	-50—+50
	Bender Range (Bend Down)	-36, -24, -12—0
	Bender Range (Bend Up)	0—12
	Channel Aftertouch Sensitivity	-36, -24, -12—+12
	Polyphonic Aftertouch Sensitivity	-36, -24, -12—+12
	Auto Bend Depth ♥	-36, -24, -12—+12
	Auto Bend Rate ♥	0—15
	Detune Depth ♥	0—15
Vib	Rate ♥	0—63
	Waveform ♥	Tri ,Sine, Square, SawUp, SawDwn, Trill1, Trill2, Randm1—4
	Depth ♥	0—15
	Delay Time ♥	0—15
	Rise Time ♥	0—15
	Modulation Lever Depth ♥	0—15
	Channel Aftertouch Sensitivity	0—15
	Polyphonic Aftertouch Sensitivity	0—15

♥: These parameters can be controlled using Control Change data. In the Sound Patch, specify the parameters you want to control.

■ Rhythm Set

Parameter Group		Parameter	Setting Range
Name		Rhythm Set Name (12 Characters)	(space) A-Z a-z 0-9 - / + * . , ; ; = ! " # \$ % & ' () () { } [] _ ? ♪
Bender		Bender Range (Bend Down)	-36, -24, -12—±0
		Bender Range (Bend Up)	0—12
Inst (B1—D7)	Tone	Tone Select	1, 1—31 - 1—128
		Source Key	C-1—G9
		Mute	Off, B1—D7
	Level	Level	0—31
		Velocity Sensitivity	-7—+7
		Env Mode	Sustain, No Sustain
		Env Attack Rate	-7—+7
		Env Decay Rate	-7—+7
		Env Release Rate	-7—+7
	Pitch	Pitch Shift Coarse	-36, -24, -12—+12
		Pitch Shift Fine	-50—+50
		Channel Aftertouch Sensitivity	-36, -24, -12—+12
		Polyphonic Aftertouch Sensitivity	-36, -24, -12—+12
		Pitch Randomize	0—15
		Auto Bend Depth	-36, -24, -12—+12
		Auto Bend Rate	0—15
	Output	Detune Depth	0—15
		Output Assign	Dry, Rev, Cho, Dir
		Pan	7>—><—<7, Rnd

■ Chord Set

Parameter Group		Parameter	Setting Range
Name		Chord Set Name (12 Characters)	(space) A-Z a-z 0-9 - / + * . , ; ; = ! " # \$ % & ' () () { } [] _ ? ♪
Note (C, C#—B)		Chord (Up to 8 notes)	A chord played on the keyboard

■ Sound Patch

() : Timbre number

BANK 1		BANK 2		BANK 3		BANK 4		BANK 5		BANK 6		BANK 7		BANK 8	
Piano, Mallet		Guitar, Organ		Strings, Choir		Bass		Wind		D – Sound		Pad&Solo		Sound Effect	
11	Acoust Piano (A11)	21	A.Guitar (A23)	31	Strings (A36)	41	Slap Bass (A46)	51	Soft Trumpet (A58)	61	Fantasia (B11)	71	Endymion (B31, B32)	81	Native Dance (B52, B53, B54, B55, B56)
12	Chorus Piano (A13)	22	E.Guitar (A24)	32	Syn. Strings (A37)	42	FlangingSlap (A47)	52	Trombone (A61)	62	Calliope (B12, B13)	72	Prelude (B33, B34)	82	Percs Hit (B57, B58, B61)
13	E.Piano (A14)	23	Heavy Guitar (A25)	33	JP8, Strings (A38)	43	FingeredBass (A48)	53	BrassSection (A62)	63	Soundtrack (B14, B15, B16)	73	Jupiters (B35, B36)	83	Velo Combi (A11, A42, A34)
14	Bright EP (A16)	24	E.Organ 1 (A26)	34	Choir (A41)	44	FrilessBass (A52)	54	Saxophone (A63)	64	Atmosphere (B17, B18)	74	Selene (B37, B38)	84	Spilt Combi (B88, A18, A33, A61, A78, A87)
15	Vibraphone (A17)	25	E.Organ 3 (A27)	35	Syn. Vox 1 (A42)	45	Acoust Bass (A53, A46)	55	JP8, Brass (A64, A65)	65	Future Pad (B21, B22)	75	Sacred Tree (B41, B42)	85	Rotor Craft (B62, B63, B64)
16	Marimba (A18)	26	E.Organ 7 (A31)	36	Syn. Vox 2 (A43)	46	Synth Bass 5 (A55)	56	Power Brass (A66, A67)	66	Pomona (B23, B24)	76	Macho Lead (B43, B44)	86	Emergency (B65, B66, B67, B68, B71)
17	Bell (A21)	27	E.Organ 9 (A32)	37	Syn. Choir 1 (A44)	47	Synth Bass 6 (A56)	57	Flute (A71)	67	Melodigan (B25, B26)	77	Lunar Lead (B45, B46)	87	Deepsea (B72, B73, B74)
18	Fanta Bell (A22)	28	Mad Organ (A33)	38	Syn. Choir 2 (A45)	48	Synth Bass 7 (A57)	58	Shakuhachi (A72)	68	Photogene (B27, B28)	78	HarmonicLead (B47, B48, B51)	88	Catastrophe (B75, B76, B77, B78, B81)

5. Factory Setting

■ Timbre

() : Tone number

A Group		B Group	
11	A.PIano 2 (1-002)	21	Bell (1-022)
12	A.PIano 4 (1-004)	22	Fanta Bell (1-112)
13	A.PIano 10 (1-010)	23	A.Guitar 1 (1-024)
14	E.PIano 1 (1-011)	24	E.Guitar 1 (1-029)
15	E.PIano 5 (1-015)	25	Heavy Guitar (1-033)
16	Bright EP (1-017)	26	E.Organ 1 (1-070)
17	Vib 1 (1-018)	27	E.Organ 3 (1-072)
18	Marimba (1-023)	28	E.Organ 5 (1-074)
11	Fantasia (1-095)	21	Future 1 (1-100)
12	Calliope 1 (1-102)	22	Future 2 (1-012)
13	Calliope 2 (1-125)	23	Pomona 1 (1-115)
14	Soundtrack 1 (1-118)	24	Pomona 2 (1-118)
15	Soundtrack 2 (1-118)	25	Melodigan 1 (1-126)
16	Soundtrack 3 (1-118)	26	Melodigan 2 (1-018)
17	Atmosphere 1 (1-026)	27	Photogene 1 (1-015)
18	Atmosphere 2 (1-107)	28	Photogene 2 (1-012)
31	E.Organ 7 (1-076)	41	Choir 3 (1-064)
32	E.Organ 9 (1-078)	42	Syn.Vox 1 (1-099)
33	R.Organ 2 (1-080)	43	Syn.Vox 2 (1-100)
34	Strings 1 (1-066)	44	Syn.Choir (1-097)
35	Strings 3 (1-068)	45	Syn.Choir 2 (1-012)
36	String Pad 2 (1-109)	46	Slap 1 (1-035)
37	JP.Strings (1-110)	47	Slap 7 (1-041)
38	Choir 1 (1-062)	48	Fingered 1 (1-047)
31	Endymion 1 (1-116)	41	Sacred 1 (1-110)
32	Endymion 2 (1-110)	42	Sacred 2 (1-099)
33	Prelusion 1 (1-099)	43	Macho 1 (1-119)
34	Prelusion 2 (1-096)	44	Macho 2 (1-119)
35	JP8.Brass (1-105)	45	Lunar 1 (1-116)
36	JP8.Strings (1-110)	46	Lunar 2 (1-116)
37	Selene 1 (1-100)	47	Harmonic 1 (1-116)
38	Selene 2 (1-126)	48	Harmonic 2 (1-118)
51	Picked 1 (1-049)	61	TP / TRB 1 (1-083)
52	Fretless 2 (1-052)	62	Brass 1 (1-091)
53	Ac.Bass (1-053)	63	Sax 1 (1-087)
54	Syn.Bass 4 (1-057)	64	Synth Brs 1 (1-105)
55	Syn.Bass 5 (1-058)	65	Synth Brs 2 (1-104)
56	Syn.Bass 6 (1-059)	66	PowerBrass 1 (1-104)
57	Syn.Bass 7 (1-060)	67	PowerBrass 2 (1-104)
58	Soft TP 1 (1-081)	68	JP.Brass 2 (1-106)
51	Harmonic 3 (1-115)	61	Percs Hit 3 (1-124)
52	Native 1 (1-125)	62	Rotor 1 (1-122)
53	Native 2 (1-027)	63	Rotor 2 (1-024)
54	Native 3 (1-127)	64	Rotor 3 (1-112)
55	Native 4 (1-126)	65	Emergency 1 (1-120)
56	Native 5 (1-126)	66	Emergency 2 (1-120)
57	Percs Hit 1 (1-122)	67	Emergency 3 (1-125)
58	Percs Hit 2 (1-023)	68	Emergency 4 (1-125)
71	Flute 1 (1-092)	81	Pulsewave1 (1-116)
72	Shaku 1 (1-093)	82	Pulsewave2 (1-117)
73	Bell Pad (1-096)	83	Pulsewaves3 (1-118)
74	Breath Vox (1-098)	84	Saw Wave 1 (1-119)
75	Pizzagogo (1-111)	85	Saw Wave 2 (1-120)
76	Spect Bell (1-113)	86	Metal (1-122)
77	Bell Drum (1-114)	87	SingingPiano (1-005)
78	Synth Harp (1-115)	88	Syn.Marimba (1-023)
71	Emergency 5 (1-125)	81	Catastrophes (1-068)
72	Deep 1 (1-127)	82	Pizz (1-121)
73	Deep 2 (1-113)	83	Breath (1-123)
74	Deep 3 (1-114)	84	Nails (1-124)
75	Catastrophe1 (1-115)	85	Spectrum 1 (1-125)
76	Catastrophe2 (1-115)	86	Spectrum 2 (1-126)
77	Catastrophe3 (1-125)	87	N.Dance (1-127)
78	Catastrophe4 (1-099)	88	Drums (1-128)

■ Rhythm Set

1 : Standard Set

		Output	
		Pan	Output Assign
	Instrument		
C3	35	Bass Drum 1	>< Dry
	36	Bass Drum 2	>< Dry
	37	Rim Shot	>< Rev
	38	Snare Drum 1	>< Rev
	39	Hand Clap	2> Rev
	40	Snare Drum 2	>< Rev
	41	Low Tom Tom 1	6> Rev
	42	Closed H.H 1 ☆	<2 Rev
	43	Low Tom Tom 2	6> Rev
	44	Open H.H 2 ☆	<2 Rev
C3	45	Mid Tom Tom 1	>< Rev
	46	Open H.H 1 ☆	<2 Rev
	47	Mid Tom Tom 2	>< Rev
	48	Hi Tom Tom 1	<4 Rev
	49	Crash Cymbal	<2 Rev
	50	Hi Tom Tom 2	<4 Rev
	51	Ride Cymbal	4> Rev
	52	China Cymbal	6> Rev
	53	Cup (mute)	4> Rev
	54	Tambourine ☆	4> Rev
C4	55	Splash Cymbal	>< Rev
	56	Cowbell	2> Rev
	57	Crash Cymbal	<2 Rev
	58	Snare Drum 3	>< Rev
	59	Ride Cymbal	4> Rev
	60	Bongo - H ☆	<4 Rev
	61	Bongo - L ☆	<2 Rev
	62	Conga (mute) ☆	2> Rev
	63	Conga - H ☆	2> Rev
	64	Conga - L ☆	4> Rev
C5	65	Timbale - H ☆	<2 Rev
	66	Timbale - L ☆	<4 Rev
	67	Agogo - H ☆	4> Rev
	68	Agogo - L ☆	4> Rev
	69	Cabasa	2> Rev
	70	Maracas ☆	<2 Rev
	71	Short Whistle ☆	2> Rev
	72	Long Whistle ☆	2> Rev
	73	Vibra - Slap ☆	4> Rev
	74	Bell Tree ☆	4> Rev
C6	75	Claves ☆	6> Rev
	76	Guiro 2 ☆☆	>< Rev
	77	Guiro 1 ☆☆	>< Rev
	78	Castanets ☆	<4 Rev
	79	Hi Pitch Tom 2	<2 Rev
	80	Triangle ☆	>< Rev
	81	Hi pitch Tom 1	<6 Rev
	82	Wood Block ☆	7> Rev
	83	Jingle Bell ☆	<2 Rev
	C7	84	Bass Drum 3
85		Bass Drum 4	>< Dry
86		Snare Drum 4	>< Rev
87		Snare Drum 5	>< Rev
88		Snare Drum 6	>< Rev
89		Low Tom Tom 3	4> Rev
90		Closed H.H 2	<2 Rev
91		Mid Tom Tom 3	<4 Rev
92		China Cymbal	<2 Rev
93		Hi Tom Tom 3	2> Rev
C7	94	Ride Cymbal	4> Rev
	95	Native Drum - 1 ☆	<4 Rev
	96	Native Drum - 2 ☆	<2 Rev
	97	Native Drum - 3 ☆	>< Rev
	98	-----	>< Rev

1 : Standard Set

A standard drum set.

2 : Dry Set

The output assign of drums for all keys is "Dry" (no effect).

3 : Electric Set

A drum set with mainly electric toms and gated snare drums.

4 : F.X. Set

A drum set with mainly sound effects.

☆ : Mute Setting

Key	Instrument	Mute
F # 2 (42)	Closed H.H 1	A # 2
G # 2 (44)	Open H.H 2	A # 2
A # 2 (46)	Open H.H 1	G # 2
E5 (76)	Guiro 2	F5
F5 (77)	Guiro 1	E5

☆ : PCM card tones are assigned to these keys. A PCM card (SN-U110-02) must be inserted. (Common to all Rhythm Sets 1-4).

■ Chord Set

C C# D D# E F F# G G# A A# B

#1. Diatonic

Cmaj7 D#maj7 (C#maj7) Dm7 E#maj7 (D#maj7) Em7 Fmaj7 G#maj7 (F#maj7) G7 A#maj7 Am7 B#maj7 (A#maj7) Bm7-6

#2. Suspended 4th

C#sus4 C#sus4 Dsus4 D#sus4 Esus4 F#sus4 G#sus4 G#sus4 Asus4 B#sus4 (A#sus4) B#sus4

#3. Minor 7

Cm7 C#m7 Dm7 D#m7 Em7 Fm7 F#m7 Gm7 G#m7 Am7 B#m7 (A#m7) Bm7

#4. Church

#5. Diatonic 3rd

#6. Diminish

Cdim C#dim Ddim D#dim Edim Fdim F#dim Gdim G#dim Adim A#dim Bdim

#7. Ethnic

#8. Reverse

C G F G F

6. Preset Tone List

No.	Tone Name	Tone Type	Remarks
Piano			
1	A.PIANO 1	V - MIX	Soft
2	A.PIANO 2	V - MIX	
3	A.PIANO 3	V - MIX	Bright
4	A.PIANO 4	V - MIX	Honky-tonk
5	A.PIANO 5	SINGLE	Soft
6	A.PIANO 6	DETUNE	Soft
7	A.PIANO 7	SINGLE	Hard
8	A.PIANO 8	DETUNE	Hard
9	A.PIANO 9	SINGLE	Hard and bright
10	A.PIANO 10	DETUNE	Hard and bright
11	E.PIANO 1	V - MIX	Soft + hard
12	E.PIANO 2	SINGLE	Soft
13	E.PIANO 3	DETUNE	Soft
14	E.PIANO 4	SINGLE	Hard
15	E.PIANO 5	DETUNE	Hard
16	BRIGHT EP1	SINGLE	
17	BRIGHT EP2	DETUNE	
Vibraphone			
18	VIB 1	SINGLE	Soft
19	VIB 2	DETUNE	Soft
20	VIB 3	V - MIX	Soft + hard
Bell			
21	BELL 1	SINGLE	Long decay
22	BELL 2	DETUNE	Long decay
Marimba			
23	MARIMBA	SINGLE	
Guitar			
24	A.GUITAR 1	SINGLE	
25	A.GUITAR 2	DETUNE	
26	A.GUITAR 3	DUAL	
27	A.GUITAR 4	DUAL	Added lower octave
28	A.GUITAR 5	V - SW	Slow attack/fast attack (v = 100)
29	E.GUITAR 1	V - SW	Muted/unmuted (v = 100)
30	E.GUITAR 2	SINGLE	Muted
31	E.GUITAR 3	SINGLE	
32	E.GUITAR 4	DETUNE	
33	HEAVY.EG 1	SINGLE	Combination fifths
34	HEAVY.EG 2	DETUNE	Combination fifths
Bass			
35	SLAP 1	SINGLE	Thumped, pulled, harmonics (E2, F # 4)
36	SLAP 2	DETUNE	Thumped, pulled, harmonics (E2, F # 4)
37	SLAP 3	SINGLE	Thumped, pulled, harmonics (B2, F # 4)
38	SLAP 4	DETUNE	Thumped, pulled, harmonics (B2, F # 4)
39	SLAP 5	V - SW	Thumped/pulled (v = 100), harmonics (F # 4)
40	SLAP 6	V - SW	Slow attack/fast attack (v = 100), harmonics (F # 4)
41	SLAP 7	SINGLE	Thumped, pulled, harmonics (B2, C # 4)
42	SLAP 8	DETUNE	Thumped, pulled, harmonics (B2, C # 4)
43	SLAP 9	SINGLE	Thumped, pulled, harmonics (B2, C # 4)
44	SLAP 10	DETUNE	Thumped, pulled, harmonics (B2, C # 4)
45	SLAP 11	V - SW	Thumped/pulled (v = 100), harmonics (C # 4)
46	SLAP 12	V - SW	Slow attack/fast attack (v = 100), harmonics (C # 4)

No.	Tone Name	Tone Type	Remarks
Bass			
47	FINGERED 1	SINGLE	Fingered, harmonics (C # 5)
48	FINGERED 2	DETUNE	Fingered, harmonics (C # 5)
49	PICKED 1	SINGLE	
50	PICKED 2	DETUNE	
51	FRETLESS 1	SINGLE	Fretless, harmonics (D # 6)
52	FRETLESS 2	DETUNE	Fretless, harmonics (D # 6)
53	AC.BASS	V - MIX	Added fret noise
54	SYN.BASS 1	V - MIX	Soft + hard
55	SYN.BASS 2	SINGLE	Soft
56	SYN.BASS 3	SINGLE	Hard
57	SYN.BASS 4	SINGLE	
58	SYN.BASS 5	SINGLE	
59	SYN.BASS 6	SINGLE	
60	SYN.BASS 7	SINGLE	
61	SYN.BASS 8	V - MIX	
Choir			
62	CHOIR 1	SINGLE	Long decay
63	CHOIR 2	SINGLE	Short decay
64	CHOIR 3	DUAL	Long decay, added lower octave
65	CHOIR 4	DUAL	Short decay, added lower octave
Strings			
66	STRINGS 1	SINGLE	Long decay
67	STRINGS 2	SINGLE	Short decay
68	STRINGS 3	DUAL	Long decay, added lower octave
69	STRINGS 4	DUAL	Short decay, added lower octave
Organ			
70	E.ORGAN 1	SINGLE	
71	E.ORGAN 2	DETUNE	
72	E.ORGAN 3	SINGLE	
73	E.ORGAN 4	DETUNE	
74	E.ORGAN 5	SINGLE	
75	E.ORGAN 6	DETUNE	
76	E.ORGAN 7	SINGLE	
77	E.ORGAN 8	DETUNE	
78	E.ORGAN 9	DUAL	
79	R.ORGAN 1	DUAL	
80	R.ORGAN 2	DUAL	
Wind			
81	SOFT TP 1	SINGLE	
82	SOFT TP 2	DETUNE	
83	TP/TRB 1	SINGLE	
84	TP/TRB 2	SINGLE	Soft
85	TP/TRB 3	SINGLE	Bright
86	SAX 1	SINGLE	
87	SAX 2	SINGLE	Soft
88	SAX 3	SINGLE	Bright
89	SAX 4	DETUNE	
90	SAX 5	DUAL	Added lower octave
91	BRASS 1	SINGLE	
92	FLUTE 1	SINGLE	
93	SHAKU 1	SINGLE	
94	SHAKU 2	DETUNE	

6. Preset Tone List

No.	Tone Name	Tone Type	Remarks
Synthesizer			
95	FANTASIA	DUAL	
96	BELL PAD	DUAL	
97	SYN CHOIR	SINGLE	
98	BREATH VOX	DUAL	
99	SYN.VOX 1	SINGLE	
100	SYN.VOX 2	SINGLE	
101	L.CALLIOPE	DUAL	
102	CALLIOPE	SINGLE	
103	METAL HIT	DUAL	
104	RICH BRASS	SINGLE	
105	JP.BRASS 1	SINGLE	
106	JP.BRASS 2	SINGLE	
107	BRASTRINGS	DUAL	
108	STRINGPAD1	SINGLE	
109	STRINGPAD2	DUAL	
110	JP.STRINGS	SINGLE	
111	PIZZAGOGO	DUAL	
112	FANTA BELL	SINGLE	
113	SPECT BELL	DUAL	
114	BELL DRUM	DUAL	
115	SYNTH HARP	SINGLE	
116	PULSEWAVE1	SINGLE	
117	PULSEWAVE2	SINGLE	
118	PULSEWAVE3	SINGLE	
119	SAW WAVE 1	SINGLE	
120	SAW WAVE 2	SINGLE	
121	PIZZ	SINGLE	
122	METAL	SINGLE	
123	BREATH	SINGLE	
124	NAILS	SINGLE	
125	SPECTRUM 1	SINGLE	
126	SPECTRUM 2	SINGLE	
127	N.DANCE	SINGLE	
Drums			
128	DRUMS	SINGLE	Refer to the drums list

* (note name) = split point (v =) = velocity threshold

● Drums List

		Tone Name
C2	35	Bass Drum 1
	36	Bass Drum 2
	37	Rim Shot
	38	Snare Drum 1
	39	Hand Clap
	40	Snare Drum 2
	41	Low Tom Tom 1
	42	Closed High Hat 1
	43	Low Tom Tom 2
	44	Open High Hat 2
C3	45	Middle Tom Tom 1
	46	Open High Hat 1
	47	Middle Tom Tom 2
	48	High Tom Tom 1
	49	Crash Cymbal
	50	High Tom Tom 2
	51	Ride Cymbal
	52	China Cymbal
	53	Cup (Mute)
	54	Off
C4	55	Off
	56	Cowbell
	57	Crash Cymbal
	58	Snare Drum 3
	59	Ride Cymbal
	60	Off
	61	Off
	62	Off
	63	Off
	64	Off
C5	65	Off
	66	Off
	67	Off
	68	Off
	69	Cabasa
	70	Off
	71	Off
	72	Off
	73	Off
	74	Off
C6	75	Off
	76	Off
	77	Off
	78	Off
	79	High Pitch Tom Tom 2
	80	Off
	81	High Pitch Tom Tom 1
	82	Off
	83	Off
	84	Bass Drum 3
C7	85	Bass Drum 4
	86	Snare Drum 4
	87	Snare Drum 5
	88	Snare Drum 6
	89	Low Tom Tom 3
	90	Closed High Hat 2
	91	Middle Tom Tom 3
	92	China Cymbal
	93	High Tom Tom 3
	94	Ride Cymbal
95	Off	
96	Off	

7. Initialized Settings

For the initialization procedure, see page 147.

■ Setup

Parameter Group	Parameter	Value	
M.Tune	Master Tune	440.0 Hz	
Effect	Chorus Sw	On	
	Reverb Sw	On	
LCD	LCD Contrast	10	
MIDI	Common	Local Control	On
		SysEx Device ID	17
		SysEx Patch Dump Sw	Off
		Rx SysEx	Off
	Kybd	Rx Control Ch	Off
		Tx Setup Ch	1
		Tx Control Change Sw	On
		Tx Program Change Sw	On
		Tx Ch Aftertouch Sw	On
	Sound	Tx Active Sensing Sw	On
		Rx Control Ch	16
		Rx Timbre Change Sw	Off

■ Keyboard Patch

Parameter Group	Parameter	Value	
Name	Keyboard Patch Name	Standard	
MIDI	Tx Ch	Set	
	Tx Arpeggio Ch	Tx	
	Tx Control Ch	Tx	
	Tx Program Change #	P.N	
	EXT, C1, C2	Ch Ctrl #	Tx Ch Off
Velo	Offset	1	
	Sensitivity	127	
Trans ★	Key Transpose	-12	
Chord ★	Chord 1	Chord Set #	1
		Key Offset	0
		Retrigger Mode	Hi
	Chord 2	Chord Set #	2
		Key Offset	0
		Retrigger Mode	Hi
Arpe ★	Arpeggio Type	Up & Down	
	Arpeggio Rate	100	

★ : These functions are turned Off.

■ Sound Patch

Parameter Group	Parameter	Value	
Name	Sound Patch Name	Acoust Piano	
Effect	Chorus	Output Mode	Pre Rev
		Chorus Level	25
		Chorus Type	Chorus1
		Delay Time	12
		Chorus Rate	25
		Chorus Depth	5
	Reverb	Feedback	0
		Reverb Type	Hall1
		Reverb Time	0
		Reverb Level	6
	Delay FB	0	
Ctrl	Prm1	Ctrl #	Off
		Parameter	Timbre Level
	Prm2	Ctrl #	Off
		Parameter	Timbre Level
	Prm3	Ctrl #	Off
		Parameter	Timbre Level
Part1—6	Timbre	Timbre #	A11
	V.Rsv	Voice Reserve	0
	MIDI	Rx Ch	1 (Parts 2—6 are Off)
		Key Range	C-1 – G9
		Velocity Range	1 – 127
		Rx Volume	On
		Rx Pan	On
		Rx Hold	On
	Output	Output Assign	Rev
		Part Level	127
Pan		>< (Parts 2—6 omitted)	
R.Part	Rhythm Set #	1	
	Voice Reserve	0	
	Rx Ch	10	
	Part Level	127	
	Level Boost	Off	
	Rx Volume	On	
	Rx Hold	On	

■ Timbre

Parameter Group	Parameter	Value
Name	Timbre Name	A.Piano 2
Tone	Tone #	I - 2
Level	Timbre Level	127
	Velocity Sensitivity	+ 7
	Ch Aftertouch Sens	0
	Env Attack Rate	0
	Env Decay Rate	0
	Env Sustain Level	0
Pitch	Env Release Rate	0
	Pitch Shift Coarse	0
	Pitch Shift Fine	0
	Bender Range (Down)	- 2
	Bender Range (Up)	2
	Ch Aftertouch Sens	0
	Poly Aftertouch Sens	0
	Auto Bend Depth	0
Auto Bend Rate	15	
Detune Depth	5	
Vib	Rate	50
	Waveform	Tri
	Depth	0
	Delay Time	0
	Rise Time	0
	Modulation Depth	8
	Ch Aftertouch Sens	0
	Poly Aftertouch Sens	0

■ Rhythm Set

Parameter	Value
Rhythm Set Name	Standard Set
Bender Range (Down)	- 12
Bender Range (Up)	12

Inst B1 - D7

Tone # : Name	Refer to following table
Source Key	
Mute	
Inst Level	31
Velocity Sensitivity	+ 7
Env Mode	No Sustain
Env Attack Rate	0
Env Decay Rate	0 (G3 is + 2)
Env Release Rate	0
Pitch Shift Coarse	0 (G3 is 12)
Pitch Shift Fine	0
Ch Aftertouch Sens	0
Poly Aftertouch Sens	0
Pitch Randomize	0
Auto Bend Depth	0
Auto Bend Rate	0
Detune Depth	0
Output Assign	Refer to following table
Pan	

■ Chord Set

C C# D D# E F F# G G# A A# B

Chord[1] Diatonic

Chord[1] Diatonic

Cmaj7 D[♯]maj7 (C[♯]maj7) Dm7 E[♯]maj7 (D[♯]maj7) Em7 Fmaj7 G[♯]maj7 (F[♯]maj7) G7 A[♯]maj7 Am7 B[♯]maj7 (A[♯]maj7) Bm7⁻⁵

Chord[2] Suspended 4th

Chord[2] Suspended 4th

Csus4 C[♯]sus4 Dsus4 D[♯]sus4 Esus4 Fsus4 F[♯]sus4 Gsus4 G[♯]sus4 Asus4 B[♯]sus4 (A[♯]sus4) Bsus4

7. Initialized Settings

		Inst				
		Tone			Output	
		Tone # : Name	Source Key	Mute	Pan	Output Assign
C3	35	1-128 : DRUMS	B 1 : Bass Drum 1	off	><	Dry
	36	1-128 : DRUMS	C 2 : Bass Drum 2	off	><	Dry
	37	1-128 : DRUMS	C # 2 : Rim Shot	off	><	Rev
	38	1-128 : DRUMS	D 2 : Snare Drum 1	off	><	Rev
	39	1-128 : DRUMS	D # 2 : Hand Clap	off	2>	Rev
	40	1-128 : DRUMS	E 2 : Snare Drum 2	off	><	Rev
	41	1-128 : DRUMS	F 2 : Low Tom Tom 1	off	6>	Rev
	42	1-128 : DRUMS	F # 2 : Closed H.H 1	A # 2	<2	Rev
	43	1-128 : DRUMS	G 2 : Low Tom Tom 2	off	6>	Rev
	44	1-128 : DRUMS	G # 2 : Open H.H 2	A # 2	<2	Rev
C3	45	1-128 : DRUMS	A 2 : Mid Tom Tom 1	off	><	Rev
	46	1-128 : DRUMS	A # 2 : Open H.H 1	G # 2	<2	Rev
	47	1-128 : DRUMS	B 2 : Mid Tom Tom 2	off	><	Rev
	48	1-128 : DRUMS	C 3 : Hi Tom Tom 1	off	<4	Rev
	49	1-128 : DRUMS	C # 3 : Crash Cymbal	off	<2	Rev
	50	1-128 : DRUMS	D 3 : Hi Tom Tom 2	off	<4	Rev
	51	1-128 : DRUMS	D # 3 : Ride Cymbal	off	4>	Rev
	52	1-128 : DRUMS	E 3 : China Cymbal	off	6>	Rev
	53	1-128 : DRUMS	F 3 : Cup (mute)	off	4>	Rev
	54	2-002 : LATIN 2	F # 3 : Tambourine	off	4>	Rev
C4	55	1-128 : DRUMS	C # 3 : Splash Cymbal	off	><	Rev
	56	1-128 : DRUMS	G # 3 : Cowbell	off	2>	Rev
	57	1-128 : DRUMS	A 3 : Crash Cymbal	off	<2	Rev
	58	1-128 : DRUMS	A # 3 : Snare Drum 3	off	><	Rev
	59	1-128 : DRUMS	B 3 : Ride Cymbal	off	4>	Rev
	60	2-002 : LATIN 2	C 4 : Bongo - H	off	<4	Rev
	61	2-002 : LATIN 2	C # 4 : Bongo - L	off	<2	Rev
	62	2-002 : LATIN 2	D 4 : Conga (mute)	off	2>	Rev
	63	2-002 : LATIN 2	D # 4 : Conga - H	off	2>	Rev
	64	2-002 : LATIN 2	E 4 : Conga - L	off	4>	Rev
C5	65	2-002 : LATIN 2	F 4 : Timbale - H	off	<2	Rev
	66	2-002 : LATIN 2	F # 4 : Timbale - L	off	<4	Rev
	67	2-002 : LATIN 2	G 4 : Agogo - H	off	4>	Rev
	68	2-002 : LATIN 2	G # 4 : Agogo - L	off	4>	Rev
	69	1-128 : DRUMS	A 4 : Cabasa	off	2>	Rev
	70	2-002 : LATIN 2	A # 4 : Maracas	off	<2	Rev
	71	2-002 : LATIN 2	B 4 : Short Whistle	off	2>	Rev
	72	2-002 : LATIN 2	C 5 : Long Whistle	off	2>	Rev
	73	2-002 : LATIN 2	C # 5 : Vibra - Slap	off	4>	Rev
	74	2-002 : LATIN 2	D 5 : Bell Tree	off	4>	Rev
C6	75	2-002 : LATIN 2	D # 5 : Claves	off	6>	Rev
	76	2-028 : GUIRO 2	A # 4 : Guiro 2	F 5	><	Rev
	77	2-027 : GUIRO 1	F 5 : Guiro 1	E 5	><	Rev
	78	2-002 : LATIN 2	F # 5 : Castanets	off	<4	Rev
	79	1-128 : DRUMS	G 5 : Hi Pitch Tom 2	off	<2	Rev
	80	2-002 : LATIN 2	G # 5 : Triangle	off	><	Rev
	81	1-128 : DRUMS	A 5 : Hi pitch Tom 1	off	<6	Rev
	82	2-002 : LATIN 2	A # 5 : Wood Block	off	7>	Rev
	83	2-002 : LATIN 2	B 5 : Jingle Bell	off	<2	Rev
	84	1-128 : DRUMS	C 6 : Bass Drum 3	off	><	Dry
C7	85	1-128 : DRUMS	C # 6 : Bass Drum 4	off	><	Dry
	86	1-128 : DRUMS	D 6 : Snare Drum 4	off	><	Rev
	87	1-128 : DRUMS	D # 6 : Snare Drum 5	off	><	Rev
	88	1-128 : DRUMS	E 6 : Snare Drum 6	off	><	Rev
	89	1-128 : DRUMS	F 6 : Low Tom Tom 3	off	4>	Rev
	90	1-128 : DRUMS	F # 6 : Closed H.H 2	off	<2	Rev
	91	1-128 : DRUMS	G 6 : Mid Tom Tom 3	off	<4	Rev
	92	1-128 : DRUMS	G # 6 : China Cymbal	off	<2	Rev
	93	1-128 : DRUMS	A 6 : Hi Tom Tom 3	off	2>	Rev
	94	1-128 : DRUMS	A # 6 : Ride Cymbal	off	4>	Rev
95	2-002 : LATIN 2	B 6 : Native Drum - 1	off	<4	Rev	
96	2-002 : LATIN 2	C 7 : Native Drum - 2	off	<2	Rev	
97	2-002 : LATIN 2	C # 7 : Native Drum - 3	off	><	Rev	
98	1-128 : DRUMS	D 7 : -----	off	><	Rev	

8. Blank Charts

Date _____

■ Setup

M.Tune	Master Tune	Hz		
Effect	Chorus	Off	On	
	Reverb	Off	On	
LCD	LCD Contrast			
MIDI	Common	Local Control		
		SysEx Device ID		
		SysEx Patch Dump	Off	On
		Rx SysEx	Off	On
	Kybd	Rx Control Ch		
		Tx Setup Ch		
		Tx Control Change	Off	On
		Tx Program Change	Off	On
		Tx Ch Aftertouch	Off	On
	Sound	Tx Active Sensing	Off	On
		Rx Control Ch		
		Rx Timbre Change	Off	On

■ Rhythm Set # : Name :

Bender (Down)	
Bender (Up)	
Inst # :	
Tone # : Name	- :
Source Key	
Mute	
Level	
Velocity	
Env Mode	
Env Attack	
Env Decay	
Env Release	
Pitch Coarse	
Pitch Fine	
Ch Aftertouch	
Poly Aftertouch	
Pitch Random	
A. Bend Depth	
A. Bend Rate	
Detune Depth	
Output Assign	
Pan	

■ Keyboard Patch # : Name :

MIDI	Tx Ch		
	Tx Arpeggio Ch		
	Tx Control Ch		
	Tx Program Change #		
	EXT Ctrl	Ch	
		Ctrl #	
	C1 Ctrl	Ch	
		Ctrl #	
	C2 Ctrl	Ch	
		Ctrl #	

Perform	Velo	Offset		
		Sensitivity		
	Trans	Key Transpose		
	Chord	Chord 1	Chord Set #	
			Key Offset	
		Chord 2	Retrigger	
			Chord Set #	
	Arpe	Key Offset		
		Retrigger		
	Arpe	Type		
		Rate		
	Key Transpose		Off	On
Chord		1	2	
Arpeggio		Off	On	

Date _____

■ Sound Patch # : _____ Name : _____

Effect	Chorus	Type	
		Output Mode	
		Level	
		Delay Time	
		Rate	
		Depth	
		Feedback	
	Reverb	Type	
		Time	
		Level	
Delay FB			
Ctrl	Prm1	Ctrl #	
		Parameter	
	Prm2	Ctrl #	
		Parameter	
	Prm3	Ctrl #	
		Parameter	

Part		1	2	3	4	5	6
Timbre	Timbre #						
V.Rsv	Voice Reserve						
MIDI	Rx Ch						
	Key Range	-	-	-	-	-	-
	Velocity Range	-	-	-	-	-	-
	Rx Volume	Off, On	Off, On	Off, On	Off, On	Off, On	Off, On
	Rx Pan	Off, On	Off, On	Off, On	Off, On	Off, On	Off, On
	Rx Hold	Off, On	Off, On	Off, On	Off, On	Off, On	Off, On
Output	Output Assign						
	Level						
	Pan						

Rhythm Part	Rhythm Set #	
	Voice Reserve	
	Rx Ch	
	Level	
	Level Boost	Off, On
	Rx Volume	Off, On
	Rx Hold	Off, On

Date _____

■ Timbre # :		Name :																																																			
<table border="1" style="width:100%; border-collapse: collapse;"> <tr><td colspan="2">Tone #</td></tr> <tr><td style="width: 10px;">Level</td><td>Timbre Level</td></tr> <tr><td></td><td>Velocity</td></tr> <tr><td></td><td>Ch Aftertouch</td></tr> <tr><td></td><td>Env Attack</td></tr> <tr><td></td><td>Env Decay</td></tr> <tr><td></td><td>Env Sustain</td></tr> <tr><td></td><td>Env Release</td></tr> </table>	Tone #		Level	Timbre Level		Velocity		Ch Aftertouch		Env Attack		Env Decay		Env Sustain		Env Release	<table border="1" style="width:100%; border-collapse: collapse;"> <tr><td style="width: 10px;">Pitch</td><td>Pitch Coarse</td></tr> <tr><td></td><td>Pitch Fine</td></tr> <tr><td></td><td>Bender Range (Down)</td></tr> <tr><td></td><td>Bender Range (Up)</td></tr> <tr><td></td><td>Ch Aftertouch</td></tr> <tr><td></td><td>Poly Aftertouch</td></tr> <tr><td></td><td>A. Bend Depth</td></tr> <tr><td></td><td>A. Bend Rate</td></tr> <tr><td></td><td>Detune Depth</td></tr> </table>	Pitch	Pitch Coarse		Pitch Fine		Bender Range (Down)		Bender Range (Up)		Ch Aftertouch		Poly Aftertouch		A. Bend Depth		A. Bend Rate		Detune Depth	<table border="1" style="width:100%; border-collapse: collapse;"> <tr><td style="width: 10px;">Vib</td><td>Rate</td></tr> <tr><td></td><td>Waveform</td></tr> <tr><td></td><td>Depth</td></tr> <tr><td></td><td>Delay Time</td></tr> <tr><td></td><td>Rise Time</td></tr> <tr><td></td><td>Mod. Depth</td></tr> <tr><td></td><td>Ch Aftertouch</td></tr> <tr><td></td><td>Poly Aftertouch</td></tr> </table>	Vib	Rate		Waveform		Depth		Delay Time		Rise Time		Mod. Depth		Ch Aftertouch		Poly Aftertouch	
Tone #																																																					
Level	Timbre Level																																																				
	Velocity																																																				
	Ch Aftertouch																																																				
	Env Attack																																																				
	Env Decay																																																				
	Env Sustain																																																				
	Env Release																																																				
Pitch	Pitch Coarse																																																				
	Pitch Fine																																																				
	Bender Range (Down)																																																				
	Bender Range (Up)																																																				
	Ch Aftertouch																																																				
	Poly Aftertouch																																																				
	A. Bend Depth																																																				
	A. Bend Rate																																																				
	Detune Depth																																																				
Vib	Rate																																																				
	Waveform																																																				
	Depth																																																				
	Delay Time																																																				
	Rise Time																																																				
	Mod. Depth																																																				
	Ch Aftertouch																																																				
	Poly Aftertouch																																																				

■ Timbre # :		Name :																																																			
<table border="1" style="width:100%; border-collapse: collapse;"> <tr><td colspan="2">Tone #</td></tr> <tr><td style="width: 10px;">Level</td><td>Timbre Level</td></tr> <tr><td></td><td>Velocity</td></tr> <tr><td></td><td>Ch Aftertouch</td></tr> <tr><td></td><td>Env Attack</td></tr> <tr><td></td><td>Env Decay</td></tr> <tr><td></td><td>Env Sustain</td></tr> <tr><td></td><td>Env Release</td></tr> </table>	Tone #		Level	Timbre Level		Velocity		Ch Aftertouch		Env Attack		Env Decay		Env Sustain		Env Release	<table border="1" style="width:100%; border-collapse: collapse;"> <tr><td style="width: 10px;">Pitch</td><td>Pitch Coarse</td></tr> <tr><td></td><td>Pitch Fine</td></tr> <tr><td></td><td>Bender Range (Down)</td></tr> <tr><td></td><td>Bender Range (Up)</td></tr> <tr><td></td><td>Ch Aftertouch</td></tr> <tr><td></td><td>Poly Aftertouch</td></tr> <tr><td></td><td>A. Bend Depth</td></tr> <tr><td></td><td>A. Bend Rate</td></tr> <tr><td></td><td>Detune Depth</td></tr> </table>	Pitch	Pitch Coarse		Pitch Fine		Bender Range (Down)		Bender Range (Up)		Ch Aftertouch		Poly Aftertouch		A. Bend Depth		A. Bend Rate		Detune Depth	<table border="1" style="width:100%; border-collapse: collapse;"> <tr><td style="width: 10px;">Vib</td><td>Rate</td></tr> <tr><td></td><td>Waveform</td></tr> <tr><td></td><td>Depth</td></tr> <tr><td></td><td>Delay Time</td></tr> <tr><td></td><td>Rise Time</td></tr> <tr><td></td><td>Mod. Depth</td></tr> <tr><td></td><td>Ch Aftertouch</td></tr> <tr><td></td><td>Poly Aftertouch</td></tr> </table>	Vib	Rate		Waveform		Depth		Delay Time		Rise Time		Mod. Depth		Ch Aftertouch		Poly Aftertouch	
Tone #																																																					
Level	Timbre Level																																																				
	Velocity																																																				
	Ch Aftertouch																																																				
	Env Attack																																																				
	Env Decay																																																				
	Env Sustain																																																				
	Env Release																																																				
Pitch	Pitch Coarse																																																				
	Pitch Fine																																																				
	Bender Range (Down)																																																				
	Bender Range (Up)																																																				
	Ch Aftertouch																																																				
	Poly Aftertouch																																																				
	A. Bend Depth																																																				
	A. Bend Rate																																																				
	Detune Depth																																																				
Vib	Rate																																																				
	Waveform																																																				
	Depth																																																				
	Delay Time																																																				
	Rise Time																																																				
	Mod. Depth																																																				
	Ch Aftertouch																																																				
	Poly Aftertouch																																																				

■ Timbre # :		Name :																																																			
<table border="1" style="width:100%; border-collapse: collapse;"> <tr><td colspan="2">Tone #</td></tr> <tr><td style="width: 10px;">Level</td><td>Timbre Level</td></tr> <tr><td></td><td>Velocity</td></tr> <tr><td></td><td>Ch Aftertouch</td></tr> <tr><td></td><td>Env Attack</td></tr> <tr><td></td><td>Env Decay</td></tr> <tr><td></td><td>Env Sustain</td></tr> <tr><td></td><td>Env Release</td></tr> </table>	Tone #		Level	Timbre Level		Velocity		Ch Aftertouch		Env Attack		Env Decay		Env Sustain		Env Release	<table border="1" style="width:100%; border-collapse: collapse;"> <tr><td style="width: 10px;">Pitch</td><td>Pitch Coarse</td></tr> <tr><td></td><td>Pitch Fine</td></tr> <tr><td></td><td>Bender Range (Down)</td></tr> <tr><td></td><td>Bender Range (Up)</td></tr> <tr><td></td><td>Ch Aftertouch</td></tr> <tr><td></td><td>Poly Aftertouch</td></tr> <tr><td></td><td>A. Bend Depth</td></tr> <tr><td></td><td>A. Bend Rate</td></tr> <tr><td></td><td>Detune Depth</td></tr> </table>	Pitch	Pitch Coarse		Pitch Fine		Bender Range (Down)		Bender Range (Up)		Ch Aftertouch		Poly Aftertouch		A. Bend Depth		A. Bend Rate		Detune Depth	<table border="1" style="width:100%; border-collapse: collapse;"> <tr><td style="width: 10px;">Vib</td><td>Rate</td></tr> <tr><td></td><td>Waveform</td></tr> <tr><td></td><td>Depth</td></tr> <tr><td></td><td>Delay Time</td></tr> <tr><td></td><td>Rise Time</td></tr> <tr><td></td><td>Mod. Depth</td></tr> <tr><td></td><td>Ch Aftertouch</td></tr> <tr><td></td><td>Poly Aftertouch</td></tr> </table>	Vib	Rate		Waveform		Depth		Delay Time		Rise Time		Mod. Depth		Ch Aftertouch		Poly Aftertouch	
Tone #																																																					
Level	Timbre Level																																																				
	Velocity																																																				
	Ch Aftertouch																																																				
	Env Attack																																																				
	Env Decay																																																				
	Env Sustain																																																				
	Env Release																																																				
Pitch	Pitch Coarse																																																				
	Pitch Fine																																																				
	Bender Range (Down)																																																				
	Bender Range (Up)																																																				
	Ch Aftertouch																																																				
	Poly Aftertouch																																																				
	A. Bend Depth																																																				
	A. Bend Rate																																																				
	Detune Depth																																																				
Vib	Rate																																																				
	Waveform																																																				
	Depth																																																				
	Delay Time																																																				
	Rise Time																																																				
	Mod. Depth																																																				
	Ch Aftertouch																																																				
	Poly Aftertouch																																																				

8. Blank Charts

Date _____

■ Rhythm Set # : Name : Bender ▼ : ▲ :									
	Tone			Level		Pitch		Output	
	Tone # : Name	Source	Mute	Level	Velo	Coarse	Fine	Assign	Pan
C2	35								
	36	37							
	38								
	40	39							
	41	42							
	43	44							
	45	46							
C3	47								
	48	49							
	50								
	52	51							
	53	54							
	55	56							
	57	58							
C4	59								
	60	61							
	62	63							
	64								
	65	66							
	67	68							
	69	70							
C5	71								
	72	73							
	74	75							
	76								
	77	78							
	79	80							
	81	82							
C6	83								
	84	85							
	86	87							
	88								
	89	90							
	91	92							
	93	94							
C7	95								
	96	97							
	98								

Date _____

■ Jump

BANK 1: _____

.....

NUMBER 1: _____

.....

BANK 2: _____

.....

NUMBER 2: _____

.....

BANK 3: _____

.....

NUMBER 3: _____

.....

BANK 4: _____

.....

NUMBER 4: _____

.....

BANK 5: _____

.....

NUMBER 5: _____

.....

BANK 6: _____

.....

NUMBER 6: _____

.....

BANK 7: _____

.....

NUMBER 7: _____

.....

BANK 8: _____

.....

NUMBER 8: _____

.....

Roland Exclusive Messages

1 Data Format for Exclusive Messages

Roland's MIDI implementation uses the following data format for all exclusive messages (type IV):

Byte	Description
FOH	Exclusive status
41H	Manufacturer ID (Roland)
DEV	Device ID
MDL	Model ID
CMD	Command ID
[BODY]	Main data
F7H	End of exclusive

MIDI status : FOH, F7H

An exclusive message must be flanked by a pair of status codes, starting with a Manufacturer-ID immediately after FOH (MIDI version 1.0).

Manufacturer - ID : 41H

The Manufacturer-ID identifies the manufacturer of a MIDI instrument that triggers an exclusive message. Value 41H represents Roland's Manufacturer-ID.

Device - ID : DEV

The Device-ID contains a unique value that identifies the individual device in the multiple implementation of MIDI instruments. It is usually set to 00H - 0FH, a value smaller by one than that of a basic channel, but value 00H - 1FH may be used for a device with multiple basic channels.

Model - ID : MDL

The Model-ID contains a value that uniquely identifies one model from another. Different models, however, may share an identical Model-ID if they handle similar data.

The Model-ID format may contain 00H in one or more places to provide an extended data field. The following are examples of valid Model-IDs, each representing a unique model:

01H
02H
03H
00H, 01H
00H, 02H
00H, 00H, 01H

Command - ID : CMD

The Command-ID indicates the function of an exclusive message. The Command-ID format may contain 00H in one or more places to provide an extended data field. The following are examples of valid Command-IDs, each representing a unique function:

01H
02H
03H
00H, 01H
00H, 02H
00H, 00H, 01H

Main data : BODY

This field contains a message to be exchanged across an interface. The exact data size and contents will vary with the Model-ID and Command-ID.

2 Address - mapped Data Transfer

Address mapping is a technique for transferring messages conforming to the data format given in Section 1. It assigns a series of memory-resident records -- waveform and tone data, switch status, and parameters, for example -- to specific locations in a machine-dependent address space, thereby allowing access to data residing at the address a message specifies.

Address-mapped data transfer is therefore independent of models and data categories. This technique allows use of two different transfer procedures: one-way transfer and handshake transfer.

One-way transfer procedure (See Section 3 for details.)

This procedure is suited for the transfer of a small amount of data. It sends out an exclusive message completely independent of a receiving device status.

Connection Diagram

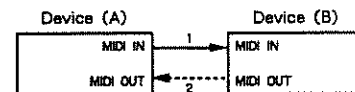

Connection at point 2 is essential for "Request data" procedures. (See Section 3.)

Handshake - transfer procedure (See Section 4 for details.)

This procedure initiates a predetermined transfer sequence (handshaking) across the interface before data transfer takes place. Handshaking ensures that reliability and transfer speed are high enough to handle a large amount of data.

Connection Diagram

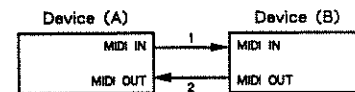

Connection at points 1 and 2 is essential.

Notes on the above two procedures

- *There are separate Command-IDs for different transfer procedures.
- *Devices A and B cannot exchange data unless they use the same transfer procedure, share identical Device-ID and Model ID, and are ready for communication.

3 One-way Transfer Procedure

This procedure sends out data all the way until it stops and is used when the messages are so short that answerbacks need not be checked.

For long messages, however, the receiving device must acquire each message in time with the transfer sequence, which inserts intervals of at least 20 milliseconds in between.

Types of Messages

Message	Command ID
Request data 1	RQ1 (11H)
Data set 1	DT1 (12H)

Request data # 1 : RQ1 (11H)

This message is sent out when there is a need to acquire data from a device at the other end of the interface. It contains data for the address and size that specify designation and length, respectively, of data required.

On receiving an RQ1 message, the remote device checks its memory for the data address and size that satisfy the request.

If it finds them and is ready for communication, the device will transmit a "Data set 1 (DT1)" message, which contains the requested data. Otherwise, the device will send out nothing.

Byte	Description
FOH	Exclusive status
41H	Manufacturer ID (Roland)
DEV	Device ID
MDL	Model ID
11H	Command ID
aaH	Address MSB
.....
	LSB
asH	Size MSB
.....
	LSB
sum	Check sum
F7H	End of exclusive

*The size of the requested data does not indicate the number of bytes that will make up a DT1 message, but represents the address fields where the requested data resides.

*Some models are subject to limitations in data format used for a single transaction. Requested data, for example, may have a limit in length or must be divided into predetermined address fields before it is exchanged across the interface.

*The same number of bytes comprises address and size data, which, however, vary with the Model-ID.

*The error checking process uses a checksum that provides a bit pattern where the least significant 7 bits are zero when values for an address, size, and that checksum are summed.

Data set 1: DT1 (12H)

This message corresponds to the actual data transfer process. Because every byte in the data is assigned a unique address, a DT1 message can convey the starting address of one or more data as well as a series of data formatted in an address-dependent order.

The MIDI standards inhibit non-real time messages from interrupting an exclusive one. This fact is inconvenient for the devices that support a "soft-through" mechanism. To maintain compatibility with such devices, Roland has limited the DT1 to 256 bytes so that an excessively long message is sent out in separate segments.

Byte	Description
FOH	Exclusive
41H	Manufacturer ID (Roland)
DEV	Device ID
MDL	Model ID
12H	Command ID
aaH	Address MSB
.....
ddH	LSB
.....
sum	Data
.....
F7H	Check sum
	End of exclusive

*A DT1 message is capable of providing only the valid data among those specified by an RQ1 message.

*Some models are subject to limitations in data format used for a single transaction. Requested data, for example, may have a limit in length or must be divided into predetermined address fields before it is exchanged across the interface.

*The number of bytes comprising address data varies from one Model-ID to another.

*The error checking process uses a checksum that provides a bit pattern where the least significant 7 bits are zero when values for an address, size, and that checksum are summed.

Example of Message Transactions

● Device A sending data to Device B
Transfer of a DT1 message is all that takes place.

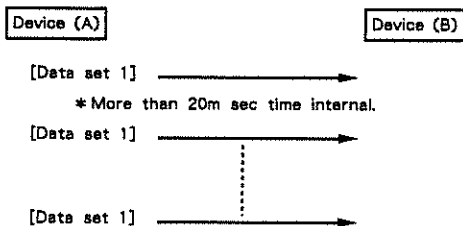

● Device B requesting data from Device A
Device B sends an RQ1 message to Device A. Checking the message, Device A sends a DT1 message back to Device B.

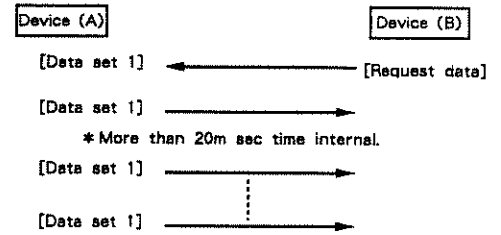

4. Handshake - Transfer Procedure

Handshaking is an interactive process where two devices exchange error checking signals before a message transaction takes place, thereby increasing data reliability. Unlike one-way transfer that inserts a pause between message transactions, handshake transfer allows much speedier transactions because data transfer starts once the receiving device returns a ready signal.

When it comes to handling large amounts of data -- sampler waveforms and synthesizer tones over the entire range, for example -- across a MIDI interface, handshaking transfer is more efficient than one-way transfer.

Types of Messages

Message	Command ID
Want to send data	WSD (40H)
Request data	RQD (41H)
Data set	DAT (42H)
Acknowledge	ACK (43H)
End of data	EOD (45H)
Communication error	ERR (4EH)
Rejection	RJC (4FH)

Want to send data: WSD (40H)

This message is sent out when data must be sent to a device at the other end of the interface. It contains data for the address and size that specify designation and length, respectively, of the data to be sent.

On receiving a WSD message, the remote device checks its memory for the specified data address and size which will satisfy the request. If it finds them and is ready for communication, the device will return an "Acknowledge (ACK)" message. Otherwise, it will return a "Rejection (RJC)" message.

Byte	Description
FOH	Exclusive status
41H	Manufacturer ID (Roland)
DEV	Device ID
MDL	Model ID
40H	Command ID
aaH	Address MSB
.....
ssH	LSB
.....
ssH	Size MSB
.....
sum	LSB
.....
F7H	Check sum
	End of exclusive

*The size of the data to be sent does not indicate the number of bytes that make up a "Data set (DAT)" message, but represents the address fields where the data should reside.

*Some models are subject to limitations in data format used for a single transaction. Requested data, for example, may have a limit in length or must be divided into predetermined address fields before it is exchanged across the interface.

*The same number of bytes comprises address and size data, which, however, vary with the Model-ID.

*The error checking process uses a checksum that provides a bit pattern where the least significant 7 bits are zero when values for an address, size, and that checksum are summed.

Request data : RQD (41H)

This message is sent out when there is a need to acquire data from a device at the other end of the interface. It contains data for the address and size that specify designation and length, respectively, of data required.

On receiving an RQD message, the remote device checks its memory for the data address and size which satisfy the request. If it finds them and is ready for communication, the device will transmit a "Data set (DAT)" message, which contains the requested data. Otherwise, it will return a "Rejection (RJC)" message.

Byte	Description
FOH	Exclusive status
41H	Manufacturer ID (Roland)
DEV	Device ID
MDL	Model ID
41H	Command ID
aaH	Address MSB
⋮	⋮
saH	LSB
saH	Size MSB
⋮	⋮
sum	LSB
sum	Check sum
F7H	End of exclusive

*The size of the requested data does not indicate the number of bytes that make up a "Data set (DAT)" message, but represents the address fields where the requested data resides.

*Some models are subject to limitations in data format used for a single transaction. Requested data, for example, may have a limit in length or must be divided into predetermined address fields before it is exchanged across the interface.

*The same number of bytes comprises address and size data, which, however, vary with the Model - ID.

*The error checking process uses a checksum that provides a bit pattern where the least significant 7 bits are zero when values for an address, size, and that checksum are summed.

Data set : DAT (42H)

This message corresponds to the actual data transfer process. Because every byte in the data is assigned a unique address, the message can convey the starting address of one or more data as well as a series of data formatted in an address - dependent order.

Although the MIDI standards inhibit non - real time messages from interrupting an exclusive one, some devices support a "soft - through" mechanism for such interrupts. To maintain compatibility with such devices, Roland has limited the DAT to 256 bytes so that an excessively long message is sent out in separate segments.

Byte	Description
FOH	Exclusive status
41H	Manufacturer ID (Roland)
DEV	Device ID
MDL	Model ID
42H	Command ID
aaH	Address MSB
⋮	⋮
ddH	LSB
ddH	Data
⋮	⋮
sum	Check sum
F7H	End of exclusive

*A DAT message is capable of providing only the valid data among those specified by an RQD or WSD message.

*Some models are subject to limitations in data format used for a single transaction. Requested data, for example, may have a limit in length or must be divided into predetermined address fields before it is exchanged across the interface.

*The number of bytes comprising address data varies from one model ID to another.

*The error checking process uses a checksum that provides a bit pattern where the least significant 7 bits are zero when values for an address, size, and that checksum are summed.

Acknowledge : ACK (43H)

This message is sent out when no error was detected on reception of a WSD, DAT, "End of data (EOD)", or some other message and a requested setup or action is complete. Unless it receives an ACK message, the device at the other end will not proceed to the next operation.

Byte	Description
FOH	Exclusive status
41H	Manufacturer ID (Roland)
DEV	Device ID
MDL	Model ID
43H	Command ID
F7H	End of exclusive

End of data : EOD (45H)

This message is sent out to inform a remote device of the end of a message. Communication, however, will not come to an end unless the remote device returns an ACK message even though an EOD message was transmitted.

Byte	Description
FOH	Exclusive status
41H	Manufacturer ID (Roland)
DEV	Device ID
MDL	Model ID
45H	Command ID
F7H	End of exclusive

Communications error : ERR (4EH)

This message warns the remote device of a communication fault encountered during message transmission due, for example, to a checksum error. An ERR message may be replaced with a "Rejection (RJC)" one, which terminates the current message transaction in midstream.

When it receives an ERR message, the sending device may either attempt to send out the last message a second time or terminate communication by sending out an RJC message.

Byte	Description
FOH	Exclusive status
41H	Manufacturer ID (Roland)
DEV	Device ID
MDL	Model ID
4EH	Command ID
F7H	End of exclusive

Rejection: RJC (4FH)

This message is sent out when there is a need to terminate communication by overriding the current message. An RJC message will be triggered when:

- a WSD or RQD message has specified an illegal data address or size.
- the device is not ready for communication.
- an illegal number of addresses or data has been detected.
- data transfer has been terminated by an operator.
- a communications error has occurred.

An ERR message may be sent out by a device on either side of the interface. Communication must be terminated immediately when either side triggers an ERR message.

Byte	Description
FOH	Exclusive status
41H	Manufacturer ID (Roland)
DEV	Device ID
MDL	Model ID
4FH	Command ID
F7H	End of exclusive

Example of Message Transactions

- Data transfer from device (A) to device (B).

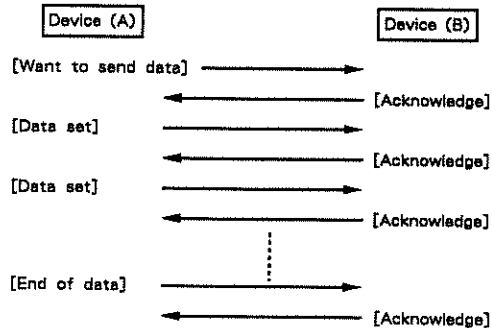

- Device (A) requests and receives data from device (B).

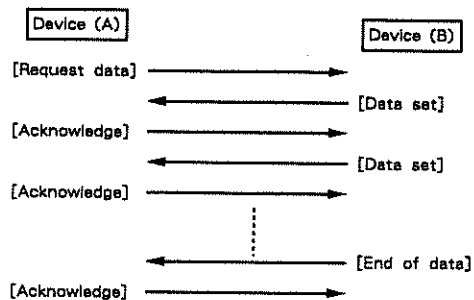

- Error occurs while device (A) is receiving data from device (B).

- 1) Data transfer from device (A) to device (B).

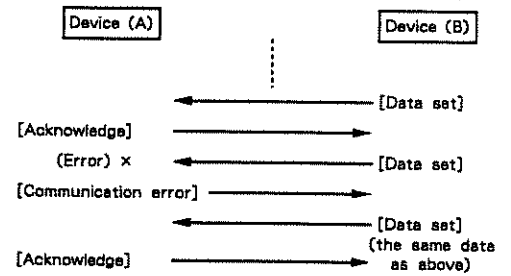

- 2) Device (B) rejects the data re-transmitted, and quits data transfer.

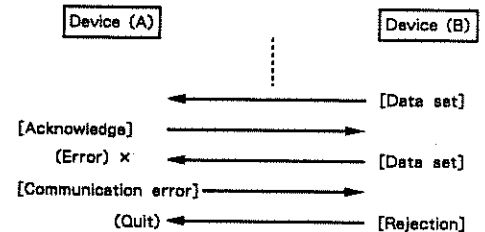

- 3) Device (A) immediately quits data transfer.

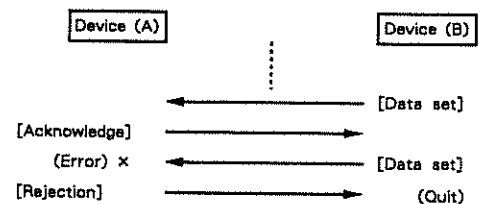

1. TRANSMITTED DATA

Active sensing is always transmitted on condition that Setup/MIDI/Kybd/Tx Active Sensing is "On", and other messages are transmitted in only Keyboard mode, Sound mode or Link mode.

■ Note event**● Note off**

Status	Second	Third
BnH	kkH	vvH
kk = Note number		0H - 7FH (0 - 127)
vv = Velocity		1H - 7FH (1 - 127)
n = MIDI channel No.		0H - FH (1 - 16)

The message is transmitted through 'Kybd/MIDI/Tx Ch'.
The message is transmitted through 'Setup/MIDI/Kybd/Tx Setup Ch' when 'Kybd/MIDI/Tx Ch' is set as 'Set'.

In arpeggio play mode, note messages of arpeggio play are transmitted through 'Kybd/MIDI/Arp Ch'.

The message is transmitted through 'Setup/MIDI/Kybd/Tx Setup Ch' when 'Kybd/MIDI/Arp Ch' is set as 'Tx'.

The message is not transmitted when 'Kybd/MIDI/Arp Ch' is set as 'Off'.

'Kybd/MIDI/Arp Ch' prior to 'Kybd/MIDI/Tx Ch' when they are set as same channel.

● Note on

Status	Second	Third
9nH	kkH	vvH
kk = Note number		0H - 7FH (0 - 127)
vv = Velocity		1H - 7FH (1 - 127)
n = MIDI channel No.		0H - FH (1 - 16)

The message is transmitted through 'Kybd/MIDI/Tx Ch'.
The message is transmitted through 'Setup/MIDI/Kybd/Tx Setup Ch' when 'Kybd/MIDI/Tx Ch' is set as 'Set'.

In arpeggio play mode, note messages of arpeggio play are transmitted through 'Kybd/MIDI/Arp Ch'.

The message is transmitted through 'Setup/MIDI/Kybd/Tx Setup Ch' when 'Kybd/MIDI/Arp Ch' is set as 'Tx'.

The message is not transmitted when 'Kybd/MIDI/Arp Ch' is set as 'Off'.

'Kybd/MIDI/Arp Ch' prior to 'Kybd/MIDI/Tx Ch' when they are set as same channel.

The detected velocity is converted into the transmitted velocity (vvH) which is within the range specified in Kybd/Perform/Velo/Velocity Range.

■ Control change**● Modulation depth**

Status	Second	Third
BnH	01H	vvH
vv = Modulation depth		00H - 7FH (0 - 127)
n = MIDI channel No.		0H - FH (1 - 16)

● Hold

Status	Second	Third
BnH	40H	vvH
vv = 00H (0) : Off		
vv = 7FH (127) : On		
n = MIDI channel No.		0H - FH (1 - 16)

● Ext control, C1, C2

Status	Second	Third
BnH	ccH	vvH

ccH = control number : 0H - 5H (0 - 5), 7H - 1FH (7 - 31), 40H - 5FH (64 - 95)
vvH = control value : 0H - 7FH (0 - 127)
n = MIDI channel No. : 0H - FH (1 - 16)

Control number can be assigned to Ext control, C1 and C2.

The message is not transmitted when 'Setup/MIDI/Kybd/Tx Control Change' is set as 'Off'.

The message is transmitted through 'Kybd/MIDI/Tx Ch'.

The message is transmitted through 'Setup/MIDI/Kybd/Tx Setup Ch' when 'Kybd/MIDI/Tx Ch' is set as 'Set'.

■ Program change

Status	Second
CnH	ppH
pp = Program number	00H - 7FH (0 - 127)
n = MIDI channel No.	0H - FH (1 - 16)

Transmits through 'Kybd/MIDI/Tx Ctrl Ch' when change keyboard patch on the panel.

Program change message is transmitted when [Part▶] button is pressed in edit page of program change number.

The message is transmitted through 'Setup/MIDI/Kybd/Tx Setup Ch' when 'Kybd/MIDI/Tx Ctrl Ch' is set as 'Set'.

The message is transmitted through 'Kybd/MIDI/Tx Ch' when 'Kybd/MIDI/Tx Ctrl Ch' is set as 'Tx'.

Transmitted program number is specified in Kybd/MIDI/Tx Pgm #.

Transmits keyboard patch number when 'Kybd/MIDI/Tx Pgm #' is set as 'P.N'.

But, the message is not transmitted when 'Setup/MIDI/Kybd/Tx Program Change' is set as 'Off' or 'Kybd/MIDI/Pgm #' is set as 'Off'.

■ Channel aftertouch

Status	Second
DnH	vvH
vv = 0 - 7FH (0 - 127)	
n = MIDI channel No.	0H - FH (1 - 16)

The message is transmitted through 'Kybd/MIDI/Tx Ch'.

The message is transmitted through 'Setup/MIDI/Kybd/Tx Setup Ch' when 'Kybd/MIDI/Tx Ch' is set as 'Set'.

The message is not transmitted when 'Kybd/MIDI/Tx Ch Aftertouch' is set as 'Off'.

■ Pitch bender change

Status	Second	Third
EnH	lH	mmH
ll = Lower pitch bender value		00H - 7FH (0 - 127)
mm = Upper pitch bender value		00H - 7FH (0 - 127)
n = MIDI channel No.		0H - FH (1 - 16)

The message is transmitted through 'Kybd/MIDI/Tx Ch'.

The message is transmitted through 'Setup/MIDI/Kybd/Tx Setup Ch' when 'Kybd/MIDI/Tx Ch' is set as 'Set'.

■ Exclusive

Status
FOH : System exclusive
F7H : EOX (End of Exclusive)

A set of various parameter is transmitted, and received using MIDI Exclusive messages

Refer to section 3 and 'Roland Exclusive Messages' for details.

■ Active sensing

Status
FEH

Transmitted for checking MIDI connection between U-20 and external equipment.

This message is always transmitted on condition that 'Setup/MIDI/Kybd/Tx Active Sensing' is set as 'On'.

2. RECOGNIZED RECEIVE DATA

This message is always recognized except for ROM play.

■ Note event

● Note off

<u>Status</u>	<u>Second</u>	<u>Third</u>
8nH	kkH	vvH
9nH	kkH	00H

kk = Note number 0H - 7FH (0 - 127)
vv = Velocity ignored
n = MIDI channel No. 0H - FH (1 - 16)

The message is recognized through 'Sound/Part/MIDI/Rx Ch', 'Sound/R.Part/Rx Ch'.

The message is recognized through 'Sound/Part/MIDI/Key Range'.

● Note on

<u>Status</u>	<u>Second</u>	<u>Third</u>
9nH	kkH	vvH

kk = Note number 0H - 7FH (0 - 127)
vv = Velocity 1H - 7FH (1 - 127)
n = MIDI channel No. 0H - FH (1 - 16)

The message is recognized through 'Sound/Part/MIDI/Rx Ch', 'Sound/R.Part/Rx Ch'.

Note number is recognized through 'Sound/Part/MIDI/Key Range'.

Note velocity is recognized through 'Sound/Part/MIDI/Velo Range'.

■ Polyphonic aftertouch

<u>Status</u>	<u>Second</u>	<u>Third</u>
AnH	kkH	vvH

kk = Note number 0H - 7FH (0 - 127)
vv = 0H - 7FH (0 - 127)
n = MIDI channel No. 0H - FH (1 - 16)

The message is recognized through 'Sound/Part/MIDI/Rx Ch', 'Sound/R.Part/Rx Ch'.

■ Control change

● Modulation depth

<u>Status</u>	<u>Second</u>	<u>Third</u>
BnH	01H	vvH

vv = 0H - 7FH (0 - 127)
n = MIDI channel No. 0H - FH (1 - 16)

The message is recognized through 'Sound/Part/MIDI/Rx Ch', 'Sound/R.Part/Rx Ch'.

● Volume

<u>Status</u>	<u>Second</u>	<u>Third</u>
BnH	07H	vvH

vv = 0H - 7FH (0 - 127)
n = MIDI channel No. 0H - FH (1 - 16)

The message is recognized through 'Sound/Part/MIDI/Rx Ch', 'Sound/R.Part/Rx Ch'.

The value (vvH) corresponds to 'Sound/Part/Output/Level'.

● Pan

<u>Status</u>	<u>Second</u>	<u>Third</u>
BnH	0AH	vvH

vv = 0H - 7FH (0 - 127)
n = MIDI channel No. 0H - FH (1 - 16)

The message is recognized through 'Sound/Part/MIDI/Rx Ch'.
The message is through 'Sound/Part/Output/Pan', but range are changed from 7 to <7.

● Hold

<u>Status</u>	<u>Second</u>	<u>Third</u>
BnH	40H	vvH

vv = 0H - 3FH (0 - 63) : Off
vv = 40H - 7FH (64 - 127) : On
n = MIDI channel No. 0H - FH (1 - 16)

The message is recognized through 'Sound/Part/MIDI/Rx Ch', 'Sound/R.Part/Rx Ch'.

● Sound control parameter 1

<u>Status</u>	<u>Second</u>	<u>Third</u>
BnH	cCH	vvH

cCH = 0H - 5H (0 - 5), 7H - 1FH (7 - 31), 40H - 5FH (64 - 95)
vvH = 0H - 7FH (0 - 127)
n = MIDI channel No. 0H - FH (1 - 16)

The message is recognized through 'Setup/MIDI/Sound/Rx Control Ch', 'Sound/Part/MIDI/Rx Ch' and 'Sound/R.Part/Rx Ch'.

Change the number through 'Sound/Ctrl/Prm1,2,3 #'.

● RPN LSB

<u>Status</u>	<u>Second</u>	<u>Third</u>
BnH	64H	vvH

vv = LSB of the parameter number controlled by RPN
n = MIDI channel No. 0H - FH (1 - 16)

● RPN MSB

<u>Status</u>	<u>Second</u>	<u>Third</u>
BnH	65H	vvH

vv = MSB of the parameter number controlled by RPN
n = MIDI channel No. 0H - FH (1 - 16)

Using MIDI RPN, parameters can be changed by Control change messages.
RPN MSB and LSB specify the parameter to be controlled, while Data entry show the parameter value.

Master fine tune and Bender range are controllable by RPN on U-20.

RPN	Data entry	Comments
<u>MSB</u> <u>LSB</u>		
00H 00H	vvH	Bender range vv= MSB LSB 00 ignore 0 cent : 0C ignore 1200 cent 0D ignore

The message is recognize through 'Sound/Part/Rx Ch', 'Sound/R.Part/Rx Ch'.

<u>MSB</u> <u>LSB</u>	Data entry	Comments
00H 01H	vvH	Master fine tune vv= MSB LSB 20 00 -50 cent : 40 00 0 cent : 50 00 +50 cent

The message is recognized through 'Setup/MIDI/Sound/Rx Control Ch'.

● Reset all controllers

Status	Second	Third
BnH	79H	00H

n = MIDI channel No. 0H - FH (1 - 16)

When Reset all controllers is recognized, each of the controllers is set as follows.

Modulation	0 (min)
Hold1	0 (off)
Pitch bender	+/- 0 (center)
Channel Aftertouch	0 (min)
Polyphonic Aftertouch	0 (min)

The message is recognize through 'Sound/Part/MIDI/Rx Ch', 'Sound/R.Part/Rx Ch'.

■ Program change

● Patch/Timbre change

Status	Second
CnH	ppH

pp = Program change number 0H - 7FH (0 - 127)
n = MIDI channel No. 0H - FH (1 - 16)

Case of Patch change
pp = 0H - 3FH (0 - 63) ...Patch # I11 - I88
pp = 40H - 7FH (64 - 127)...Patch # C11 - C88
(The message will be ignored if no RAM CARD is inserted.)

Case Timbre change
pp = 0H - 7FH (0 - 127) ...Timbre # A11 - B88
(The Timbre is selected from the same media (Internal or RAM CARD) as Sound patch.)

The Timber change is recognized through 'Sound/Part/MIDI/Rx Ch'.
The Timbre change is not recognized through 'Setup/MIDI/Sound/Rx Timbre Change' is set as 'Off'.

The Patch change is recognized through 'Setup/MIDI/Sound/Rx Control Ch'.
The Patch change is not recognized through 'Setup/MIDI/Sound/Rx Control Ch' is set as 'Off'.
The Program change is not recognized Edit mode or ROM play mode.

■ Channel aftertouch

Status	Second
DnH	vvH

vv = 0H - 7FH (0 - 127)
n = MIDI channel No. 0H - FH (1 - 16)

The message is recognized through 'Sound/Part/MIDI/Rx Ch', 'Sound/R.Part/Rx Ch'.

■ Pitch bender

Status	Second	Third
EnH	llH	mmH

ll = Lower Pitch bender value 00H - 7FH (0 - 127)
mm = Upper Pitch bender value 00H - 7FH (0 - 127)
n = MIDI channel No. 0H - FH (1 - 16)

The message is recognized through 'Sound/Part/MIDI/Rx Ch', 'Sound/R.Part/Rx Ch'.

■ Modes

● Local control

Status	Second	Third
BnH	7AH	vvH

vv = 00H - 3FH (0 - 63) : Off
vv = 40H - 7FH (64 - 127) : On

The message is recognized through 'Setup/MIDI/Kybd/Rx Control Ch'.
The message is ignored through 'Setup/MIDI/Kybd/Rx Control Ch' is set as 'Off'.

● All notes off

Status	Second	Third
BnH	7BH	00H

n = MIDI channel No. 0H - FH (1 - 16)

When All notes off is recognized, all the notes which have been turned on by MIDI Note on message are turned off.

The message is recognized through 'Sound/Part/MIDI/Rx Ch', 'Sound/R.Part/Rx Ch'.

● Omni off

Status	Second	Third
BnH	7CH	00H

n = MIDI channel No. 0H - FH (1 - 16)

Recognized as All notes off only.
The U - 20 stays in Mode 3 (Omni off, Poly).

● Omni on

Status	Second	Third
BnH	7DH	00H

n = MIDI channel No. 0H - FH (1 - 16)

Recognized as All notes off only.
The U - 20 stays in Mode 3 (Omni off, Poly).

● Mono

Status	Second	Third
BnH	7EH	mmH

mm = Mono channel range ignore
n = MIDI channel No. 0H - FH (1 - 16)

Recognized as All notes off only.
The U - 20 stays in Mode 3 (Omni off, Poly).

● Poly

Status	Second	Third
BnH	7FH	00

n = MIDI channel No. 0H - FH (1 - 16)

Recognized as All notes off only.
The U - 20 stays in Mode 3 (Omni off, Poly).

■ Exclusive

Status
F0H : system exclusive
F7H : EOX (End of Exclusive)

A set of various parameter is transmitted, and received using MIDI Exclusive messages. Refer to section 3 and 'Roland Exclusive Messages' for details.

The message is not recognized through 'Setup/MIDI/Common/Rx SysEx' is set as 'Off'.
Recognized through 'Setup/MIDI/Common/Device ID'.

■ Active sensing

Status
FEH

Once receiving this message, the U - 20 expects to accept status or data in sequence, at last within 300 msec intervals.
If the unit fails to receive a message 300 msec after previous one, it judges there is a problem somewhere in MIDI path, muting the current sound and setting each of controllers as below, then stopping 300 msec - interval monitoring of incoming signal.

3. EXCLUSIVE COMMUNICATIONS

U-20's exclusive map is roughly divided into two area, Bulk-dump area and Individual parameter area.

Bulk-dump area is suited for dumping a set of parameters owing to its hi-speedness, while individual parameter area is suited for controlling each parameter.

■ Device ID

The message is transmitted or received through 'Setup/MIDI/Common/Device ID'.

■ Model ID

Model-ID# in the exclusive message : 2BH

■ Bulk dump

When U-20 is transmitter, Panel operation or MIDI Exclusive data request1.

U-20's bulk-dump follows the rules shown below.

- One byte data read from U-20's internal memory is transferred after it is divided into two (upper 4 bits and lower 4 bits).
For example, 0ABh will be divided into 0Bh and 0Ah (lower first).
- In the case of sending 1 packet of exclusive message, 64 bytes of internal data will be transferred in 128 bytes.
However, the last 1 packet to be sent may get fractional according to the amount of data to be read from internal memory.

Therefore, contents of bulk-dump can easily be known from the structure of internal memory's data.

[Table1] - [Table12] are maps of internal memory, not maps of MIDI.

Transformation must be considered for address and data.

The first address to be read for Bulk-dump is noted 0.

If certain bits of 1 byte data have meanings individually, their bit numbers are also noted.

Bits that are not specified are to be recognized as "-" (reserved).

Basical value for data noted as "reserved" is 0.

As for values and display, refer to the explanation of individual parameter area. Explanation is common between the two.

However, some of the Set up parameters cannot be controlled individually. Those kinds are explained here.

■ Transmit

Exclusive messages are transmitted under following conditions.

1) Patch dump

When switching keyboard patch in play mode, all of temporary keyboard patch and temporary chord 1, 2 is transmitted as bulk-dump.

When switching keyboard patch in play mode, all of temporary sound patch patch, temporary timbre and temporary rhythm setup is transmitted as bulk-dump.

When switching keyboard patch in rink mode, all of noted above is transmitted as bulk-dump.

2) Edit parameter dump

Value of parameter currently being edited can be transmitted by pressing [ENTER]. However, parameters that are not supported by exclusive message will not be transmitted.

3) Bulk dump mode

Transmit as follows.

Data/Bulk/Temp : All, Keyboard Patch, Chord1, Chord2, Sound Patch, Timbre [1]... [6], Timbre All, Rhythm Setup

Data/Bulk/Int : All, Setup, Keyboard Patch, Chord, Sound Patch, Timbre, Rhythm Setup

Data/Bulk/Card : RAM Card All

4) Recognize RQ1

When receiving RQ1 (refer to Roland exclusive format), parameter corresponding to the address is transmitted.

RQ1 for certain parameters is ignored.

U-20 can not send discontinuous blocks by one RQ1.

■ Recognized receive data

This message is always recognized except for ROM play.

■ Parameter address map

address DT1 RQ1 (*...available)

[Bulk Dump Area]

00 00 00 * *	Setup Memory	00 00 00H Bytes [Table 1]
:	:	(Size of Exclusive Address Map)
0B		
00 01 00 * *	Keyboard Patch Temp	00 00 40H Bytes [Table 2]
:	:	
3F		
00 02 00 * *	Chord1 Temp	00 01 60H Bytes [Table 3]
:	:	
03 5F		
00 04 00 * *	Chord2 Temp	00 01 60H Bytes
:	:	
05 5F		
00 06 00 * *	Sound Patch Temp	00 01 20H Bytes [Table 4]
:	:	
07 1F		
00 10 00 * *	Timbre[1] Temp	00 00 40H Bytes [Table 5]
:	:	
10 3F		
00 11 00 * *	Timbre[2] Temp	00 00 40H Bytes
:	:	
11 3F		
00 12 00 * *	Timbre[3] Temp	00 00 40H Bytes
:	:	
12 3F		
00 13 00 * *	Timbre[4] Temp	00 00 40H Bytes
:	:	
13 3F		
00 14 00 * *	Timbre[5] Temp	00 00 40H Bytes
:	:	
14 3F		
00 16 00 * *	Timbre[6] Temp	00 00 40H Bytes
:	:	
15 3F		
00 20 00 * *	Rhythm Setup Temp	00 0C 20H Bytes [Table 6]
:	:	
2C 1F		
01 00 00 * *	Keyboard Patch -11...C-88	00 40 00H Bytes [Table 7]
:	:	
3F 7F		
02 00 00 * *	Timbre -A11...C-B88	01 00 00H Bytes [Table 8]
:	:	
7F 7F		
03 00 00 * *	Sound Patch -11...C-88	01 20 00H Bytes [Table 9]
:	:	
04 1F 7F		
05 00 00 * *	Rhythm Setup -R1...C-R4	00 62 00H Bytes [Table 10]
:	:	
61 7F		
06 00 00 * *	Chord Set 1-8 -1...C-8	00 1C 00H Bytes [Table 11]
:	:	
1B 7F		
08 00 00 * *	RAM Card All	04 00 00H Bytes [Table 12]
:	:	
0B 7F 7F		

[Individual Parameter Control Area]

Temporary area : Keyboard Patch, Chord, Sound Patch, Timbre, Rhythm Setup

10 00 00 * *	Setup	00 00 03H Bytes [Table 13]
:	:	
02		
10 01 00 * *	Keyboard Patch	00 00 2EH Bytes [Table 14]
:	:	
2D		
10 02 00 * *	Chord1	00 00 78H Bytes [Table 15]
:	:	
77		
10 03 00 * *	Chord2	00 00 78H Bytes
:	:	
77		
10 04 00 * *	Sound Patch Common	00 00 2AH Bytes [Table 16]
:	:	

28			
10 04 60	* *	Sound Patch Rhytha Part	00 00 29H Bytes [Table 17]
:			
66			
10 05 00	* *	Sound Patch Part1	00 00 0AH Bytes [Table 18]
:			
0C			
10 05 10	* *	Sound Patch Part2	00 00 0AH
:			
1C			
:			
10 05 50	* *	Sound Patch Part6	00 00 0AH Bytes
:			
5C			
10 10 00	* *	Timbre[1]	00 00 32H Bytes [Table 19]
:			
31			
10 11 00	* *	Timbre[2]	00 00 32H Bytes
:			
31			
:			
10 15 00	* *	Timbre[6]	00 00 32H Bytes
:			
31			
11 00 00	* *	Rhytha Setup Common	00 00 20H Bytes [Table 20]
:			
19			
11 23 00	* *	Rhytha Setup Inst=B1	00 00 20H Bytes [Table 21]
:			
13			
11 24 00	* *	Rhytha Setup Inst=C2	00 00 20H Bytes
:			
13			
:			
11 63 00	* *	Rhytha Setup Inst=D7	00 00 20H Bytes
:			
13			
[Mode Changes]			
60 00 00	* *	Play Mode Change	00 00 06H Bytes [Table 22]
:			
05			

[Table 1] Setup Memory

Memory Offset Address	Description		
00 00H	bit E-F	-	
	bit D	Chorus Sw	(0...1 : Off...On)
	bit C	Reverb Sw	(0...1 : Off...On)
	bit 8-B	LCD Contrast	(0...15 : 0...15)
	bit 0-7	Master Tune	(0...255 : 427.4...452.9)
00 02H	bit F	Local Ctrl Sw	(0...1 : Off...On)
	bit E	Patch Dump Sw	(0...1 : Off...On)
	bit D	Kybd Active Sensing Sw	(0...1 : Off...On)
	bit 8-C	Kybd Rx Ctrl Channel	(0...15 : 1...15, Off)
	bit 7	Kybd Channel After Sw	(0...1 : Off...On)
	bit 6	Kybd Pgm Change Sw	(0...1 : Off...On)
	bit 5	Kybd Tx Ctrl Change Sw	(0...1 : Off...On)
	bit 0-4	Kybd Tx Setup Channel	(0...15 : 1...15)
00 04H	bit E-F	-	
	bit D	Common Rx Exclusive Sw	(0...1 : Off...On)
	bit 8-C	Device ID	(0...31 : 1...32)
	bit 7	Sound Rx Timbre Change Sw	(0...1 : Off...On)
	bit 5-6	-	
	bit 0-4	Sound Rx Ctrl Channel	(0...15 : 1...15, Off)
Total size = 06H (Size on Memory)			

[Table 2] Keyboard Patch Temporary

Memory Offset address	Description	
00 00H	bit 0-7	name (ASCII)
:		
00 08H		
00 0CH	bit F	Transpose
	bit A-E	Tx Ctrl Channel
	bit 5-9	Tx Arpe Channel
	bit 0-4	Tx Channel
00 0EH	bit F	C2 Tx Ch
	bit 8-E	C2 Ctrl #
	bit 7	C1 Tx Ch
	bit 0-6	C1 Ctrl #
00 10H	bit 8-F	Tx Pgm #
	bit 7	Ext Tx Ch
	bit 0-6	Ext Ctrl #
00 12H	bit E-F	Key Mode
	bit 7-D	Arp Rate
	bit 0-6	Transpose
00 14H	bit E-F	Arp Type
	bit 7-D	Velocity Offset
	bit 0-6	Velocity Sens
00 16H	bit A-F	-
	bit 8-9	Retrig Mode 1
	bit 7	Arpeggio
	bit 4-6	Chord Set # 1
	bit 0-3	Chord Offset 1
00 18H	bit A-F	-
	bit 8-9	Retrig Mode 2
	bit 7	-
	bit 4-6	Chord Set # 2
	bit 0-3	Chord Offset 2
Total size = 20H		

[Table 3] Chord1, 2 Temporary

Memory Offset address	Description	
00 00H	bit 0-7	name (ASCII)
:		
00 08H		
00 0CH	bit 0-7	Interval-1 of "C" (80h = Off)
00 0DH	bit 0-7	Interval-2 of "C"
:		
00 18H	bit 0-7	Interval-1 of "C#" (80h = Off)
:		
00 5BH	bit 0-7	Interval-8 of "B" (80h = Off)
Total size = 70H		

[Table 4] Sound Patch Temporary

Memory Offset address	Description	
00 00H	bit 0-7	Name
:		
00 08H		
00 0CH	bit B-F	Chorus Depth
	bit 5-A	Chorus Level
	bit 5	-
	bit 0-4	Chorus Rate
00 0EH	bit D-F	Chorus Type
	bit 7-C	Chorus Feedback
	bit 6	-
	bit 0-5	Rev/Delay Time
00 10H	bit B-F	Delay Feedback
	bit 5-A	-

	bit 0-4	Chorus Delay Time		bit 0-3	Env Attack
00 12H	bit F	Chorus Out Mode	00 12H	bit E-F	-
	bit C-E	Rev/Delay Type		bit 8-D	Pitch Shift Coarse
	bit B	-		bit 7	-
	bit 6-A	Rev Pre Delay Time		bit 0-6	Pitch Shift Fine
	bit 5	-			
	bit 0-4	Rev/Delay Level	00 14H	bit E-F	-
00 14H	bit D-F	-		bit 9-D	Auto Bend Depth
	bit 8-C	Parameter1		bit 5-8	Bend Range Upper
	bit 7	-		bit 0-4	Bend Range Lower
	bit 0-6	Ctrl # 1	00 16H	bit E-F	-
00 15H	bit D-F	-		bit A-D	Auto Bend Rate
	bit 8-C	Parameter2		bit 5-9	Pitch Ch Aftertouch Sens
	bit 7	-		bit 0-4	Pitch Poly Aftertouch Sens
	bit 0-6	Ctrl # 2	00 18H	bit C-F	Vib Depth
00 18H	bit D-F	-		bit 8-B	Vib Delay
	bit 8-C	Parameter3		bit 4-7	Vib Modulation Depth
	bit 7	-		bit 0-3	-
	bit 0-6	Ctrl # 3	00 1AH	bit C-F	-
00 1AH	bit F	-		bit 8-B	Vib Waveform
	bit E	Rx Volume		bit 6-7	-
	bit D	Rx Hold		bit 0-5	Vib Rate
	bit 8-C	Rhythm Part Channel	00 1CH	bit C-F	Vib Poly Aftertouch Sens
	bit 7	-		bit 8-B	Vib Ch Aftertouch Sens
	bit 5-6	Rhythm Setup #		bit 4-7	-
	bit 0-4	Rhythm Part Voice Reserve		bit 0-3	Vib Rise Time
00 1CH	bit 8-F	-			Total size = 20H
	bit 7	Rhythm Part Level Boost			
	bit 0-6	Rhythm Part Level			

----- Part 1-6 -----

Memory Offset address	Description	
00 1EH	bit F	-
	bit D-E	Output Assign
	bit 8-C	Voice Reserve
	bit 7	Rx Volume
	bit 0-6	Timbre #
00 20H	bit C-F	Panning
	bit 5-B	Part Level
	bit 0-4	Receive Channel
		(off, 1-16)
00 22H	bit F	Rx Pan
	bit 8-E	Key Range Hi
	bit 7	Rx Hold
	bit 0-6	Key Range Low
00 24H	bit F	-
	bit 8-E	Velo Range Hi
	bit 7	-
	bit 0-6	Velo Range Low
		Total size = 50H

[Table 5] Timbre1, 2, 3, 4, 5, 6 Temporary

Offset address	Description	
00 00H	bit 0-7	Name
:		
00 0BH		
00 0CH	bit C-F	Detune Depth
	bit 7-B	Tone Media
	bit 0-6	Tone #
00 0EH	bit F	-
	bit 8-E	Timbre Level
	bit 4-7	Level Ch Aftertouch Sens
	bit 0-3	Level Velo Sens
00 10H	bit C-F	Env Release
	bit 8-B	Env Sustain
	bit 4-7	Env Decay

[Table 6] Rhythm Setup Temporary

Offset address	Description	
00 00H	bit 0-7	Name
:		
00 0BH		
00 0CH	bit 9-F	-
	bit 5-8	Bender Range Upper
	bit 0-4	Bender Range Lower

----- Inst "B1" - "D7" -----

Offset address	Description	
00 0EH	bit C-F	Detune Depth
	bit 7-B	Tone Media
	bit 0-6	Tone #
00 10H	bit C-F	Auto Bend Rate
	bit 7-B	Pitch Offset Coarse
	bit 0-6	Pitch Offset Fine
00 12H	bit F	Env Mode
	bit A-E	Pitch Ch Aftertouch Sens
	bit 5-9	Pitch Poly Aftertouch Sens
	bit 0-4	Auto Bend Depth
00 14H	bit C-F	Env Release
	bit 8-B	Env Decay
	bit 4-7	Env Attack
	bit 0-3	Level Velo Sens
00 16H	bit F	-
	bit 8-E	Mute Inst
	bit 7	-
	bit 0-6	Source Key
00 18H	bit F	-
	bit B-E	Pitch Randomize
	bit 9-A	Out Asgn
	bit 4-8	Out Level
	bit 0-3	Panning
		Total size = 310H

[Table 7] Keyboard Patch I11 - C88

Offset address	Description
Same as temporary Keyboard area.	
Total size = 2000H	

[Table 8] Timbre IA11 - CB88

Offset address	Description
Same as temporary Timbre area.	
Total size = 2000H	

[Table 9] Sound Patch I11 - C88

Offset address	Description
Same as temporary Sound Patch area.	
Total size = 5000H	

[Table 10] Rhythm Setup I1 - C4

Offset address	Description
Same as temporary Rhythm Setup area.	
Total size = 1880H	

[Table 11] Chord Set I1 - C8

Offset address	Description
Same as temporary Chord Set area.	
Total size = 700H	

[Table 12] RAM Card All

Offset address	Description
Same as temporary RAM Card all area.	
Total size = 8000H	

[Table 13] Setup Parameter (Individual)

address	DT1	RQ1	Description
10 00 00	*	*	Chorus Sw (0...1 : Off...On)
01	*	*	Reverb Sw (0...1 : Off...On)
02	*	*	LCD Contrast (0...15 : 0...15)
Total size = 00 00 03H			

[Table 14] Keyboard Patch Parameter (Individual)

address	DT1	RQ1	Description
10 01 00	*	*	Patch Name1 Lower 4bit
01	*	*	Patch Name1 Upper 4bit
:			
17	*	*	Patch Name12 Upper 4bit
18	*	*	Tx Pgm # Lower 4bit (0...129 : 001...128, P.N, Off)
19	*	*	Tx Pgm # Upper 4bit
1A	*	*	Tx Channel (0...16 : 01...16, Set)
1B	*	*	Tx Arpeggio Channel (0...17 : 01...16, Set, Tx)
1C	*	*	Tx Ctrl Channel (0...17 : 01...16, Set, Tx)
1D	*	*	Tx Ext Ctrl Tx Ch (0...1 : Tx Ch, Tx Ctrl Ch)
1E	*	*	Tx Ext Ctrl # (0...63 : 00...5, 7...31, 64...95, Off)

1F	*	*	Tx C1 Ctrl Tx Ch (0...1 : Tx Ch, Tx Ctrl Ch)
20	*	*	Tx C1 Ctrl # (0...63 : 00...5, 7...31, 64...95, Off)
21	*	*	Tx C2 Ctrl Tx Ch (0...1 : Tx Ch, Tx Ctrl Ch)
22	*	*	Tx C2 Ctrl # (0...63 : 00...5, 7...31, 64...95, Off)
23	*	*	Key Velocity Offset (1...127 : 1...127)
24	*	*	Key Velocity Sens (0...127 : 0...127)
25	*	*	Key Transpose (28...100 : -36...+36)
26	*	*	Chord Set 1 # (0...7 : 1...8)
27	*	*	Key Offset 1 (0...11 : 0...11)
28	*	*	Retrig Mode 1 (0...2 : Off, Low, Hi)
29	*	*	Type (0...3 : Up, Down, Up-down, Random)
2A	*	*	Rate (0...127 : 0...127)
2B	*	*	Key Transpose (0...1 : Off...On)
2C	*	*	Key Mode (0...2 : Off, Chord1, 2)
2D	*	*	Arpeggio (0...1 : Off, On)
2E	*	*	Chord Set 2 # (0...7 : 1...8)
2F	*	*	Key Offset 2 (0...11 : 0...11)
30	*	*	Retrig Mode 2 (0...2 : Off, Low, Hi)
Total size = 00 00 31H			

[Table 15] Chord 1, 2 Parameter (Individual)

address	DT1	RQ1	Description
10 02 00	*	*	Chord Name1 Lower 4bit
01	*	*	Chord Name1 Upper 4bit
:			
17	*	*	Chord Name12 Upper 4bit
18	*	*	Chord Tone1 interval "C" (1...127 : Off, -63...+63(semi))
19	*	*	Chord Tone2 interval "C"
:			
24	*	*	Chord Tone1 interval "C#"
:			
77	*	*	Chord Tone8 interval "B"
10 03 00	*	*	Chord2 Individual 120bytes
:			
77			
Total size = 00 00 78H			

[Table 16] Sound Patch Parameter (Individual)

address	DT1	RQ1	Description
10 04 00	*	*	Patch Name1 Lower 4bit
01	*	*	Patch Name1 Upper 4bit
:			
17	*	*	Patch Name12 Upper 4bit
18	*	*	Chorus Type (0...4 : Chorus1, Chorus2, FB-Chorus, Flanger, Short Delay)
19	*	*	Chorus Out Mode (0...1 : Pre Rev, Post Rev)
1A	*	*	Chorus Level (0...31 : 0...31)
1B	*	*	Chorus Delay (0...31 : 0...31)
1C	*	*	Chorus Rate (0...31 : 0...31)
1D	*	*	Chorus Depth (0...31 : 0...31)
1E	*	*	Chorus Feedback (1...63 : -31...+31)
1F	*	*	Reverb Type (0...7 : Room1, Room2, Room3, Hall1, Hall2, Gate, Delay, CrossDelay)
20	*	*	Reverb Time (0...31 : 0...31)
21	*	*	Reverb Level (0...31 : 0...31)
22	*	*	Reverb Delay Feedback (0...31 : 0...31)
23	*	*	Param1 # (00...5, 7...31, 64...95, Off)
24	*	*	Param1 Param (0...18 : Timbre Level, Env Attack, Env Decay, Env Sustain, Env Release, A Bend Depth, A Bend Rate, Detune Depth, Vib Rate, Vib Waveform, Vib Depth, Vib Delay, Vib Rise Time, Vib Mod Depth, Chrs Level, Chrs Rate, Chrs Feedback, Rev Level, Delay Feedback)
25	*	*	Param2 # (0...63 : 00...5, 7...31, 64...95, Off)
26	*	*	Param2 Param (Same as Param1)
27	*	*	Param3 # (0...63 : 00...5, 7...31, 64...95, Off)
28	*	*	Param3 Param (Same as Param1)
Total size = 00 00 28H			

[Table 17] Sound Patch Rhythm Part Parameter (Individual)

10 04 60	*	*	Rhythm Setup # (0...3 : 1...4)
61	*	*	Voice Reserve (0...30 : 0...30)
62	*	*	Receive Channel (0...16 : 01...16, Off)
63	*	*	Level (0...127 : 0...127)
64	*	*	Level Boost (0...1 : Off, On)
65	*	*	Rx Volume (0...1 : Off, On)
66	*	*	Rx Hold (0...1 : Off, On)
Total size = 00 00 07H			

[Table 20] Rhythm Setup Parameter (Individual)

address	DT1	RQ1	
11 00 00	*	*	Setup Name1 Lower 4bit
01	*	*	Setup Name1 Upper 4bit
:			
17	*	*	Setup Name12 Upper 4bit
18	*	*	Bender Range Lower (0...15 : -36, -24, -12...0)
19	*	*	Bender Range Upper (0...12 : 0...12)
Total size = 00 00 1AH			

[Table 18] Sound Patch Part1 Parameter (Individual)

10 05 00	*	*	Timbre Number (0...127 : A11...B88)
01	*	*	Voice Reserve (0...30 : 0...30)
02	*	*	Receive Channel (0...16 : 1...16, Off)
03	*	*	Key Range Low (0...127 : C-1...G9)
04	*	*	Key Range Hi (0...127 : C-1...G9)
05	*	*	Velo Range Min (1...127 : 1...127)
06	*	*	Velo Range Max (1...127 : 1...127)
07	*	*	Output Assign (0...3 : Dry, Rev, Cho, Dir)
08	*	*	Level (0...127 : 0...127)
09	*	*	Pan (0...15 : 7>.><...<7, Rnd)
0A	*	*	Rx Volume (0...1 : Off, On)
0B	*	*	Rx Pan (0...1 : Off, On)
0C	*	*	Rx Hold (0...1 : Off, On)
Total size = 00 00 0DH			

[Table 21] Rhythm Setup Parameter Inst = B1 (Individual)

11 23 00	*	*	Tone Media (0...31 : I, 01...31)
01	*	*	Tone Number (0...127 : 1...128)
02	*	*	Source Key (0...127 : C-1...G9)
03	*	*	Mute Inst (34...98 : Off, B1...D7)
04	*	*	Inst Level (0...31 : 0...31)
05	*	*	Velocity Sens (1...15 : -7...+7)
06	*	*	Env Mode (0...1 : Sustain, No Sustain)
07	*	*	Env Attack Rate (1...15 : -7...+7)
08	*	*	Env Decay Rate (1...15 : -7...+7)
09	*	*	Env Release Rate (1...15 : -7...+7)
0A	*	*	Pitch Shift Coarse (0...27 : -36, -24, -12...+12)
0B	*	*	Pitch Shift Fine (14...114 : -50...+50)
0C	*	*	Channel After Sens (0...27 : -36, -24, -12...+12)
0D	*	*	Poly After Sens (0...27 : -36, -24, -12...+12)
0E	*	*	Random (0...15 : 00...15)
0F	*	*	Auto Bend Depth (0...27 : -36, -24, -12...+12)
10	*	*	Auto Bend Rate (0...15 : 0...15)
11	*	*	Detune Depth (0...15 : 0...15)
12	*	*	Output Assign (0...3 : Dry, Rev, Cho, Dir)
13	*	*	Pan (0...15 : 7>.><...<7, Rnd)
Total size = 00 00 14H			

[Table 19] Timbre Parameter [1] (Individual)

address	DT1	RQ1	
10 10 00	*	*	Timbre Name1 Lower 4bit
01	*	*	Timbre Name1 Upper 4bit
:			
17	*	*	Timbre Name12 Upper 4bit
18	*	*	Tone Media (0...31 : I, 01...31)
19	*	*	Tone Number (0...127 : 1...128)
1A	*	*	Timbre Level (0...127 : 0...127)
1B	*	*	Velocity Sens (1...15 : -7...+7)
1C	*	*	Channel Press Sens (1...15 : -7...+7)
1D	*	*	Env Attack Rate (1...15 : -7...+7)
1E	*	*	Env Decay Rate (1...15 : -7...+7)
1F	*	*	Env Sustain Level (1...15 : -7...+7)
20	*	*	Env Release Rate (1...15 : -7...+7)
21	*	*	Pitch Shift Coarse (8...56 : -24...+24)
22	*	*	Pitch Shift Fine (14...114 : -50...+50)
23	*	*	Bend Range Lower (0...15 : -36, -24, -12...0)
24	*	*	Bend Range Upper (0...12 : 00...12)
25	*	*	Channel After Sens (0...27 : -36, -24, -12...+12)
26	*	*	Poly After Sens (0...27 : -36, -24, -12...+12)
27	*	*	Auto Bend Depth (0...27 : -36, -24, -12...+12)
28	*	*	Auto Bend Rate (0...15 : 0...15)
29	*	*	Detune Depth (0...15 : 0...15)
2A	*	*	Rate (0...63 : 0...63)
2B	*	*	Waveform (0...8 : Tri, Sine, Square, SawUp, SawDwn, Rand1...4)
2C	*	*	Depth (0...15 : 0...15)
2D	*	*	Delay (0...15 : 0...15)
2E	*	*	Rise Time (0...15 : 0...15)
2F	*	*	Modulation Depth (0...15 : 0...15)
30	*	*	Ch After Sens (0...15 : 0...15)
31	*	*	Poly After Sens (0...15 : 0...15)
Total size = 00 00 32H			

[Table 22] Mode Changes

60 00 00	*	Keyboard Patch (DATA will be ignored)
60 00 01	*	Sound Patch (DATA will be ignored)
60 00 02	*	Link (DATA will be ignored)
60 00 03	*	Part (0...5 : Part1...Part6)
60 00 04	*	R.Part (DATA will be ignored)
60 00 05	*	ROM Play (DATA will be ignored)

address	Block	Sub Block	Reference
00-00-00+	setup memory		Table 1
00-01-00+	kybd patch temp		Table 2
00-02-00+	chord temp	chord 1	Table 3
		chord 2	
00-06-00+	sound patch temp		Table 4
00-10-00+	timbre temp	timbre [1]	Table 5
		timbre [2]	
		timbre [3]	
		timbre [4]	
		timbre [5]	
		timbre [6]	
00-18-00+	rhytha setup temp		Table 6
01-00-00+	keyboard patch		Table 7
02-00-00+	timbre		Table 8
03-00-00+	sound patch		Table 9
05-00-00+	Rhytha setup		Table 10
06-00-00+	chord set		Table 11
08-00-00+	RAM card all		Table 12

[Individual Parameter Control]

10-00-00+	setup		Table 13
10-01-00+	keyboard patch		Table 14
10-02-00+	chord	chord 1	Table 15
		chord 2	
10-04-00+	sound patch com		Table 16
10-04-60+	sound patch rhy		Table 17
10-06-00+	sound patch	part 1	Table 18
		part 2	
		part 3	
		part 4	
		part 5	
		part 6	
10-10-00+	timbre[1] 50bytes	timbre 1	Table 19
		timbre 2	
		timbre 3	

		timbre 4	
		timbre 5	
		timbre 6	
11-00-00+	Rhythm setup com		Table 20
11-23-00+	Rhy setup inst=B1	inst=B1	Table 21
		inst=D7	

[Mode Changes]

60-00-00+	Play mode change		Table 22
-----------	------------------	--	----------

Function ...		Transmitted	Recognized	Remarks
Basic Channel	Default Changed	1 - 16 1 - 16	1 - 16 1 - 16	Memorized
Mode	Default Messages Altered	Mode 3 x *****	Mode 3 x	
Note Number	True Voice	0 - 127 *****	0 - 127 0 - 127	
Velocity	Note ON Note OFF	○ v = 1 - 127 ○ v = 1 - 127	○ v = 1 - 127 ○ v = 0 - 127, 9n v = 0	
After Touch	Key's Ch's	x *	○ ○	
Pitch Bender		*	* - 36 - + 12	9 bit resolution
Control Change	0 - 5, 7 - 31, 64 - 95	* (assignable)	* (assignable)	Modulation Volume Panpot Hold 1
	1	*	○	
	7	*	*	
	10	*	*	
	64	*	*	
	100, 101	** (0, 1)	** (0, 1)	RPN LSB, MSB
	6, 38	***	***	Data Entry MSB, LSB
	121	x	○	Reset All Controllers
Prog Change	True #	* 0 - 127 *****	* 0 - 127 0 - 127	
System Exclusive		*	*	
System Common	Song Pos Song Sel Tune	x x x	x x x	
System Real Time	Clock Commands	x x	x x	
Aux Messages	Local ON/OFF All Notes OFF Active Sense Reset	x x * x	○ ○ ○ x	
Notes		* Can be set to ○ or x manually. and memorized. ** Can be set to ○ or x manually. *** RPN = Registered Parameter Number. RPN # 0 : Pitch Bend Sensitivity RPN # 1 : Master Tune		

■ How to read a MIDI Implementation Chart

- : MIDI data that can be transmitted or received
- × : MIDI data that cannot be transmitted or received
- * : Transmission or reception can be turned on or off. The setting is remembered even when the power is turned off.

● Basic Channel

The MIDI channel for transmitting (receiving) MIDI data can be specified over this range. The MIDI channel setting is remembered even when the power is turned off.

● Mode

Most recent synthesizers use mode 3 (omni off, poly).

Reception : Data is received only on the specified channels, and played polyphonically.

Transmission : All musical data is transmitted on the specified MIDI channel.

* "Mode" refers to MIDI Mode messages.

● Note Number

This is the range of note numbers that can be transmitted (received). Note number 60 is middle C (C4).

● Velocity

This is the range over which velocity can be transmitted (received) by Note On and Note Off messages.

● Aftertouch

Key's : polyphonic aftertouch
Ch's : channel aftertouch

● Pitch Bender

The bender range setting of each Timbre determines the range of pitch change caused by pitch bender data. When set to 0, pitch bender data will be ignored.

● Control Change

This indicates the control numbers that can be transmitted (received), and what they will control. For details, refer to the MIDI implementation.

● Program Change

The program change numbers in the chart indicate the actual data. (This is one less than the Pitch and Timbre program numbers.)

● Exclusive

Exclusive message reception can be turned on/off by the exclusive switch (setup).

● Common, Realtime

These MIDI messages are used to synchronize sequencers and rhythm machines. The U-20 does not use these messages.

● Other

These messages are mainly used to keep a MIDI system running correctly. Active sensing transmission can be turned on/off.

Main Specifications

U-20 : RS-PCM keyboard

●Keyboard

61 keys (with velocity and channel aftertouch)

●Sound Generator

RS-PCM Sound Generation
Maximum Voices : 30 voices

●Internal Memory

Setup :	1
Keyboard Patches :	64
Chord Sets :	8
Sound Patches :	64
Timbres :	128
Rhythm Sets (64 keys : B1—D7):	4
Internal Tones :	128

●RAM Card (M-256E)

Setup :	1
Keyboard Patches :	64
Chord Sets :	8
Sound Patches :	64
Timbres :	128
Rhythm Sets (64 keys : B1—D7):	4

●Display

2 line 24 character (with backlight)

●Dimensions

985 (W) × 310 (D) × 85 (H) mm
38-3/4" × 12-1/6" × 3-1/4"

●Weight

10 kg/22 lbs

●Power Consumption

20 W

●Accessories

Owners Manual
Sound Patch Chart
Guarantee
Connection Cable (PJ-1M)

●Options

RAM Card (Memory Card)	M-256E
PCM Card (Sound Library)	SN-U110 series
Stereo Headphones	RH-100
Foot Switch	DP-2, DP-6
Expression Pedal	EV-5, EV-10
MIDI/SYNC Cable	MSC-07, 15, 25, 50, 100
Semi-hard Case	SHC-2
Carrying Bag	CB-10
Keyboard Stand	KS-8

* For product improvement, specifications and appearance are subject to change without notice.

Index

- A**
- Aftertouch 26
 - Arpeggio Rate 35
 - Arpeggio Type 35
 - Arpeggio Play 34
 - Auto Bend Depth (Rhythm Set) ... 75
(Timbre) 64
 - Auto Bend Rate (Rhythm Set) 75
(Timbre) 64
- B**
- Bender Range (Rhythm Set) 78
(Timbre) 63
 - Bulk Dump 145
- C**
- Channel Aftertouch Sensitivity
 - (Level, Timbre) 62
 - (Pitch, Timbre) 64
 - (Rhythm Set) 74
 - (Vibrato, Timbre) 66
 - Chord Play 30
 - Chord Set 30, 39
 - Chord Set Name 42
 - Chord 1/2 Chord Set Select 30
 - Key Offset 31
 - Retrigger Mode 31
 - Chorus/Flanger Depth 54
 - Level 54
 - Rate 54
 - Type 53
 - Chorus Switch (Setup) 51
 - Common Group 90
 - Control Number
 - (Keyboard Patch) 104
 - (Sound Patch) 105
 - Ctrl Group 90
- D**
- Data Mode 15, 128
 - Delay Time (Sound Patch) 54
(Vibrato, Timbre) 66
 - Depth (Vibrato, Timbre) 66
 - Detune Depth (Rhythm Set) 75
(Timbre) 64
 - Device ID 107, 144
- E**
- Edit Mode 15, 124
 - Edit Procedure 124
 - Effect Group (Sound Patch) 53
 - Env Attack Rate (Rhythm Set) ... 73
(Timbre) 62
 - Env Decay Rate (Rhythm Set) ... 73
(Timbre) 62
 - Envelope Mode (Rhythm Set) 73
 - Env Release Rate (Rhythm Set) ... 73
(Timbre) 62
 - Env Sustain Level (Timbre) 62
 - EXT/C1/C2 Control Number 104
Channel 104
- F**
- Feedback (Chorus, Sound Patch) ... 54
(Reverb, Sound Patch) ... 55
- H**
- Hold 28
- I**
- Initialize (Internal Data) 147
(RAM Card) 129
- J**
- Jump 24, 125

K

Kybd Group90
 Keyboard Patch Mode 15, 20, 122
 Keyboard Patch Name36
 Key Range95
 Key Transpose29

L

LCD Contrast44
 Level (Rhythm Set)73
 Level Boost Switch
 (Rhythm Part)52
 Level Group (Rhythm Set)72
 Level Group (Timbre)61
 Link Play Mode 15, 18, 122
 Load142
 Local Control Switch108

M

Master Tuning23
 MIDI Group (Keyboard Patch)89
 (Setup)89
 (Sound Patch)89
 MIDI Monitor149
 Modulation Lever Depth
 (Vibrato, Timbre)66
 Mute (Rhythm Set)72

N

Name (Chord Set)42
 (Keyboard Patch)36
 (Rhythm Set)78
 (Sound Patch)57
 (Timbre)67

O

Output Assign (Rhythm Set)76
 (Sound Patch)50
 Output Group (Rhythm Set)76
 (Sound Patch)50
 Output Mode53

P

Pan (Sound Patch)51
 (Rhythm Set)76
 Parameter Dump146
 Parameter Select (Sound Patch)105
 Part Level
 (Part1—6, Sound Patch)51
 (R.Part, Sound Patch)52
 Part Play Mode 15, 19, 123
 Part1—6 Group90, 94
 Patch Dump146
 Patch Dump Switch107
 PCM Card60
 Pitch Group (Rhythm Set)74
 (Timbre)63
 Pitch Randomize (Rhythm Set)75
 Pitch Shift Coarse (Timbre)63
 (Rhythm Set)74
 Pitch Shift Fine (Timbre)63
 (Rhythm Set)74
 Play Mode 15, 120
 Polyphonic Aftertouch Sensitivity
 (Pitch, Timbre)64
 (Rhythm Set)75
 (Vibrato, Timbre)66

R

RAM Card128
 Rate (Vibrato, Timbre)65
 Reverb/DelayLevel55
 Time55
 Type55
 Reverb Switch (Setup)51
 Rhythm Play Mode 15, 21, 123
 Rhythm Set Name78
 Rhythm Set Select52
 Rise Time (Vibrato, Timbre)66
 ROM Play Mode 12, 15
 R.Part Group90, 94
 Rx Ch (Part 1—6, Sound Patch)94
 (R.Part, Sound Patch)94
 Rx Control Ch (Kybd, Setup)97
 (Sound, Setup)97

-
- Rx Hold Switch106
Rx Pan Switch106
Rx System Exclusive
Switch107, 144
Rx Timbre Change Switch97
Rx Volume Switch106
- S**
- Save142
Sound Group90
Sound Patch Mode 15, 20, 122
Sound Patch Name56
Source Key (Rhythm Set)72
- T**
- Timbre Level61
Timbre Name67
Timbre Select50
Tone46
Tone Select (Rhythm Set)71
(Timbre)59
Tx Active Sensing Switch108
Tx Arpeggio Ch92
Tx Ch92
Tx Channel Aftertouch Switch93
Tx Control Ch100
Tx Control Change Switch105
Tx Program Change Switch100
Tx Program Change Number100
Tx Setup Ch93
- U**
- Utility147
- V**
- Velocity26
Velocity Offset115
Velocity Range (Sound Patch)95
Velocity Sensitivity
(Keyboard Patch)115
(Rhythm Set)73
(Timbre)61
Vib Group65
Voice Reserve
(Part1—6, Sound Patch)117
(R.Part, Sound Patch)117
- W**
- Waveform (Vibrato, Timbre)65
Write Procedure
(Chord Set)43, 139
(Keyboard Patch)37, 133
(MIDI)108
(Rhythm Set)79, 139
(Sound Patch)57, 133
(Summary)131
(Timbre)68, 136

Apparatus containing Lithium batteries

ADVARSEL!

Lithiumbatteri – Eksplosionsfare ved fejlagtig håndtering.
Udskiftning må kun ske med batteri af samme fabrikat og type.
Levér det brugte batteri tilbage til leverandøren.

VARNING!

Explosionsfara vid felaktigt batteribyte.
Använd samma batterityp eller en ekvivalent typ som rekommenderas av apparatillverkaren.
Kassera använt batteri enligt fabrikantens instruktion.

ADVARSEL!

Lithiumbatteri – Eksplosjonsfare.
Ved utskifting benyttes kun batteri som anbefalt av apparatfabrikanten.
Brukt batteri returneres apparatleverandøren.

VAROITUS!

Paristo voi räjähtää, jos se on virheellisesti asennettu.
Vaihda paristo ainoastaan laitevalmistajan suosittelemaan tyyppiin. Hävitä käytetty paristo valmistajan ohjeiden mukaisesti.

Bescheinigung des Herstellers/Importeurs

Hiermit wird bescheinigt, daß der/die/das

ROLAND RS-PCM KEYBOARD U-20

(Gerät. Typ. Bezeichnung)

in Übereinstimmung mit den Bestimmungen der

Amtsbl. Vfg 1046/1984

(Amtsblattverfügung)

funk-entstört ist.

Der Deutschen Bundespost wurde das Inverkehrbringen dieses Gerätes angezeigt und die Berechtigung zur Überprüfung der Serie auf Einhaltung der Bestimmungen eingeräumt.

Roland Corporation Osaka/Japan

Name des Herstellers/Importeurs

FEDERAL COMMUNICATIONS COMMISSION RADIO FREQUENCY INTERFERENCE STATEMENT

This equipment has been tested and found to comply with the limits for a Class B digital device, pursuant to Part 15 of the FCC Rules. These limits are designed to provide reasonable protection against harmful interference in a residential installation. This equipment generates, uses, and can radiate radio frequency energy and, if not installed and used in accordance with the instructions, may cause harmful interference to radio communications. However, there is no guarantee that interference will not occur in a particular installation. If this equipment does cause harmful interference to radio or television reception, which can be determined by turning the equipment off and on, the user is encouraged to try to correct the interference by one or more of the following measures:

- Reorient or relocate the receiving antenna.
- Increase the separation between the equipment and receiver.
- Connect the equipment into an outlet on a circuit different from that to which the receiver is connected.
- Consult the dealer or an experienced radio/TV technician for help.

Unauthorized changes or modification to this system can void the users authority to operate this equipment.
This equipment requires shielded interface cables in order to meet FCC class B Limit.

CLASS B

This digital apparatus does not exceed the Class B limits for radio noise emissions set out in the Radio Interference Regulations of the Canadian Department of Communications.

NOTICE

CLASSE B

Cet appareil numérique ne dépasse pas les limites de la classe B au niveau des émissions de bruits radioélectriques fixés dans le Règlement des signaux parasites par le ministère canadien des Communications.

AVIS

 Roland®

10495

UPC 10495



10495

10495

Roland Corporation