

SECTION 9

CRANKING SYSTEM

CONTENTS

9-1.	GENERAL DESCRIPTION	9-2
9-2.	SPECIFICATIONS	9-4
9-3.	LUBRICATION	9-5
9-4.	REMOVAL AND INSTALLATION	9-5
9-5.	DISASSEMBLY	9-6
9-6.	STARTING MOTOR INSPECTION	9-7
	COMMUTATOR	9-7
	FIELD COIL	9-8
	BRUSH	9-8
	BRUSH HOLDER AND SPRING	9-9
	DRIVE LEVER	9-9
	PINION	9-9
	ARMATURE SHAFT BUSH	9-9
	MAGNETIC SWITCH	9-10
9-7.	PERFORMANCE TEST	9-11
	PULL-IN TEST	9-11
	HOLD-IN TEST	9-11
	PLUNGER RETURN	9-11
	PERFORMANCE TEST	9-11

9-1. GENERAL DESCRIPTION

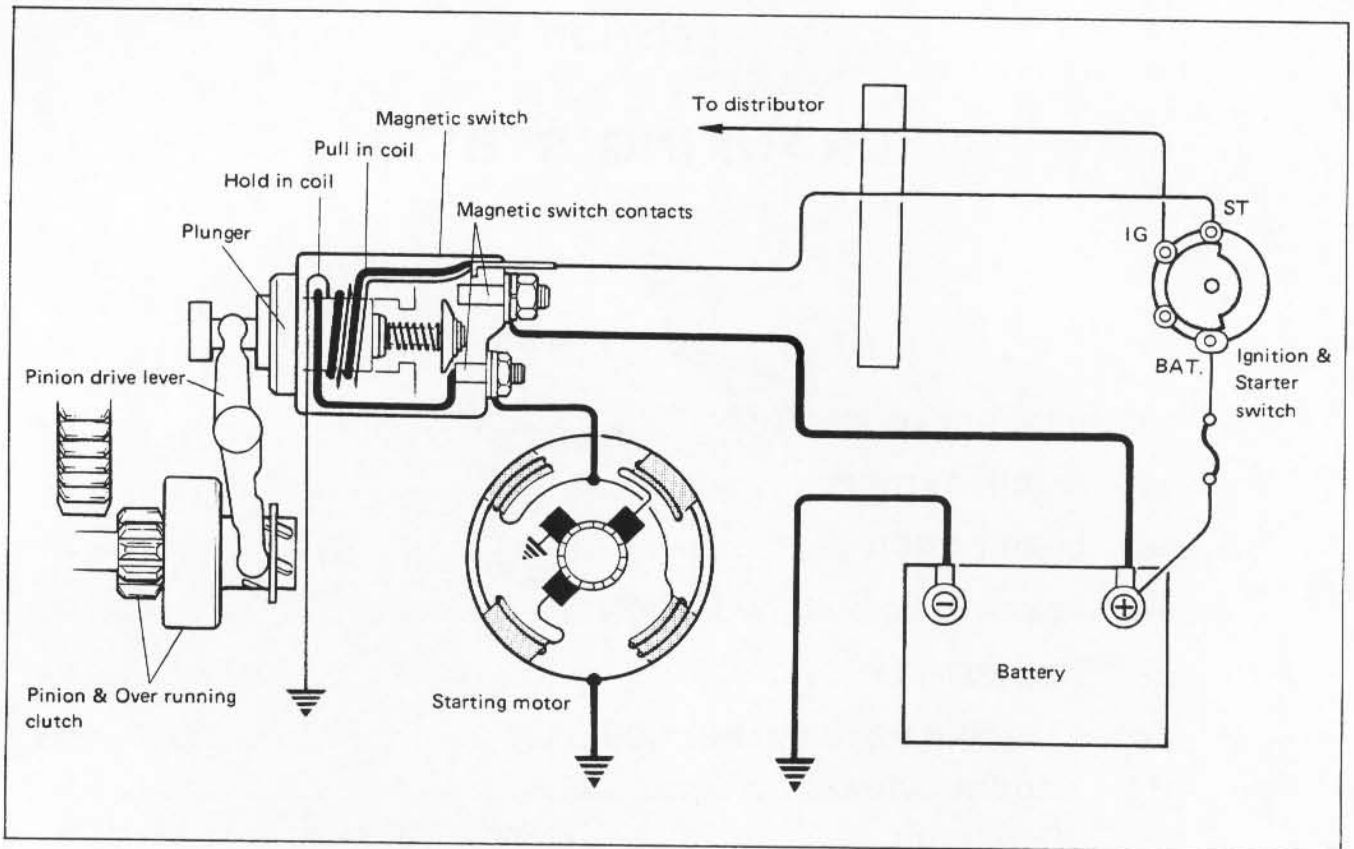

Fig. 9-1 Cranking circuit

CRANKING CIRCUIT

The cranking circuit consists of the battery, starting motor, ignition switch, and related electrical wiring. These components are connected electrically as shown in Fig. 9-1. Only the starting motor will be covered in this portion.

STARTING MOTOR

The starting motor consists of parts shown in Fig. 9-2 and has field coils mounted in starting motor yoke (frame)

The magnetic switch assembly and parts in the starting motor are enclosed in the housings so that they will be protected against possible dirt and water splash.

In the circuit shown in Fig. 9-1, the magnetic (motor) switch coils are magnetized when the ignition switch is closed. The resulting plunger and pinion drive lever movement causes the pinion to engage the engine flywheel gear and the magnetic switch main contacts to close, and cranking takes place. When the engine starts, the pinion overrunning clutch protects the armature from excessive speed until the switch is opened, at which time the return spring causes the pinion to disengage.

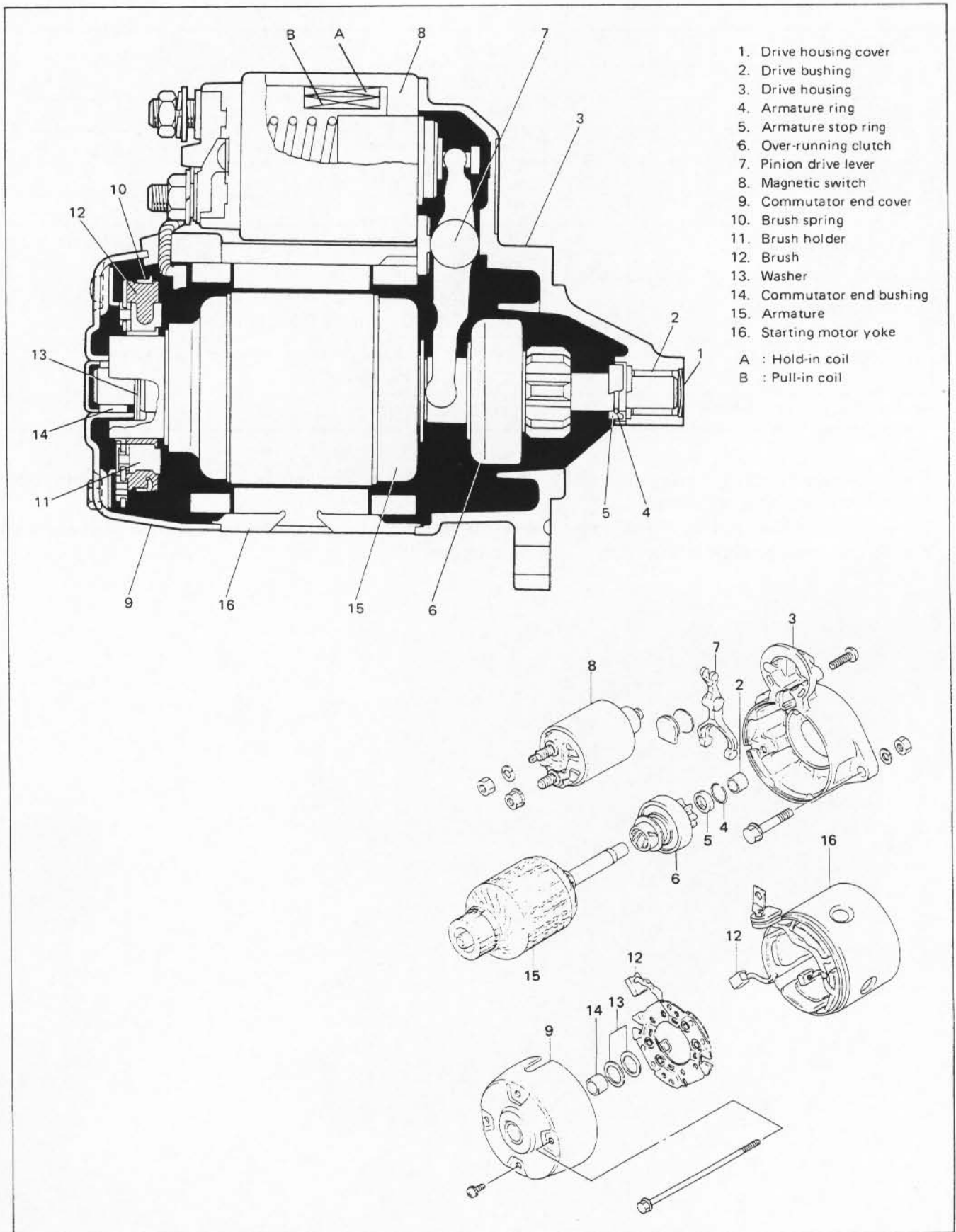

Fig. 9-2

9-2. SPECIFICATIONS

Voltage	12 volts
Output	0.8 kW [0.9 kW]
Rating	30 seconds
Direction of rotation	Clockwise as viewed from pinion side
Brush length	17 mm (0.67 in.)
Number of pinion teeth	8
No-load characteristic	60 A maximum at 11.5 volts, 6,500 r/min [6,600 r/min] minimum
Load characteristic	150 A maximum at 9 volts and 0.28 kg-m [0.29 kg-m] torque, 2,000 r/min [1,900 r/min] minimum
Locked rotor current	380 A [500A] maximum at 5 volts, 0.88 kg-m [1.15 kg-m] minimum
Magnetic switch operating voltage	8 volts maximum

NOTE:

There are two types of starting motor; 0.8 kW and [0.9 kW] as indicated in the above table. Which one to be used depends on specifications.

When replacing the starting motor, check label printed part number on the motor to be replaced and be sure to use a new starting motor of the same part number.

9-3. LUBRICATION

The starting motor does not require lubrication except during overhaul.

When the motor is disassembled for any reason, lubricate as follows:

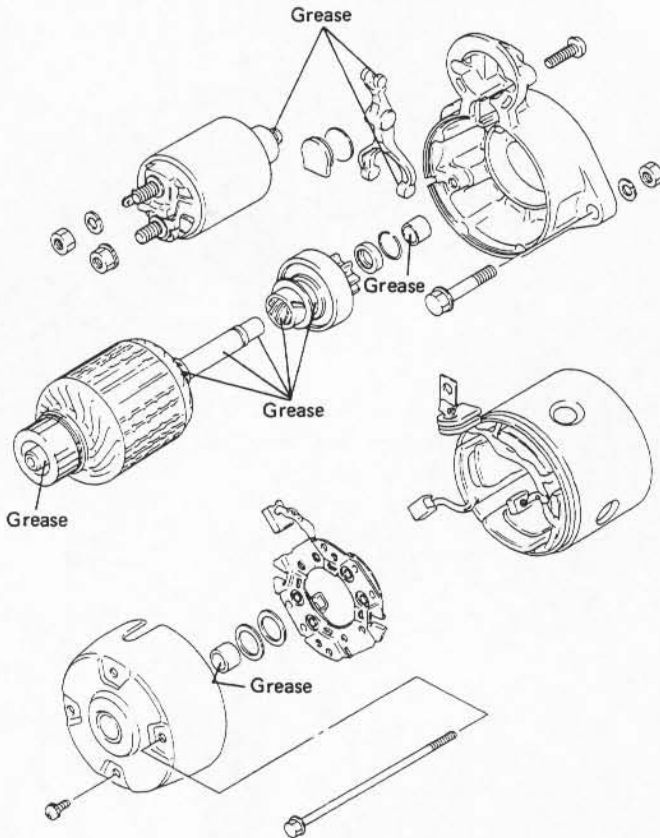

Bearing grease
SUZUKI SUPER GREASE A
99000-25010

Fig. 9-3 Starting motor greasing point

9-4. REMOVAL AND INSTALLATION

Use following procedure to remove starter:

- 1) Disconnect negative battery lead at battery.
- 2) Disconnect magnetic switch lead wire (BLACK/YELLOW) and battery cable from starting motor terminals.
- 3) Remove two starting motor mount bolts.
- 4) Remove starting motor.
- 5) To install, reverse the above procedure.

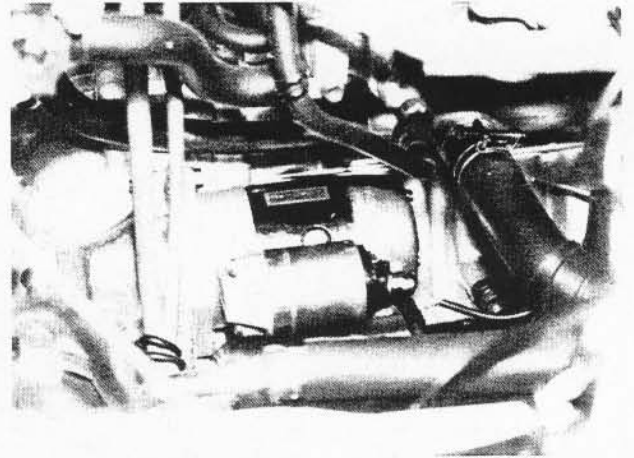

Fig. 9-4 Starting motor mounting

9-5. DISASSEMBLY

NOTE:

Before disassembling starting motor, be sure to put match marks (A and B) as shown in the figure below so that any possible mistakes can be avoided.

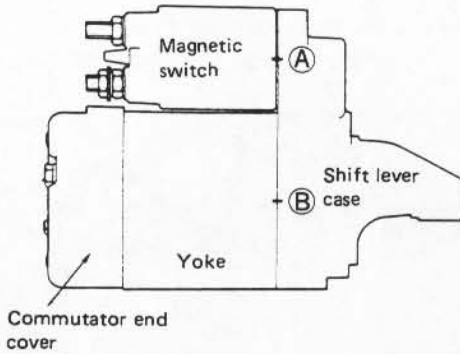

Fig. 9-5

- 1) Remove nut securing the end of field coil lead to terminal on the head of magnetic switch.

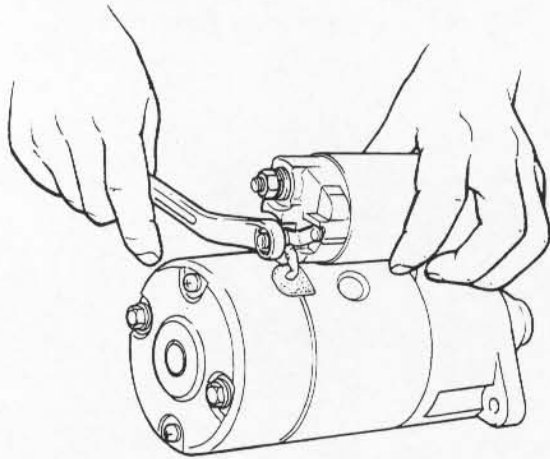

Fig. 9-6

- 2) Take off magnetic switch ① from starting motor body by removing two mounting screws.

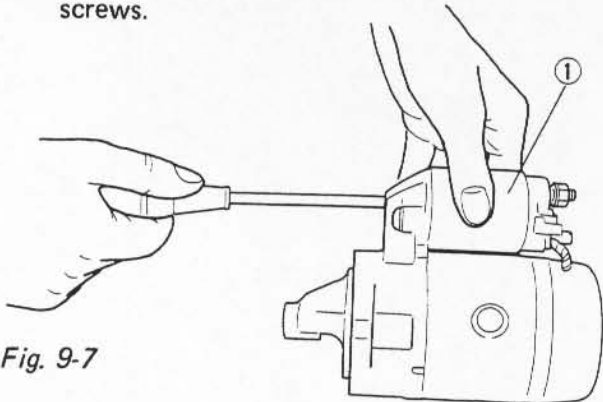

Fig. 9-7

- 3) Loosen 2 bolts and 2 screws to remove commutator end cover.
- 4) Separate drive housing and armature from yoke.

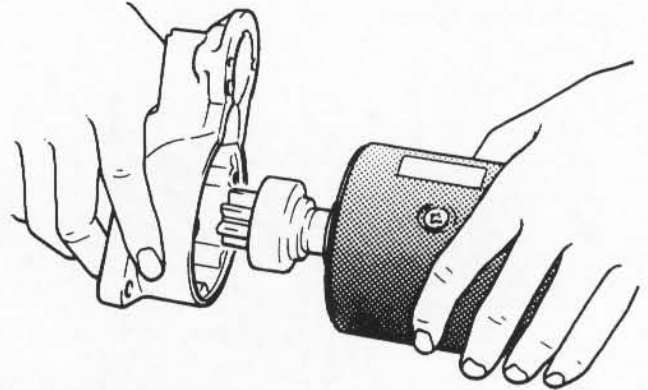

Fig. 9-8

- 5) Draw brushes out of holder.

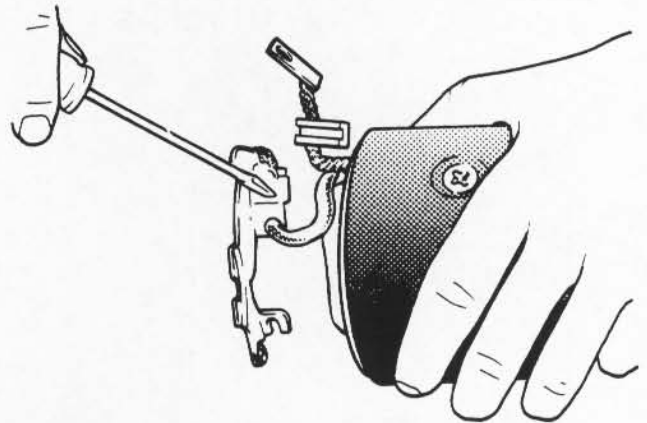

Fig. 9-9

- 6) Draw off over running clutch, as follows:
 - (1) Draw stop ring ① toward clutch side.
 - (2) Remove armature ring ② and slide off clutch.

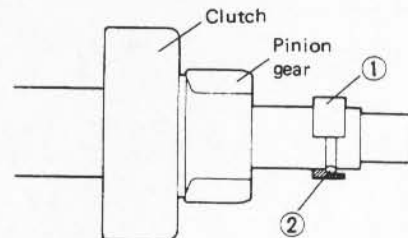

Fig. 9-10

9-6. STARTING MOTOR INSPECTION

1) Inspect Commutator

Inspect commutator for dirt or burn. Correct with sandpaper or lathe, if necessary.

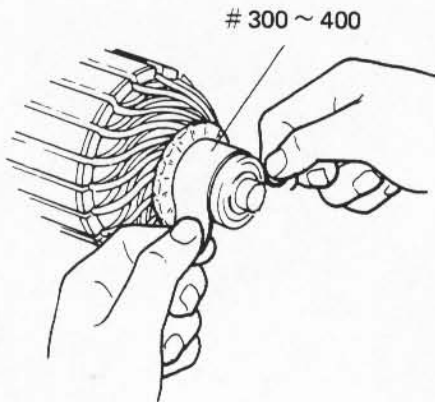

Fig. 9-11

Check commutator for uneven wear. If deflection of dial gauge pointer exceeds limit, repair or replace.

NOTE:

Below specification presupposes that armature is free from bend. Bent shaft must be replaced.

	Standard	Limit
Commutator out of round	0.05 mm (0.0019 in.) or less	0.4 mm (0.015 in.)

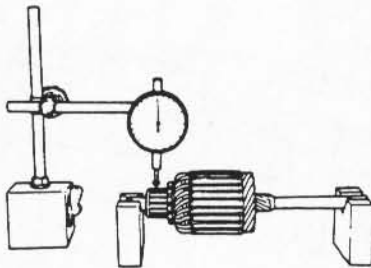

Fig. 9-12

Inspect commutator for wear. If below limit, replace armature.

	Standard	Limit
Commutator outside diameter	32 mm (1.26 in.)	31 mm (1.22 in.)

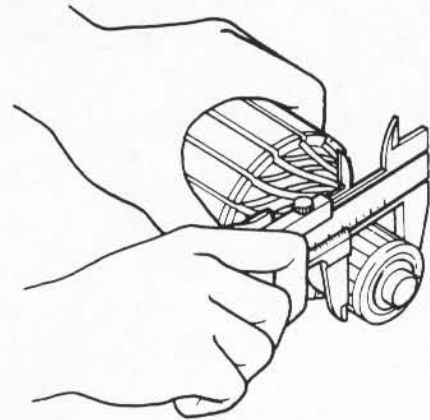

Fig. 9-13

Inspect commutator for mica depth. Correct or replace if below limit.

	Standard	Limit
Commutator mica depth	0.4 – 0.6 mm (0.015 – 0.023 in.)	0.2 mm (0.0078 in.)

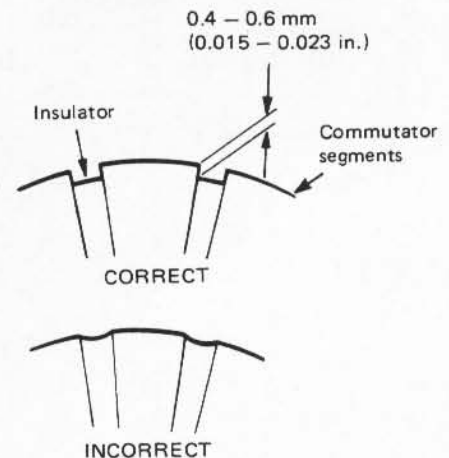

Fig. 9-14

Ground test

Check commutator and armature coil core. If there is continuity, armature is grounded and must be replaced.

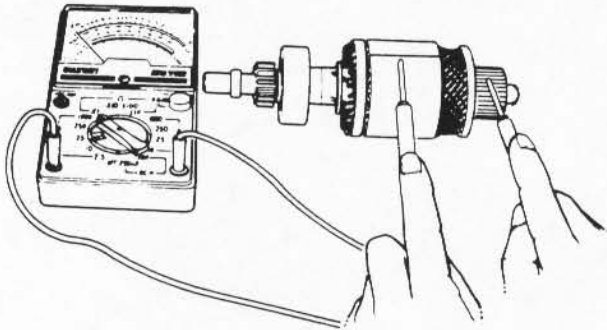

Fig. 9-15

Open circuit test

Check for continuity between segments. If there is no continuity at any test point, there is an open circuit and armature must be replaced.

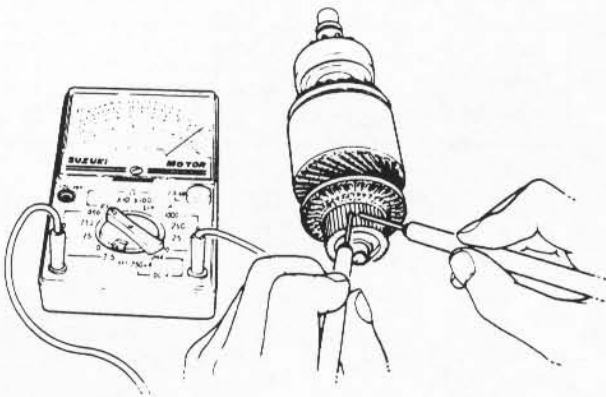

Fig. 9-16

2) Inspect Field Coil

Open circuit test

Check for continuity between brush and bare surface. If there is continuity, field windings are grounded. The field coil must be replaced.

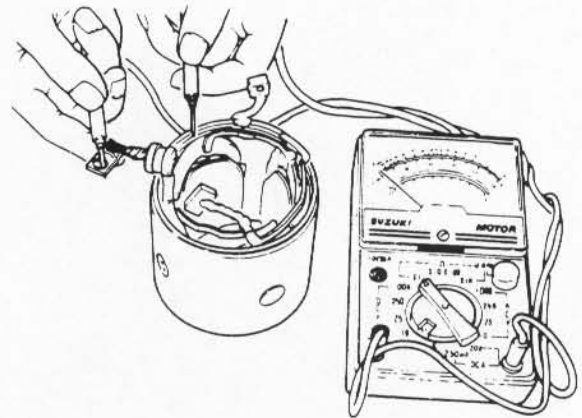

Fig. 9-17

3) Inspect Brush

Check brushes for wear. If below limit, replace brush.

	Standard	Limit
Brush length	17 mm (0.67 in.)	11.5 mm (0.45 in.)

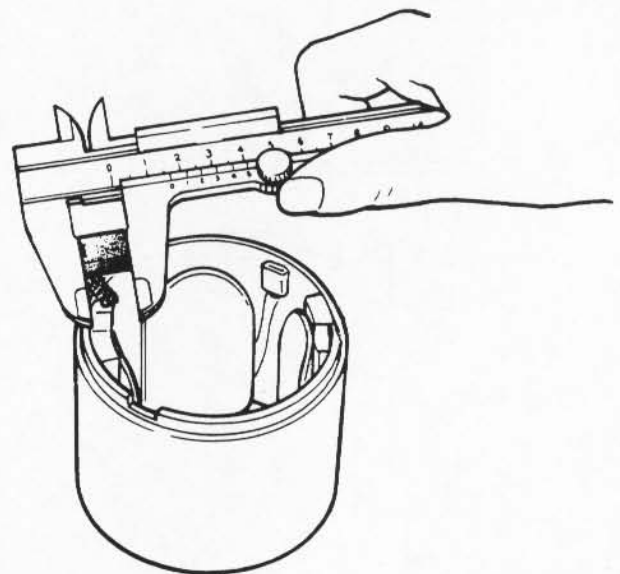

Fig. 9-18

4) Inspect Brush Holder and Spring

Check movement of brush in brush holder. If brush movement within brush holder is sluggish, check brush holder for distortion and sliding faces for contamination.

Clean or correct as necessary.

Check for continuity across insulated brush holder (positive side) and grounded brush holder (negative side).

If continuity exists, brush holder is grounded due to defective insulation and should be replaced.

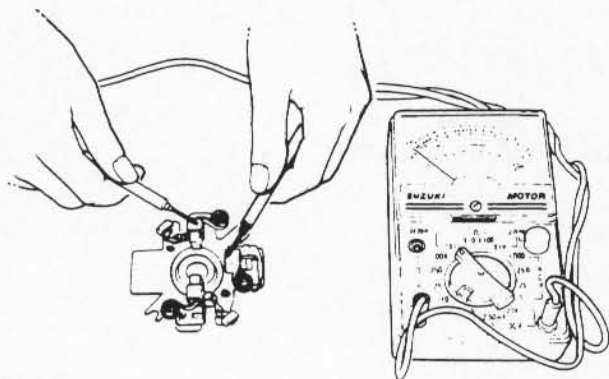

Fig. 9-19

Inspect brush spring for wear, damage or other abnormal conditions. Replace if necessary.

Brush spring tension	Standard	Limit
	1.6 kg (3.53 lb)	1.0 kg (2.20 lb)

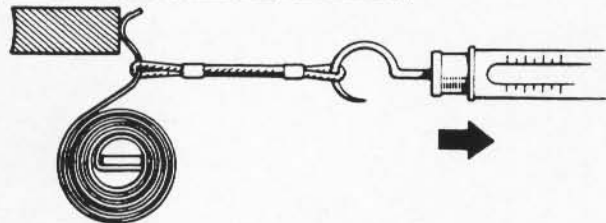

Fig. 9-20

5) Inspect Drive Lever

Inspect drive lever for wear. Replace if necessary.

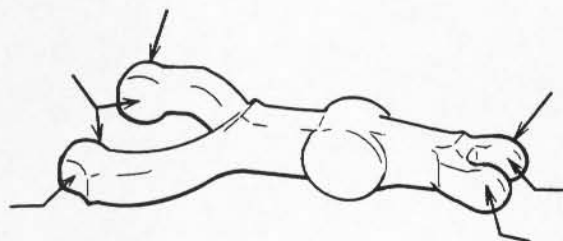

Fig. 9-21

6) Inspect Pinion

Inspect pinion for wear, damage or other abnormal conditions. Check that clutch locks up when turned in direction of drive and rotates smoothly in reverse direction. Replace if necessary.

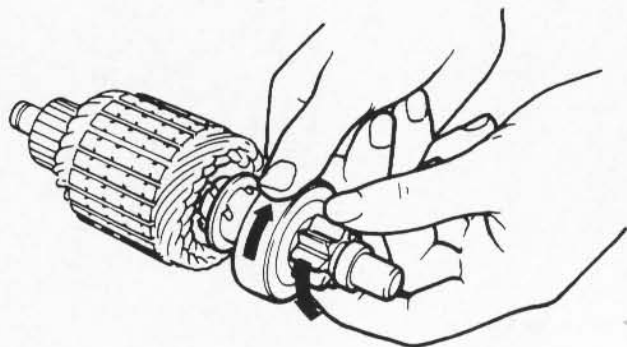

Fig. 9-22

Inspect spline teeth for wear or damage. Replace if necessary. Inspect pinion for smooth movement.

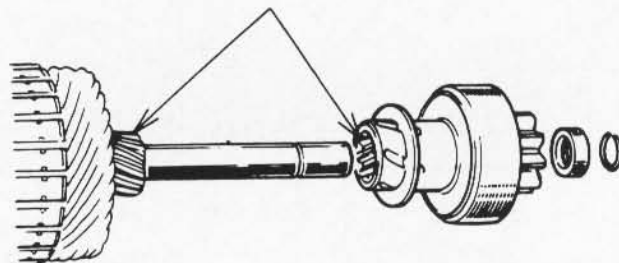

Fig. 9-23

7) Inspect Armature Shaft Bush

Inspect bushes for wear or damage. Replace if necessary.

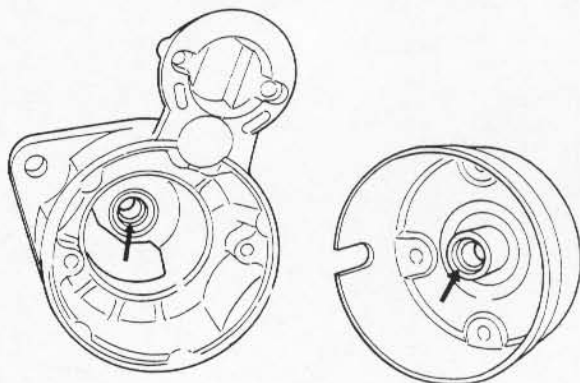

Fig. 9-24

8) Inspect Magnetic Switch

Push in plunger and release it. The plunger should return quickly to its original position. Replace if necessary.

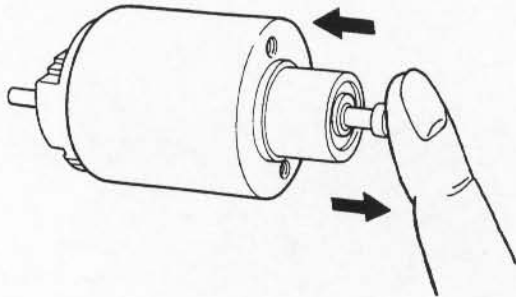

Fig. 9-25

Pull-in coil open circuit test

Check for continuity across magnetic switch 'S' terminal and 'M' terminal. If no continuity exists, the coil is open and should be replaced.

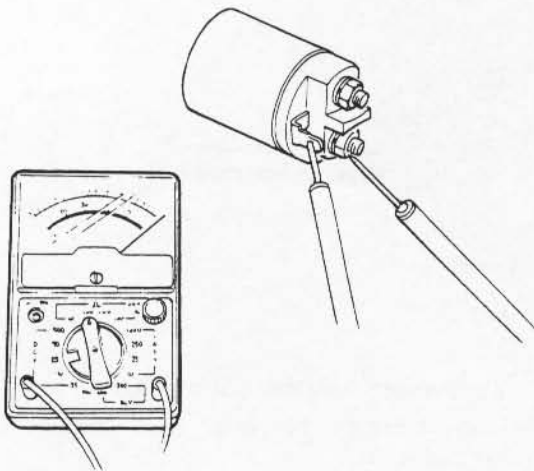

Fig. 9-26

Hold in coil open circuit test

Check for continuity across magnetic switch 'S' terminal and coil case. If no continuity exists, the coil is open and should be replaced.

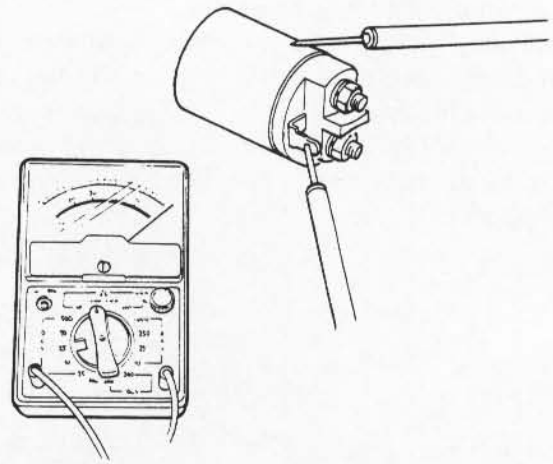

Fig. 9-27

9-7. PERFORMANCE TEST

CAUTION:

These tests must be performed within 3 – 5 seconds to avoid burning out the coil.

1) Pull-in Test

Connect battery to magnetic switch as shown. Check that plunger moves outward. If plunger does not move, replace magnetic switch.

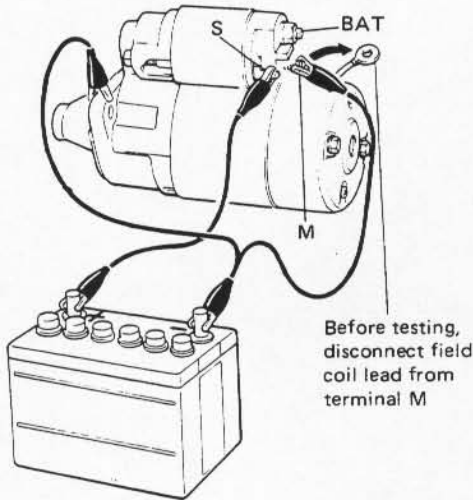

Fig. 9-28

2) Hold-in Test

While connected as above with plunger out, disconnect negative lead from terminal M. Check that plunger remains out. If plunger returns inward, replace magnetic switch.

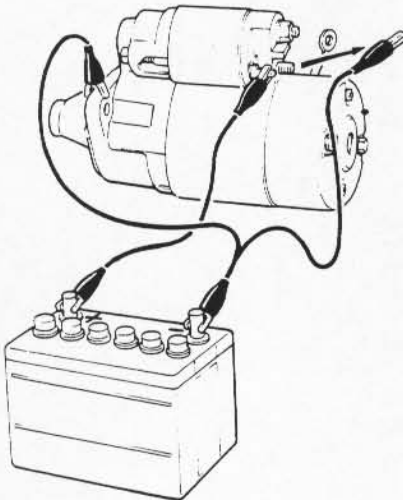

Fig. 9-29

3) Check Plunger Return

Disconnect negative lead from switch body. Check that plunger returns inward. If plunger does not return, replace magnetic switch.

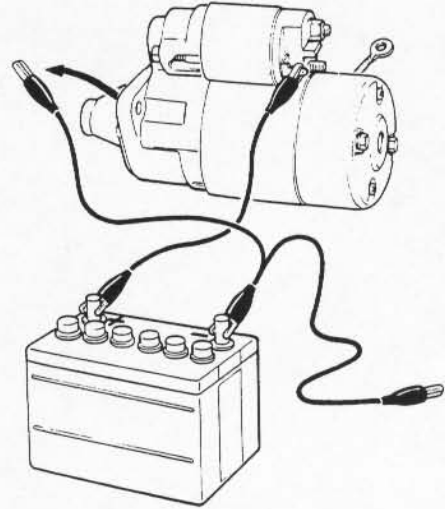

Fig. 9-30

4) No-load Performance Test

- Connect battery and ammeter to starter as shown.
- Check that starter rotates smoothly and steadily with pinion moving out. Check that ammeter reads the specified current.

Specified current
Less than 60 A at 11.5 V

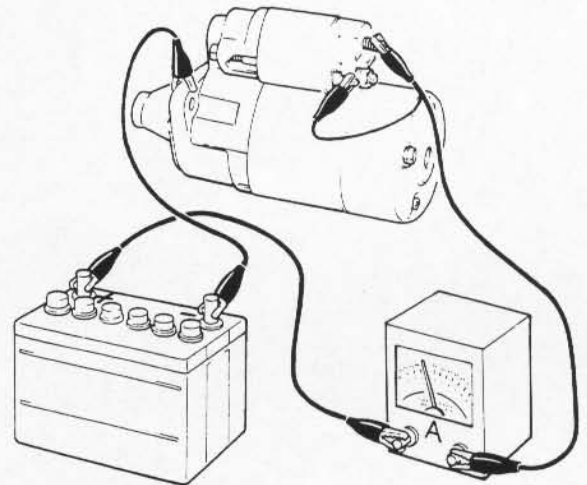

Fig. 9-31