

LUBRICATION SYSTEM

DESCRIPTION

A fully pressurized, fully filtered lubrication system has been adopted for this engine.

OPERATION

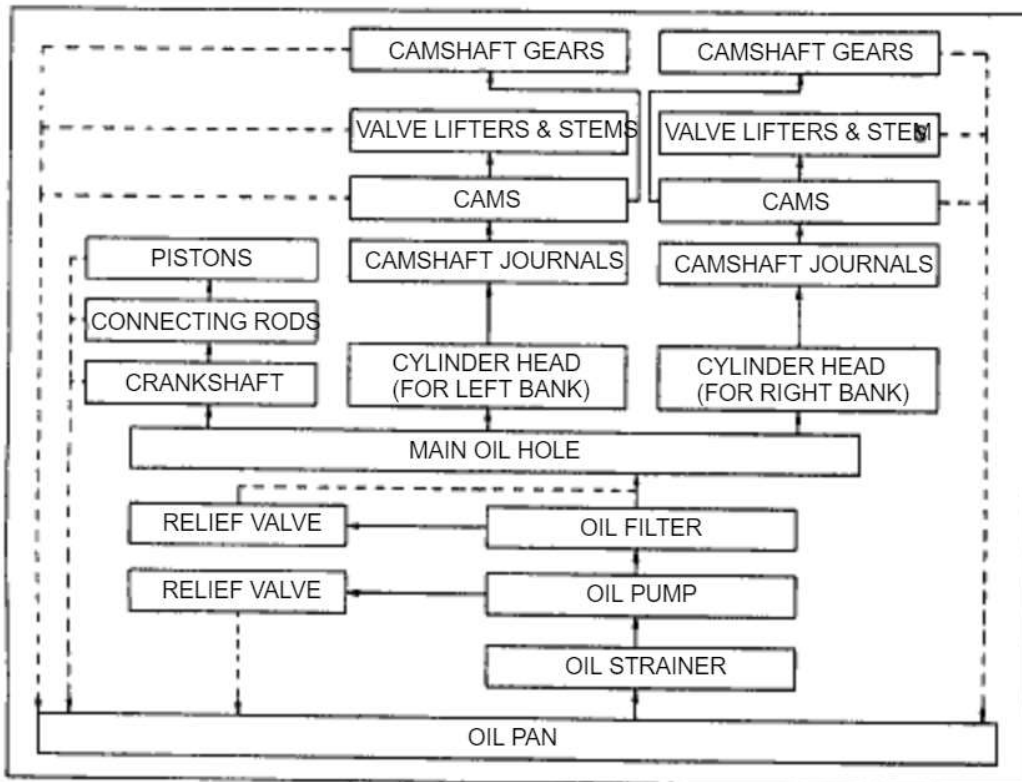
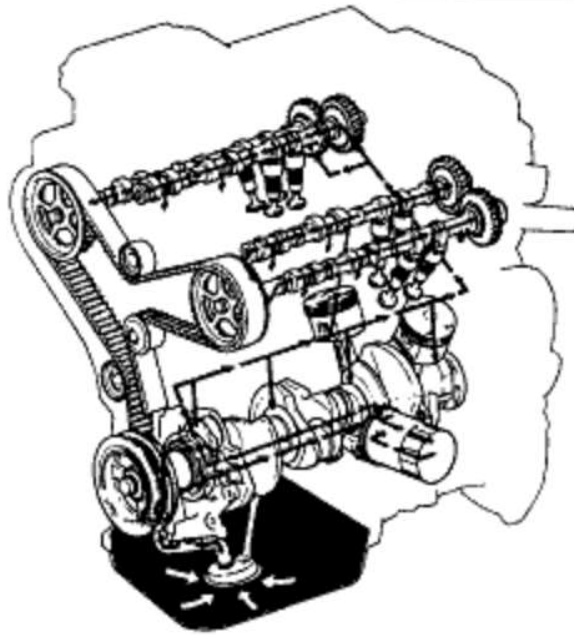

EG2-368**1MZ-FE ENGINE – LUBRICATION SYSTEM**

A pressure feeding lubrication system has been adopted to supply oil to the moving parts of this engine. The lubrication system consists of an oil pan, oil pump, oil filter and other external parts which supply oil to the moving parts in the engine block. The oil circuit is shown in the illustration at the top of the previous page. Oil from the oil pan is pumped up by the oil pump. After it passes through the oil filter, it is fed through the various oil holes in the crankshaft and cylinder block. After passing through the cylinder block and performing its lubricating function, the oil is returned by gravity to the oil pan. A dipstick on the center left side of the cylinder block is provided to check the oil level.

OIL PUMP

The oil pump pumps up oil from the oil pan and feeds it under pressure to the various parts of the engine. An oil strainer is mounted in front of the inlet to the oil pump to remove impurities. The oil pump itself is a trochoid type pump, inside of which there is a drive rotor and a driven rotor. When the drive rotor rotates, the driven rotor rotates in the same direction, and since the axis of the drive rotor shaft is different from the center of the driven rotor, the space between the two rotors changes as they rotate. Oil is drawn in when the space is wide and is discharged when the space is narrow.

OIL PRESSURE REGULATOR (RELIEF VALVE)

At high engine speeds, the engine oil supplied by the oil pump exceeds the capacity of the engine to utilize it. For that reason, the oil pressure regulator works to prevent an oversupply of oil. –During normal oil supply, a coil spring and valve keep the bypass closed, but when too much oil is being fed, the pressure become extremely high, overpowering the force of the spring and opening the valves. This allows the excess oil to flow through the relief valve and return to the oil pan.





OIL FILTER

The oil filter is a full flow type filter with a built-in paper filter element. Particles of metal from wear, airborne dirt, carbon and other impurities can get into the oil during use and could cause accelerated wear or seizing if allowed to circulate through the engine. The oil filter, integrated into the oil line, removes these impurities as the oil passes through it. The filter is mounted outside the engine to simplify replacement of the filter element. A relief valve is also included ahead of the filter element to relieve the high oil pressure in case the filter element becomes clogged with impurities. The relief valve opens when the oil pressure overpowers the force of the spring. Oil passing through the relief valve bypasses the oil filter and flows directly into the main oil hole in the engine.

PREPARATION

0901-01

SST (SPECIAL SERVICE TOOLS)

	09032-00100 Oil Pan Seal Cutter	No.2 oil pan
	09223-00010 Cover & Seal Replacer	Crankshaft front oil seal
	09226-07500 Oil Filter Wrench	
	09816-30010 Oil Pressure Switch Socket	

0902-01

RECOMMENDED TOOLS

	09200-00010 Engine Adjust Kit	
---	-------------------------------	--

0903-01

EQUIPMENT

Oil pressure gauge	
Precision straight edge	Oil pump
Torque wrench	

0904-01

LUBRICANT

Item	Capacity	Classification
Engine oil		
Dry fill	5.5 liters (5.8 US qts, 4.8 Imp. qts)	API grade SG or SH, Energy-Conserving II or ILSAC multigrade and recommended viscosity oil with SAE 5W-30 being the preferred engine oil
Drain and refill w/ Oil filter change	4.7 liters (5.0 US qts, 4.1 Imp. qts)	
w/o Oil filter change	4.5 liters (4.8 US qts, 4.0 Imp. qts)	

EG2-370

1MZ-FE ENGINE - LUBRICATION SYSTEM

SSM (SPECIAL SERVICE MATERIALS)

08826-00080 Seal packing or equivalent	Oil pump No.1 oil pan No.2 oil pan
08833-00080 Adhesive 1344, THREE BOND 1344, LOCTITE 242 or equivalent	Oil pressure switch

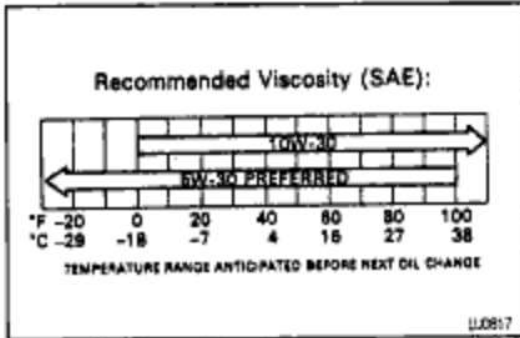

OIL PRESSURE CHECK

1. CHECK ENGINE OIL QUALITY

Check the oil for deterioration, entry of water, discoloring or thinning.

If the quality is visibly poor, replace the oil.

Oil grade:

API grade SG or SH, Energy – Conserving II or ILSAC multigrade engine oil. Recommended viscosity is as shown in the illustration with SAE 5W-30 being the preferred engine oil.

2. CHECK ENGINE OIL LEVEL

The oil level should be between the "L" and "F" marks on the dipstick.

If low, check for leakage and add oil up to the "F" mark.

NOTICE:

- Do not fill with engine oil above the "F" mark.

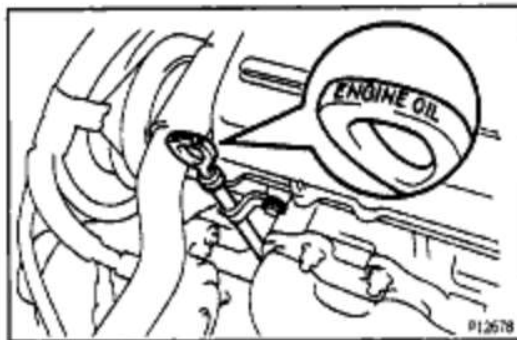
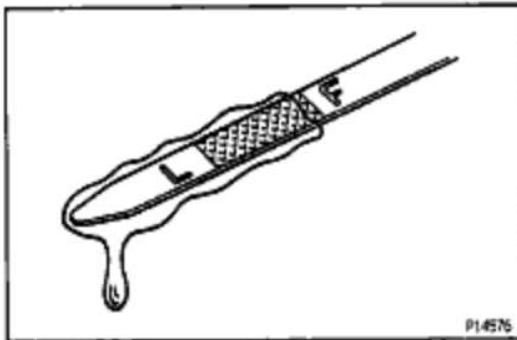

- Install the oil dipstick facing the direction shown in the illustration.

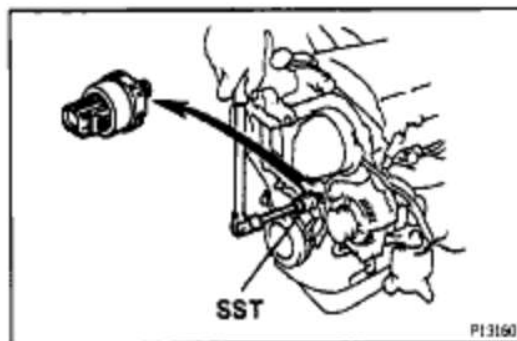

3. REMOVE OIL PRESSURE SWITCH, AND INSTALL OIL PRESSURE GAUGE

- Using SST, remove the oil pressure switch.
- SST 09816 – 30010

1MZ-FE ENGINE - LUBRICATION SYSTEM

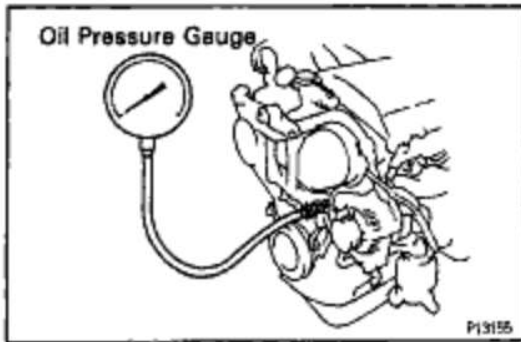

(b) Install the oil pressure gauge.

4. WARM UP ENGINE

Allow the engine to warm up to normal operating temperature.

5. CHECK OIL PRESSURE

Oil pressure:

At idle speed

29 kPa (0.3 kgf/cm², 4.3 psi) or more

At 3,000 rpm

294 – 539 kPa (3.0 – 5.5 kgf/cm², 43 – 78 psi)

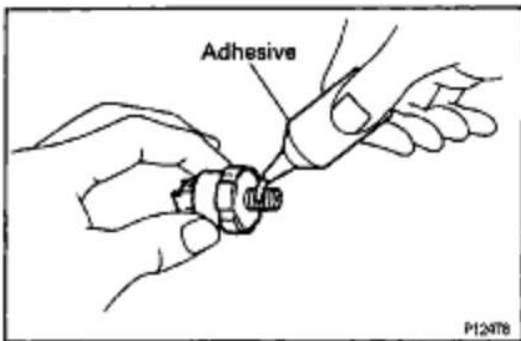

6. REMOVE OIL PRESSURE GAUGE AND REINSTALL OIL PRESSURE SWITCH

(a) Remove the oil pressure gauge.

(b) Apply adhesive to 2 or 3 threads of the oil pressure switch.

Adhesive:

Part No. 08833-00080, THREE BOND 1344,
LOCTITE 242 or equivalent

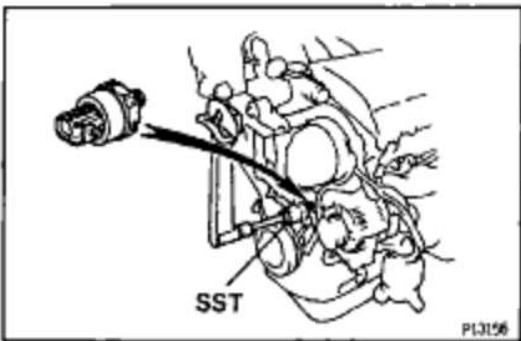

(c) Using SST, reinstall the oil pressure switch.

SST 09816-30010

Torque: 13 N-m (130 kgf-cm, 9 ft-lbf)

7. START ENGINE AND CHECK FOR LEAKS

OIL AND FILTER REPLACEMENT

CAUTION:

D888-81

- Prolonged and repeated contact with mineral oil will result in the removal of natural fats from the skin, leading to dryness, irritation and dermatitis. In addition, used engine oil contains potentially harmful contaminants which may cause skin cancer.
- Exercise caution in order to minimize the length and frequency of contact of your skin to used oil. Wear protective clothing and gloves. Wash your skin thoroughly with soap and water, or use waterless hand cleaner, to remove any used engine oil. Do not use gasoline, thinners, or solvents.
- In order to preserve the environment, used oil and used oil filter must be disposed of only at designated disposal sites.



1. DRAIN ENGINE OIL

- Remove the oil filler cap.
- Remove the oil drain plug, and drain the oil into a container.

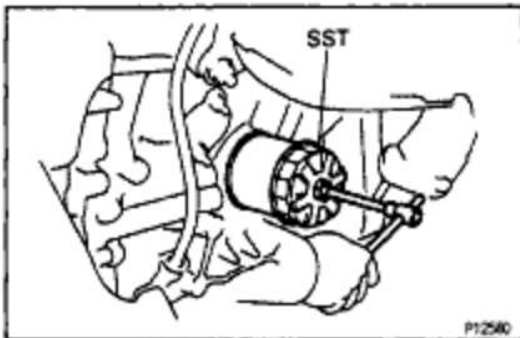

2. REPLACE OIL FILTER

- Using SST, remove the oil filter.
SST 09228-07500

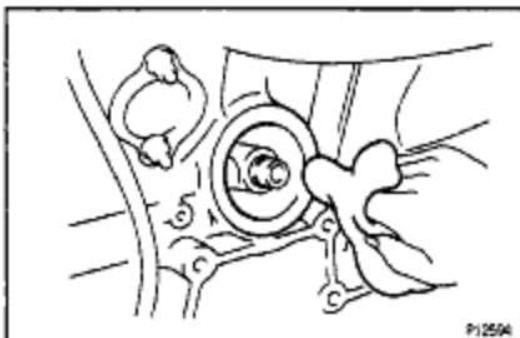

- Check and clean the oil filter installation surface.

1MZ-FE ENGINE - LUBRICATION SYSTEM

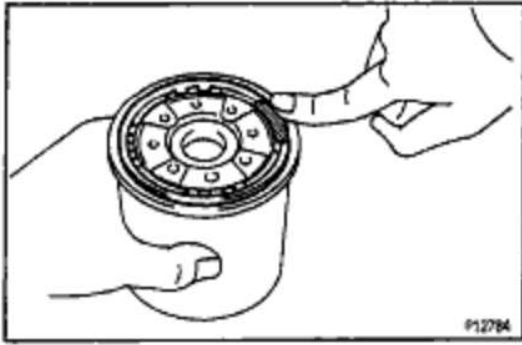

(c) Apply clean engine oil to the gasket of a new oil filter.

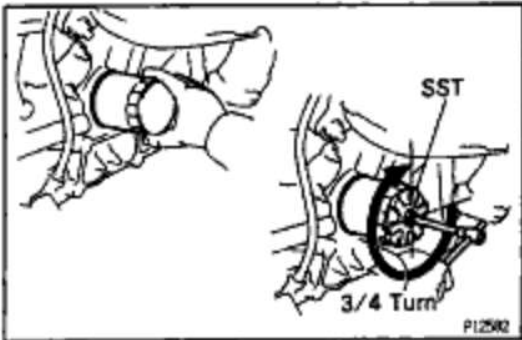

(d) Lightly screw the oil filter into place, and tighten it until the gasket contacts the seat.

(e) Using SST, tighten it an additional 3/4 turn.
SST 09228-07500



3. REFILL WITH ENGINE OIL

(a) Clean and install the oil drain plug with a new gasket.

Torque: 37 N-m (375 kgf-cm, 27 ft-lbf)

(b) Fill with fresh engine oil.

Oil grade:

API grade SG or SH, Energy - Conserving II or ILSAC multigrade and recommended viscosity oil, with SAE 5W-30 being the preferred engine oil.

Capacity:

Drain and refill

w/ Oil filter change

4.7 liters (5.0 US qts, 4.1 Imp. qts)

w/o Oil filter change

4.5 liters (4.8 US qts, 4.0 Imp. qts)

Dry fill

5.5 liters (5.8 US qts, 4.8 Imp. qts)

(c) Reinstall the oil filler cap.

4. START ENGINE AND CHECK FOR OIL LEAKS

5. RECHECK ENGINE OIL LEVEL

EG2-374

1MZ-FE ENGINE - LUBRICATION SYSTEM

OIL PUMP COMPONENTS FOR REMOVAL AND INSTALLATION

8286A-08

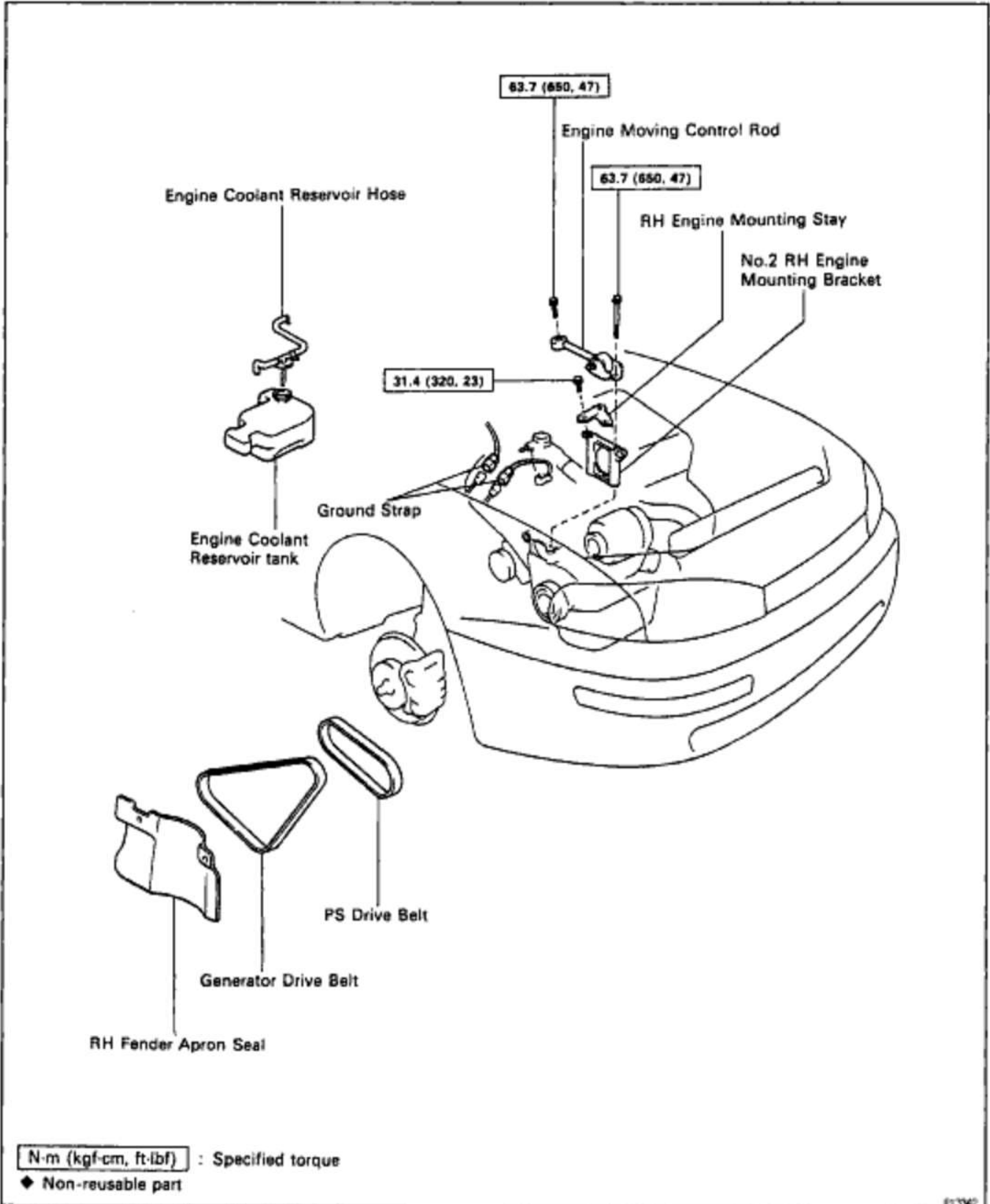

EG2-376

1MZ-FE ENGINE - LUBRICATION SYSTEM

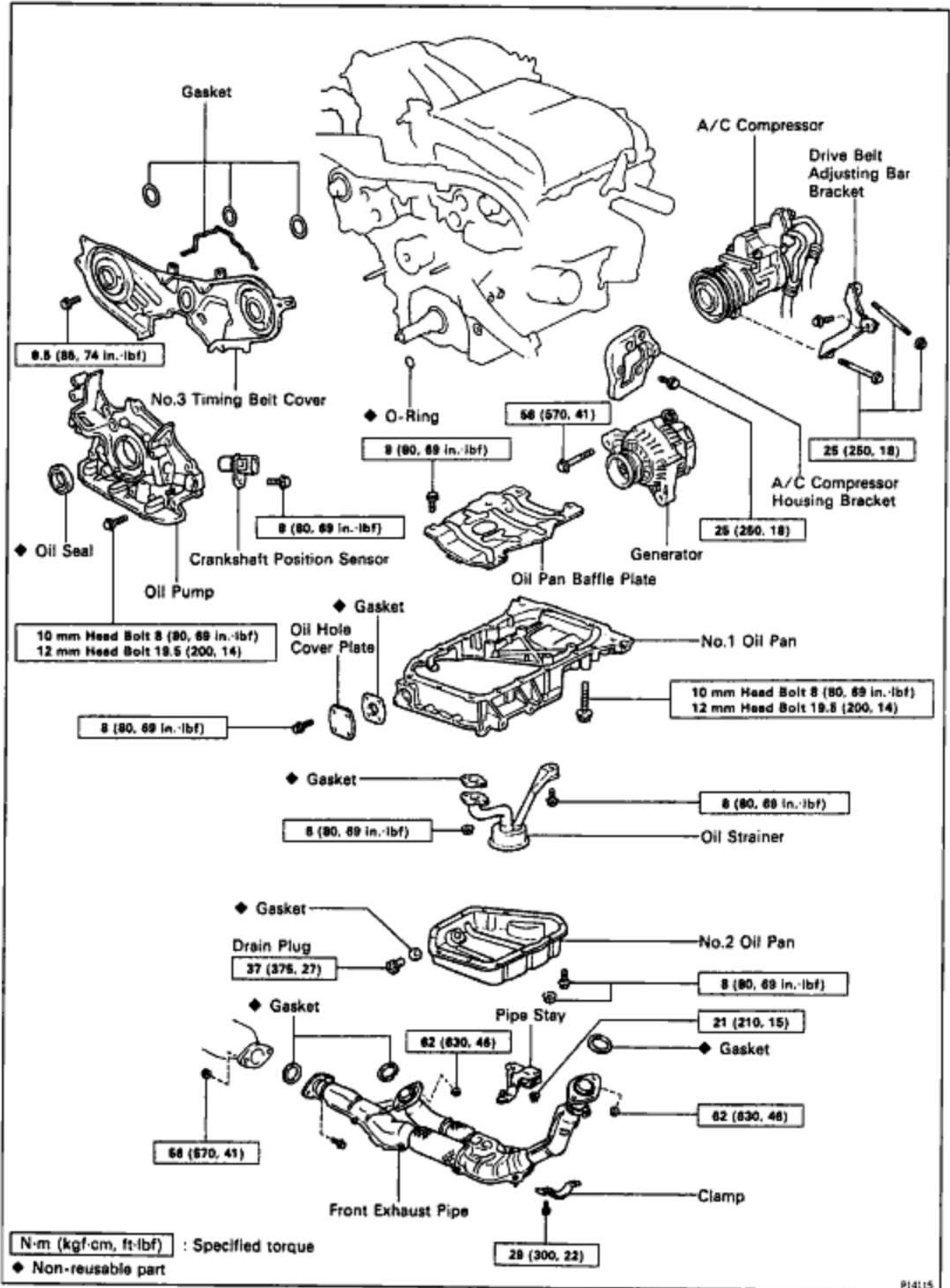

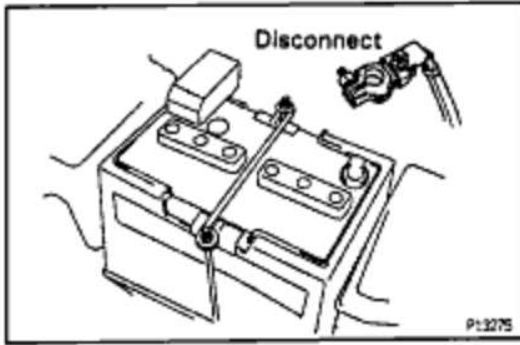

OIL PUMP REMOVAL

(See Components for Removal and Installation)

HINT: When repairing the oil pump, the oil pan and strainer should be removed and cleaned.

1. DISCONNECT NEGATIVE (-) TERMINAL CABLE FROM BATTERY

CAUTION: Work must be started after 90 seconds from the time the Ignition switch is turned to the 'LOCK' position and the negative (-) terminal cable is disconnected from the battery.

2. DRAIN ENGINE OIL

3. REMOVE OIL DIPSTICK

4. REMOVE TIMING BELT

(See step 2 to 20 on pages EG2-41 to 45)

5. REMOVE TIMING PULLEYS

(See step 21 to 24 on pages EG2-45 to 47)

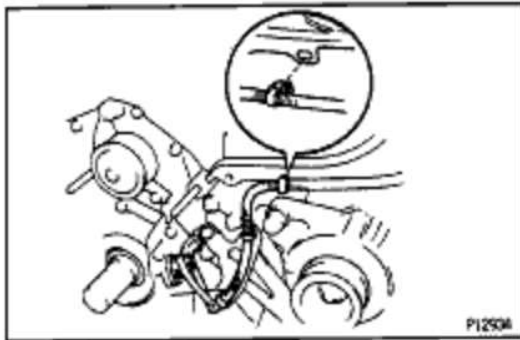

6. DISCONNECT ENGINE WIRE

- (a) Disconnect the crankshaft position sensor connector.
- (b) Disconnect the engine wire from the wire clamp.

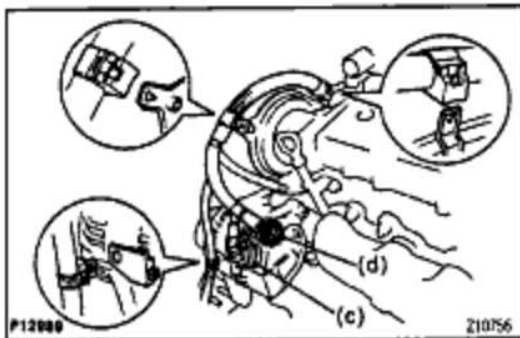

- (c) Disconnect the generator connector.
- (d) Remove the nut and disconnect the generator wire.
- (e) Disconnect the engine wire from the 3 clamps.

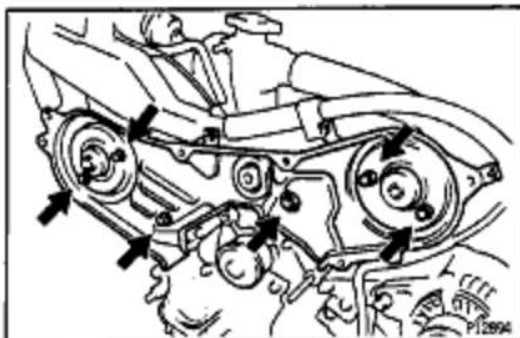

7. REMOVE No.3 TIMING BELT COVER

Remove the 6 bolts and belt cover.

EG2-378

1MZ-FE ENGINE - LUBRICATION SYSTEM

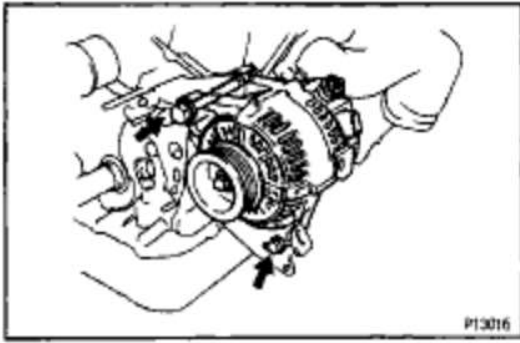
**8. REMOVE GENERATOR**

Remove the 2 bolts and generator.

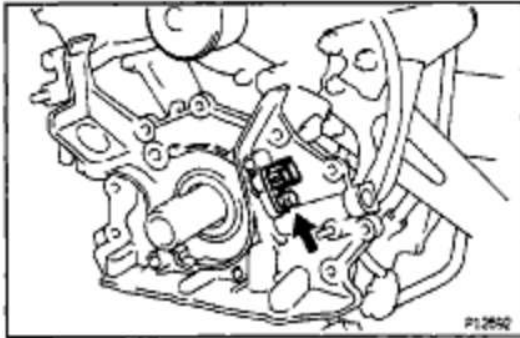
**9. REMOVE CRANKSHAFT POSITION SENSOR**

Remove the bolt and position sensor.

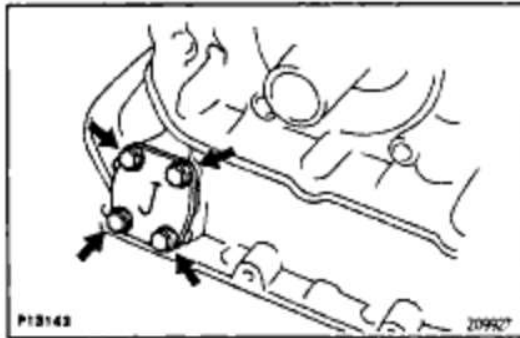
**10. REMOVE OIL HOLE COVER PLATE**

Remove the 4 bolts and cover plate.

**11. REMOVE A/C COMPRESSOR WITHOUT DISCONNECTING HOSES**

- (a) Disconnect the A/C compressor connector.
- (b) Remove the drive belt.
- (c) Remove the 5 bolts, 2 nuts and drive belt adjusting bar bracket, and disconnect the A/C compressor.
- (d) Move the compressor aside and suspend it.

**12. REMOVE A/C COMPRESSOR HOUSING BRACKET**

Remove the 3 bolts and A/C compressor housing bracket.

1MZ-FE ENGINE - LUBRICATION SYSTEM

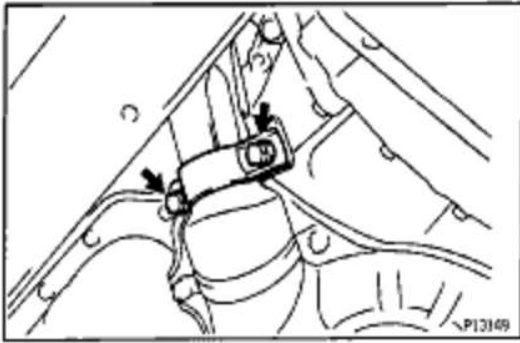
**13. REMOVE FRONT EXHAUST PIPE**

(a) Remove the 2 bolts and exhaust pipe clamp.

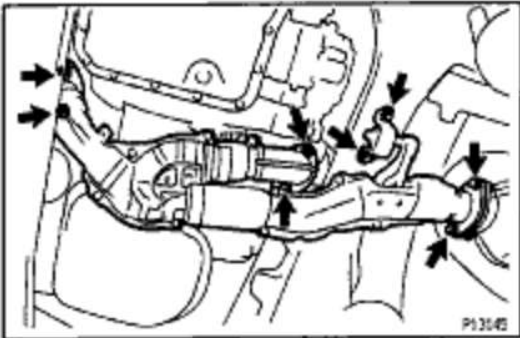

(b) Remove the 2 bolts, and disconnect the bracket.

(c) Remove the 2 bolts and 2 nuts holding the front exhaust pipe to the three-way catalytic converter.

(d) Remove the 4 nuts holding the front exhaust pipe to the exhaust manifolds.

(e) Remove the front exhaust pipe and 3 gaskets.

14. REMOVE FRONT EXHAUST PIPE STAY

Remove the 2 bolts and pipe stay.

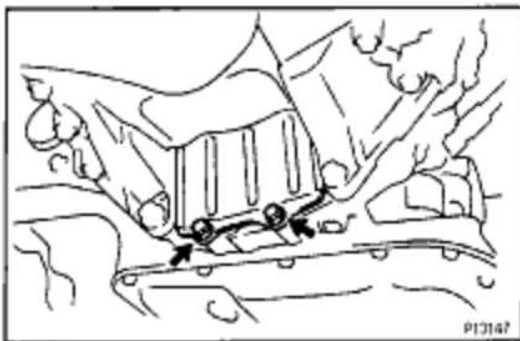
**15. REMOVE FLYWHEEL HOUSING UNDERCOVER**

Remove the 2 bolts and undercover.

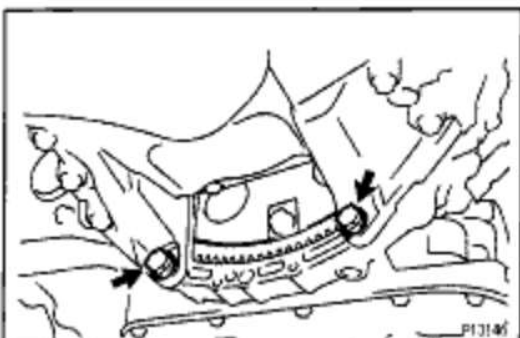
**16. REMOVE BOLTS HOLDING NO.1 OIL PAN TO TRANSAXLE**

Remove the 2 bolts.

EG2-380

1MZ-FE ENGINE - LUBRICATION SYSTEM

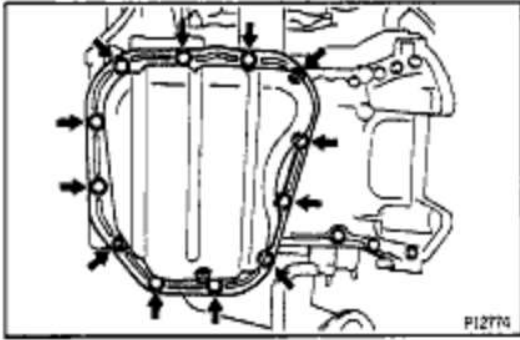
**17. REMOVE NO.2 OIL PAN**

(a) Remove the 10 bolts and 2 nuts.

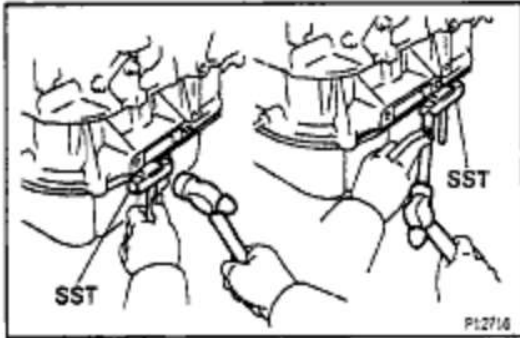

(b) Insert the blade of SST between the No. 1 and No.2 oil pans, and cut off applied sealer and remove the No. 1 oil pan.

SST 09032 - 00100

NOTICE:

- Be careful not to damage the No.2 oil pan contact surface of the No.1 oil pan.
- Be careful not to damage the No..2 oil pan flange.

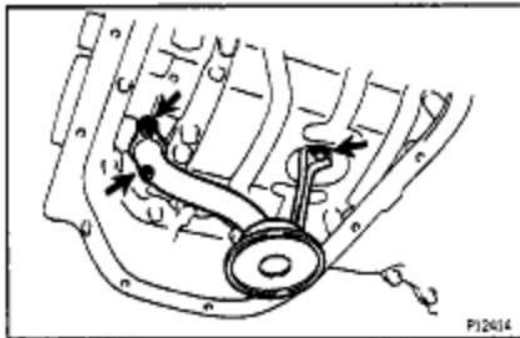
**18. REMOVE OIL STRAINER**

Remove the bolt, 2 nuts, oil strainer and gasket.

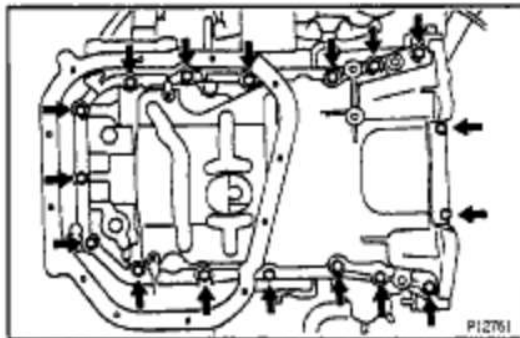
**19. REMOVE NO.1 OIL PAN**

(a) Remove the 17 bolts.

1MZ-FE ENGINE - LUBRICATION SYSTEM

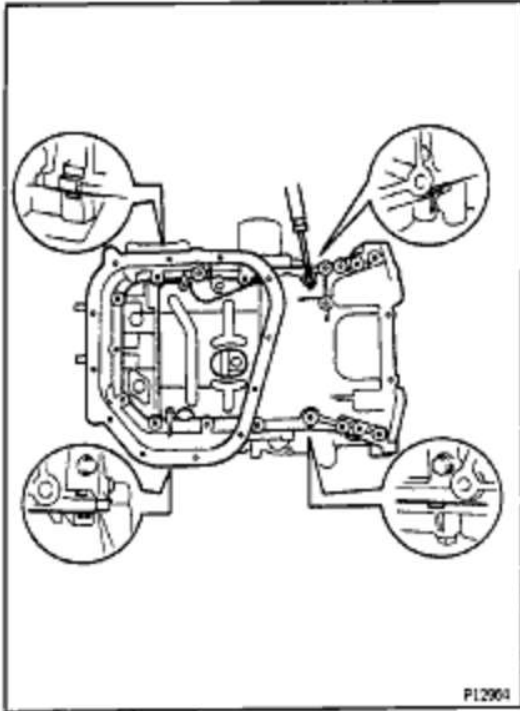

(b) Using a screwdriver, remove the No. 1 oil pan by prying the portions between the cylinder block and No.1 oil pan.

NOTICE: Be careful not to damage the contact surfaces of the cylinder block and No.1 oil pan.

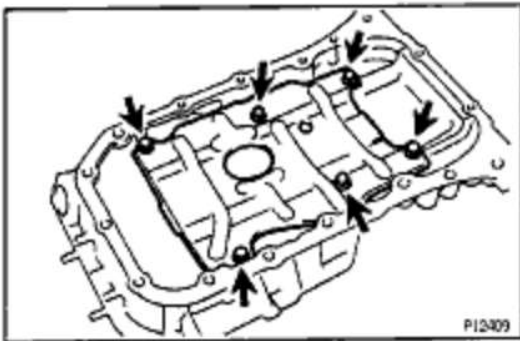

20. REMOVE OIL PAN BAFFLE PLATE

Remove the 6 bolts and baffle plate.

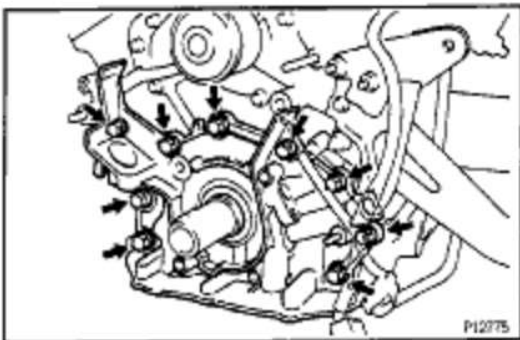

21. REMOVE OIL PUMP

(a) Remove the 9 bolts.

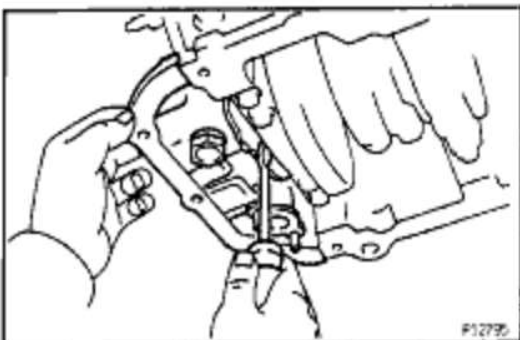

(b) Remove the oil pump by prying a screwdriver between the oil pump and main bearing cap.

(c) Remove the O-ring.

EG2-382

1MZ-FE ENGINE - LUBRICATION SYSTEM

COMPONENTS FOR DISASSEMBLY AND ASSEMBLY

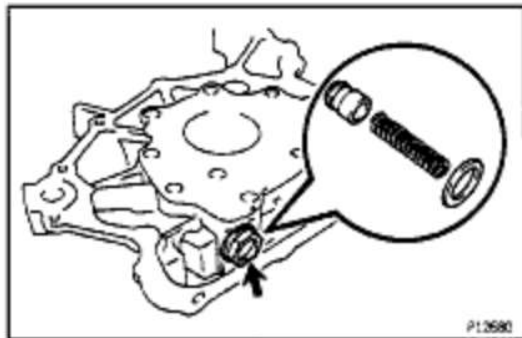
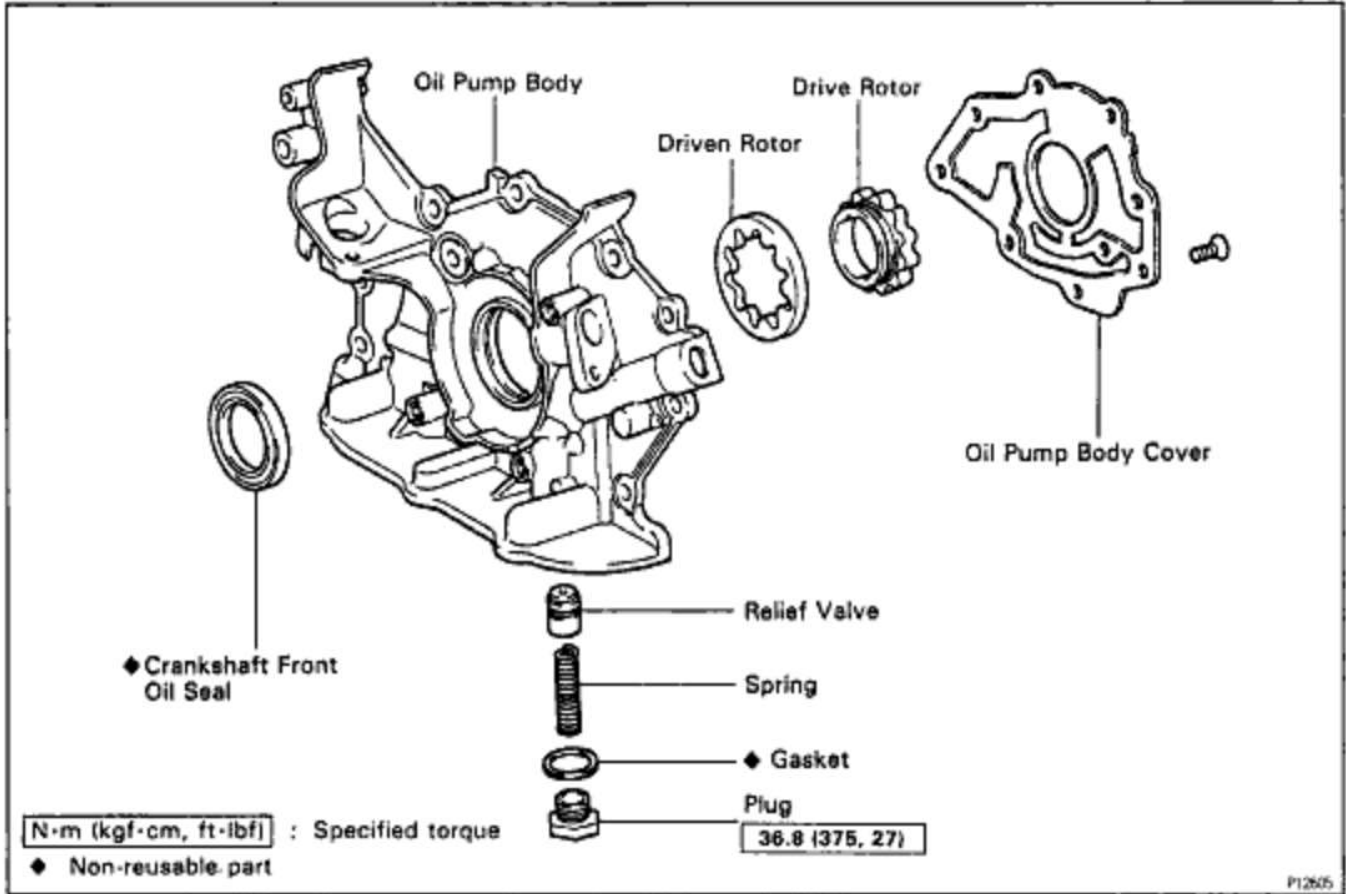

OIL PUMP DISASSEMBLY

1. REMOVE RELIEF VALVE

Remove the plug, gasket, spring and relief valve.

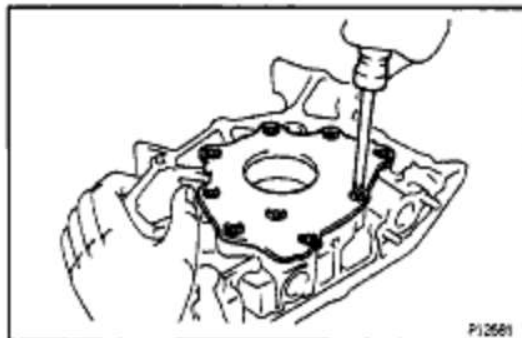

2. REMOVE DRIVE AND DRIVEN ROTORS

Remove the 9 screws, pump body cover, drive and driven rotors.

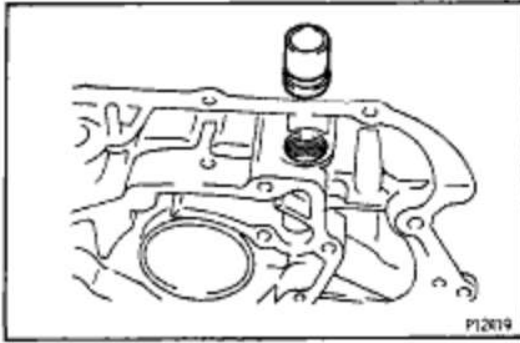

OIL PUMP INSPECTION

1. INSPECT RELIEF VALVE

Coat the valve with engine oil and check that it falls smoothly into the valve hole by its own weight.

If it does not, replace the relief valve. If necessary, replace the oil pump assembly.

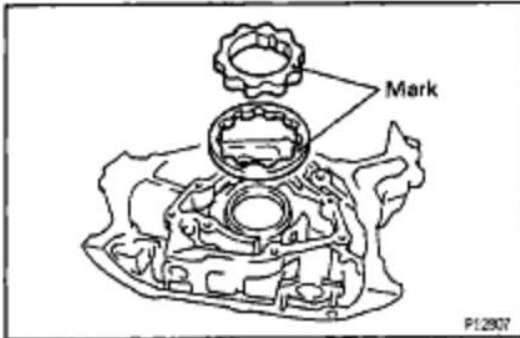

2. INSPECT DRIVE AND DRIVEN ROTORS

A. Place drive and driven rotors into oil pump body

Place the drive and driven rotors into the oil pump body with the mark facing upward.

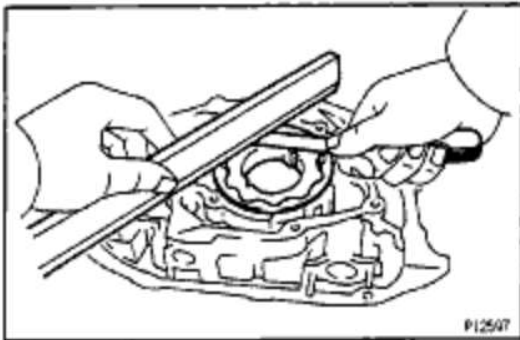

B. Inspect rotor side clearance

Using a feeler gauge and precision straight edge, measure the clearance between the rotors and precision straight edge.

Standard side clearance:

0.030 – 0.090 mm (0.0012 – 0.0035 in.)

Maximum side clearance:

0.15 mm (0.0059 in.)

If the side clearance is greater than maximum, replace the rotors as a set. If necessary, replace the oil pump assembly.

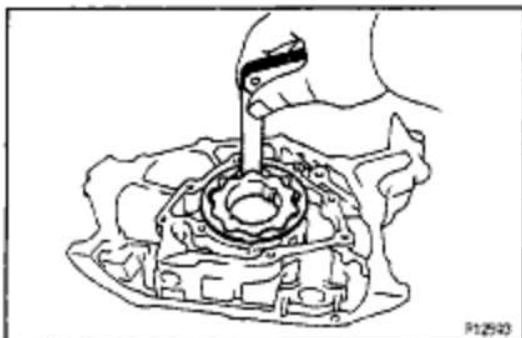

C. Inspect rotor tip clearance

Using a feeler gauge, measure the clearance between the drive and driven rotor tips.

Standard tip clearance:

0.110 – 0.240 mm (0.0043 – 0.0094 in.)

Maximum tip clearance:

0.35 mm (0.0138 in.)

If the tip clearance is greater than maximum, replace the rotors as a set.

EG2-384

1MZ-FE ENGINE - LUBRICATION SYSTEM

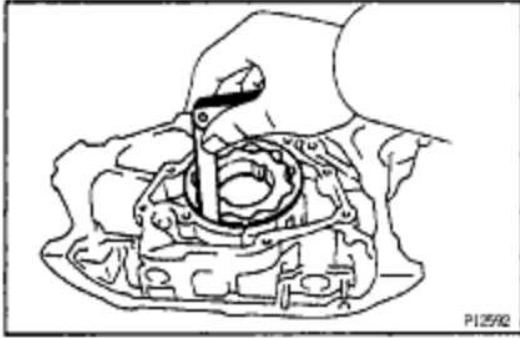
**D. Inspect rotor body clearance**

Using a feeler gauge, measure the clearance between the driven rotor and body.

Standard body clearance:

0.100 – 0.175 mm (0.0039 – 0.0069 in.)

Maximum body clearance:

0.30 mm (0.0118 in.)

If the body clearance is greater than maximum, replace the rotors as a set. If necessary, replace the oil pump assembly.

18MC-08

CRANKSHAFT FRONT OIL SEAL REPLACEMENT

HINT: There are 2 methods (A and B) to replace the oil seal which are as follows:

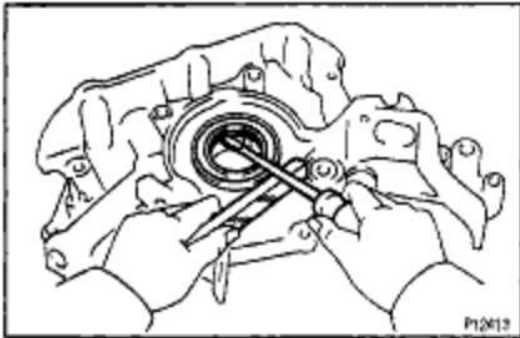
**REPLACE CRANKSHAFT FRONT OIL SEAL****A. If oil pump is removed from cylinder block:**

(a) Using a screwdriver, pry out the oil seal.

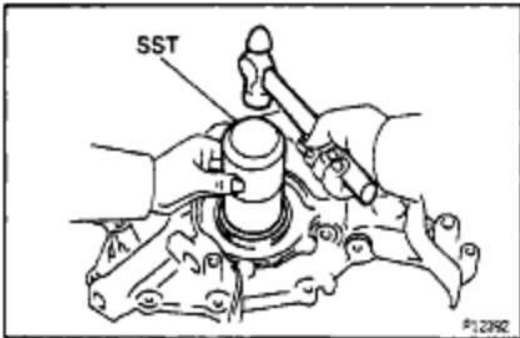

(b) Using SST and a hammer, tap in a new oil seal until its surface is flush with the oil pump body edge.

SST 09223 – 00010

(c) Apply MP grease to the oil seal lip.

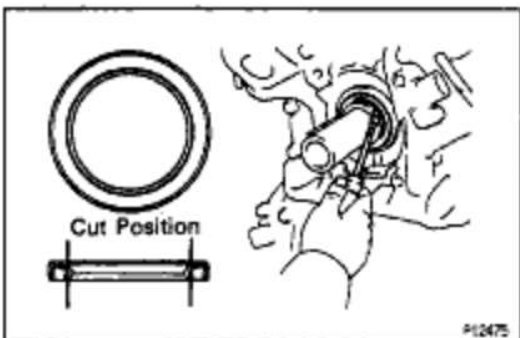
**B. If oil pump is installed to the cylinder block:**

(a) Using a knife, cut off the oil seal lip.

(b) Using a screwdriver, pry out the oil seal.

NOTICE: Be careful not to damage the crankshaft. Tape the screwdriver tip.



- (c) Apply MP grease to a new oil seal lip.
 (d) Using SST and a hammer, tap in the oil seal until its surface is flush with the oil pump body edge.
 SST 09223 - 00010

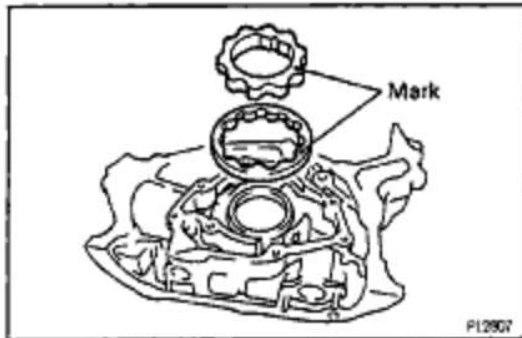

OIL PUMP ASSEMBLY

(See Components for Disassembly and Assembly)

1. INSTALL DRIVE AND DRIVEN ROTORS

- (a) Place the drive and driven rotors into pump body with the marks facing the pump body cover side.

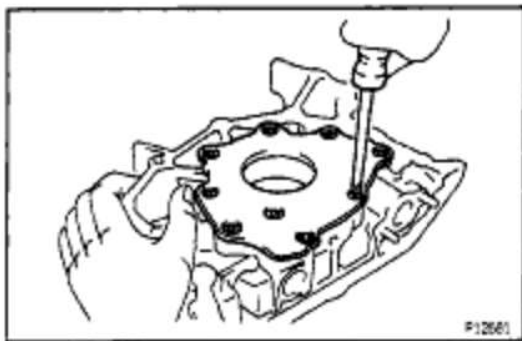

- (b) Install the pump body cover with the 9 screws.

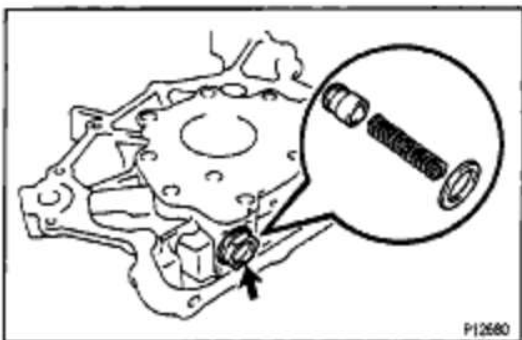

2. INSTALL RELIEF VALVE

- (a) Insert the relief valve and spring into the pump body hole.

- (b) Install the plug with a new gasket.

Torque: 36.8 N-m (375 kgf-cm, 37 ft-lbf)

EG2-386

1MZ-FE ENGINE - FE ENGINE - LUBRICATION SYSTEM

MSP-01

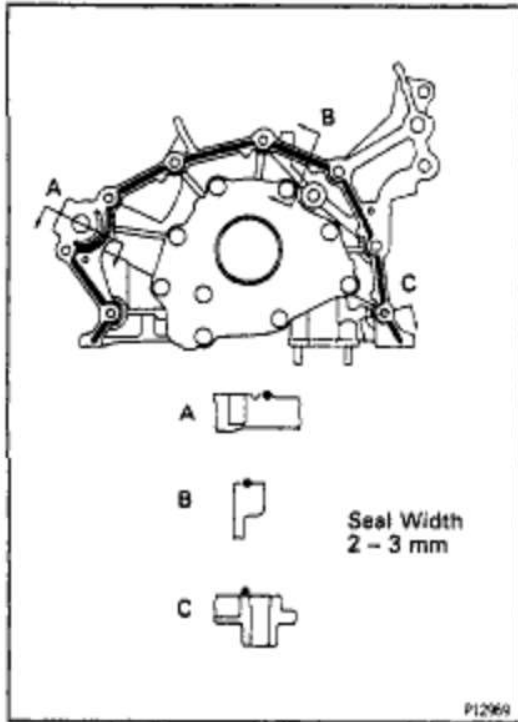
**OIL PUMP INSTALLATION**

(See Components for Removal and Installation)

1. INSTALL OIL PUMP

(a) Remove any old packing (FIPG) material and be careful not to drop any oil on the contact surfaces of the oil pump and cylinder block.

- Using a razor blade and gasket scraper, remove all the old packing (FIPG) material from the gasket surfaces and sealing grooves.
- Thoroughly clean all components to remove all the loose material.
- Using a non-residue solvent, clean both sealing surfaces.

(b) Apply seal packing to the oil pump as shown in the illustration.

Seal packing:**Part No. 08826-00080 or equivalent**

- Install a nozzle that has been cut to a 2-3 mm (0.08-0.12 in.) opening.

HINT: Avoid applying an excessive amount to the surface.

- Parts must be assembled within 3 minutes of application. Otherwise the material must be removed and reapplied.
- Immediately remove nozzle from the tube and reinstall cap.

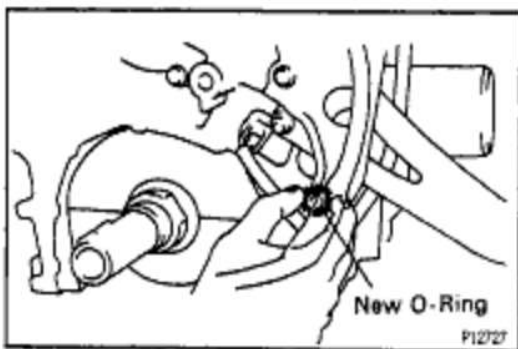

(c) Place a new O - ring in position on the cylinder block.

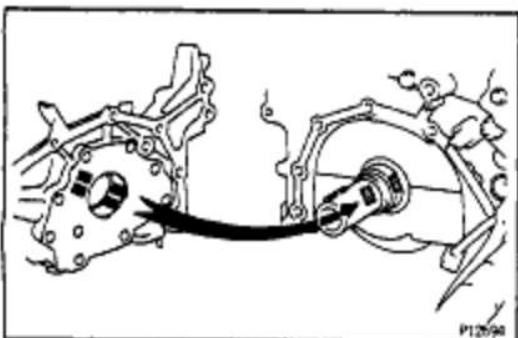

(d) Engage the spline teeth of the oil pump drive gear with the large teeth of the crankshaft, and slide the oil pump on the crankshaft.

1MZ-FE ENGINE - LUBRICATION SYSTEM

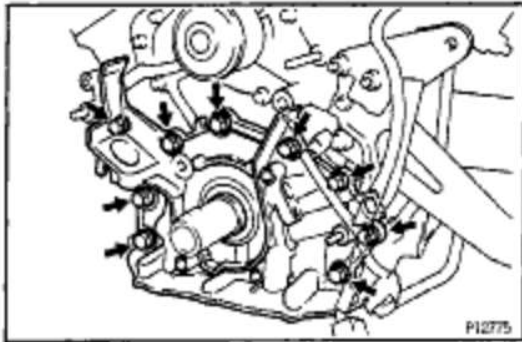

(e) Install the oil pump with the 9 bolts.

Torque:

8 N-m (80 kgf-cm, 69 in.-lbf) for 10 mm head bolt

19.5 N-m (200 kgf-cm, 14 ft.-lbf) for 12 mm head bolt

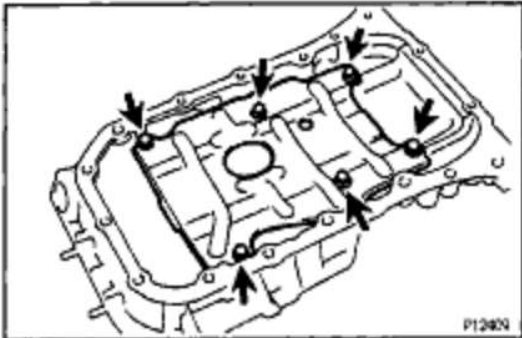

2. INSTALL OIL PAN BAFFLE PLATE

Install the baffle plate with the 6 bolts.

Torque: 8 N-m (80 kgf-cm, 69 in.-lbf)

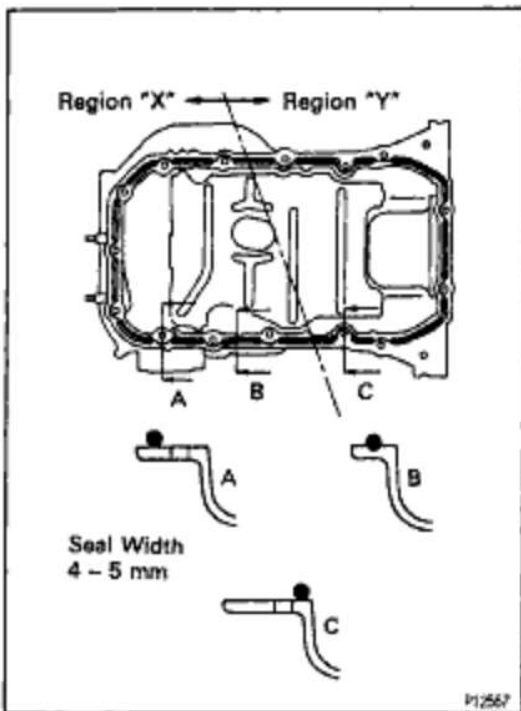

3. INSTALL NO.1 OIL PAN

(a) Remove any old packing (FIPG) material and be careful not to drop any oil on the contact surfaces of the oil pan, oil pump and cylinder block.

- Using a razor blade and gasket scraper, remove all the old packing (FIPG) material from the gasket surfaces and sealing grooves.
- Thoroughly clean all components to remove all the loose material.
- Using a non-residue solvent, clean both sealing surfaces.

(b) Apply seal packing to the oil pan as shown in the illustration.

Seal packing:

Part No. 08826-00080 or equivalent

Region "X" is at the outer side of the bolt hole.

Region "Y" is at the inner side of the bolt hole.

- Install a nozzle that has been cut to a 4-5 mm (0.16-0.20 in.) opening.

HINT: Avoid applying an excessive amount to the surface.

- Parts must be assembled within 3 minutes of application. Otherwise the material must be removed and reapplied.
- Immediately remove nozzle from the tube and reinstall cap.

EG2-388

1MZ-FE ENGINE - LUBRICATION SYSTEM

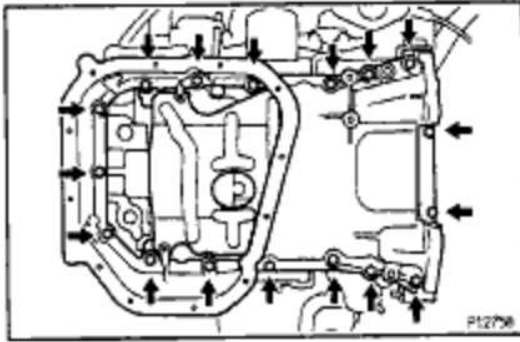

(c) Install the oil pan with the 17 bolts.

Torque:

- 8 N-m (80 kgf-cm, 69 in.-lbf) for 10 mm head bolt**
- 19.5 N-m (200 kgf-cm, 14 ft-lbf) for 12 mm head bolt**

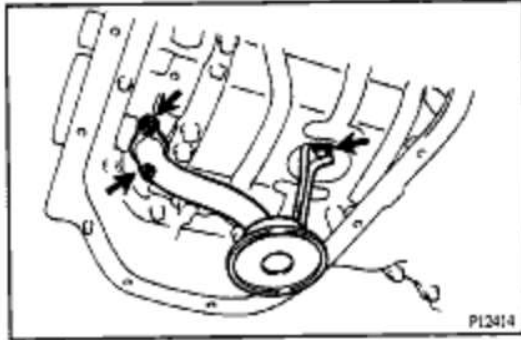
**4. INSTALL OIL STRAINER**

Install a new gasket and the oil strainer with the bolt and 2 nuts.

Torque: 8 N-m (80 kgf-cm, 69 in.-lbf)

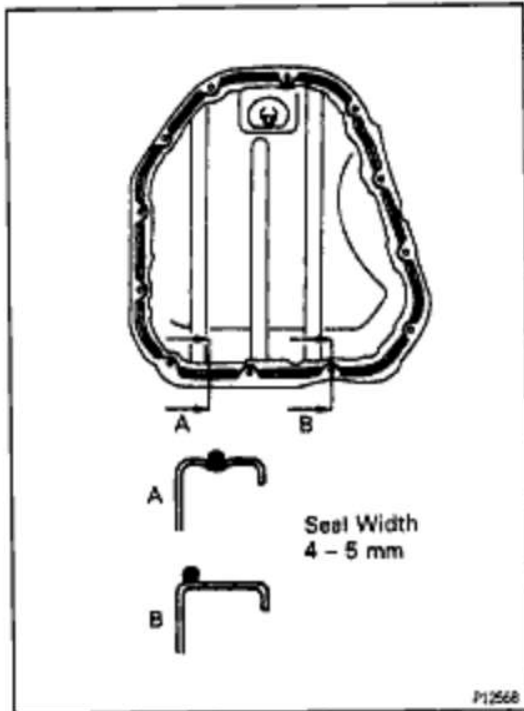
**5. INSTALL NO.2 OIL PAN**

(a) Remove any old packing (FIPG) material and be careful not to drop any oil on the contact surface of the No. 1 and No.2 oil pans.

- Using a razor blade and gasket scraper, remove all the old packing (FIPG) material from the gasket surfaces and sealing grooves.
- Thoroughly clean all components to remove all the loose material.
- Using a non-residue solvent, clean both sealing surfaces.

NOTICE: Do not use a solvent which will affect the painted surfaces.

(b) Apply seal packing to the No.2 oil pan as shown in the illustration.

Seal packing:

Part No. 088218-00080 or equivalent

- Install a nozzle that has been cut to a 4-5 mm (0.16 - 0.20 in.) opening.

HINT: Avoid applying an excessive amount to the surface.

- Parts must be assembled within 3 minutes an application. Otherwise the material must be removed and reapplied.
- Immediately remove nozzle from the tube and reinstall cap.

1MZ-FE ENGINE - LUBRICATION SYSTEM

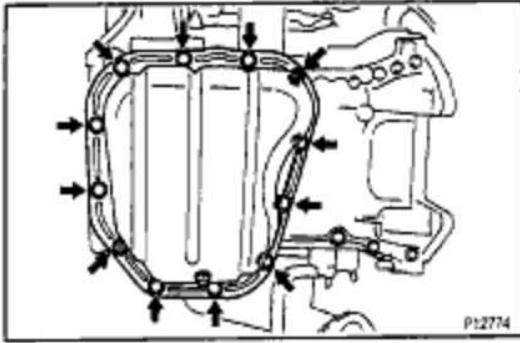

(c) Install the No.2 oil pan with the 10 bolts and 2 nuts.

Torque: 8 N-m (80 kgf-cm, 69 in.-lbf)

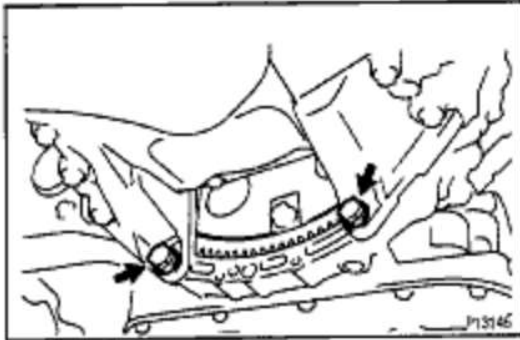

6. INSTALL BOLTS HOLDING NO.1 OIL PAN TO TRANSAXLE

Install the 2 bolts.

Torque: 37 N-m (380 kgf-cm, 27 ft-lbf)

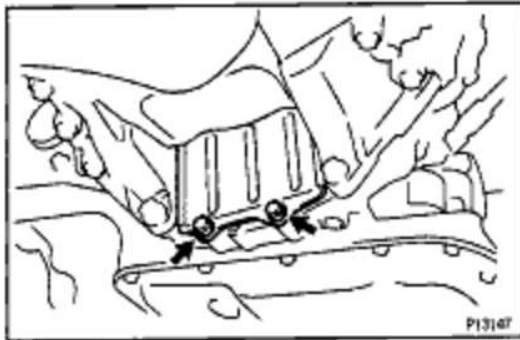

7. INSTALL FLYWHEEL HOUSING UNDERCOVER

Install the undercover with the 2 bolts.

Torque: 7.8 N-m (80 kgf-cm, 69 in.-lbf)

8. INSTALL FRONT EXHAUST PIPE STAY

Install the pipe stay with the 2 bolts.

Torque: 21 N-m (210 kgf-cm, 15 ft-lbf)

9. INSTALL FRONT EXHAUST PIPE

(a) Temporarily install 3 new gaskets and the front exhaust pipe with the 2 bolts and 6 nuts.

(b) Tighten the 4 nuts holding the exhaust manifolds to the front exhaust pipe.

Torque: 62 N-m (630 kgf-cm, 46 ft-lbf)

(c) Tighten the 2 bolts and 2 nuts holding the three-way catalytic converter to the front exhaust pipe.

Torque: 56 N-m (570 kgf-cm, 41 ft-lbf)

(d) Connect the bracket with the 2 bolts.

Torque: 19 N-m (195 kgf-cm, 14 ft-lbf)

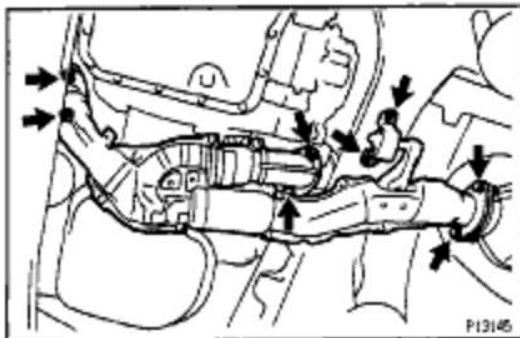

EG2-390

1MZ-FE ENGINE - LUBRICATION SYSTEM

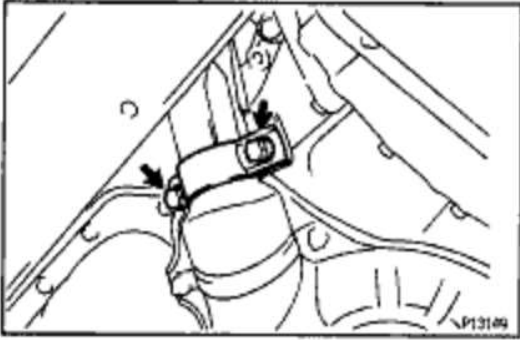

(e) Connect the front exhaust pipe clamp with the 2 bolts.
Torque: 29 N-m (300 kgf-cm, 22 ft-lbf)

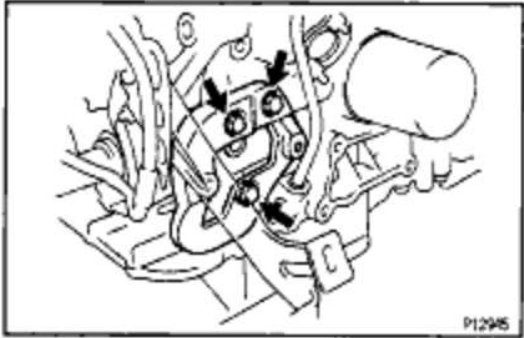

10. INSTALL A/C COMPRESSOR HOUSING BRACKET
Install the housing bracket with the 3 bolts.
Torque: 26 N-m (250 kgf-cm, 18 ft-lbf)



11. INSTALL A/C COMPRESSOR
(a) Install the A/C compressor and drive belt adjusting bar bracket with the 5 bolts.
Torque: 25 N-m (250 kgf-cm, 18 ft-lbf)

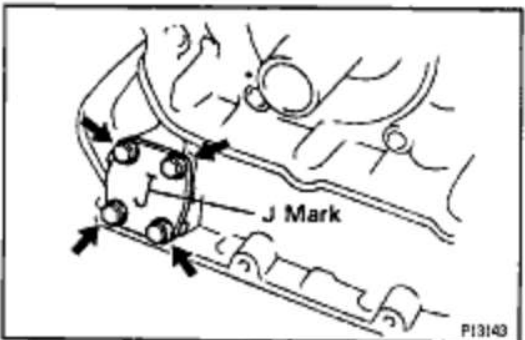

12. INSTALL OIL HOLE COVER PLATE
Install a new gasket and the hole cover plate (J mark facing outward) with the 4 bolts.
Torque: 8 N-m (80 kgf-cm, 69 in.-lbf)

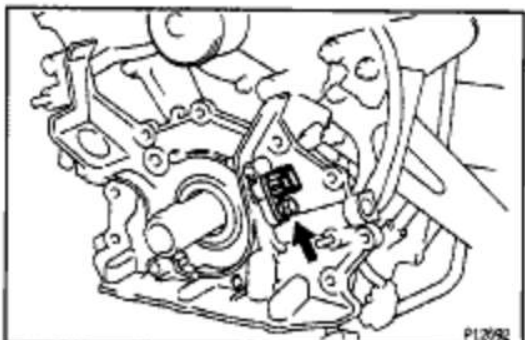

13. INSTALL CRANKSHAFT POSITION SENSOR
Install the position sensor with the bolt.
Torque: 8 N-m (80 kgf-cm, 89 in.-lbf)

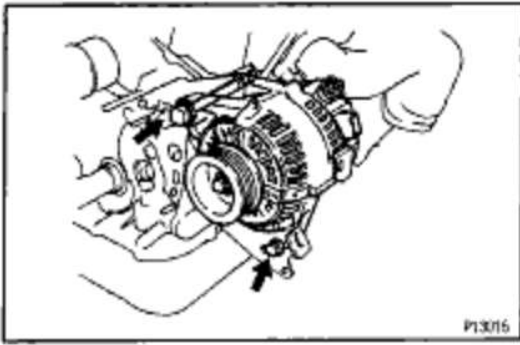

14. INSTALL GENERATOR

Install the generator with the 2 bolts. Do not tighten the bolts yet.

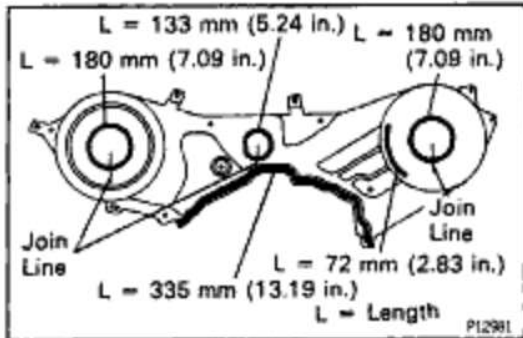

15. INSTALL NO.3 TIMING BELT COVER

(a) Check that the timing belt cover gaskets have no cracks or peeling, etc.

If the gaskets do have cracks or peeling etc., replace them using the following steps.

(1) Using a screwdriver and gasket scraper, remove all the old gasket material.

(2) Thoroughly clean all components to remove all the loose material.

(3) Remove the backing paper from a new gasket and install the gasket evenly to the part of the belt cover shaded black in the illustration.

NOTICE: When joining gaskets, do not leave a gap between them. Cut off any excess gasket.

(4) After installing the gasket, press down on it so that the adhesive firmly sticks to the belt cover.

(b) Install new gaskets to the No.3 belt cover.

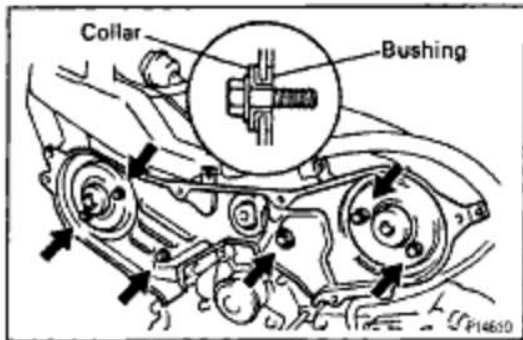

(c) Install the belt cover with the 6 bolts.

Torque: 8.5 N-m (85 kgf-cm. 74 in.-lbf)

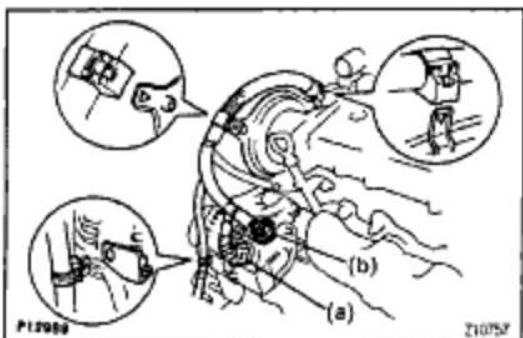

16. CONNECT ENGINE WIRE

(a) Connect the generator connector.

(b) Connect the generator wire with the nut.

(c) Connect the engine wire with the 3 clamps.

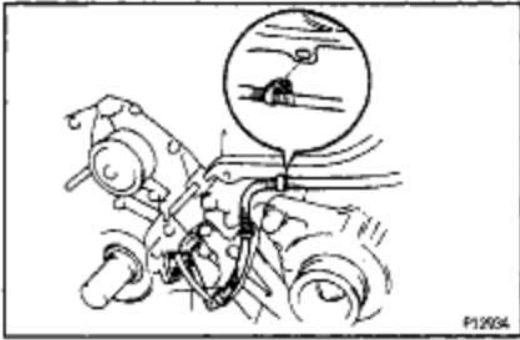
EG2-392**1MZ-FE ENGINE - LUBRICATION SYSTEM**

- (d) Connect the crankshaft position sensor connector.
- (e) Connect the engine wire with the wire clamp.

17. INSTALL TIMING PULLEYS

(See steps 1 to 5 on pages [EG2-49](#), 50)

18. INSTALL TIMING BELT

(See steps 6 to 27 on pages [EG2-51](#) to 66)

19. FILL ENGINE WITH OIL

Capacity:

Drain and refill

w/ Oil filter change

4.7 liters (5.0 US qts, 4.1 Imp. qts)

w/o Oil filter change

4.5 liters (4.8 US qts, 4.0 Imp. qts)

20. CONNECT NEGATIVE (-) TERMINAL CABLE TO BATTERY**21. START ENGINE AND CHECK FOR LEAKS****22. RECHECK ENGINE OIL LEVEL**

SERVICE SPECIFICATIONS

SERVICE DATA

Oil pressure	At idle speed (normal operating temperature) At 3,000 rpm (normal operating temperature)	29 kPa (0.3 kgf/cm², 43 psi) or more 294 - 539 kPa (3.0 - 5.5 kgf/cm², 43 - 78 psi)
Oil pump	Side clearance	STD Maximum
	Body clearance	STD Maximum
	Tip clearance	STD Maximum
		0.030 - 0.090 mm (0.0012 - 0.0035 in.) 0.15 mm (0.0059 in.) 0.100 - 0.175 mm (0.0039 - 0.0069 in.) 0.30 mm (0.0118 in.) 0.110 - 0.240 mm (0.0043 - 0.0094 in.) 0.35 mm (0.0138 in.)

TORQUE SPECIFICATIONS

Pert tightened	N-m	kgf-cm	ft-lbf
Oil pressure switch x Cylinder block	13	130	9
No.2 oil pan x Drain plug	37	375	27
Oil pump x Plug (for relief valve)	38.8	375	37
Oil pump x Cylinder block (10 mm head bolt)	8	80	69 in.-lbf
Oil pump x Cylinder block (12 mm head bolt)	19.5	200	14
Oil pan baffle plate x No.1 oil pan	8	80	69 in.-lbf
No.1 idler pulley x Oil pump	34	350	25
No. 1 oil pan x Cylinder block	19.5	200	14
No. 1 oil pan x Oil pump	8	80	69 in.-lbf
No.1 oil pan x Rear oil seal retainer	8	80	69 in.-lbf
Oil strainer x Main bearing cap	8	80	69 in.-lbf
Oil strainer x Oil pump	8	80	69 in.-lbf
No.2 oil pan x No. 1 oil pan	8	80	69 in.-lbf
Flywheel housing under cover x Transaxle	8	80	69 in.-lbf
Exhaust pipe stay x No.1 oil pan	21	210	15
Exhaust pipe clamp x Exhaust pipe stay	29	300	22
A/C compressor housing bracket x Cylinder block	25	250	18
A/C compressor x A/C compressor housing bracket	25	255	18
Oil hole cover plate x No.2 oil pan	8	80	69 in.-lbf
No.1 oil pan x Transaxle case	37	380	27
Front exhaust pipe x Exhaust manifold	62	630	46
Front exhaust pipe x Converter	56	570	41
Crankshaft position sensor x Oil pump	8	80	69 in.-lbf
No.3 timing belt cover x Cylinder head	8.5	85	74 in.-lbf