

EG2-436

1MZ-FE ENGINE - LOCATION OF CONNECTORS

# LOCATION OF CONNECTORS

## Location of Connectors in Engine Compartment

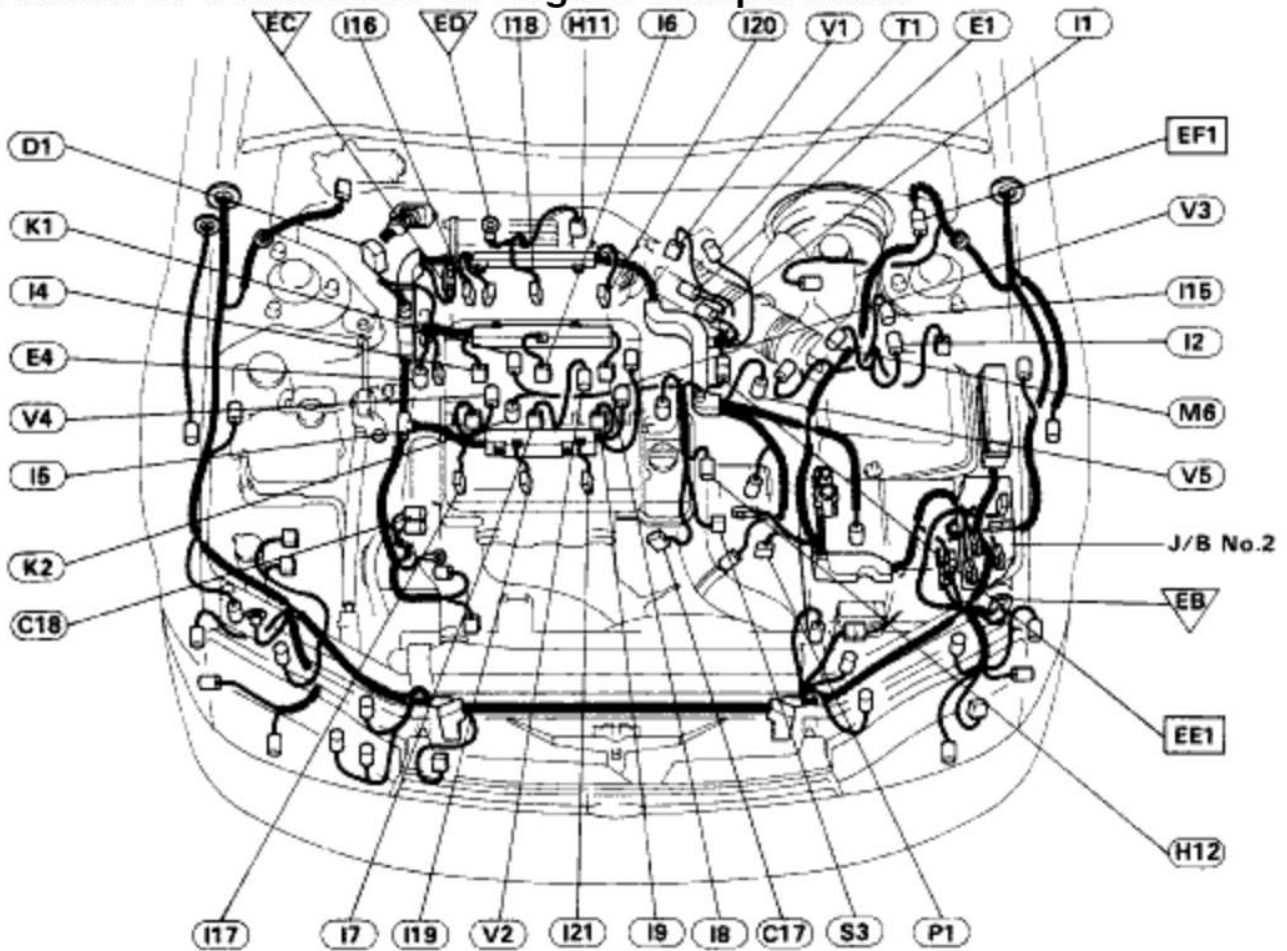

N09612

**C17**  
Camshaft  
Position Sensor



le-2-1-D

**C18**  
Crankshaft  
Position Sensor



le-2-1-D

**D1**  
Data Link Connector 1



le-23-1

**E1**  
EGR Gas  
Temp. Sensor



le-2-1-C

**E4**  
Engine Coolant Temp.  
Sensor



V-2-1-C

**H11**  
Heated Oxygen  
Sensor  
(Bank 1 Sensor 1)



le-4-1-D

**H12**  
Heated Oxygen  
Sensor  
(Bank 2 Sensor 1)



le-4-1-D

**I1**  
Idle Air Control  
Valve



le-3-1-H

1MZ-FE ENGINE - LOCATION OF CONNECTORS

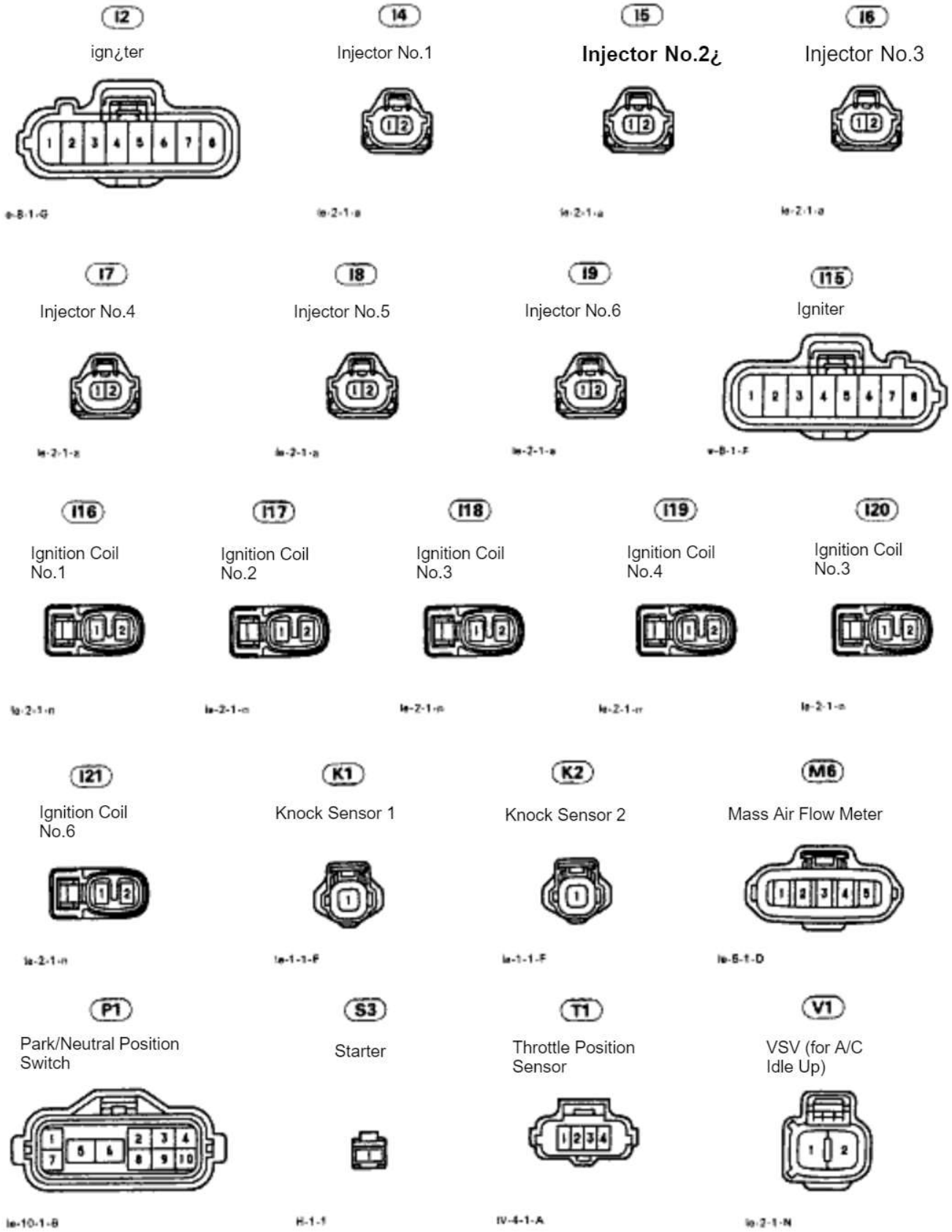

EG2-438

1MZ-FE ENGINE - LOCATION OF CONNECTORS

# Location of Connectors in Engine Compartment (Cont'd)

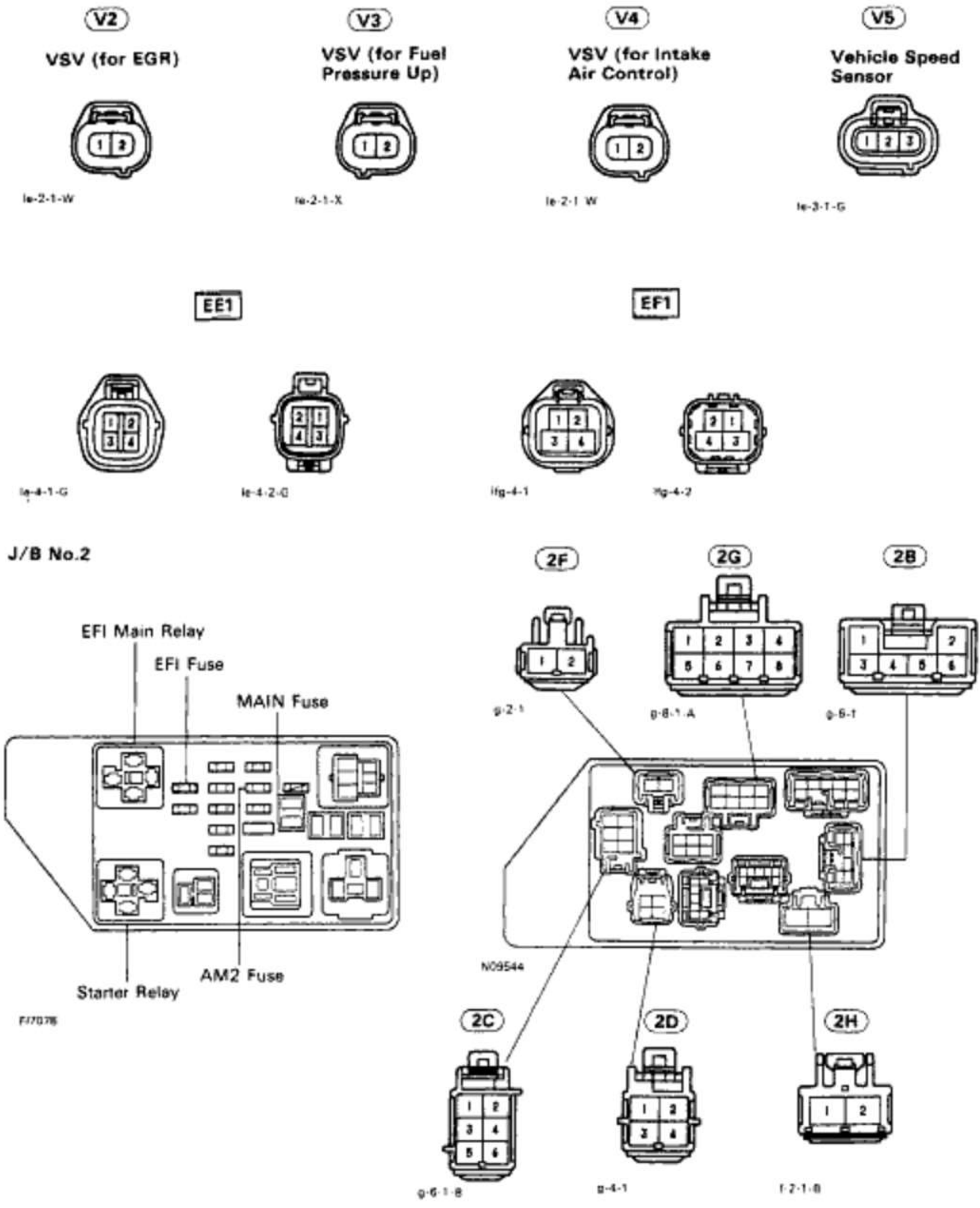

1MZ-FE ENGINE - LOCATION OF CONNECTORS

# Location of Connectors in Instrument Panel

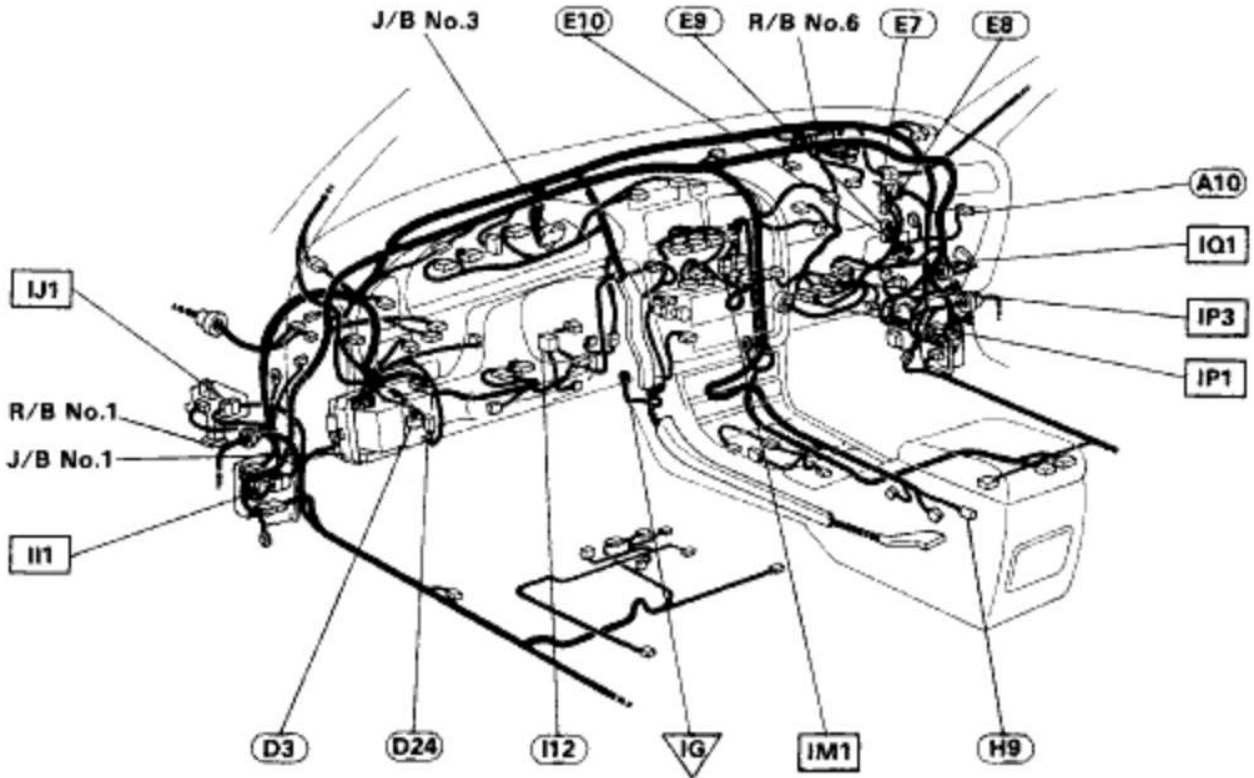

N08014

**A10**  
A/C Amplifier



n-14-1-A

**D3**  
Data Link Connector 2



S-17-1

**D24**  
Data Link Connector 3

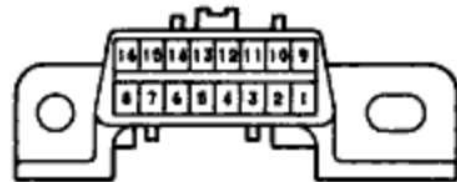

N08214

**E7**  
Engine Control Module

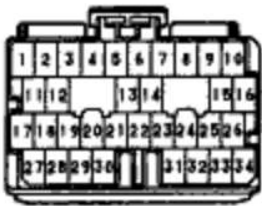

n-34-1

**E8** Engine Control Module **E9** Engine Control Module **E10** Engine Control Module



n-22-1

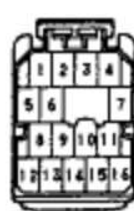

n-16-1



n-28-1

**EG2-440**

**1MZ-FE ENGINE - LOCATION OF CONNECTORS**

**H9**  
Heated Oxygen  
Sensor  
(Bank 1 Sensor 2)



ie-4-1-D

**I12**  
Ignition Switch

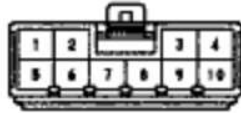

g-10-1-B

**I11**



e-10-1



e-10-2

**IJ1**



eg-19-1

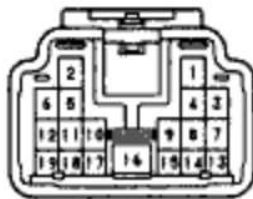

eg-19-2

**IM1**

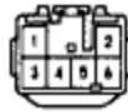

ie-6-1-A



ie-6-2-A

**IQ1**



e-6-1



e-6-2

**IP1**



e-20-1-B

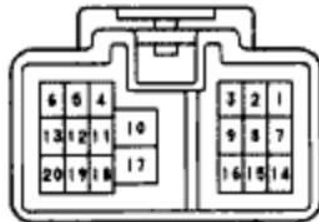

e-20-2-B

**IP3**



ef-19-1



ef-19-2

**J/B No.1**

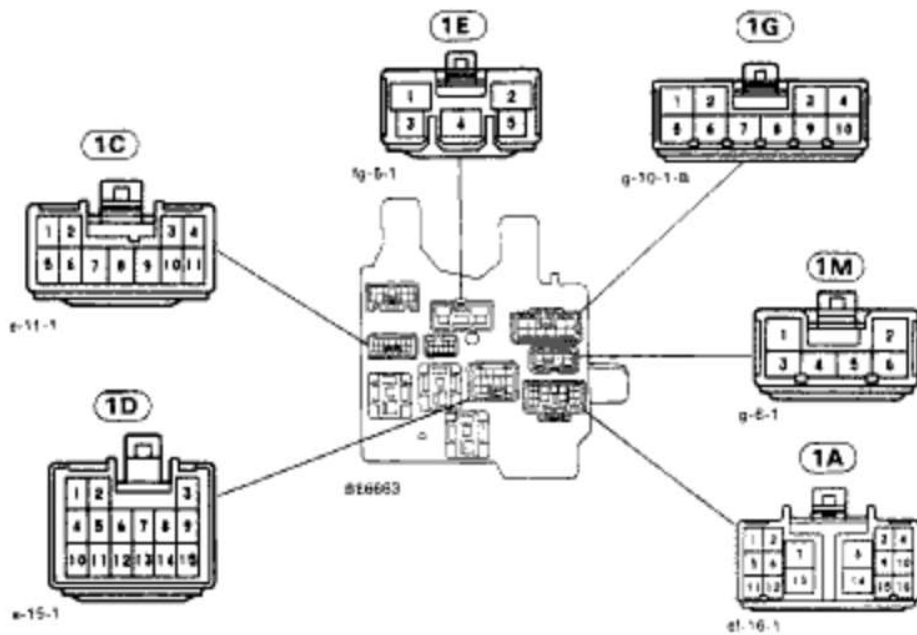

1MZ-FE ENGINE - LOCATION OF CONNECTORS

### Location of Connectors in Instrument Panel (Cont'd)

J/B No.3

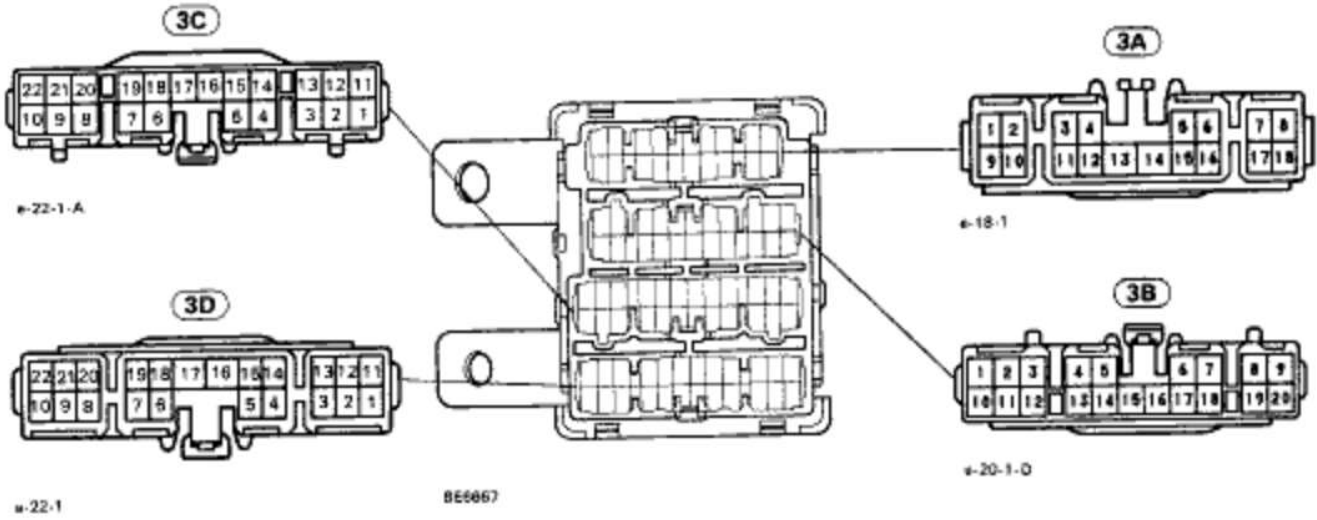

R/B No.1

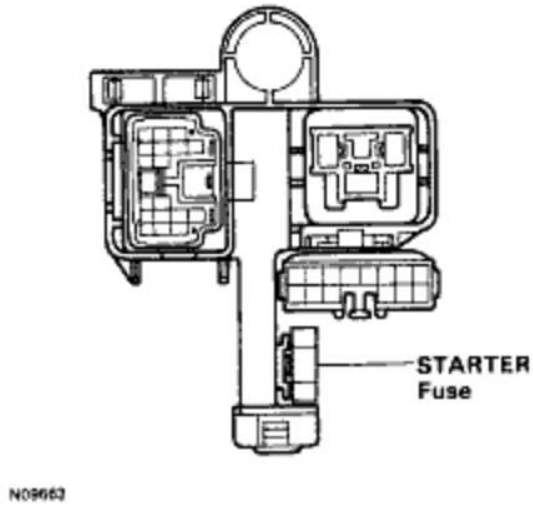

R/B No.6

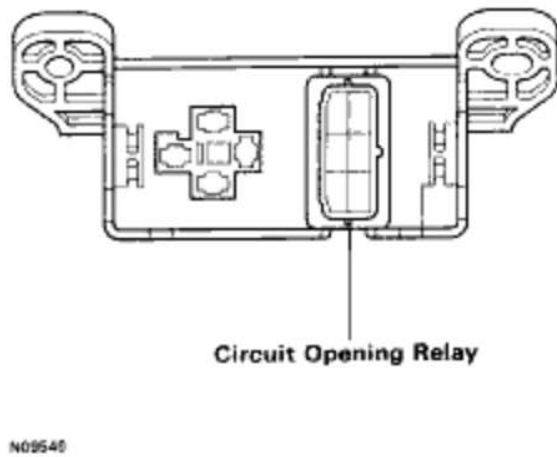

EG2-442

1MZ-FE ENGINE - LOCATION OF CONNECTORS

## Location of Connectors in Body

Sedan

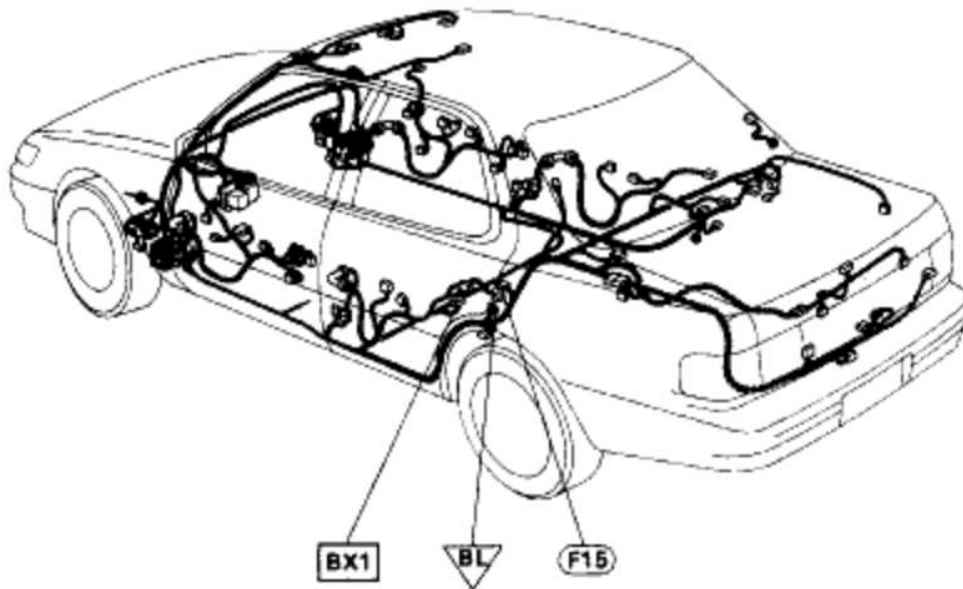

N09815

Coupe

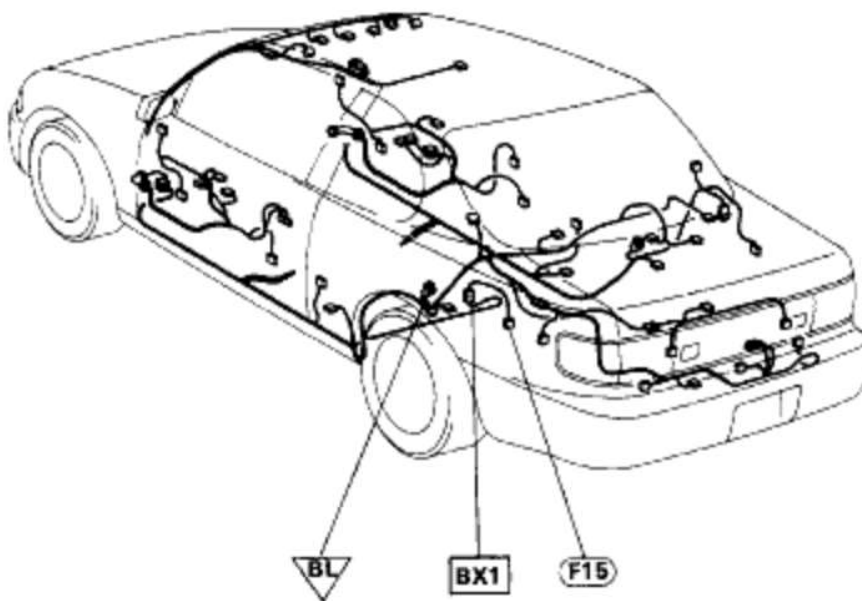

N09703

1MZ-FE ENGINE - LOCATION OF CONNECTORS

Wagon

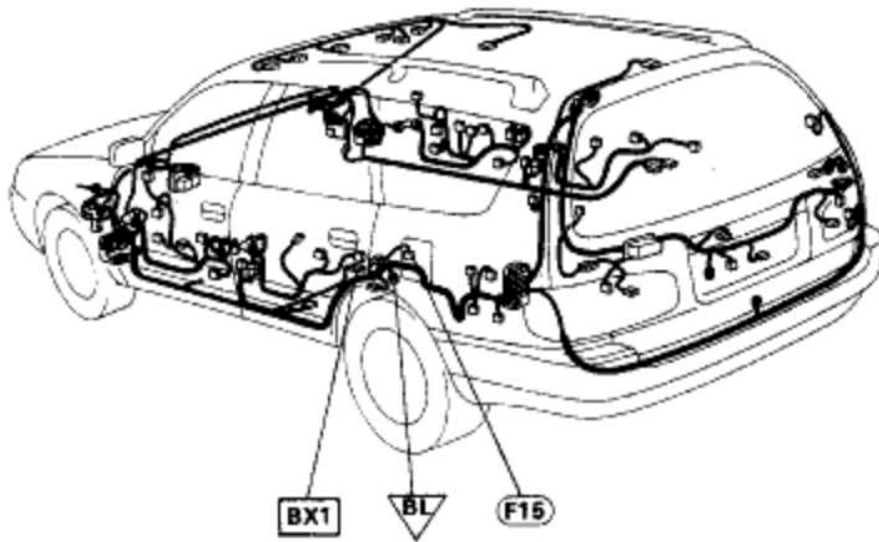

N09704

