

1MZ-FE ENGINE TROUBLESHOOTING

HOW TO PROCEED WITH TROUBLESHOOTING

The Engine Control System broadly consists of the sensors, ECM and actuators. The ECM receives signals from various sensors, judges the operating conditions and determines the optimum injection duration, timing, ignition timing and idle speed.

In general, the Engine Control System is considered to be a very intricate system to troubleshoot. But, the fact is that if you inspect each circuit in order following the procedures in this manual, troubleshooting of this system is not complex.

When troubleshooting OBDII vehicles, use an OBDII scan tool complying with SAE J1978 or TOYOTA hand-held –tester to confirm the diagnostic trouble codes, freezed frame data and engine data.

This will enable you to determine the system causing the problem.

This section explains the best method of troubleshooting and how to carry out the necessary repairs.

(1) CUSTOMER PROBLEM ANALYSIS

Using the customer problem analysis check sheet for reference, ask the customer in detail about the problem.

(2) CONNECT OBDII SCAN TOOL OR TOYOTA HAND-HELD TESTER TO DLC 3

Connect the OBDII scan tool complying with SAE J1978 or TOYOTA hand-held tester to the vehicle's data link connector 3.

NOTICE: For OBDII scan tool or TOYOTA hand-held tester operating instructions, see the instruction booklet accompanying the scan tool or tester.

If your display shows "UNABLE" TO CONNECT TO VEHICLE" when you have connected the scan tool/TOYOTA hand-held tester cable to DLC 3, turn the ignition switch ON and operate the scan tool/TOYOTA hand-held tester, inspect DLC (See page [EG2-401](#))

(3) CHECK DIAGNOSTIC TROUBLE CODE AND FREEZED FRAME DATA (PRECHECK)

First check the diagnostic trouble codes. If a code is output, make a note of it.

Also check and note the freezed frame data.

HINT: Output of the malfunction code indicates a circuit malfunction. However, it does not indicate whether the malfunction is still occurring or occurred in the past and returned to normal. To determine this, first confirm the problem symptoms in (7) and then recheck the diagnostic trouble code in (9). If troubleshooting started based only on the malfunction code in the diagnostic trouble code check in (3), it could result in a misdiagnosis and troubleshooting of circuits which are normal, making it more difficult to locate the cause of the problem.

(4) CLEAR DIAGNOSTIC TROUBLE CODE AND FREEZED FRAME DATA

Use the OBDII scan tool or TOYOTA hand-held tester to erase the diagnostic trouble codes and freezed frame data.

NOTICE: For OBDII scan tool or TOYOTA hand-held tester operating instructions, see the instruction booklet accompanying the scan tool.

(5) VISUAL INSPECTION

(6) SETTING CHECK MODE DIAGNOSIS**(7) PROBLEM SYMPTOM CONFIRMATION**

If the engine does not start, first carry out steps (10) and (12) while referring to the diagnostic trouble codes confirmed in step (4) .

(8) SYMPTOM SIMULATION

To find the trouble more quickly, set the diagnosis check to check mode and confirm the problem symptoms with the higher sensing ability of the ECM. If the trouble does not reappear, use the symptom simulation method to make sure the trouble can be reproduced.

(9) DIAGNOSTIC TROUBLE CODE CHECK IN CHECK MODE

Check the diagnostic trouble code in check mode. If a malfunction code is output, proceed to step (11) of the Diagnostic Trouble Code Chart. If a malfunction code is not output, proceed to step (10) Basic Inspection.

(10) BASIC INSPECTION

Carry out basic inspection such as the spark check and fuel pressure check, etc.

(11) DIAGNOSTIC TROUBLE CODE CHART

If a malfunction code is displayed, inspect the circuit indicated by the chart for each code.

(12) MATRIX CHART OF PROBLEM SYMPTOMS

If a diagnostic trouble code is not displayed in the diagnosis in check mode, troubleshoot according to the inspection order in the Matrix Chart of Problem Symptoms.

(13) CIRCUIT INSPECTION

Determine if the malfunction is in the sensor, actuator, wire harness, connector or the ECM.

(14) PARTS INSPECTION

When the Matrix Chart of Problem Symptoms instructs you to check the parts, refer to the parts inspection section in this manual.

(15) CHECK FOR INTERMITTENT PROBLEMS

By checking for intermittent problems, you can isolate the place where momentary interruptions or momentary shorts are occurring due to poor contacts.

(16) ADJUSTMENT, REPAIR

After you locate the cause of the problem, follow the inspection and replacement procedures in this manual and adjust or repair as necessary.

(17) CONFIRMATION TEST

After completing adjustment or repairs, confirm not only that the malfunction is eliminated, but also test drive the vehicle, to make sure the entire Engine Control System is operating normally.

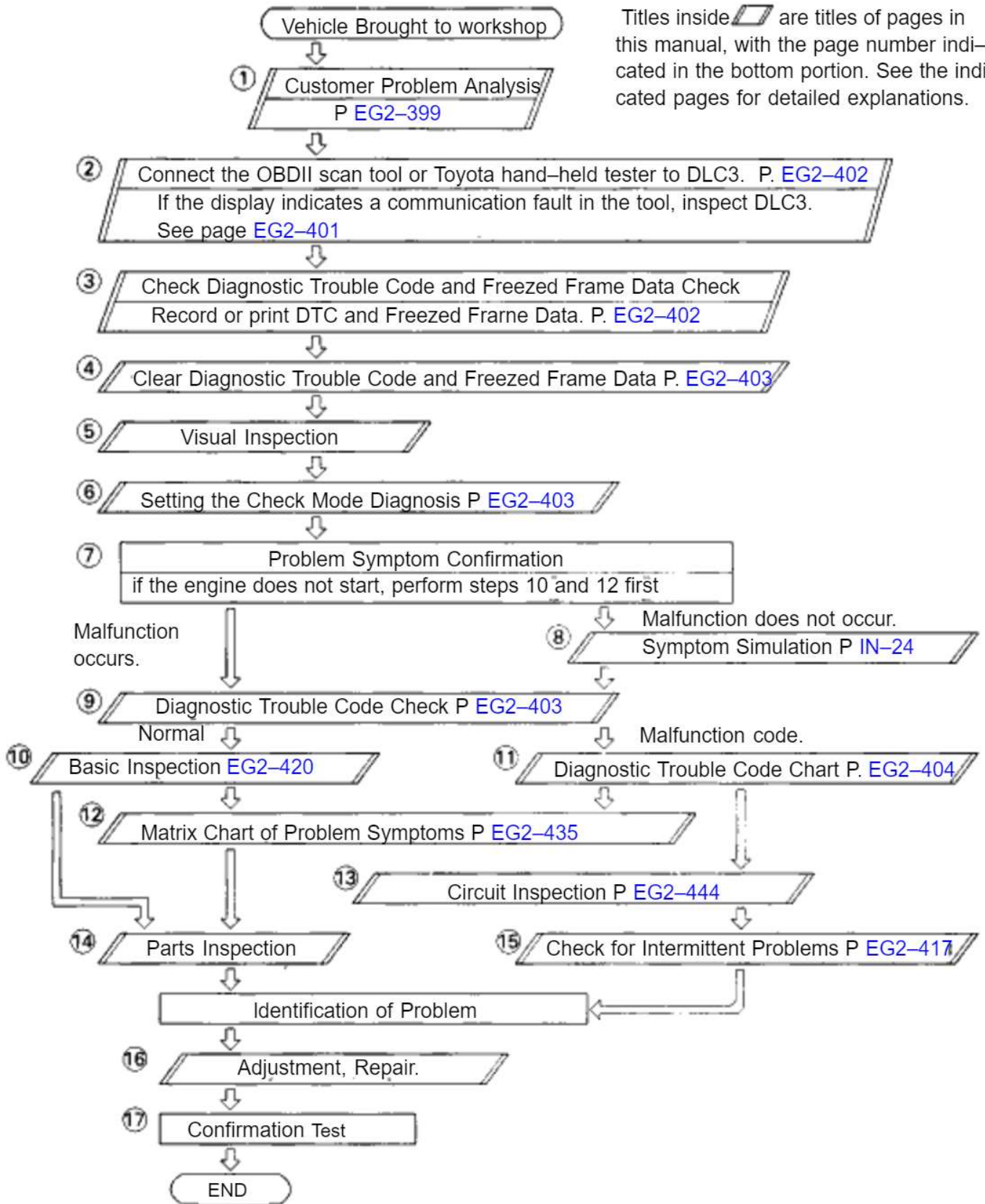

CUSTOMER PROBLEM ANALYSIS CHECK SHEET

ENGINE CONTROL System Check Sheet	Inspector's Name _____
--	------------------------

Customer's name		Model and model year	
Driver's name		Frame no.	
Date vehicle brought in		Engine model	
License no.		Odometer reading	km miles

Problem Symptoms	<input type="checkbox"/> Engine does not Start	<input type="checkbox"/> Engine does not crank <input type="checkbox"/> No initial combustion <input type="checkbox"/> No complete combustion
	<input type="checkbox"/> Difficult to Start	<input type="checkbox"/> Engine cranks slowly <input type="checkbox"/> Other _____
	<input type="checkbox"/> Poor Idling	<input type="checkbox"/> Incorrect first idle <input type="checkbox"/> Idling rpm is abnormal [<input type="checkbox"/> High <input type="checkbox"/> Low (rpm)] <input type="checkbox"/> Rough idling <input type="checkbox"/> Other _____
	<input type="checkbox"/> Poor Driveability	<input type="checkbox"/> Hesitation <input type="checkbox"/> Back fire <input type="checkbox"/> Muffler explosion (after-fire) <input type="checkbox"/> Surging <input type="checkbox"/> Knocking <input type="checkbox"/> Other _____
	<input type="checkbox"/> Engine Stall	<input type="checkbox"/> Soon after starting <input type="checkbox"/> After accelerator pedal depressed <input type="checkbox"/> After accelerator pedal released <input type="checkbox"/> During A/C operation <input type="checkbox"/> Shifting from N to D <input type="checkbox"/> Other _____
	<input type="checkbox"/> Others	

Dates Problem Occurred		
Problem Frequency	<input type="checkbox"/> Constant <input type="checkbox"/> Sometimes (times per day/month) <input type="checkbox"/> Once only <input type="checkbox"/> Other _____	
Conditions When Problem Occurs	Weather	<input type="checkbox"/> Fine <input type="checkbox"/> Cloudy <input type="checkbox"/> Rainy <input type="checkbox"/> Snowy <input type="checkbox"/> Various/Other _____
	Outdoor Temperature	<input type="checkbox"/> Hot <input type="checkbox"/> Warm <input type="checkbox"/> Cool <input type="checkbox"/> Cold (approx. ____ °F/ ____ °C)
	Place	<input type="checkbox"/> Highway <input type="checkbox"/> Suburbs <input type="checkbox"/> Inner City <input type="checkbox"/> Uphill <input type="checkbox"/> Downhill <input type="checkbox"/> Rough road <input type="checkbox"/> Other _____
	Engine Temp.	<input type="checkbox"/> Cold <input type="checkbox"/> Warming up <input type="checkbox"/> After warming up <input type="checkbox"/> Any temp. <input type="checkbox"/> Other _____
	Engine Operation	<input type="checkbox"/> Starting <input type="checkbox"/> Just after starting [min.] <input type="checkbox"/> Idling <input type="checkbox"/> Racing <input type="checkbox"/> Driving <input type="checkbox"/> Constant speed <input type="checkbox"/> Acceleration <input type="checkbox"/> Deceleration <input type="checkbox"/> A/C switch ON/OFF <input type="checkbox"/> Other _____

Condition of Malfunction Indicator Lamp	<input type="checkbox"/> Remains on <input type="checkbox"/> Sometimes lights up <input type="checkbox"/> Does not light up	
Diagnostic Trouble Code Inspection	Normal Mode (Precheck)	<input type="checkbox"/> Normal <input type="checkbox"/> Malfunction code(s) [code] <input type="checkbox"/> Freezed frame data []
	Check Mode	<input type="checkbox"/> Normal <input type="checkbox"/> Malfunction code(s) [code] <input type="checkbox"/> Freezed frame data []

EG2-400

1MZ-FE ENGINE – DIAGNOSIS SYSTEM



DIAGNOSIS SYSTEM

DESCRIPTION

When troubleshooting OBDII vehicles, the only difference from the usual troubleshooting procedure is that you connect to the vehicle the OBDII scan tool complying with SAE J1978 or TOYOTA hand-held tester, and read off various data output from the vehicle's ECM.

OBDII regulations require that the vehicle's on-board computer lights up the Malfunction Indicator Lamp (MIL) on the instrument panel when the computer detects a malfunction in the computer itself or in drive system components which affect vehicle emissions. In addition to the MIL lighting up when a malfunction is detected, the applicable diagnostic trouble codes prescribed by SAE J2012 are recorded in the ECM memory. (See page [EG2-404](#))

If the malfunction does not reoccur in 3 trips, the MIL goes off but the diagnostic trouble codes remain recorded in the ECM memory.

To check the diagnostic trouble codes, connect the OBDII scan tool or TOYOTA hand-held tester to Data Link Connector 3 on the vehicle. The OBDII scan tool or TOYOTA hand-held tester also enables you to erase the diagnostic trouble codes and check frozen frame data and various forms of engine data. (For operating instructions, see the OBDII scan tool's instruction book.)

Diagnostic trouble codes include SAE controlled codes and Manufacturer controlled codes.

SAE controlled codes must be set as prescribed by the SAE, while Manufacturer controlled codes can be set freely by the manufacturer within the prescribed limits.

(See diagnostic trouble code chart on page [EG2-404](#))

The diagnosis system operates in normal mode during normal vehicle use. It also has a check mode for technicians to simulate malfunction symptoms and troubleshoot. Most diagnostic trouble codes use 2 trip detection logic*to prevent erroneous detection and ensure thorough malfunction detection. By switching the ECM to check mode when troubleshooting, the technician can cause the MIL to light up for a malfunction that is only detected once or momentarily. (TOYOTA hand-held tester only)

(See page [EG2-403](#))

*2 trip detection logic

When a logic malfunction is first detected, the malfunction is temporarily stored in the ECM memory. If the same malfunction is detected again during the second drive test, this second detection causes the MIL to light up.

The 2 trip repeats the same mode a 2nd time. (However, the IG switch must be turned OFF between the 1 st trip and 2nd trip).

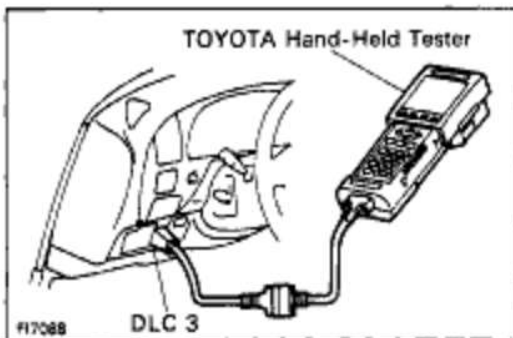

Freeze frame data:

Freeze frame data records the engine condition when a misfire (DTC P0300 – P0306) or fuel trim malfunction (DTC P0171, P0172), or other malfunction (first malfunction only), is detected.

Because freeze frame data records the engine conditions (fuel system, calculator load, engine coolant temperature, fuel trim, engine speed, vehicle speed, etc.) when the malfunction is detected, when troubleshooting it is useful for determining whether the vehicle was running or stopped, the engine warmed up or not, the air–fuel ratio lean or rich, etc. at the time of the malfunction.

Priorities for Troubleshooting:

If troubleshooting priorities for multiple diagnostic codes are given in the applicable diagnostic chart, these should be followed.

If no instructions are given, troubleshoot diagnostic trouble codes according to the following priorities.

(1) Diagnostic trouble codes other than fuel trim malfunction (DTC P0171, P0172) and EGR (DTC P0401, P0402) and misfire (DTC P0300 – P0306).

(2) Fuel trim malfunction (DTC P0171, P0172) and EGR (DTC P0401, P0402)

(3) Misfire (DTC P0300 – P0306).

DATA LINK CONNECTOR 3 INSPECTION

The vehicle's ECM uses V.P.W. (Variable Pulse Width) for communication to comply with SAE J1850. The terminal arrangement of DLC 3 complies with SAE J1962 and matches the V. P.W. format.

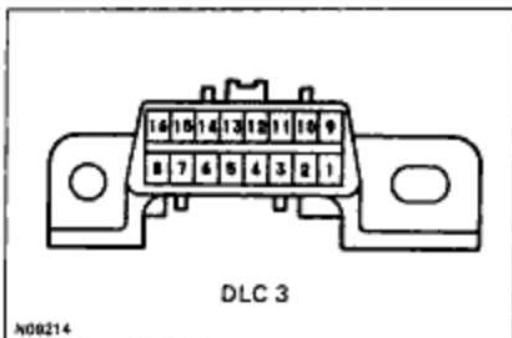

Terminal No.	Connection	Voltage or Resistance	Condition
2	Bus (+) Line	Pulse generation	During transmission
4	Chassis Ground	↔ Body Ground 1 0 or less	Always
5	Signal Ground	↔ Body Ground 1 0 or less	Always
16	Battery Positive	↔ Body Ground 9 – 14 V	Always

HINT: If your display shows "UNABLE TO CONNECT TO VEHICLE" when you have connected the cable of the OBDII scan tool or TOYOTA hand–held tester to DLC 3, turned the ignition switch ON and operated the scan tool, there is a problem on the vehicle side or tool side.

1) If communication is normal when the tool is connected to another vehicle, inspect DLC 3 on the original vehicle.

2) If communication is still not possible when the tool is connected to another vehicle, the problem is probably in the tool itself, so consult the Service Department listed in the tool's instruction manual.

EG2-402

1MZ-FE ENGINE – DIAGNOSIS SYSTEM

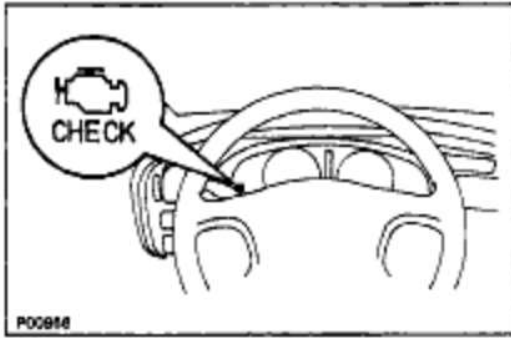

Diagnosis Inspection (Normal Mode) MALFUNCTION INDICATOR LAMP CHECK

1. The malfunction indicator lamp comes on when the ignition switch is turned ON and the engine is not running.

HINT: If the malfunction indicator lamp does not light up, troubleshoot the combination meter.

(See page [BE-64](#)).

2. When the engine is started, the malfunction indicator lamp should go off. If the lamp remains on, the diagnosis system has detected a malfunction or abnormality in the system.

DIAGNOSTIC TROUBLE CODE CHECK

NOTICE (TOYOTA hand-held tester only): When the diagnosis system is switched from normal mode to check mode, it erases all diagnostic trouble codes and frozen frame data recorded in normal mode. So before switching modes, always check the diagnostic trouble codes and frozen frame data, and note them down.

1. Prepare the OBDII scan tool (complying with SAE J1978) or TOYOTA hand-held tester.

2. Connect the OBDII scan tool or TOYOTA hand-held tester to data link connector 3 in the fuse box at the lower left of the instrument panel.

3. Turn the ignition switch ON and turn the OBDII scan tool or TOYOTA hand-held tester switch ON.

4. Use the OBDII scan tool or TOYOTA hand-held tester to check the diagnostic trouble codes and frozen frame data, note them down. (For operating instructions, see the OBDII scan tool's instruction book.)

5. See page [EG2-404](#) to confirm the details of the diagnostic trouble codes.

NOTICE: When simulating symptoms with an OBDII scan tool (excluding TOYOTA hand-held tester) to check the diagnostic trouble codes, use normal mode. For codes on the diagnostic trouble code chart subject to "2 trip detection logic", turn the ignition switch OFF after the symptom is simulated the first time. Then repeat the simulation process again. When the problem has been simulated twice, the MIL lights up and the diagnostic trouble codes are recorded in the ECM.

Diagnosis Inspection (Check Mode)

TOYOTA HAND-HELD TESTER only

Compared to the normal mode, the check mode has an increased sensitivity to detect malfunctions.

Furthermore, the same diagnostic items which are detected in the normal mode can also be detected in the check mode.

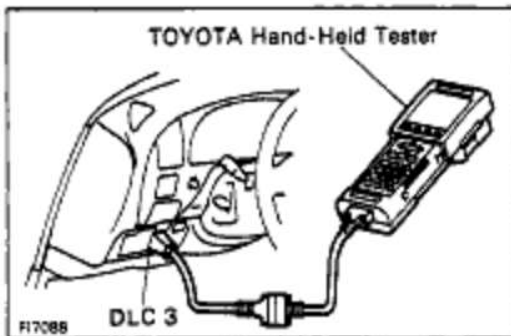

DIAGNOSTIC TROUBLE CODE CHECK

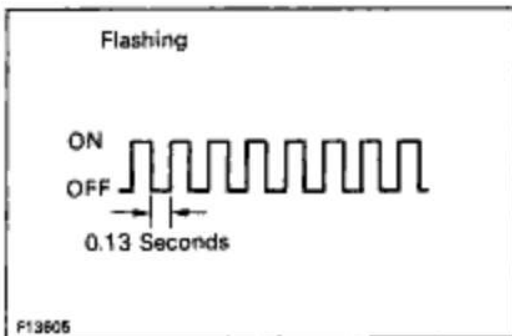
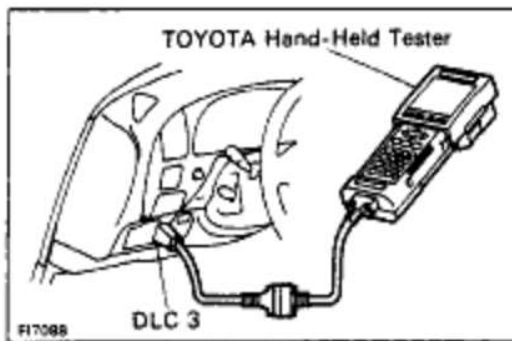

1. Initial conditions.
 - (a) Battery positive voltage 11 V or more.
 - (b) Throttle valve fully closed.
 - (c) Transmission in park or neutral position.
 - (d) Air conditioning switched OFF.
2. Turn ignition switch OFF.
3. Prepare the TOYOTA hand-held tester.
4. Connect the TOYOTA hand-held tester to data link connector 3 in the fuse box at the lower left of the instrument panel.
5. Turn the ignition switch ON and switch the TOYOTA hand-held tester ON.
6. Switch the TOYOTA hand-held tester normal mode to check mode. (Check that the MIL flashes.)
7. Start the engine. (The MIL goes out after the engine start.)
8. Simulate the conditions of the malfunction described by the customer.

NOTICE: Leave the ignition switch ON until you have checked the diagnostic trouble codes, etc.

9. After simulating the malfunction conditions, use the TOYOTA hand-held tester diagnosis selector to check the diagnostic trouble codes and frozen frame data, etc. HINT: Take care not to turn the ignition switch OFF. Turning the ignition switch OFF switches the diagnosis system from check mode to normal mode, so all diagnostic codes, etc. are erased.
10. After checking the diagnostic trouble code, inspect the applicable circuit.

DIAGNOSTIC TROUBLE CODE CLEARANCE

The following actions will erase the diagnostic trouble codes and frozen frame data.

1. Operating the OBDII scan tool (complying with SAE J1978) or TOYOTA hand-held tester to erase the codes. (See the OBDII scan tool's instruction book for operating instructions.)
2. Disconnecting the battery terminals or EFI fuse.

NOTICE: If the TOYOTA hand-held tester switches the ECM from normal mode to check mode or vice-versa, or if the ignition switch is turned from ON to ACC or OFF during check mode, the diagnostic trouble codes and frozen frame data will be erased.

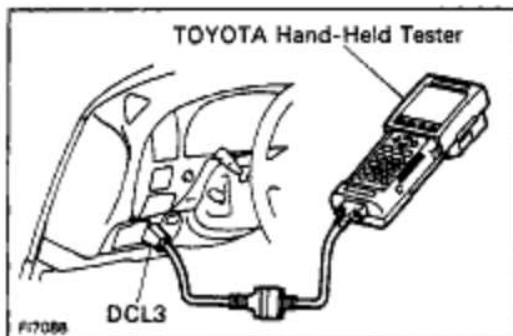

DIAGNOSTIC TROUBLE CODE CHART (SAE Controlled)

HINT: Parameters listed in the chart may not be exactly the same as your reading due to the type of instrument or other factors.

DTC No.	Detection Item	Diagnostic Trouble Code Detecting Condition
P0100	Mass Air Flow Circuit Malfunction	Open or short in mass air flow meter circuit with engine speed 4,000 rpm or less.
P0101	Mass Air Flow Circuit Range/ Performance Problem	Conditions a) and b) continue with engine speed 900 rpm or less. (2 trip detection logic) a) Closed throttle position switch: ON b) Mass air flow meter output) ≥ 2.2 V
P0110	Intake Air Temp. Circuit Malfunction	Open or short in intake air temp. sensor circuit.
P0115	Engine Coolant Temp. Circuit Malfunction	Open or short in engine coolant temp. sensor circuit.
P0116	Engine Coolant Temp. Circuit Range/ Performance Problem	20 min. or more after starting engine, engine coolant temp. sensor value is 30°C (86°F) or less. (2 trip detection logic)
P0120	Throttle Position Circuit Malfunction	Condition a) or b) continues. a) VTA \leq (0.1 V, and closed throttle position switch is OFF. b) VTA) ≥ 4.9 V
P0121	Throttle Position Circuit Range/ Performance Problem	When closed throttle position switch is ON, condition a) continues. (2 trip detection logic) a) VTA) ≥ 2.0 V
P0125	Insufficient Coolant Temp. for Closed Loop Fuel Control	After the engine is warmed up, heated oxygen sensor output does not indicate RICH even once when conditions a) and b) continue for at least 2 minutes. a) Engine speed: 1,500 rpm or more b) Vehicle speed: 40 km/h (25 mph) or more
P0130	Heated Oxygen Sensor Circuit Malfunction (Bank 1 Sensor 1)	Voltage output of heated oxygen sensor remains at 0.4 V or more, or 0.55 V or less, during idling after the engine is warmed up. (2 trip detection logic)
P0133	Heated Oxygen Sensor Circuit Slow Response (Bank 1 Sensor 1)	Response time for the heated oxygen sensor's voltage output to change from rich to lean, or from lean to rich, is 1 sec. or more during idling after the engine is warmed up. (2 trip detection logic)

1MZ-FE ENGINE – DIAGNOSTIC TROUBLE CODE CHART

If a malfunction code is displayed during the diagnostic trouble code check in check mode, check the circuit for that code listed in the table below (Proceed to the page given for that circuit).

Trouble Area	MIL	Memory	See Page
<ul style="list-style-type: none"> Open or short in mass air flow meter circuit. Mass air flow meter ECM 	○	○	EG2-444
<ul style="list-style-type: none"> Mass air flow meter 	○	○	EG2-450
<ul style="list-style-type: none"> Open or short in intake air temp. sensor circuit. Intake air temp. sensor ECM 	○	○	EG2-451
<ul style="list-style-type: none"> Open or short in engine coolant temp. sensor circuit. Engine coolant temp. sensor ECM 	○	○	EG2-457
<ul style="list-style-type: none"> Engine coolant temp. sensor Coolant system 	○	○	EG2-462
<ul style="list-style-type: none"> Open or short in throttle position sensor circuit. Throttle position sensor. ECM 	○	○	EG2-463
<ul style="list-style-type: none"> Throttle position sensor 	○	○	EG2-472
<ul style="list-style-type: none"> Open or short in heated oxygen sensor circuit. Heated oxygen sensor. 	○	○	EG2-473
<ul style="list-style-type: none"> Heated oxygen sensor Fuel trim malfunction 	○	○	EG2-476
<ul style="list-style-type: none"> Heated oxygen sensor 	○	○	EG2-480

EG2-406

1MZ-FE ENGINE – DIAGNOSTIC TROUBLE CODE CHART

DIAGNOSTIC TROUBLE CODE CHART (Cont'd)

DTC No.	Detection Item	Diagnostic Trouble Code Detecting Condition
P0135	Heated Oxygen Sensor Heater Circuit Malfunction (Bank 1 Sensor 1)	When the heater operates, heater current exceeds 2 A or voltage drop for the heater circuit exceeds 5 V. (2 trip detection logic)
		Heater current of 0.25 A or less when the heater operates. (2 trip detection logic)
P0136	Heated Oxygen Sensor Circuit Malfunction (Bank 1 Sensor 2)	Voltage output of the heated oxygen sensor (bank1 sensor 2) remains at 0.4 V or more or 0.5 V or less when the vehicle is driven at 50 km/h (31 mph) or more after the engine is warmed up. (2 trip detection logic)
P0141	Heated Oxygen Sensor Heater Circuit Malfunction (Bank 1 Sensor 2)	Same as DTC No. P01 35.
P0150	Heated Oxygen Sensor Circuit Malfunction (Bank 2 Sensor 1)	Same as DTC No. P01 30.
P0153	Heated Oxygen Sensor Circuit Slow Response (Bank 2 Sensor 1)	Same as DTC No. P01 33.
P0155	Heated Oxygen Sensor Heater Circuit Malfunction (Bank 2 Sensor 1)	Same as DTC No. P01 35.
P0171	System too Lean (Fuel Trim)	When the air fuel ratio feedback is stable after engine warming up, the fuel trim is considerably in error on the RICH side. (2 trip detection logic)
P0172	System too Rich (Fuel Trim)	When the air fuel ratio feedback is stable after engine warming up, the fuel trim is considerably in error on the LEAN side. (2 trip detection logic)
P0201 P0202 P0203 P0204 P0205 P0206	Injector Circuit Malfunction – Cylinder 1 – Cylinder 2 – Cylinder 3 – Cylinder 4 – Cylinder 5 – Cylinder 6	A specified cylinder misfire continuously. (2 trip detection logic)

1MZ-FE ENGINE – DIAGNOSTIC TROUBLE CODE CHART

Trouble Area	MIL	Memory	See Page
<ul style="list-style-type: none"> • Open or short in heater circuit of heated oxygen sensor. • Heated oxygen sensor heater • ECM 	○	○	EG2-481
<ul style="list-style-type: none"> • Heated oxygen sensor 	○	○	EG2-484
<ul style="list-style-type: none"> • Same as DTC No. P01 35. 	○	○	EG2-481
<ul style="list-style-type: none"> • Same as DTC No. P01 30. 	○	○	EG2-476
<ul style="list-style-type: none"> • Same as DTC No. P01 33. 	○	○	EG2-480
<ul style="list-style-type: none"> • Same as DTC No. P01 35. 	○	○	EG2-481
<ul style="list-style-type: none"> • Air intake (hose loose) • Fuel line pressure • Injector blockage • Heated oxygen sensor malfunction • Mass air flow meter • Engine coolant temp. sensor 	○	○	EG2-486
<ul style="list-style-type: none"> • Fuel line pressure • Injector leak, blockage • Heated oxygen sensor malfunction • Mass air flow meter • Engine coolant temp. sensor 	○	○	EG2-486
<ul style="list-style-type: none"> • Open or short in injector circuit • Injector blockage, seized • Ignition system • Valve clearance not to specification • Compression pressure 	○	○	EG2-491

EG2-408

1MZ-FE ENGINE – DIAGNOSTIC TROUBLE CODE CHART

DIAGNOSTIC TROUBLE CODE CHART (Cont'd)

DTC No.	Detection Item	Diagnostic Trouble Code Detecting Condition
P0300	Random Misfire Detected	Misfiring of multiple cylinders is detected during the same 200 or 1,000 revolutions.
P0301 P0302 P0303 P0304 P0305 P0306	Misfire Detected – Cylinder 1 – Cylinder 2 – Cylinder 3 – Cylinder 4 – Cylinder 5 – Cylinder 6	For each 200 revolutions of the engine, misfiring is detected which can cause catalyst overheating. (This causes MIL to blink.) For each 1,000 revolutions of the engine, misfiring is detected which causes emissions deterioration. (2 trip detection logic)
P0325	Knock Sensor 1 Circuit Malfunction	No knock sensor 1 signal to ECM with engine speed 2,000 rpm or more.
P0330	Knock Sensor 2 Circuit Malfunction	No knock sensor 2 signal to ECM with engine speed 2,000 rpm or more.
P0335	Crankshaft Position Sensor Circuit Malfunction	No crankshaft position sensor signal to ECM during cranking. (2 trip detection logic)
		No crankshaft position sensor signal to ECM during engine running.
P0336	Crankshaft Position Sensor Circuit Range/ Performance	Deviation in crankshaft position sensor signal and camshaft position sensor signal. (2 trip detection logic)
P0340	Camshaft Position Sensor Circuit Malfunction	No camshaft position sensor signal to ECM during cranking. (2 trip detection logic)
		No camshaft position sensor signal to ECM during engine running.
P0401	Exhaust Gas Recirculation Flow Insufficient Detected	After the engine is warmed up and run at 80 km/h (50 mph) for 3 to 5 minutes, the EGR gas temperature sensor value does not exceed 40°C (104°F) above the ambient air temperature, (2 trip detection logic)

1MZ-FE ENGINE – DIAGNOSTIC TROUBLE CODE CHART

Trouble Area	MIL	Memory	See Page
<ul style="list-style-type: none"> • Ignition system • Injector • Fuel line pressure • EG R • Compression pressure • Valve clearance not to specification • Valve timing • Mass air flow meter • Engine coolant temp. sensor 	○	○	EG2-493
<ul style="list-style-type: none"> • Open or short in knock sensor 1 circuit. • Knock sensor 1 (looseness) • ECM 	○	○	EG2-499
<ul style="list-style-type: none"> • Open or short in knock sensor 2 circuit. • Knock sensor 2 (looseness) • ECM 	○	○	EG2-499
<ul style="list-style-type: none"> • Open or short in crankshaft position sensor circuit. • Crankshaft position sensor • Starter • ECM 	○	○	EG2-503
<ul style="list-style-type: none"> • Mechanical system malfunction (skipping teeth of timing belt, belt stretched) • ECM 	○	○	EG2-507
<ul style="list-style-type: none"> • Open or short in camshaft position sensor circuit. • Camshaft position sensor • Starter • ECM 	○	○	EG2-508
<ul style="list-style-type: none"> • EGR valve stuck closed • Short in EGR VSV circuit • Open in EGR gas temp. sensor circuit • EGR hose disconnected • ECM 	○	○	EG2-512

EG2-410

1MZ-FE ENGINE – DIAGNOSTIC TROUBLE CODE CHART

DIAGNOSTIC TROUBLE CODE CHART (Cont'd)

DTC No.	Detection Item	Diagnostic Trouble Code Detecting Condition
P0402	Exhaust Gas Recirculation Flow Excessive Detected	EG R gas temp. sensor value is high during EGR cut-off when engine is cold (Race engine at about 4,000 rpm without load so that vacuum is applied to port E). (2 trip detection logic)
		EG R valve is always open. (2 trip detection logic)
P0420	Catalyst System Efficiency Below Threshold	After the engine is warmed up and the vehicle driven for 5 min. at 32 – 80 km/h (20 – 50 mph), the waveforms of the heated oxygen sensors, bank 1, 2 sensor 1 and bank 1 sensor 2 have the same amplitude.
P0500	Vehicle Speed Sensor Malfunction	No vehicle speed sensor signal to ECM under conditions a) and b). a) Park/neutral position switch is OFF. b) Vehicle is being driven.
P0505	Idle Control System Malfunction	Idle speed continues to vary greatly from the target speed. (2 trip detection logic)
P0510	Closed Throttle Position Switch Malfunction	The closed throttle position switch does not turn ON even once when the vehicle is driven. (2 trip detection logic)

1MZ-FE ENGINE – DIAGNOSTIC TROUBLE CODE CHART

Trouble Area	MIL*1	Memory	See Page
<ul style="list-style-type: none"> EGR valve stuck open EGR VSV open malfunction Open in EGR VSV circuit Short in EGR gas temp. sensor circuit ECM 	○	○	EG2-527
<ul style="list-style-type: none"> Three-way catalytic converter Open or short in heated oxygen sensor circuit Heated oxygen sensor 	○*2	○	EG2-534
<ul style="list-style-type: none"> Open or short in vehicle speed sensor circuit. Vehicle speed sensor Combination meter ECM 	○	○	EG2-537
<ul style="list-style-type: none"> IAC valve is stuck or closed Open or short in IAC valve circuit Air conditioner idle up VSV Air intake (hose loose) 	○	○	EG2-541
<ul style="list-style-type: none"> Open in closed throttle position switch circuit. Closed throttle position switch ECM 	○	○	EG2-546

*1.... MIL does not light up

○ MIL lights up

◎ MIL lights up, O/D OFF indicator light blinks

*2.... MIL lights up only on USA specification vehicles.

DIAGNOSTIC TROUBLE CODE CHART (Cont'd)

DTC No.	Detection Item	Diagnostic Trouble Code Detecting Condition
P0720	Output Speed Sensor Circuit Malfunction (for Electronically Controlled Transaxle)	DTC No. P0500 is detected.
P0750	Shift Solenoid A Malfunction (Shift Solenoid Valve No.1)	During normal driving the gear required by the ECM does not match the actual gear, (2 trip detection logic)
P0753	Shift Solenoid A Electrical (Shift Solenoid Valve No.1)	Open or short in shift solenoid valve No.1 circuit.
P0755	Shift Solenoid6 Malfunction (Shift Solenoid Valve No.2)	Same as for DTC No. P0750.
P0758	Shift Solenoid B Electrical (Shift Solenoid Valve No.2)	Open or short in shift solenoid valve No.2 circuit.
P0770	Shift Solenoid E Malfunction (Shift Solenoid Valve SL)	Lock-up does not occur when driving in the lock-up range (normal driving at 80 km/h [50 mph]), or lock-up remains ON in the lock-up OFF range. (2 trip detection logic)
P0773	Shift Solenoid E Electrical (Shift Solenoid Valve SL)	Open or short in shift solenoid valve SL circuit. (2 trip detection logic)

1MZ-FE ENGINE – DIAGNOSTIC TROUBLE CODE CHART

Trouble Area	MIL*	Memory	See Page
<ul style="list-style-type: none"> Same as for DTC No. P0500. 	⊙	○	AX2-92
<ul style="list-style-type: none"> Shift solenoid valve No.1 is stuck open or closed. Valve body is blocked up or stuck. 	⊙	○	AX2-96
<ul style="list-style-type: none"> Open or short in shift solenoid valve No.1 circuit. Shift solenoid valve No.1 ECM 	⊙	○	AX2-98
<ul style="list-style-type: none"> Shift solenoid valve No.2 is stuck open or closed. 	⊙	○	AX2-96
<ul style="list-style-type: none"> Open or short in shift solenoid valve No.2 circuit. Shift solenoid valve No.2 ECM 	⊙	○	AX2-98
<ul style="list-style-type: none"> Shift solenoid valve SL is stuck open or closed. Lock-up clutch 9 Valve body is blocked up or stuck. 	⊙	○	AX2-102
<ul style="list-style-type: none"> Open or short in shift solenoid valve SL circuit. Shift solenoid valve SL ECM 	⊙	○	AX2-104

* – MIL does not light up

○ MIL lights up

⊙ MIL lights up, O/D OFF indicator light blinks

DIAGNOSTIC TROUBLE CODE CHART (Manufacturer Controlled)

DTC No.	Detection Item	Diagnostic Trouble Code Detecting Condition
P1300	Igniter Circuit Malfunction	No IGF signal to ECM for 6 consecutive IGT signals during engine running.
P1500	Starter Signal Circuit Malfunction	No starter signal to ECM.
P1600	ECM BATT Malfunction	Open in back up power source circuit.
P1605	Knock Control CPU Malfunction	Engine control computer malfunction (for knock control).
P1705	"NC2" Revolution Sensor Circuit Malfunction (Direct Clutch Speed Sensor)	Output of direct clutch speed sensor (NC2) is 300 rpm or less under conditions a) and b). (2 trip detection logic) a) Vehicle speed: 32 km/h (20 mph) or more b) Park/neutral position switch: OFF
P1765	Linear Solenoid for Accumulator Pressure Control Circuit Malfunction (Shift Solenoid Valve SLN)	After the engine is warmed up, the current flow to the shift solenoid valve SLN is 0.2 A or less for at least 1 sec. under condition a) or b). (2 trip detection logic) a) Engine speed: 500 rpm or more b) Park/neutral position switch: ON (P or N position)
P1780	Park/Neutral Position Switch Malfunction	Two or more switches are ON simultaneously for "N", "2" and "L" position. (2 trip detection logic)
		When driving under conditions a) and b) for 30 sec. or more, the park/neutral position switch is ON (N position). (2 trip detection logic) a) Vehicle speed: 70 km/h (44 mph) or more b) Engine speed: 1,500 – 2,500 rpm

1MZ-FE ENGINE – DIAGNOSTIC TROUBLE CODE CHART

Trouble Area	MIL*	Memory	See Page
<ul style="list-style-type: none"> Open or short in IGF or IGT circuit from igniter to ECM. Igniter ECM 	○	○	EG2-550
<ul style="list-style-type: none"> Open or short in starter signal circuit. Open or short in ignition switch or starter relay circuit, ECM 	-	○	EG2-557
<ul style="list-style-type: none"> Open in back up power source circuit. ECM 	○	○	EG2-559
<ul style="list-style-type: none"> ECM 	○	○	EG2-561
<ul style="list-style-type: none"> Open or short in direct clutch speed sensor circuit. Direct clutch speed sensor ECM 	⊙	○	AX2-108
<ul style="list-style-type: none"> Open or short in shift solenoid valve SLN circuit. Shift solenoid valve SLN ECM 	-	○	AX2-112
<ul style="list-style-type: none"> Short in park/neutral position switch circuit. Park/neutral position switch ECM 	○	○	EG2-562

*: – MIL does not light up

○ MIL lights up

⊙ MIL lights up, O/D OFF indicator light blinks

EG2-416

1MZ-FE ENGINE – SAFE CHART

FAIL-SAFE CHART

If any of the following codes is recorded, the ECM enters fail-safe mode.

DTC No.	Fail-Safe Operation	Fail-safe Deactivation Conditions
P0100	<ul style="list-style-type: none"> • Ignition timing fixed at 5₂ BTDC. • Injection time fixed Starting 11.0 m sec. CTP Switch ON 3.5 m sec. CTP Switch OFF 6.3 m sec. 	Returned to normal condition
P0110	Intake air temp. is fixed at 68 ₂ F (20 ₂ C).	Returned to normal condition
P0115	Engine coolant temp. is fixed at 176 ₂ F (80 ₂ C).	Returned to normal condition
P0120	VTA is fixed at 0 ₂ .	The following condition must be repeated at least 2 times consecutively. When closed throttle position switch is ON: 0.1 V ≤ VTA ≤ 0.95 V
P0135 P0141 P0155	The heater circuit in which an abnormality is detected is turned off.	Ignition switch OFF
P0325 P0330	Max. timing retardation.	Ignition switch OFF
P0720	Gears are shifted according to the engine rpm and throttle angle.	Returned to normal condition
P0753	Power to the solenoid valve and lock-up solenoid valve is cut off.	Returned to normal condition
P0758	Power to the solenoid valve and lock-up solenoid valve is cut off.	Returned to normal condition
P0773	Power to the solenoid valve is cut off.	Returned to normal condition
P1300	Fuel cut	IGF signal is detected for 6 consecutive ignitions.
P1605	Max. timing retardation.	Returned to normal condition
P1766	Power to the solenoid valve is cut off.	Returned to normal condition

Back-up Function

If there is trouble with the program in the ECM and ignition signals (IGT) are not output from the microcomputer, the ECM controls fuel injection and ignition timing at predetermined levels as a back-up function to make it possible to continue to operate the vehicle.

Furthermore, the injection duration is calculated from the starting signal (STA) and the closed throttle position switch signal (IDL). Also, the ignition timing is fixed at 5₂ BTDC, without relation to the engine speed,

HINT: If the engine is controlled by the back-up function, the malfunction indicator lamp lights up to warn the driver of the malfunction but the diagnostic trouble code is not output.

CHECK FOR INTERMITTENT PROBLEMS

TOYOTA HAND-HELD TESTER only

By putting the vehicle's ECM in check mode, 1 trip detection logic is possible instead of 2 trip detection logic and sensitivity to detect open circuits is increased. This makes it easier to detect intermittent problems.

CLEAR DIAGNOSTIC TROUBLE CODES

See page [EG2-403](#)

SET CHECK MODE

See page [EG2-403](#)

PERFORM A SIMULATION TEST

Using the symptom simulation (see page [IN-24](#)), shake and pull lightly on the wire harness, connector or terminals in the circuit indicated by the malfunction code. In this test, if the malfunction indicator lamp lights up, it indicates that the place where the wire harness, connector or terminals being pulled or shake has faulty contact. Check that point for loose connections, dirt on the terminals, poor fit or other problems and repair as necessary.

HINT: After cancelling out the diagnostic trouble code in memory and setting the check mode, if the malfunction indicator lamp does not go off after the engine is started, check thoroughly for faulty contacts, etc., then try the check again. If the malfunction indicator lamp still does not go off, check and replace the ECM.

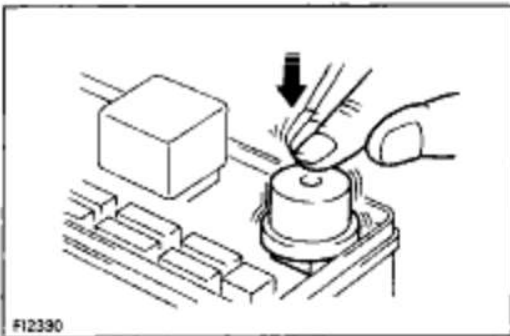
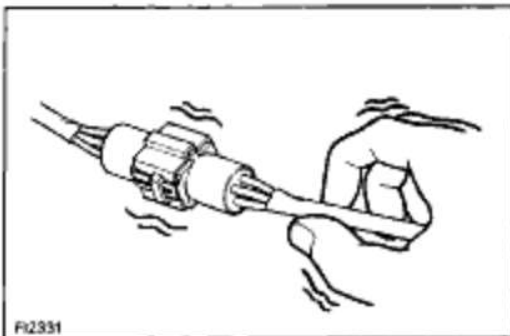

EG2-418

1MZ-FE ENGINE - CHECK FOR INTERMITTENT PROBLEMS

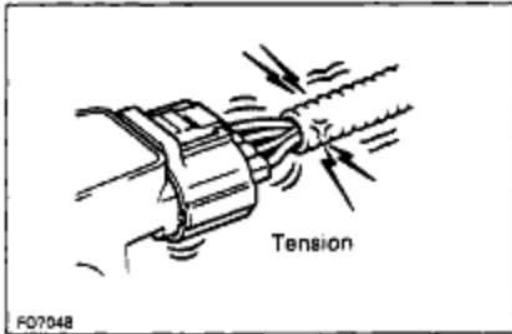
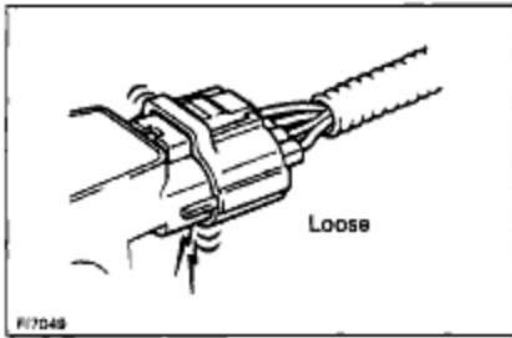

CONNECTOR CONNECTION AND TERMINAL INSPECTION

When checking for an open circuit or short circuit, it is important to check the connector connection and the condition of the terminals.

OPEN CIRCUIT:

This could be due to a disconnected wire harness, faulty contact in the connector, a connector terminal pulled out, etc.

HINT:

1. A wire rarely breaks in the middle of its length. Most cases occur at the connector. In particular, carefully check the connectors of sensors and actuators.
2. Faulty contact could be due to rusting of the connector terminals, to foreign materials entering the terminals or a drop in the contact pressure between the male and female terminals of the connector. Simply disconnecting and reconnecting the connectors once changes the condition of the connection and may result in a return to normal operation. Therefore, in troubleshooting, if no abnormality is found in the wire harness and connector check, but the problem disappears after the check, then the cause is considered to be in the wire harness or connectors.

SHORT CIRCUIT:

This could be due to a short circuit between the wire harness and the body ground or to a short inside the switch, etc.

HINT:

When there is a short between the wire harness and body ground, check thoroughly whether the wire harness is caught in the body or is clamped properly.

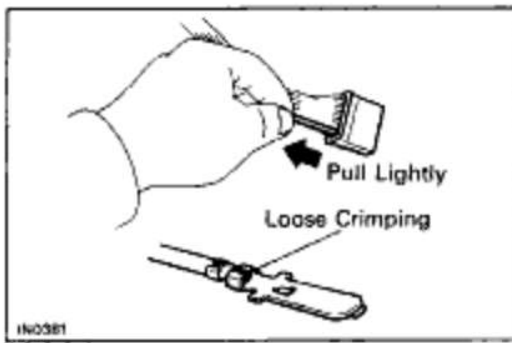

VISUAL CHECK AND CONTACT PRESSURE CHECK

- (a) Disconnect the connectors at both ends.
 (b) Check for rust or foreign material, etc. on the terminals of the connectors.
 (c) Check crimped portions for looseness or damage and check if the terminals are secured in the lock position.
 HINT: The terminals should not come out when pulled lightly.

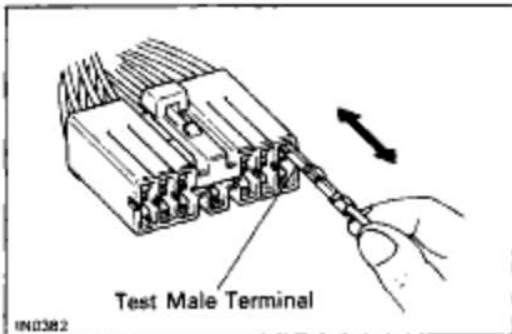

- (d) Prepare a test male terminal and insert it in the female terminal, then pull it out.

NOTICE: When testing a gold-plated female terminal, always use a gold-plated male terminal.

HINT: When the test terminal is pulled out more easily than others, there may be poor contact in that section.

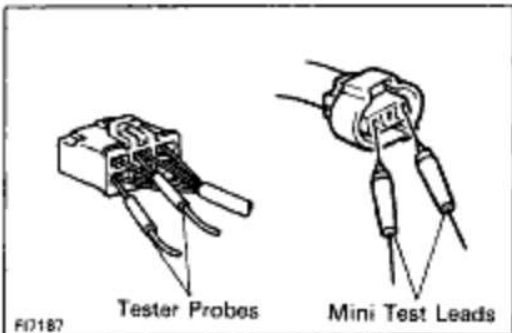

CONNECTOR HANDLING

When inserting tester probes into a connector, insert them from the rear of the connector. When necessary, use mini test leads. For water resistant connectors which cannot be accessed from behind, take good care not to deform the connector terminals.

EG2-420

1MZ-FE ENGINE - BASIC INSPECTION

BASIC INSPECTION

When the normal code is displayed in the diagnostic trouble code check, troubleshooting should be performed in the order for all possible circuits to be considered as the causes of the problems. In many cases, by carrying out the basic engine check shown in the following flow chart, the location causing the problem can be found quickly and efficiently. Therefore, use of this check is essential in engine troubleshooting.

1	Is battery positive voltage 11 V or more when engine is stopped?
YES	NO Charge or replace battery.
2	Is engine cranked?
YES	NO Proceed to page ST-47, 63 and continue to troubleshoot.
3	Does engine start?
YES	NO Go to step 7
4	Check air filter.

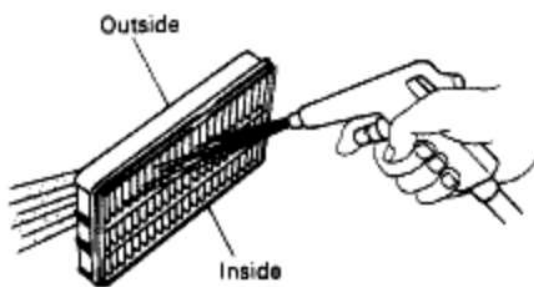

P00455

- P** Remove air filter.
- C** Visually check that the air cleaner element is not damaged or excessively oily.
- Flow** If necessary, clean element with compressed air. First blow from inside thoroughly, then blow from outside of element.

OK	NG Repair or replace.
Go to step 5	

5 Check idle speed.

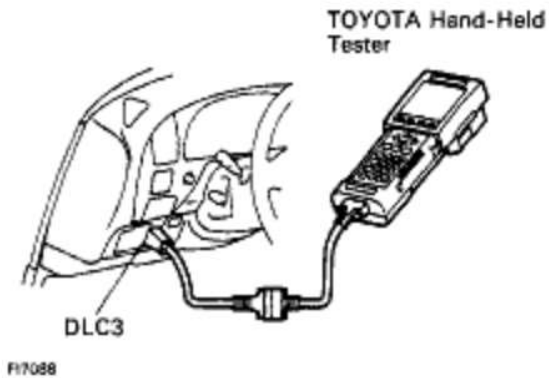

- P** (1) Warm up engine to normal operating temperature.
 (2) Switch off all accessories.
 (3) Switch off air conditioning.
 (4) Shift transmission into "N" position.
 (5) Connect the OBDII scan tool or TOYOTA hand-held tester to data link connector 3 on the vehicle.

C Use CURRENT DATA to check the engine idle speed.

OK Idle speed: 650 – 750 rpm

OK

NG

Proceed to matrix chart of problem symptoms on page [EG2-435](#).

6 Check ignition timing.

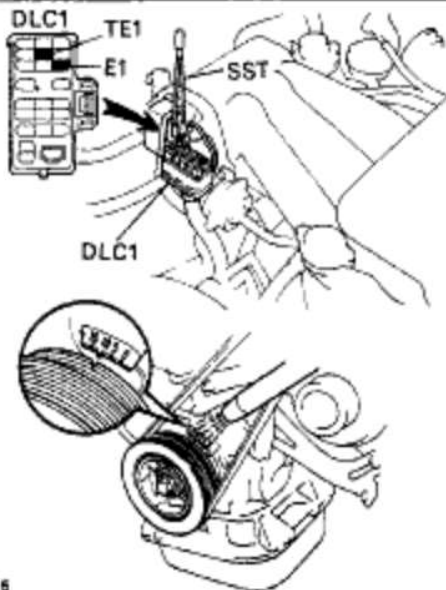

- P** (1) Warm up engine to normal operating temperature.
 (2) Shift transmission into "N" position.
 (3) Keep the engine speed at idle.
 (4) Using SST, connect terminals TE1 and E1 of data link connector 1.
 SST 09843-18020
 (5) Using a timing light, connect the tester to check wire. (See page IG-81)

C Check ignition timing.

OK Ignition timing: 10₂ BTDC at idle

OK

NG

Proceed to page IG-80 and continue to troubleshoot.

Proceed to matrix chart of problem symptoms on page [EG2-435](#).

EG2-422

1MZ-FE ENGINE – BASIC INSPECTION

7

Check fuel pressure.

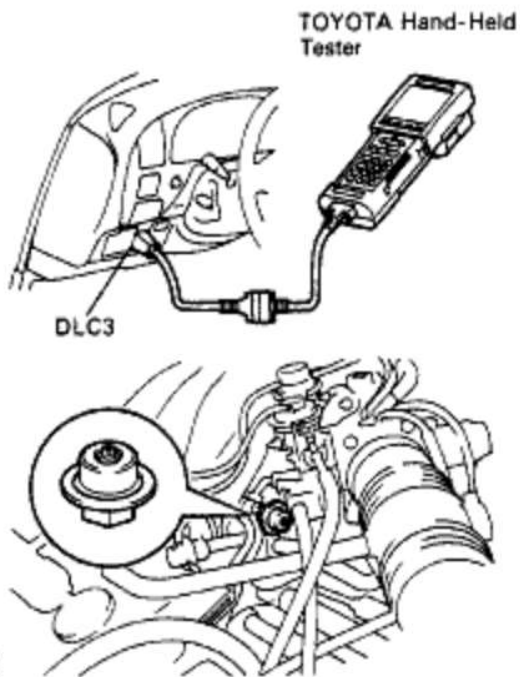

- P** (1) Be sure that enough fuel is in the tank.
 (2) Turn ignition switch ON.
 (3) Connect the TOYOTA hand-held tester to data link connector 3 on the vehicle.
 (4) Use ACTIVE TEST mode to operate the fuel pump.
- C** Check that the pulsation damper screw rises up when the fuel pump operates.

OK

NG

Proceed to page [EG2-230](#) and continue to troubleshoot.

8

Check for spark.

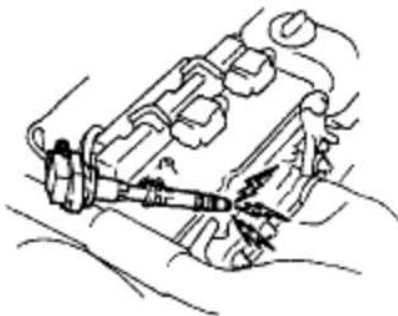

- P** (1) Remove ignition coil (See page IG-89).
 (2) Remove spark plug.
 (3) Install the spark plug to the ignition coil, and connect the ignition coil connector.
 (4) Ground the spark plug.
 (5) Disconnect injector connector.
- C** Check if spark occurs while engine is being cranked.
- NOTICE:** To prevent excess fuel being injected from the injectors during this test, don't crank the engine for more than 5 –10 seconds at a time.

OK

NG

Proceed to page [IG-87](#) and continue to troubleshoot.

Proceed to matrix chart of problem systems on page [EG2-435](#).

PARTS LOCATION

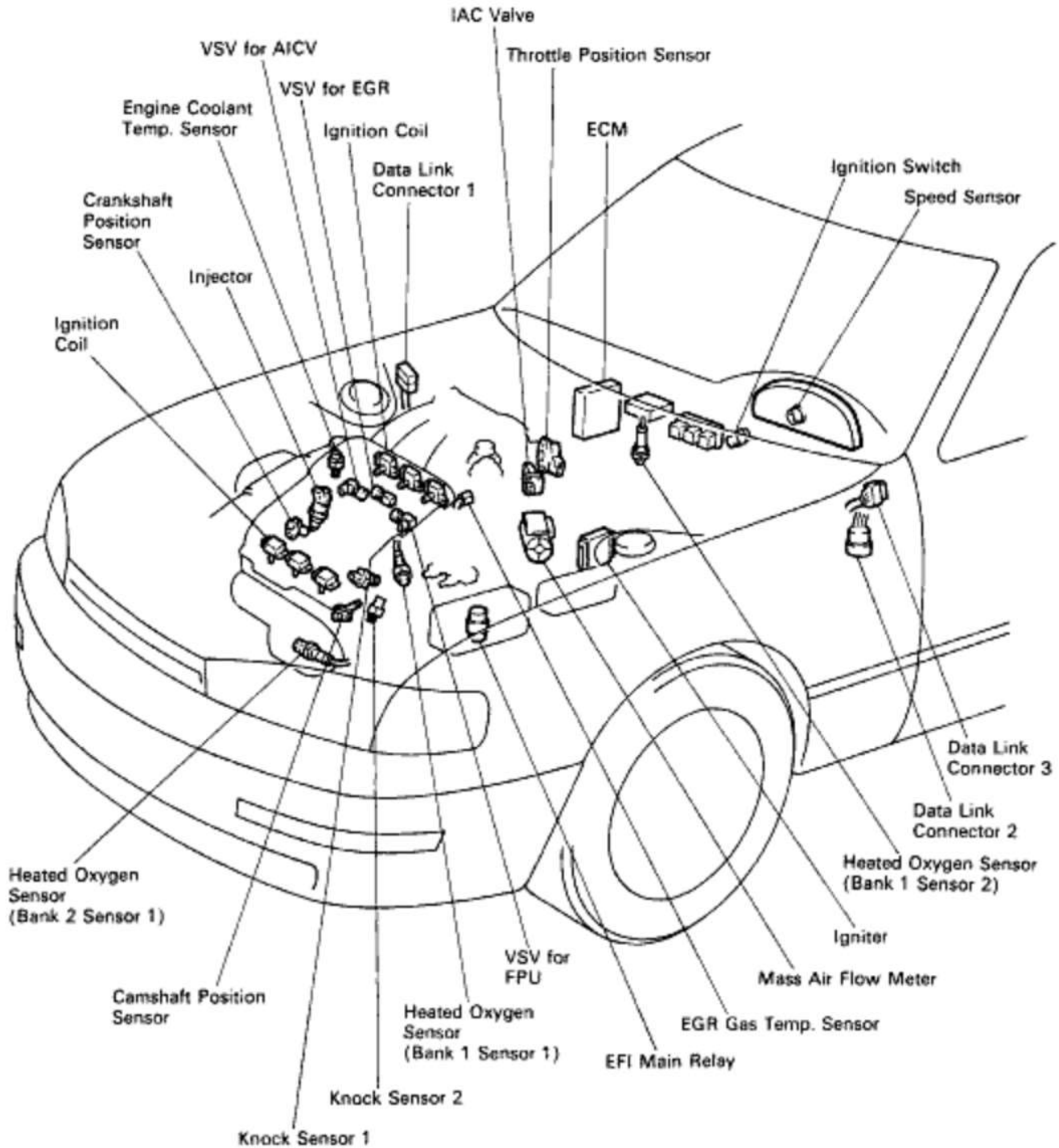

F17089

EG2-424

1MZ-FE ENGINE - WIRING DIAGRAM

WIRING DIAGRAM

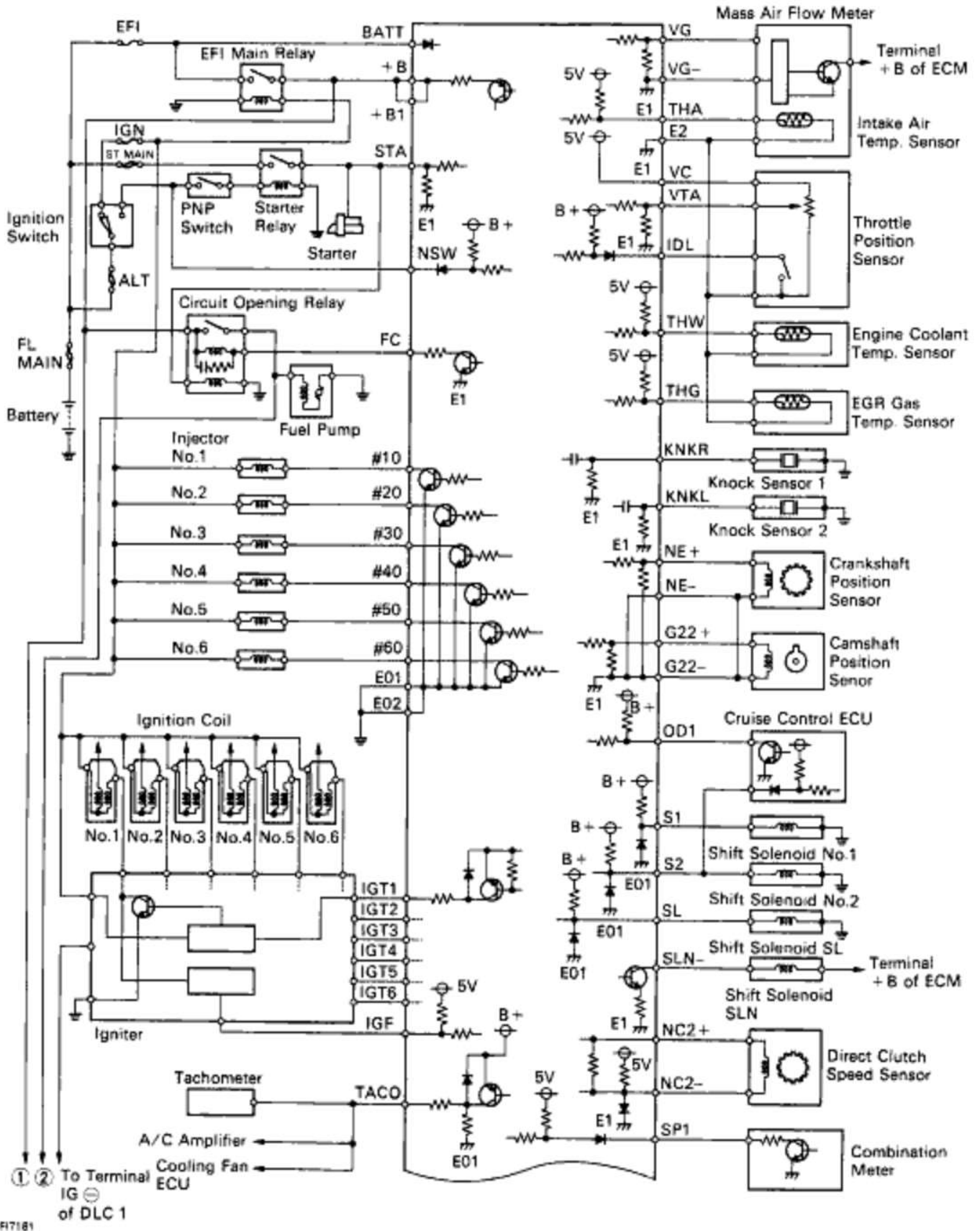

EG2-426

1MZ-FE ENGINE - TERMINALS OF ECM

TERMINALS OF ECM

When measuring the voltage or resistance of the connector part of the ECM, always insert the test probe into the connector from the wire harness side.

ECM Terminals									
		E7		E8		E9		E10	
Terminal No.	Symbol	Connection		Terminal No.	Symbol	Connection			
E7- 1	-	-----		E7-15	IG T3	Igniter			
2	-	-----		16	IG T2	Igniter			
3	SLN ⊕	Shift solenoid SLN		17	S2	Shift Solenoid No.2			
4	-			18	-				
5	#60	Injector (No.6)		19	-	-----			
6	#50	Injector (No.5)		20	-	-----			
7	#40	Injector (No.4)		21	-	-----			
8	#30	Injector (No.3)		22	RSC	IAC valve			
9	#20	Injector (No.2)		23	RSO	IAC valve			
10	#10	Injector (No.1)		24	IGT1	Igniter			
11	S1	Shift solenoid No.1		25	FPU	Fuel pressure up VSV			
12	IGF	Igniter		26	IGT4	Igniter			
13	STA	Starter relay		27	SL	Shift solenoid SL			
14	NSW	Park/Neutral position switch		28	E03	Oxygen sensor heater ground			

1MZ-FE ENGINE - TERMINALS OF ECM

Terminal No.	Symbol	Connection	Terminal No.	Symbol	Connection
E7-29	IGT6	Igniter	E8-19	OXL	Heated oxygen sensor (Bank 2 Sensor 1)
30	IGT5	Igniter	20	THW	Engine coolant temp. sensor
31	-	-----	21	THA	Intake air temp. sensor
32	IDL	Throttle position sensor	22	E2	Sensor ground
33	E02	Power ground	E9- 1	ACV	A/C idle-up VSV
34	E01	Power ground	2	-	-----
E8- 1	VC	Throttle position sensor	3	W	Malfunction indicator lamp
2	-	-----	4	-	-----
3	-	-----	5	TE1	Data link connector 1
4	NC2 ⊖	Direct clutch speed sensor	6	ACIS	Intake air control valve VSV
5	NE ⊕	Crankshaft position sensor	7	VG ⊖	Mass air flow meter
6	NE ⊖	Crankshaft position sensor	8	-	-----
7	VTA	Throttle position sensor	9	-	-----
8	VG	Mass air flow meter	10	HTL	Heated oxygen sensor heater (Bank 2 Sensor 1)
9	NC2 ⊕	Direct clutch speed sensor	11	HTR	Heated oxygen sensor heater (Bank 1 Sensor 1)
10	-	-----	12	EGR	EGR VSV
11	-	-----	13	-	-----
12	-	-----	14	THG	EG R gas temp. sensor
13	OXR	Heated oxygen sensor (Bank 1 Sensor 1)	15	-	-----
14	KNKL	Knock sensor 2	16	E1	ECM ground
15	KNKR	Knock sensor 1	E10- 1	-	-----
16	G22 ⊕	Camshaft position sensor	2	L	Park/Neutral position switch
17	G22 ⊖	Camshaft position sensor	3	P	Electronically controlled transmission select switch
18	FC	Circuit opening relay	4	-	-----

EG2-428

1MZ-FE ENGINE - TERMINALS OF ECM

TERMINALS OF ECM (Cont'd)

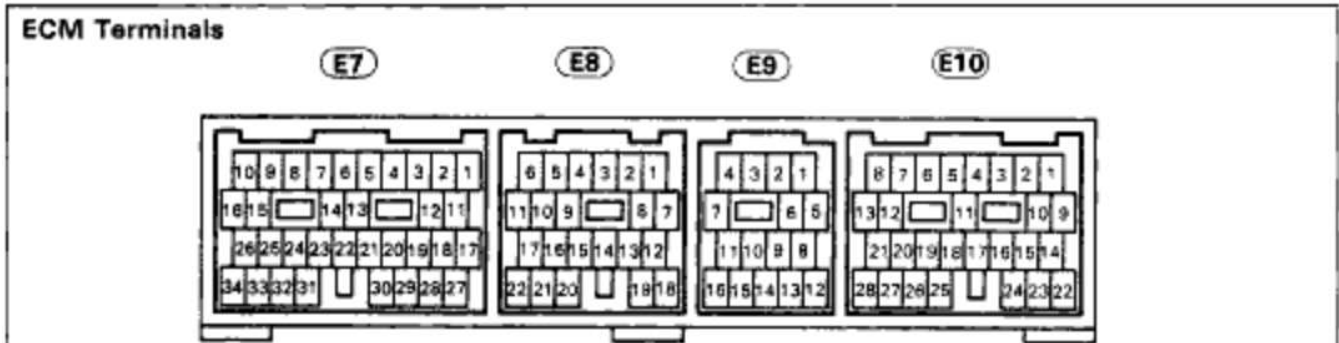

F15810

Terminal No.	Symbol	Connection	Terminal No.	Symbol	Connection
E10- 5	ACT	A/C control assembly	E10-17	-	---
6	OD2	0/D main switch	18	-	---
7	OD1	Cruise control ECU	19	-	---
8	-	---	20	A/C	A/C control assembly
9	-	---	21	ELS	Defogger relay Taillight relay
10	2	Park/Neutral position switch	22	+ B	EFI Main relay
11	-	---	23	+ B1	EFI Main relay
12	SP1	Vehicle speed sensor	24	STP	Stop light switch Stop light
13	TACO	Tachometer	25	HTS	Heated oxygen sensor heater (Bank 1 Sensor 2)
14	BATT	Battery	26	OXS	Heated oxygen sensor (Bank 1 Sensor 2)
15	R	Park/Neutral position switch	27	-	---
16	-	---	28	SDL	Data link connector 3

- MEMO -

STANDARD VALUE OF ECM TERMINALS

Symbols (Terminals No.)	Wiring Color	STD Voltage (V)	Condition
BATT (E10-14) - E1 (E9-16)	W-L ↔ BR	9 ~ 14	Always
+B (E10-22) +B1 (E10-23) - E1 (E9-16)	B-O ↔ BR B-O ↔ BR	9 ~ 14	IG switch ON
VC (E8-1) - E2 (E8-22)	L-R ↔ BR	4.5 ~ 5.5	IG switch ON
IDL (E7-32) - E2 (E8-22)	L ↔ BR	0 ~ 3	IG switch 0 N Throttle valve fully closed.
		9 ~ 14	IG switch ON Throttle valve fully open.
VTA (E10-7) - E2 (E8-22)	B-Y ↔ BR	0.3 ~ 0.8	IG switch ON Throttle valve fully closed.
		3.2 ~ 4.9	IG switch 0 N Throttle valve fully open.
VG (E8-8) - VG - (E9-7)	R ↔ R-B	1.1 - 1.5	Idling, P or N Position, A/C switch off.
THA (E8-21) - E2 (E8-22)	L-B ↔ BR	0.5 ~ 3.4	Idling, Intake air temp. 20°C (68°F)
THW (E8-20) - E2 (E8-22)	G-B ↔ BR	0.2 ~ 1.0	Idling, Engine coolant temp. 80°C (176°F)
STA (E7-13) - E1 (E9-16)	B-W ↔ BR	8.0 or more	Cranking
#10 (E7-10) #20 (E7-9) #30 (E7-8) - E01 (E7-34) #40 (E7-7) #50 (E7-6) #60 (E7-5)	W Y GR L ↔ W-B R G	9 ~ 14	IG switch 0 N
		Pulse generation (See page EG2-492)	Idling
IGT1 (E7-24) IGT2 (E7-16) IGT3 (E7-15) - E1 (E9-16) IGT4 (E7-26) IGT5 (E7-30) IGT6 (E7-29)	W-G Y-R GR-B ↔ BR L-B R-B G-R	Pulse generation (See page EG2-556)	Idling
		4.5 ~ 5.5	IG switch ON
IGF (E7-12) - E1 (E9-16)	W-R ↔ BR	Pulse generation (See page EG2-556)	Idling
		Pulse generation (See page EG2-505)	Idling
G22 ⊕ (E8-16) - G22 ⊖ (E8-17)	B-W ↔ L	Pulse generation (See page EG2-505)	Idling
NE ⊕ (E8-5) - NE ⊖ (E8-6)	R ↔ G	Pulse generation (See page EG2-505)	Idling
FPU (E7-25) - E1 (E9-16)	B-R ↔ BR	9 ~ 14	IG switch ON
		0 ~ 3	Restarting at high engine coolant temp.
ELS (E10-21) - E1 (E9-16)	B-R ↔ BR	7.5 ~ 14	Defogger switch and taillight switch ON.
		0 ~ 1.5	Defogger switch and taillight switch OFF.
EGR (E9-12) - E1 (E9-16)	B-L ↔ BR	9 ~ 14	IG switch ON
ACIS (E9-8) - E1 (E9-16)	R-Y ↔ BR	9 ~ 14	IG switch ON

STANDARD VALUE OF ECM TERMINALS (Cont'd)

Symbols (Terminals No.)	Wiring Color	STD Voltage (V)	Condition
RSC (E7-22) - E1 (E9-16) RSO (E7-23)	Y-B ↔ BR G-B ↔ BR	9 ~ 14	IG switch ON Disconnect (E7) of ECM connector
ACV (E9-1) - E1 (E9-16)	W-L ↔ BR	0 ~ 3	Idling, A/C switch ON
		9 ~ 14	Idling, A/C switch OFF
OXR (E8-13) - E1 (E9-16) OXL (E8-19)	R-L ↔ BR R-L ↔ BR	Pulse generation	Maintain engine speed at 2,500 rpm for 2 mins. after warming up.
HTL (E9-10) HTR (E9-11) - E03 (E7-28) HTS (E10-25)	V-R L-B ↔ W-B P-B	Below 3.0	Idling
		9 ~ 14	IG switch ON
KNKR (E8-15) - E1 (E9-16) KNKL (E8-14)	W ↔ BR W ↔ BR	Pulse generation (See page EG-502)	Idling
NSW (E7-14) - E1 (E9-16)	B-W ↔ BR	9 ~ 14	IG switch ON Other shift position in "P", "N" position
		0 ~ 3.0	IG switch ON Shift position in "P", "N" position
SP1 (E10-12) - E1 (E9-16)	V-Y ↔ BR	Pulse generation	IG switch ON Rotate driving wheel slowly.
TE1 (E9-5) - E1 (E9-16)	GR-B ↔ BR	4.5 ~ 5.5	IG switch ON
OD1 (E10-7) - E1 (E9-16)	Y-B ↔ BR	4.5 ~ 5.5	IG switch ON
ACT (E10-5) - E1 (E9-16)	LG-B ↔ BR	4.5 ~ 5.5	Idling, A/C switch ON
		Below 2.0	Idling, A/C switch OFF
A/C (E10-20) - E1 (E9-16)	B-Y ↔ BR	Below 2.0	Idling, A/C switch ON
		4.5 ~ 5.5	Idling, A/C switch OFF