

* 3 : Before Nov. 2009 Production
 * 4 : From Nov. 2009 Production

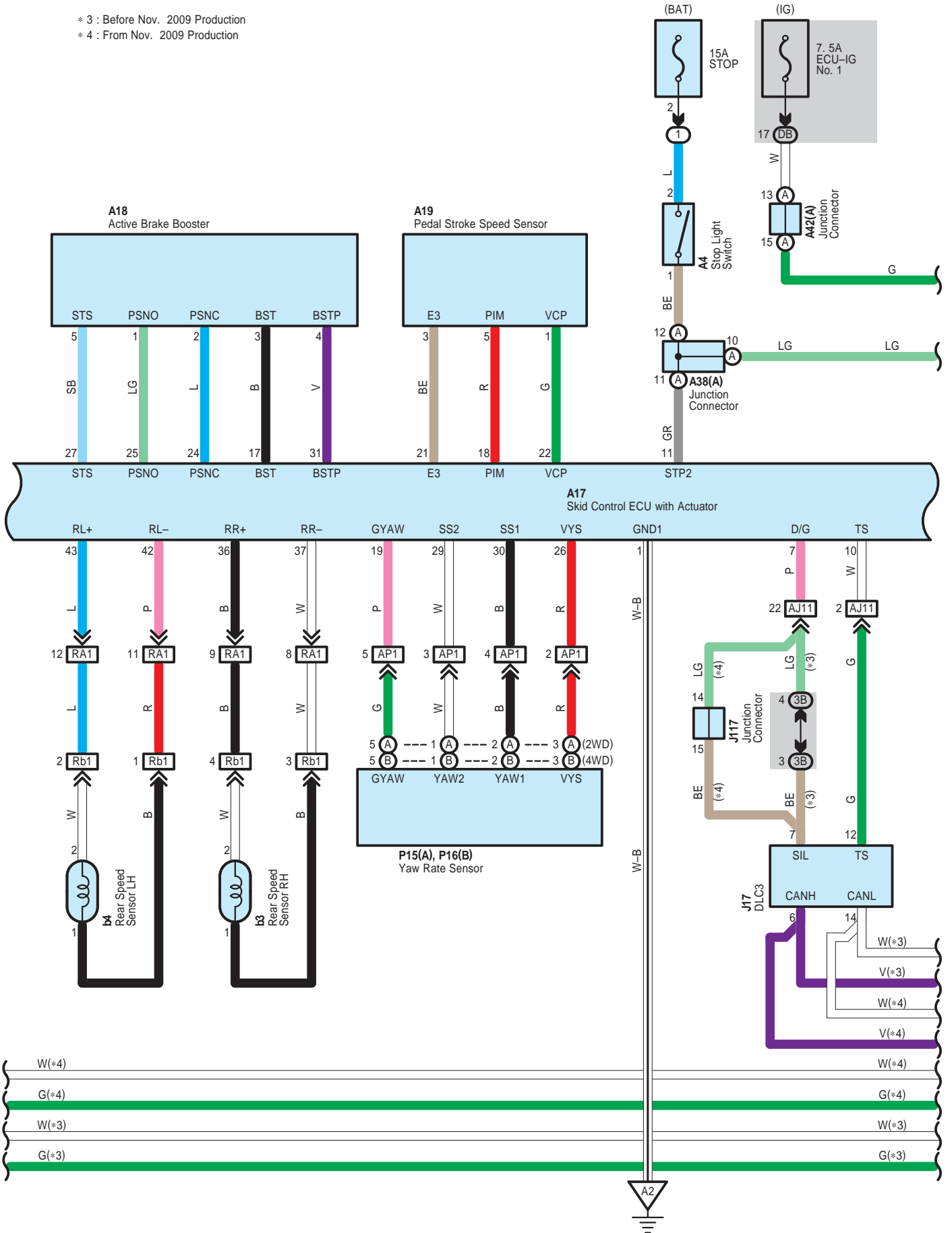

- * 1 : Except 1GR-FE
- * 3 : Before Nov. 2009 Production
- * 4 : From Nov. 2009 Production

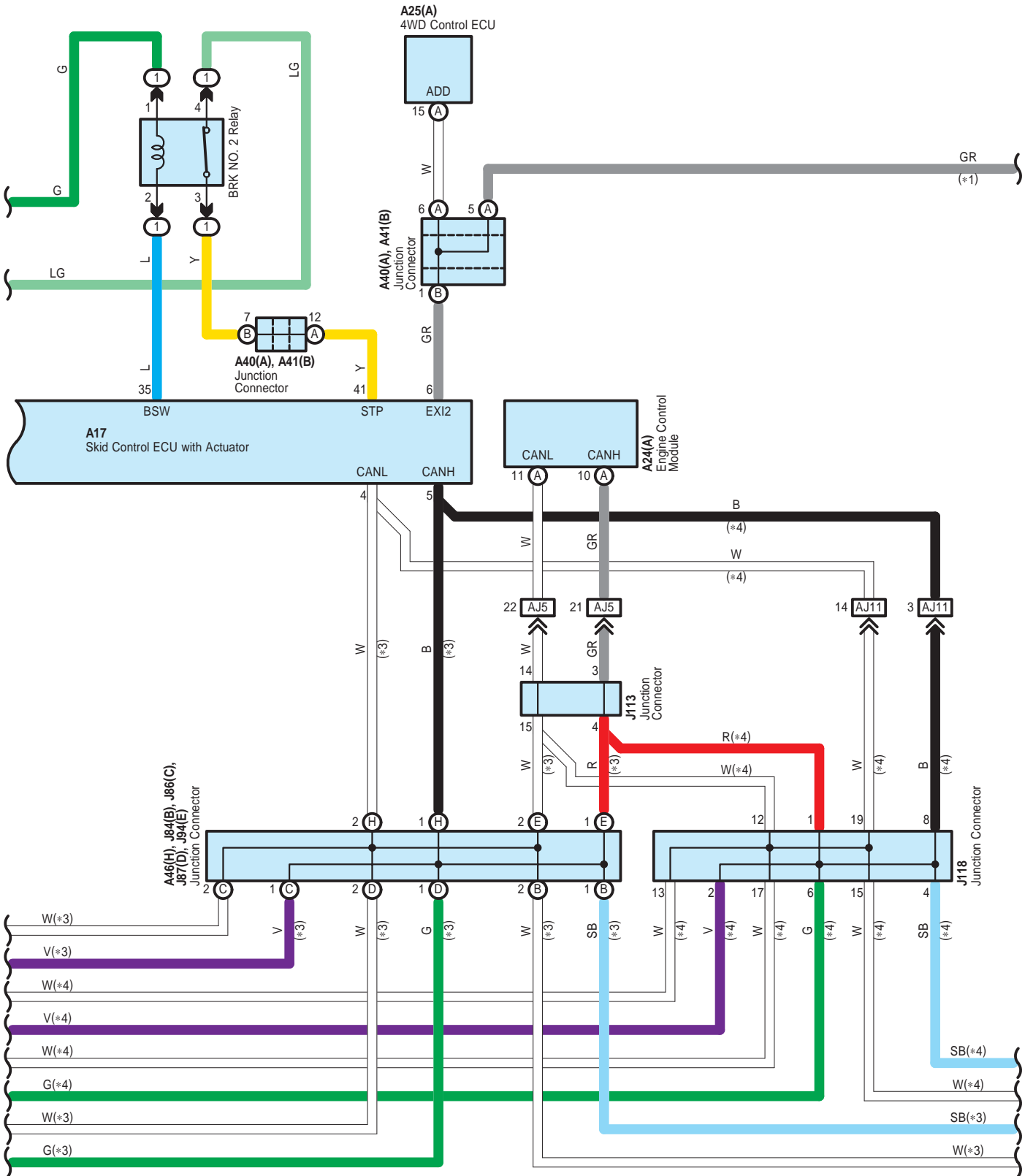

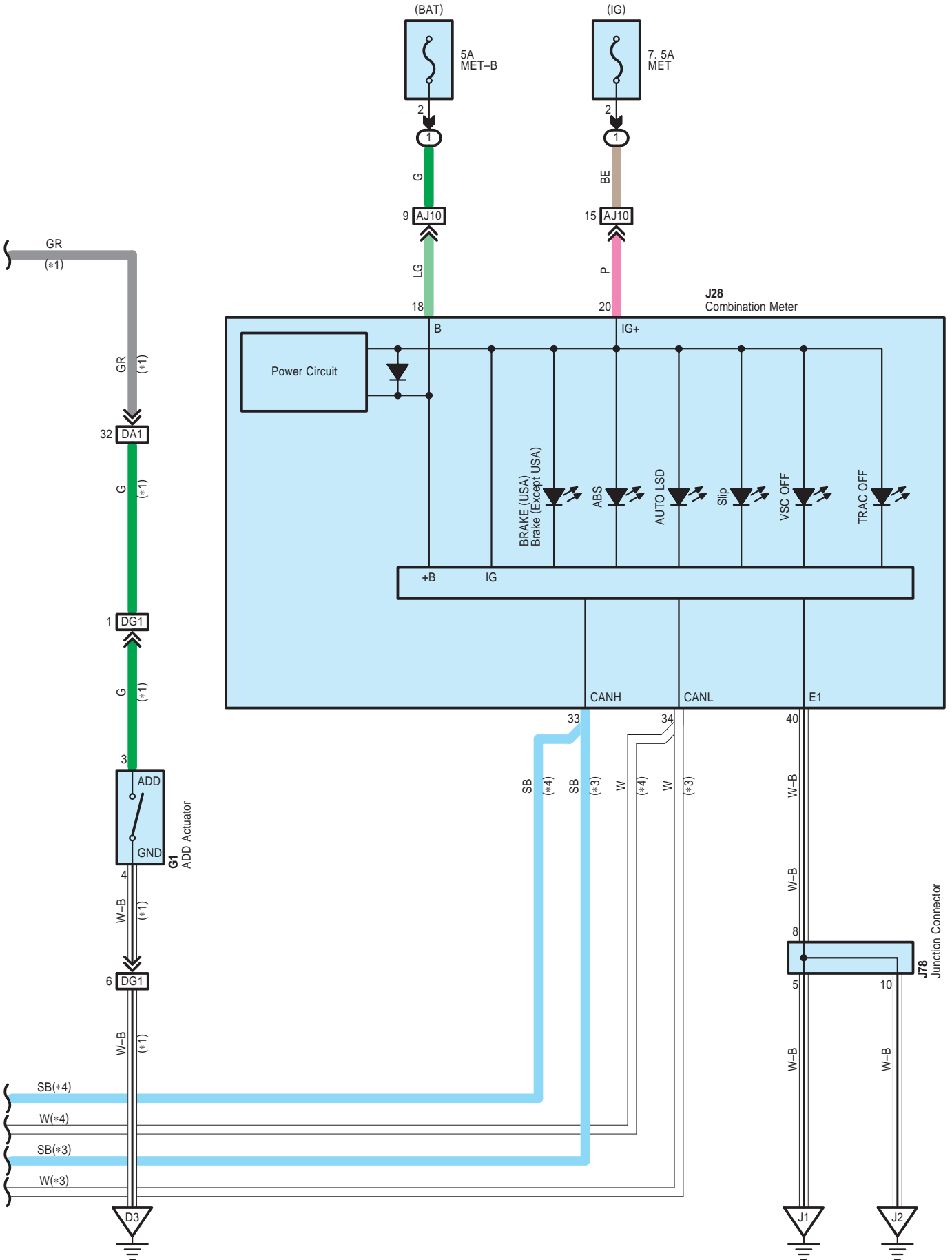

A 4

Blue

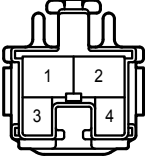

A 5

White



A 17

Black

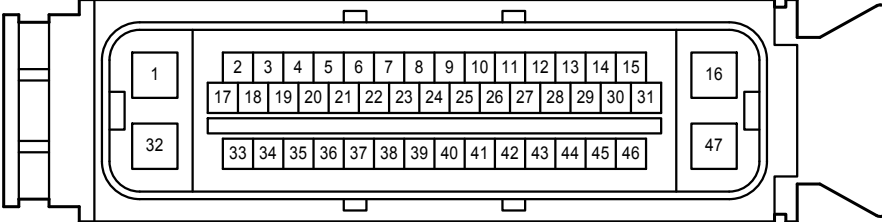

A 18

Black

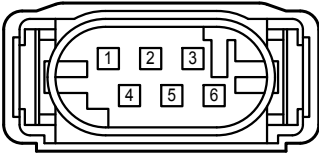

A 19

Black

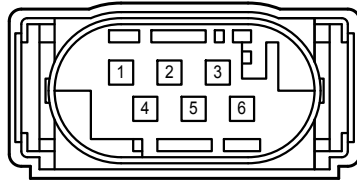

A 24

Black

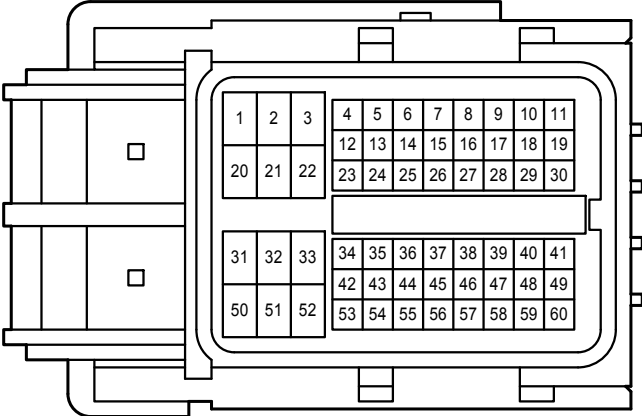

A 25

Black

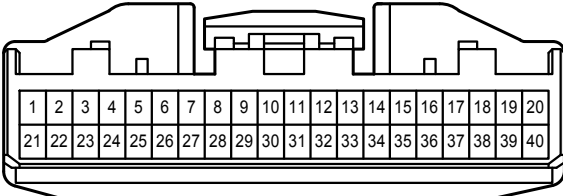

A 38

White

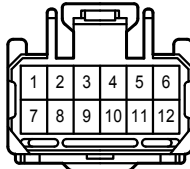

A 40

White

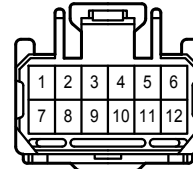

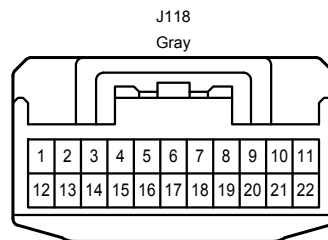
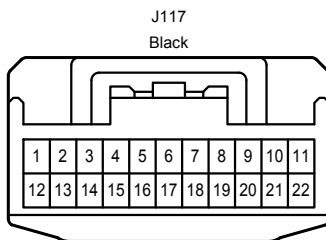
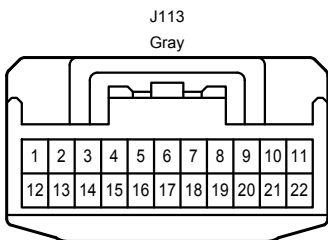
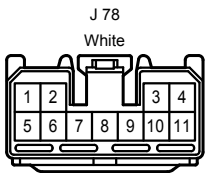
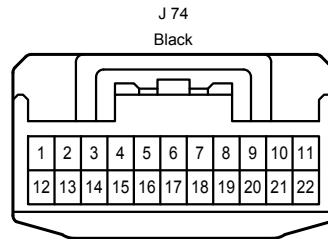
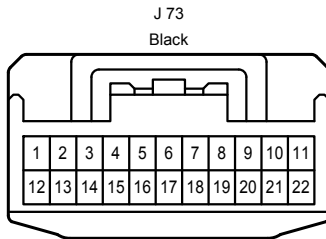
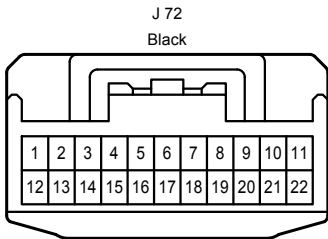
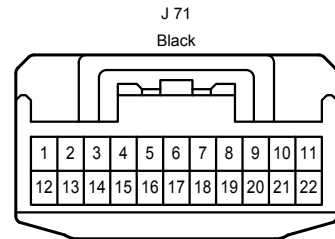
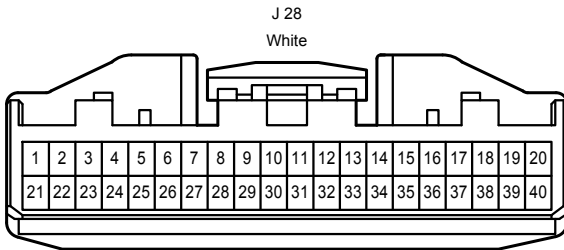
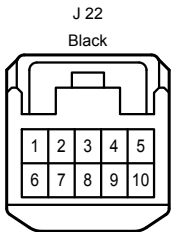
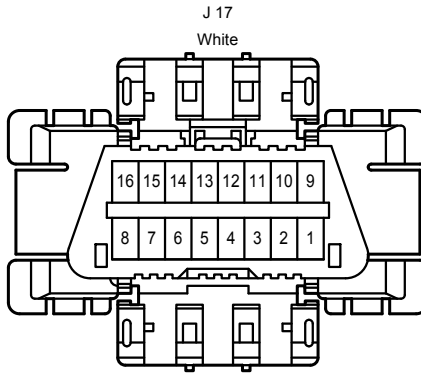
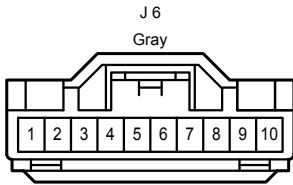
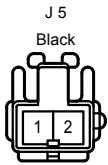
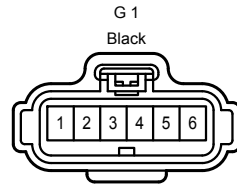
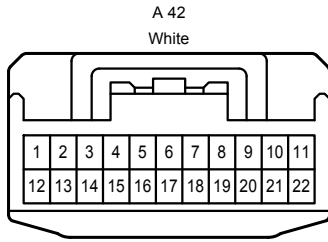
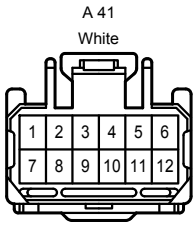

P 15
Black

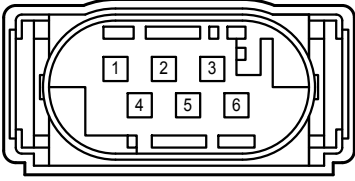

P 16
Black

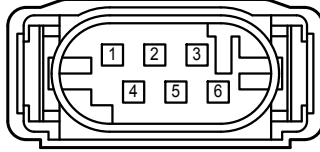

b 1
Black

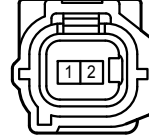

b 2
Black



b 3
Black



b 4
Black

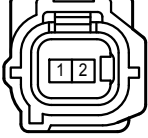

3B
White

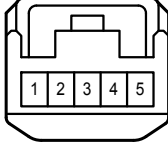

DB
White

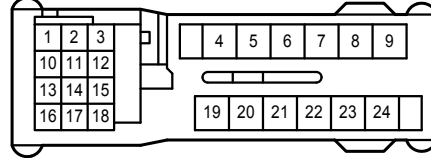

DD
White

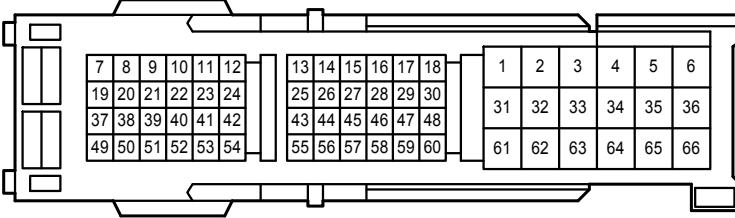

AJ5
White

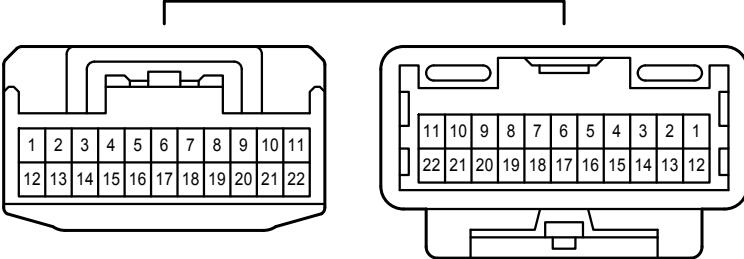

AJ10
Gray

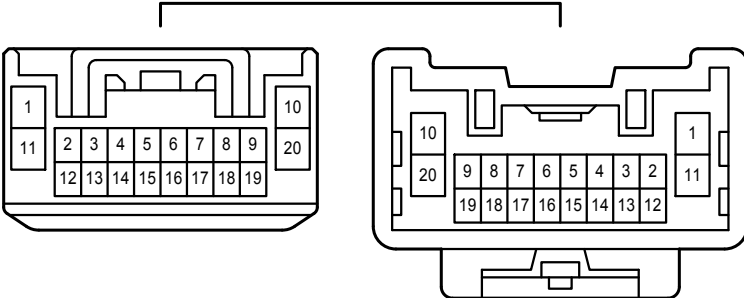

AJ11
Gray

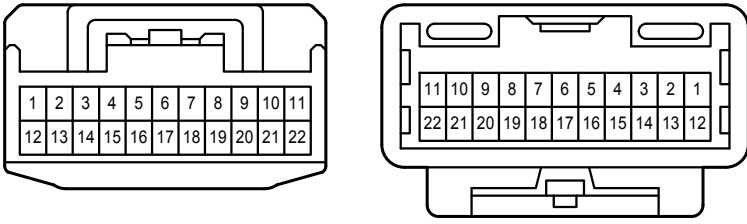

AP1
White

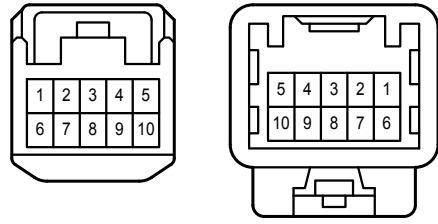

Ab1
Gray

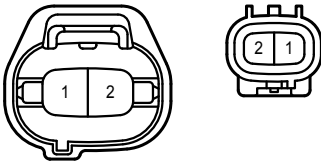

Ab2
Gray

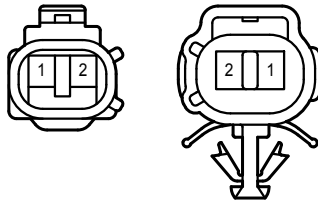

DA1
White

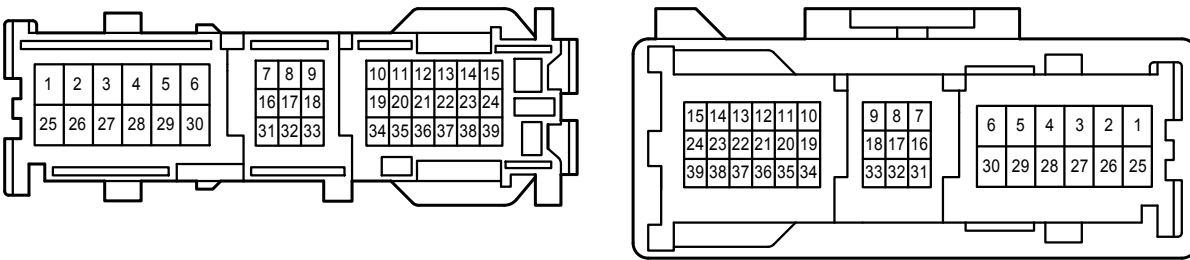

DG1
Black

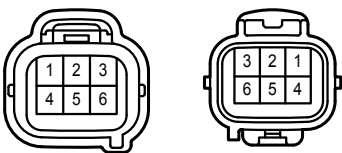

RA1
White

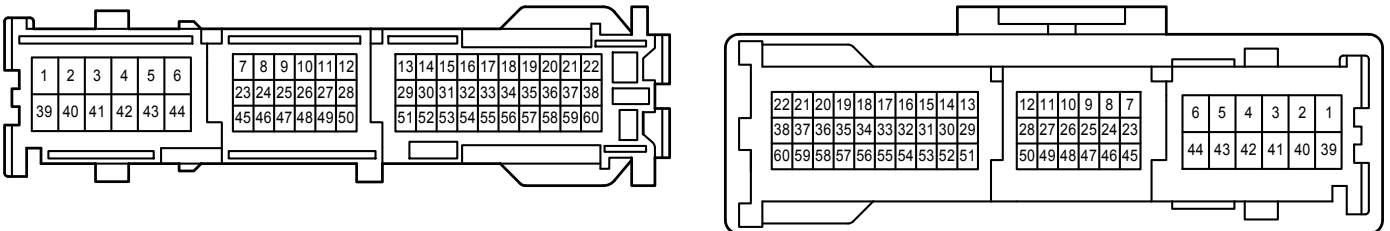

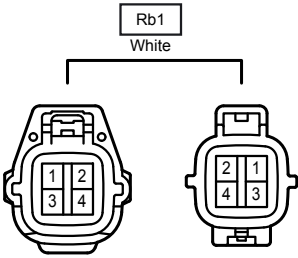

Accessory Meter

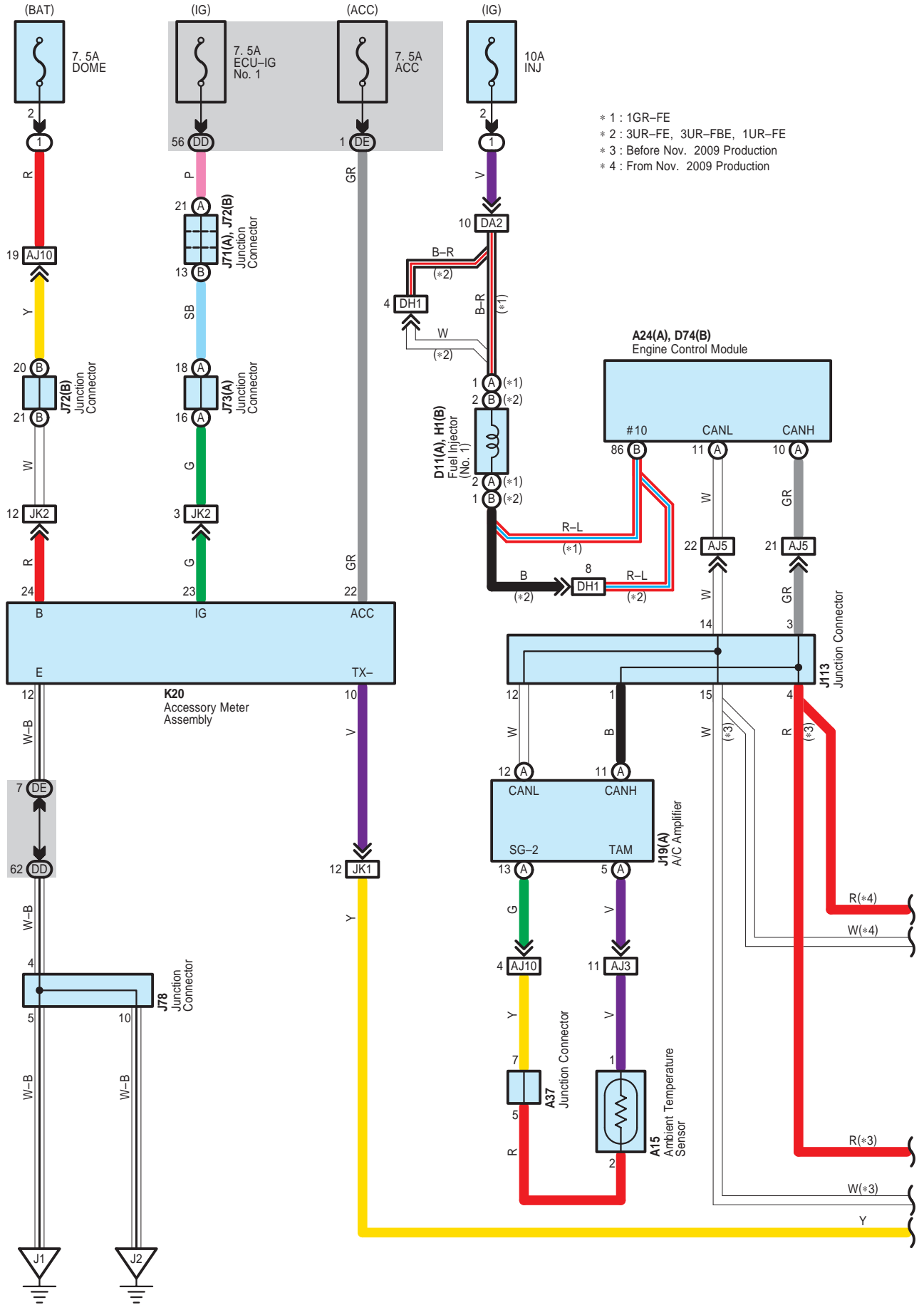

Accessory Meter

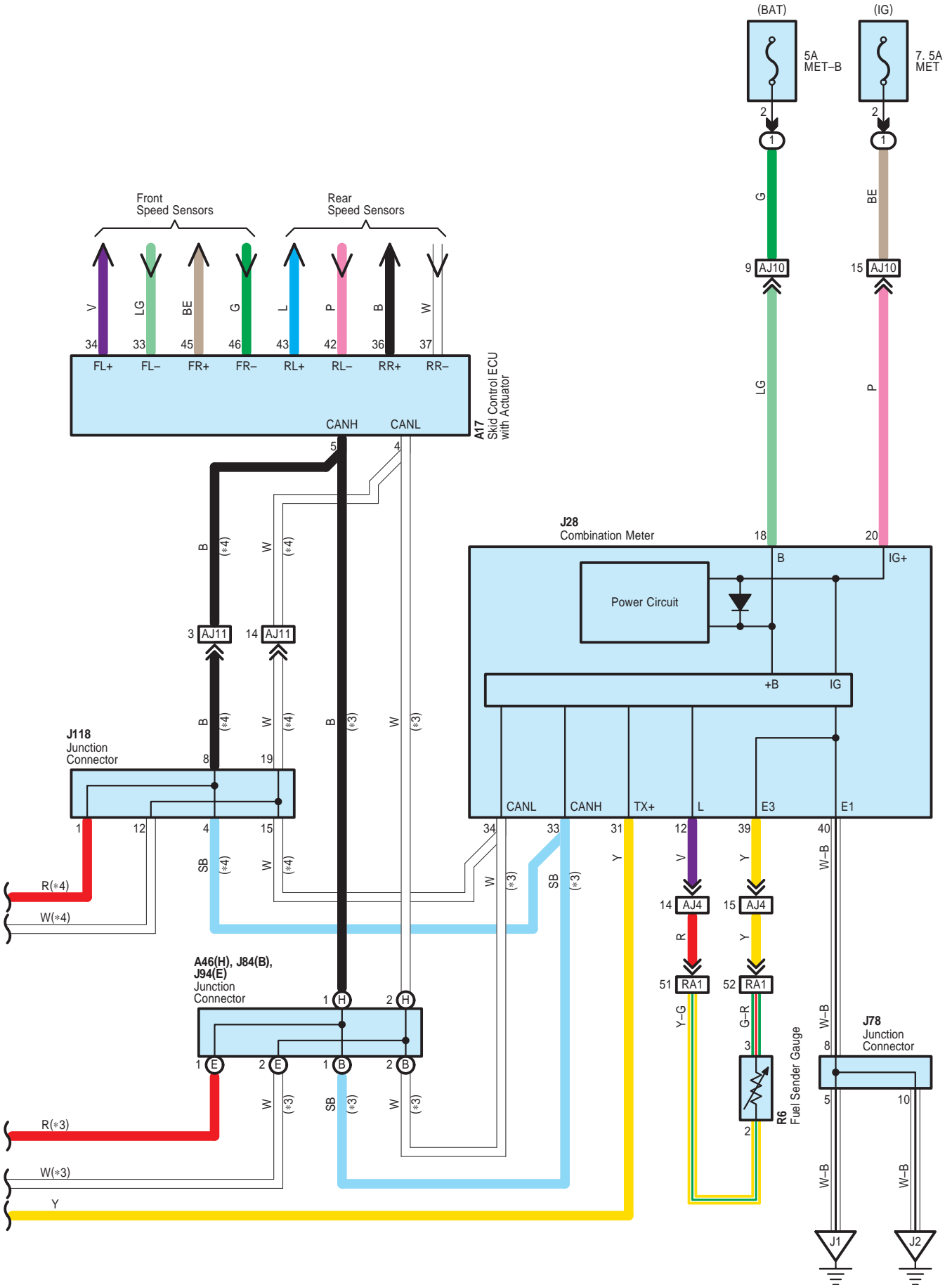

Accessory Meter

A 15
Black



A 17
Black

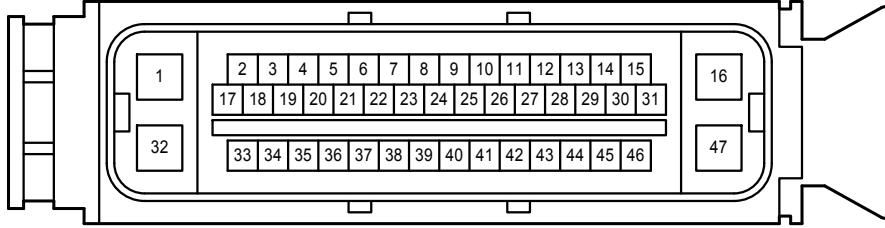

A 24
Black

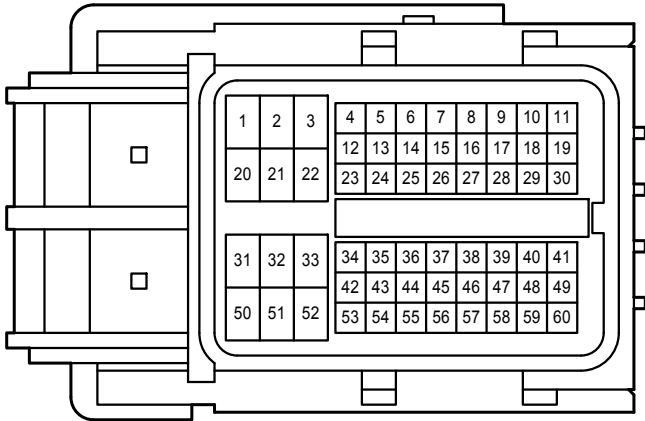

A 37
White

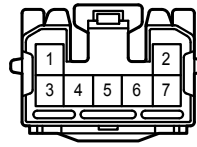

A 46
White

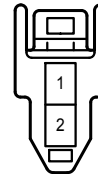

D 11
Gray

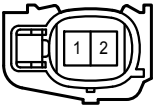

D 74
Black

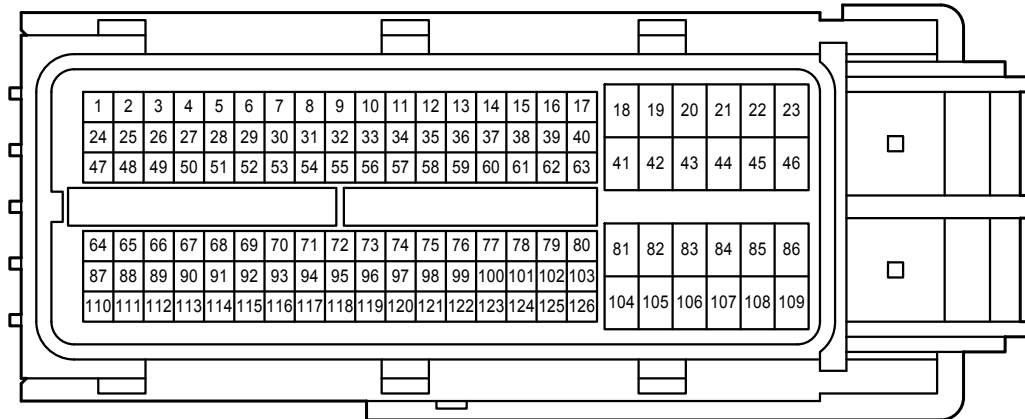

H 1
Black

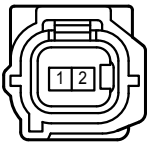

J 19
White

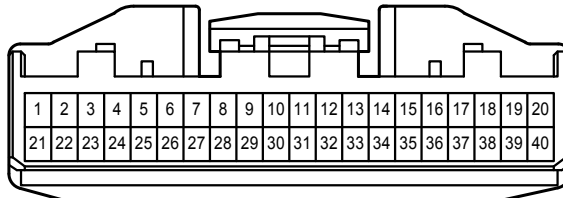

Accessory Meter

J 28
White

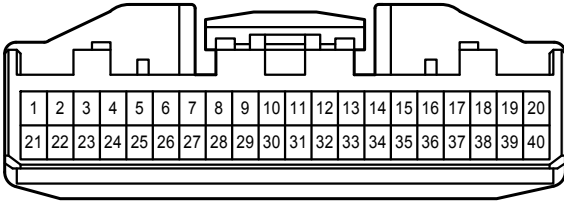

J 71
Black

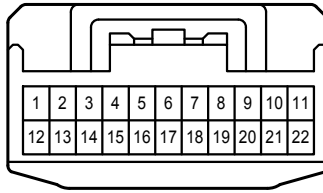

J 72
Black

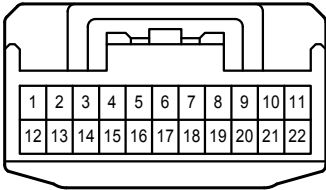

J 73
Black

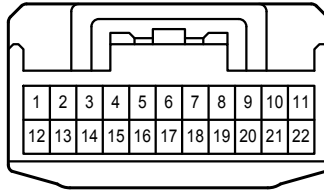

J 78
White

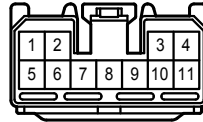

J 84
White

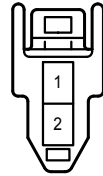

J 94
White

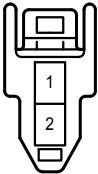

J113
Gray

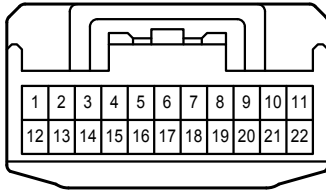

J118
Gray

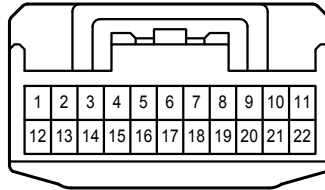

K 20
White

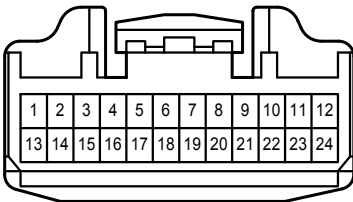

R 6
White



DD
White

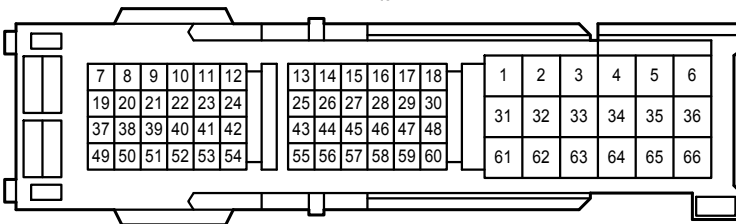

DE
White

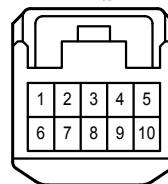

AJ3
White

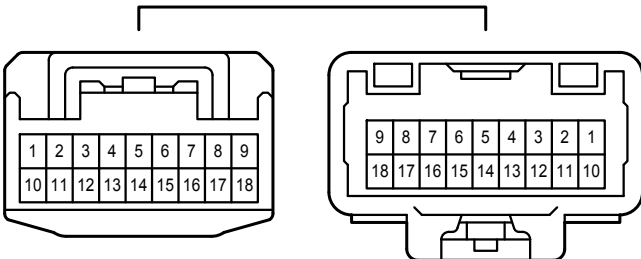

AJ4
White

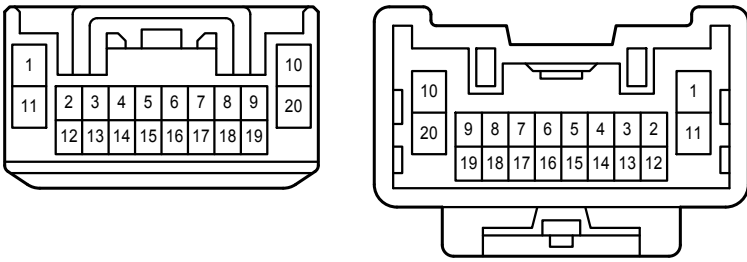

AJ5
White

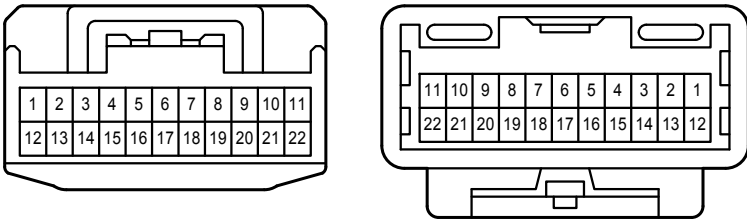

AJ10
Gray

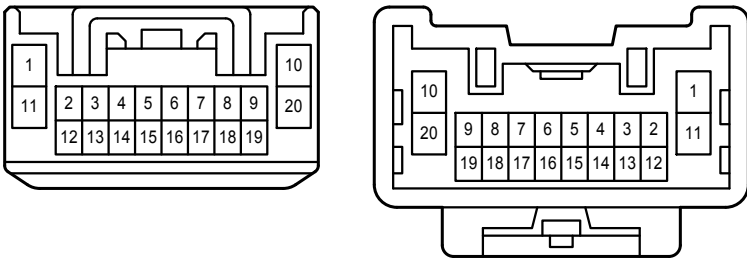

AJ11
Gray

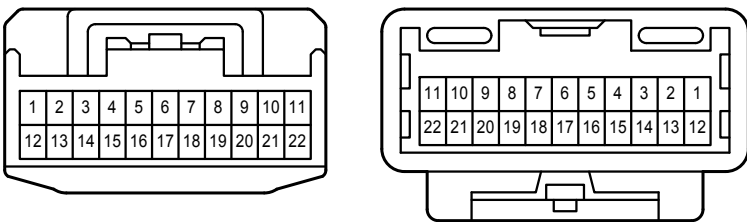

DA2
White

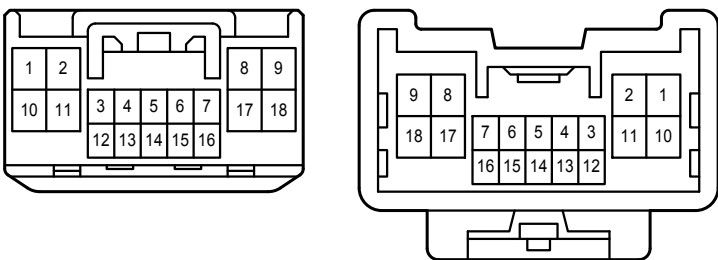

DH1
Gray

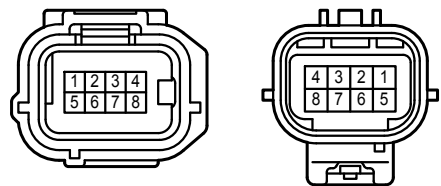

Accessory Meter

JK1
White

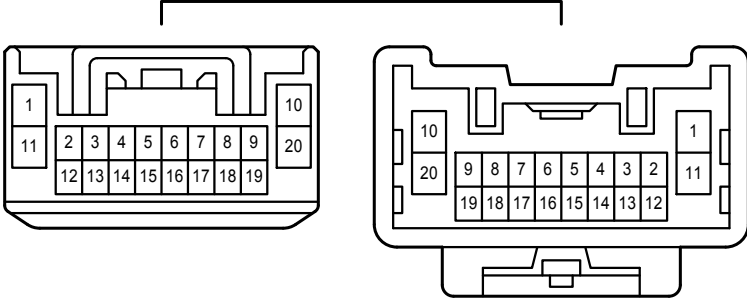

JK2
White

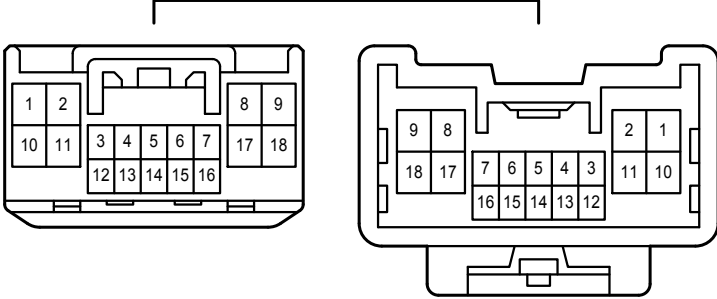

RA1
White

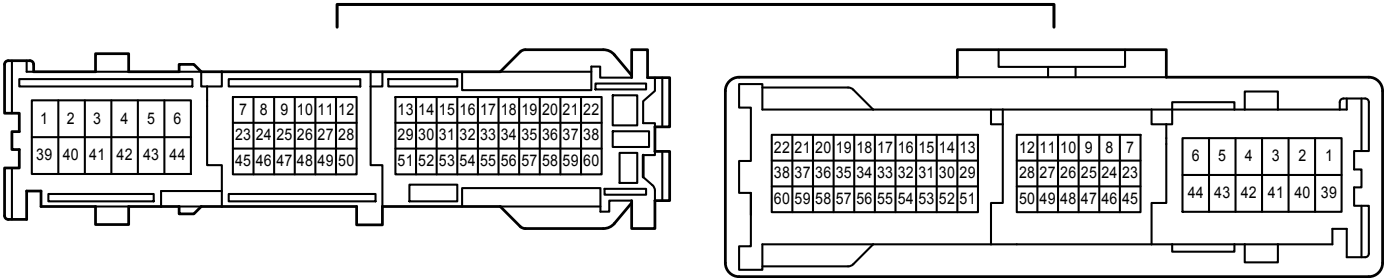

Air Conditioning

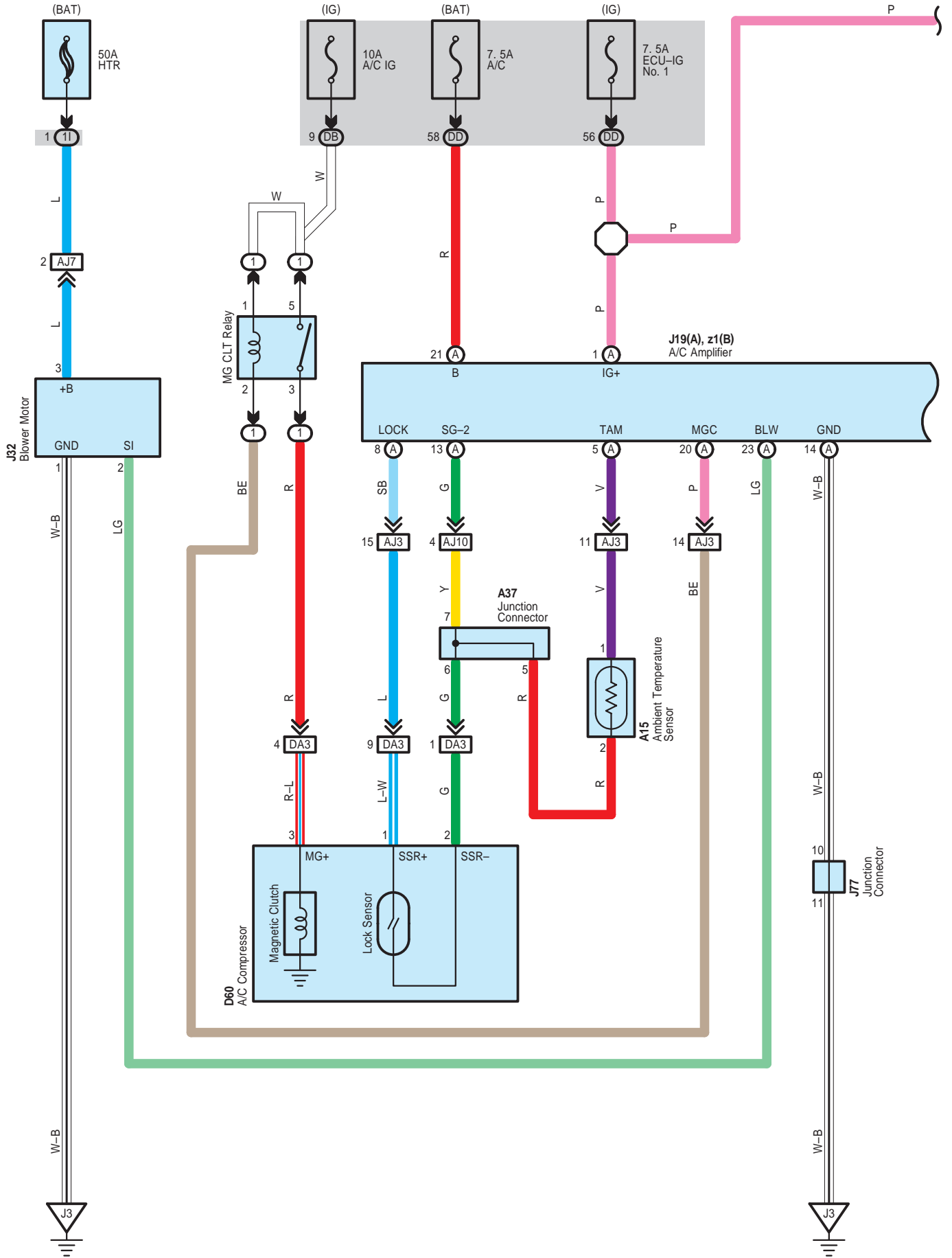

Air Conditioning

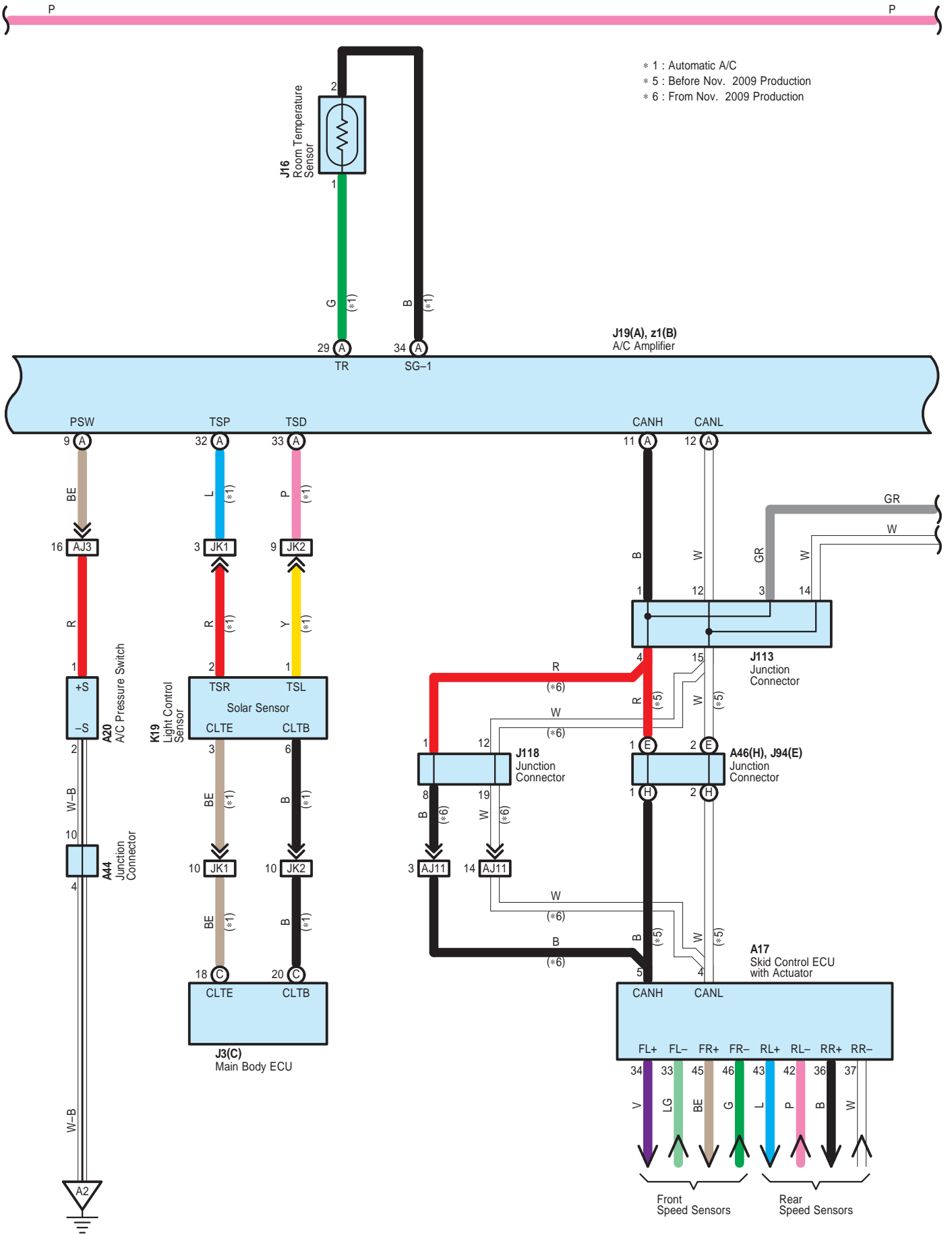

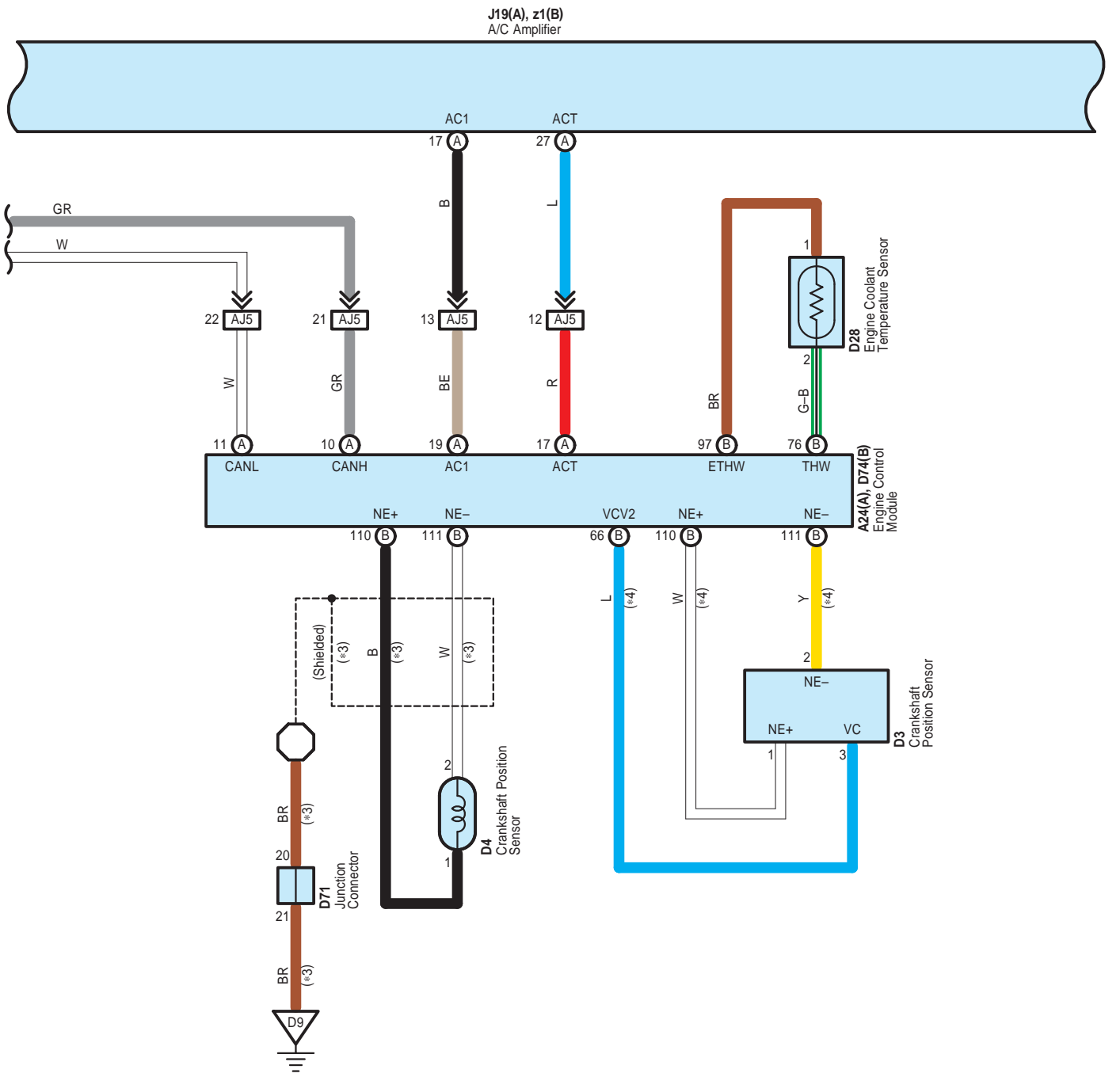



* 3 : 1GR-FE
 * 4 : 3UR-FE, 3UR-FBE, 1UR-FE

J19(A), z1(B)
 A/C Amplifier

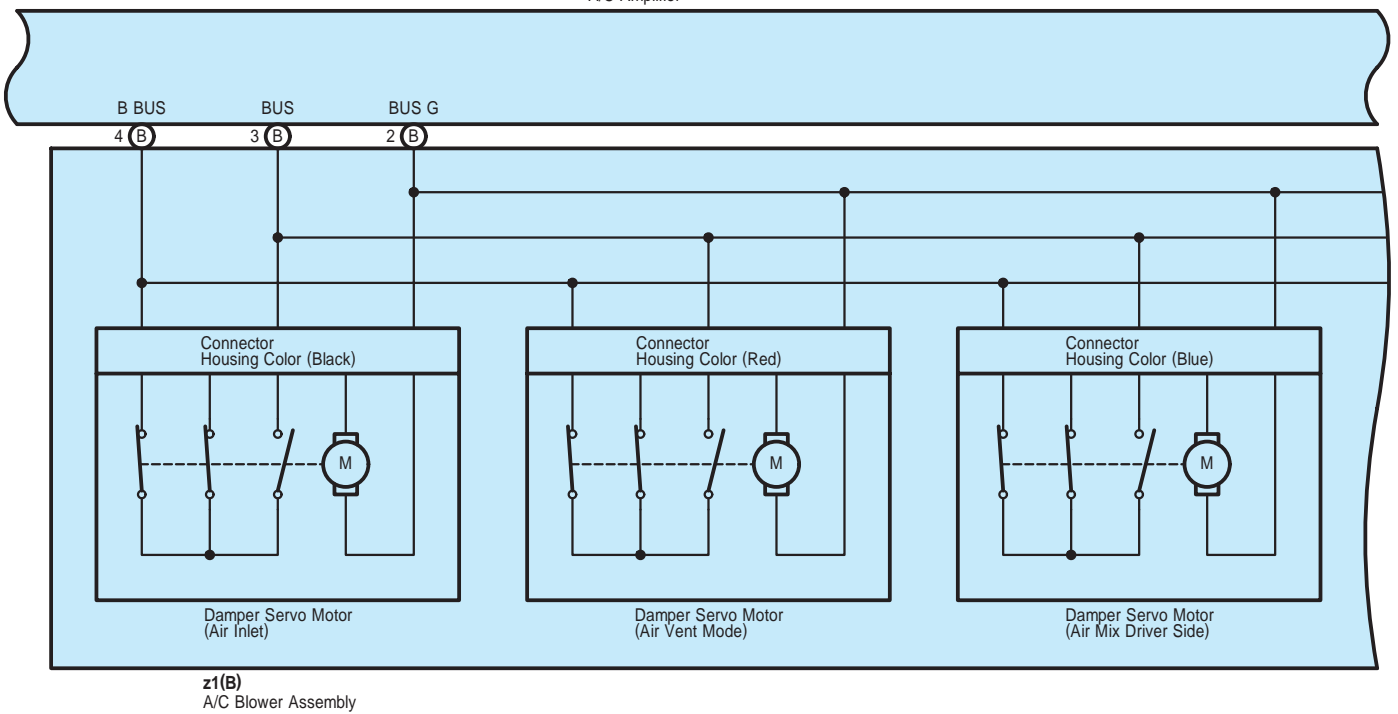

Air Conditioning

* 1 : Automatic A/C

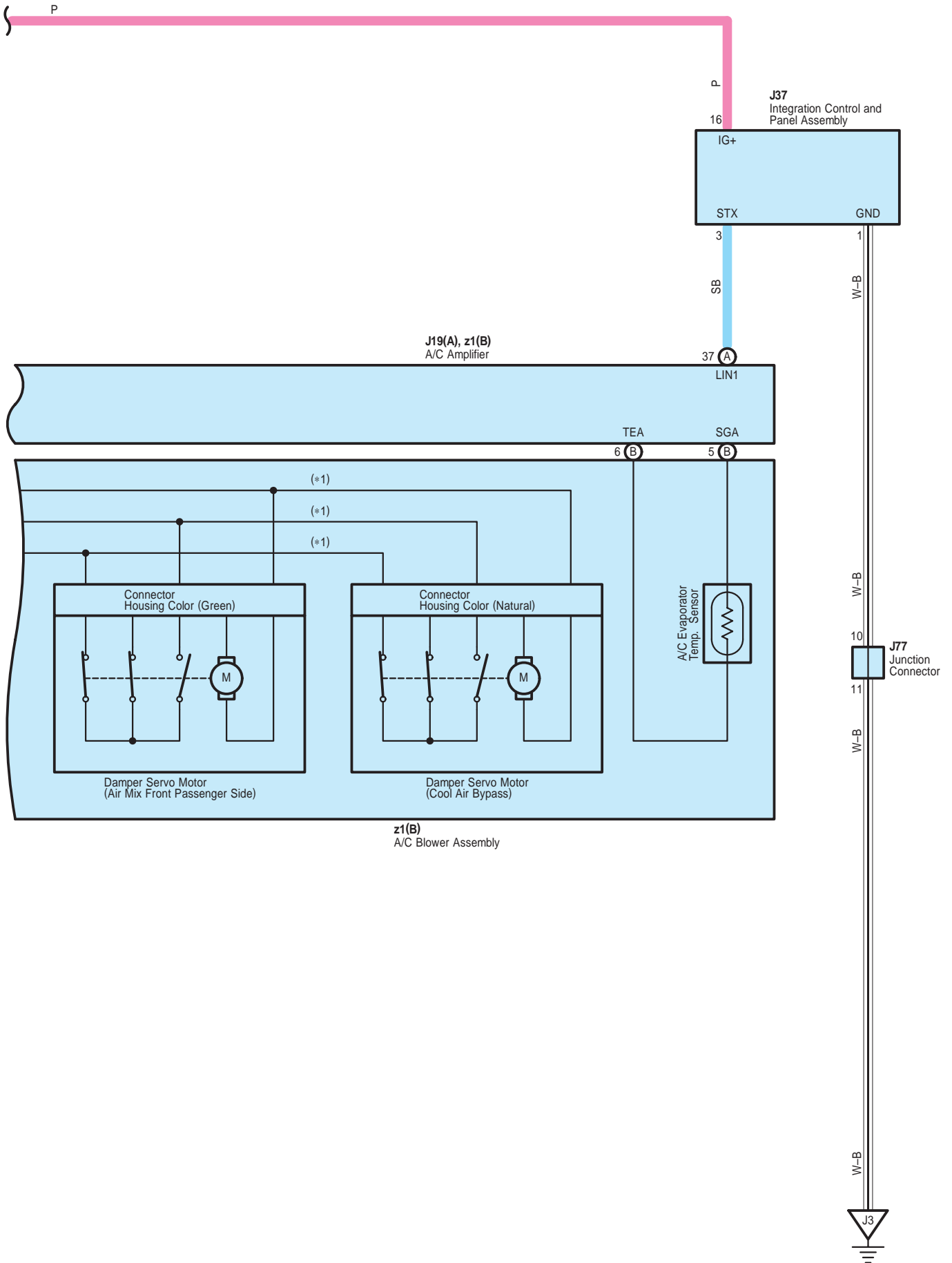

Air Conditioning

A 15
Black



A 17
Black

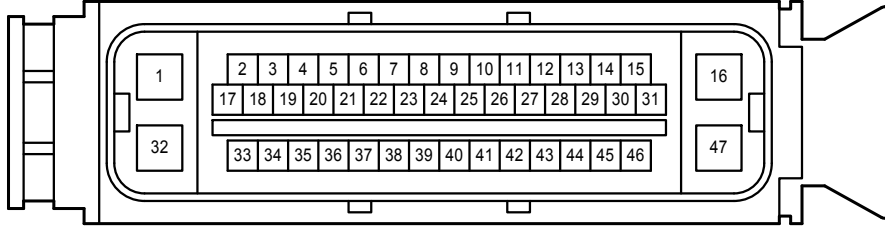

A 20
Black

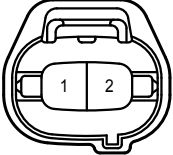

A 24
Black

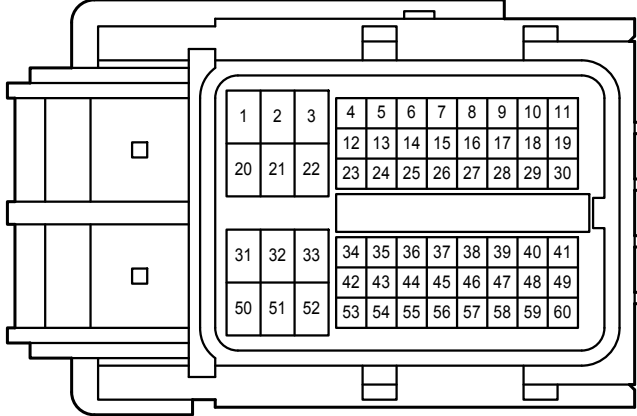

A 37
White

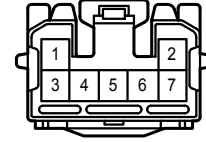

A 44
White

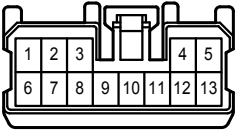

A 46
White

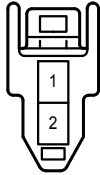

D 3
Black

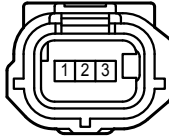

D 4
Black

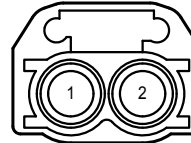

D 28
Dark Gray



D 60
Gray



D 71
White

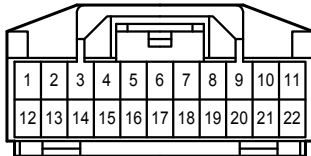

D 74
Black

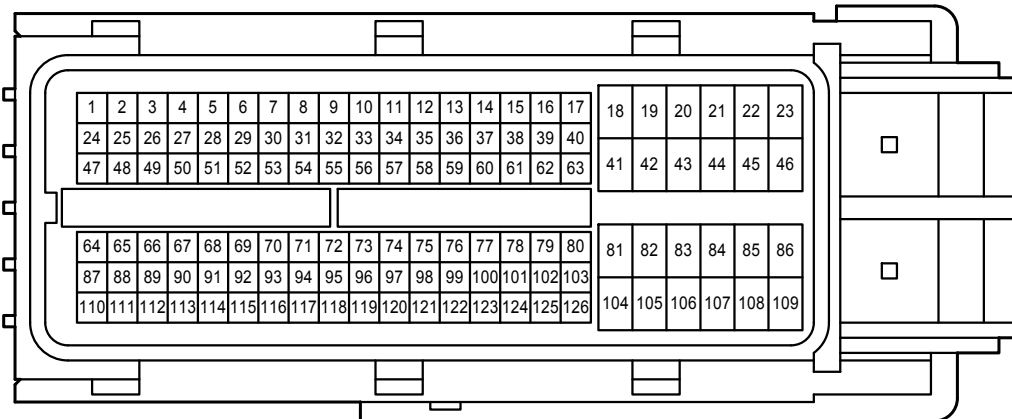

Air Conditioning

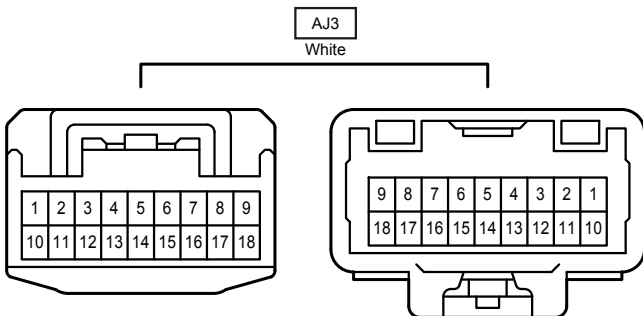
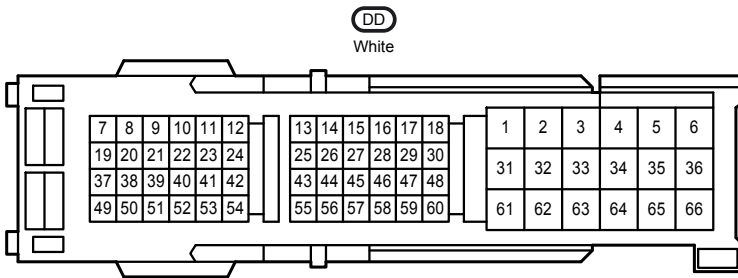
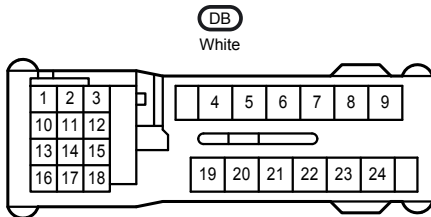
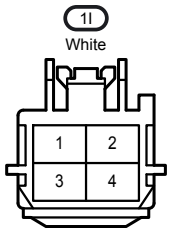
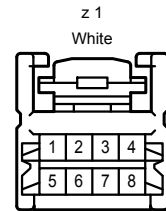
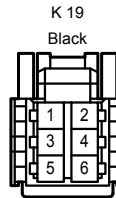
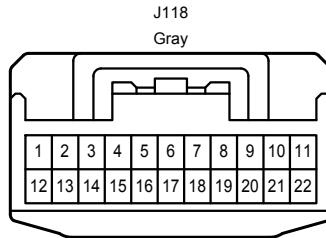
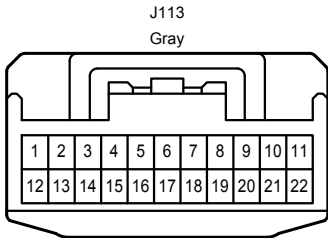
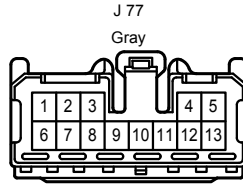
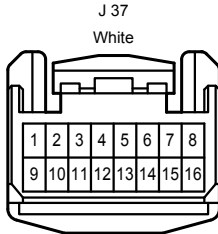
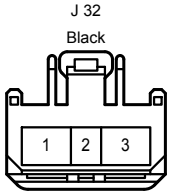
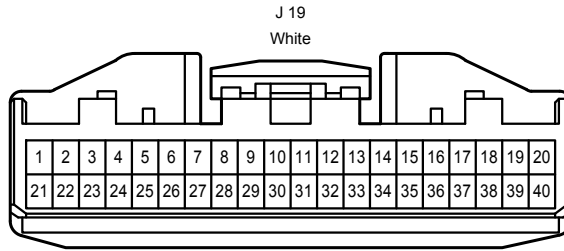
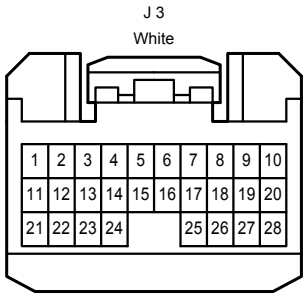

AJ5
White

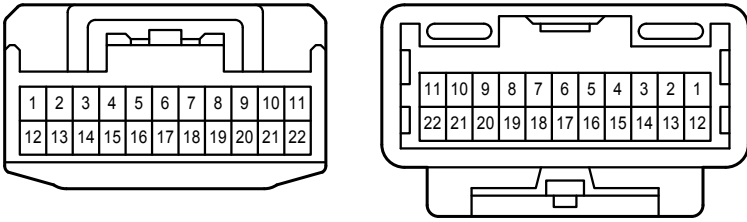

AJ7
Gray

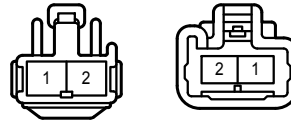

AJ10
Gray

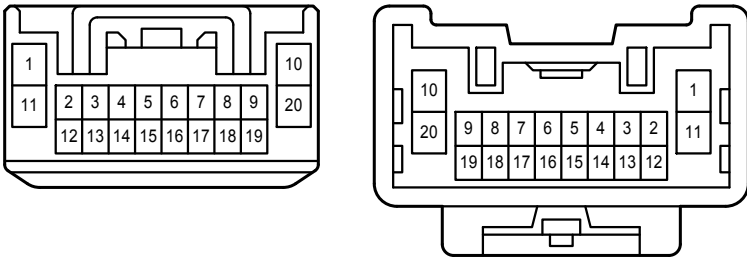

DA3
White

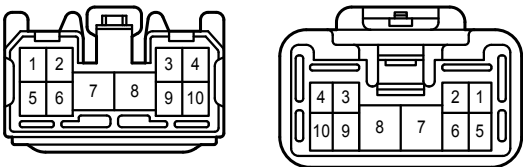

JK1
White

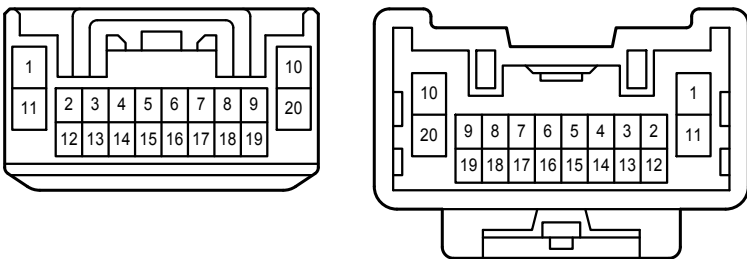

JK2
White

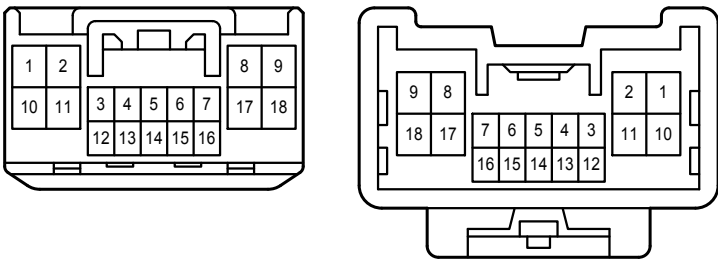

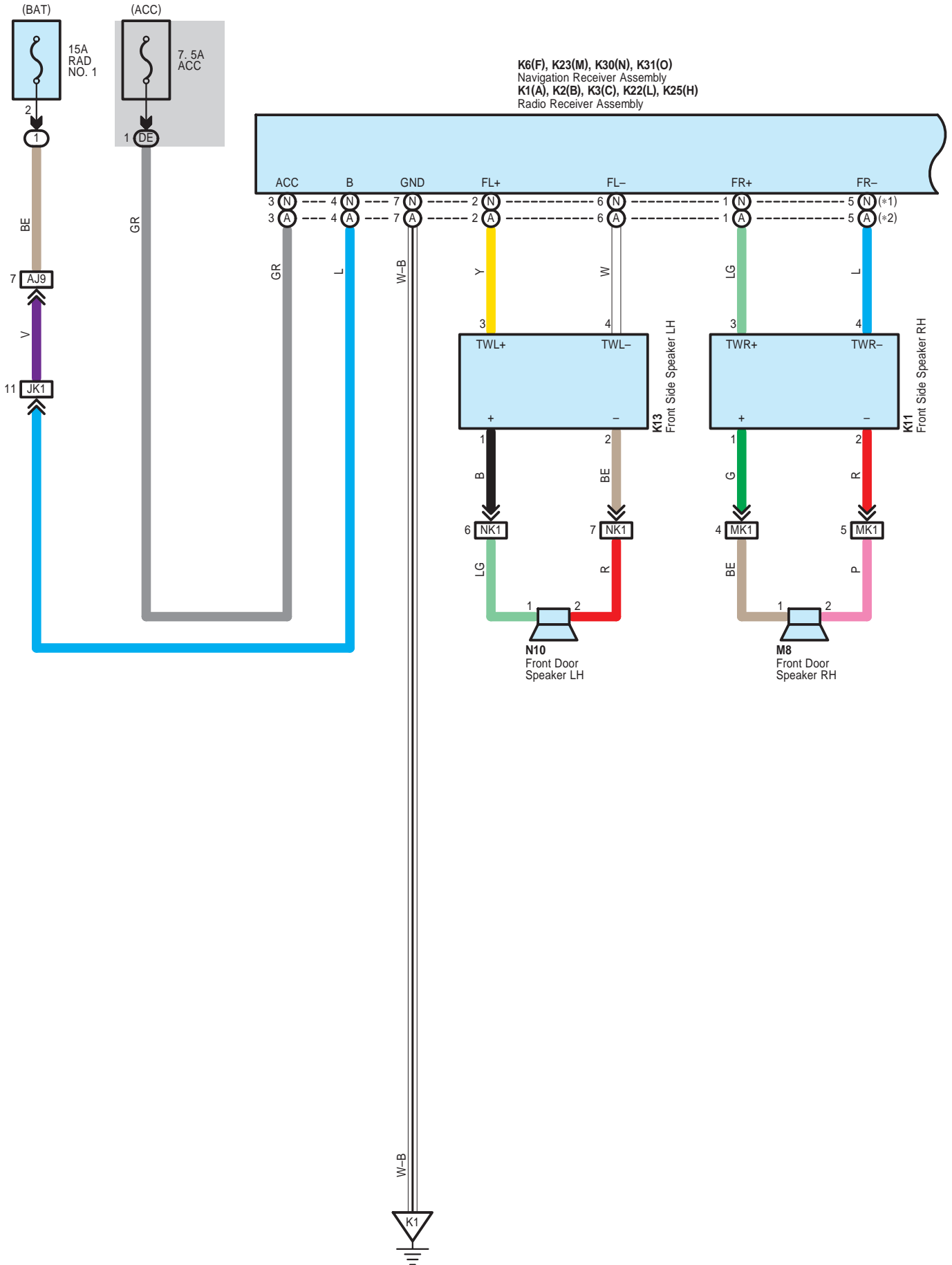

K6(F), K23(M), K30(N), K31(O)
 Navigation Receiver Assembly
 K1(A), K2(B), K3(C), K22(L), K25(H)
 Radio Receiver Assembly

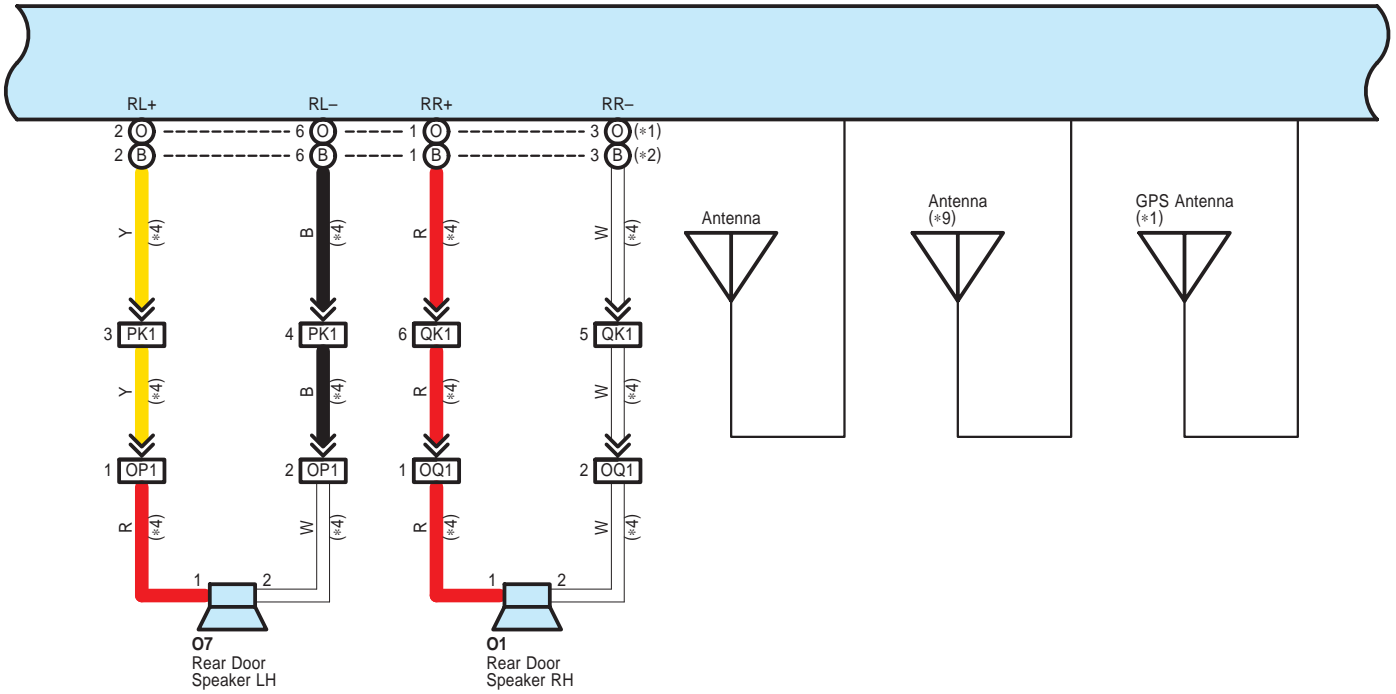

- * 1 : w/ Navigation System
- * 2 : w/o Navigation System
- * 4 : w/ Rear Door Speaker
- * 9 : w/ SDARS Antenna

K6(F), K23(M), K30(N), K31(O)
 Navigation Receiver Assembly
 K1(A), K2(B), K3(C), K22(L), K25(H)
 Radio Receiver Assembly

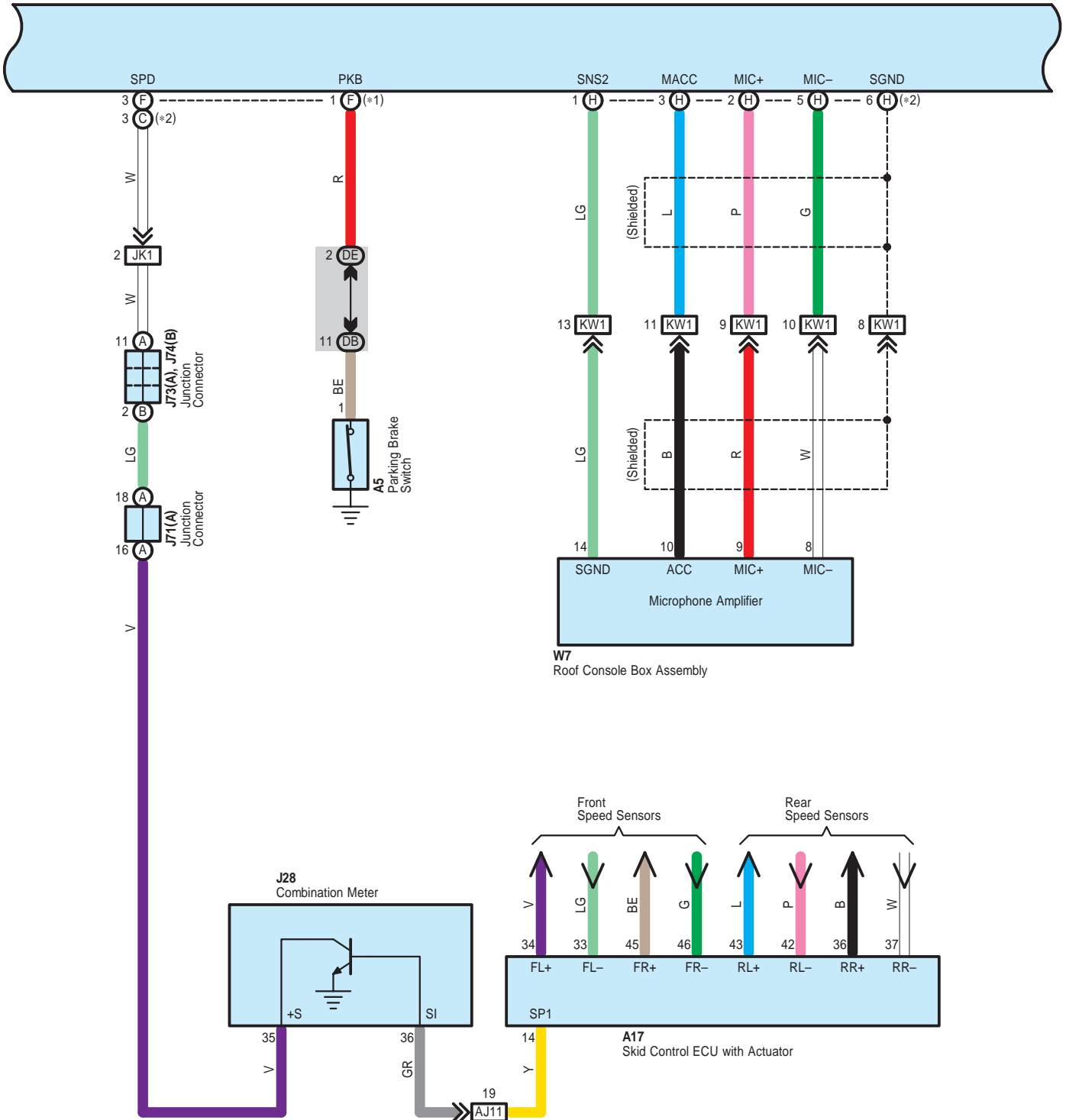

- * 1 : w/ Navigation System
- * 2 : w/o Navigation System
- * 3 : w/ Rear View Monitor

K6(F), K23(M), K30(N), K31(O)
 Navigation Receiver Assembly
 K1(A), K2(B), K3(C), K22(L), K25(H)
 Radio Receiver Assembly

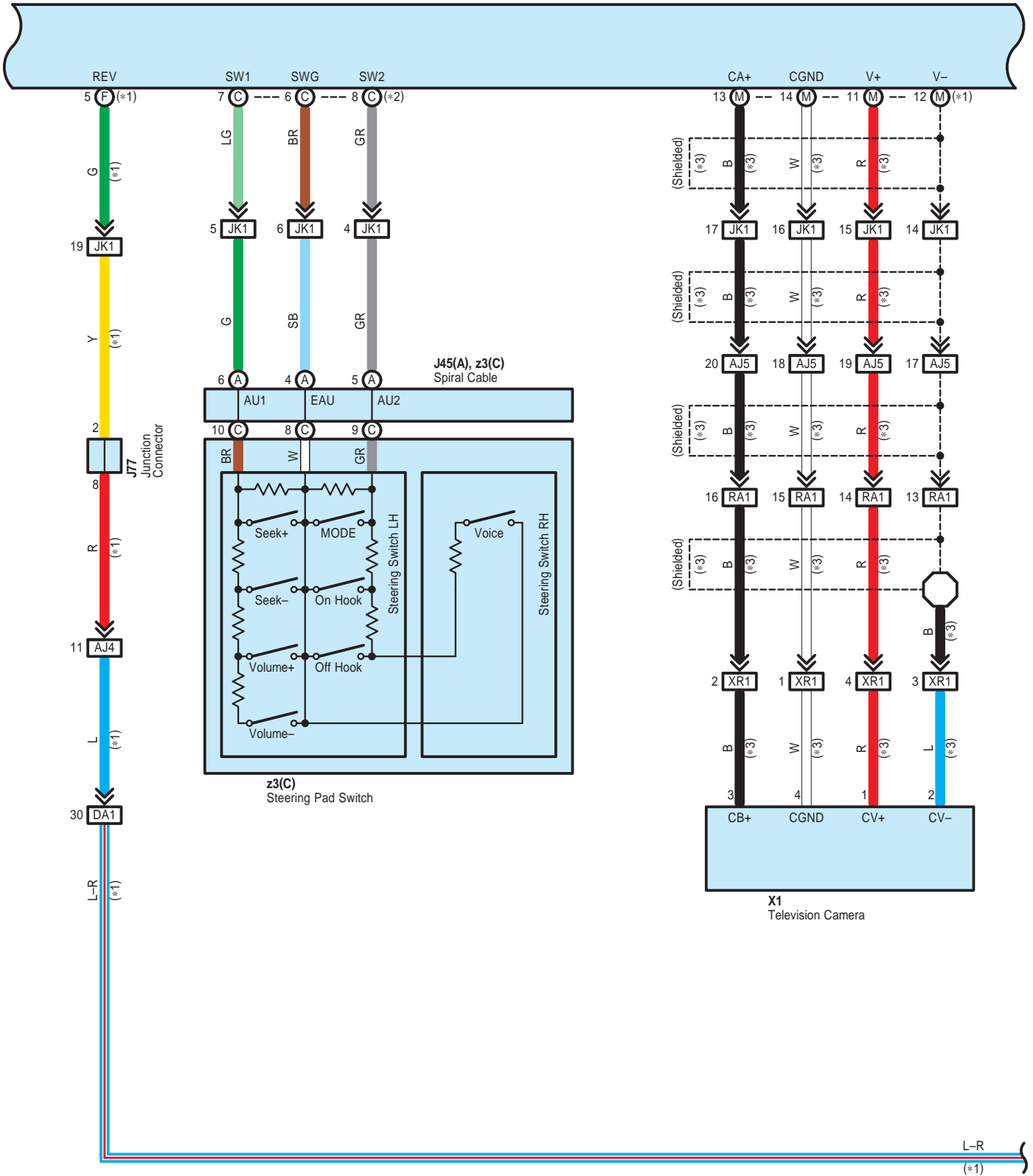

K6(F), K23(M), K30(N), K31(O)
 Navigation Receiver Assembly
 K1(A), K2(B), K3(C), K22(L), K25(H)
 Radio Receiver Assembly

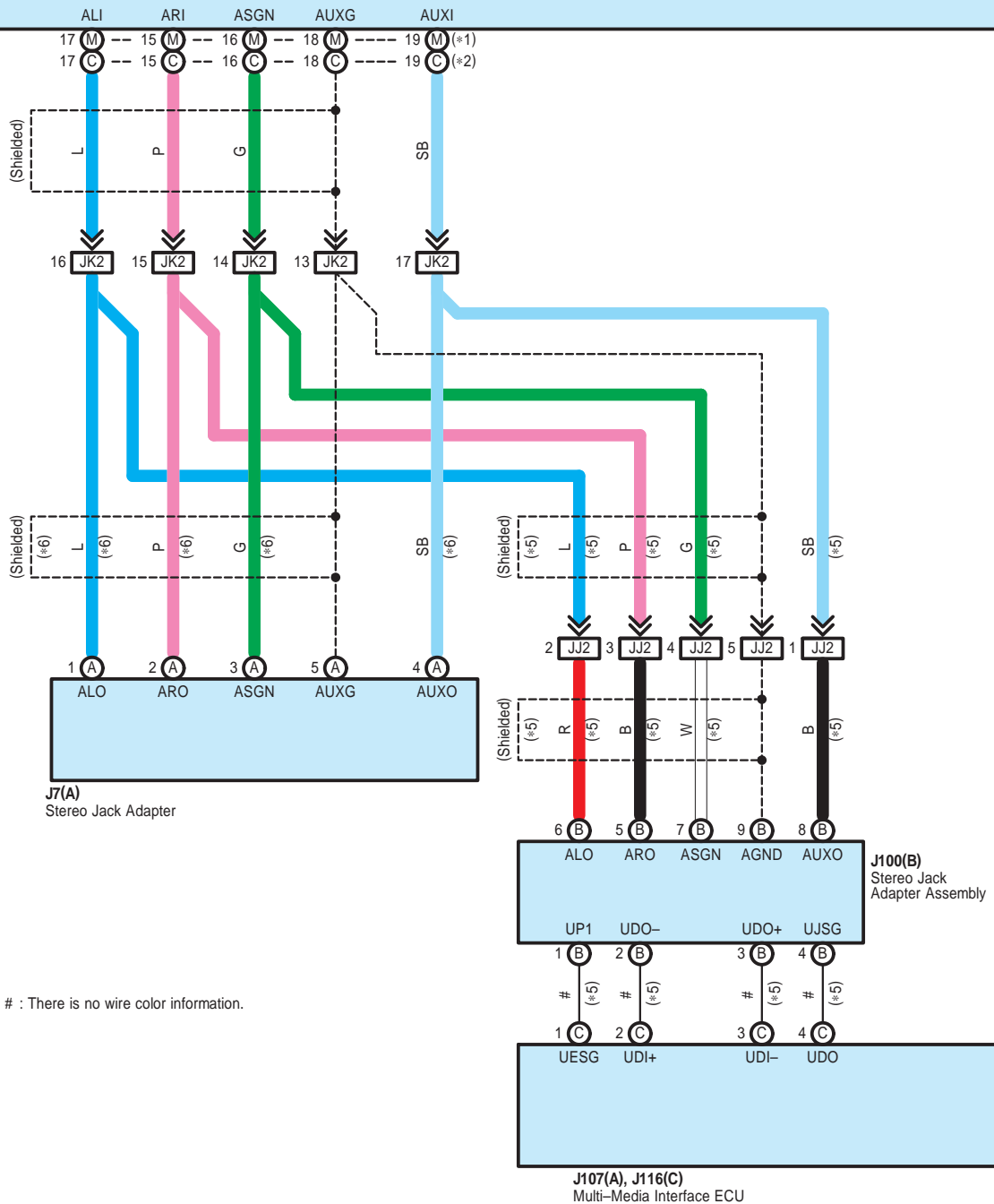

: There is no wire color information.



K6(F), K23(M), K30(N), K31(O)
 Navigation Receiver Assembly
 K1(A), K2(B), K3(C), K22(L), K25(H)
 Radio Receiver Assembly

- * 1 : w/ Navigation System
- * 2 : w/o Navigation System
- * 5 : w/ Multi-Media Interface ECU
- * 6 : w/o Multi-Media Interface ECU

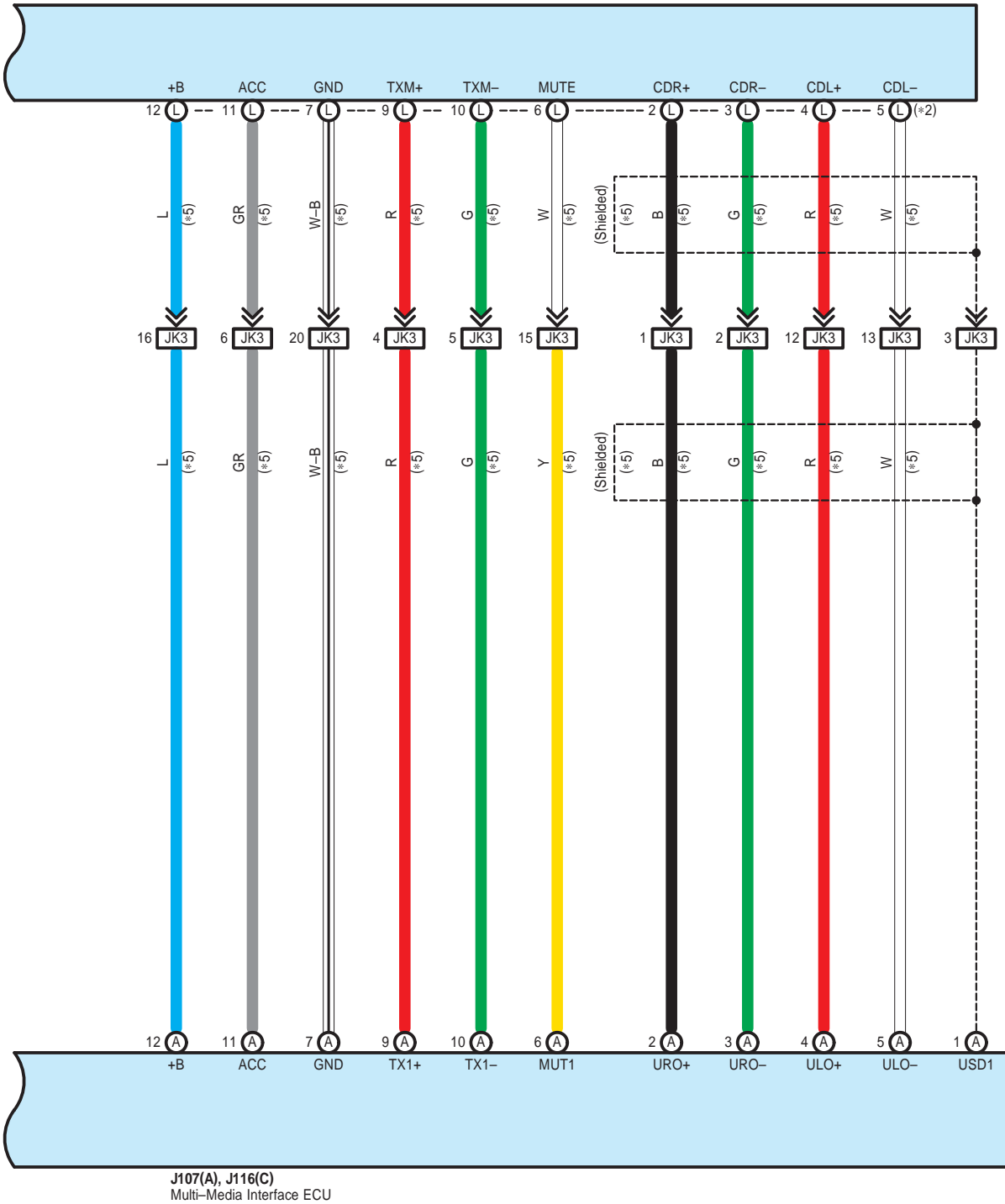

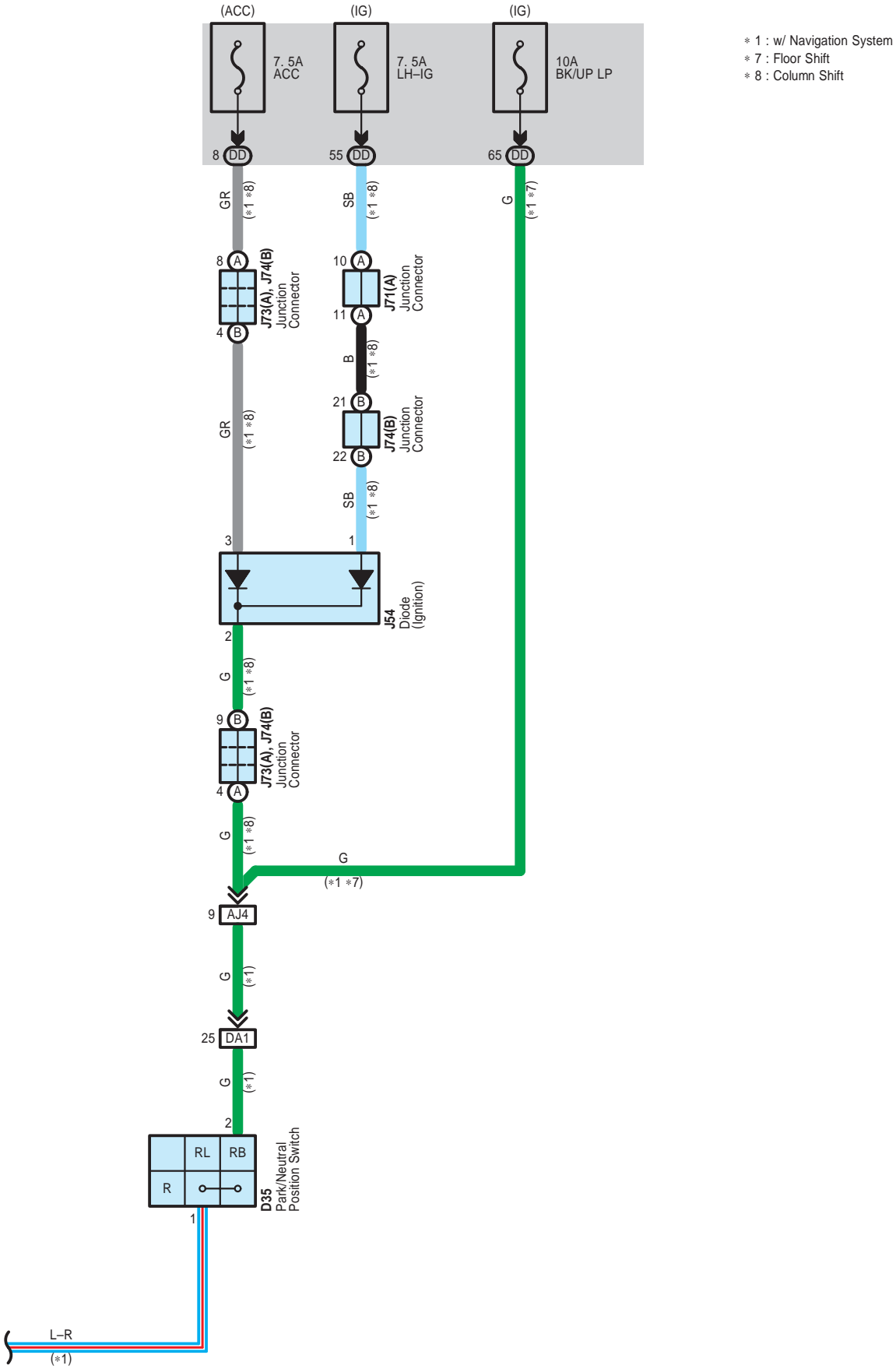

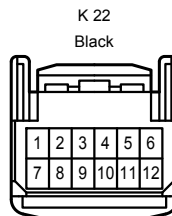
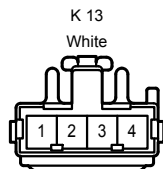
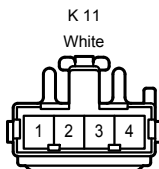
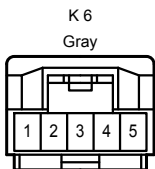
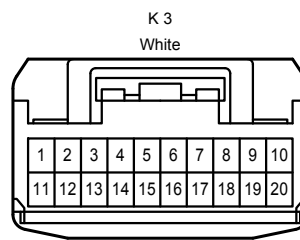
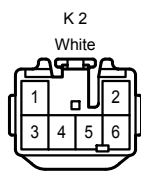
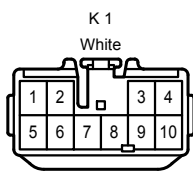
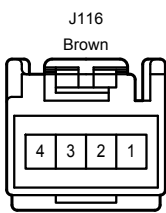
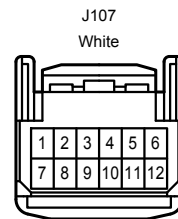
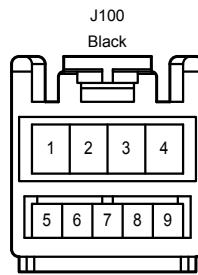
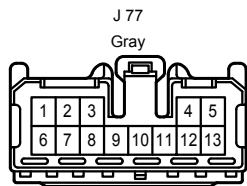
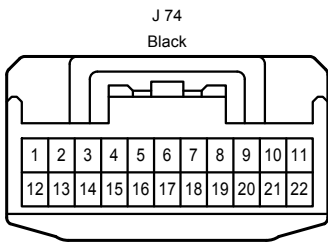
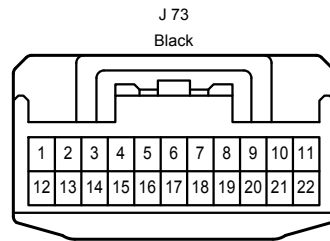
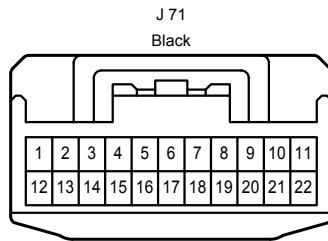
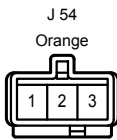
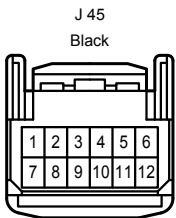
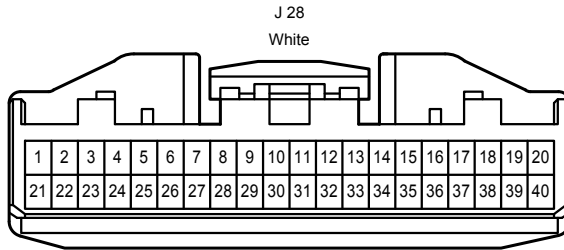
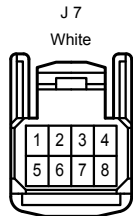
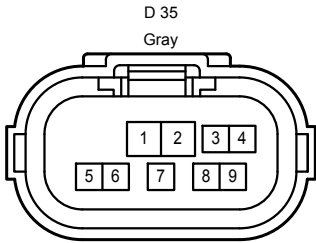
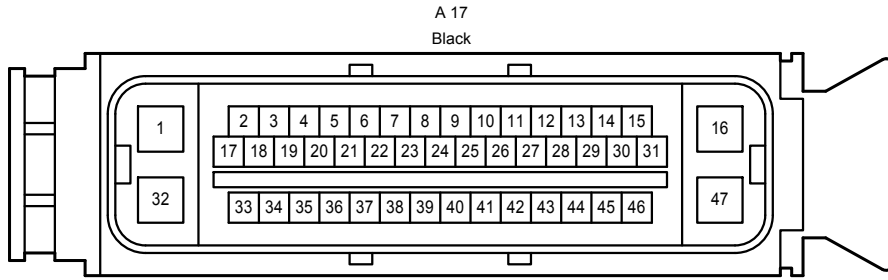

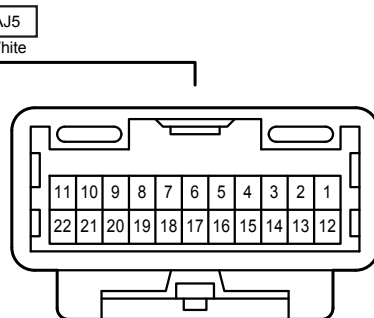
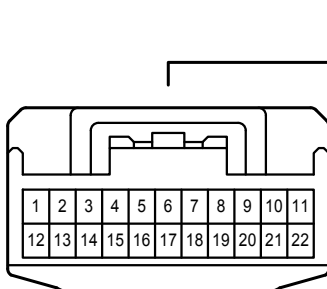
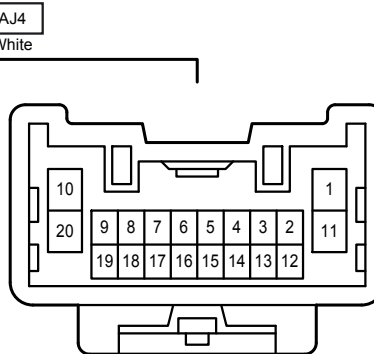
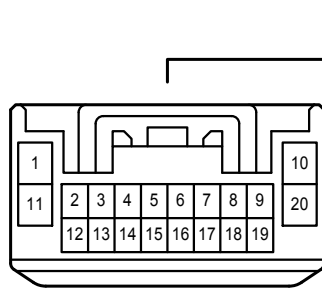
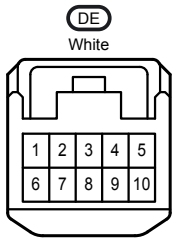
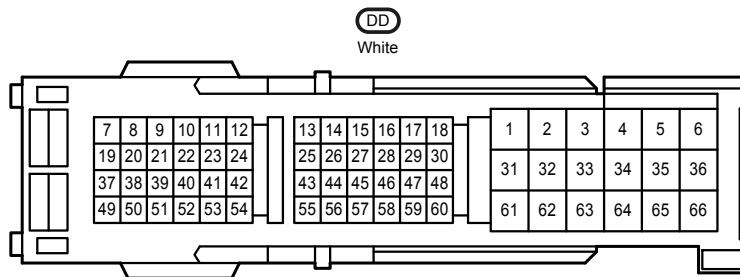
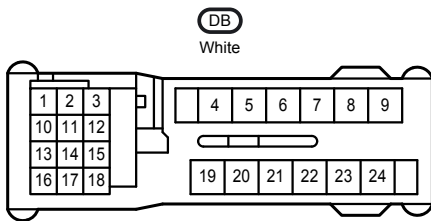
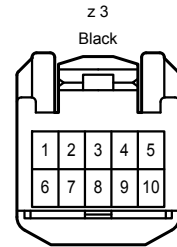
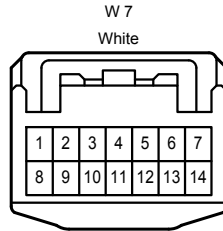
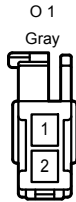
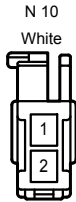
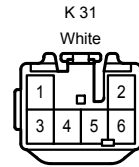
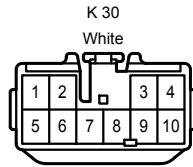
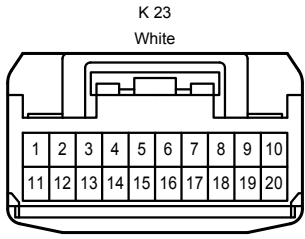

AJ9
Gray

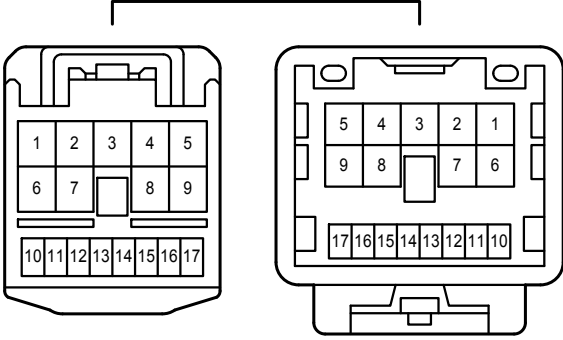

AJ11
Gray

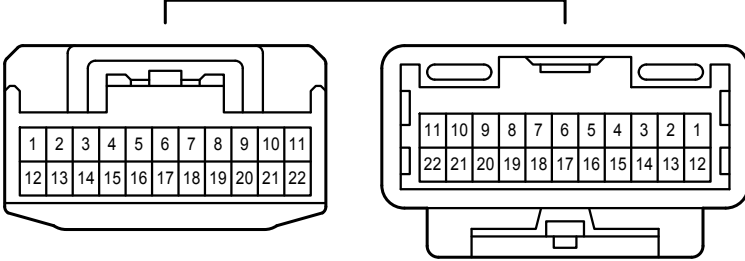

DA1
White

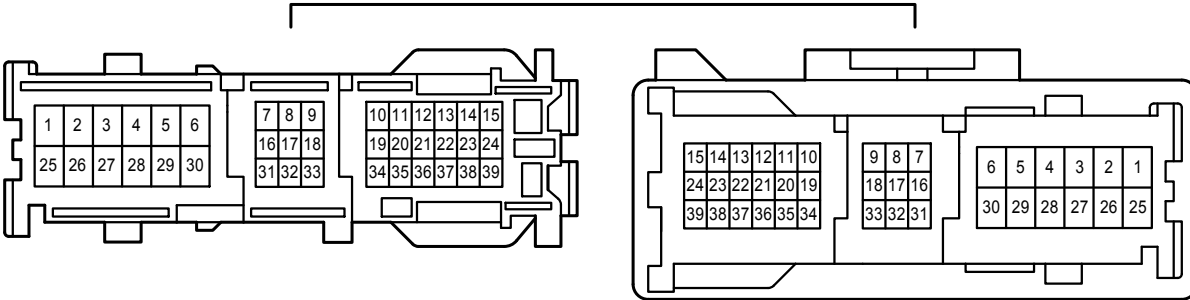

JJ2
White

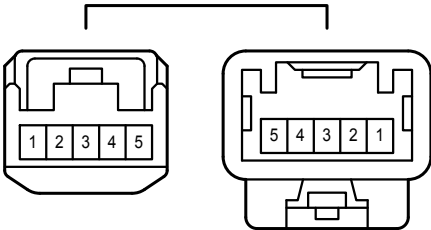

JK1
White

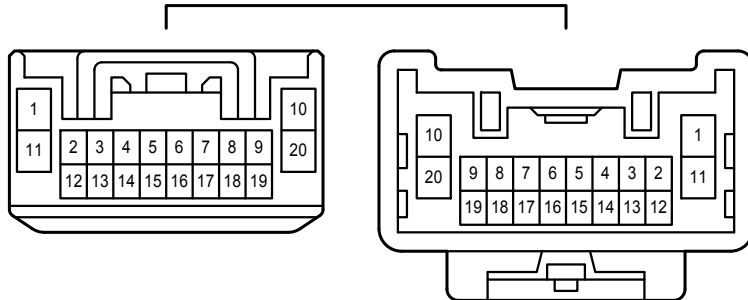

JK2
White

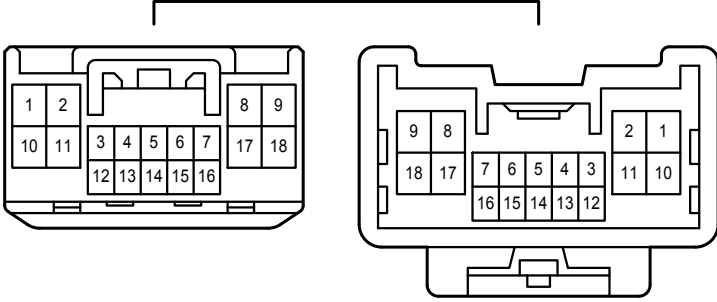

JK3
White

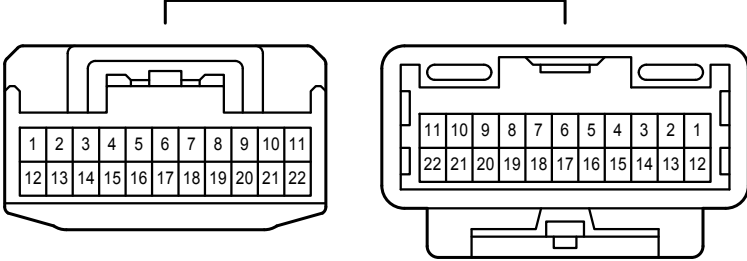

KW1
White

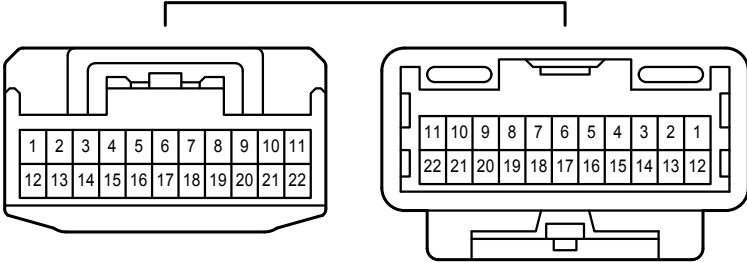

MK1
Blue

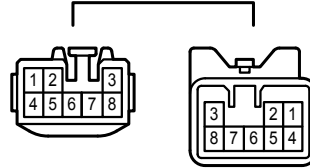

NK1
Blue

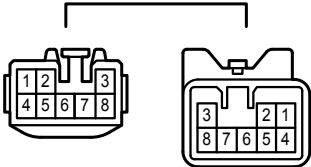

OP1
White

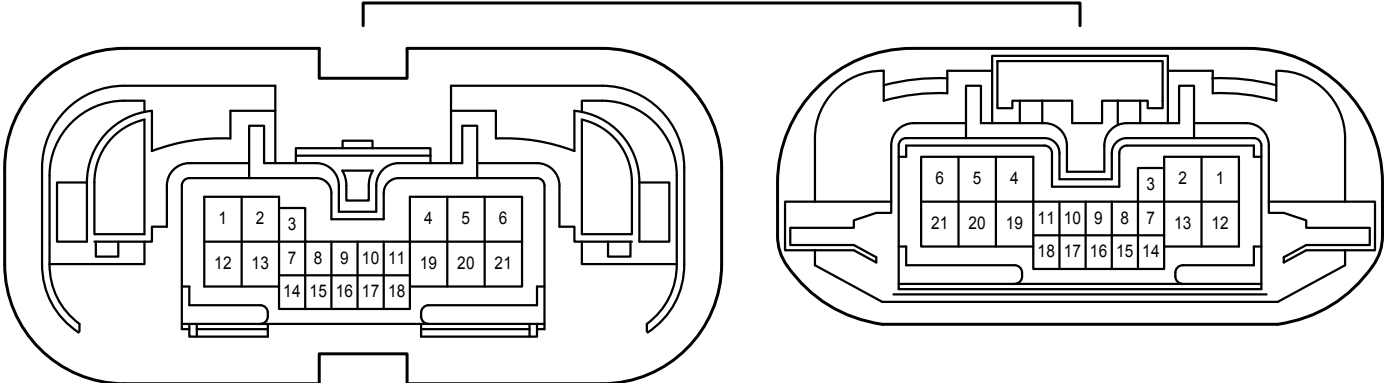

QO1
White

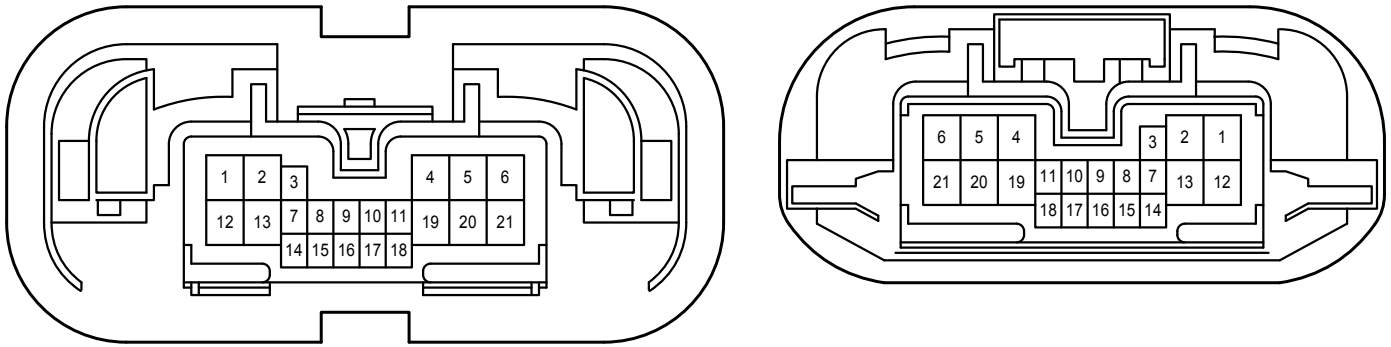

PK1
Gray

QK1
Black

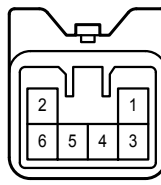
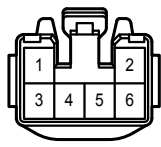
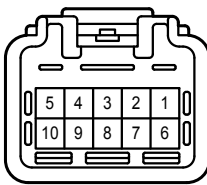

RA1
White

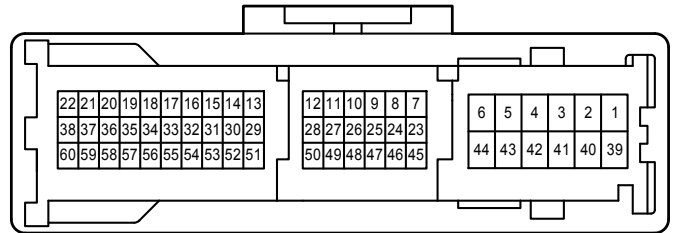
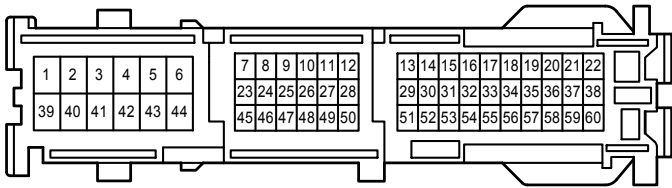

XR1
White

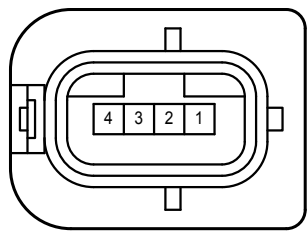
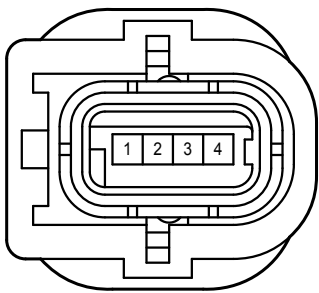

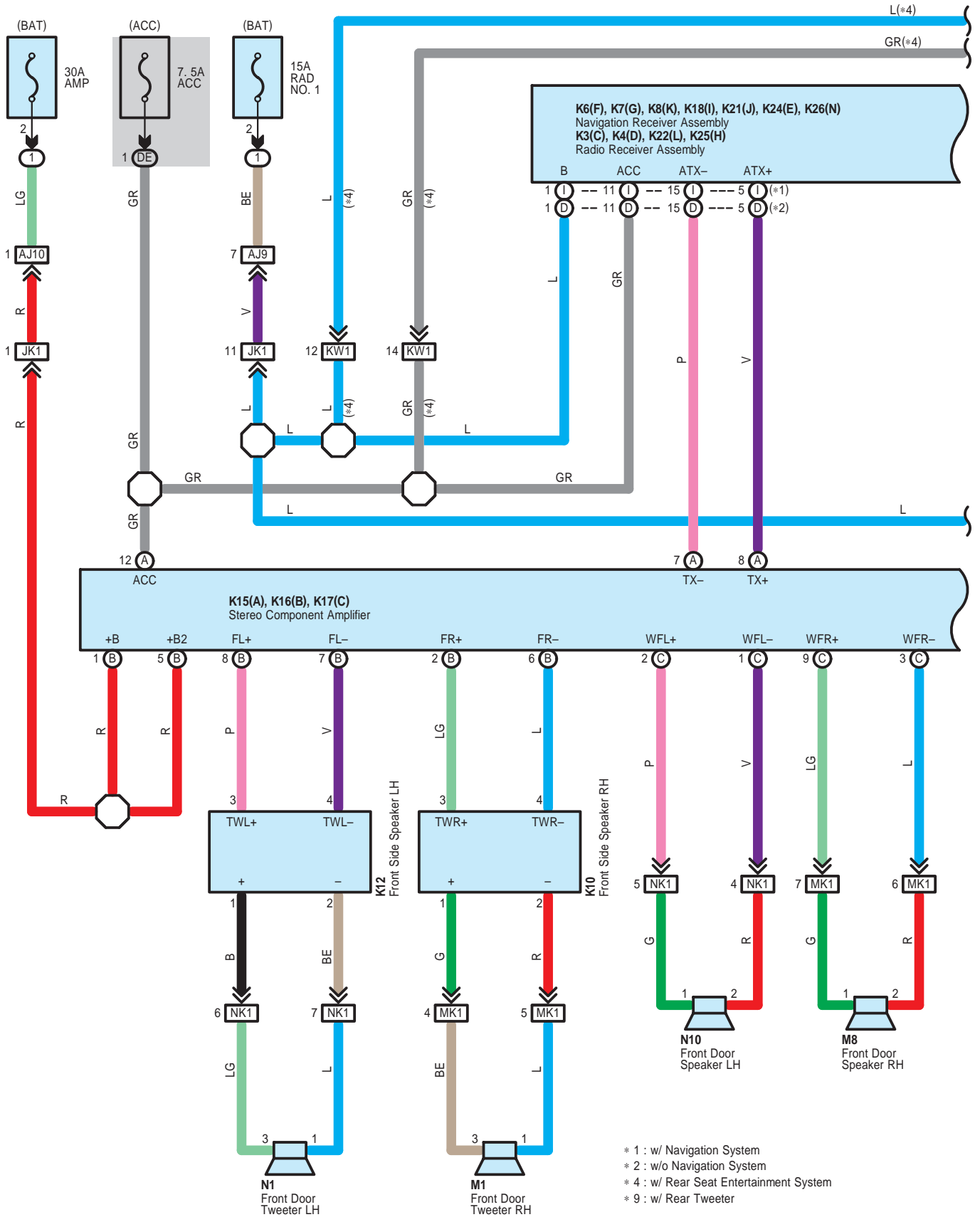

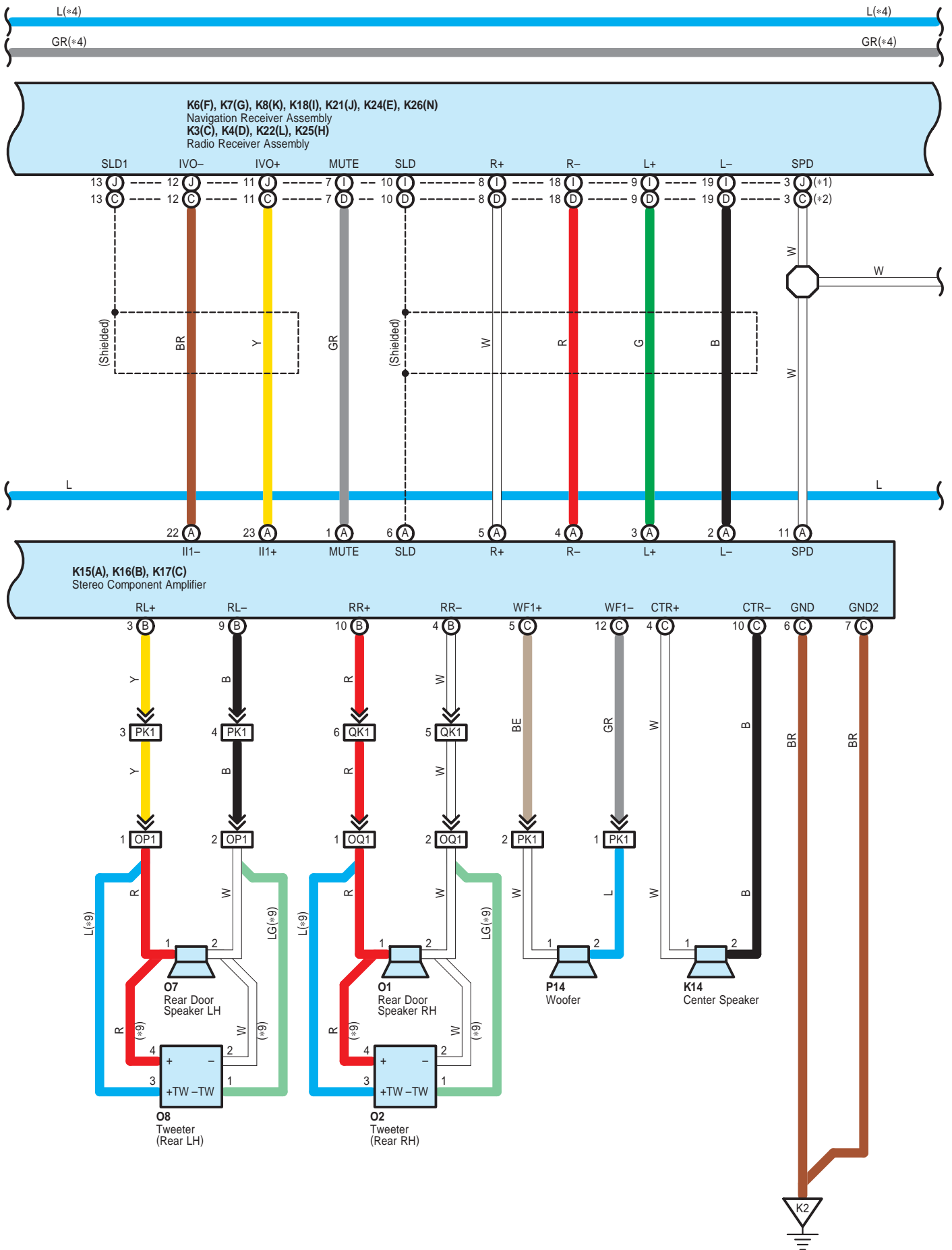

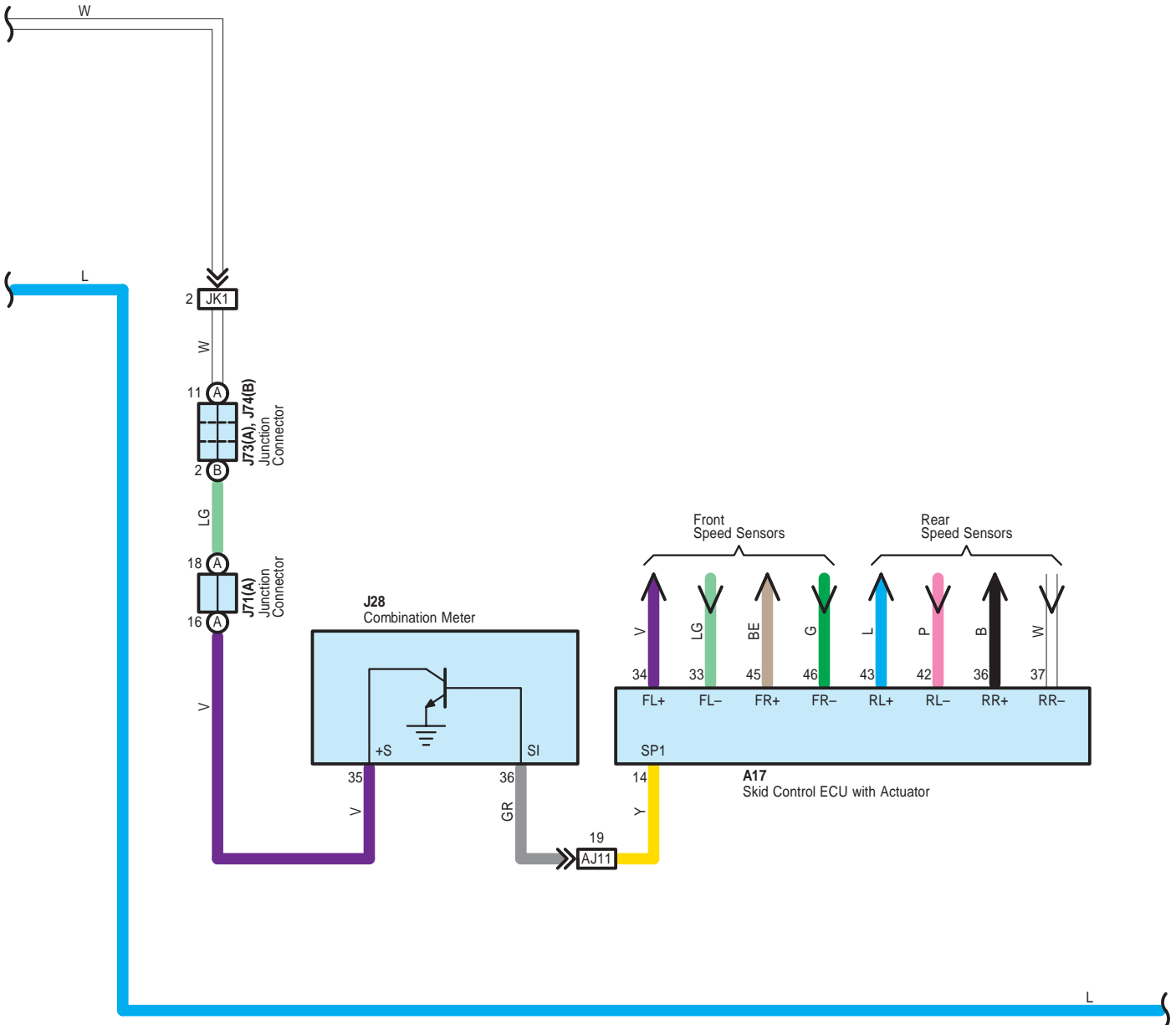
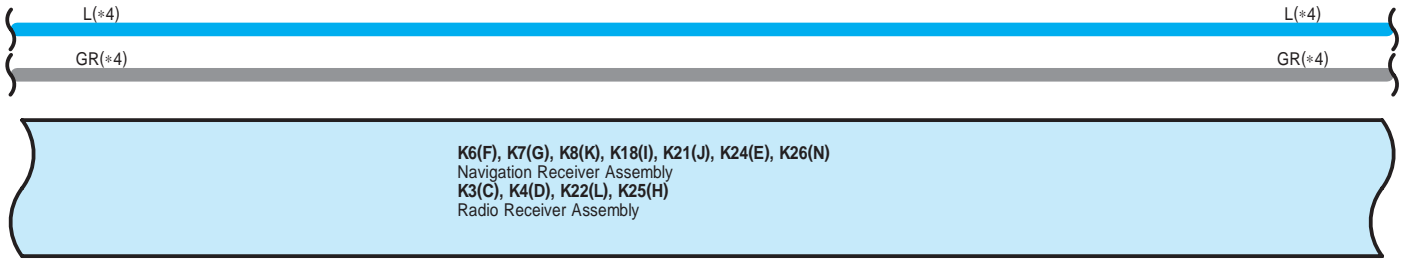

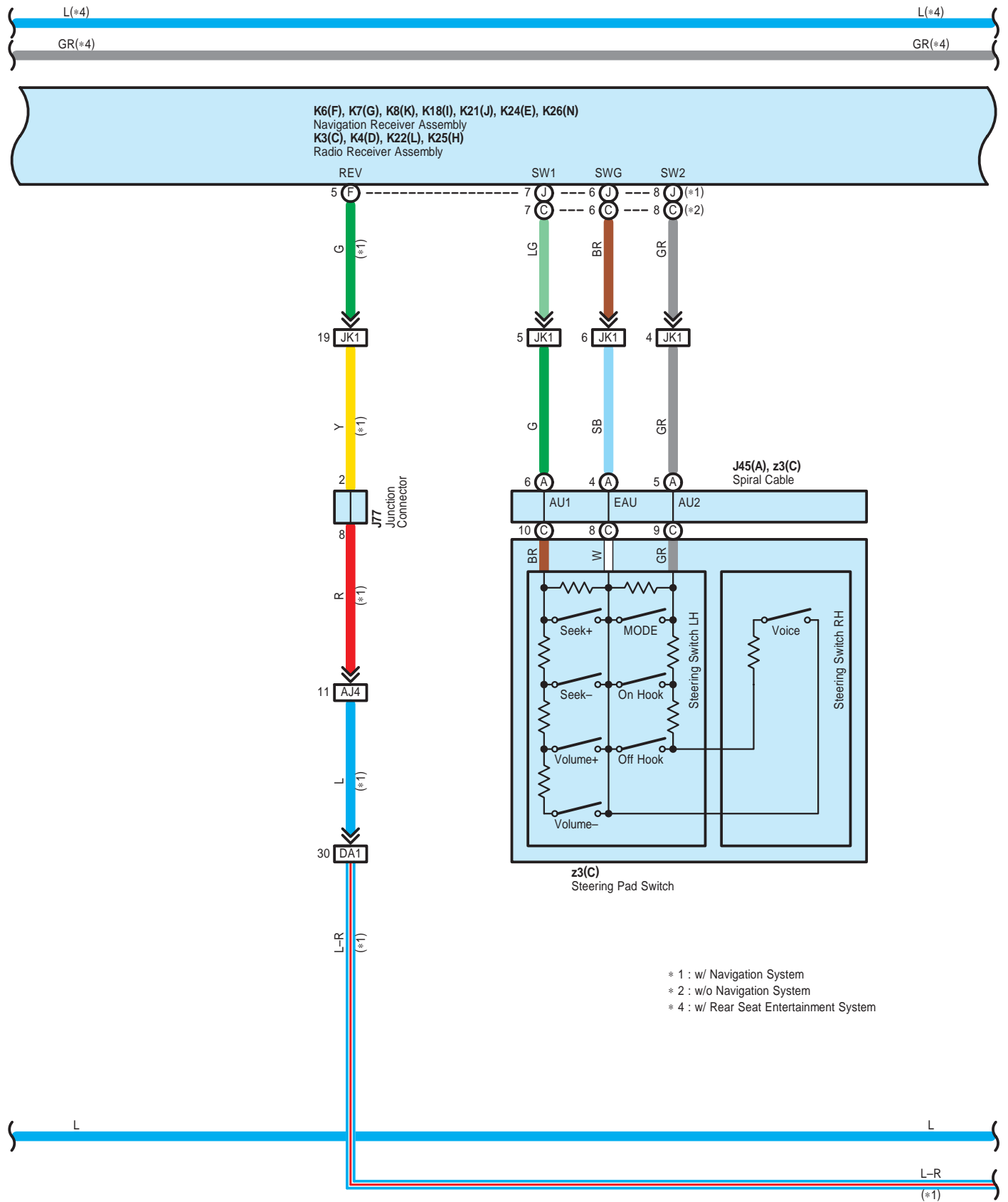

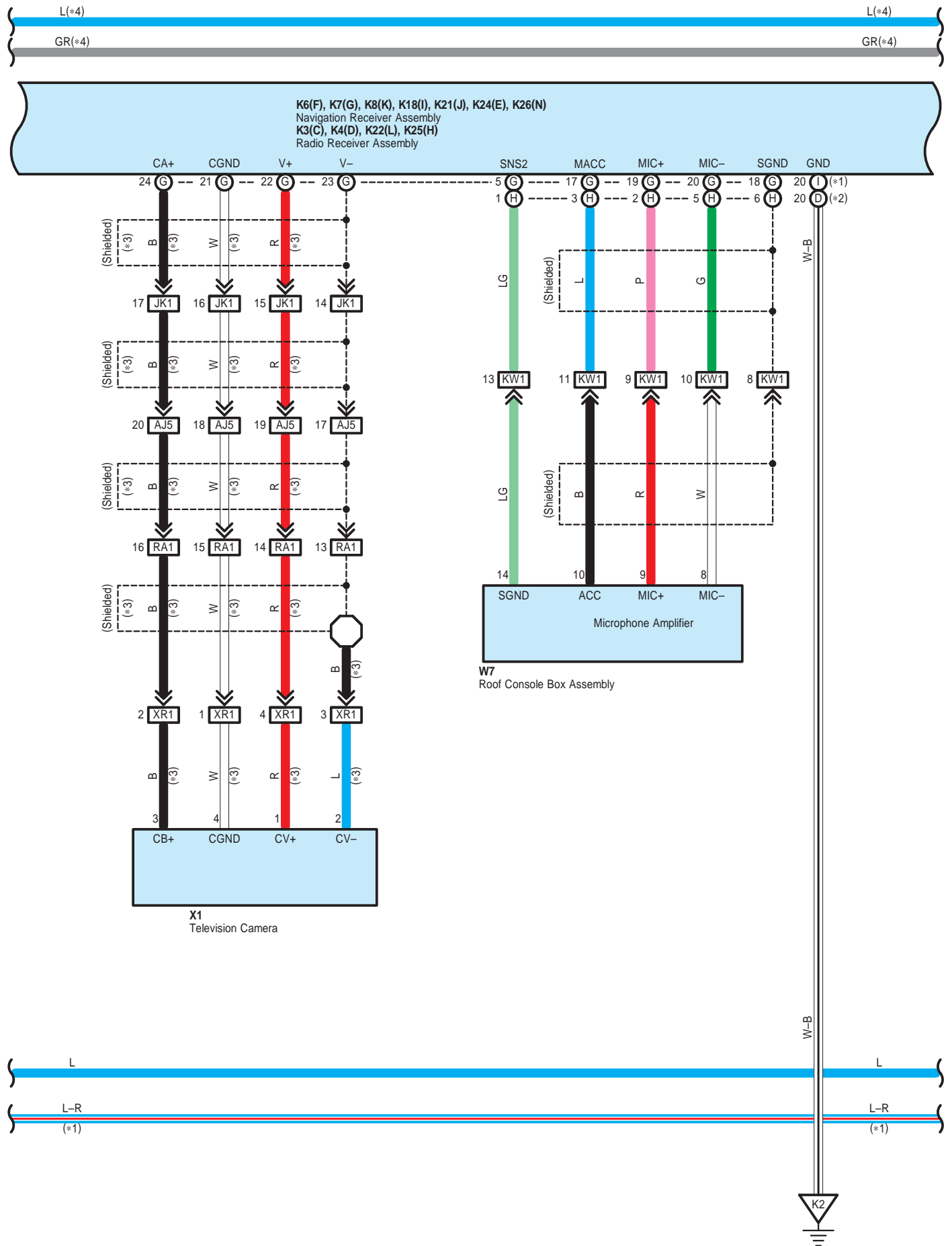

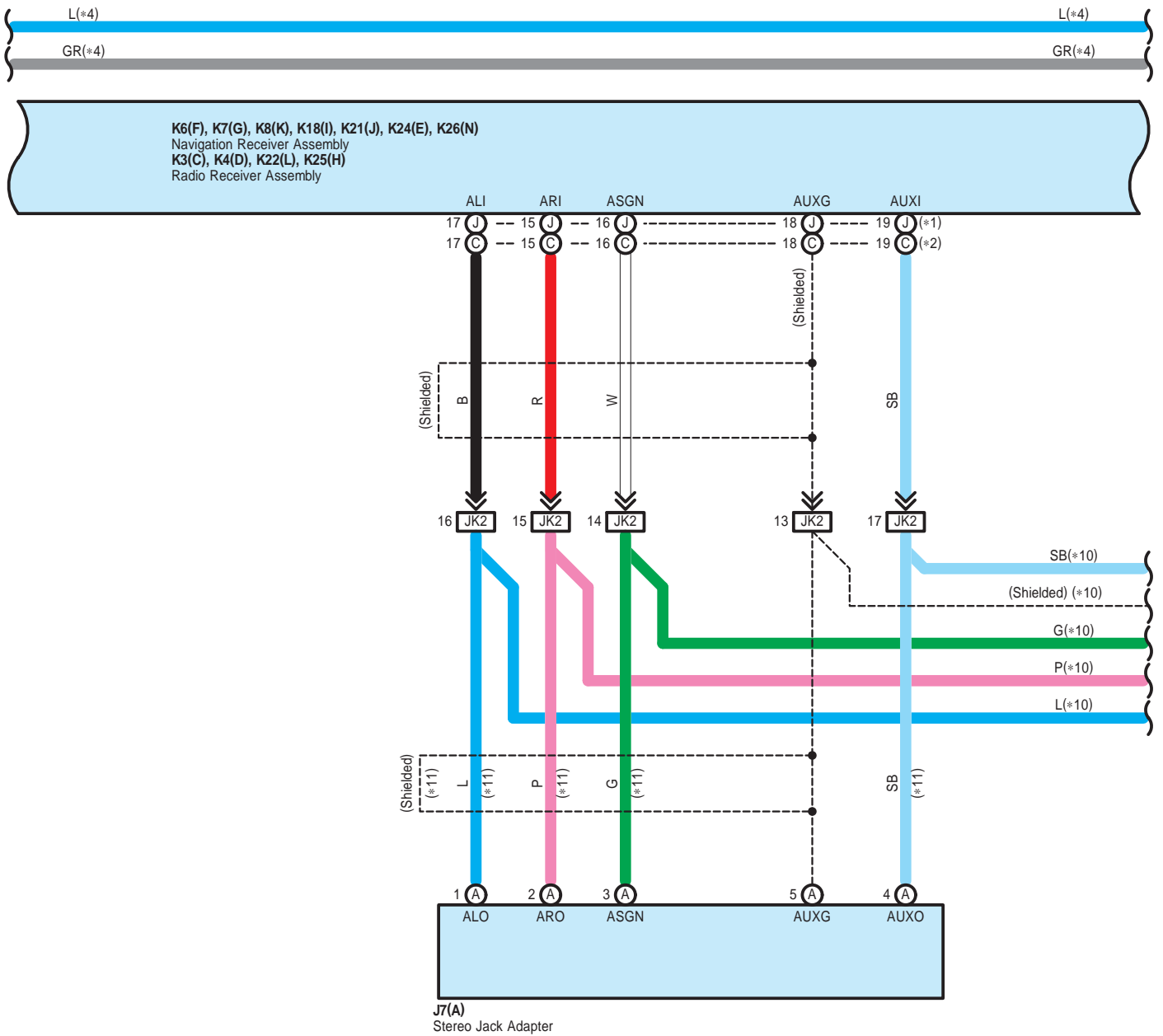

- * 1 : w/ Navigation System
- * 2 : w/o Navigation System
- * 3 : w/ Rear View Monitor
- * 4 : w/ Rear Seat Entertainment System
- *10 : w/ Multi-Media Interface ECU
- *11 : w/o Multi-Media Interface ECU



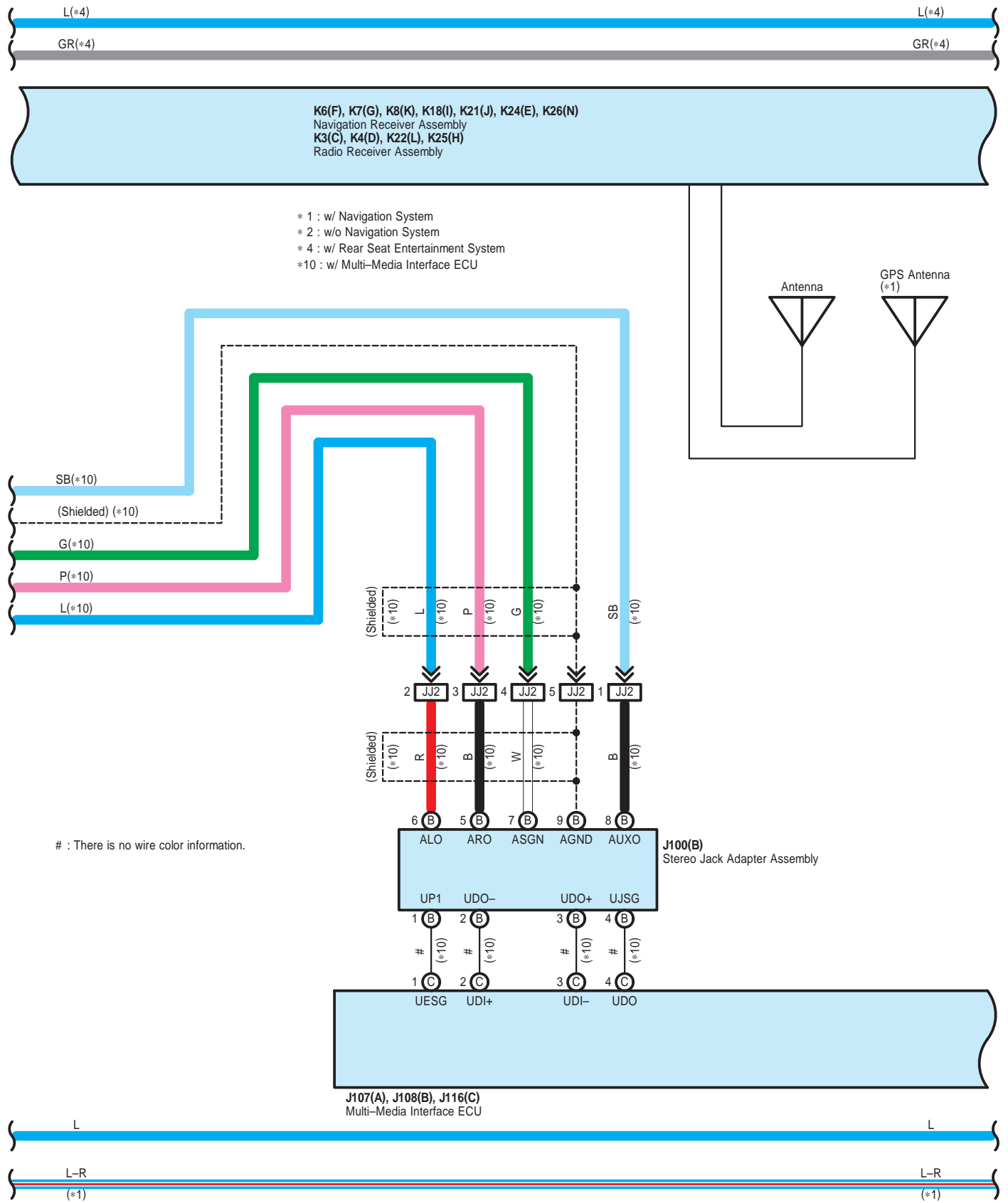

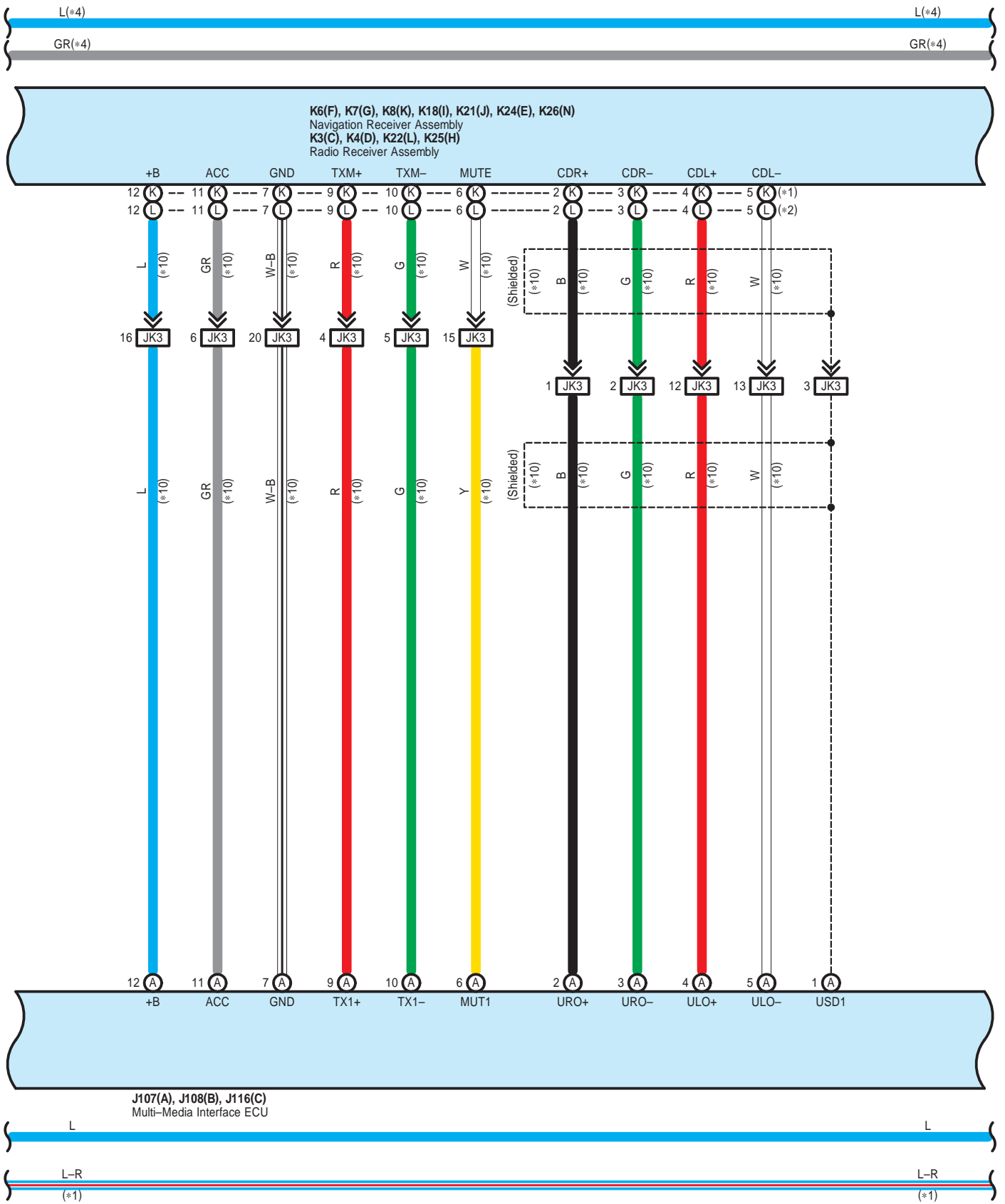

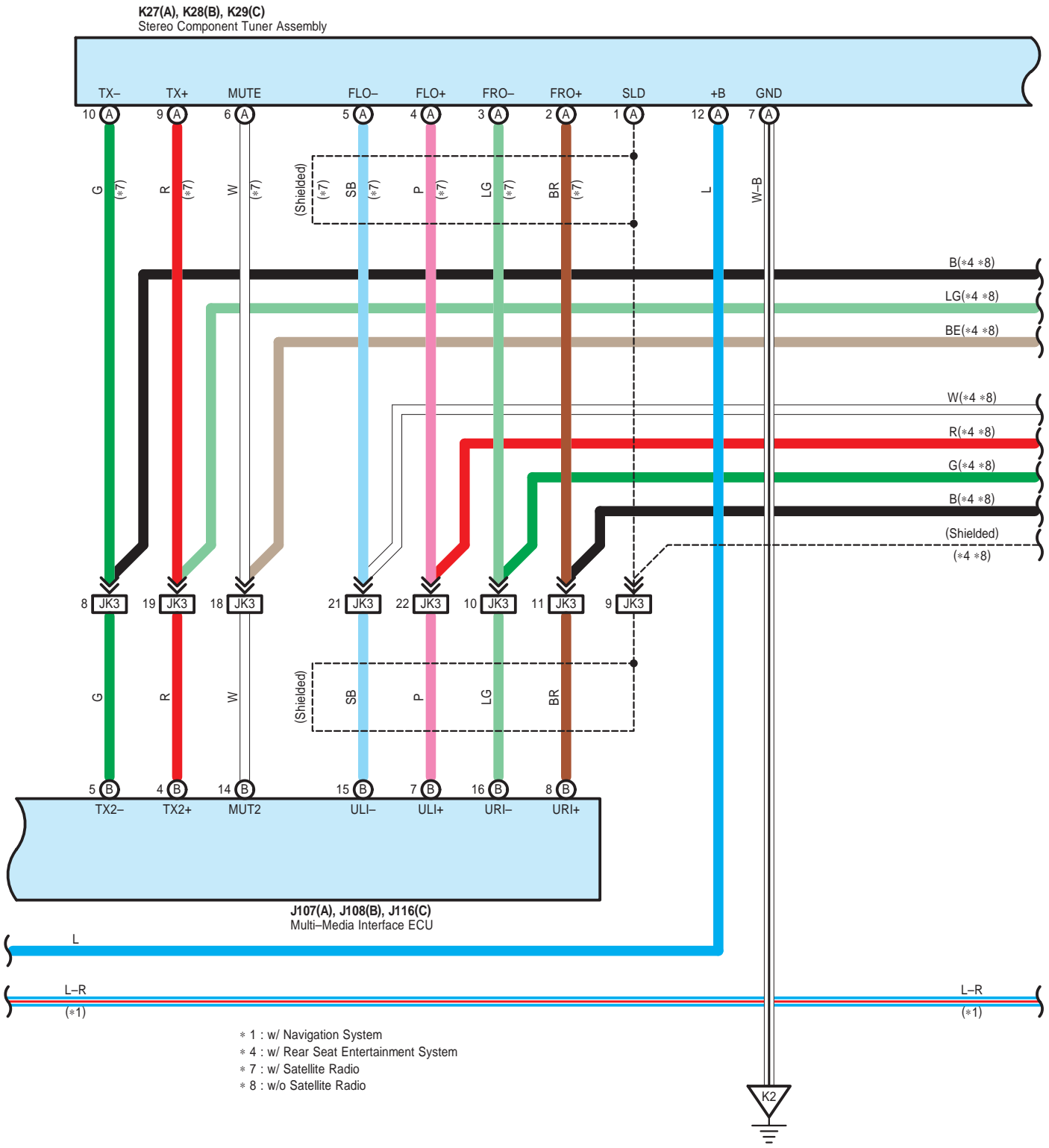
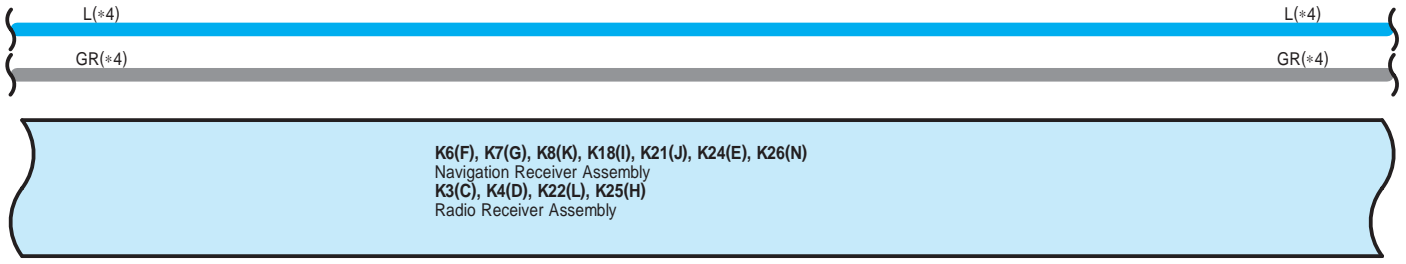



K6(F), K7(G), K8(K), K18(I), K21(J), K24(E), K26(N)
 Navigation Receiver Assembly
 K3(C), K4(D), K22(L), K25(H)
 Radio Receiver Assembly

K27(A), K28(B), K29(C)
 Stereo Component Tuner Assembly

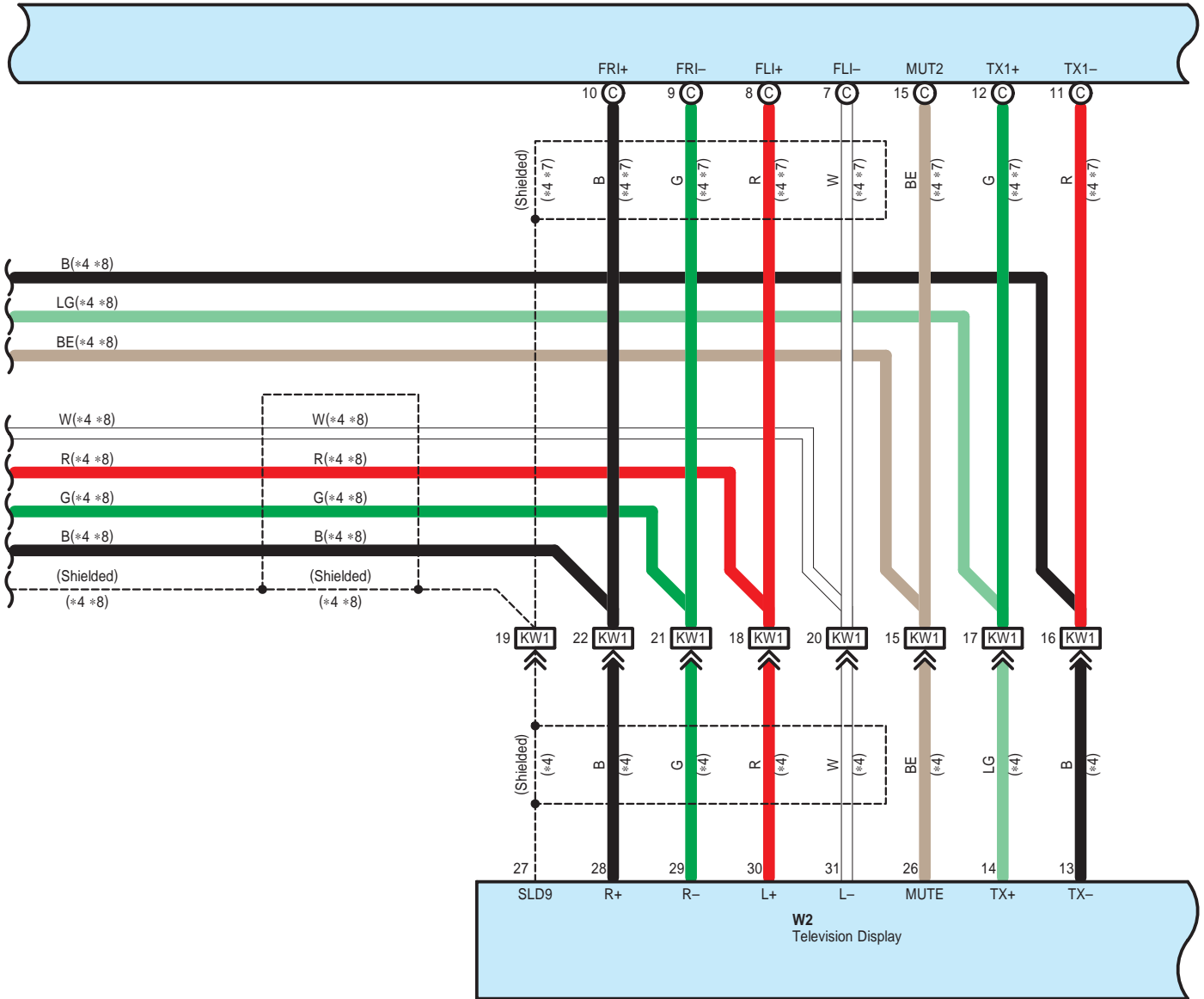

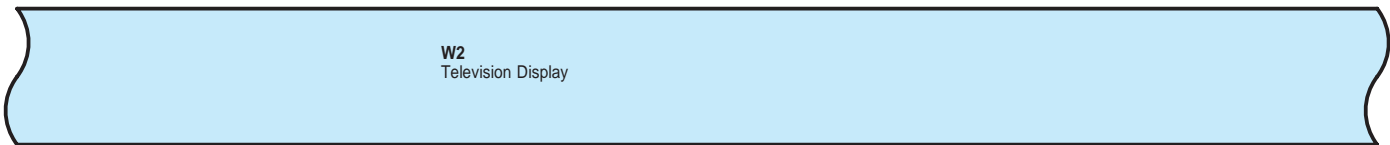
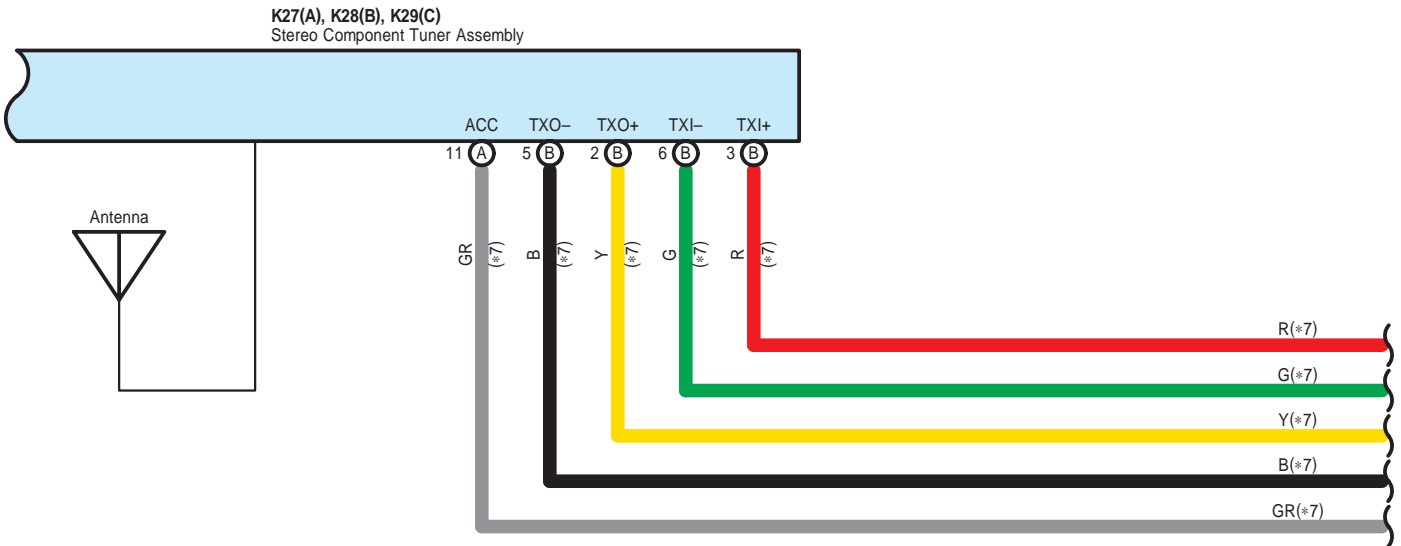
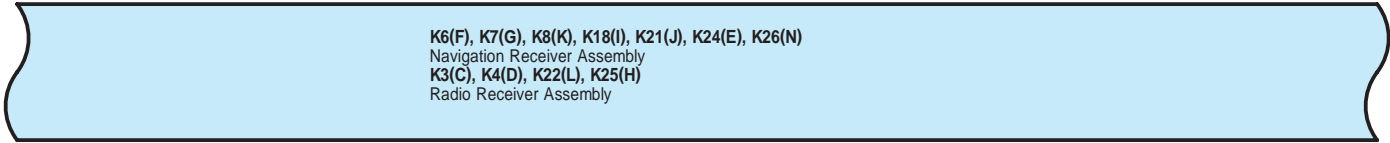

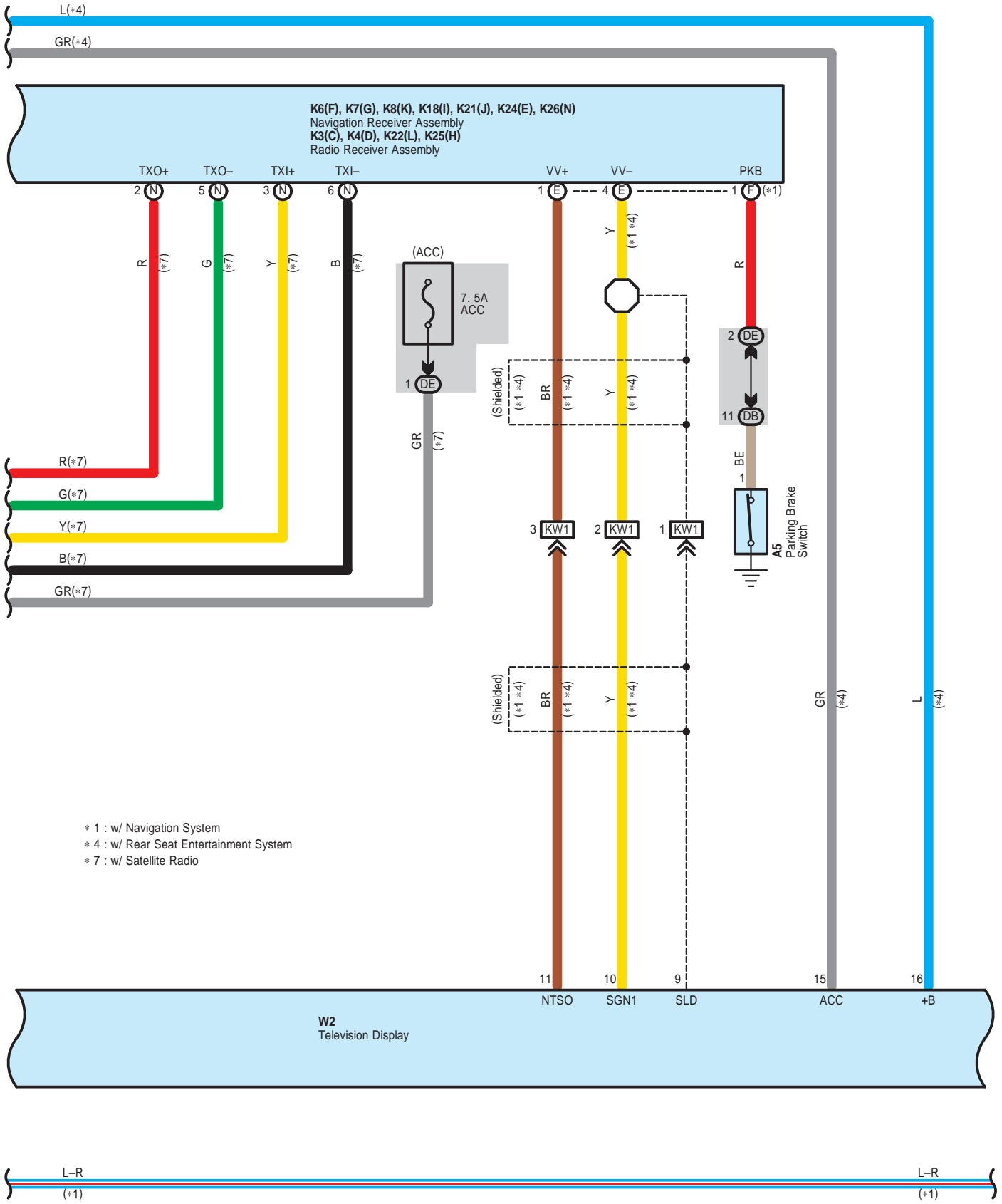

T4
Video Terminal

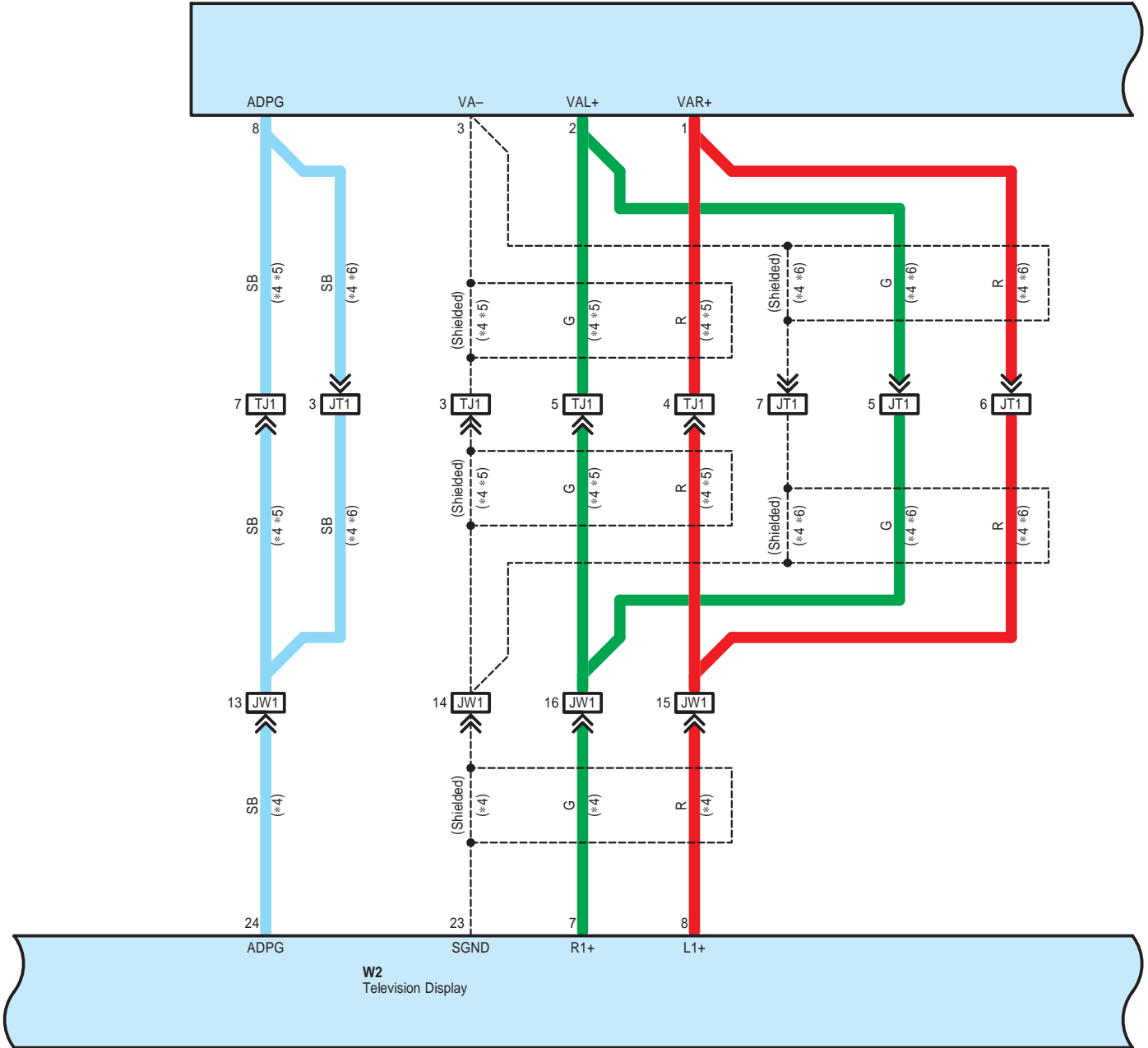

- * 1 : w/ Navigation System
- * 4 : w/ Rear Seat Entertainment System
- * 5 : Floor Shift
- * 6 : Column Shift

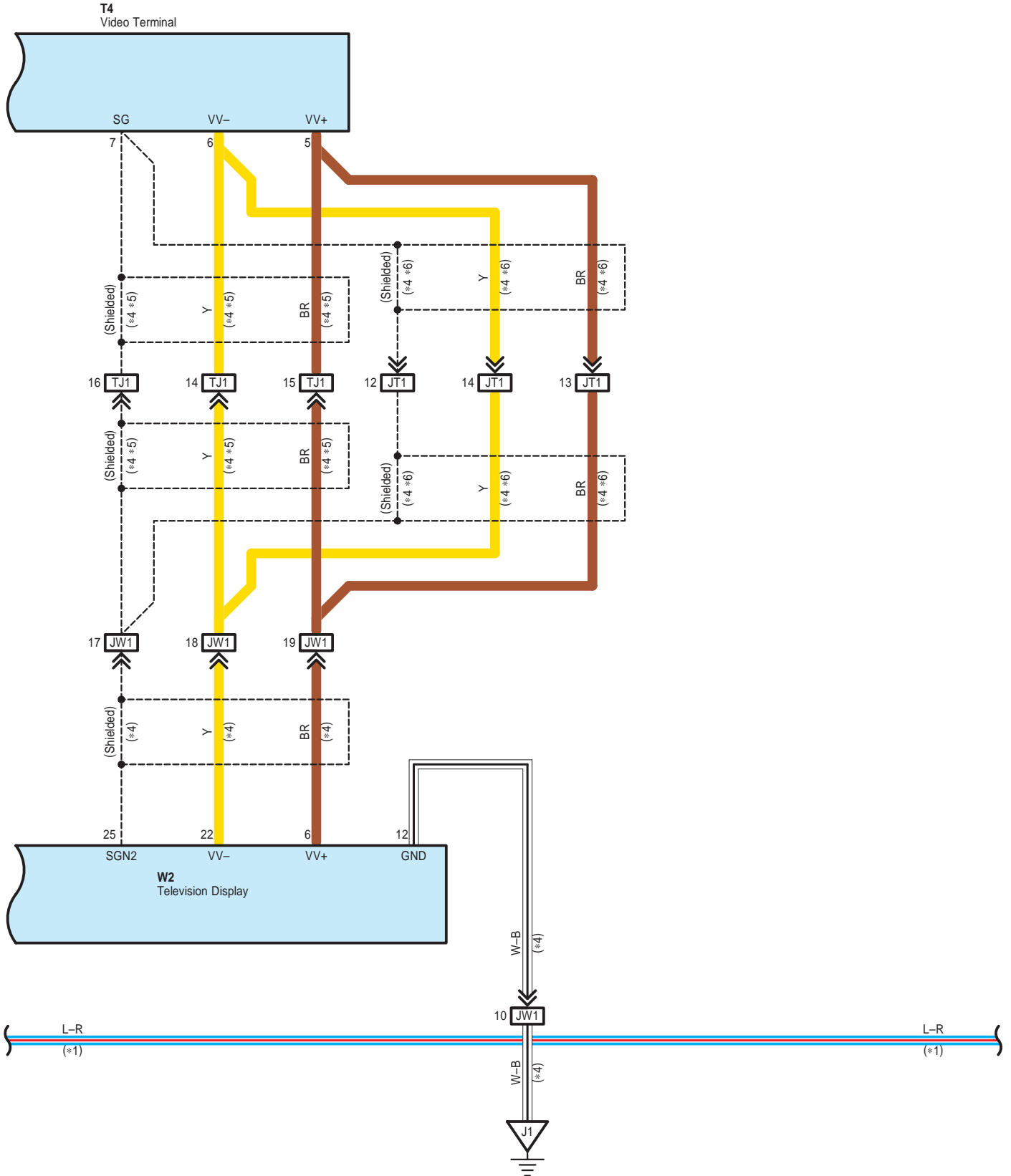

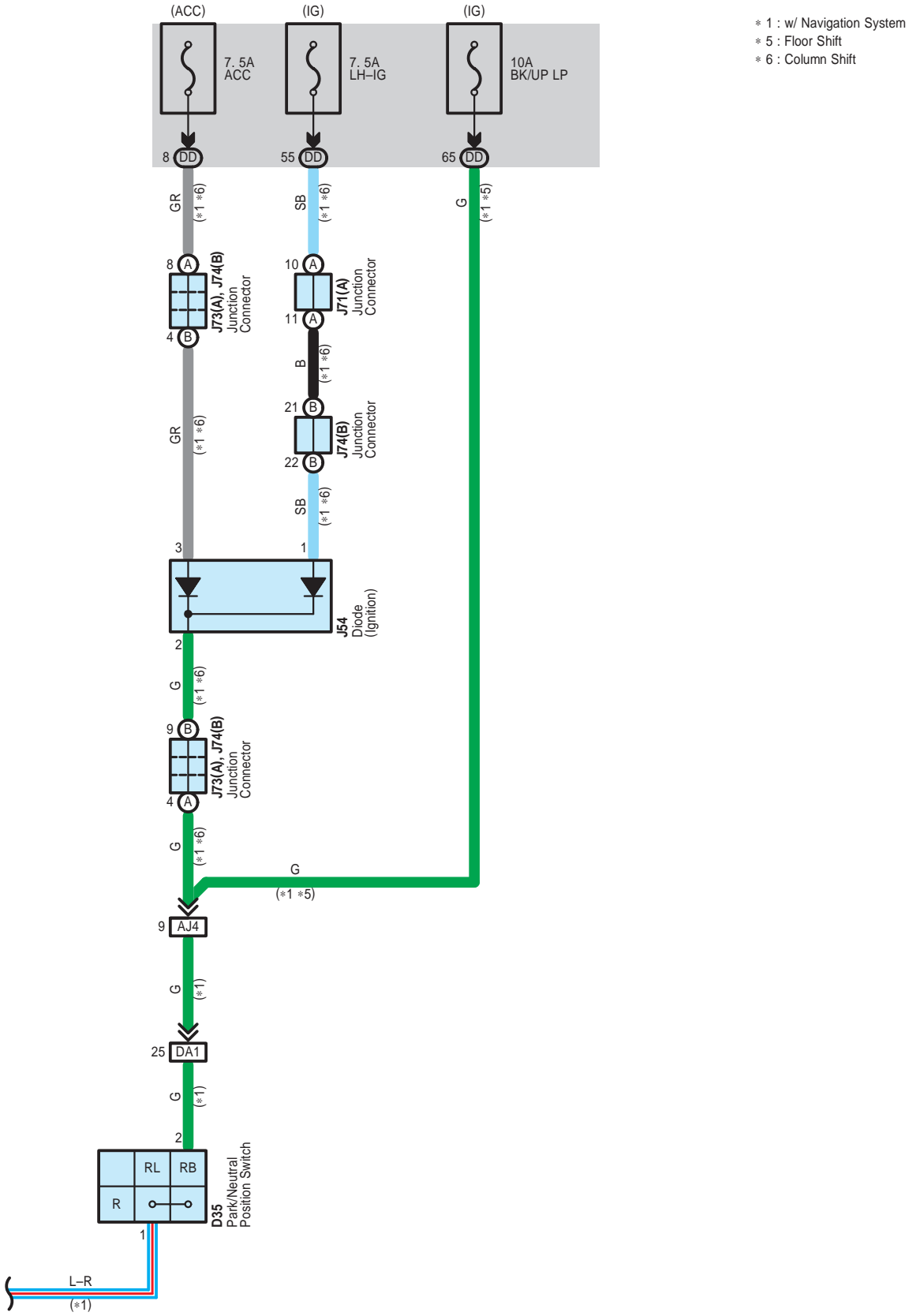

A 5
White



A 17
Black

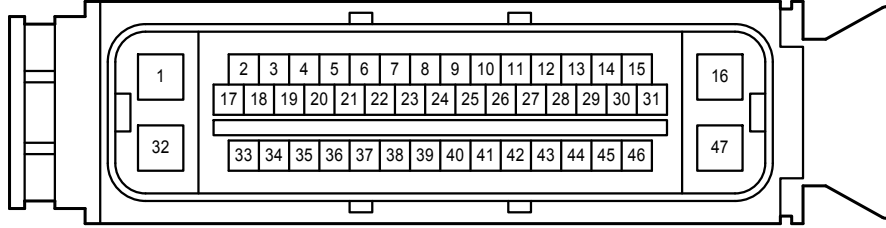

D 35
Gray

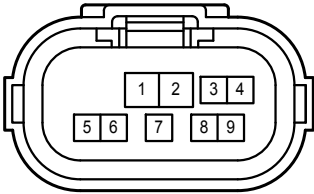

J 7
White

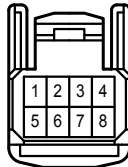

J 28
White

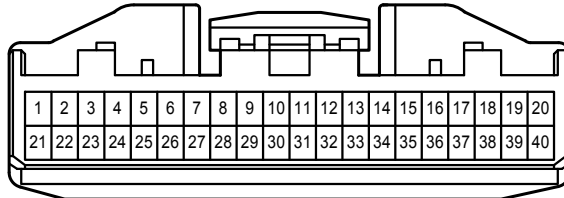

J 45
Black

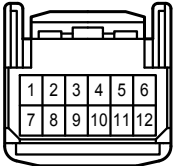

J 54
Orange

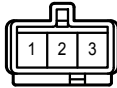

J 71
Black

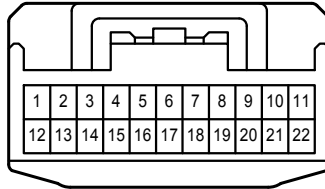

J 73
Black

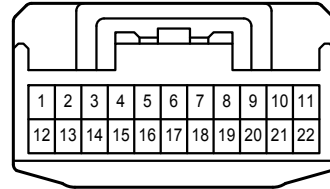

J 74
Black

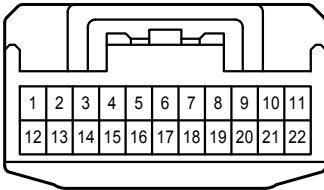

J 77
Gray

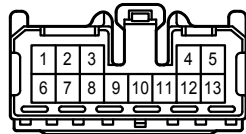

J100
Black

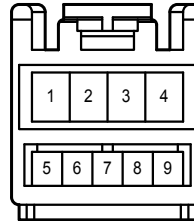

J107
White

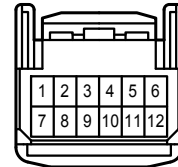

J108
White

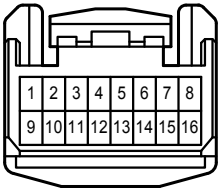

J116
Brown

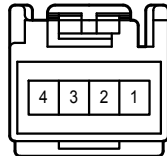

K 3
White

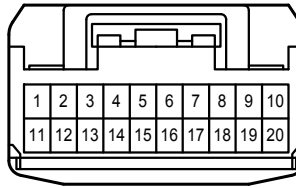

K 4
White

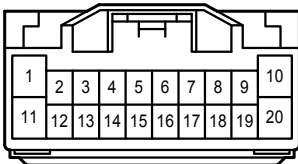

K 6
Gray

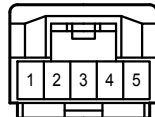

K 7
White

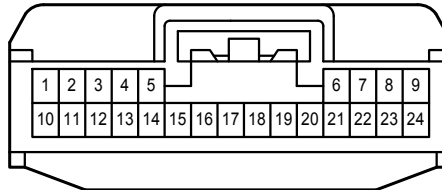

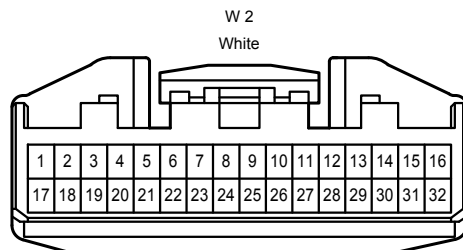
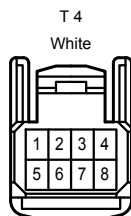
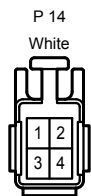
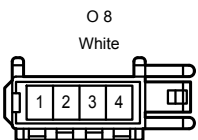
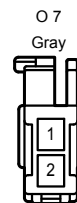
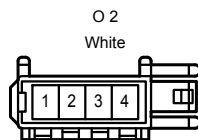
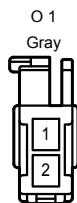
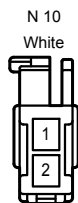
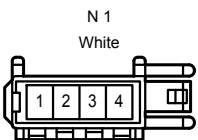
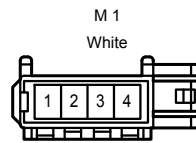
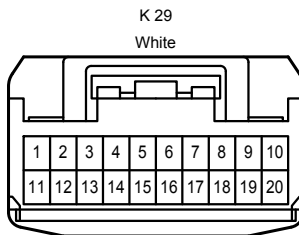
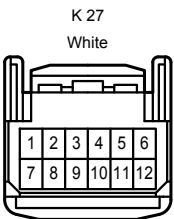
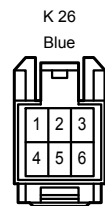
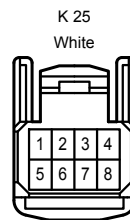
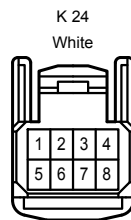
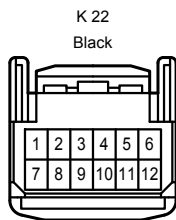
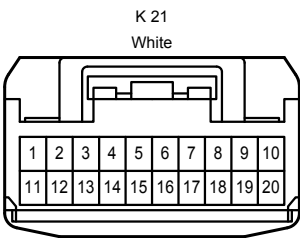
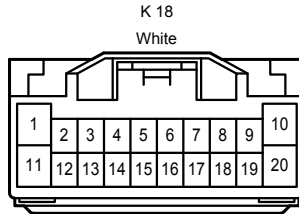
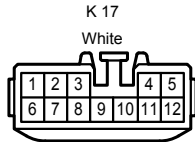
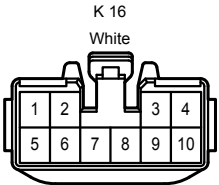
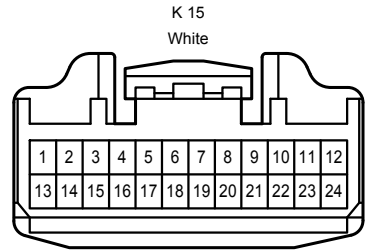
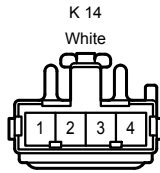
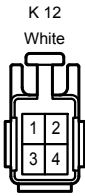
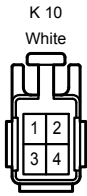
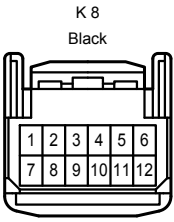

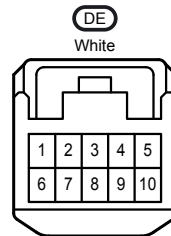
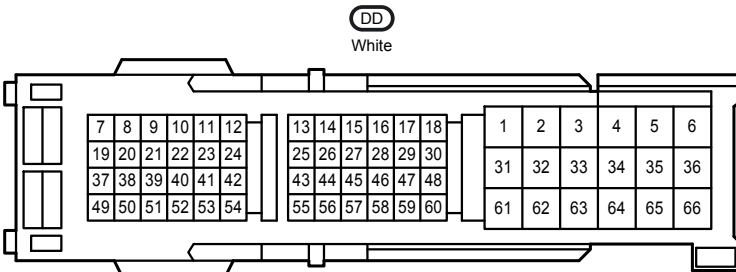
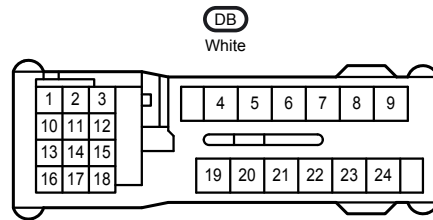
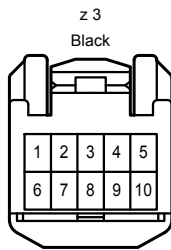
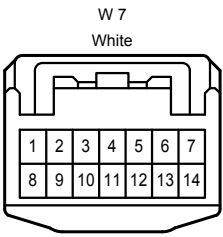

AJ4
White

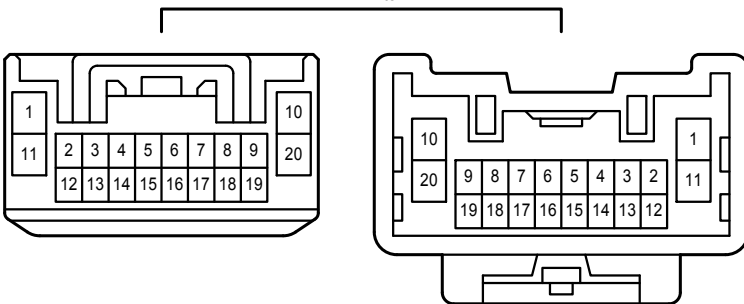

AJ5
White

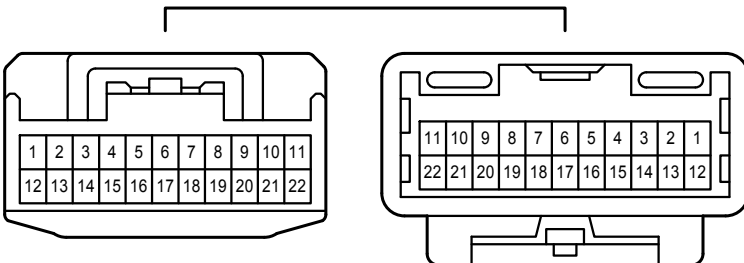

AJ9
Gray

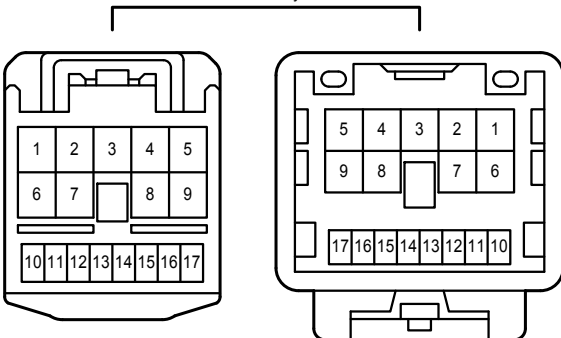

AJ10
Gray

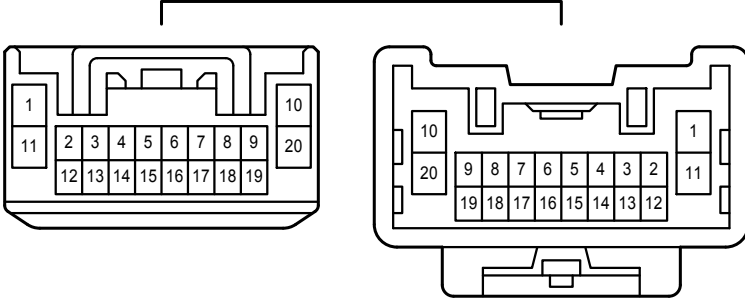

AJ11
Gray

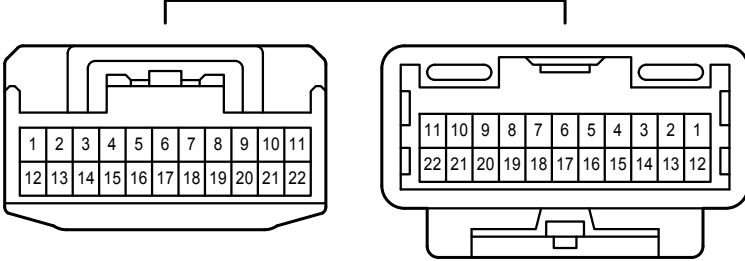

DA1
White

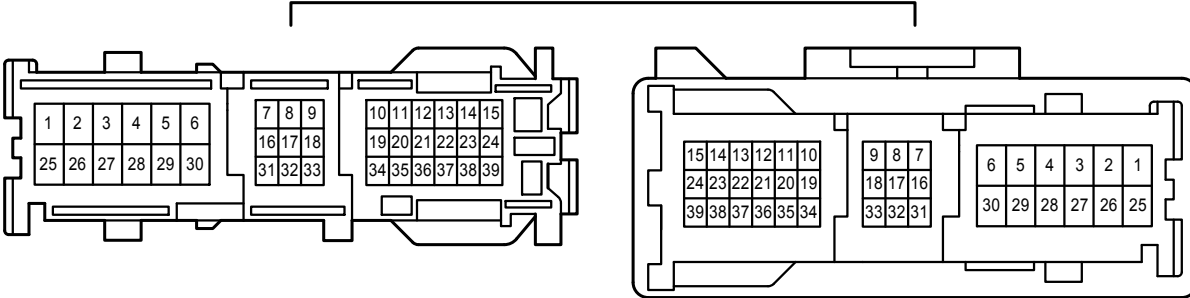

JJ2
White

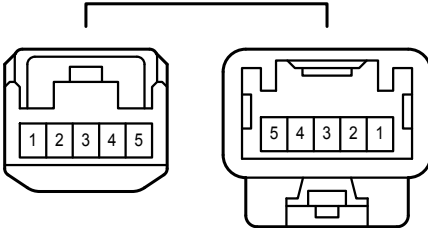

JK1
White

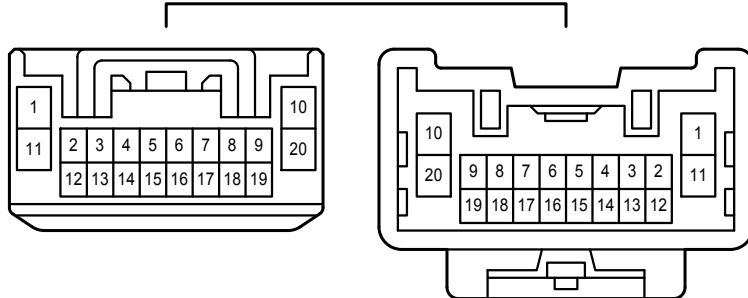

JK2
White

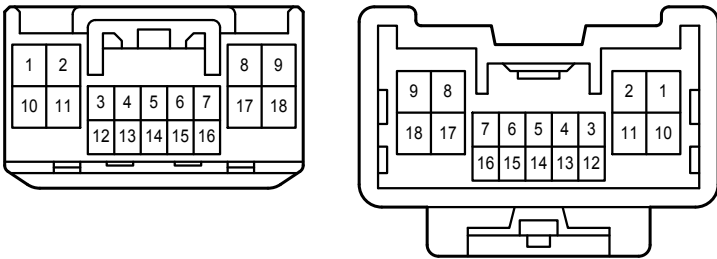

JK3
White

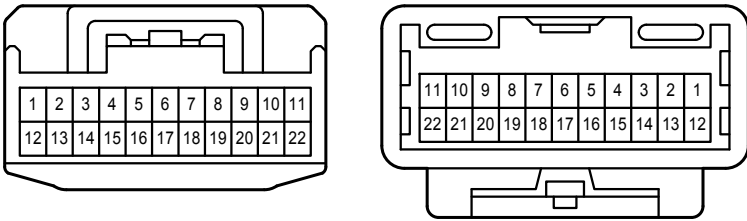

JT1
Black

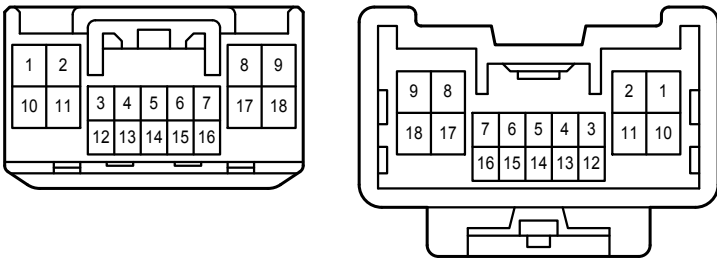

JW1
White

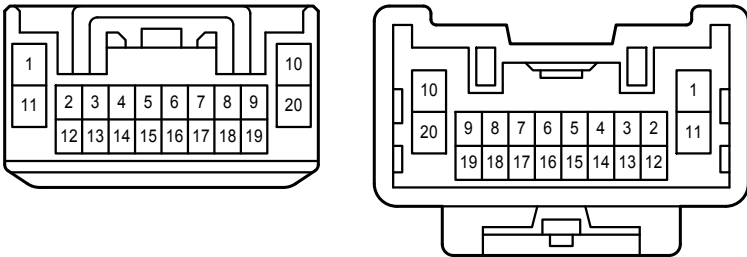

KW1
White

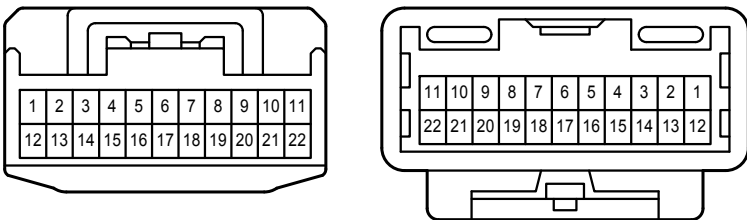

MK1
Blue

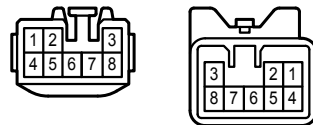

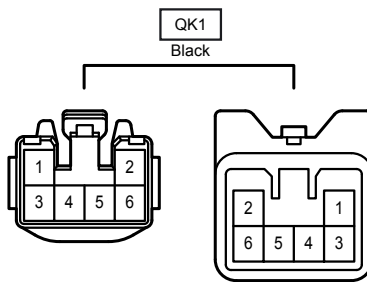
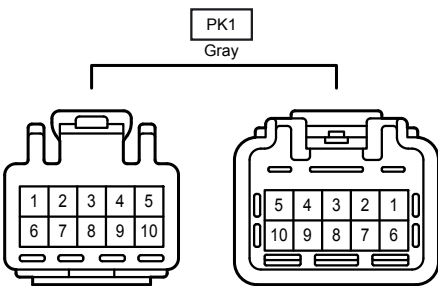
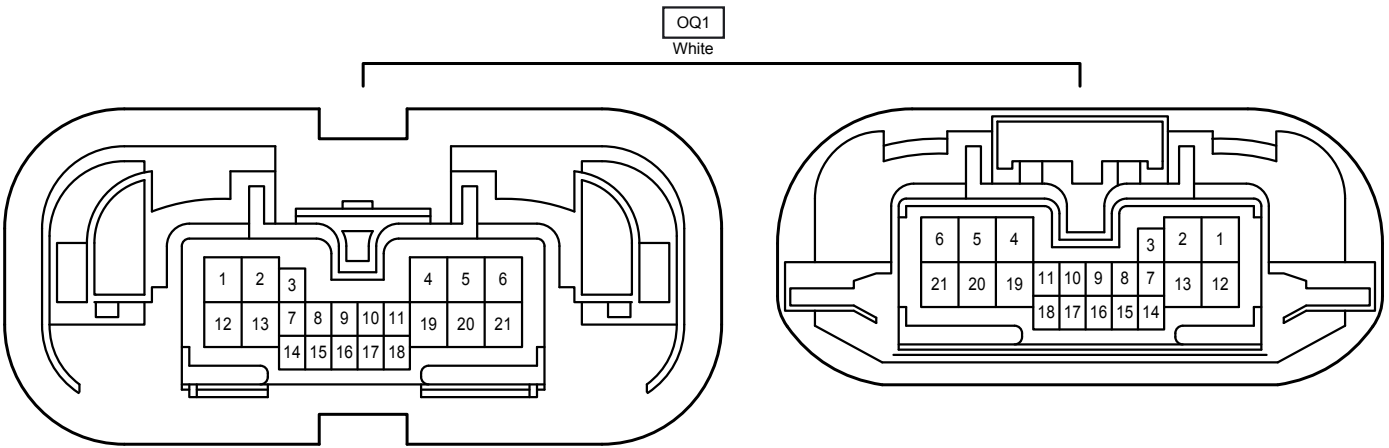
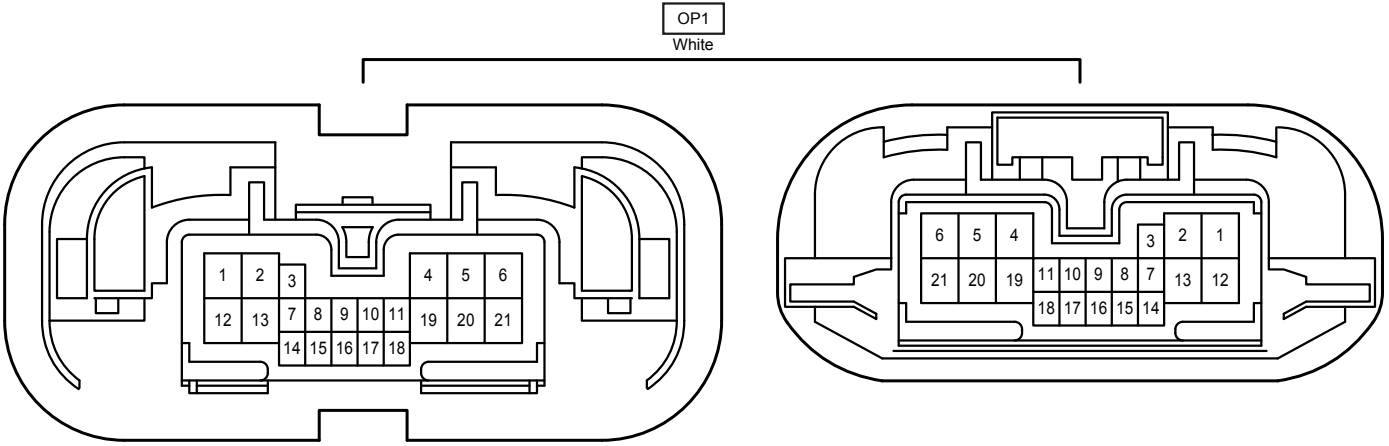
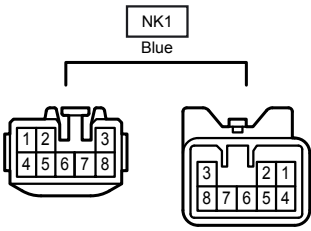

RA1
White

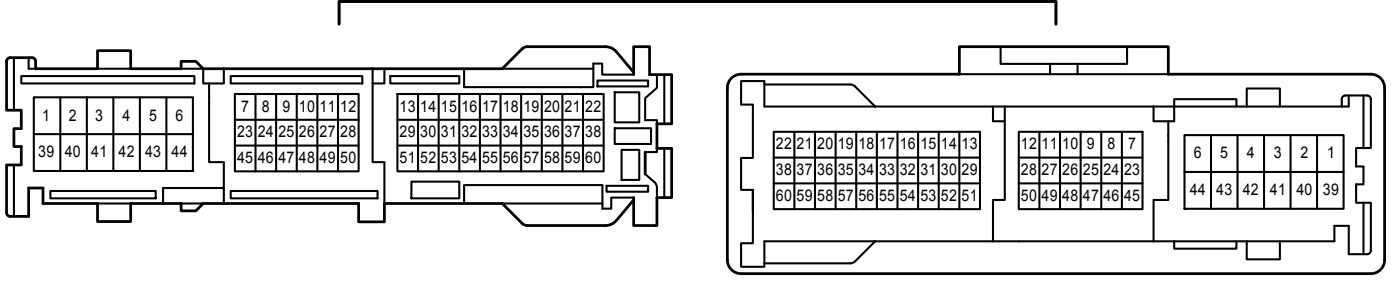

TJ1
White

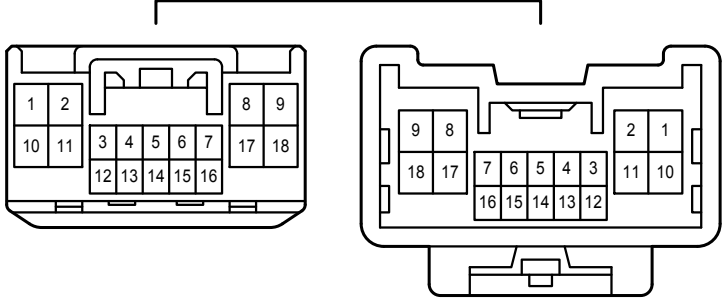

XR1
White

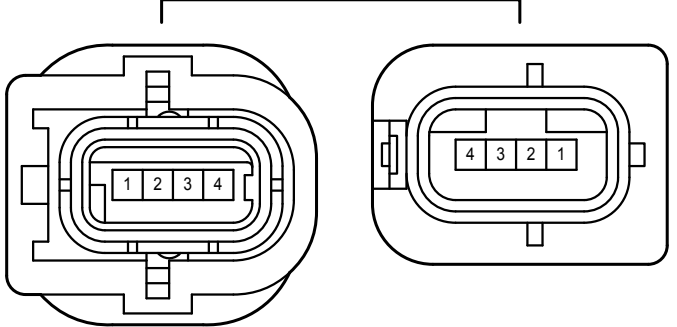

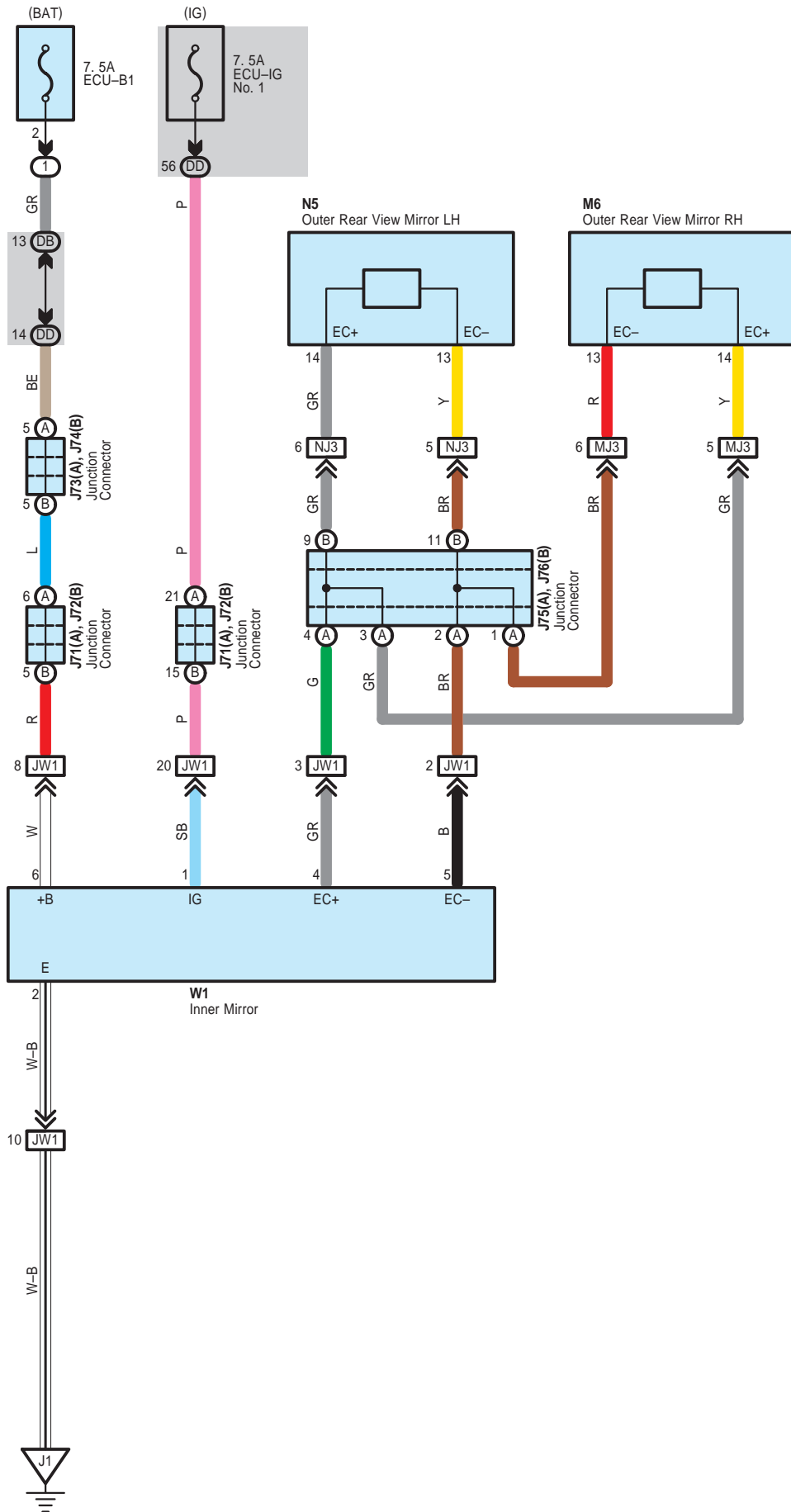

Automatic Glare-Resistant EC Mirror , Compass

J 71
Black

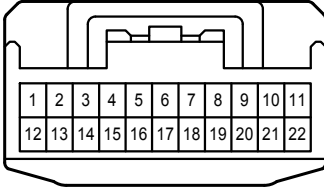

J 72
Black

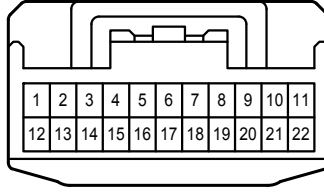

J 73
Black

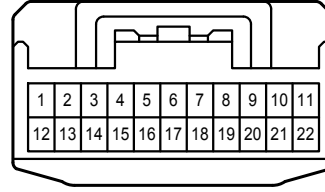

J 74
Black

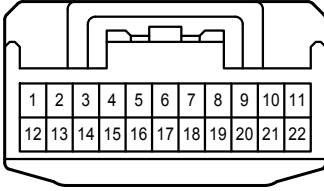

J 75
White

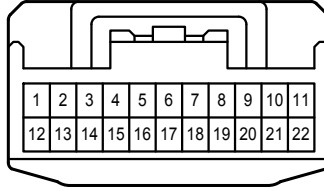

J 76
White

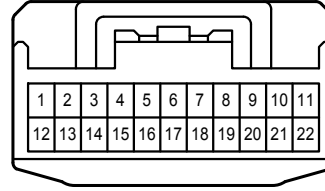

M 6
White

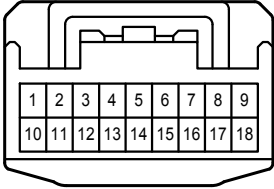

N 5
White

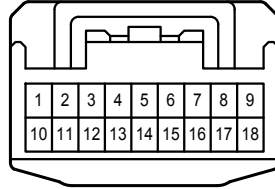

W 1
Black

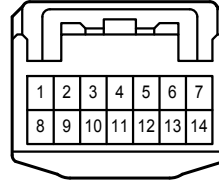

DB
White

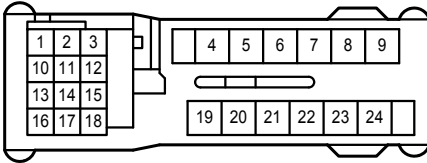

DD
White

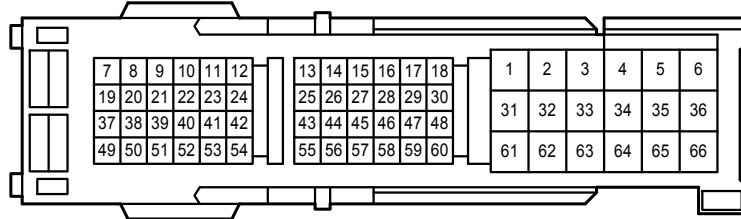

JW1
White

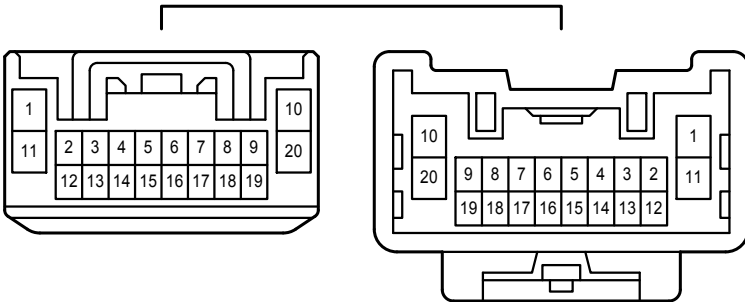

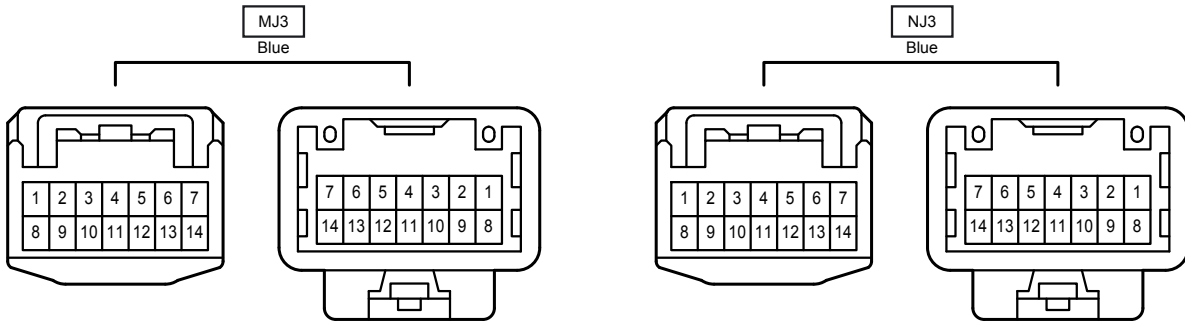

Automatic Light Control , Light Auto Turn Off System

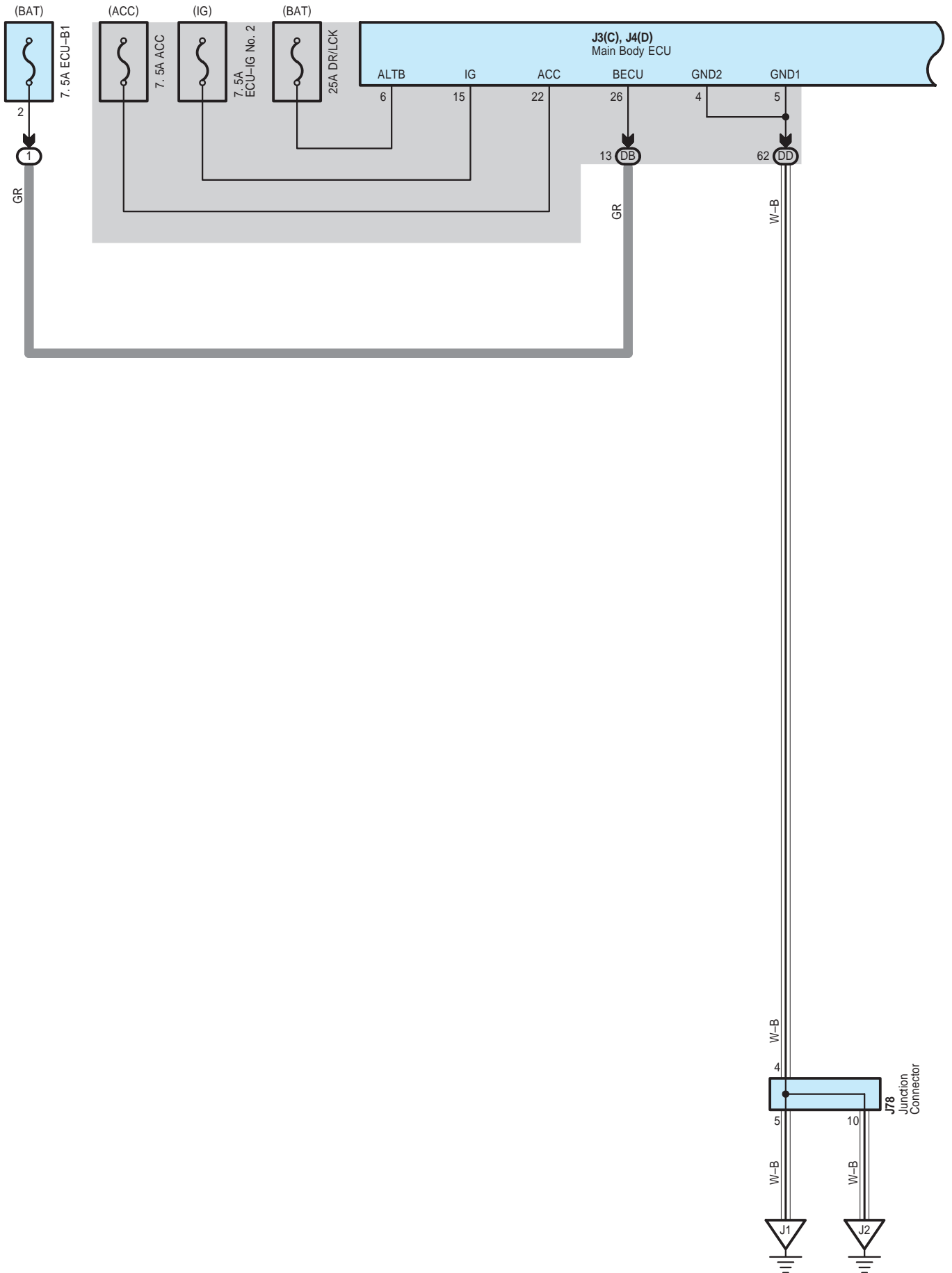

Automatic Light Control , Light Auto Turn Off System

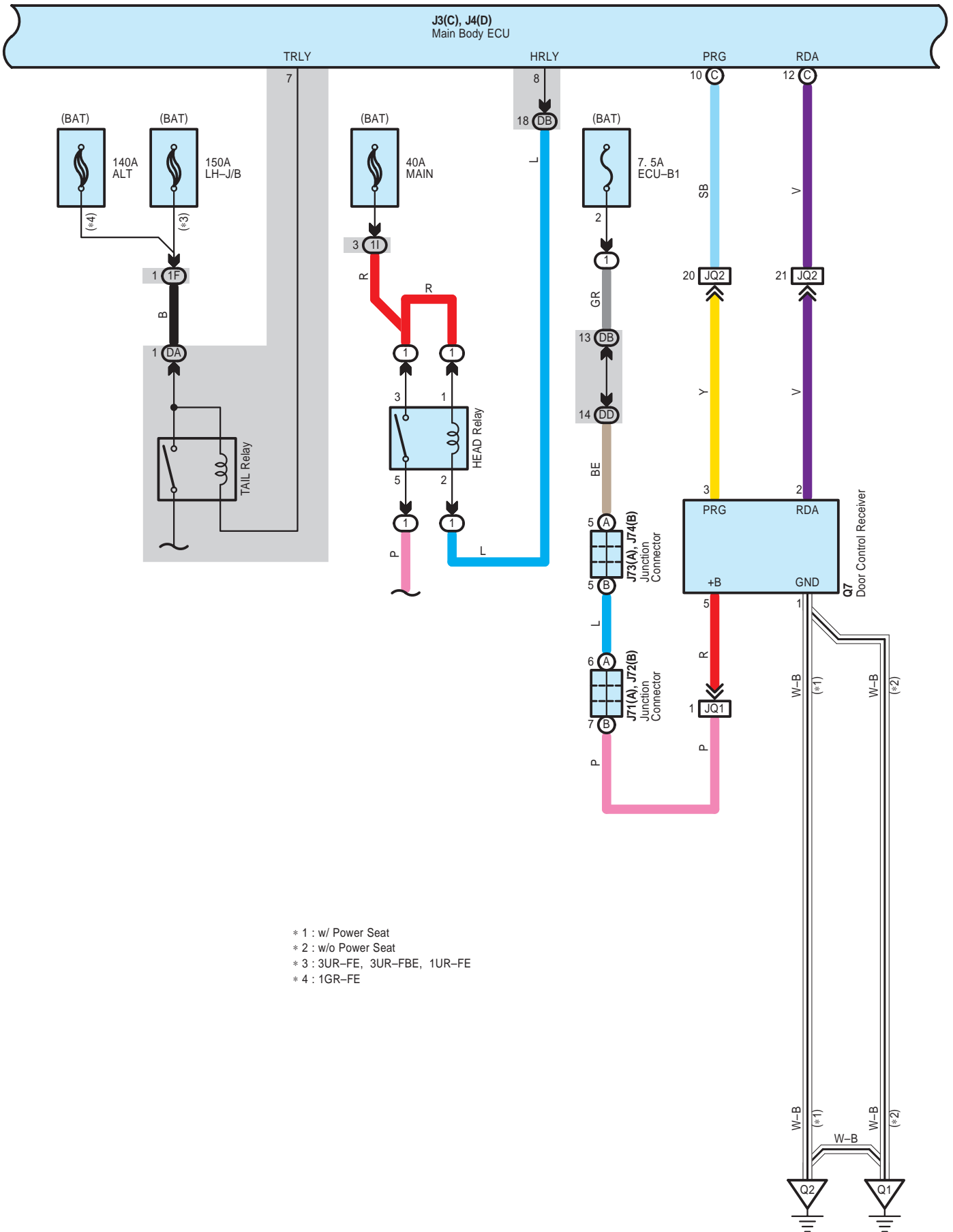

- * 1 : w/ Power Seat
- * 2 : w/o Power Seat
- * 3 : 3UR-FE, 3UR-FBE, 1UR-FE
- * 4 : 1GR-FE

Automatic Light Control , Light Auto Turn Off System

* 5 : w/ Seat Position Memory
 * 6 : w/ Rear Door Courtesy Light

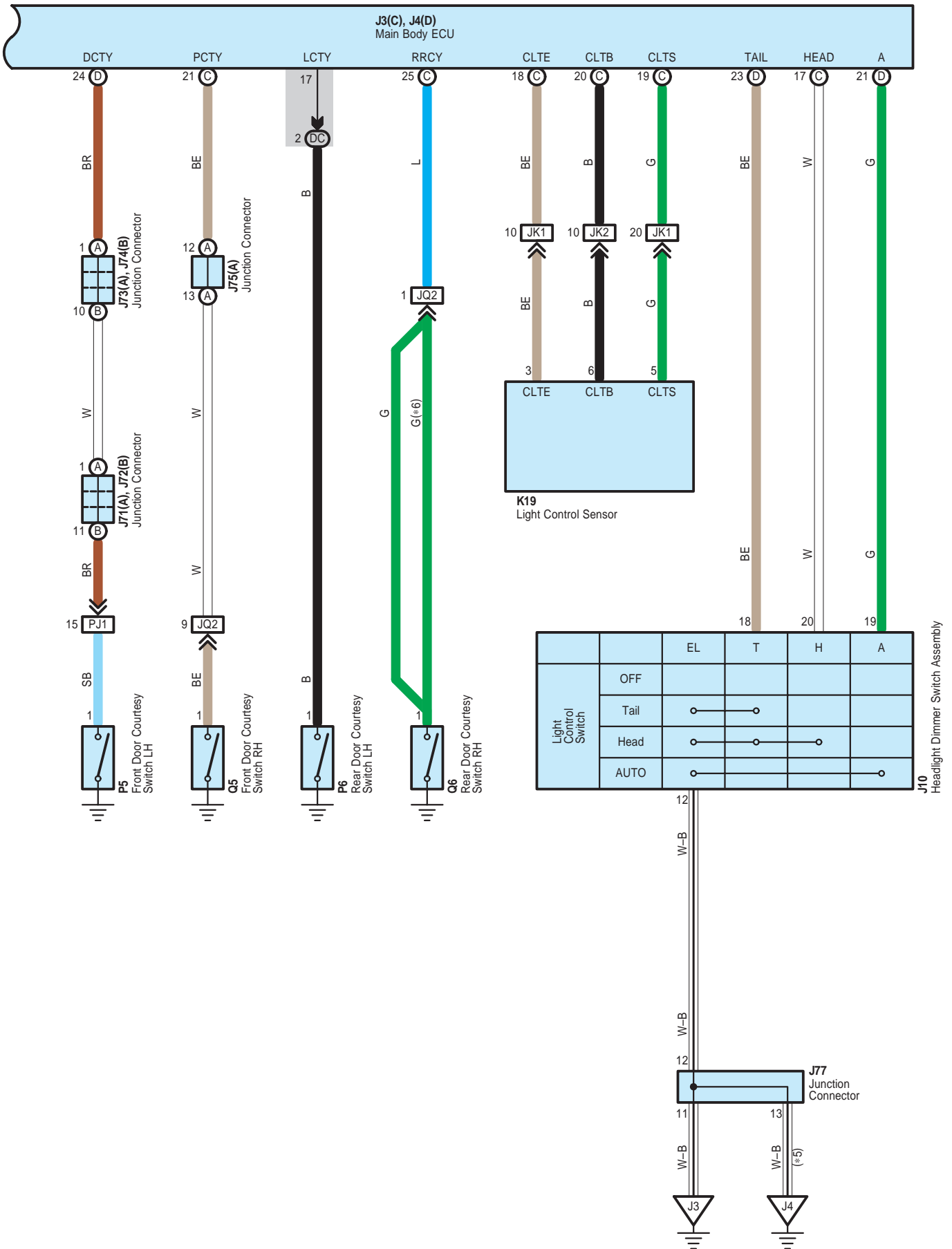

Automatic Light Control , Light Auto Turn Off System

J 3
White

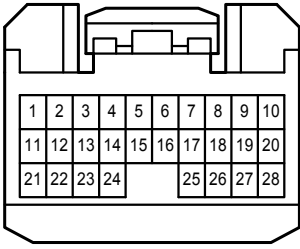

J 4
White

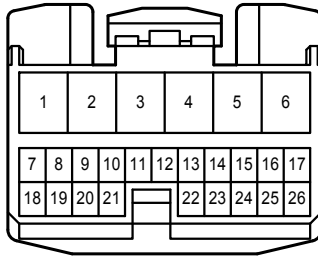

J 10
White

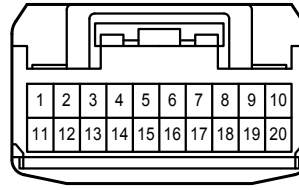

J 71
Black

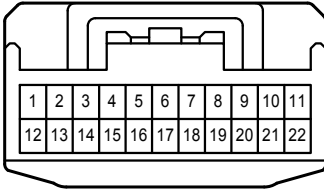

J 72
Black

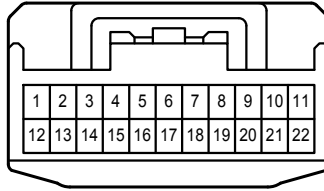

J 73
Black

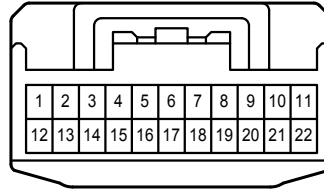

J 74
Black

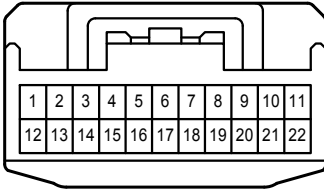

J 75
White

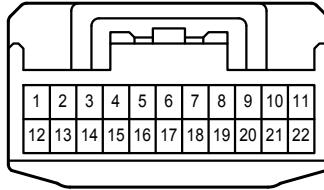

J 77
Gray

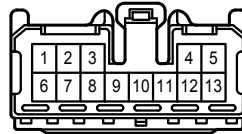

J 78
White

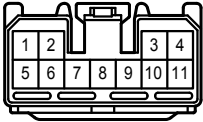

K 19
Black

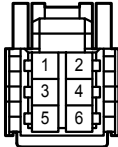

P 5
White



P 6
White



Q 5
White



Q 6
White



Q 7
White

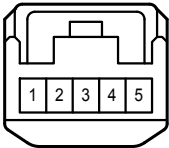

1F

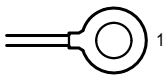

1I

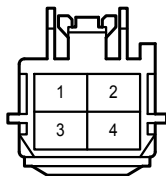

DA

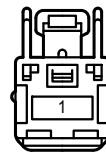

DB
White

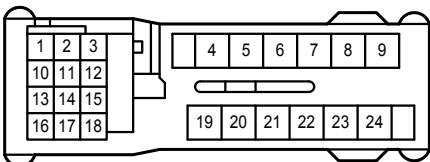

DC
White

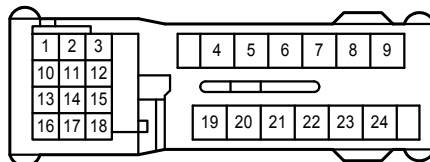

Automatic Light Control , Light Auto Turn Off System

DD

White

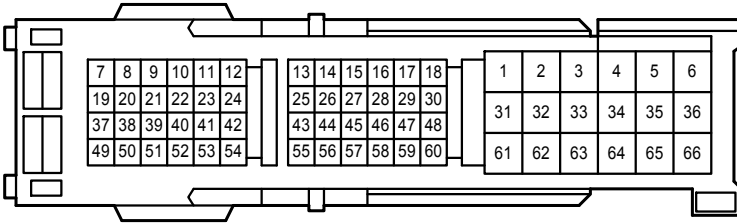

JK1

White

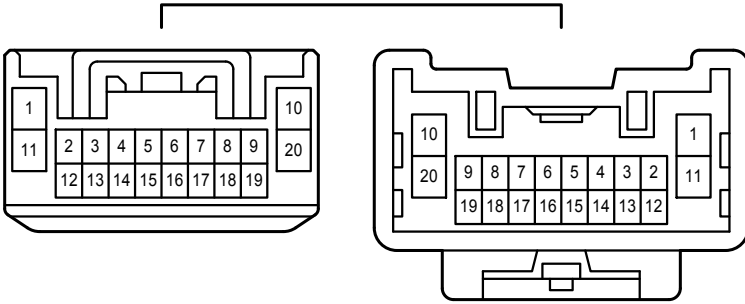

JK2

White

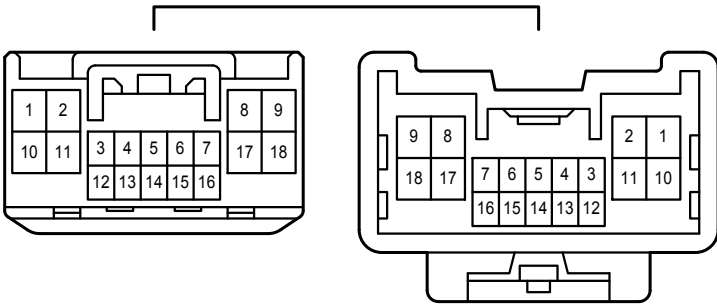

JQ1

Gray

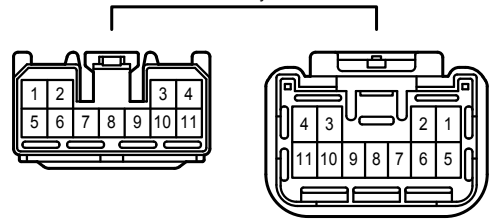

JQ2

Gray

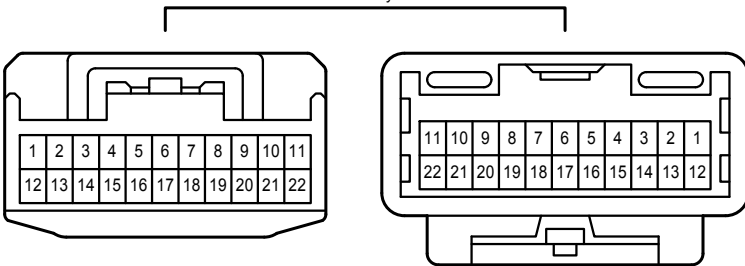

PJ1

Black

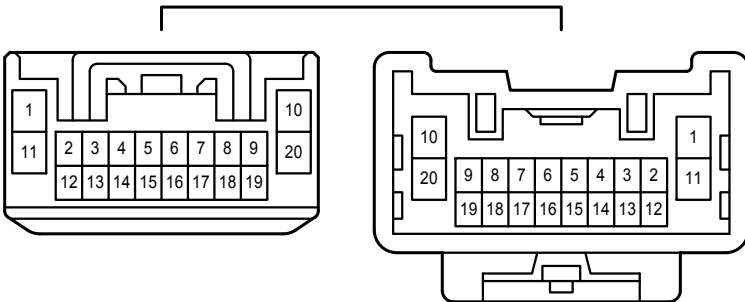

Back-Up Light

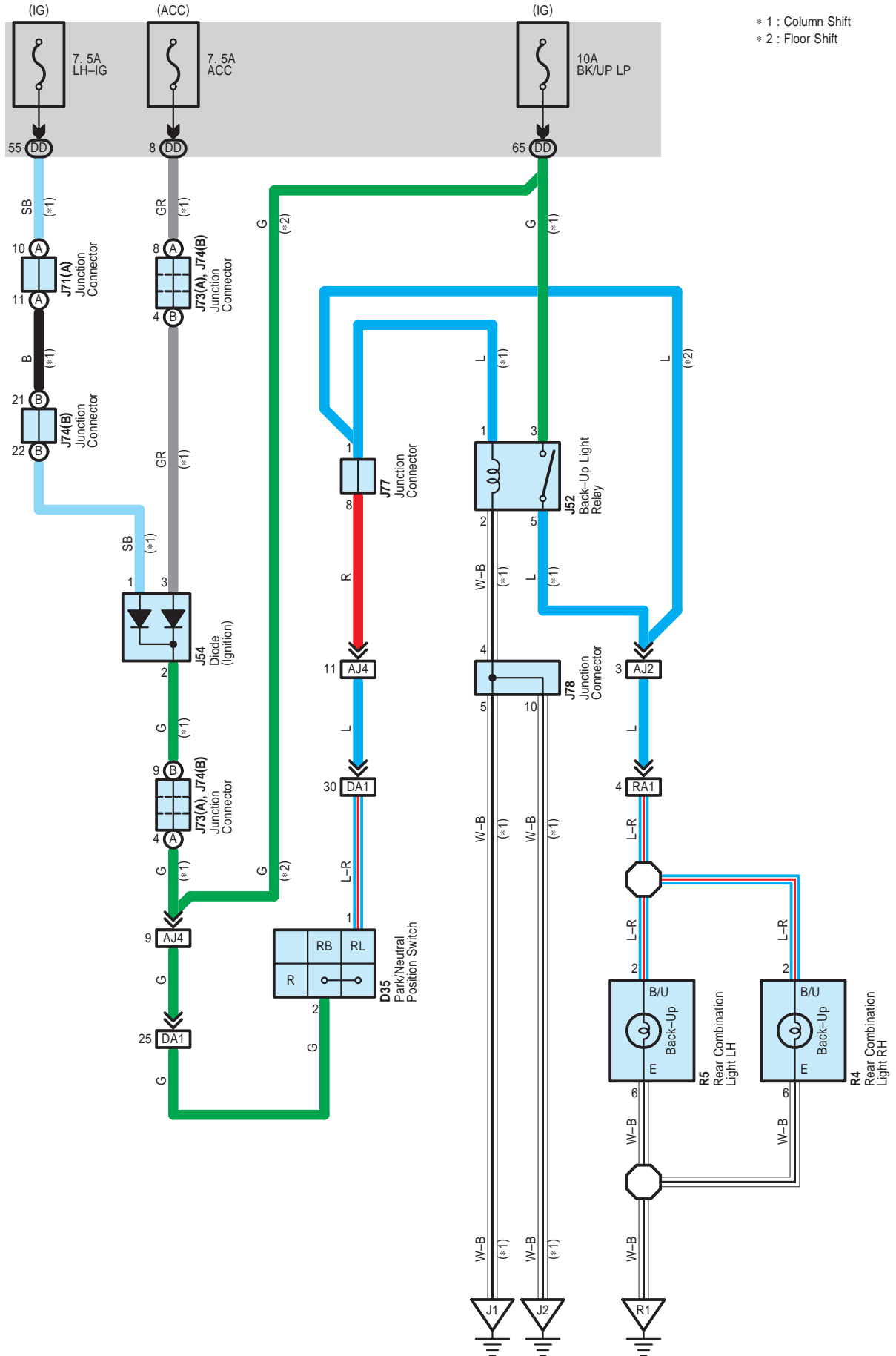

Back-Up Light

D 35
Gray

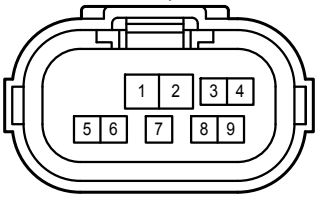

J 52
White

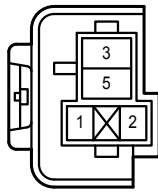

J 54
Orange

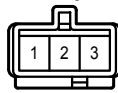

J 71
Black

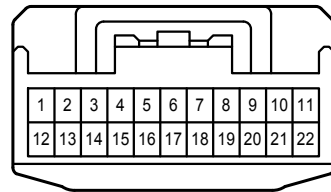

J 73
Black

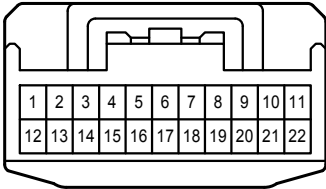

J 74
Black

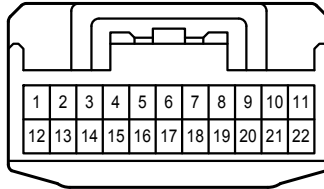

J 77
Gray

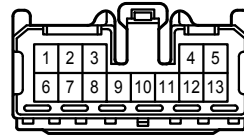

J 78
White

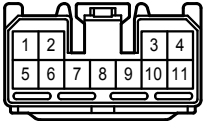

R 4
Gray



R 5
Gray



DD
White

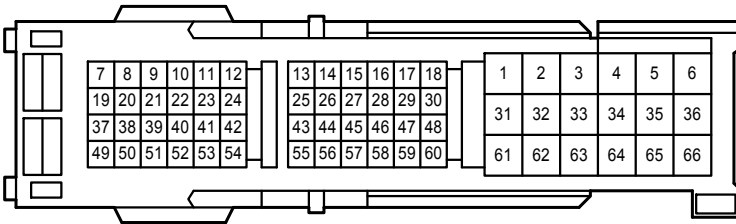

AJ2
White

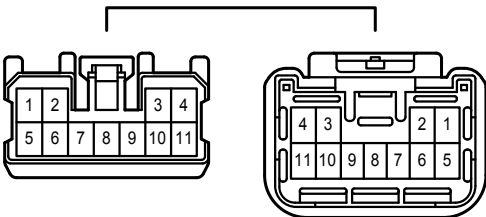

AJ4
White

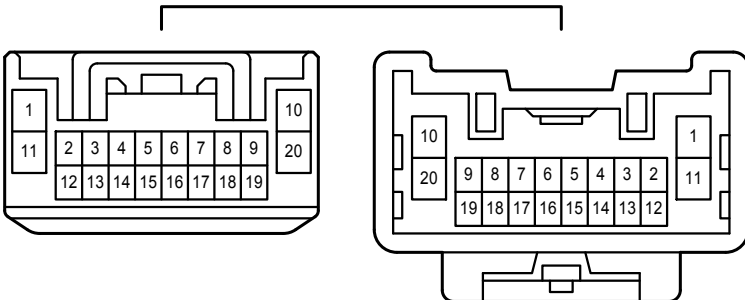

Back-Up Light

DA1
White

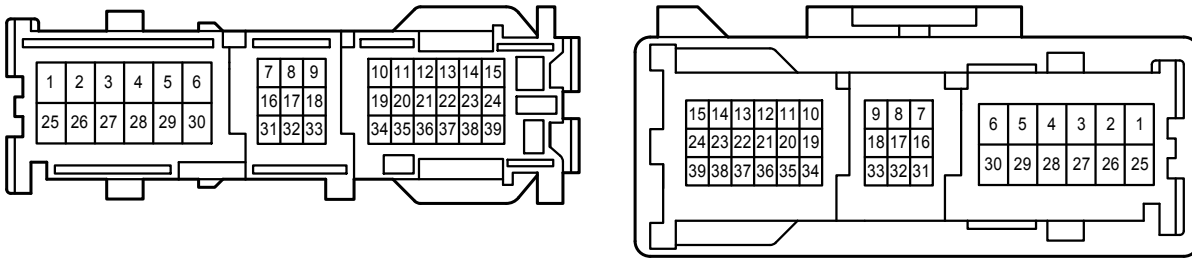

RA1
White

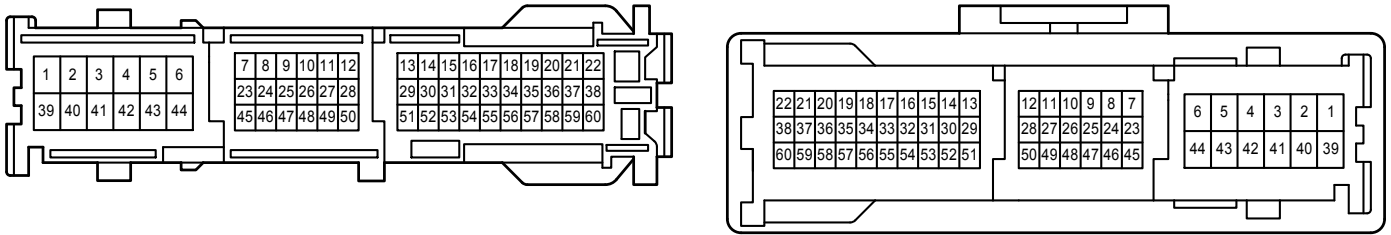

Cargo Light

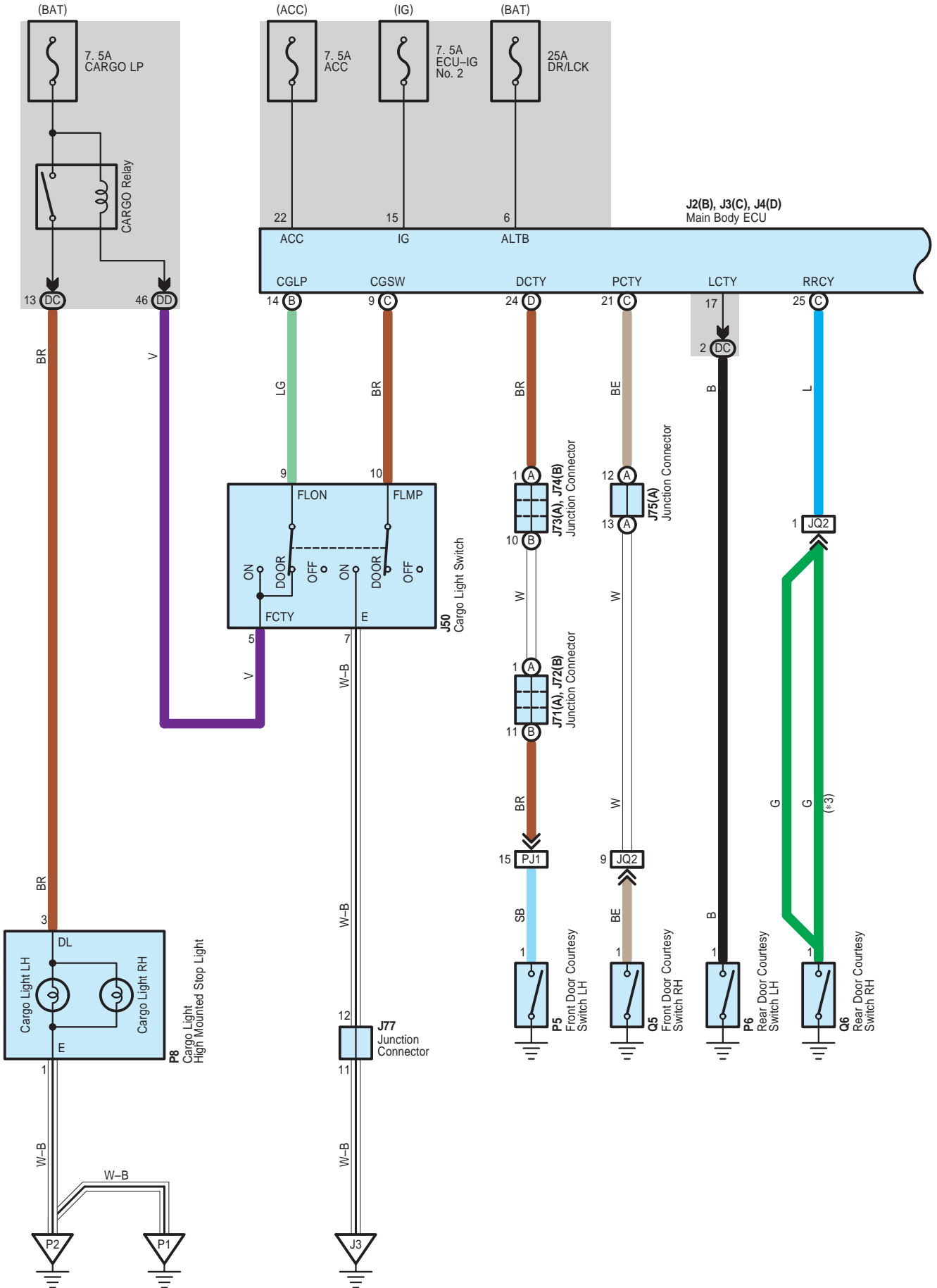

Cargo Light

- * 1 : w/ Power Seat
- * 2 : w/o Power Seat
- * 3 : w/ Rear Door Courtesy Light

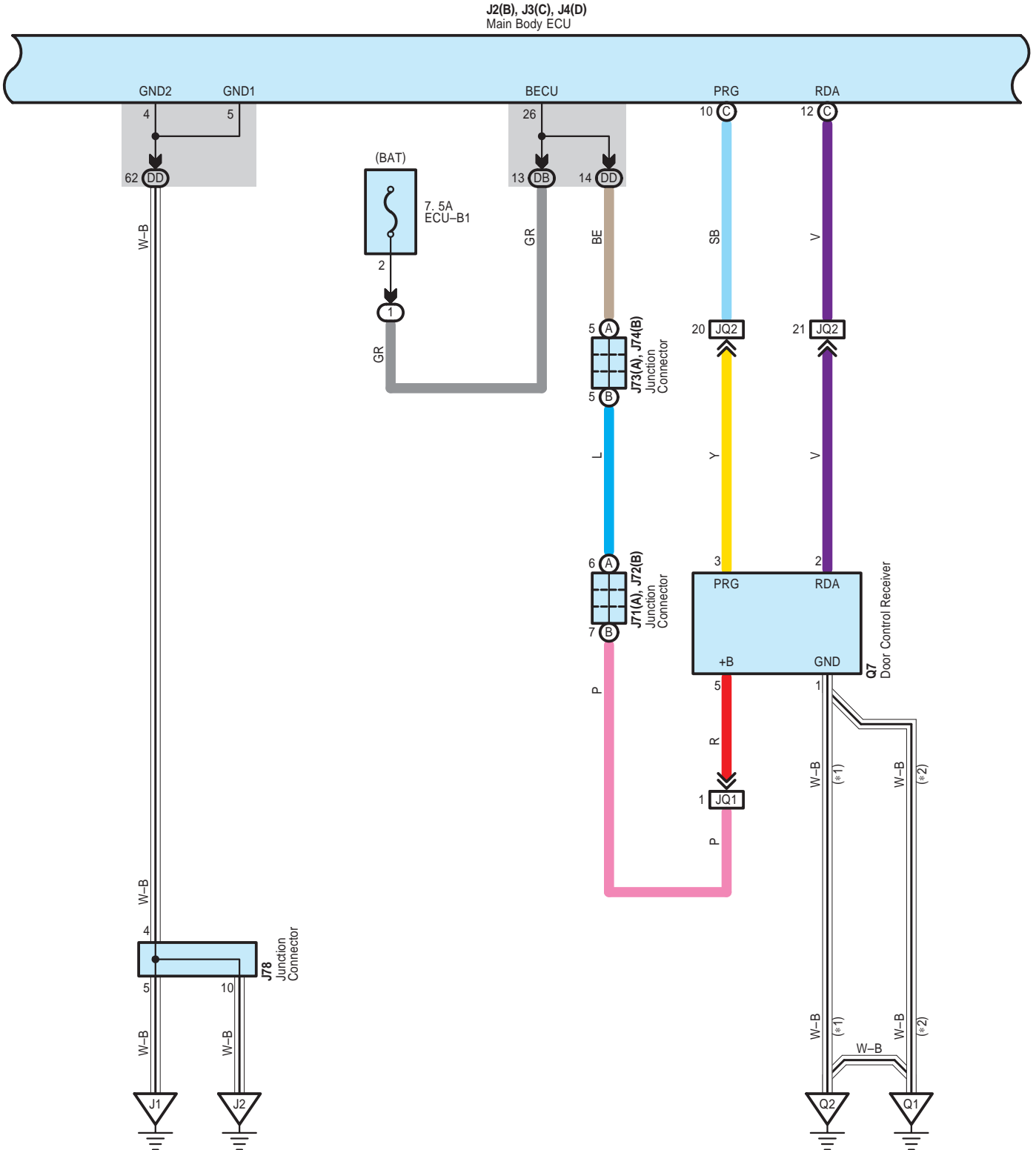

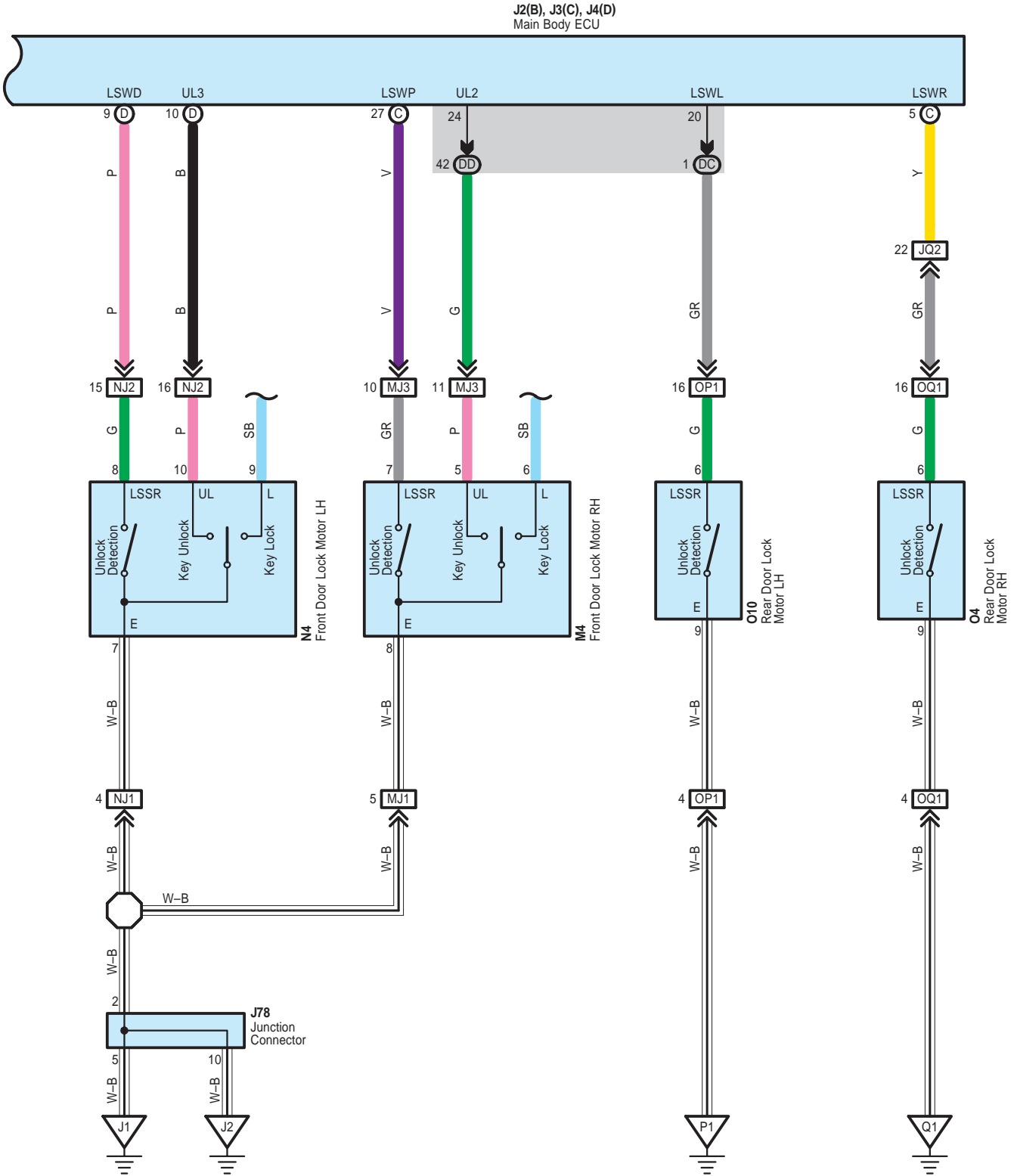

Cargo Light

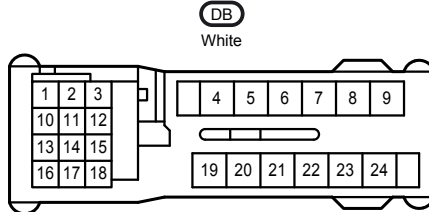
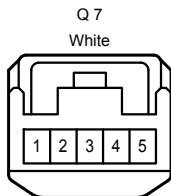
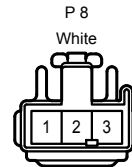
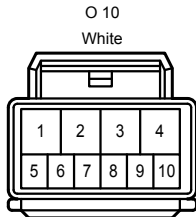
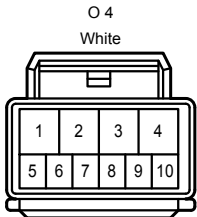
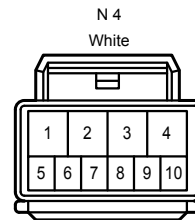
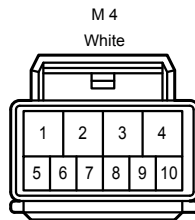
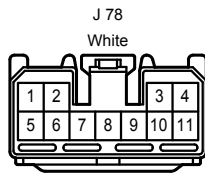
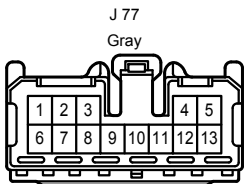
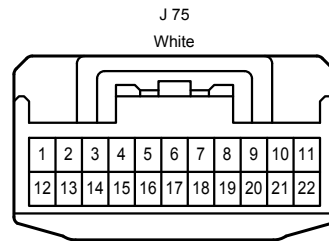
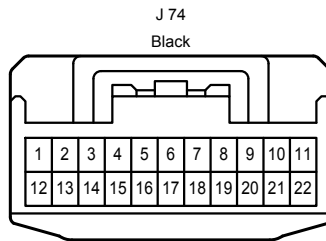
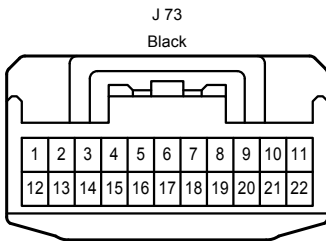
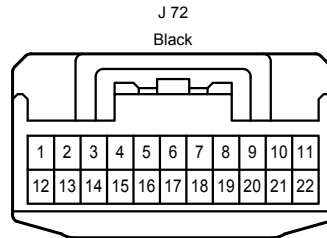
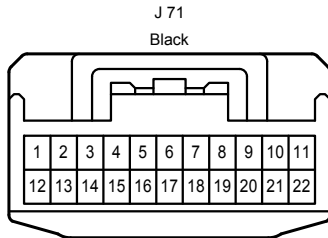
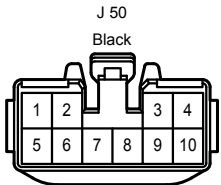
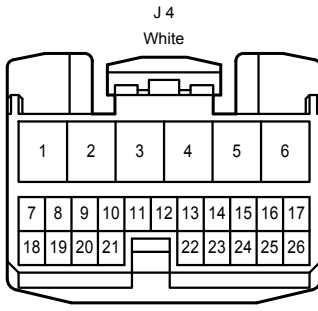
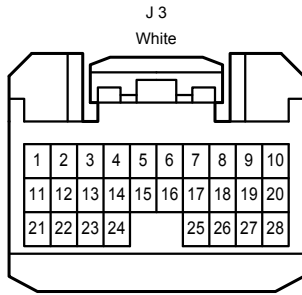
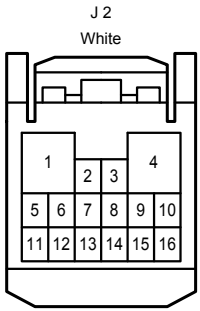

Cargo Light

DC
White

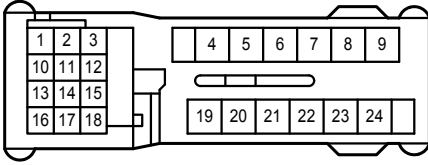

DD
White

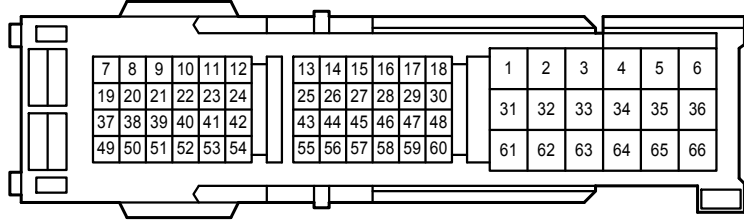

JQ1
Gray

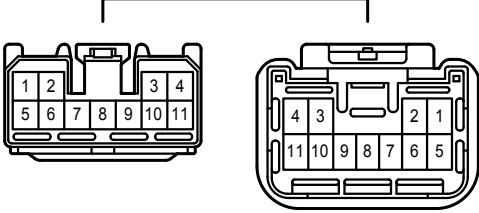

JQ2
Gray

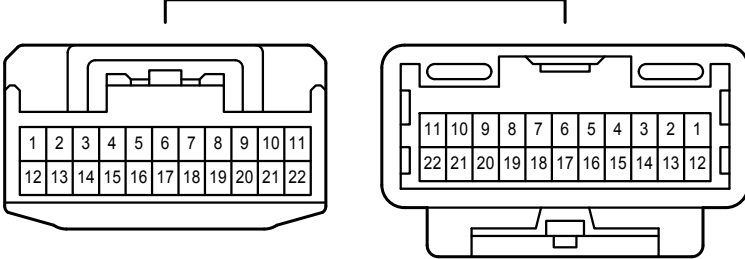

MJ1
Blue

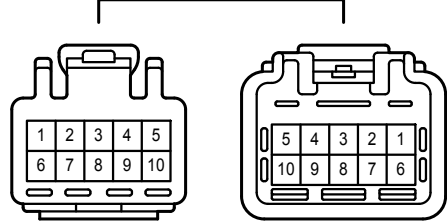

MJ3
Blue

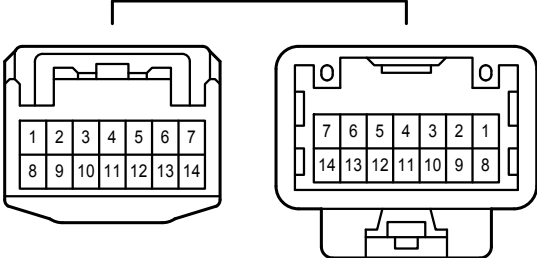

NJ1
Blue

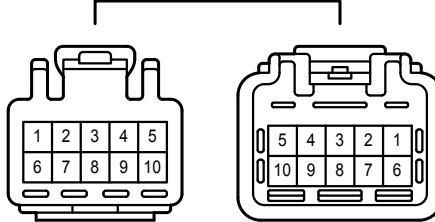

NJ2
Blue

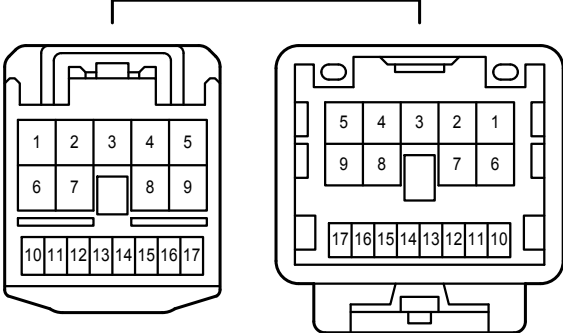

Cargo Light

OP1
White

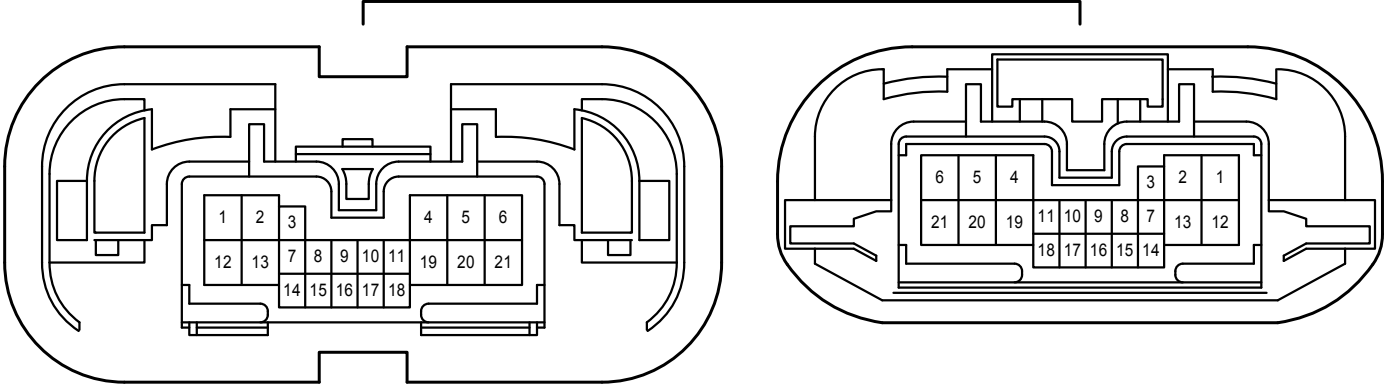

OQ1
White

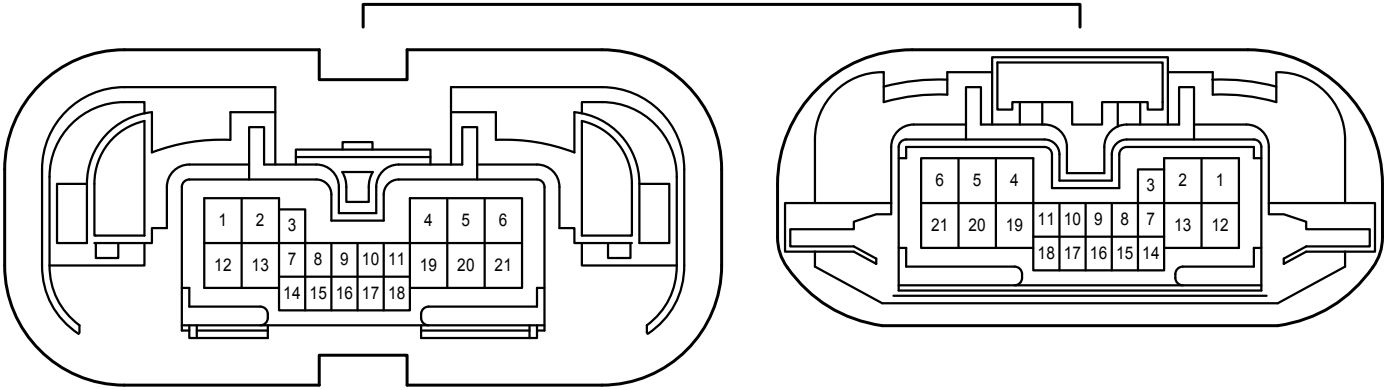

PJ1
Black

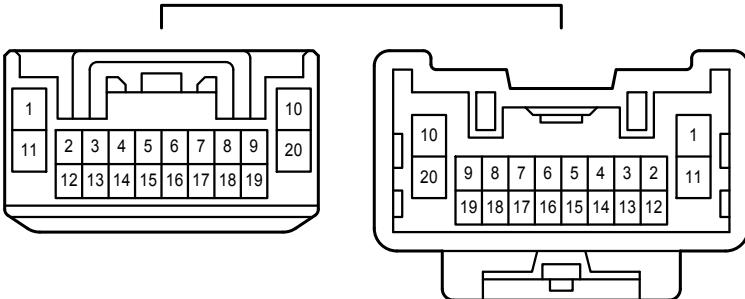

Charging

- * 3 : 3UR-FE, 3UR-FBE, 1UR-FE
- * 4 : 1GR-FE

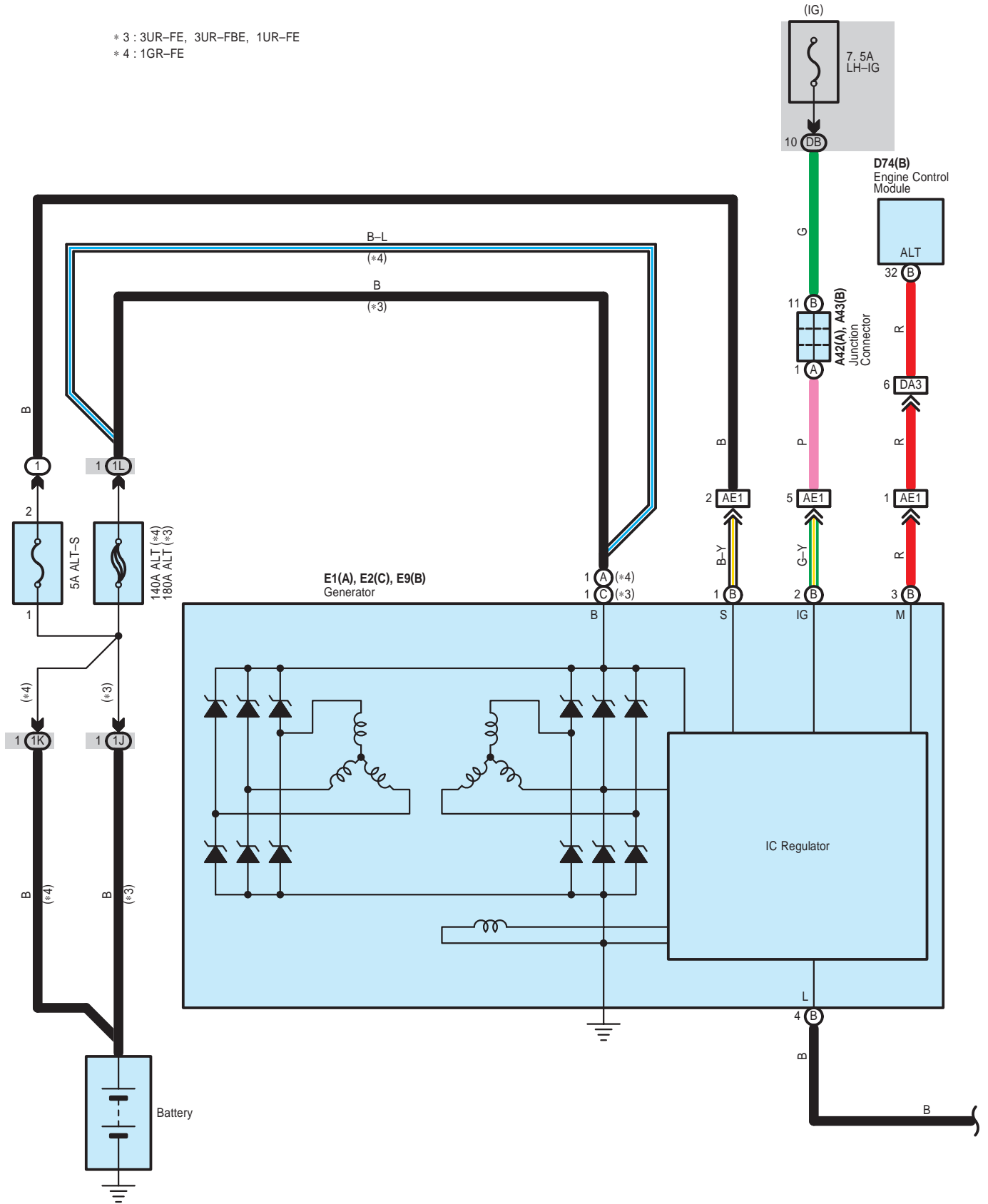

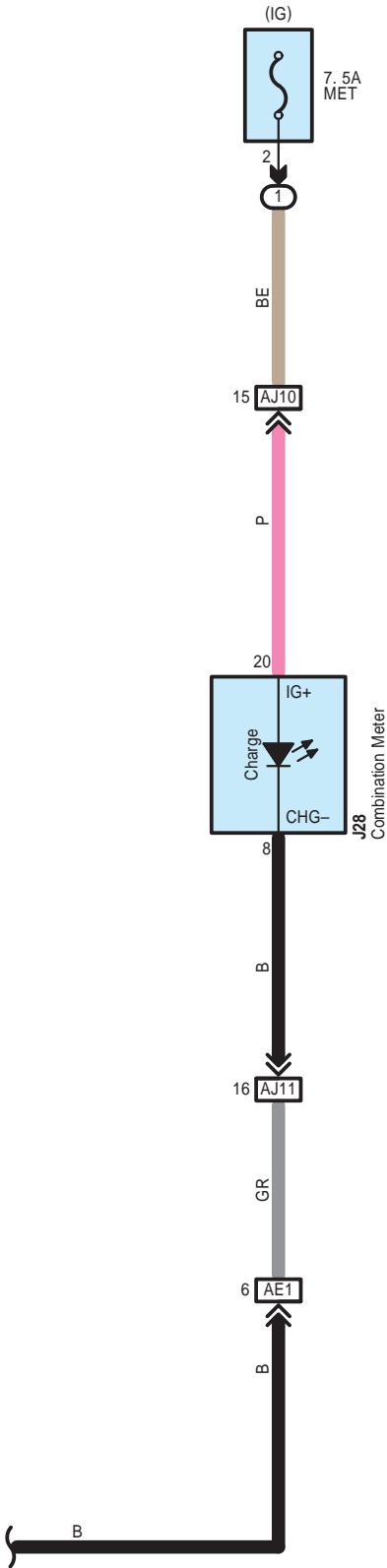

Charging

A 42
White

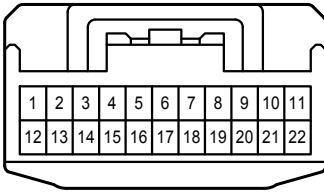

A 43
White

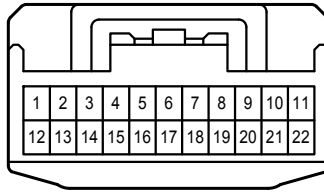

D 74
Black

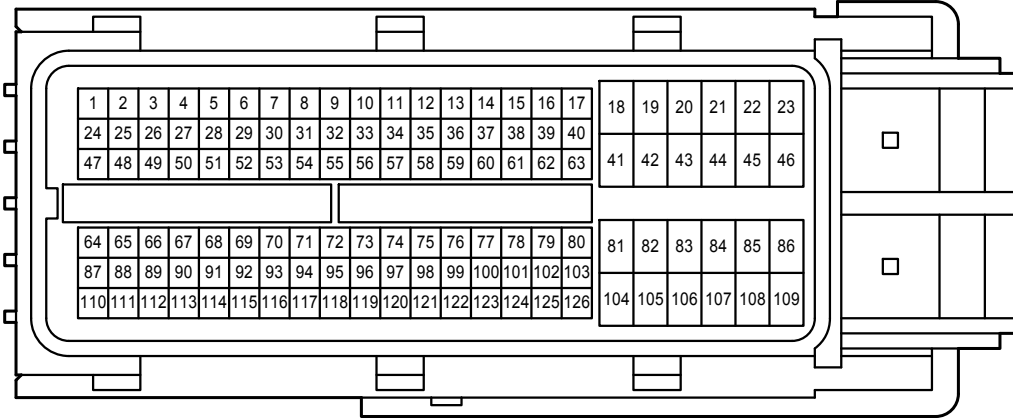

E 1

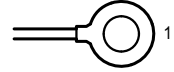

E 2

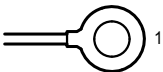

E 9
Black



J 28
White

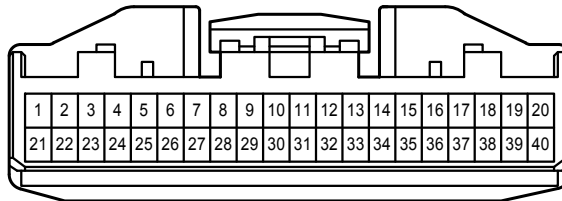

1J

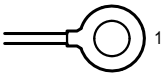

1K

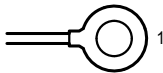

1L

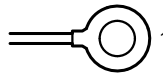

DB
White

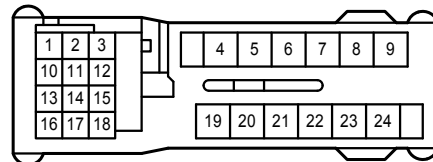

AE1
Gray

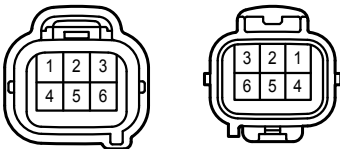

AJ10
Gray

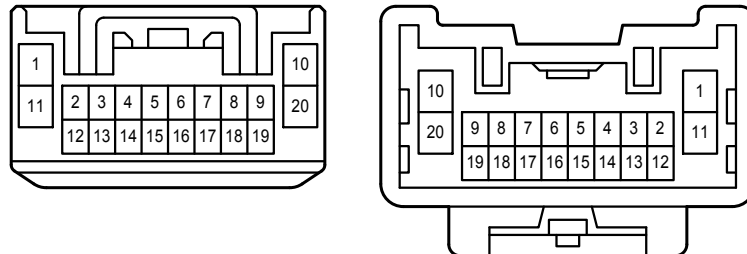

AJ11
Gray

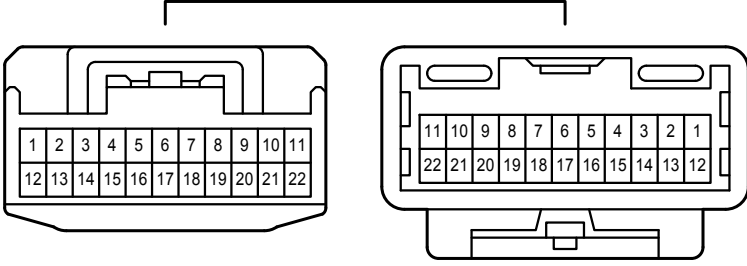

DA3
White

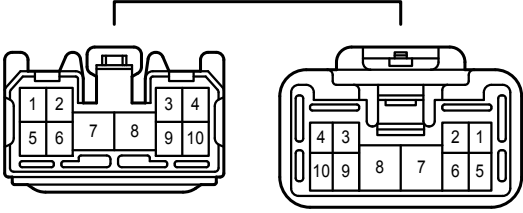

Cigarette Lighter

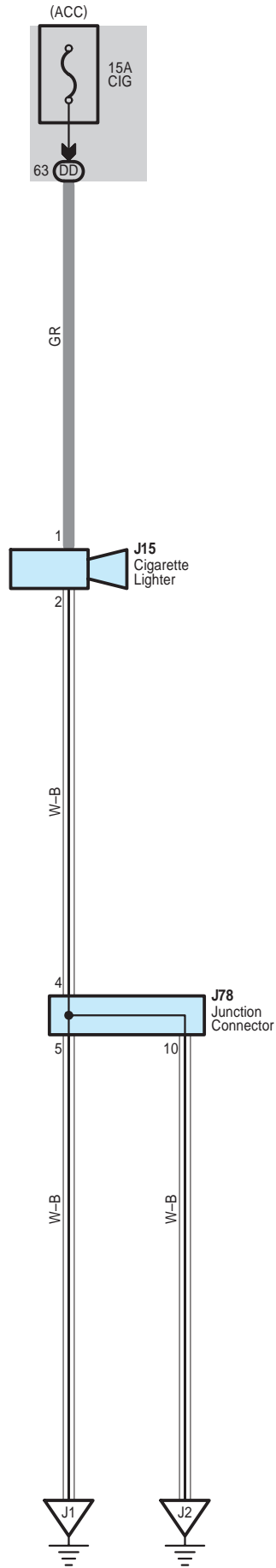

Cigarette Lighter

J 15
White

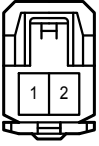

J 78
White

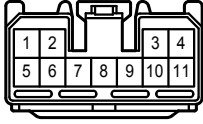

DD
White

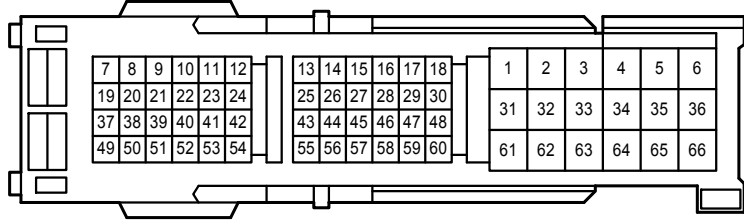

Climate Control Seat , Seat Heater <w/ Climate Control Seat>

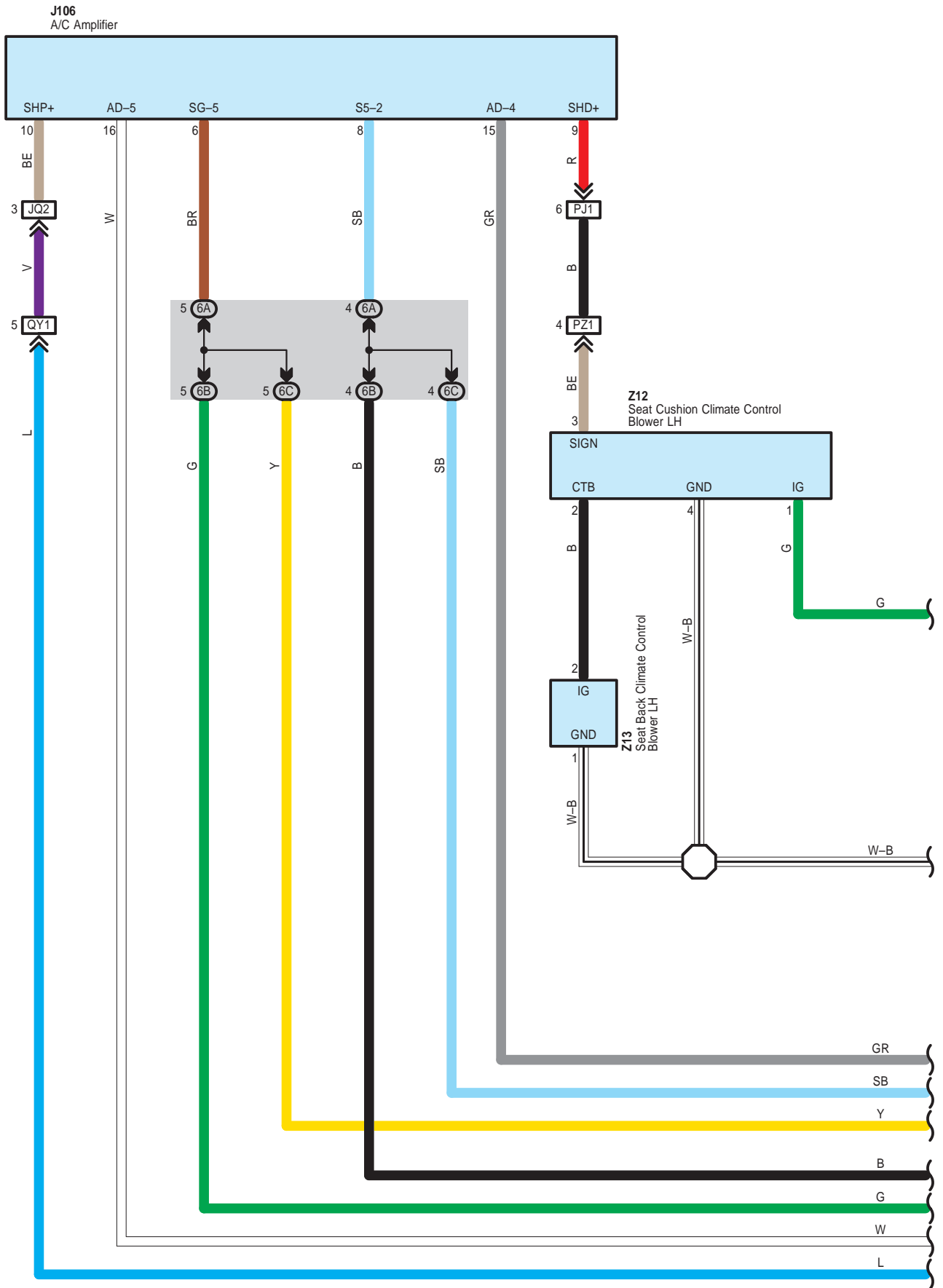

Climate Control Seat , Seat Heater <w/ Climate Control Seat>

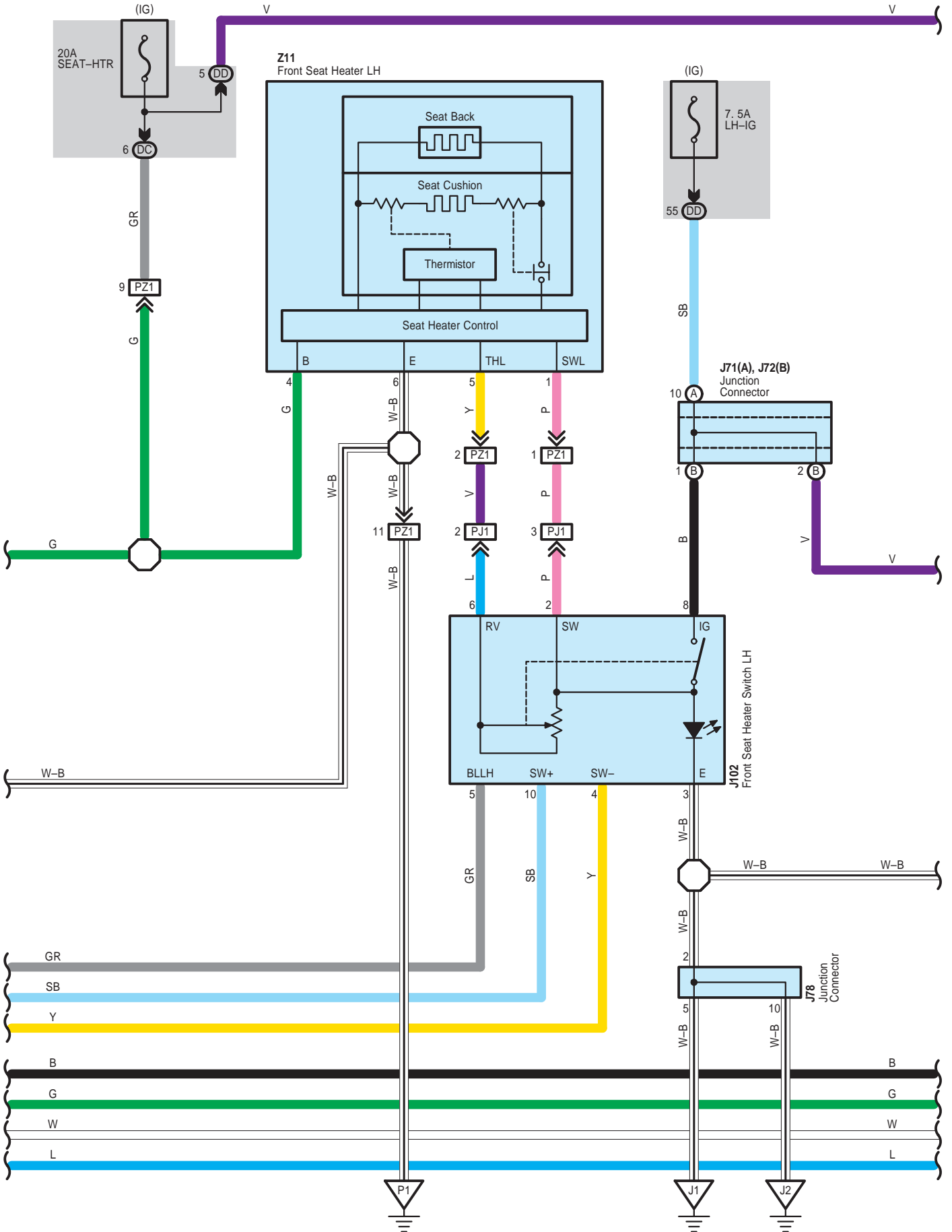

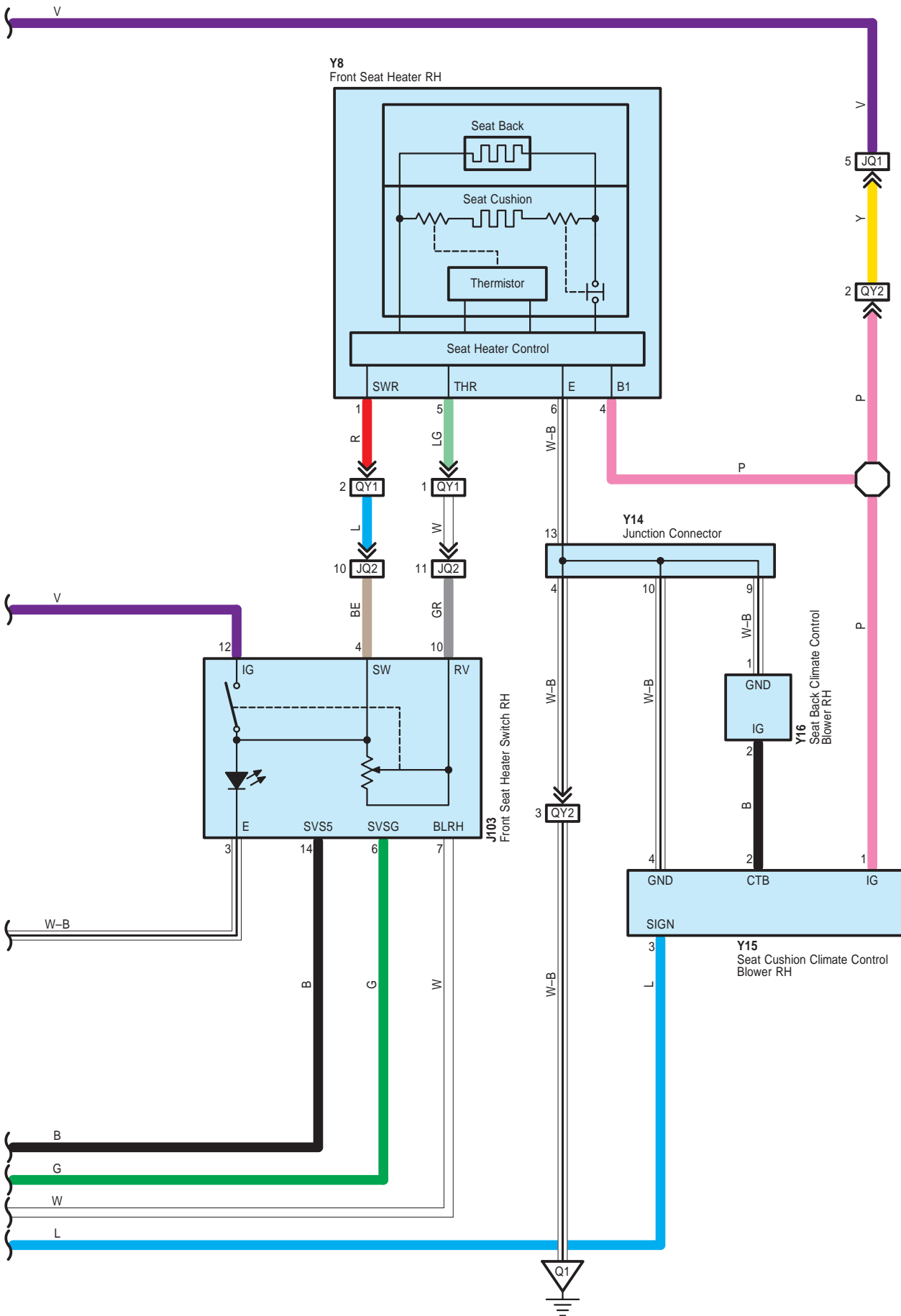

Climate Control Seat , Seat Heater <w/ Climate Control Seat>

J 71
Black

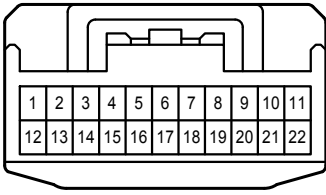

J 72
Black

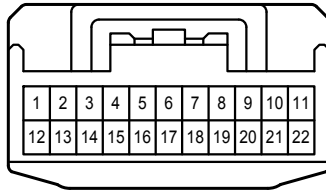

J 78
White

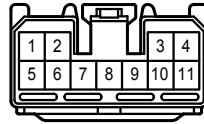

J102
Black

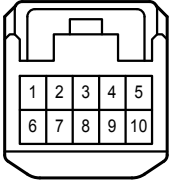

J103
Black

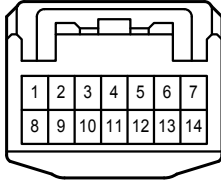

J106
White

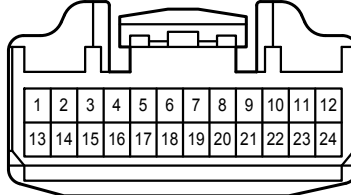

Y 8
White



Y 14
White

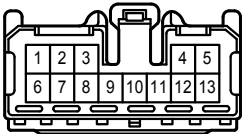

Y 15
Black

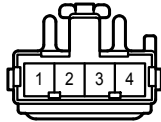

Y 16
Black

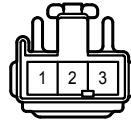

Z 11
White



Z 12
Black

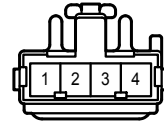

Z 13
Black

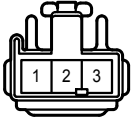

6A
Black

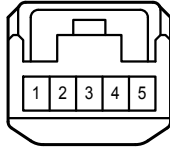

6B
White

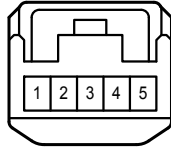

6C
Blue

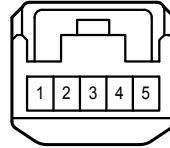

DC
White

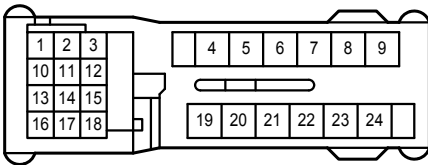

DD
White

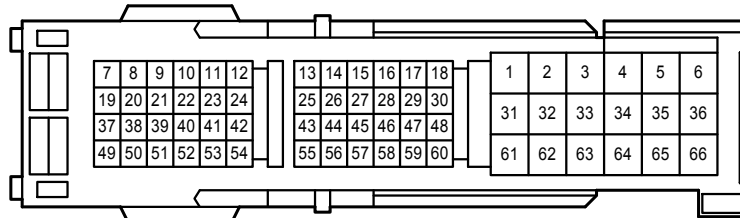

JQ1
Gray

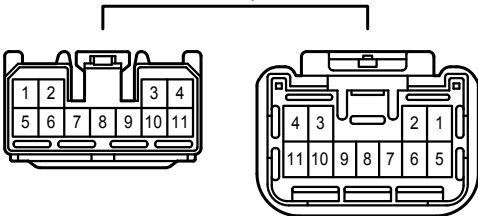

Climate Control Seat , Seat Heater <w/ Climate Control Seat>

JQ2
Gray

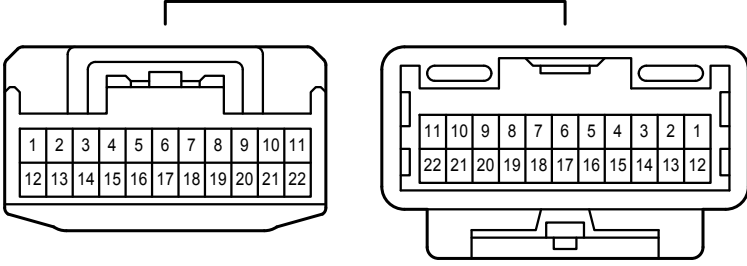

PJ1
Black

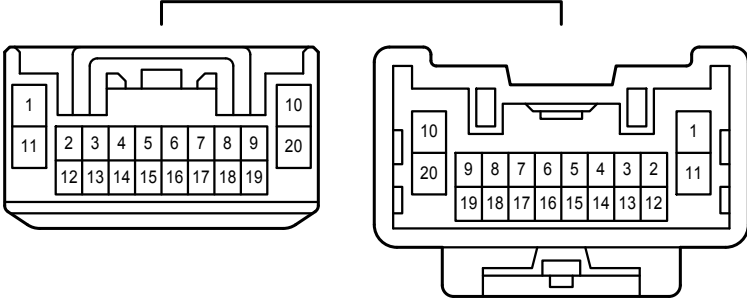

PZ1
White

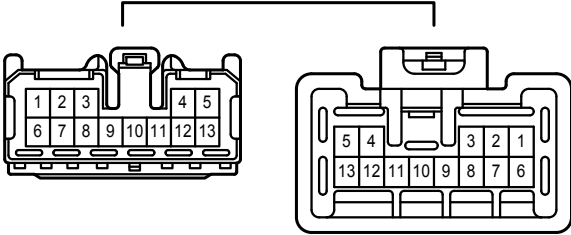

QY1
White

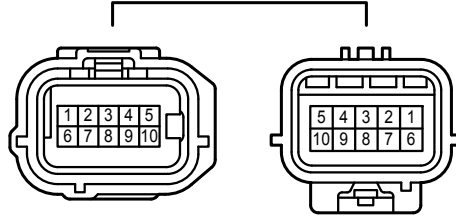

QY2
White

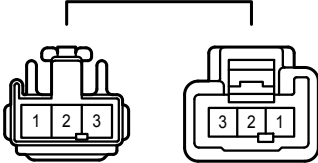

Combination Meter

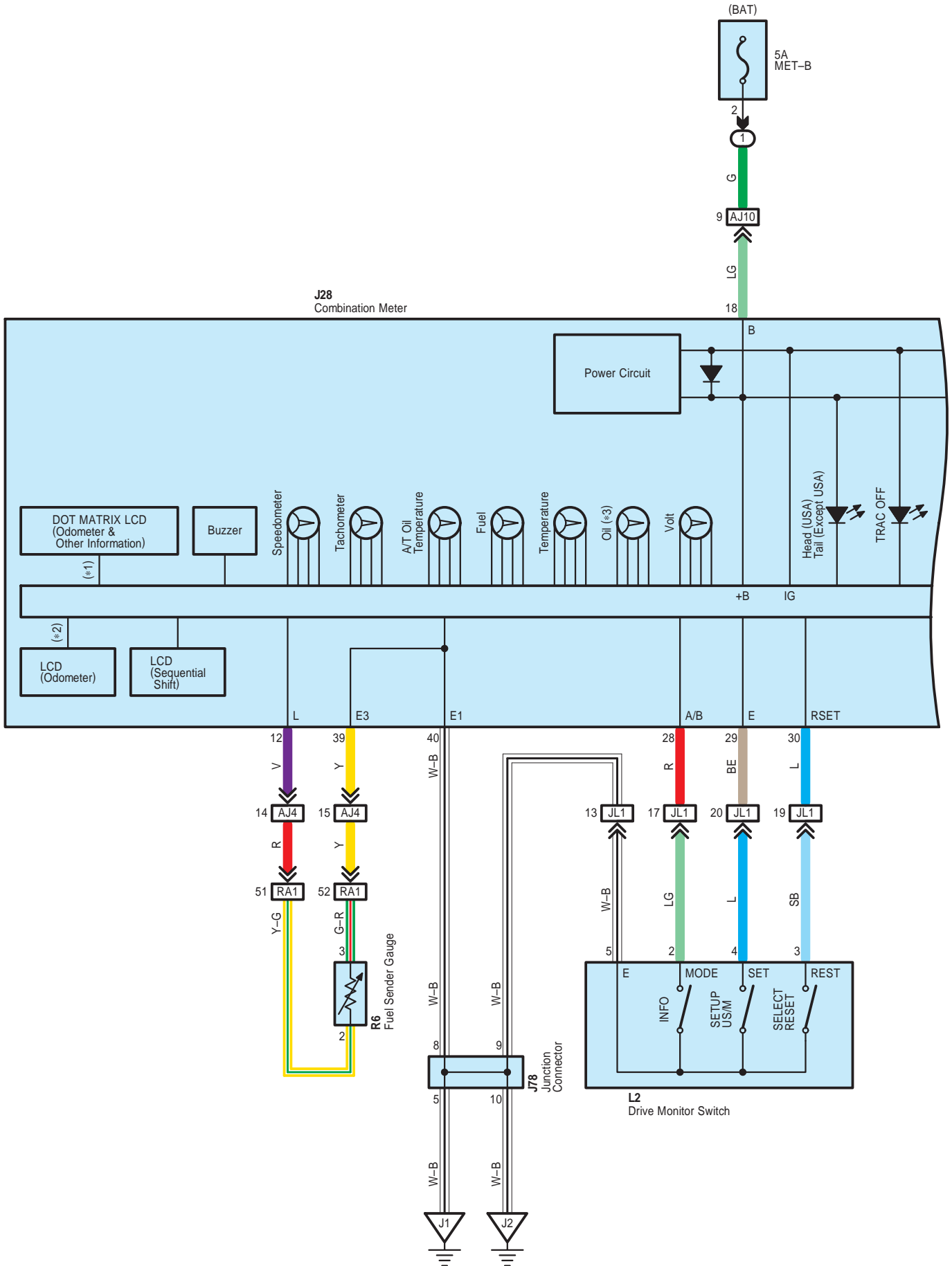

Combination Meter

- * 1 : Optitron Meter
- * 2 : Except Optitron Meter
- * 3 : w/ Oil Pressure Gauge
- * 4 : w/o Oil Pressure Gauge
- * 7 : 1GR-FE
- *10 : 3UR-FE, 3UR-FBE, 1UR-FE

J28
Combination Meter

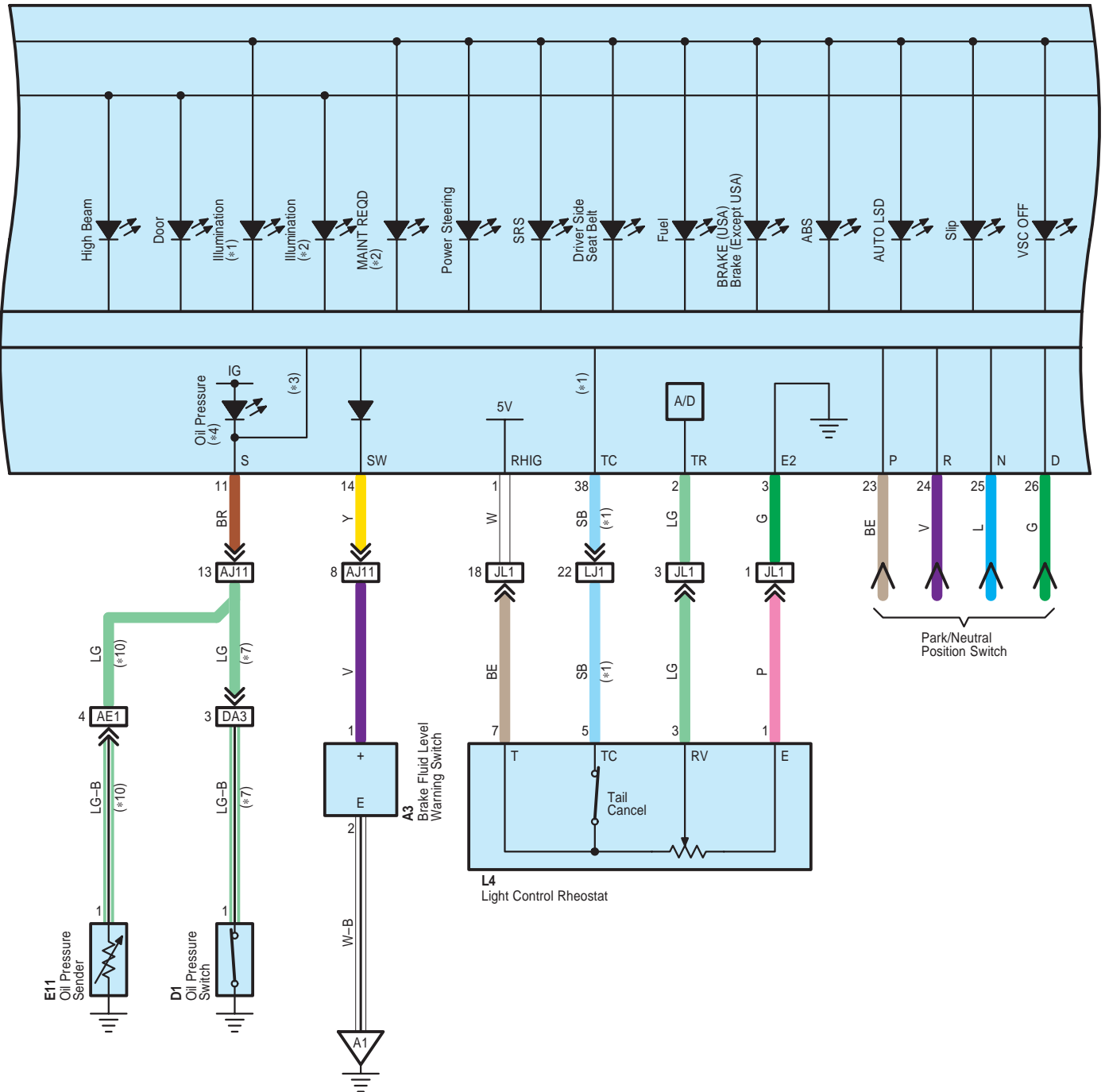

Combination Meter

- * 1 : Optitron Meter
- * 2 : Except Optitron Meter
- *12 : Before Nov. 2009 Production
- *13 : From Nov. 2009 Production

J28
Combination Meter

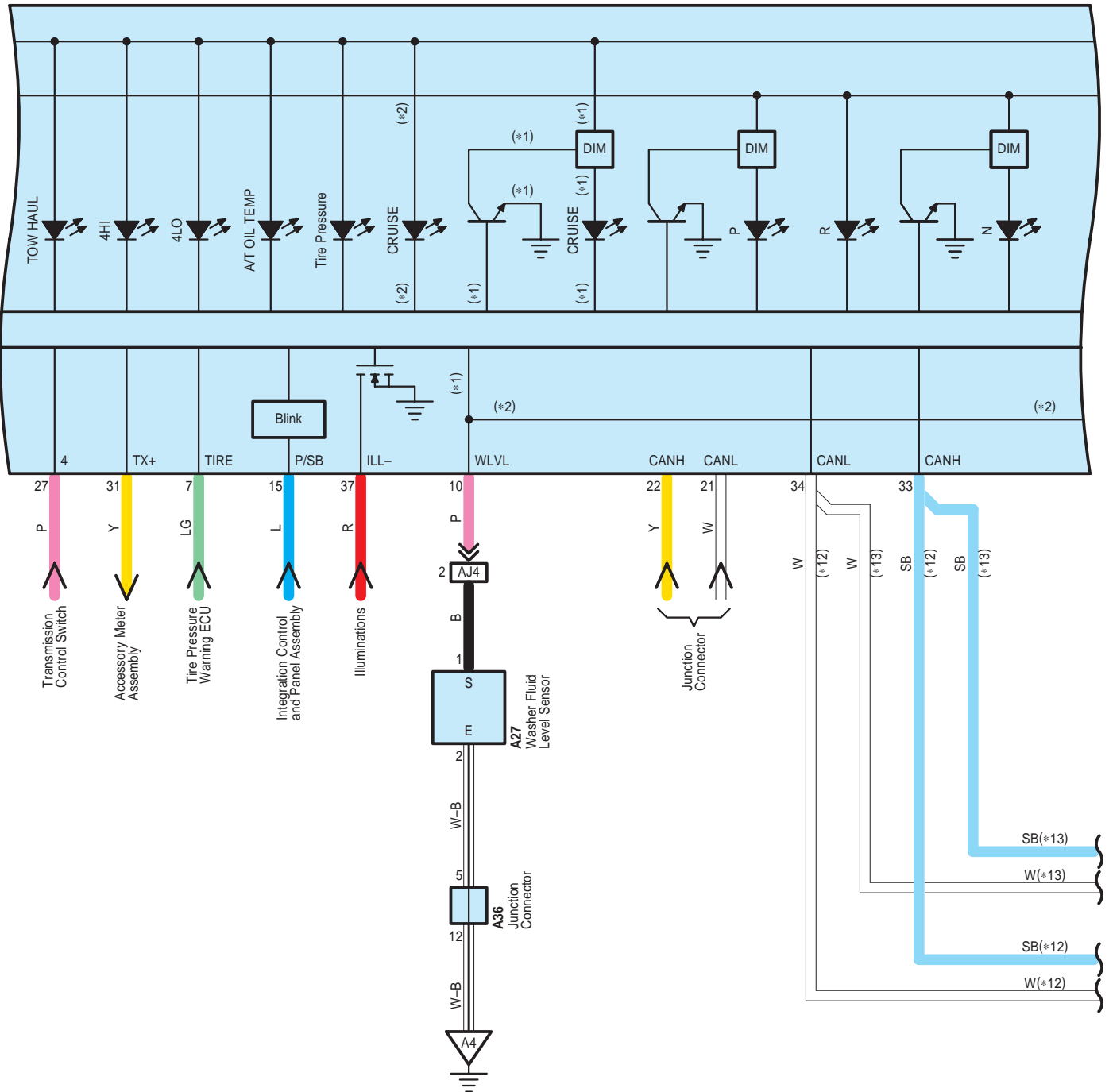

Combination Meter

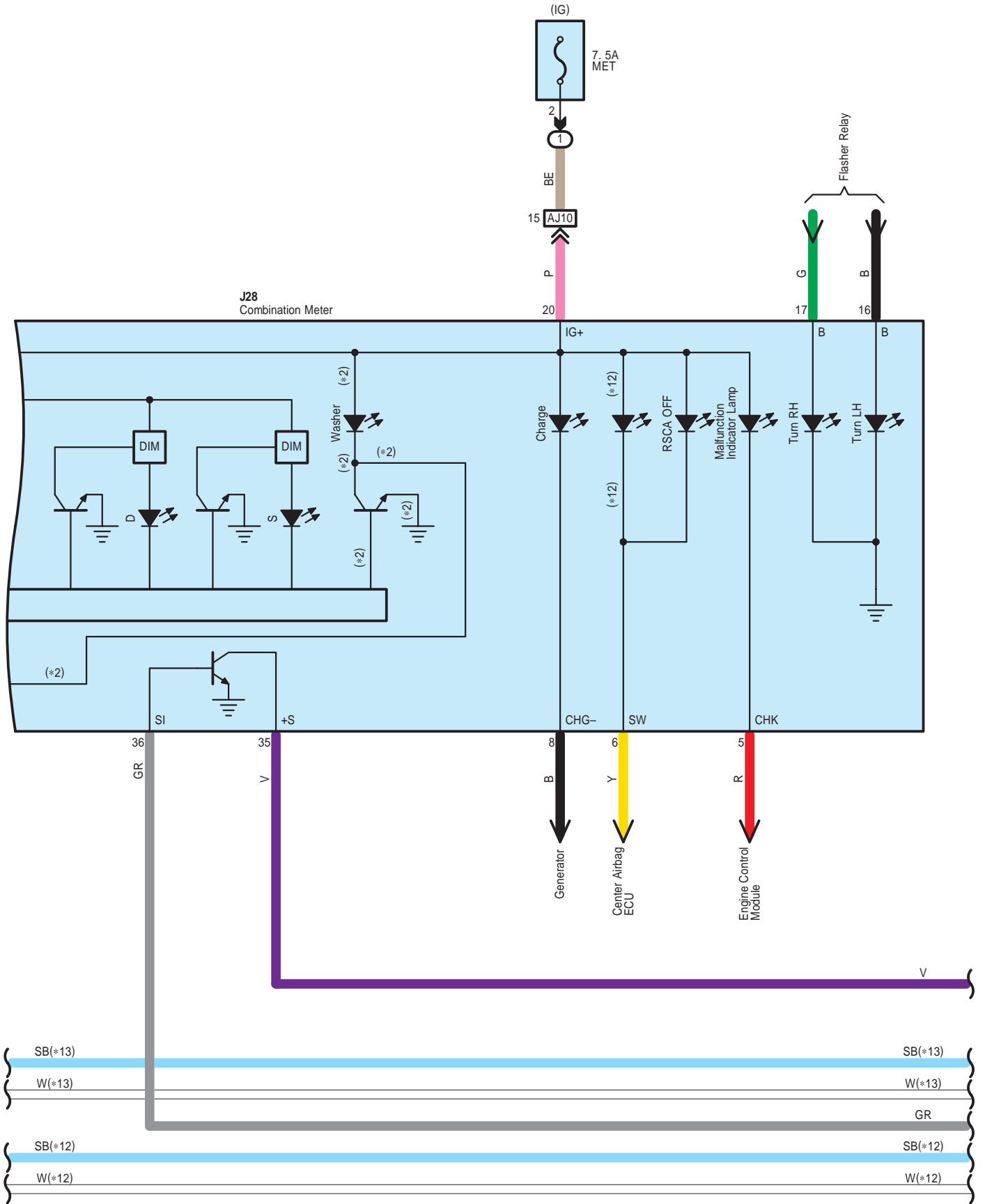

Combination Meter

- * 5 : w/o Navigation System
- * 6 : 1UR-FE
- * 7 : 1GR-FE
- * 8 : Built-in Type Amplifier w/ Navigation System
- * 9 : Separate Type Amplifier w/ Navigation System
- * 10 : 3UR-FE, 3UR-FBE, 1UR-FE
- * 11 : 3UR-FE, 3UR-FBE
- * 12 : Before Nov. 2009 Production
- * 13 : From Nov. 2009 Production

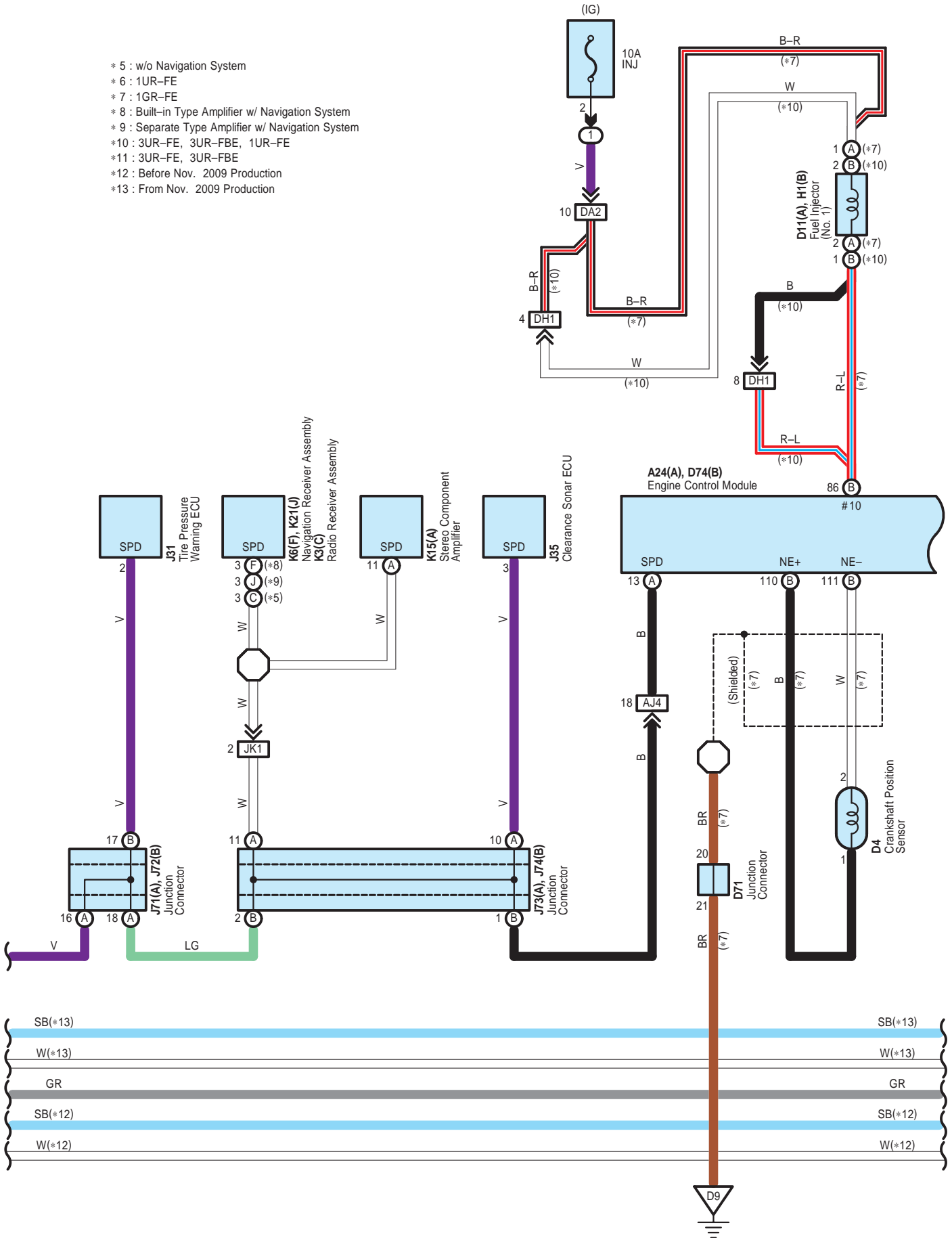

Combination Meter

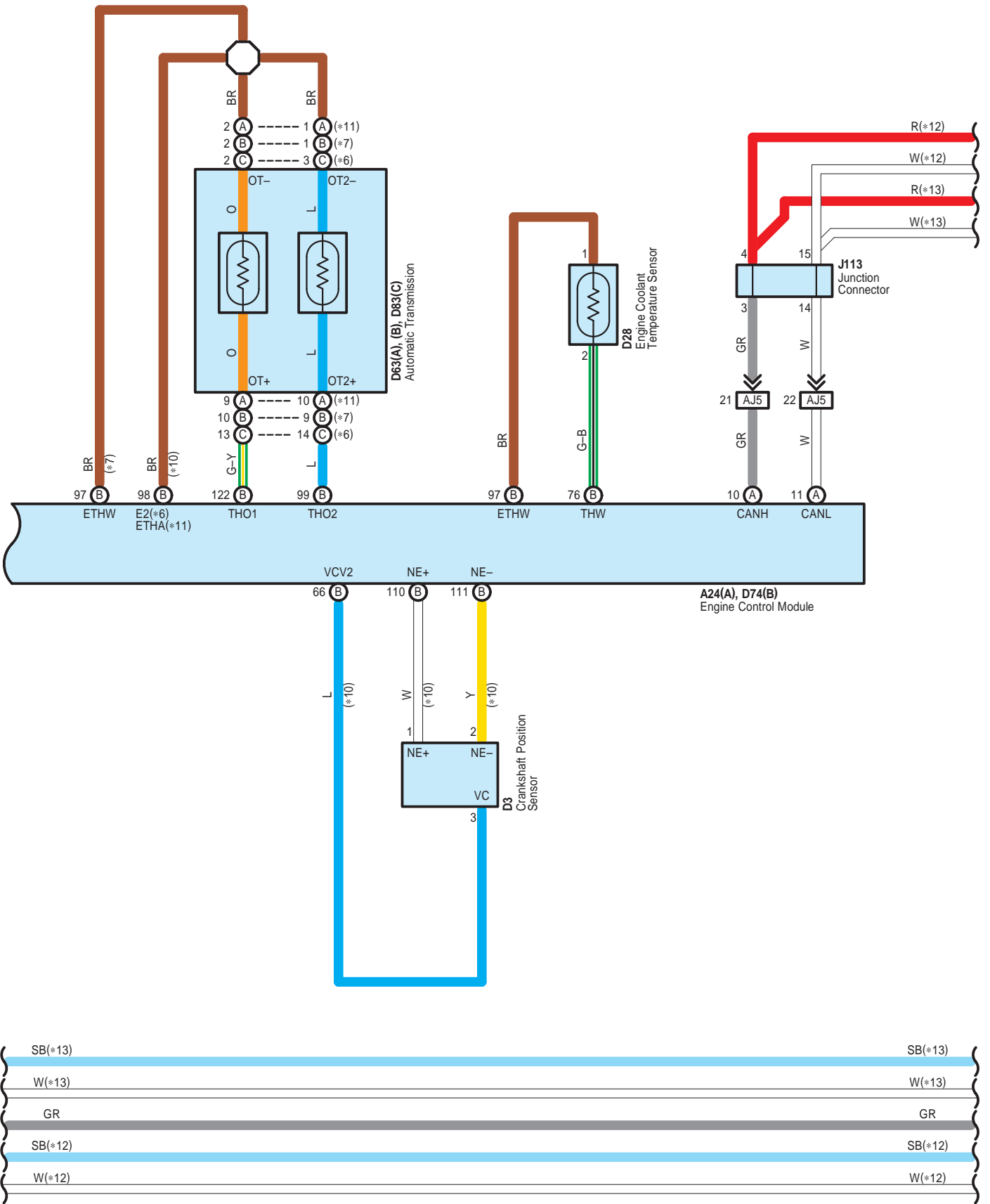

Combination Meter

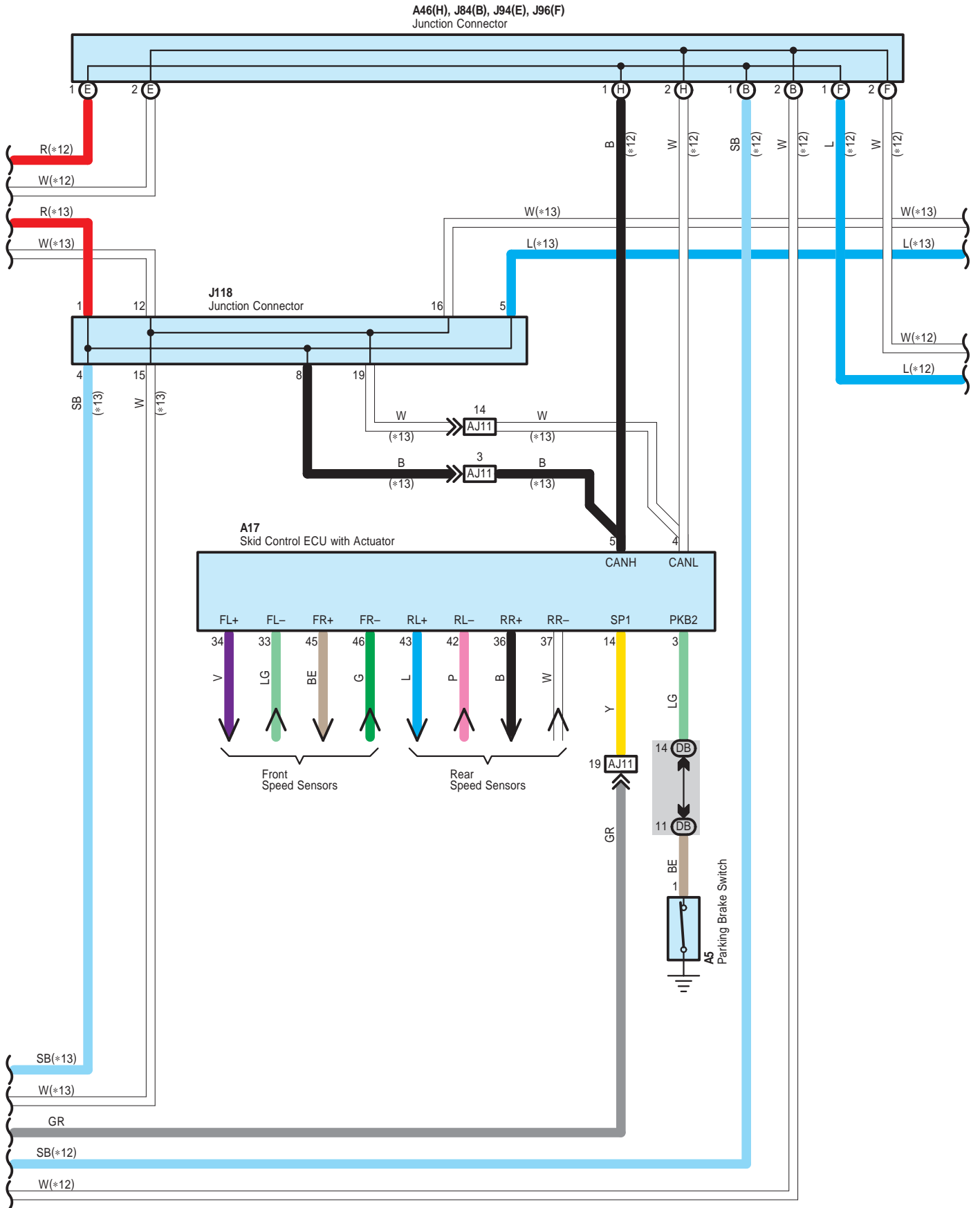

Combination Meter

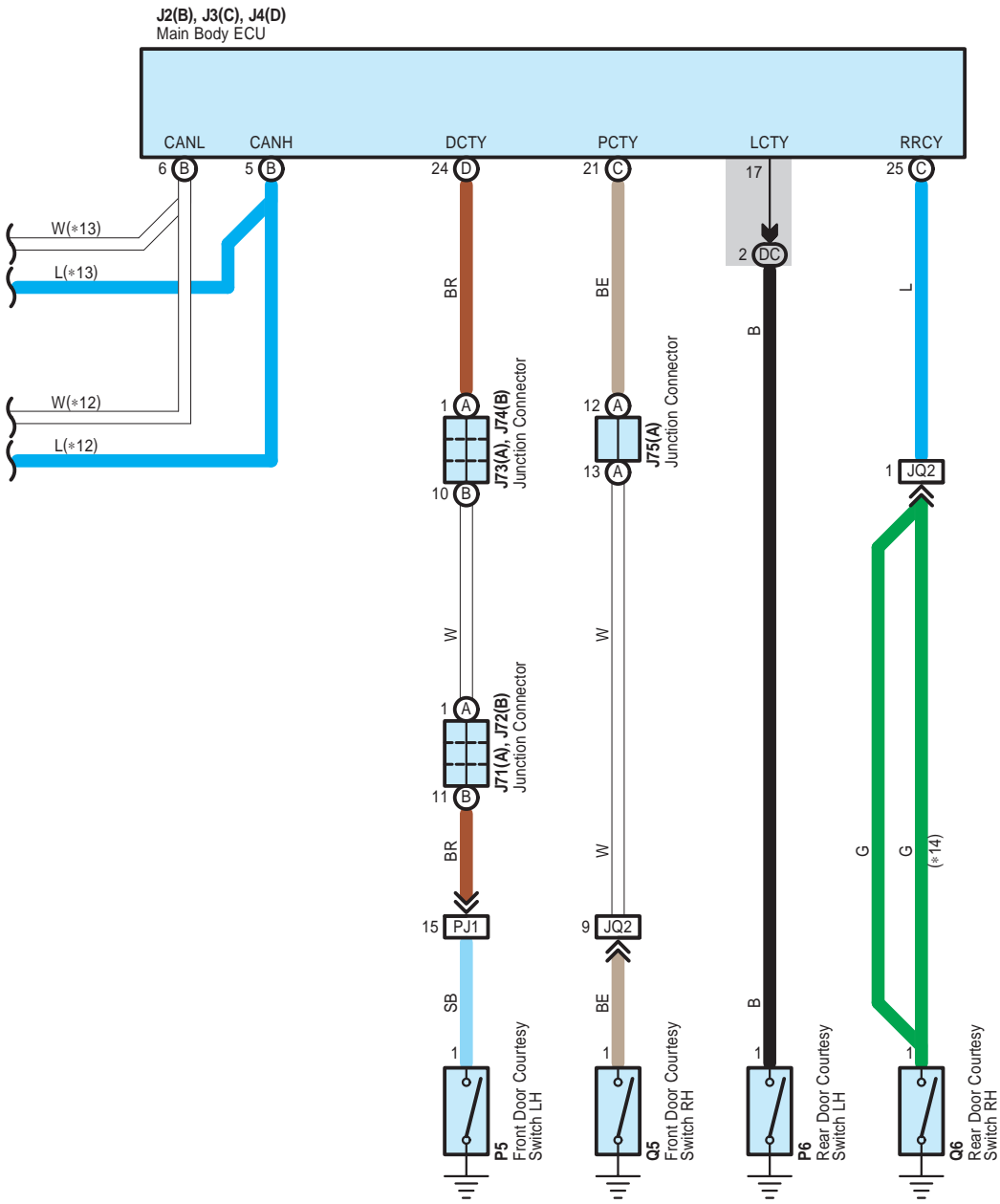

*12 : Before Nov. 2009 Production
 *13 : From Nov. 2009 Production
 *14 : w/ Rear Door Courtesy Light

Combination Meter

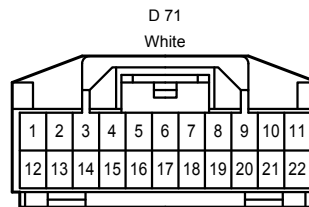
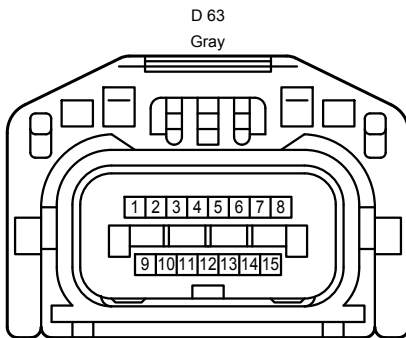
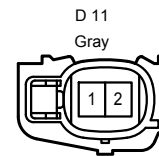
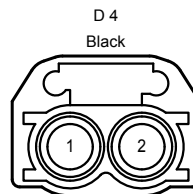
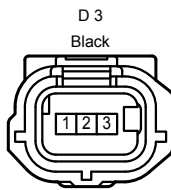
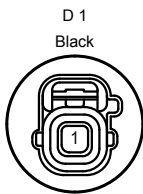
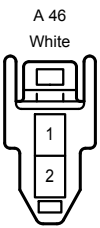
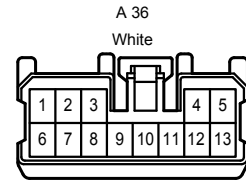
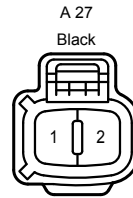
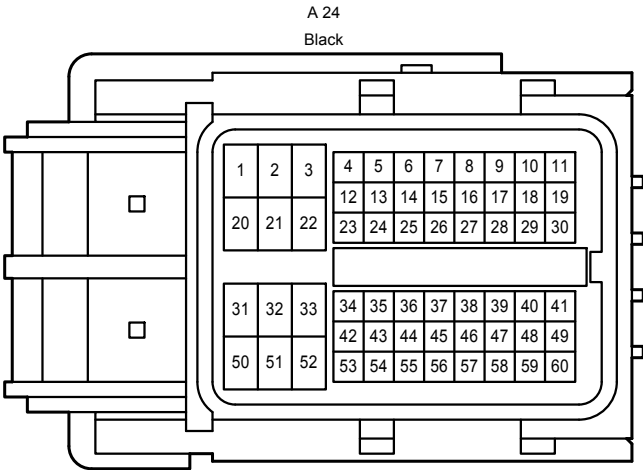
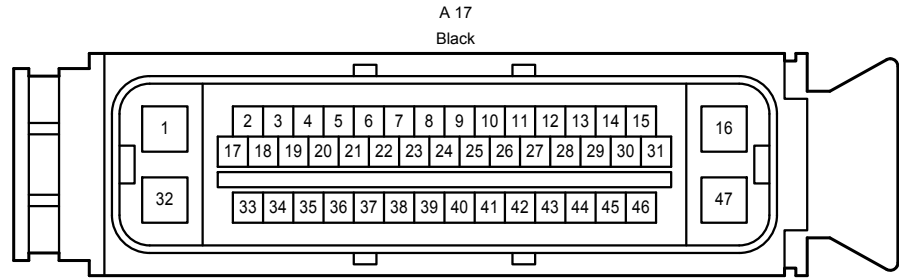

Combination Meter

D 74
Black

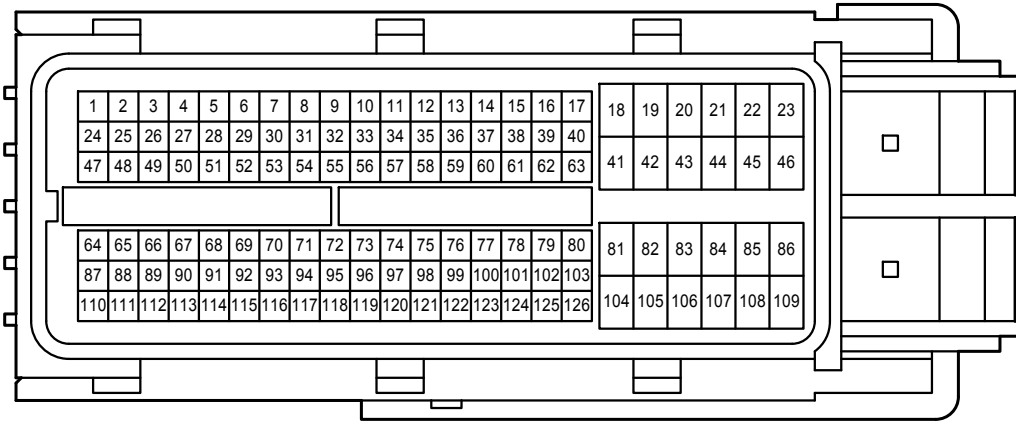

D 83

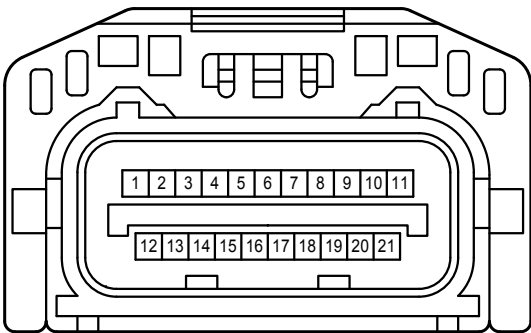

E 11
Black



H 1
Black

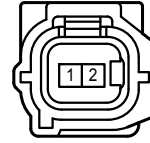

J 2
White

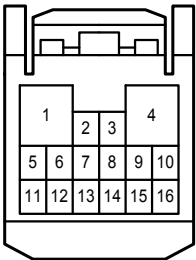

J 3
White

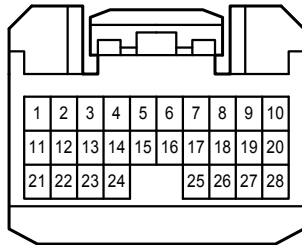

J 4
White

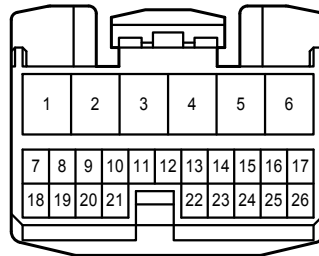

J 28
White

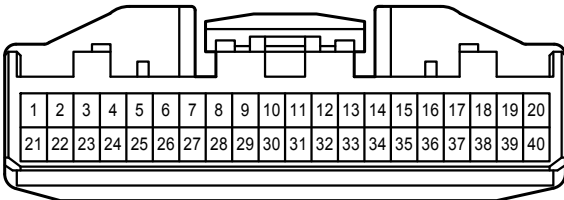

J 31
White

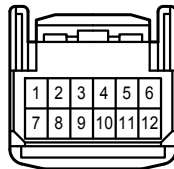

J 35
White

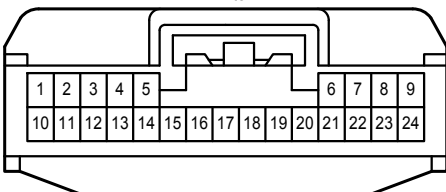

J 71
Black

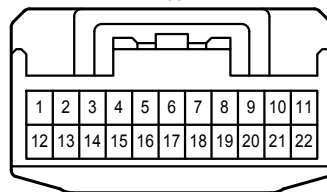

Combination Meter

J 72
Black

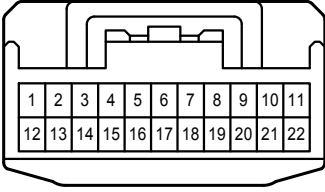

J 73
Black

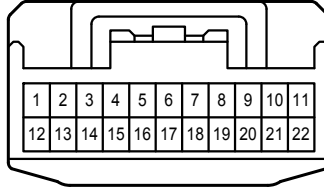

J 74
Black

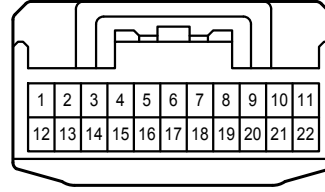

J 75
White

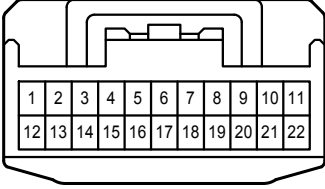

J 78
White

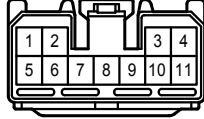

J 84
White

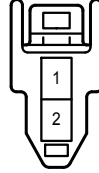

J 94
White

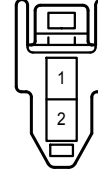

J 96
White

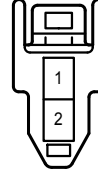

J113
Gray

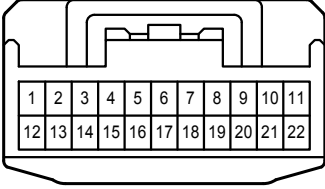

J118
Gray

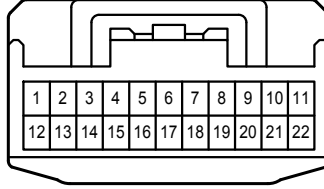

K 3
White

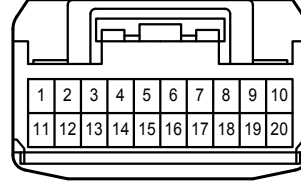

K 6
Gray

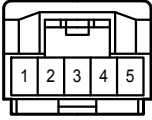

K 15
White

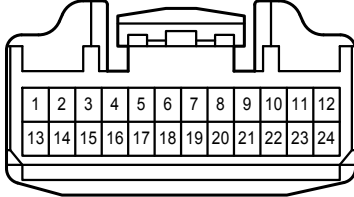

K 21
White

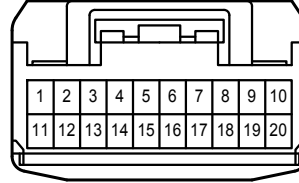

L 2
Black

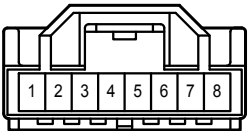

L 4
White

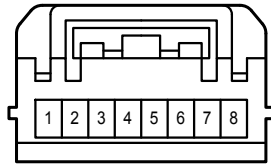

P 5
White



P 6
White



Q 5
White



Q 6
White



R 6
White



DB
White

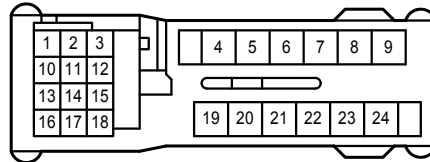

Combination Meter

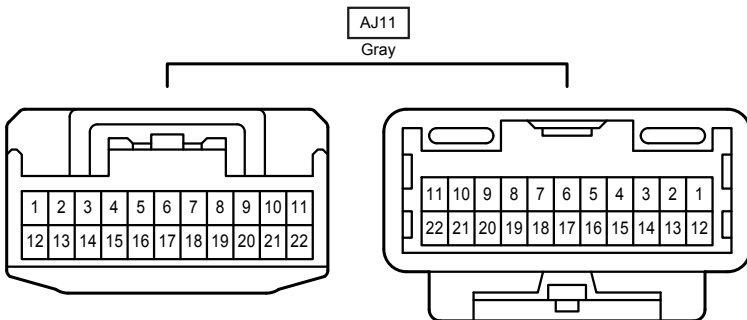
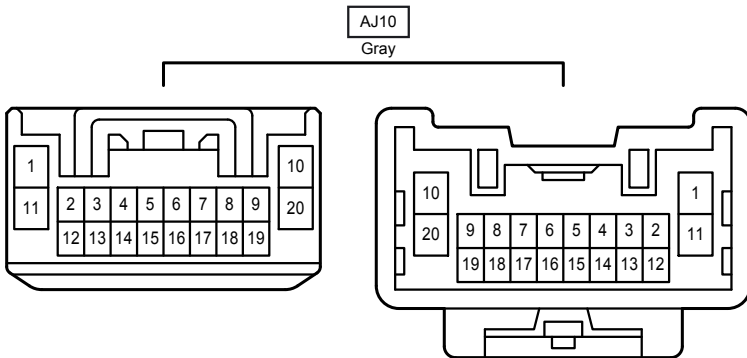
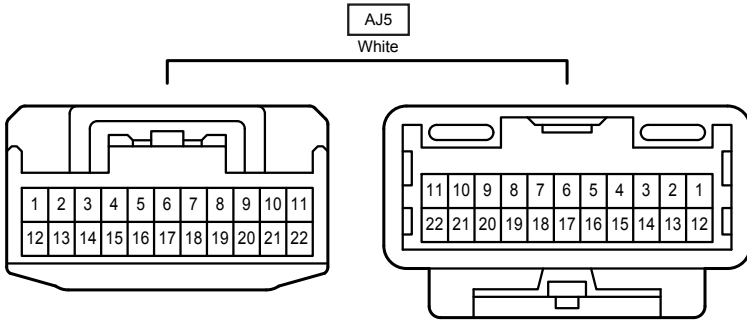
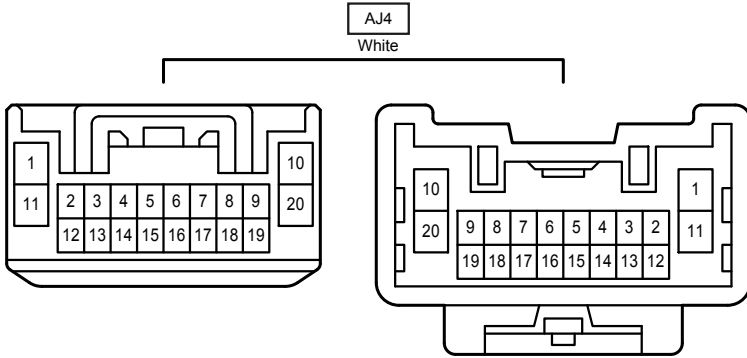
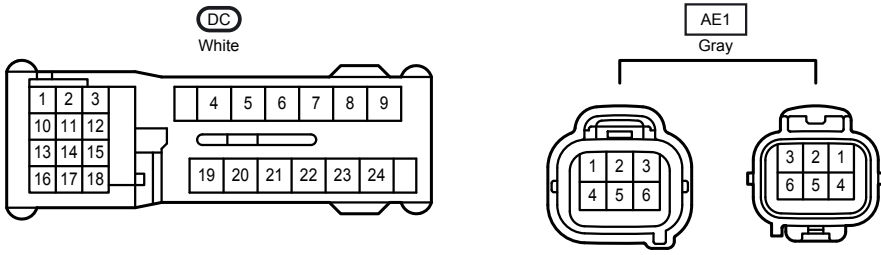

Combination Meter

DA2
White

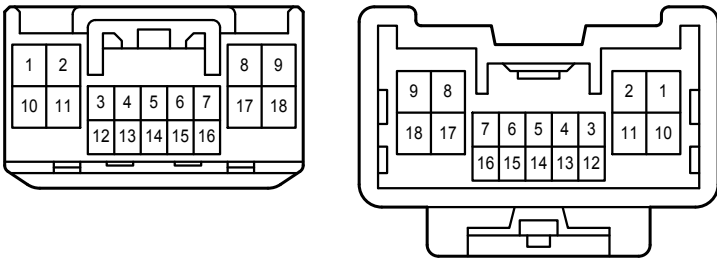

DA3
White

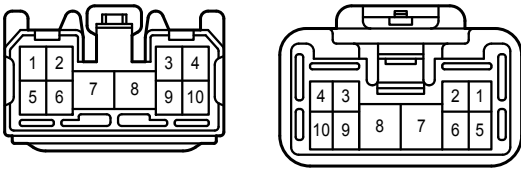

DH1
Gray

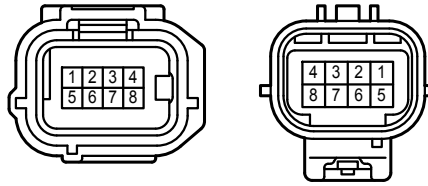

JK1
White

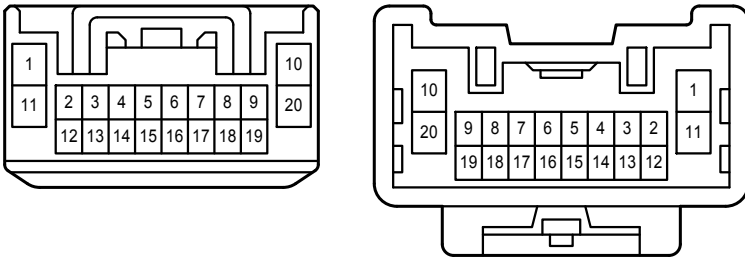

JL1
White

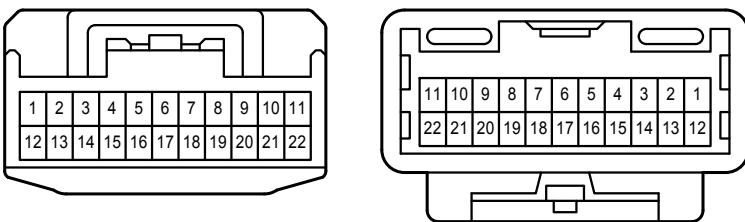

JQ2
Gray

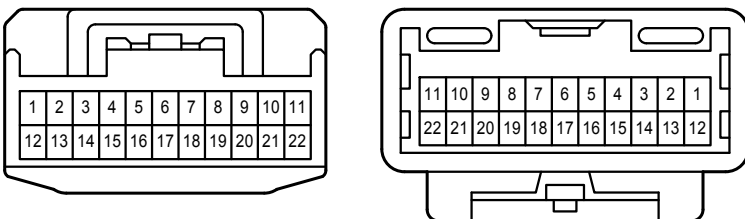

Combination Meter

PJ1
Black

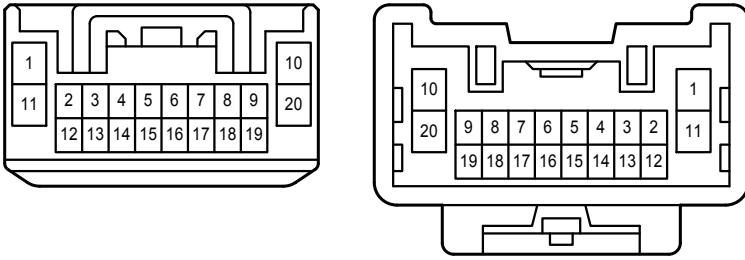

RA1
White

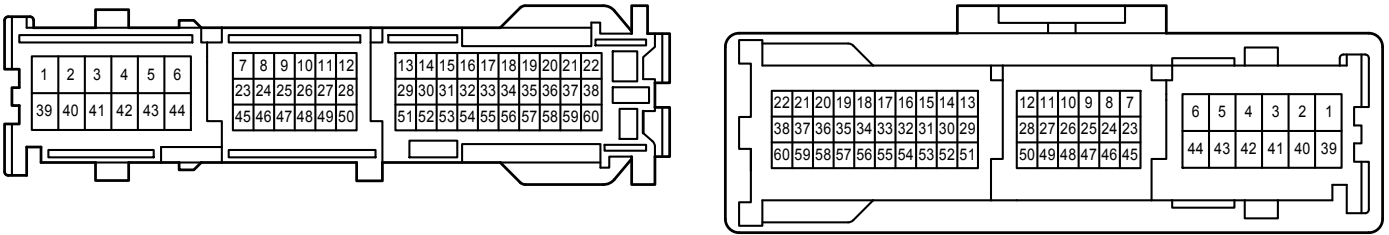

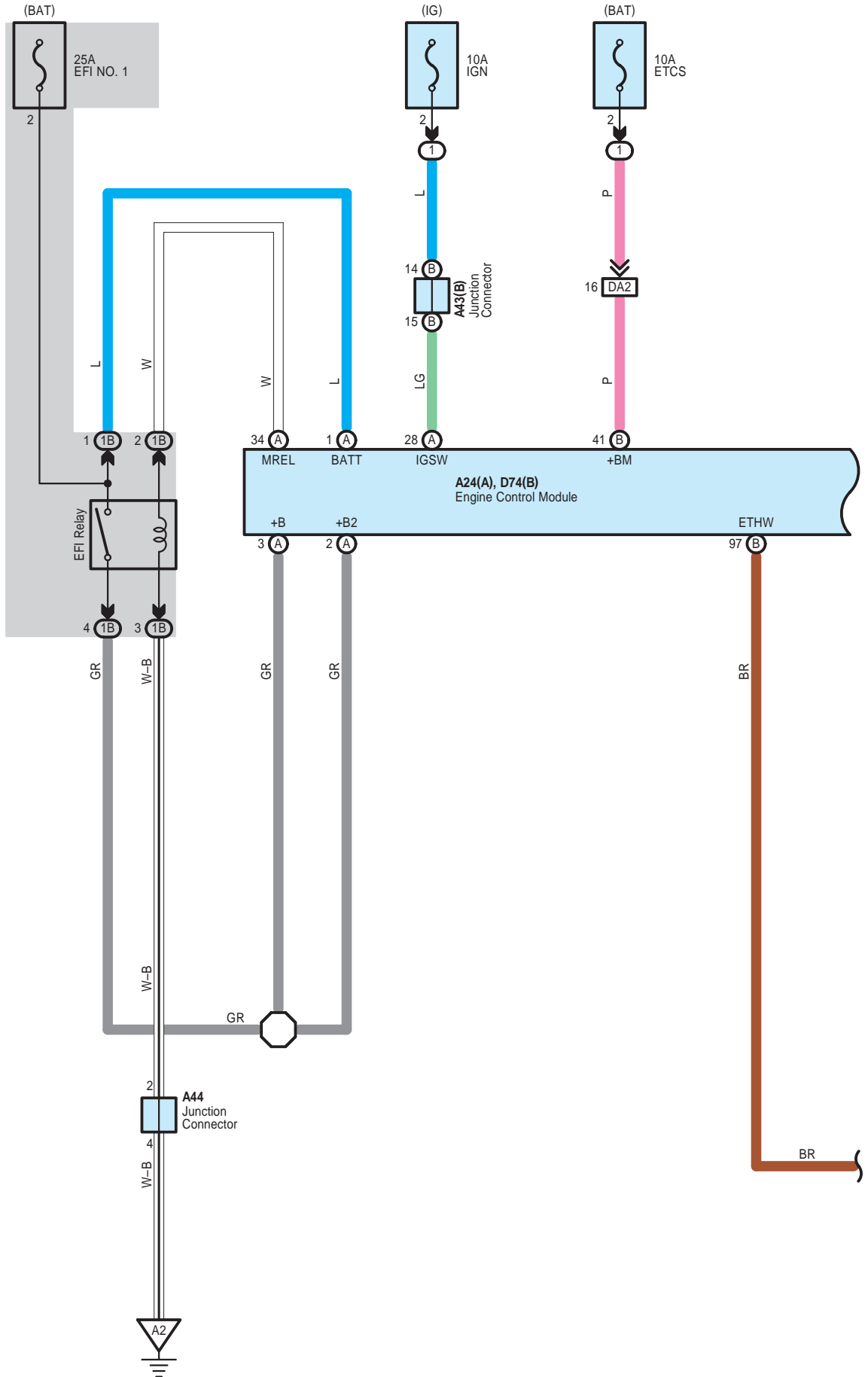

* 1 : Shielded

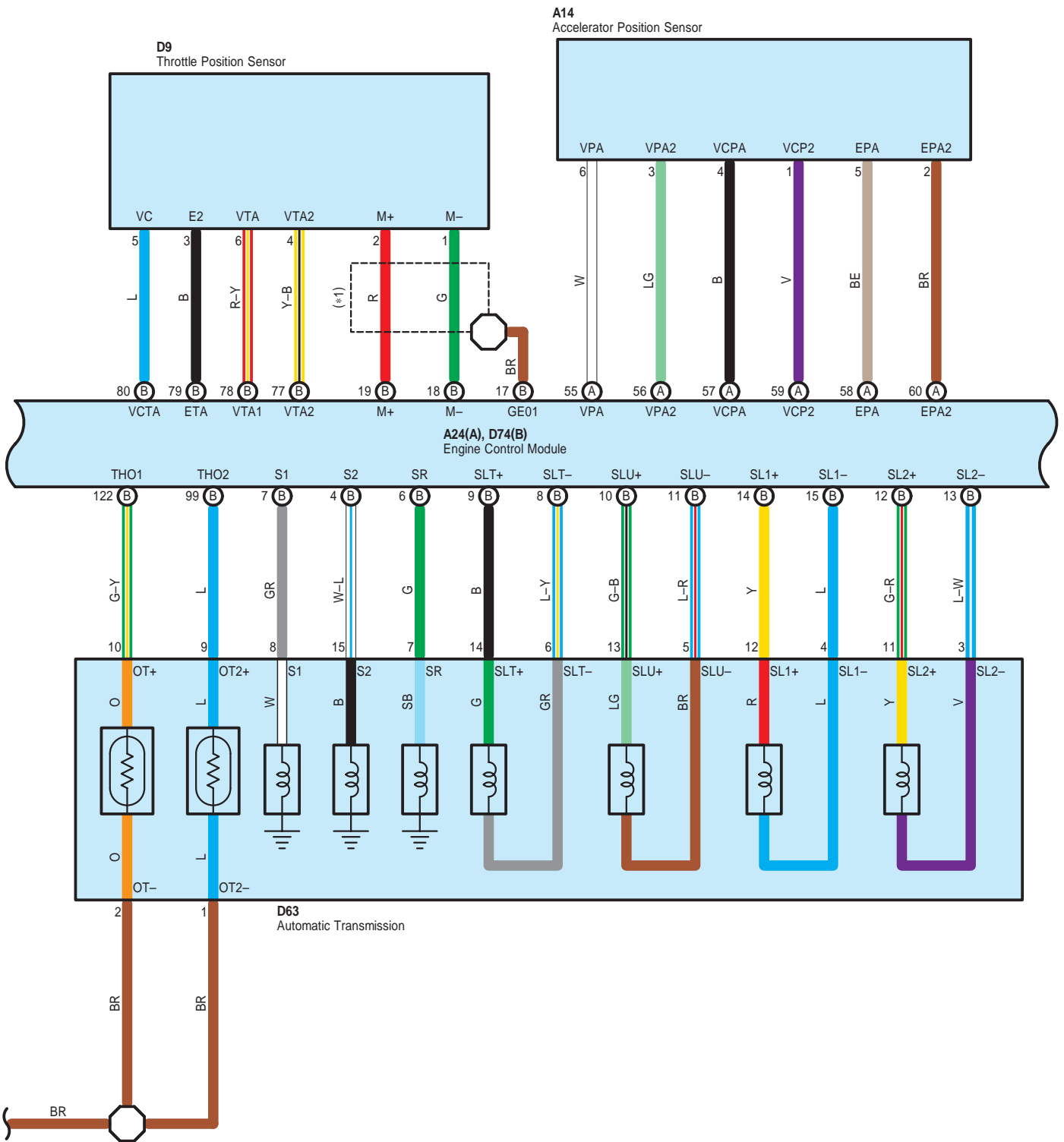

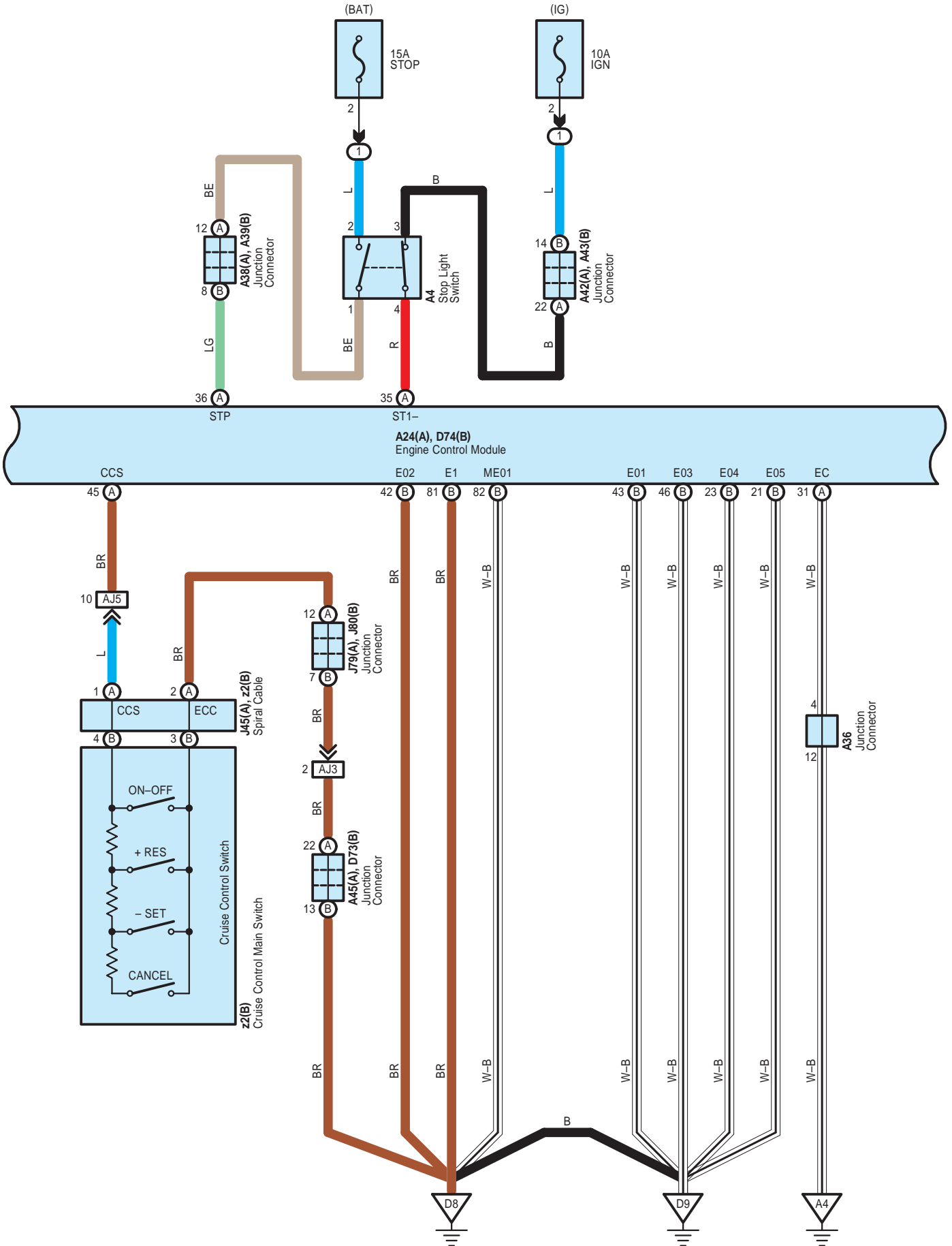

* 4 : Before Nov. 2009 Production
 * 5 : From Nov. 2009 Production

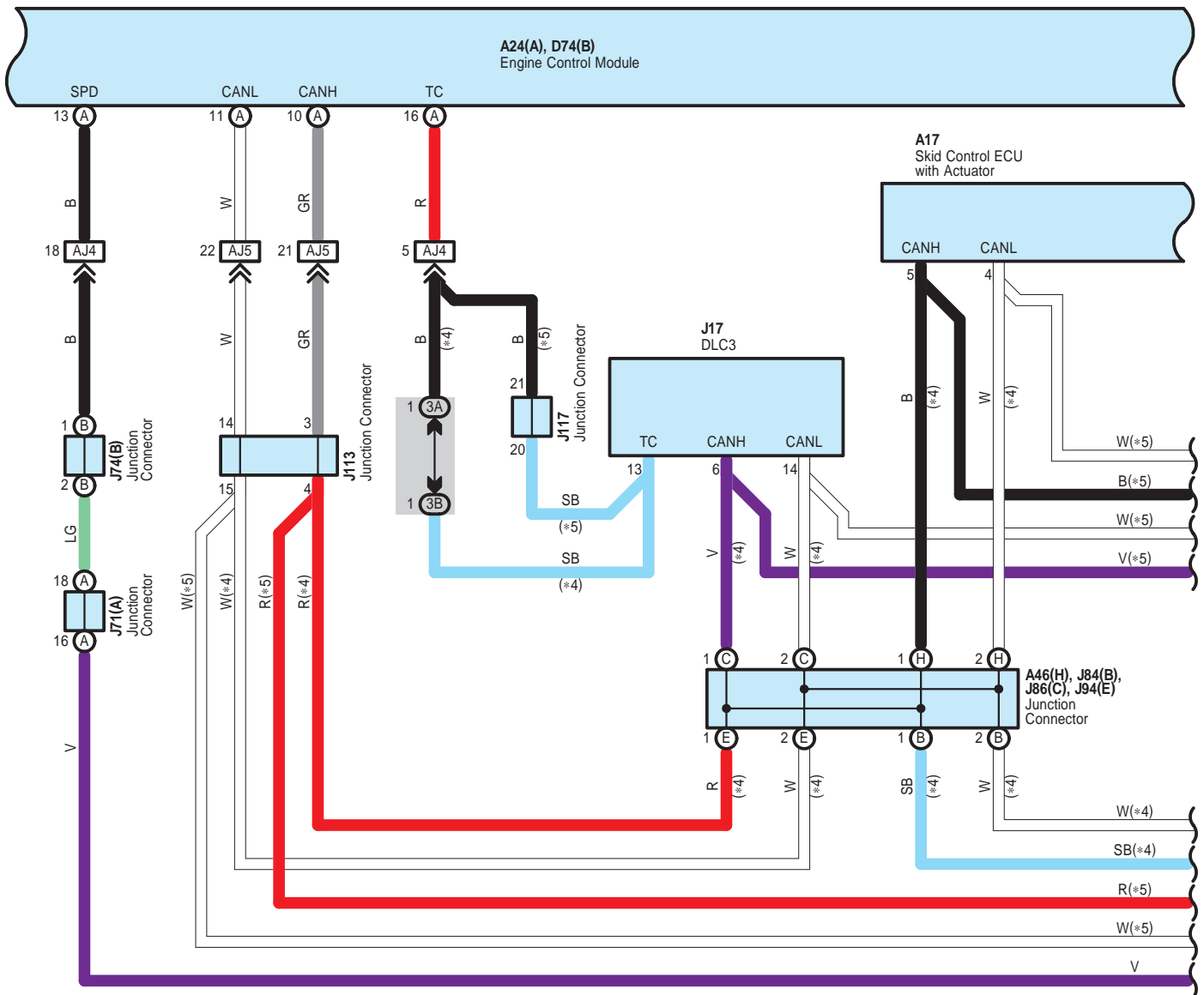

- * 2 : Floor Shift
- * 3 : Column Shift
- * 4 : Before Nov. 2009 Production
- * 5 : From Nov. 2009 Production

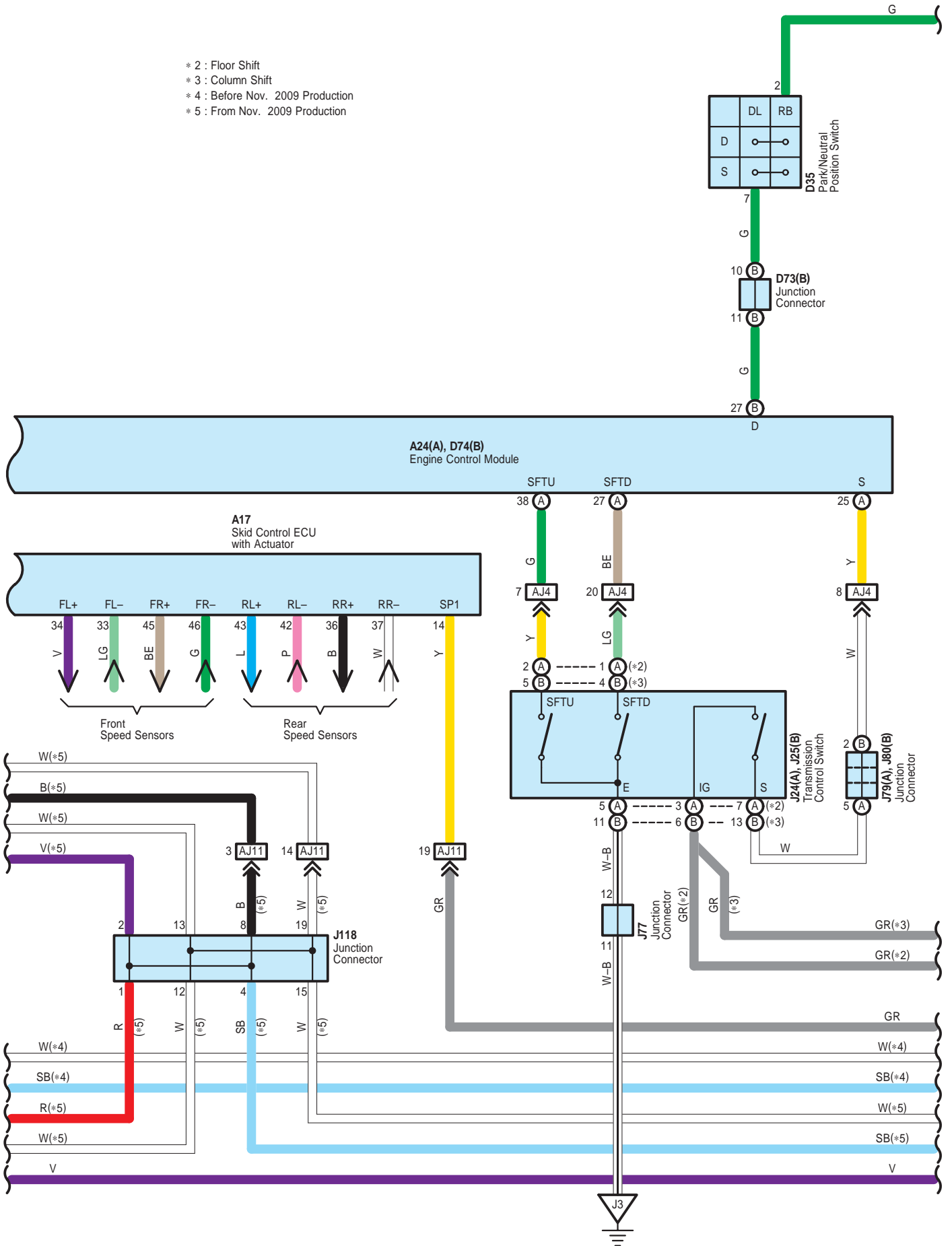

Cruise Control <1GR-FE>

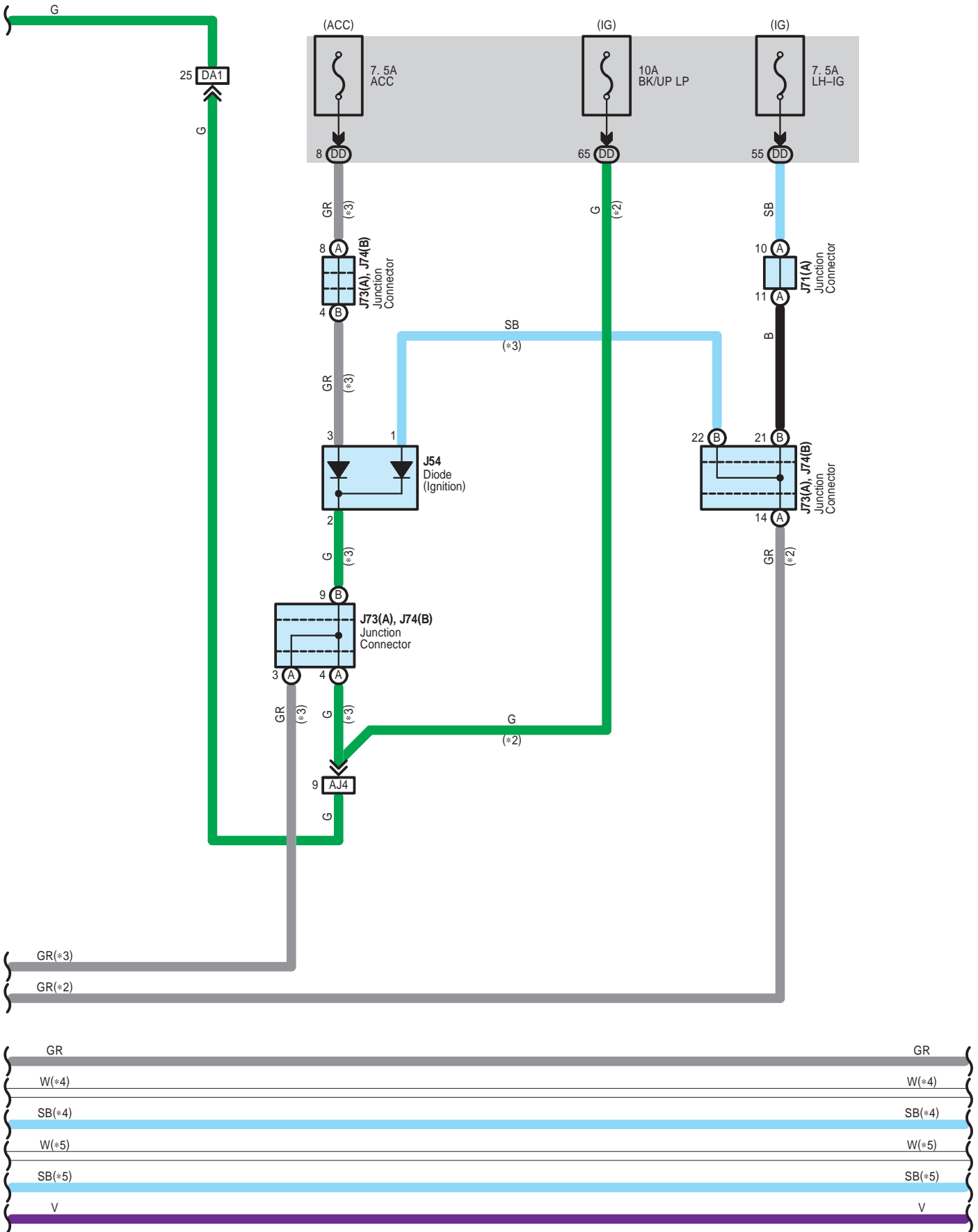

Cruise Control <1GR-FE>

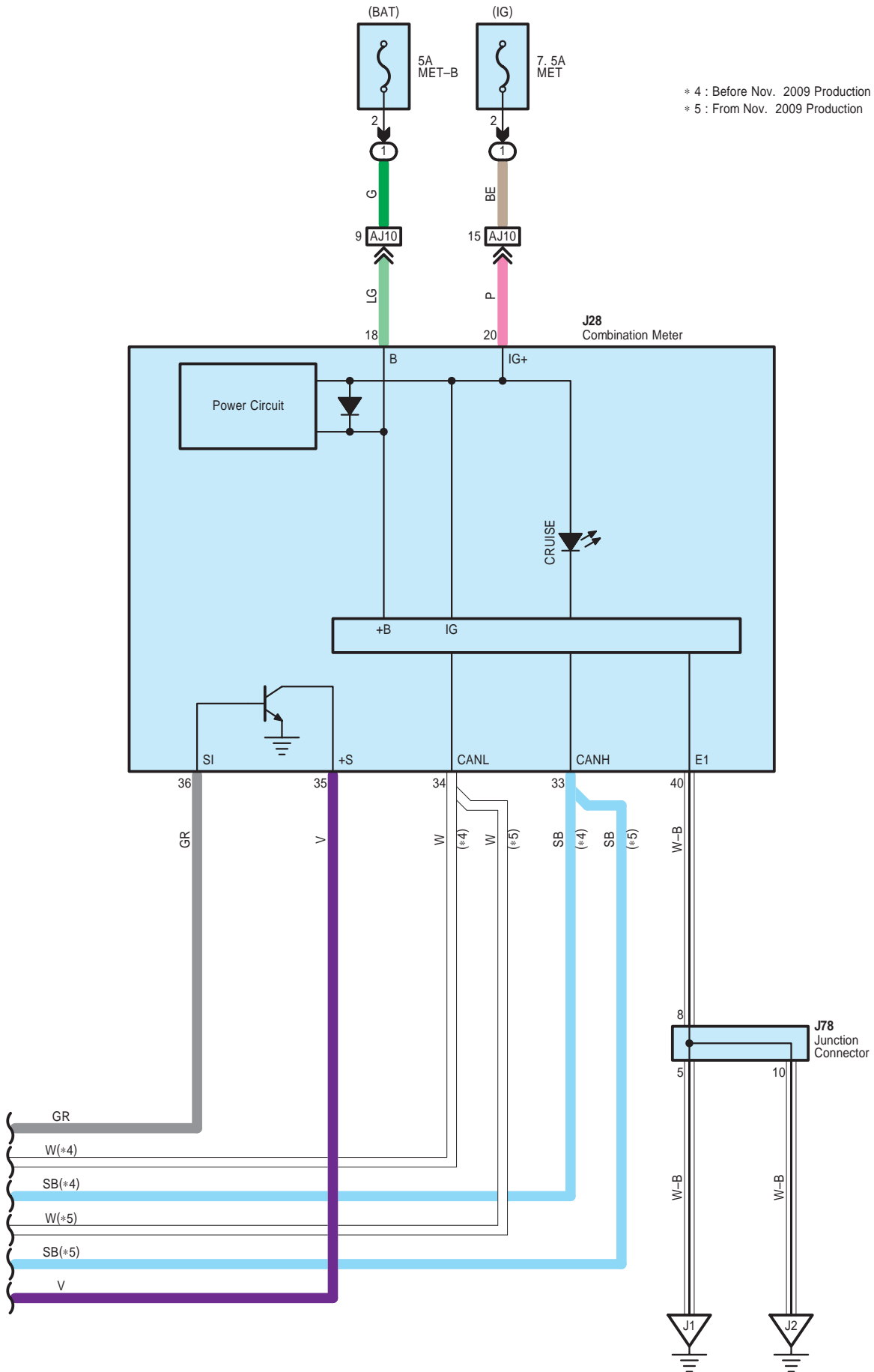

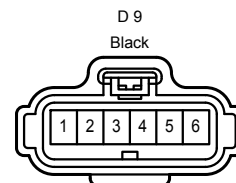
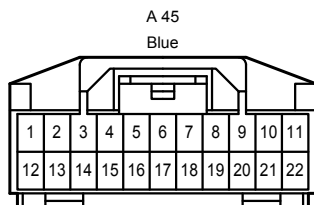
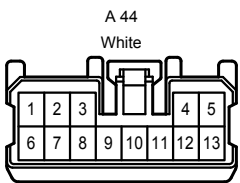
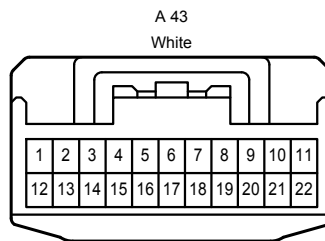
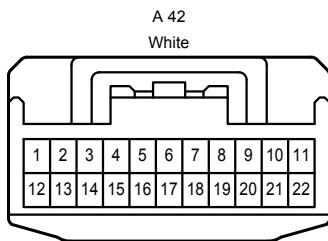
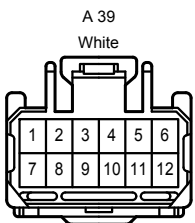
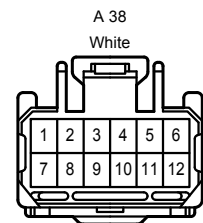
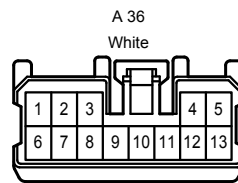
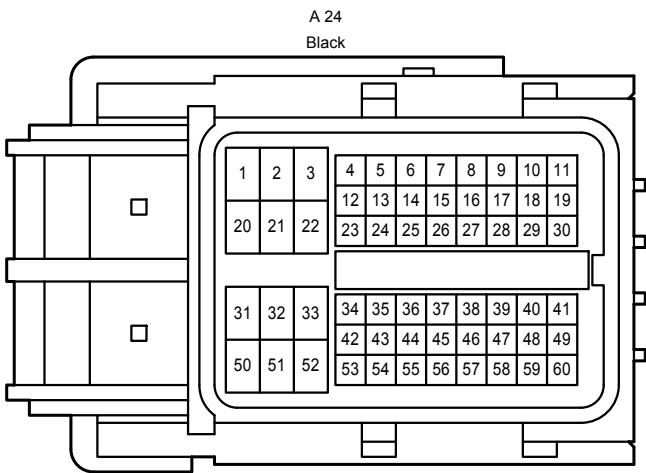
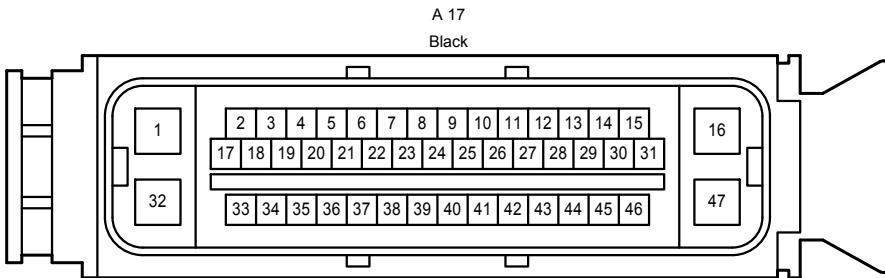
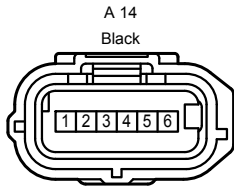
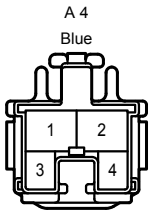

Cruise Control <1GR-FE>

D 35
Gray

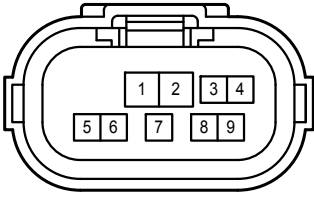

D 63
Gray

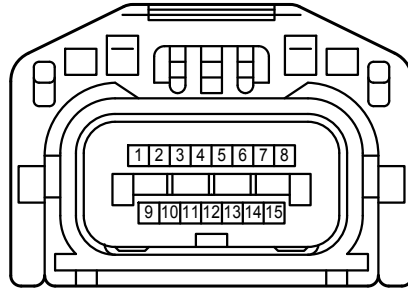

D 73
Blue

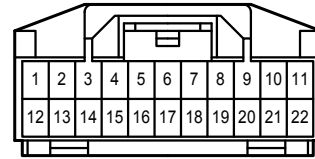

D 74
Black

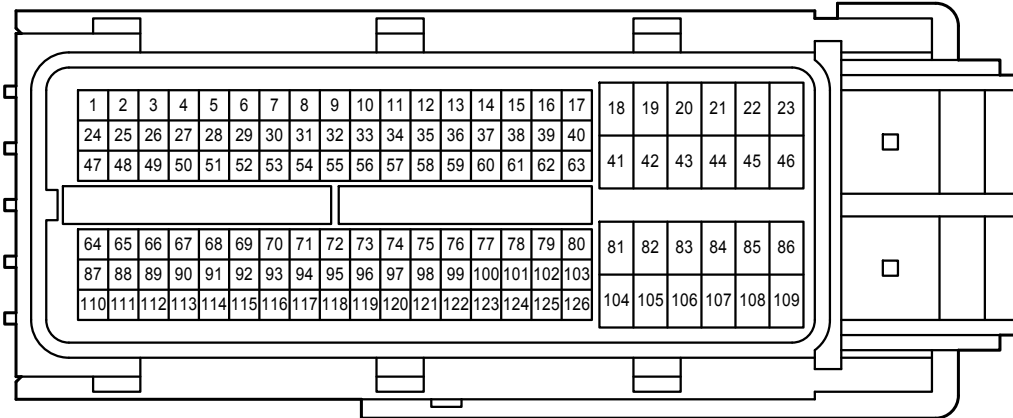

J 17
White

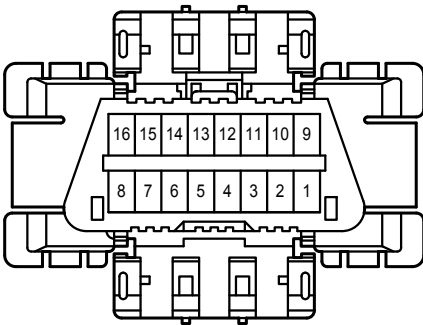

J 24
White

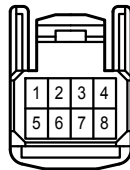

J 25
White

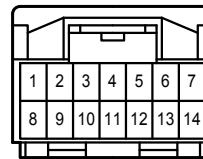

J 28
White

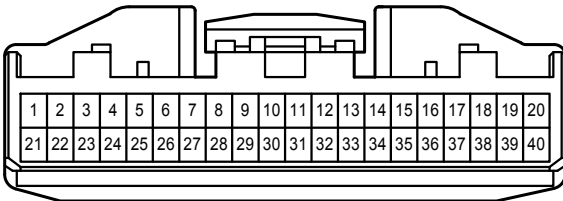

J 45
Black

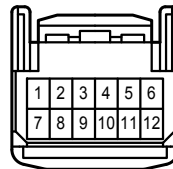

J 54
Orange



J 71
Black

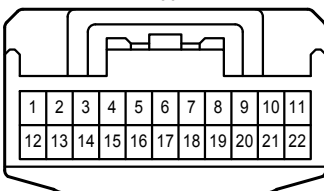

J 73
Black

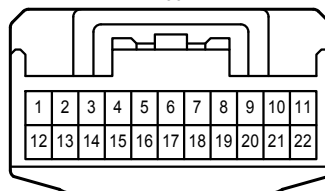

J 74
Black

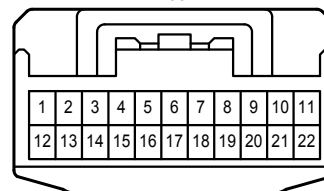

J 77
Gray

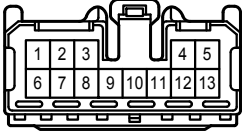

J 78
White

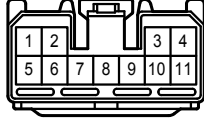

J 79
White

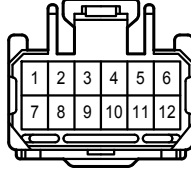

J 80
White

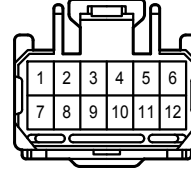

J 84
White

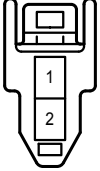

J 86
White

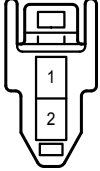

J 94
White

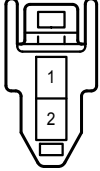

J113
Gray

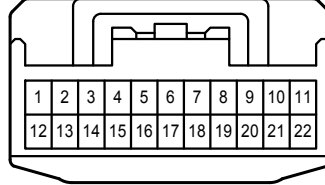

J117
Black

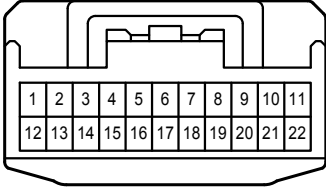

J118
Gray

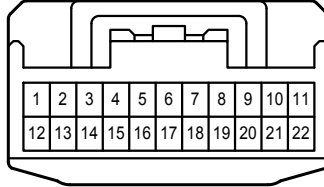

z 2
Black

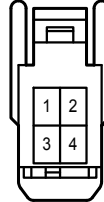

1B
White

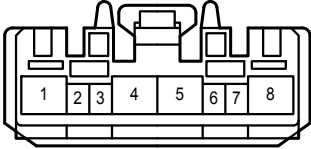

3A
Black

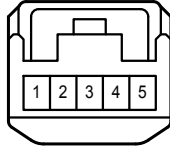

3B
White

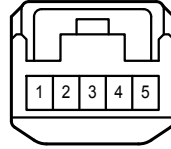

DD
White

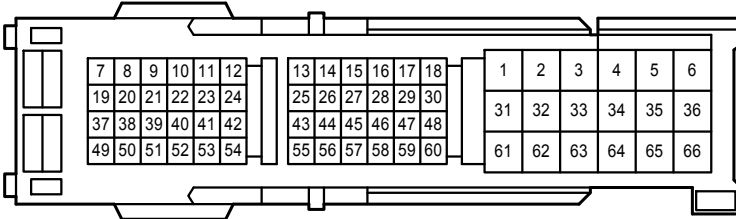

AJ3
White

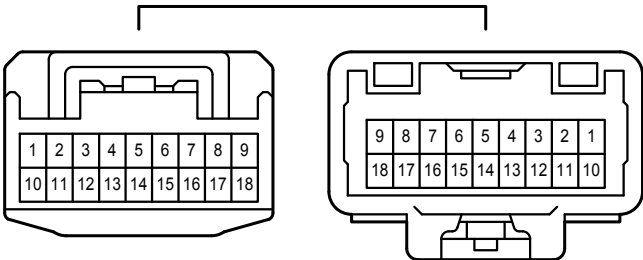

AJ4
White

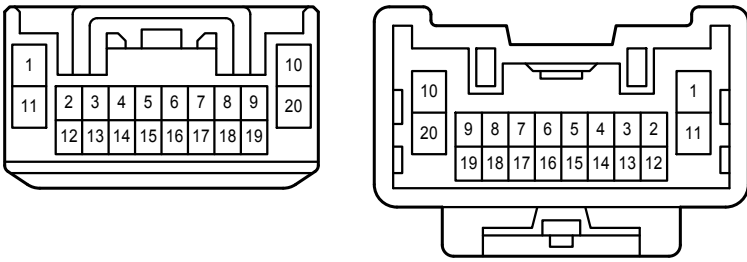

AJ5
White

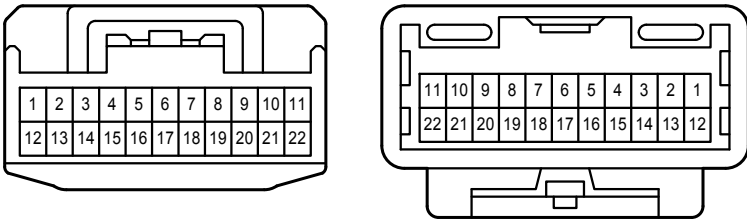

AJ10
Gray

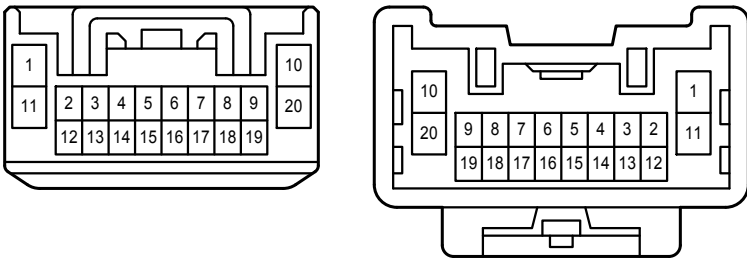

AJ11
Gray

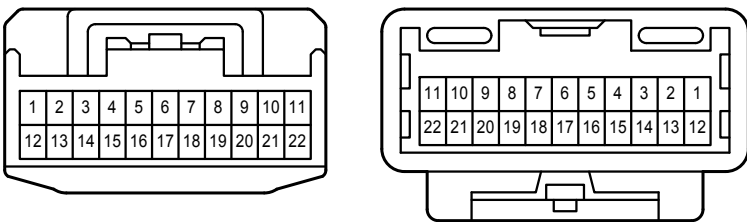

DA1
White

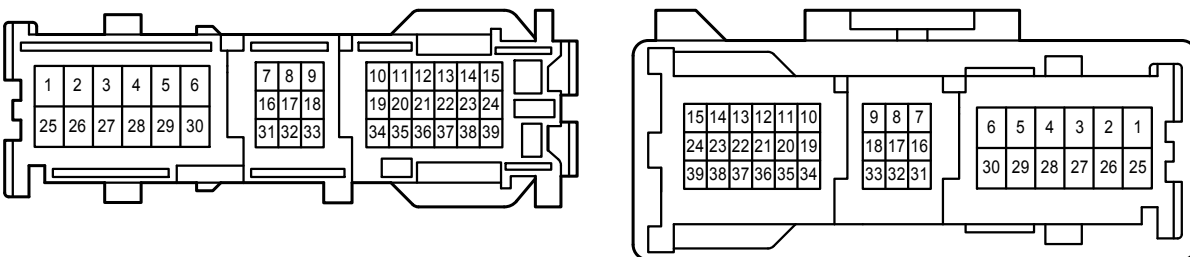

DA2
White

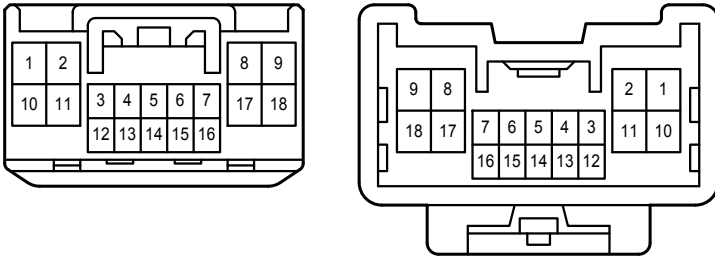

* 1 : Shielded

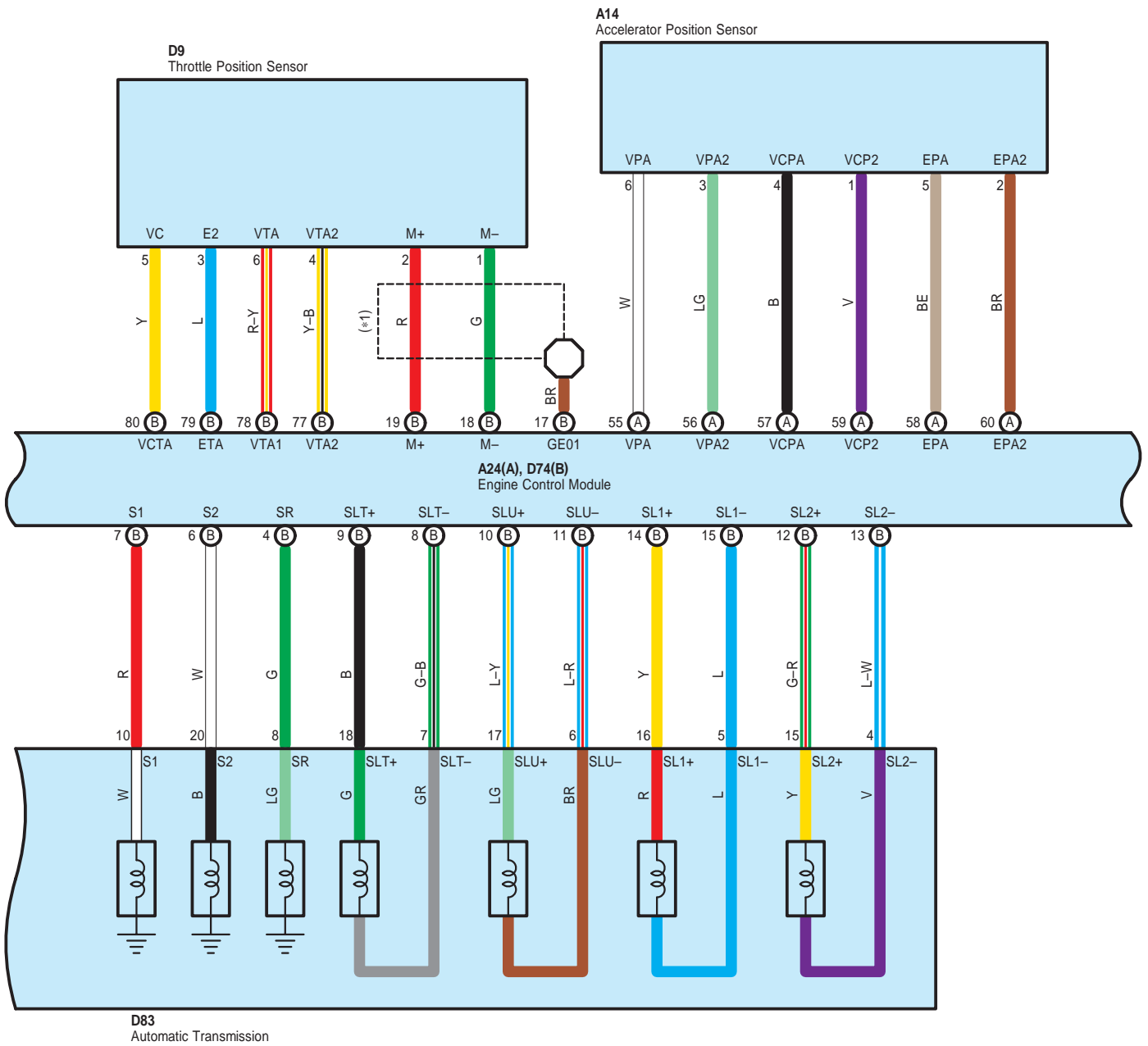

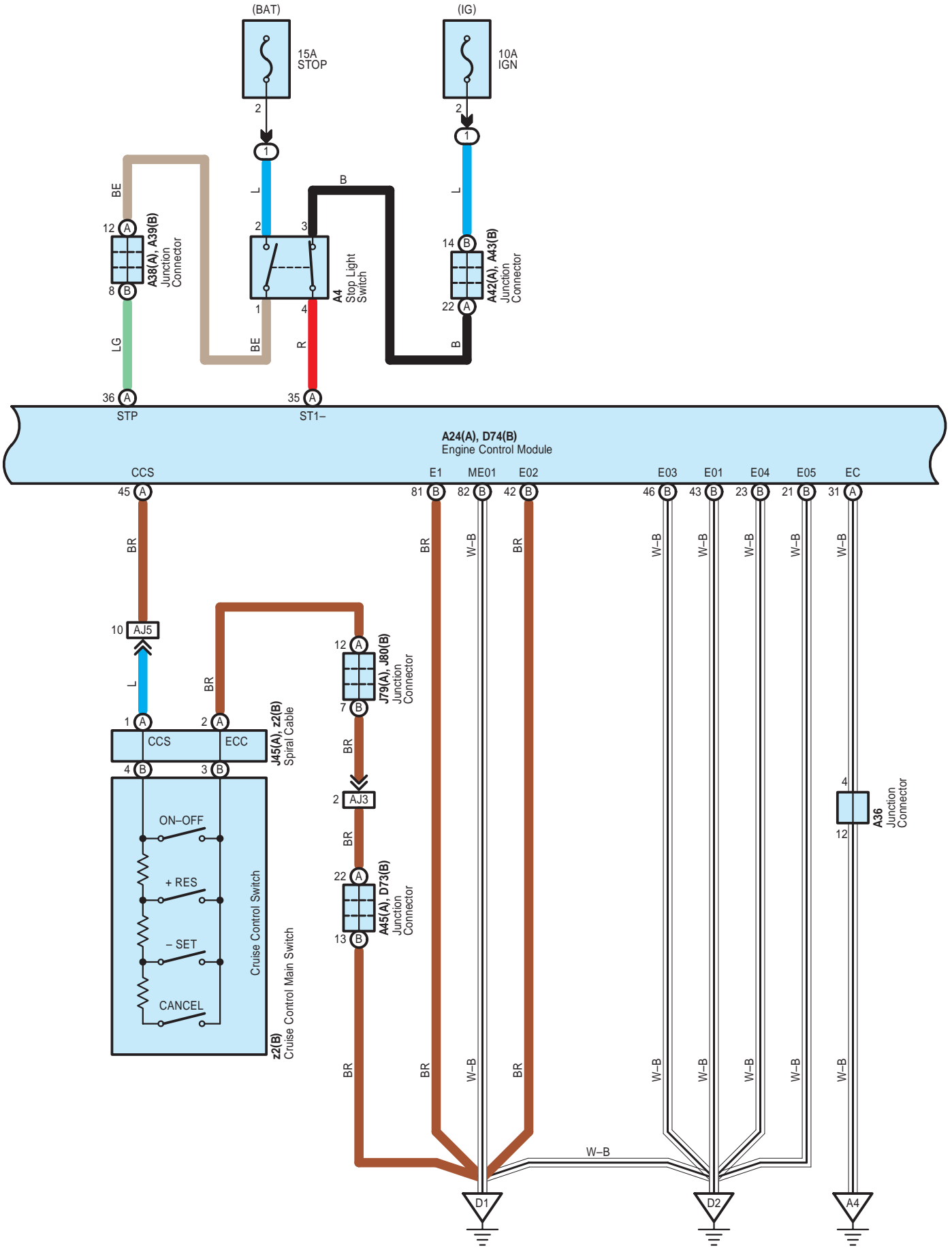

* 6 : Before Nov. 2009 Production
 * 7 : From Nov. 2009 Production

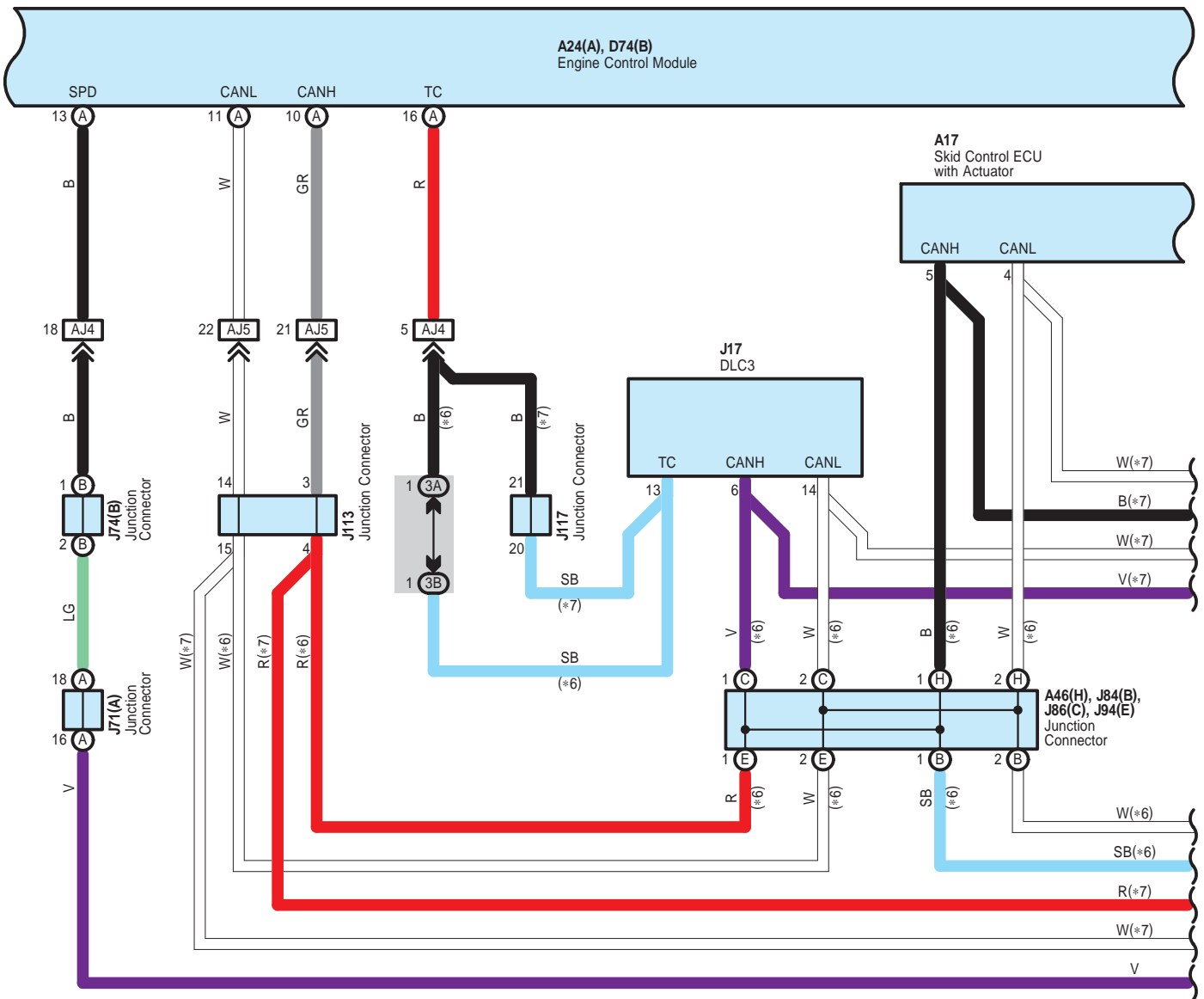

- * 2 : Floor Shift
- * 3 : Column Shift
- * 6 : Before Nov. 2009 Production
- * 7 : From Nov. 2009 Production

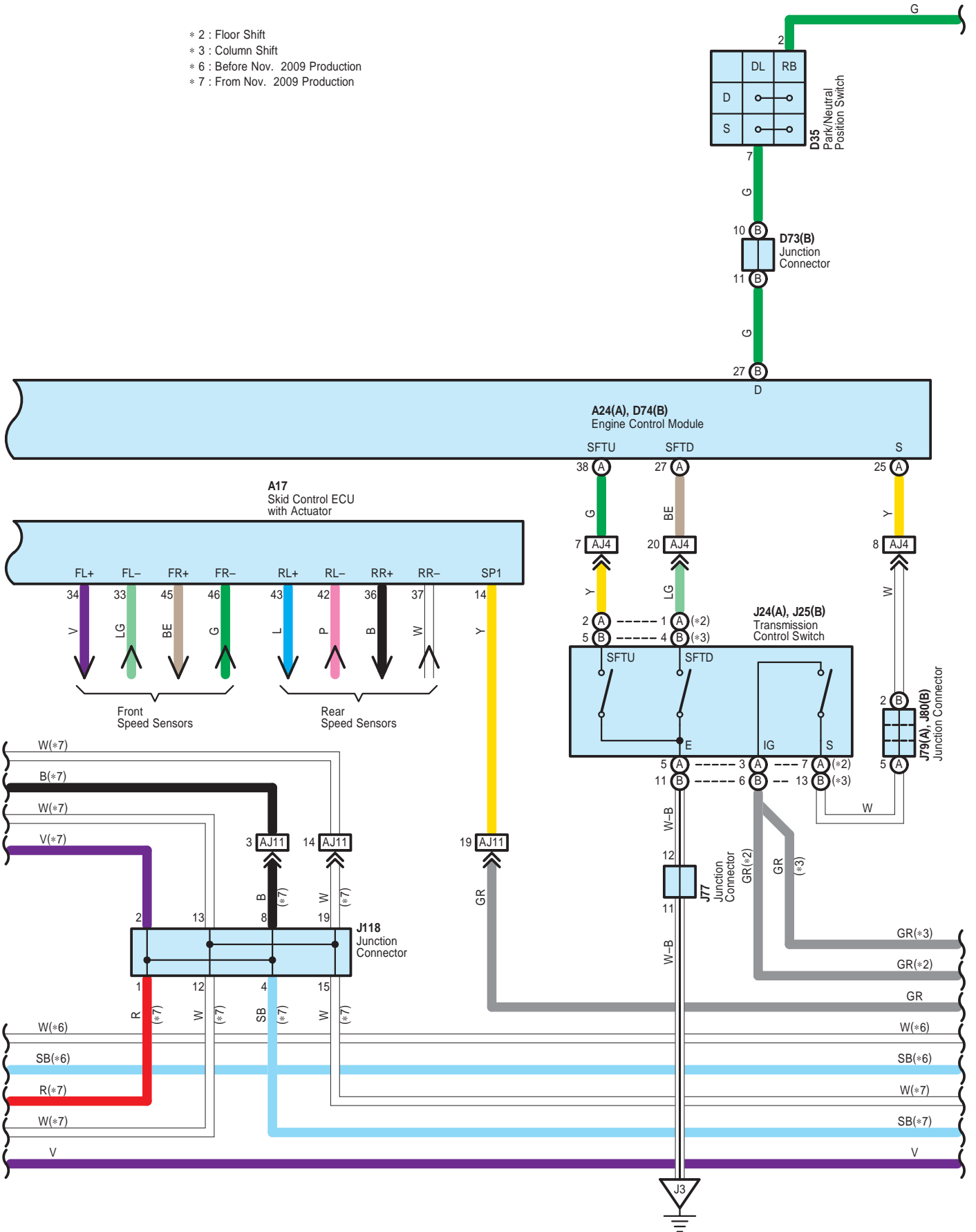

Cruise Control <1UR-FE>

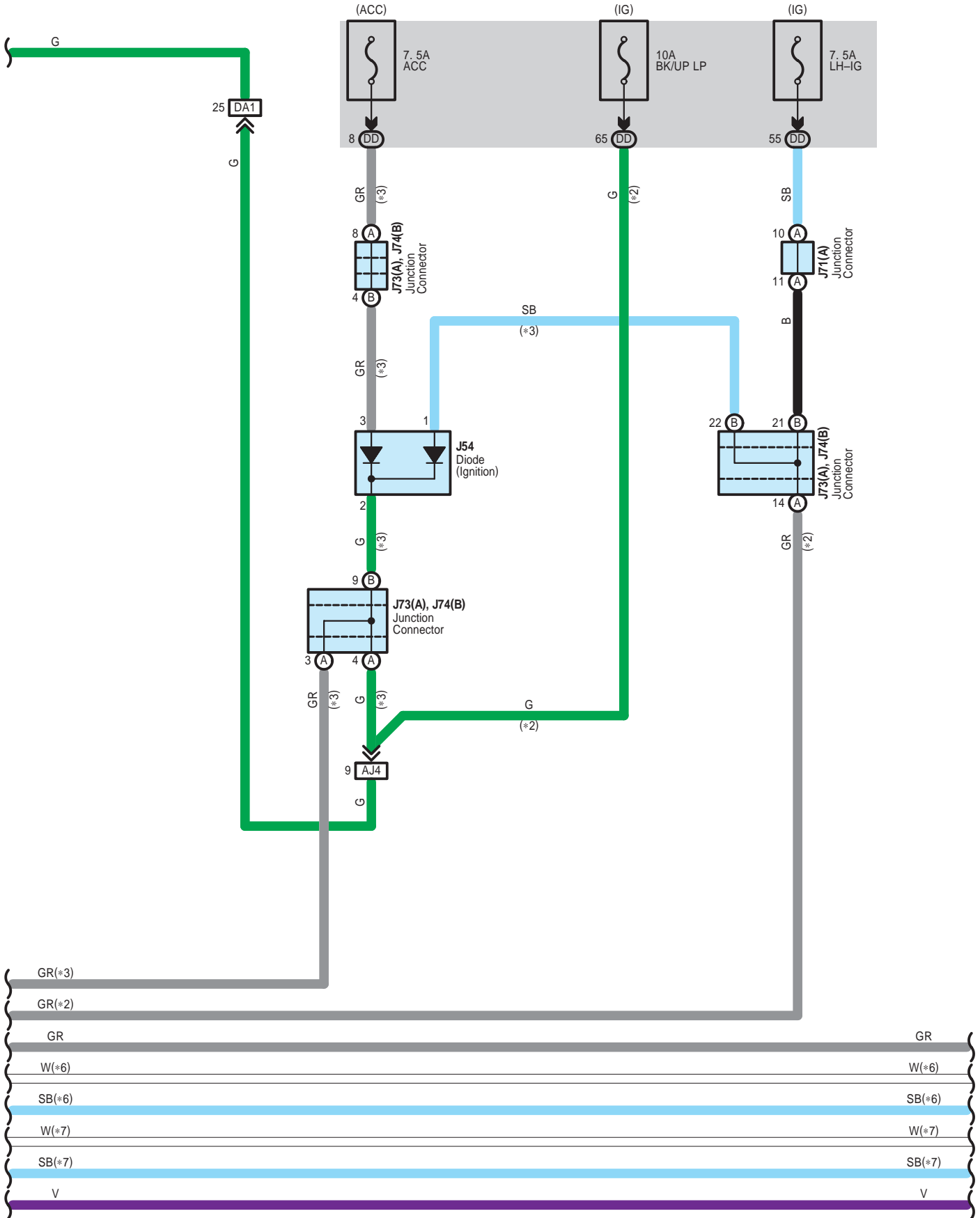

Cruise Control <1UR-FE>

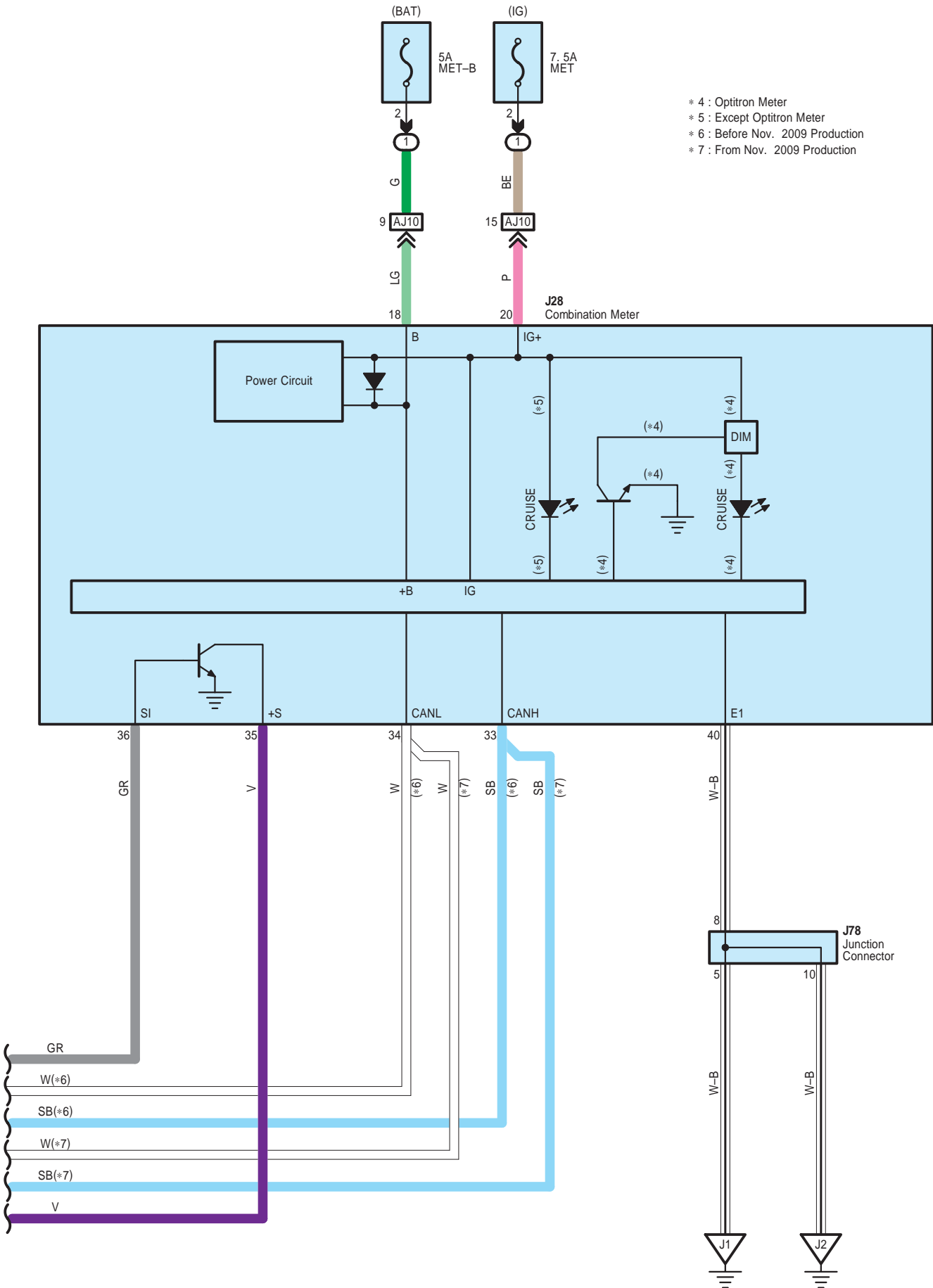

Cruise Control <1UR-FE>

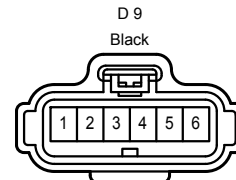
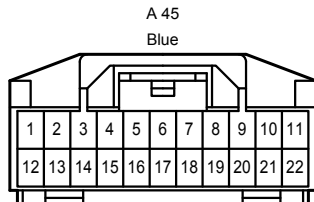
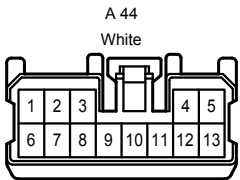
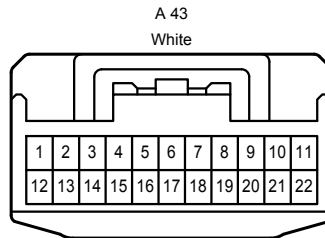
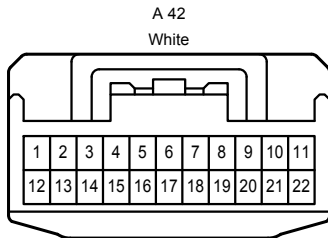
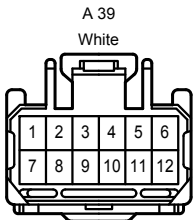
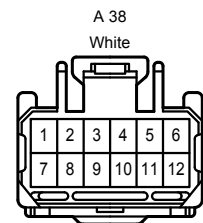
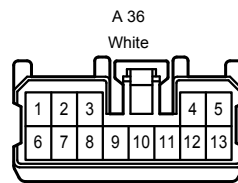
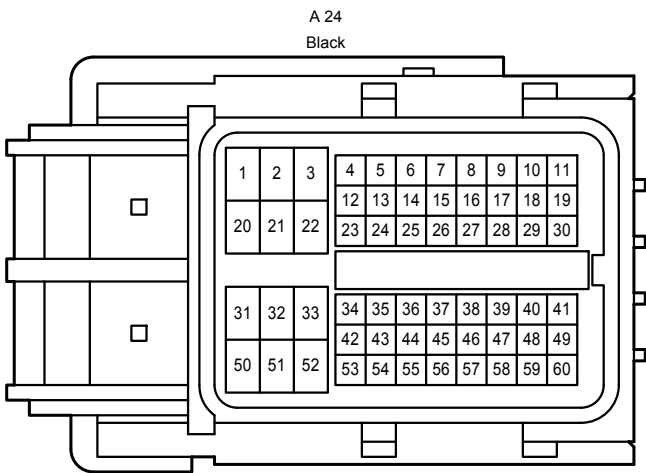
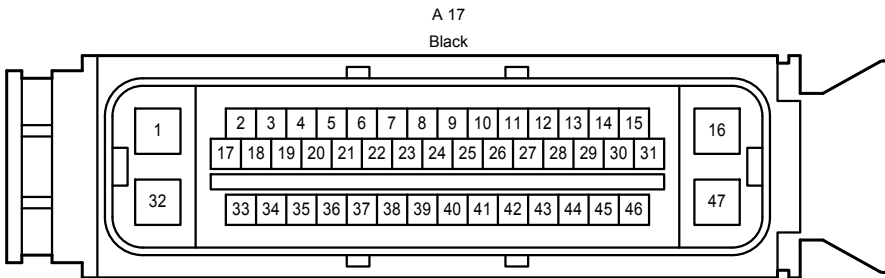
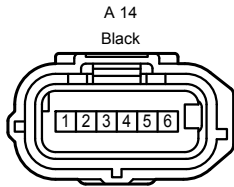
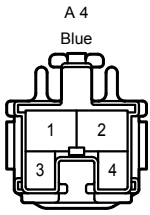

Cruise Control <1UR-FE>

D 35
Gray

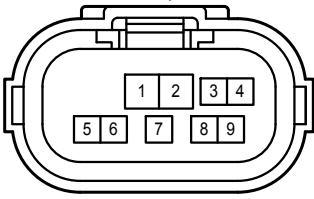

D 73
Blue

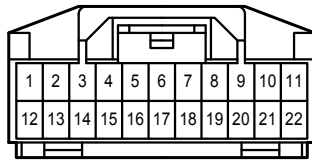

D 74
Black

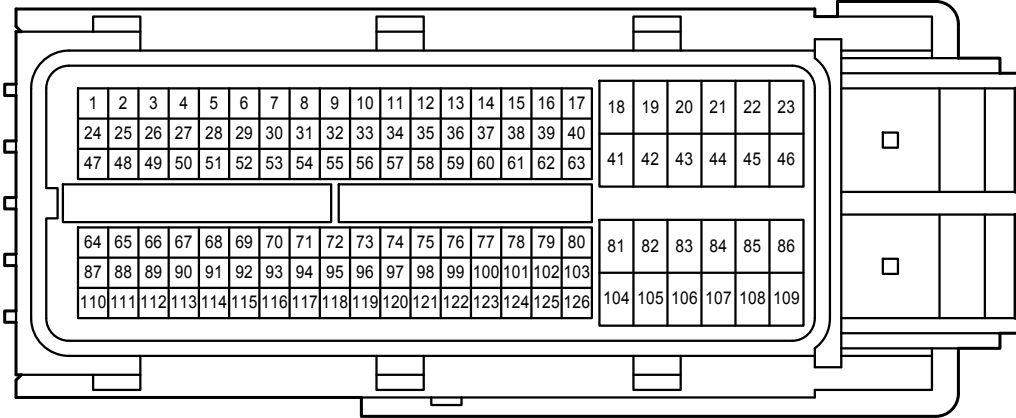

D 83

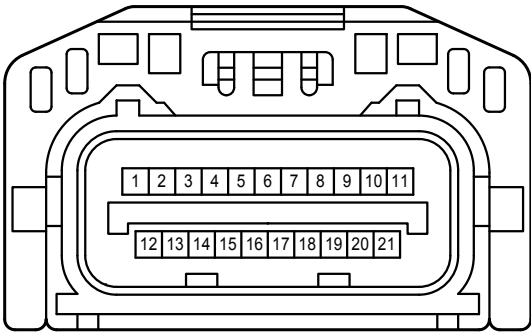

J 17
White

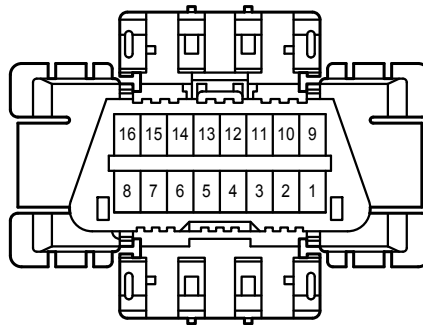

J 24
White

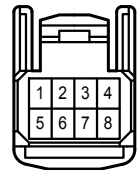

J 25
White

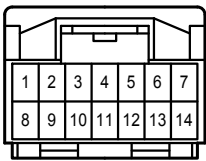

J 28
White

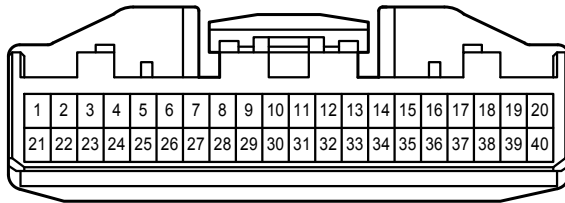

J 45
Black

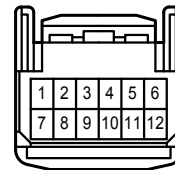

J 54
Orange

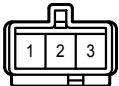

J 71
Black

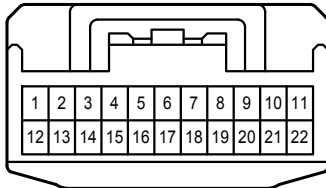

J 73
Black

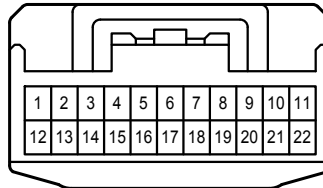

J 74
Black

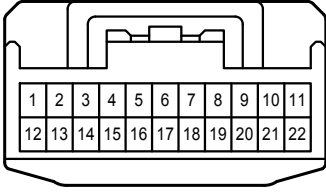

J 77
Gray

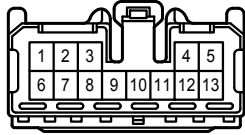

J 78
White

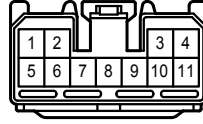

J 79
White

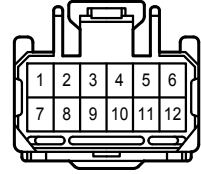

J 80
White

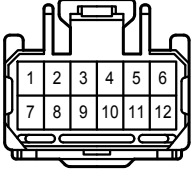

J 84
White

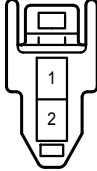

J 86
White

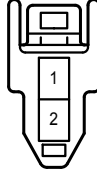

J 94
White

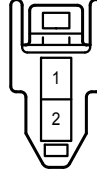

J113
Gray

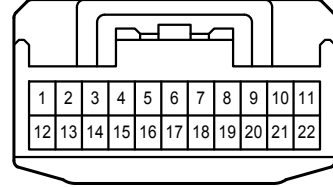

J117
Black

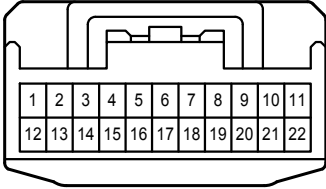

J118
Gray

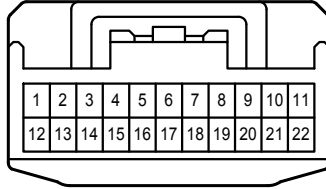

z 2
Black

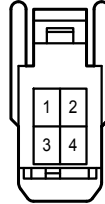

1B
White

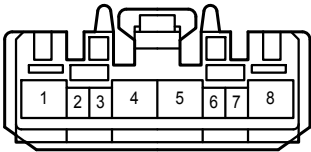

3A
Black

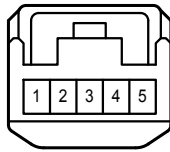

3B
White

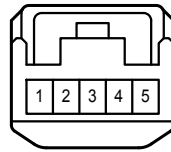

DD
White

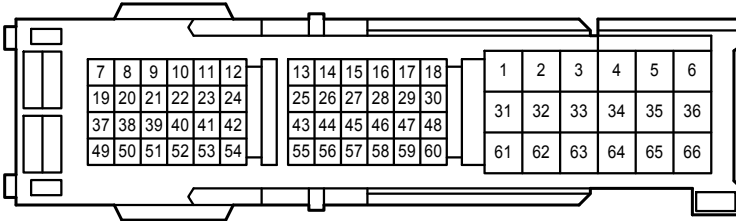

AJ3
White

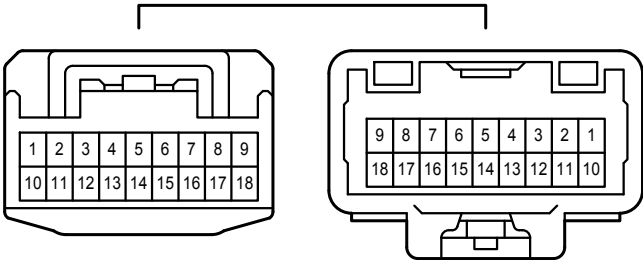

AJ4
White

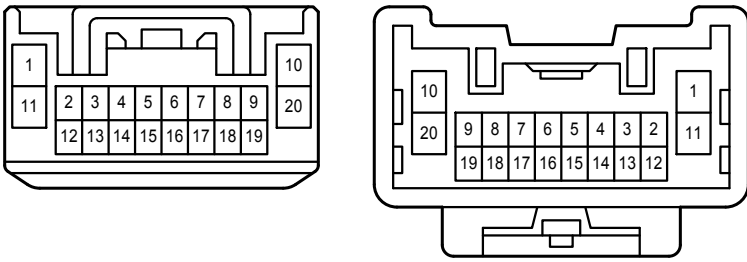

AJ5
White

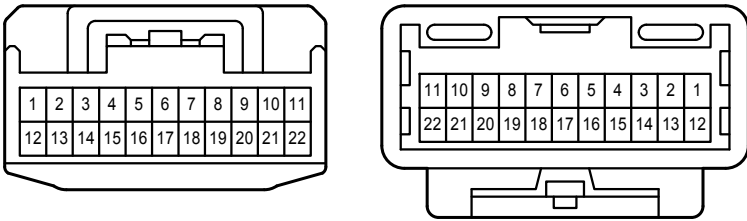

AJ10
Gray

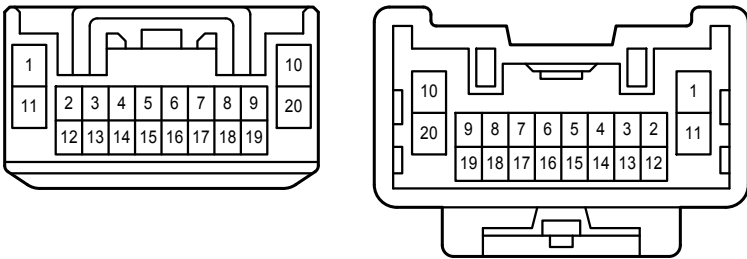

AJ11
Gray

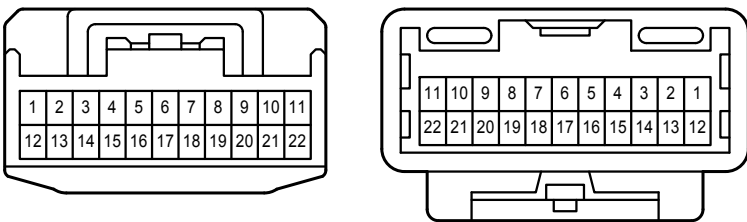

DA1
White

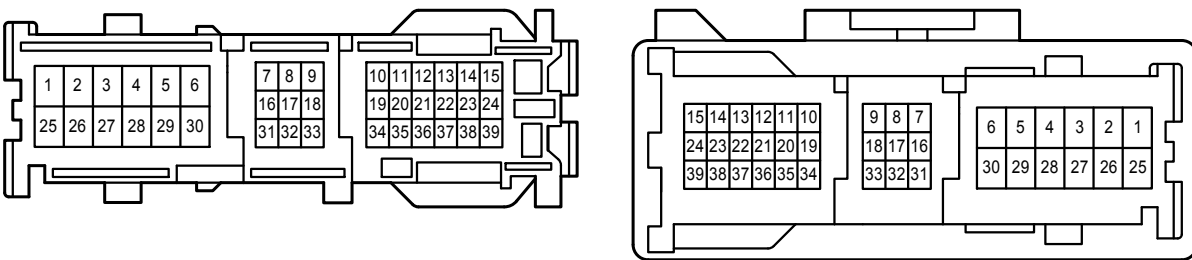

DA2
White

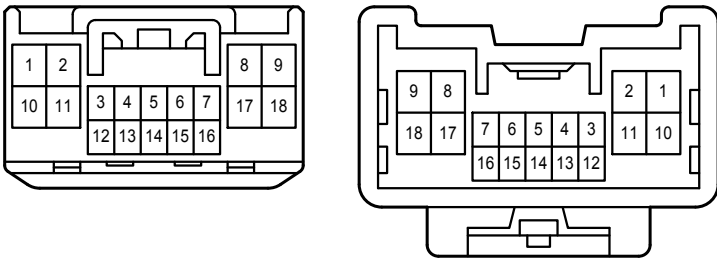

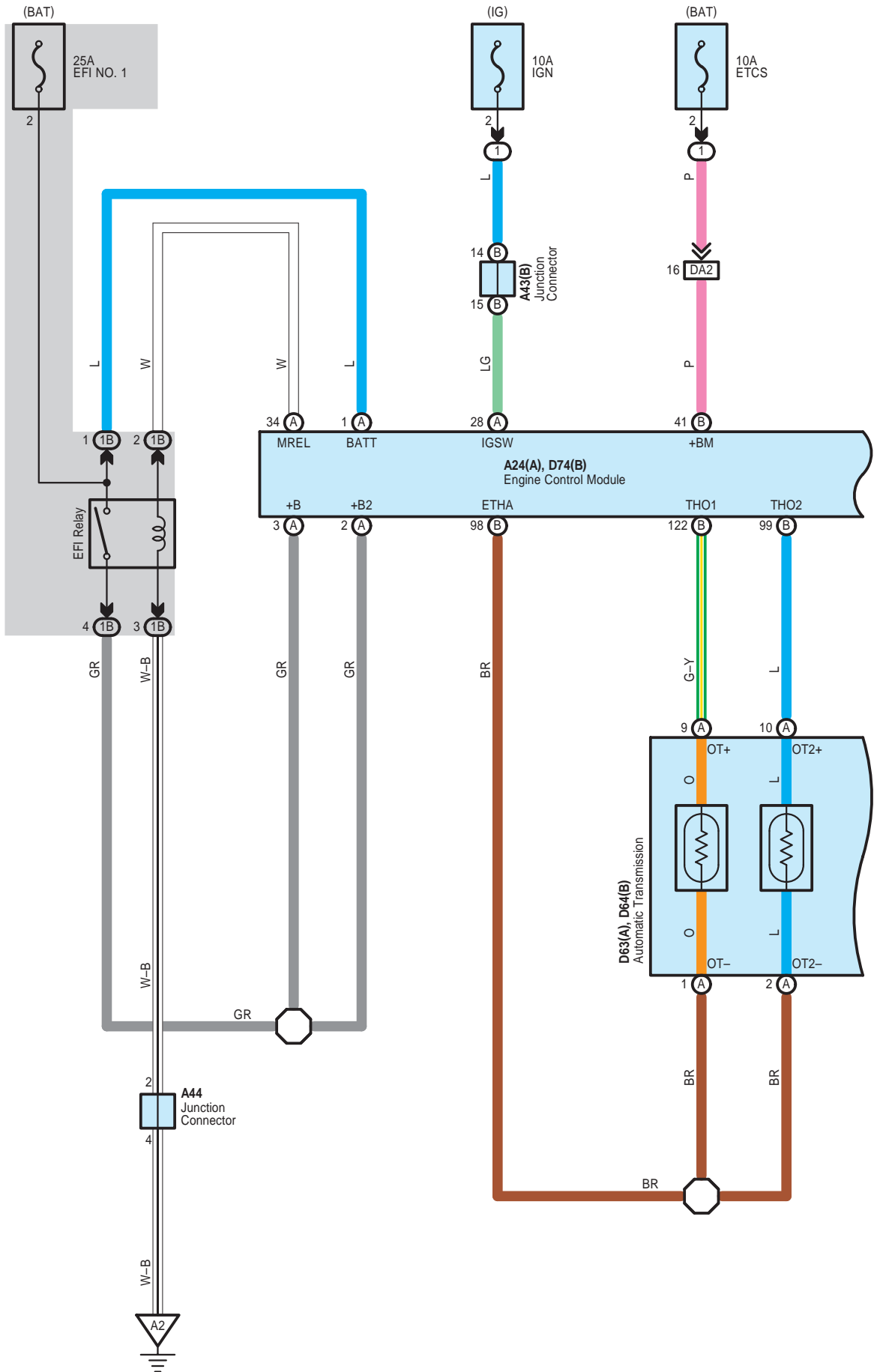

* 1 : Shielded

A14
Accelerator Position Sensor

D9
Throttle Position Sensor

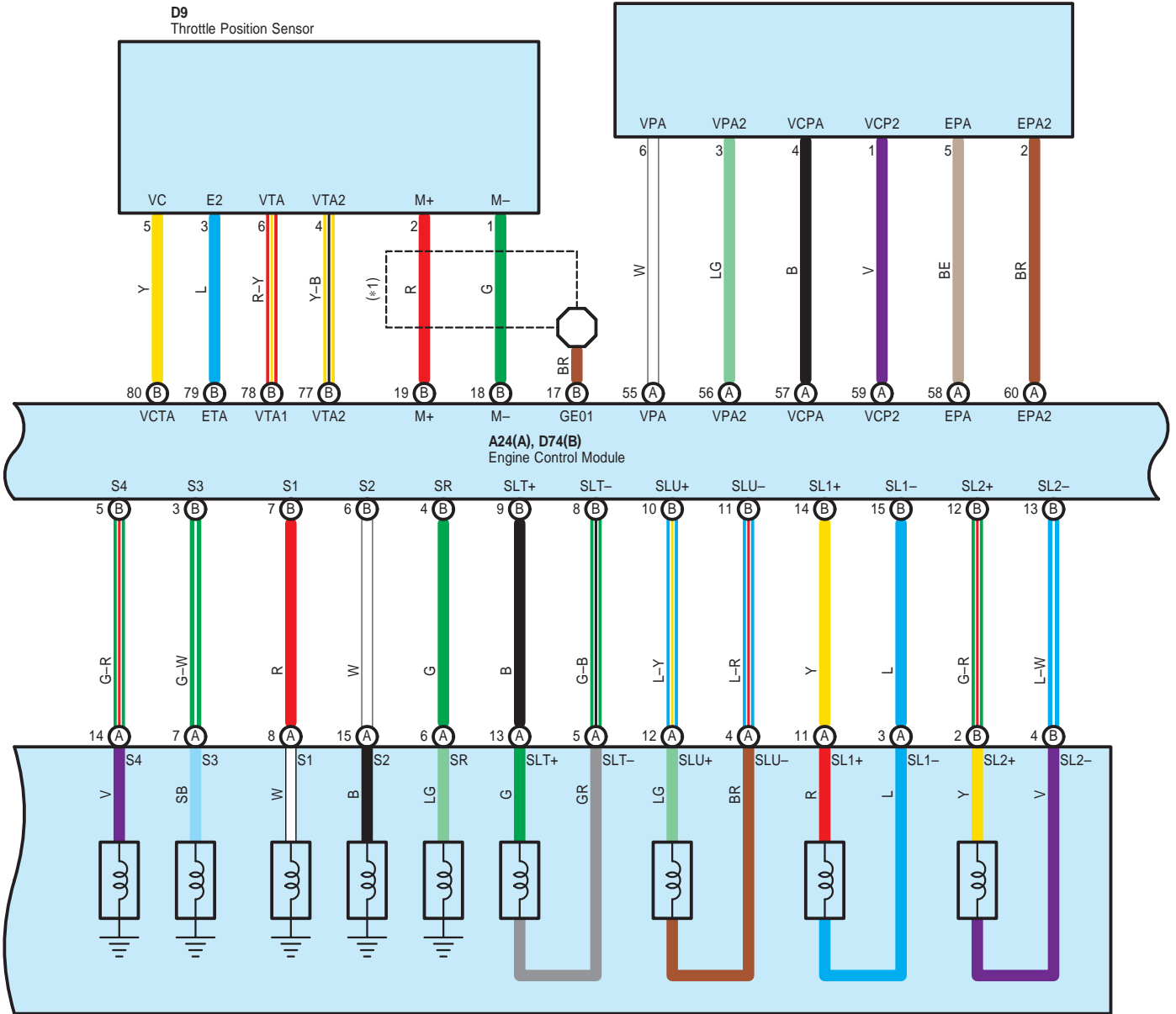

D63(A), D64(B)
Automatic Transmission

Cruise Control <3UR-FE, 3UR-FBE>

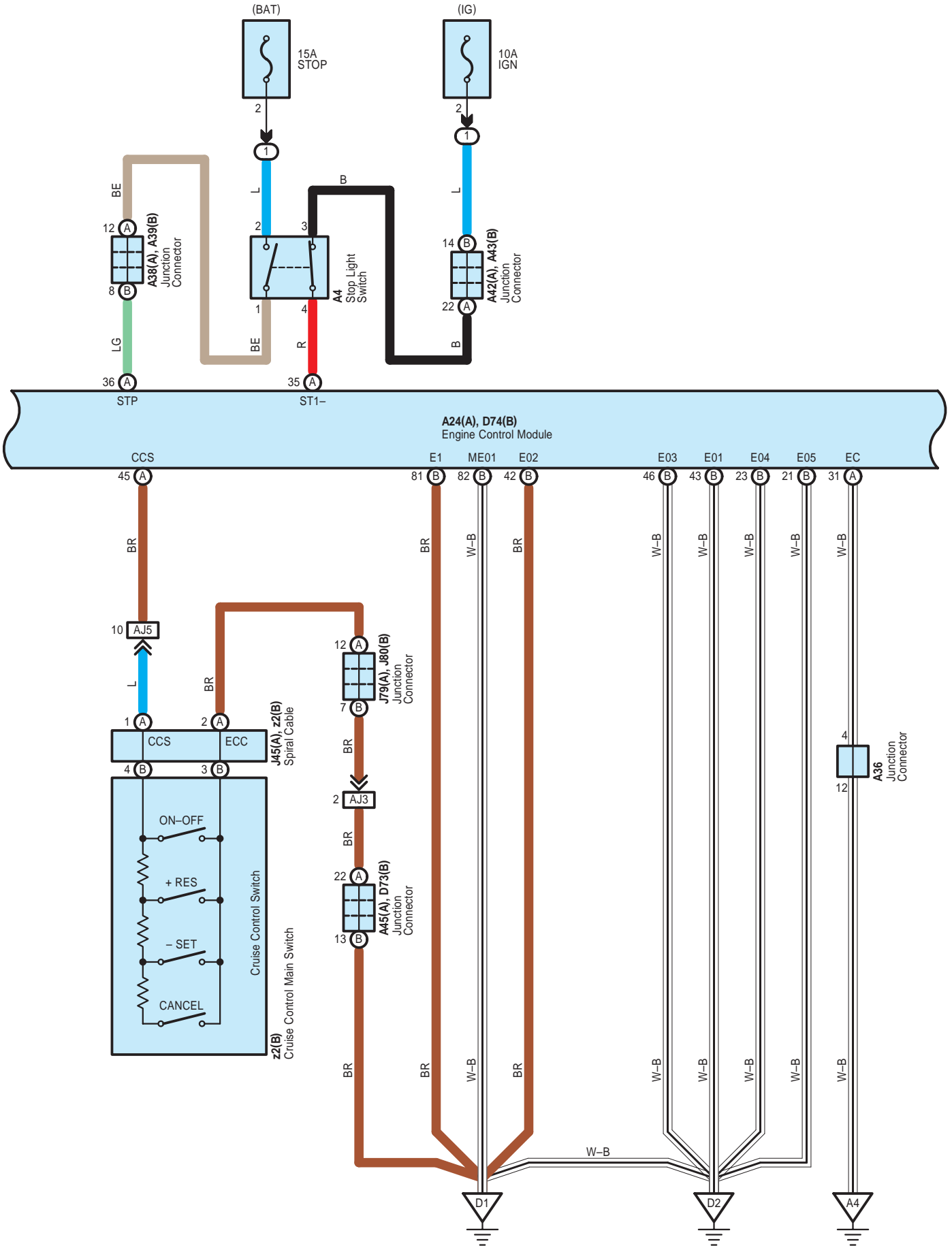

* 6 : Before Nov. 2009 Production
 * 7 : From Nov. 2009 Production

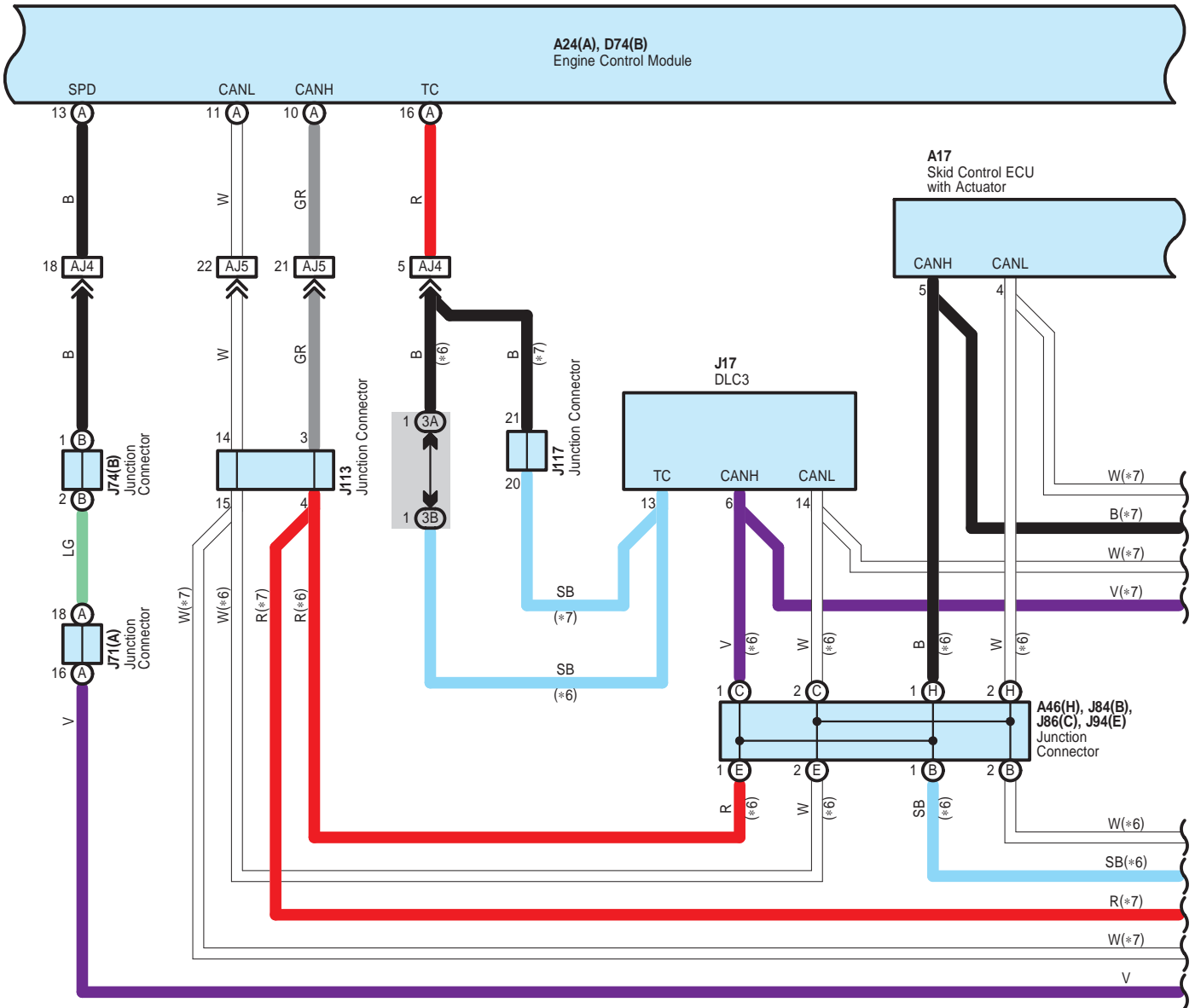

- * 2 : Floor Shift
- * 3 : Column Shift
- * 6 : Before Nov. 2009 Production
- * 7 : From Nov. 2009 Production

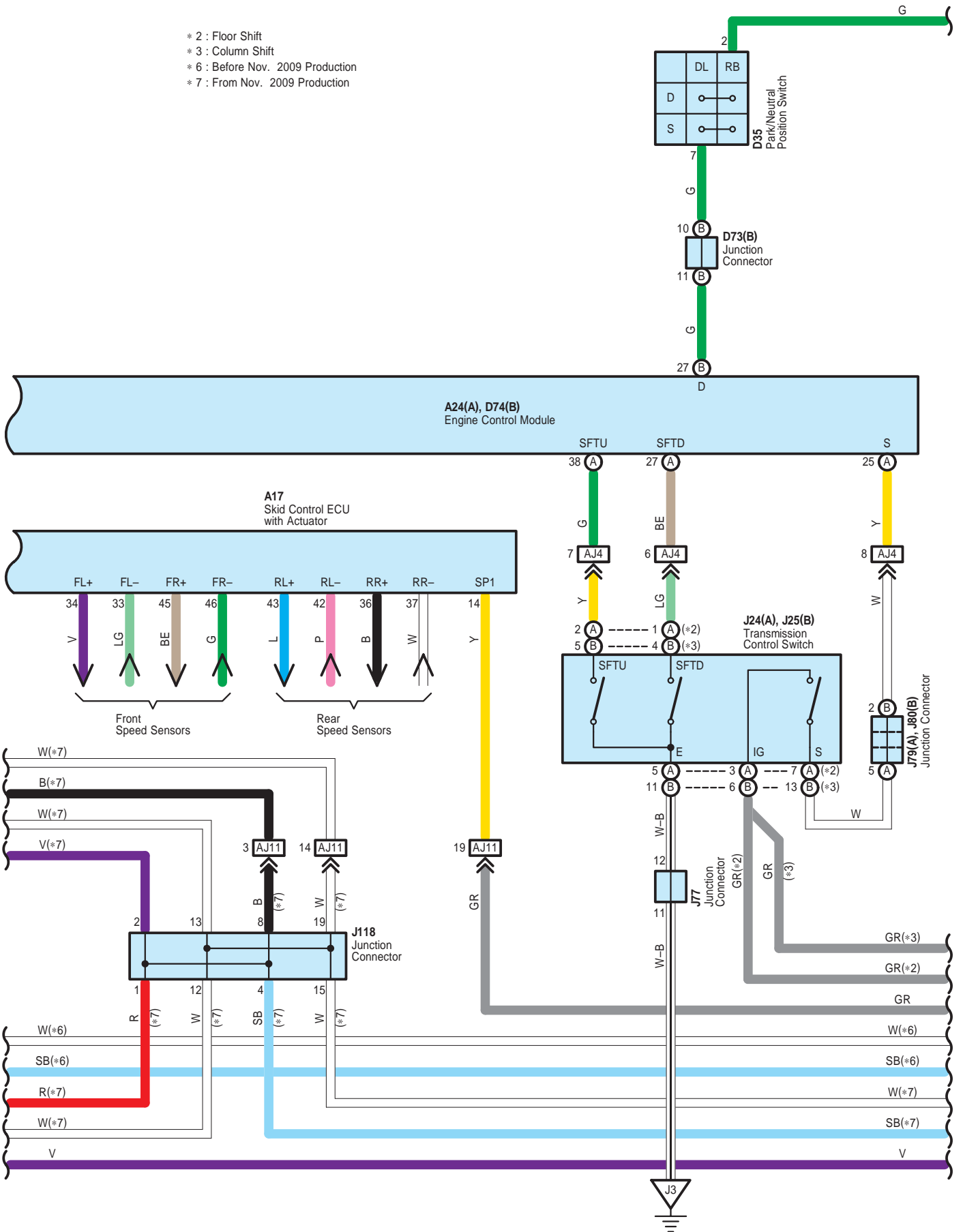

Cruise Control <3UR-FE, 3UR-FBE>

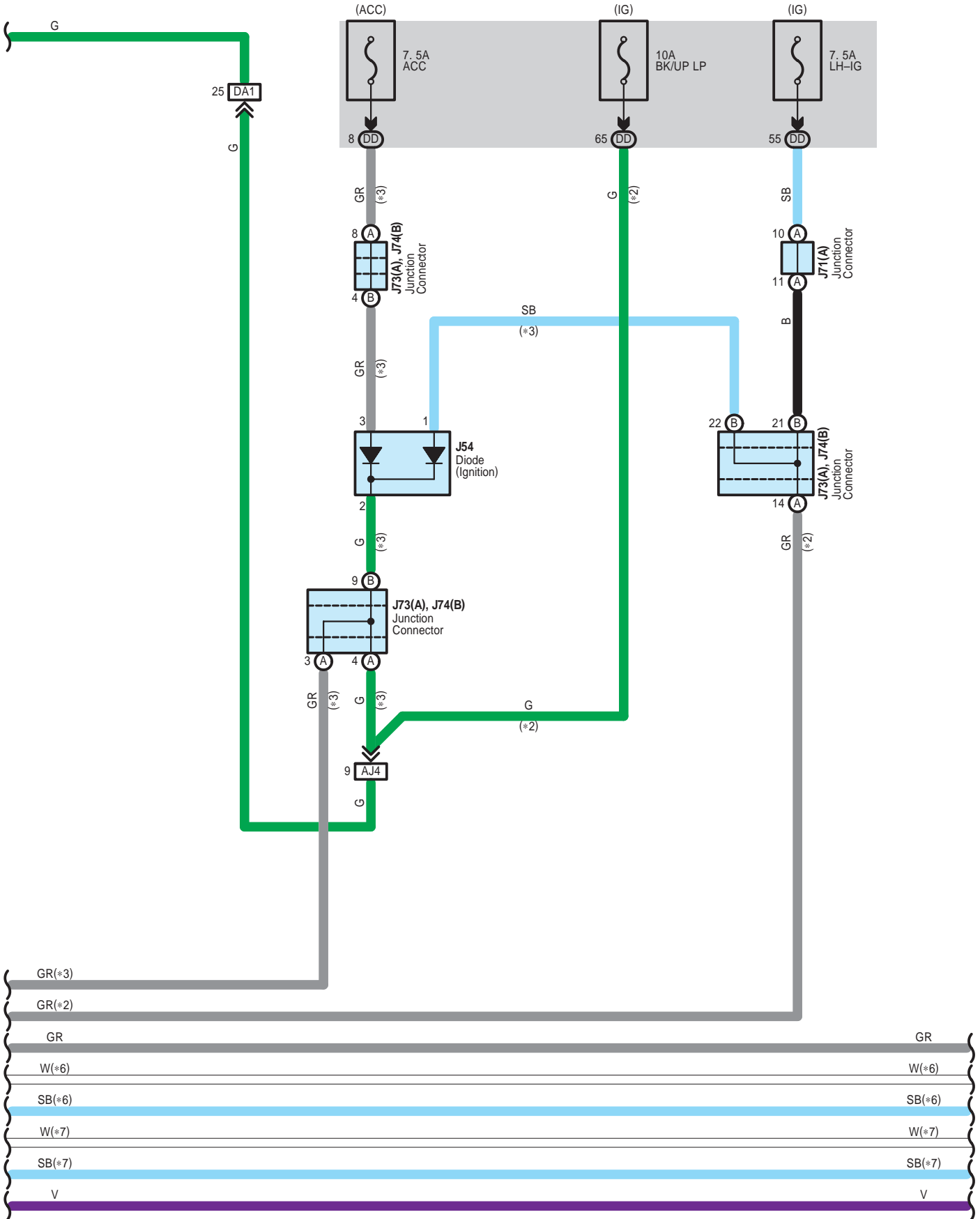

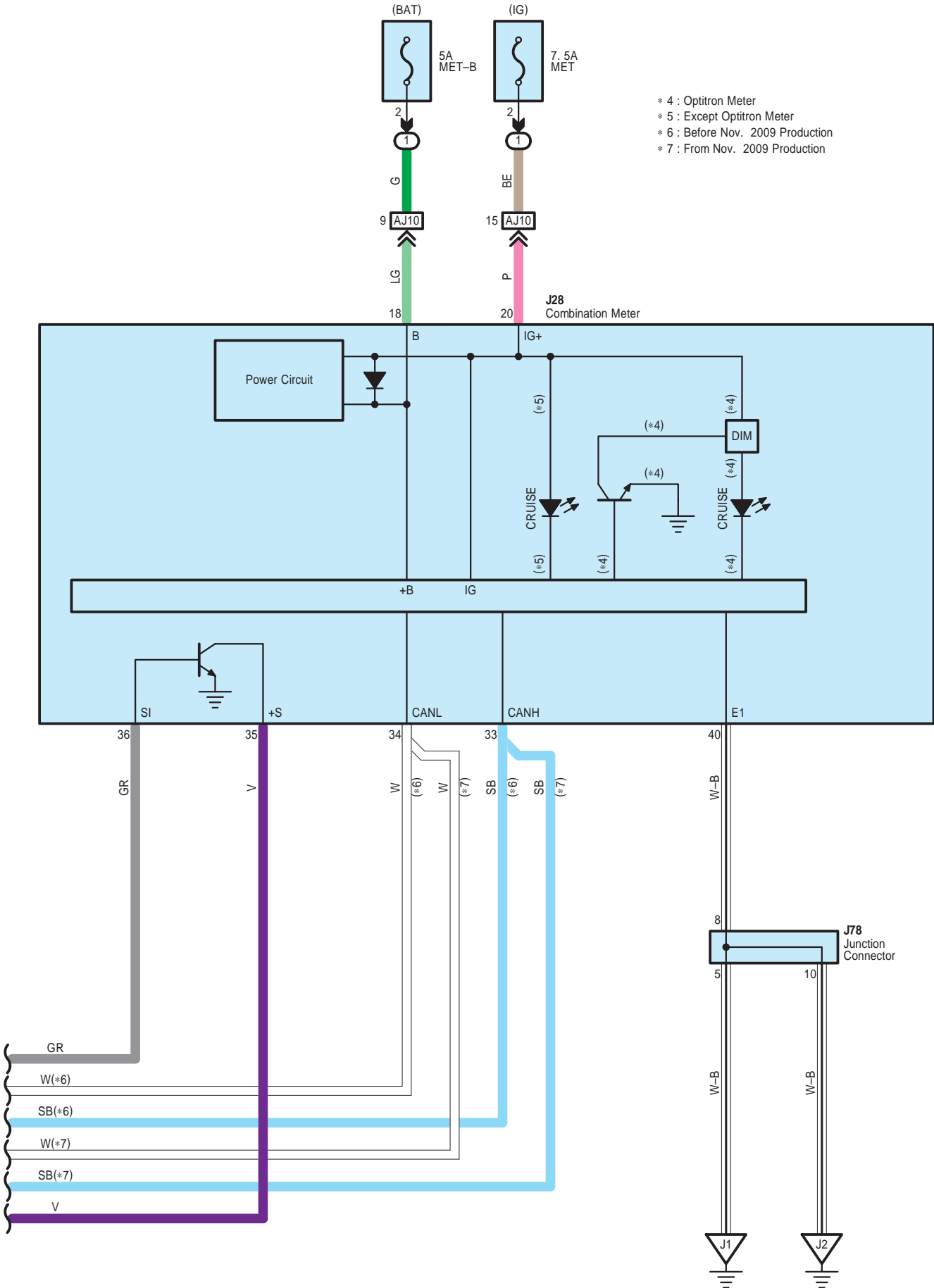

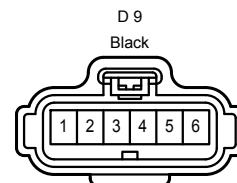
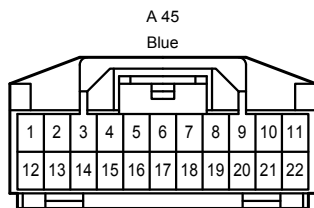
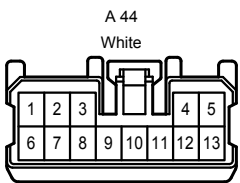
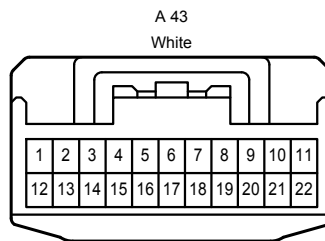
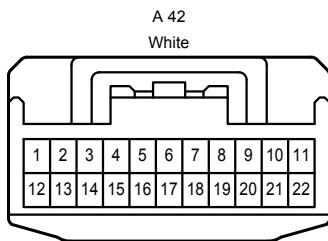
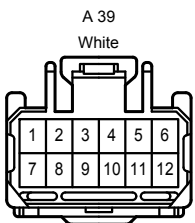
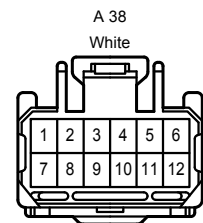
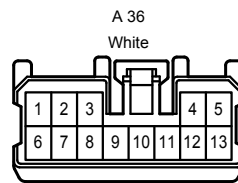
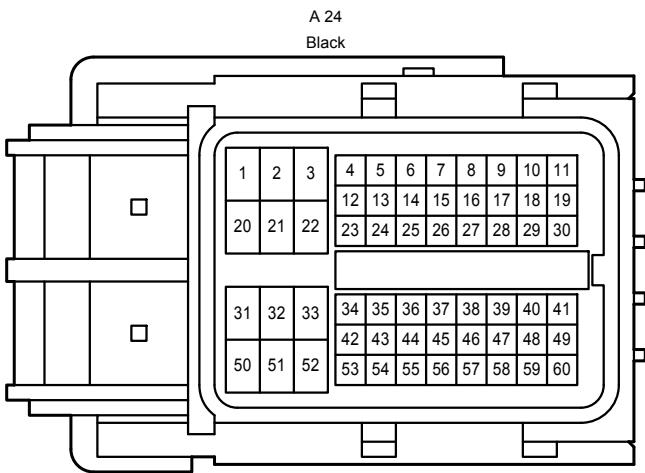
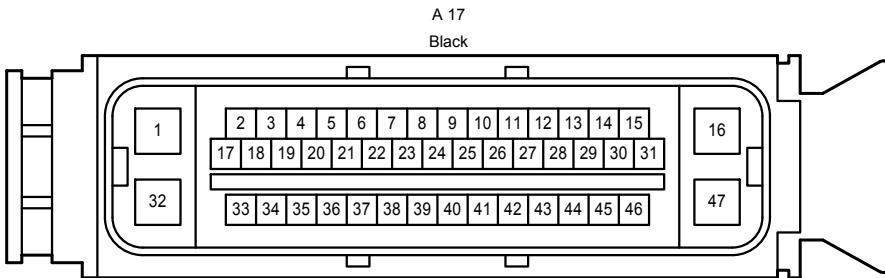
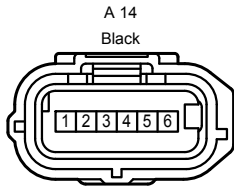
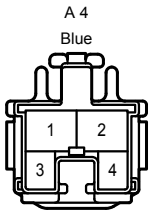

Cruise Control <3UR-FE, 3UR-FBE>

D 35
Gray

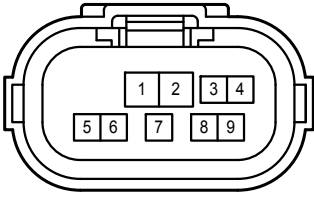

D 63
Gray

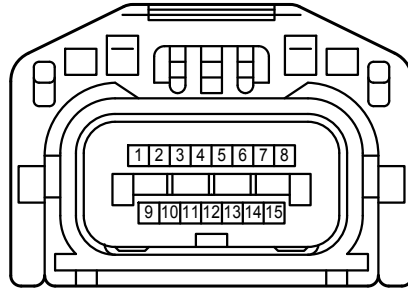

D 64
Gray

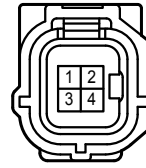

D 73
Blue

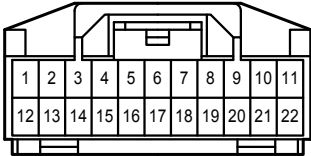

D 74
Black

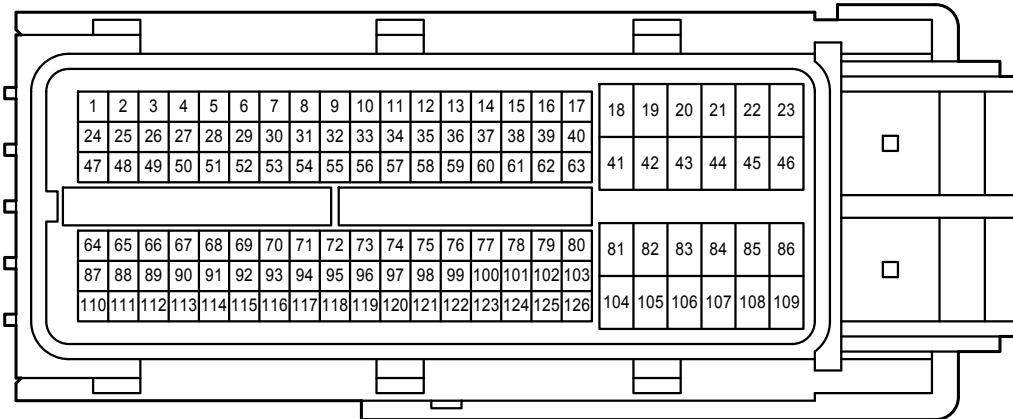

J 17
White

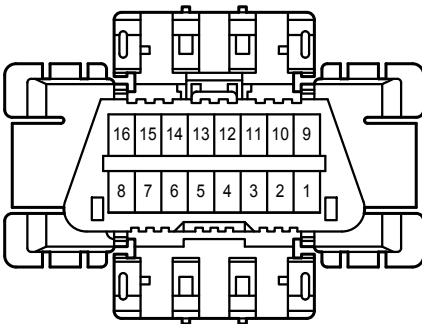

J 24
White

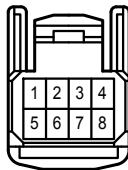

J 25
White

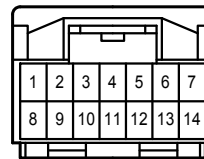

J 28
White

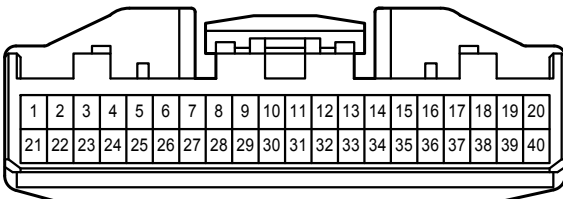

J 45
Black

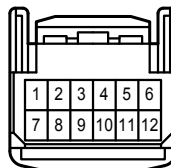

J 54
Orange

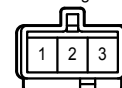

Cruise Control <3UR-FE, 3UR-FBE>

J 71
Black

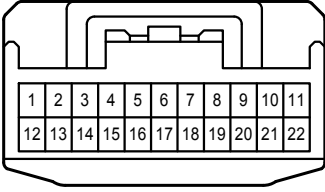

J 73
Black

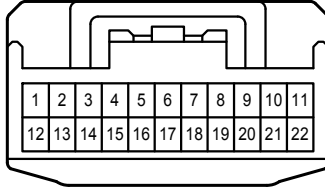

J 74
Black

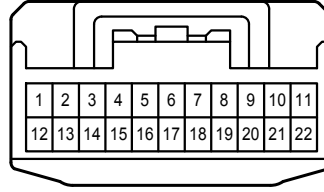

J 77
Gray

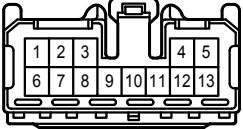

J 78
White

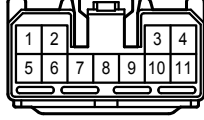

J 79
White

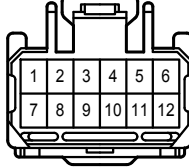

J 80
White

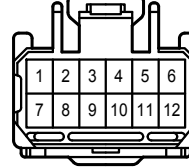

J 84
White

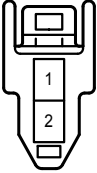

J 86
White

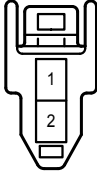

J 94
White

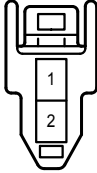

J113
Gray

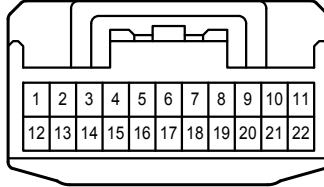

J117
Black

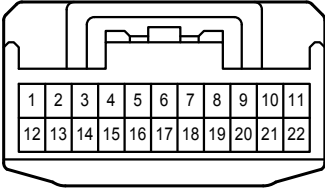

J118
Gray

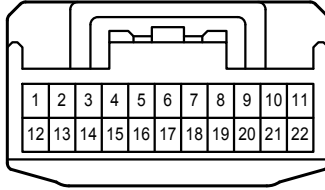

z 2
Black

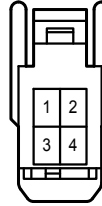

1B
White

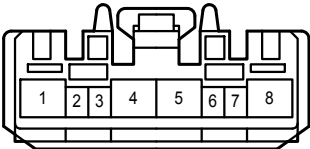

3A
Black

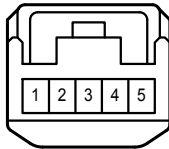

3B
White

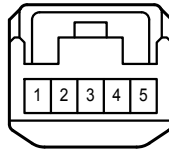

DD
White

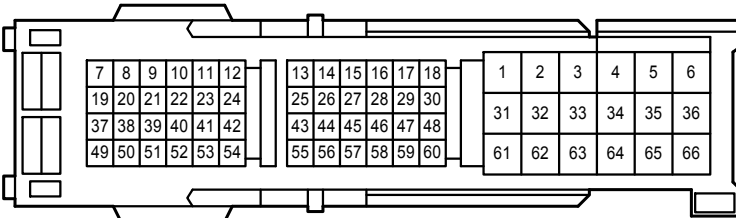

AJ3
White

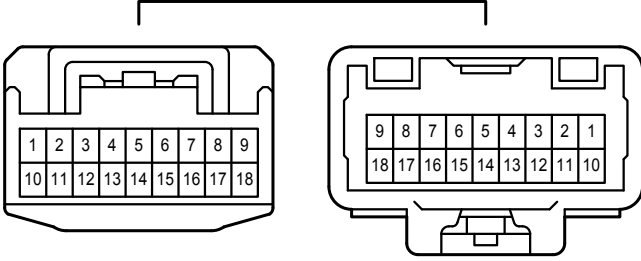

AJ4
White

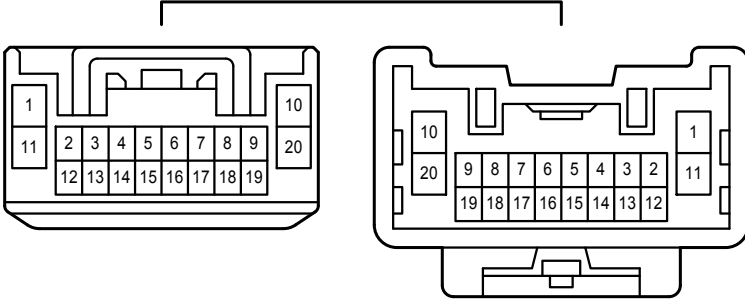

AJ5
White

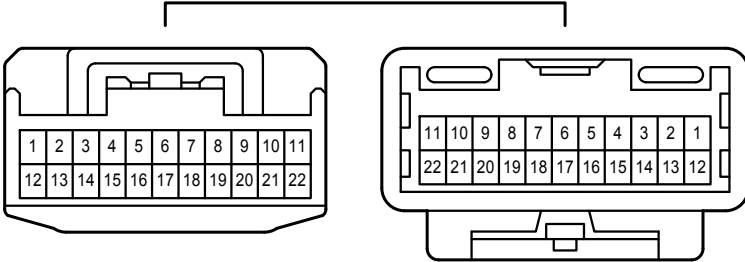

AJ10
Gray

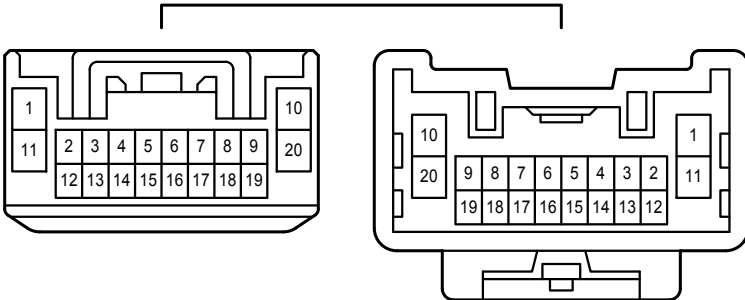

AJ11
Gray

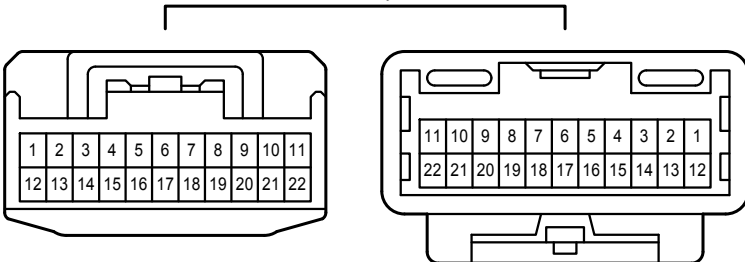

Cruise Control <3UR-FE, 3UR-FBE>

DA1
White

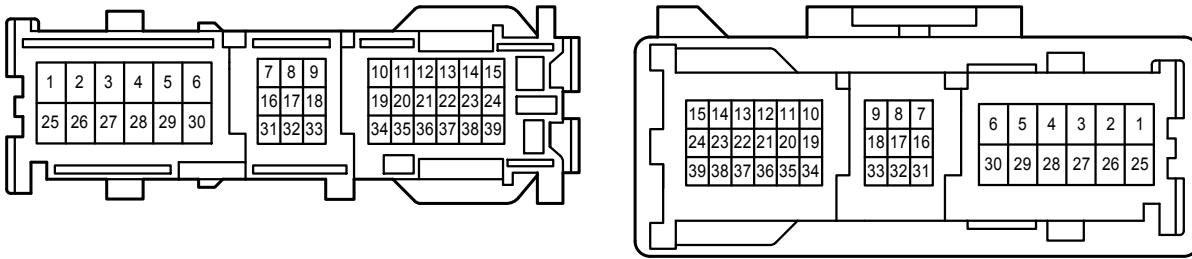

DA2
White

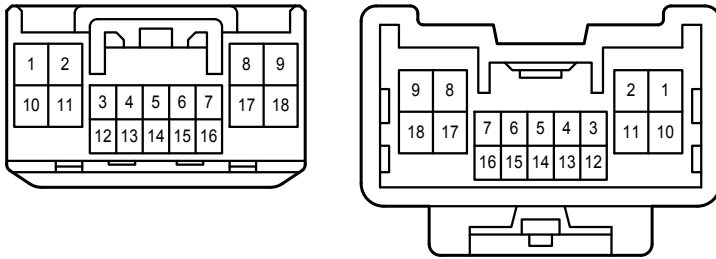

Data Link Connector 3

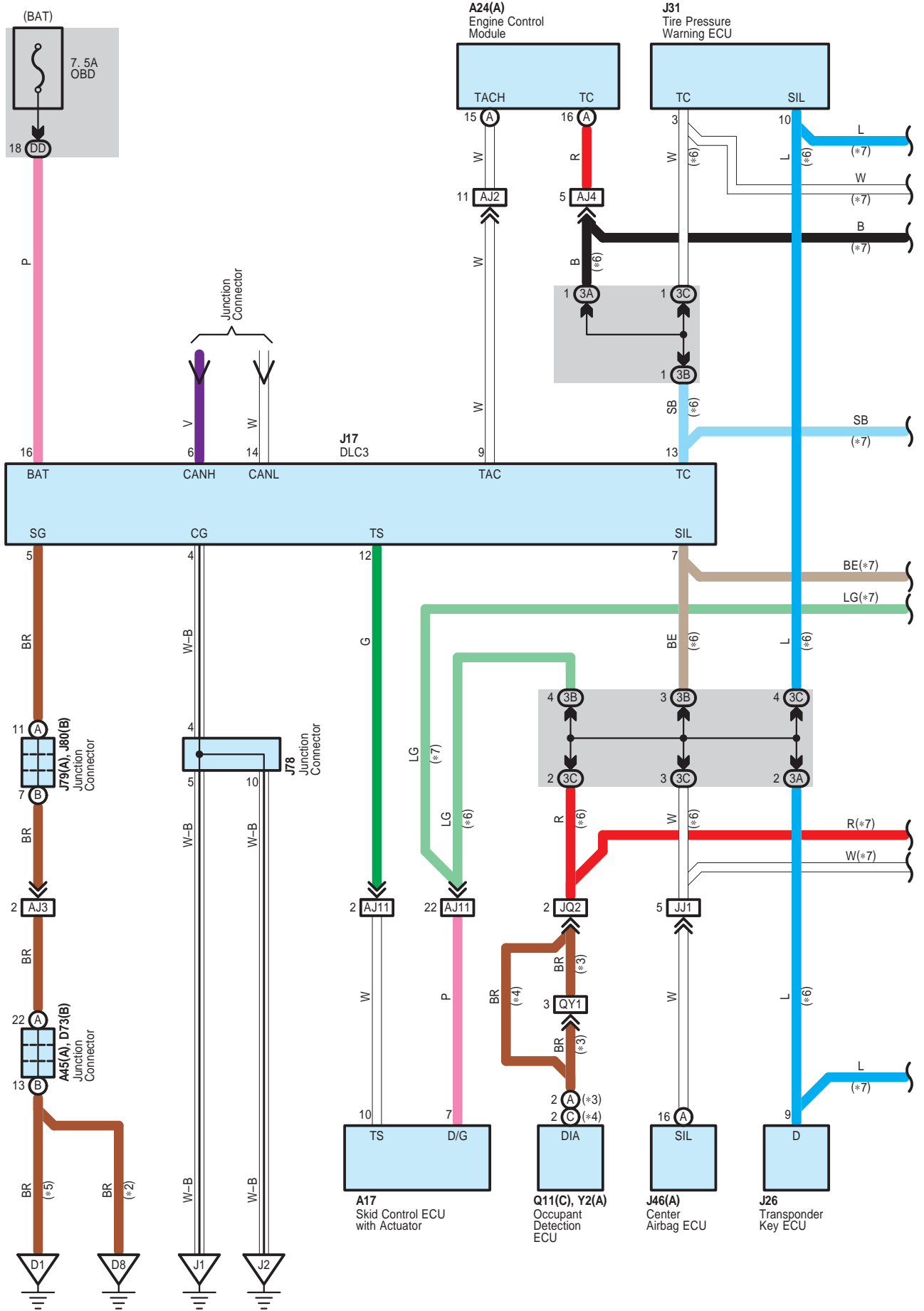

Data Link Connector 3

- * 2 : 1GR-FE
- * 3 : w/ Power Seat
- * 4 : w/o Power Seat
- * 5 : 3UR-FE, 3UR-FBE, 1UR-FE
- * 6 : Before Nov. 2009 Production
- * 7 : From Nov. 2009 Production

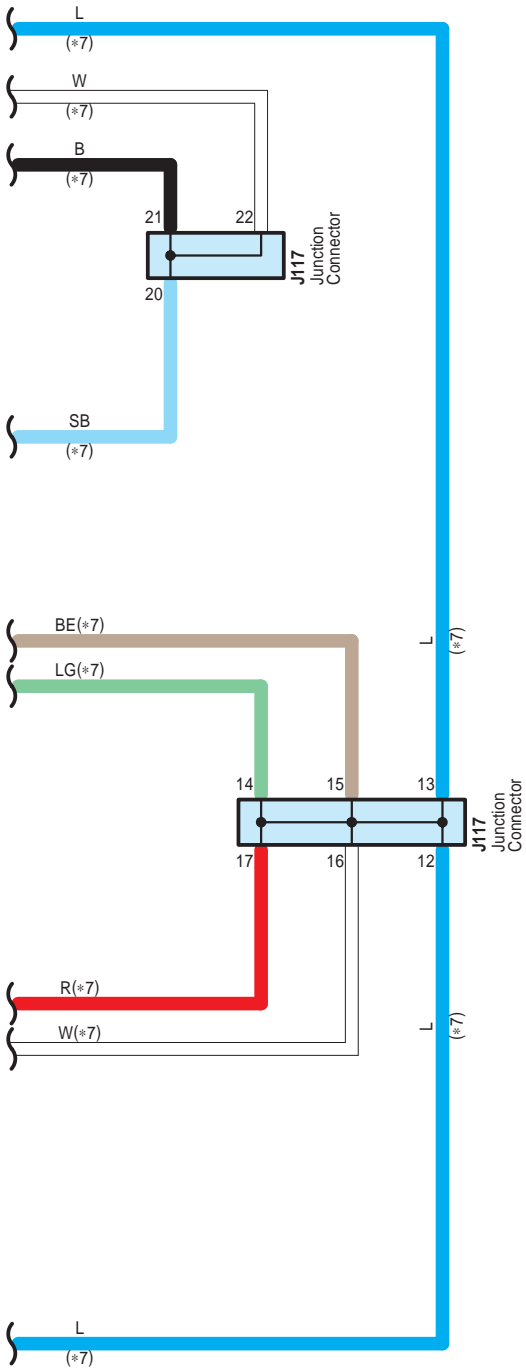

Data Link Connector 3

A 17
Black

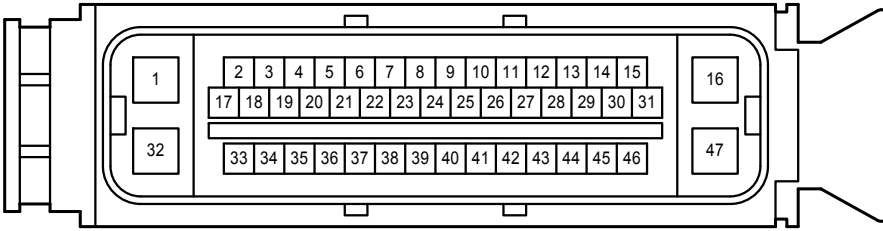

A 24
Black

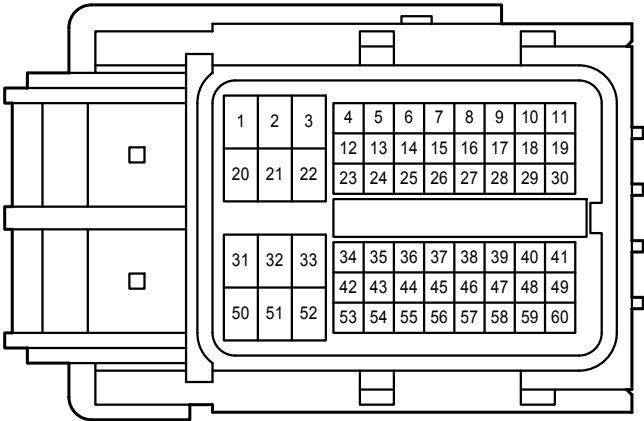

A 45
Blue

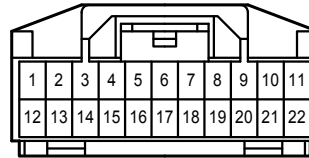

D 73
Blue

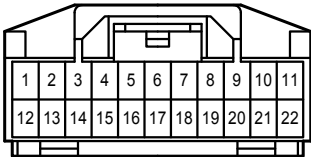

J 17
White

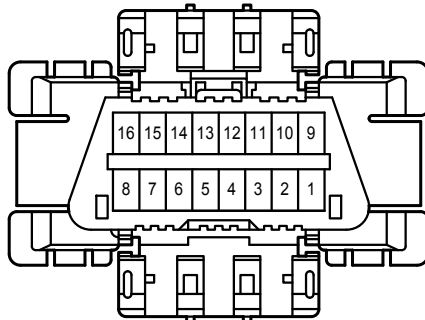

J 26
White

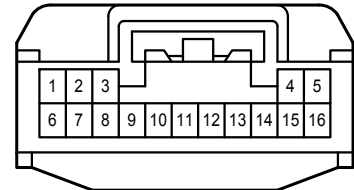

J 31
White



J 46
Yellow

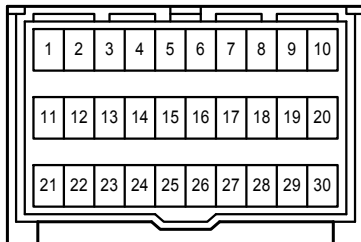

J 78
White

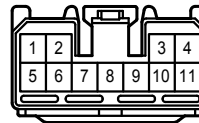

J 79
White

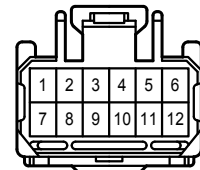

J 80
White

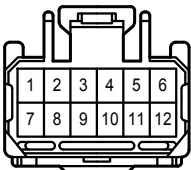

J117
Black

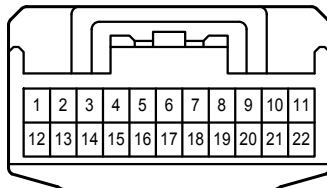

Q 11
Black

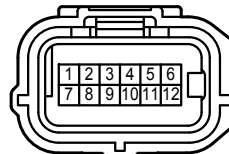

Data Link Connector 3

Y 2
Black

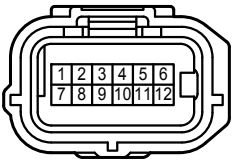

3A
Black

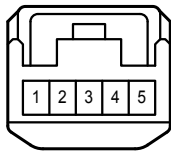

3B
White

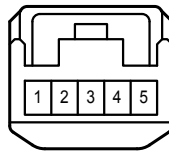

3C
Blue

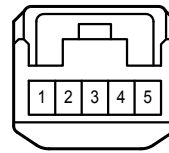

DD
White

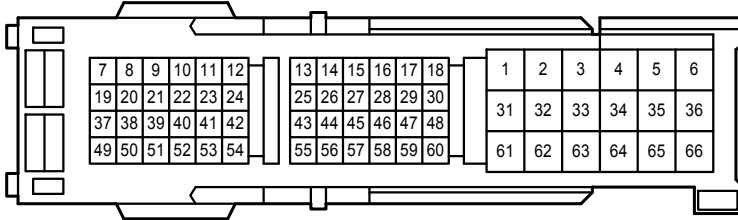

AJ2
White

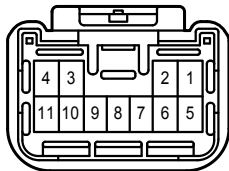
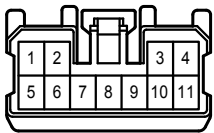

AJ3
White

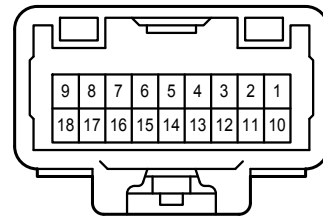
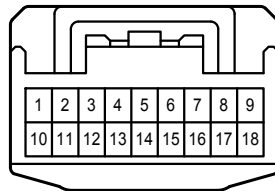

AJ4
White

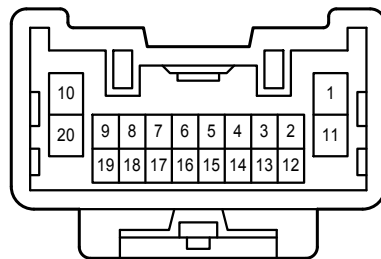
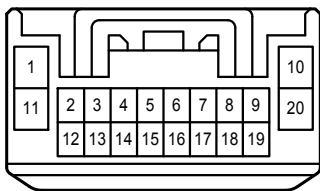

AJ11
Gray

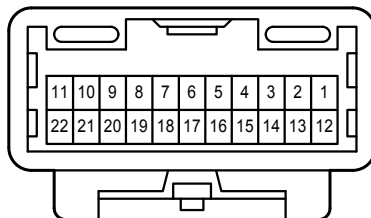
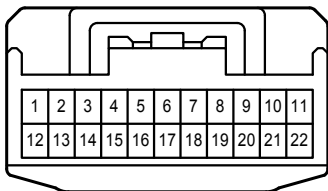

JJ1
White

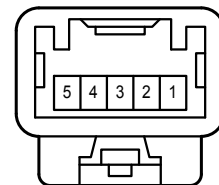
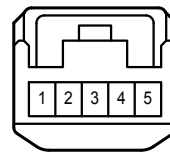

JQ2
Gray

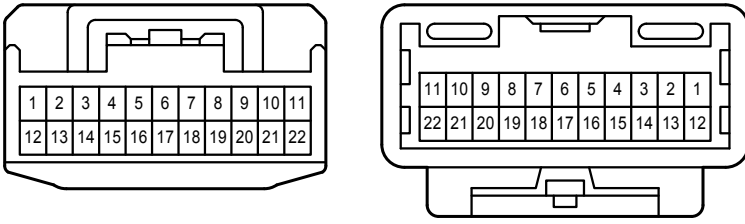

QY1
White

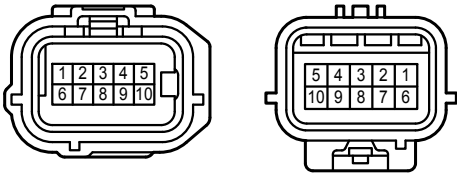

Door Lock Control

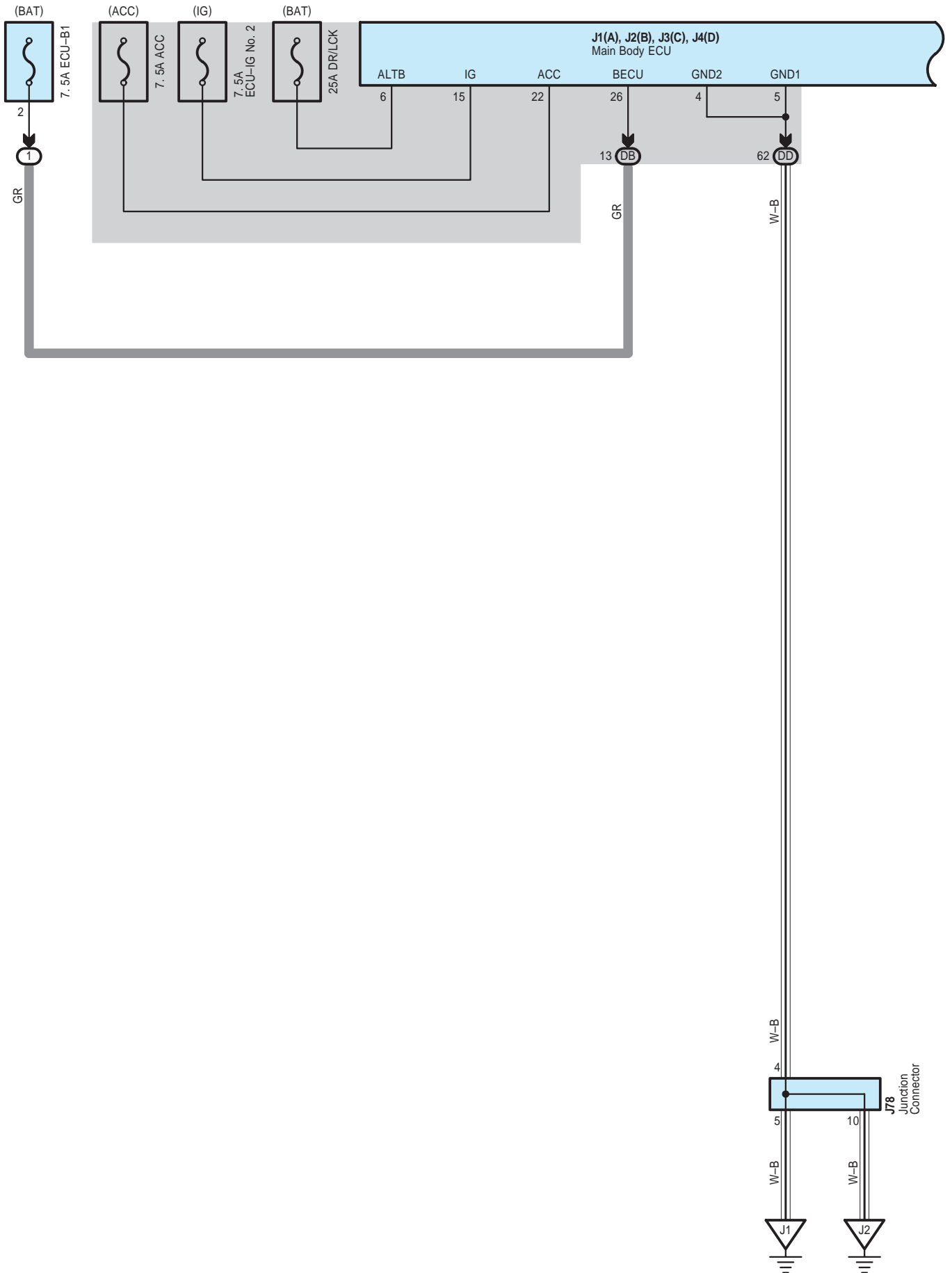

Door Lock Control

J1(A), J2(B), J3(C), J4(D)
Main Body ECU

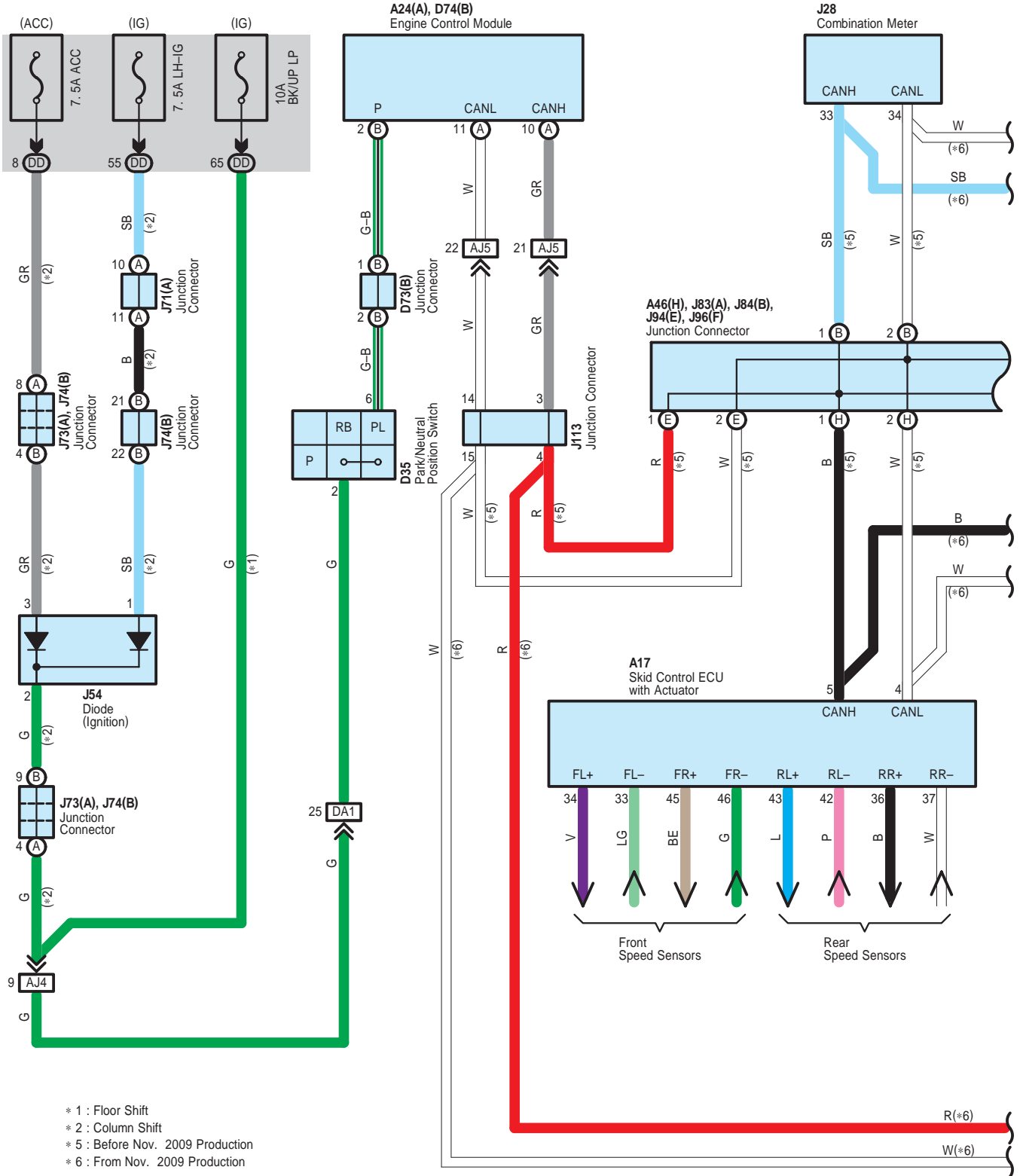

Door Lock Control

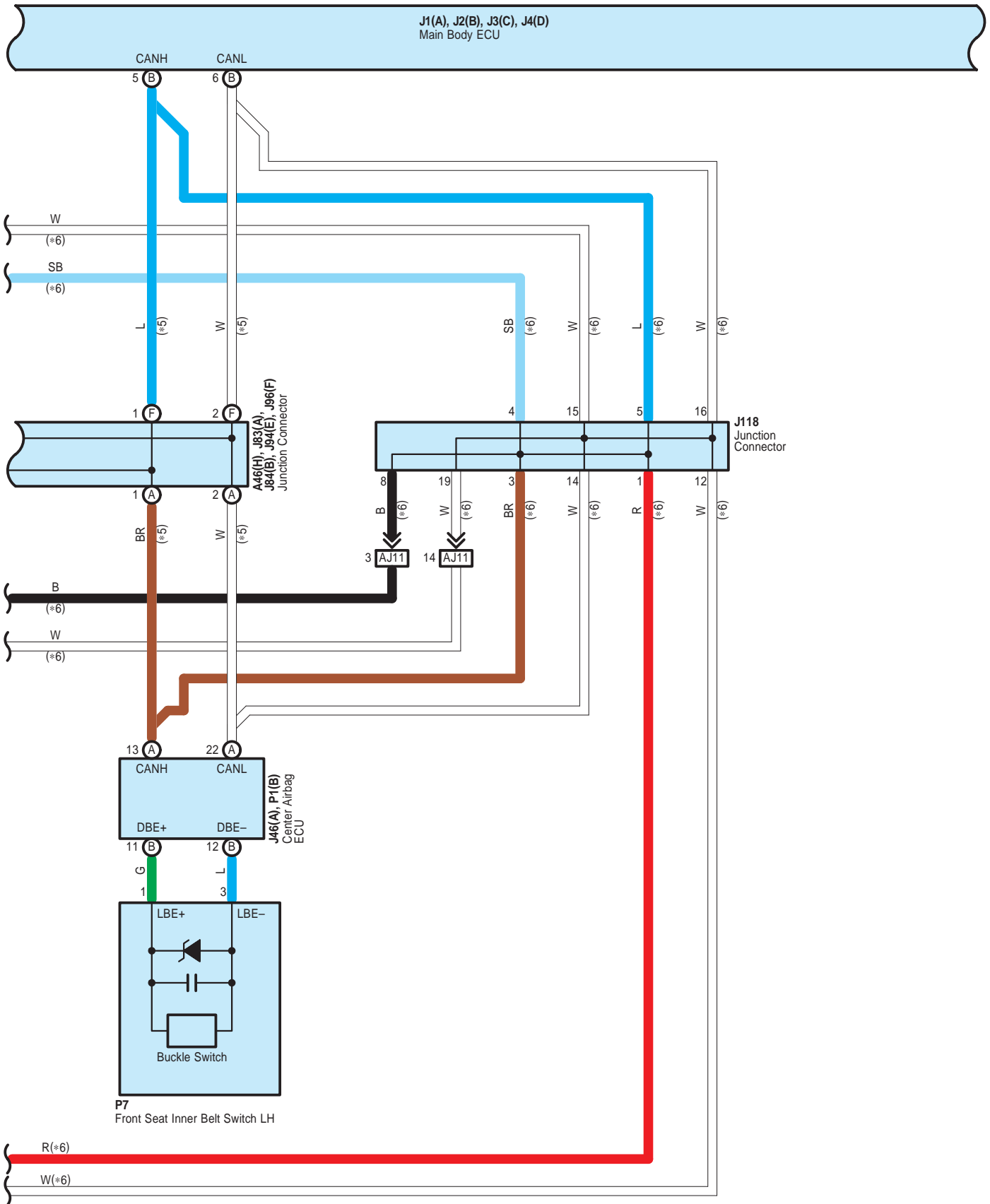

Door Lock Control

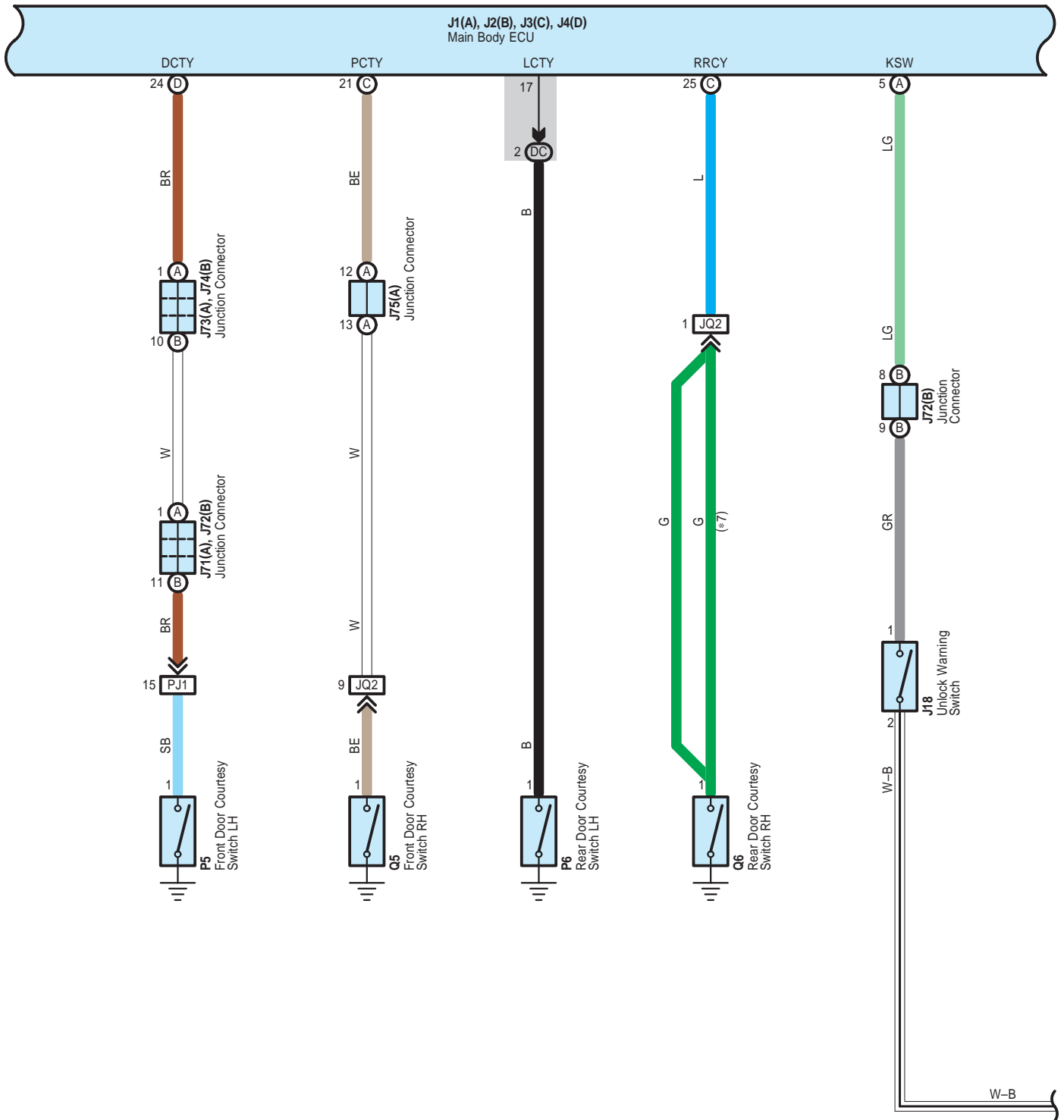

* 5 : Before Nov. 2009 Production
 * 6 : From Nov. 2009 Production
 * 7 : w/ Rear Door Courtesy Light

Door Lock Control

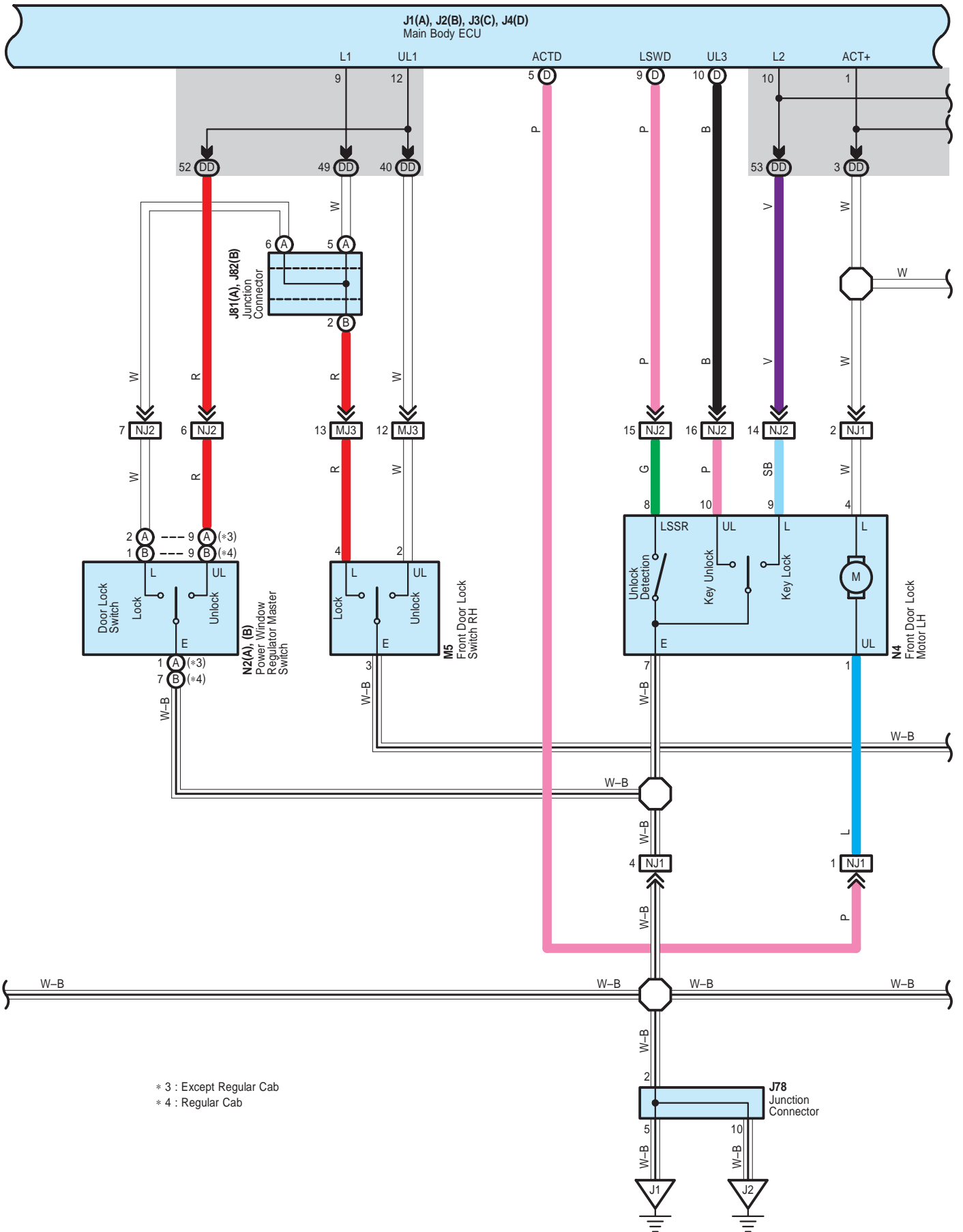

* 3 : Except Regular Cab
 * 4 : Regular Cab

Door Lock Control

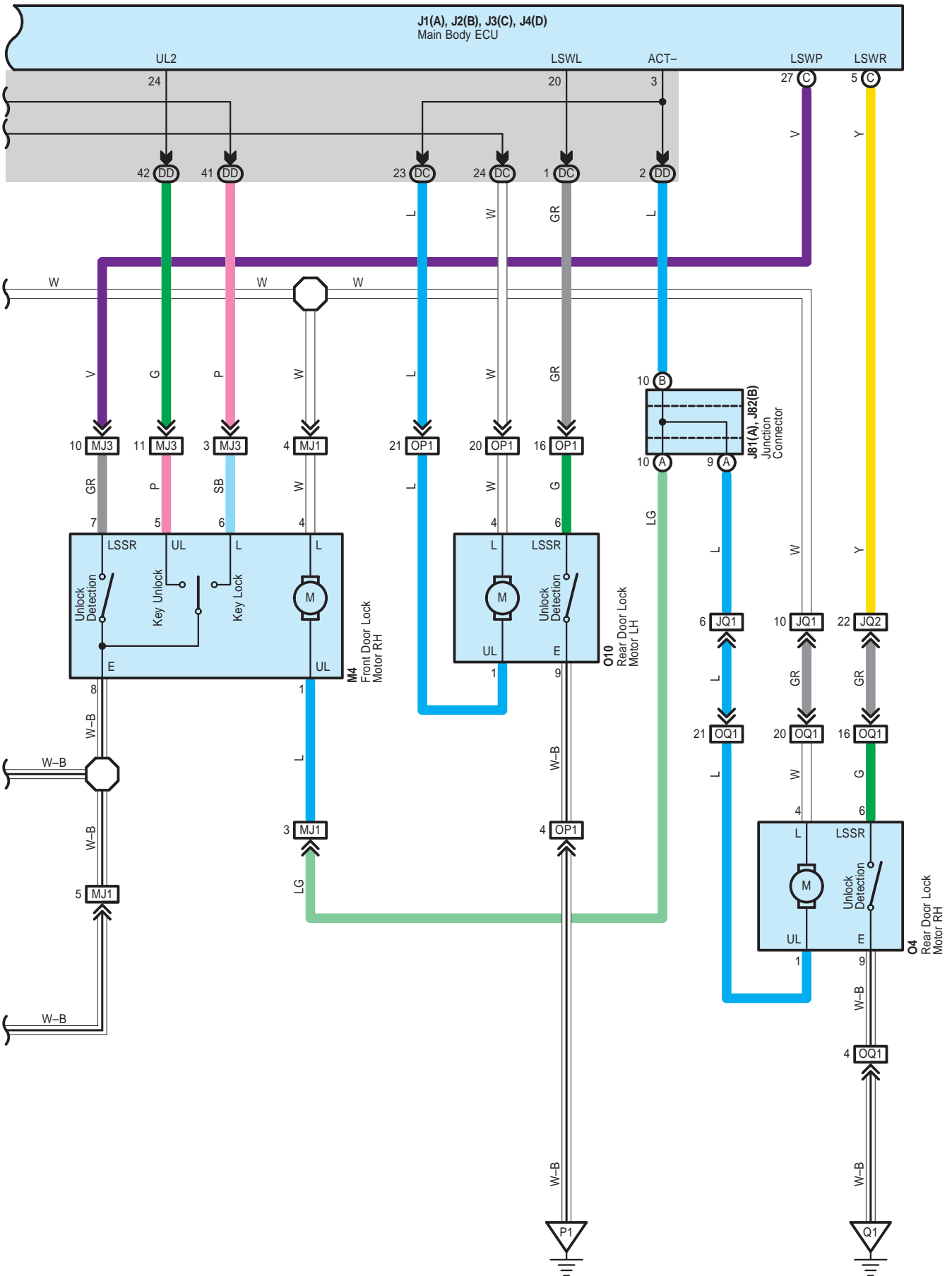

Door Lock Control

A 17
Black

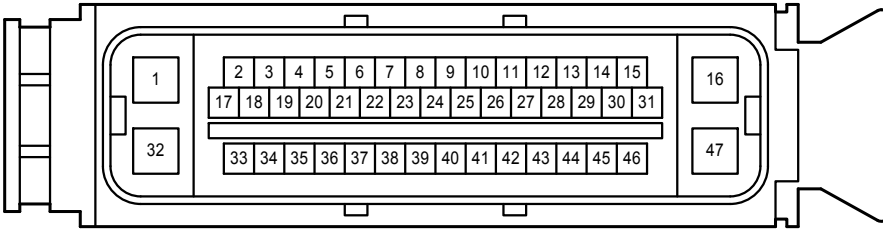

A 24
Black

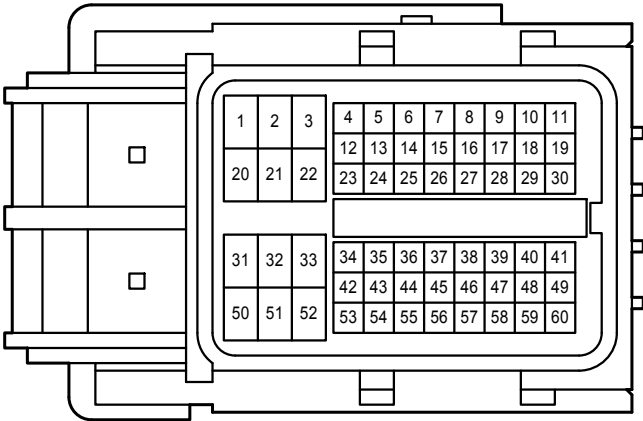

A 46
White

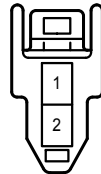

D 35
Gray

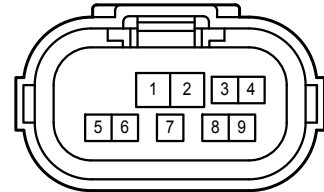

D 73
Blue

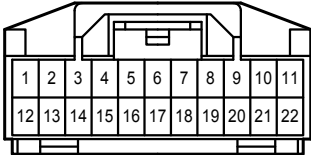

D 74
Black

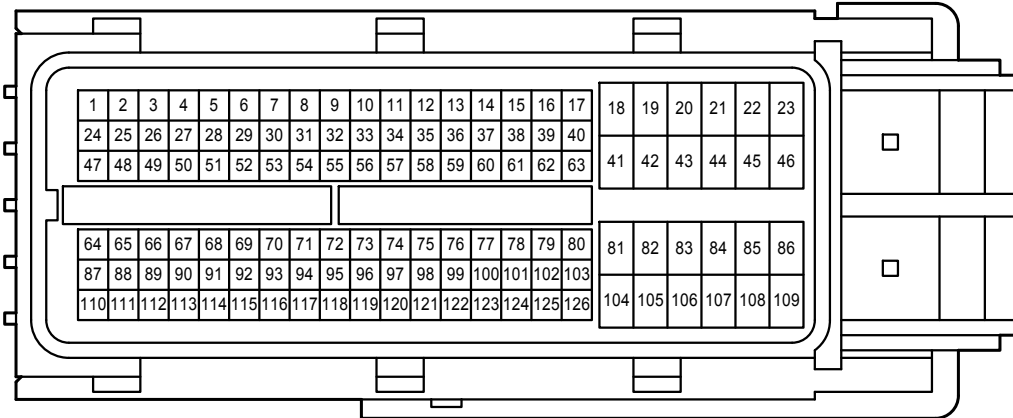

J 1
White

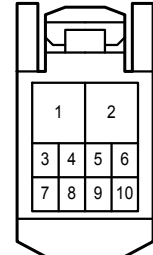

Door Lock Control

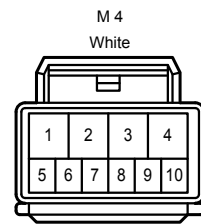
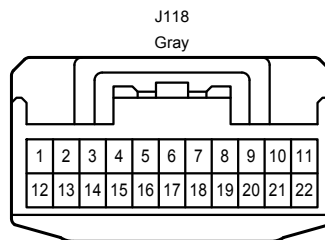
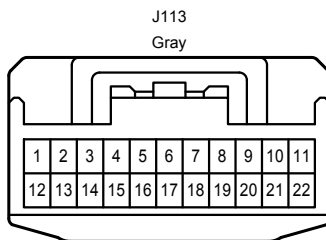
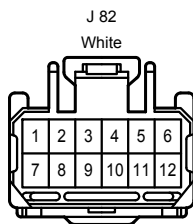
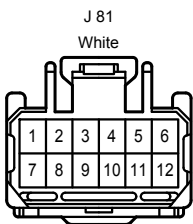
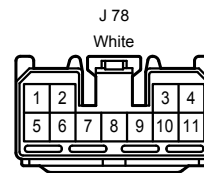
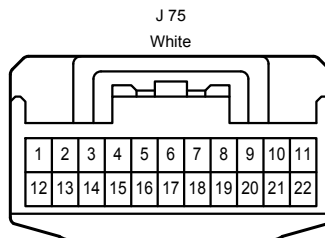
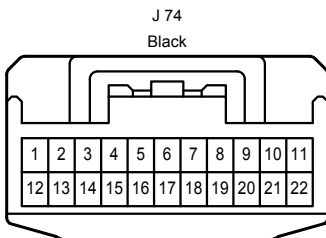
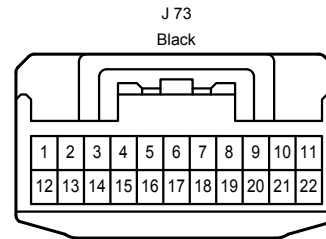
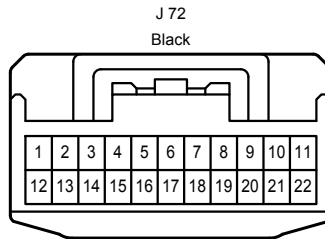
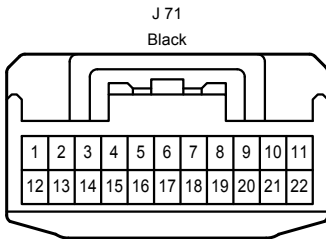
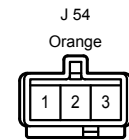
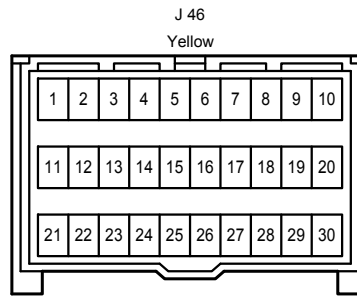
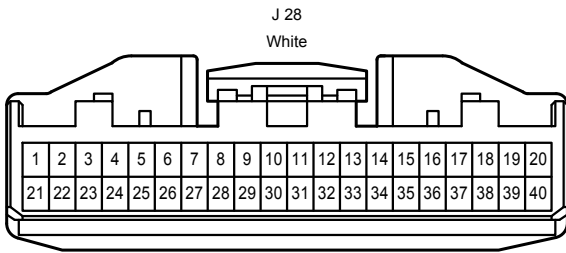
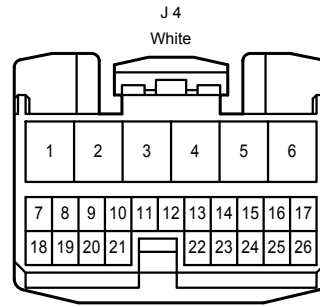
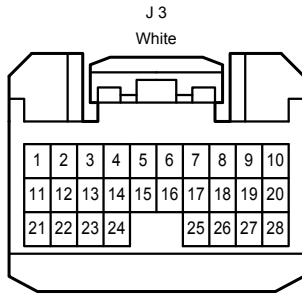
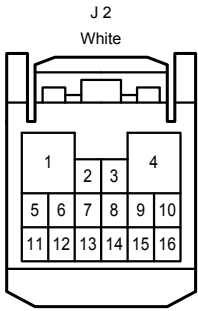

Door Lock Control

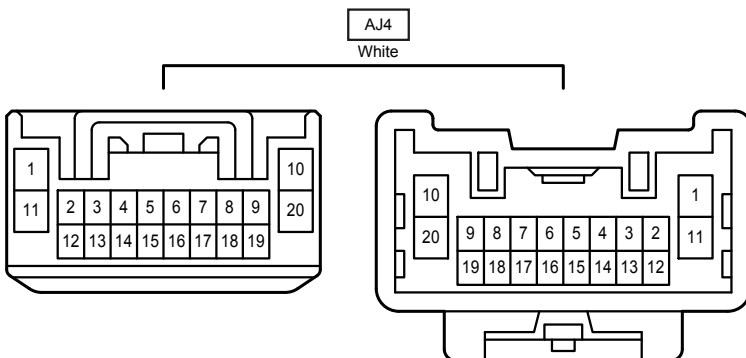
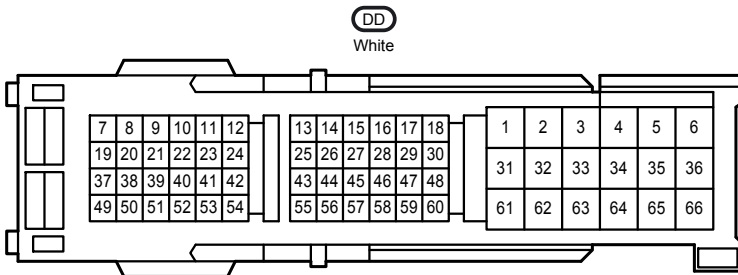
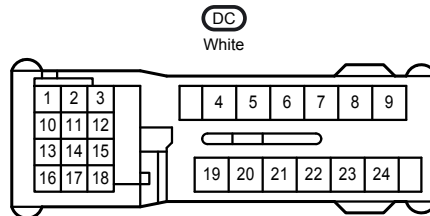
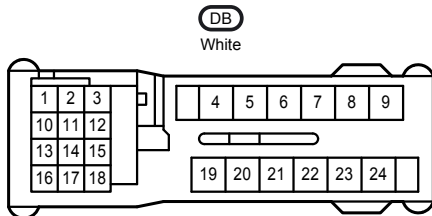
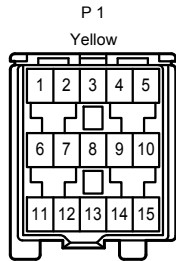
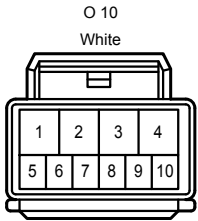
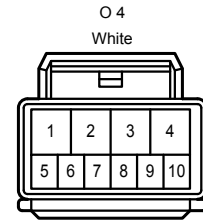
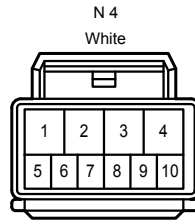
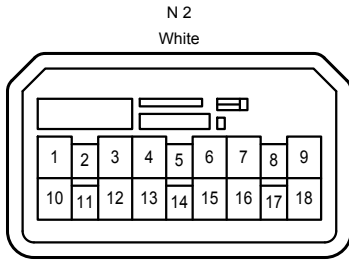
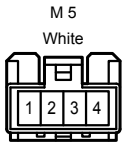

Door Lock Control

AJ5
White

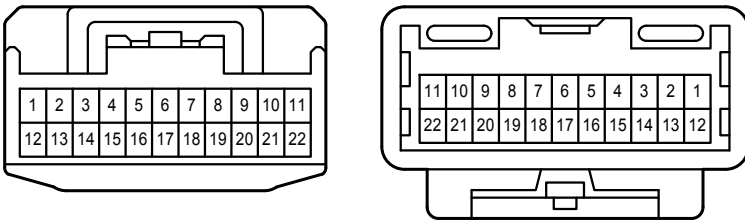

AJ11
Gray

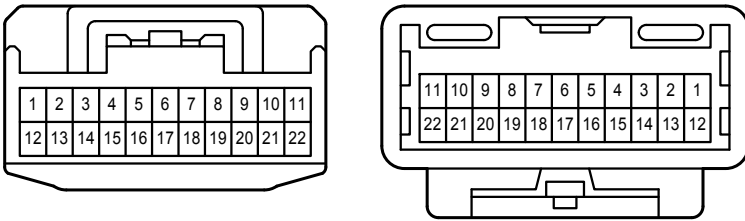

DA1
White

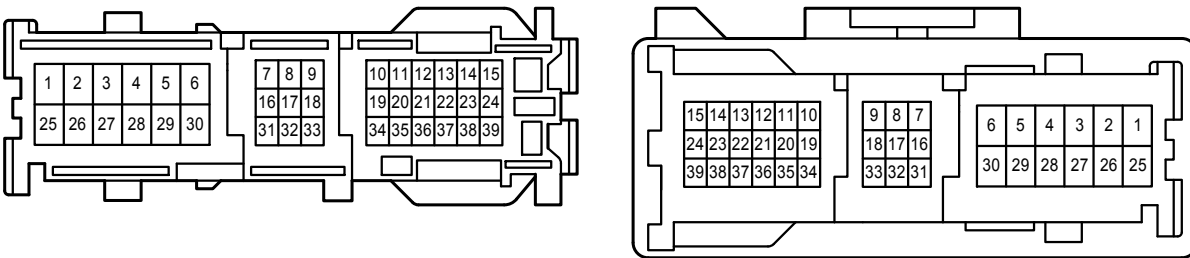

JQ1
Gray

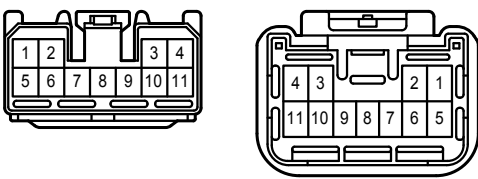

JQ2
Gray

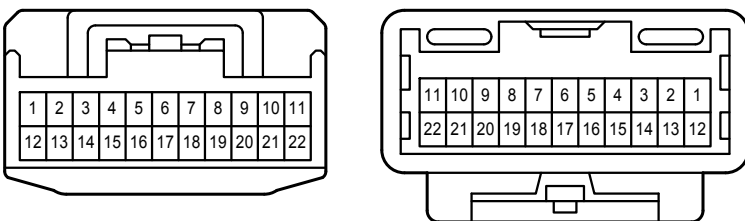

MJ1
Blue

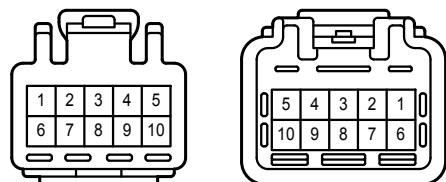

Door Lock Control

MJ3
Blue

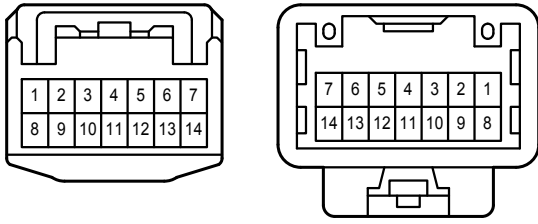

NJ1
Blue

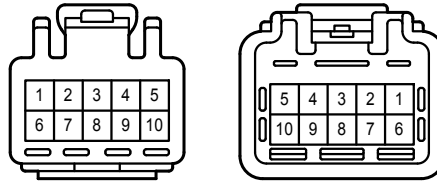

NJ2
Blue

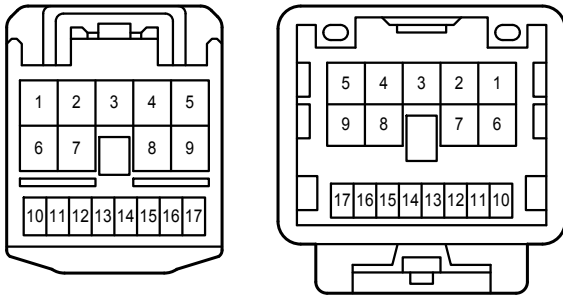

OP1
White

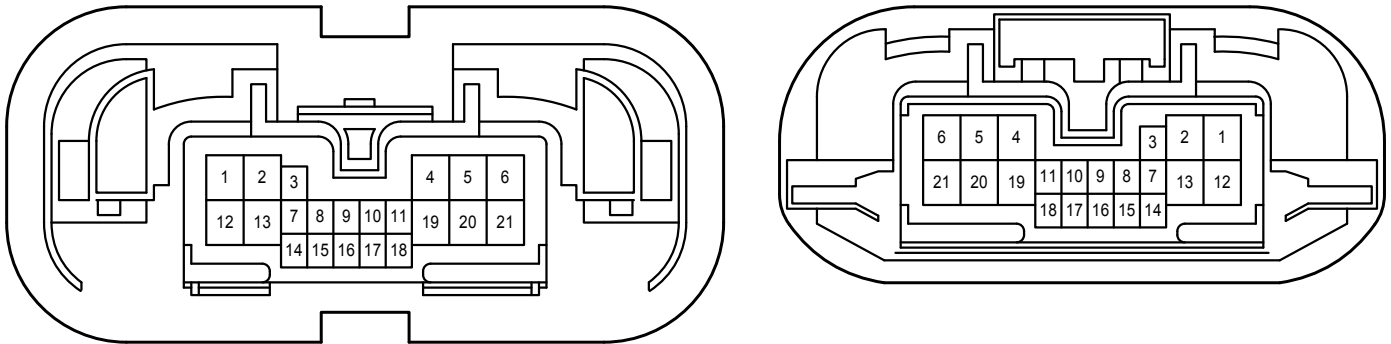

OQ1
White

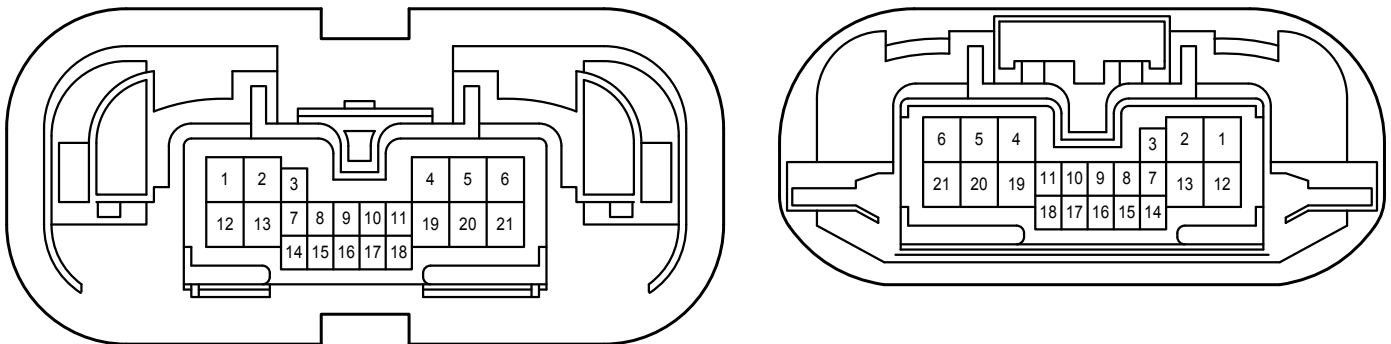

PJ1
Black

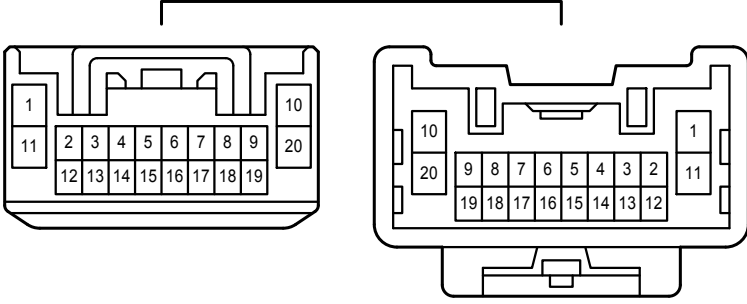

Electronically Controlled Transmission and A/T Indicator <1GR-FE>

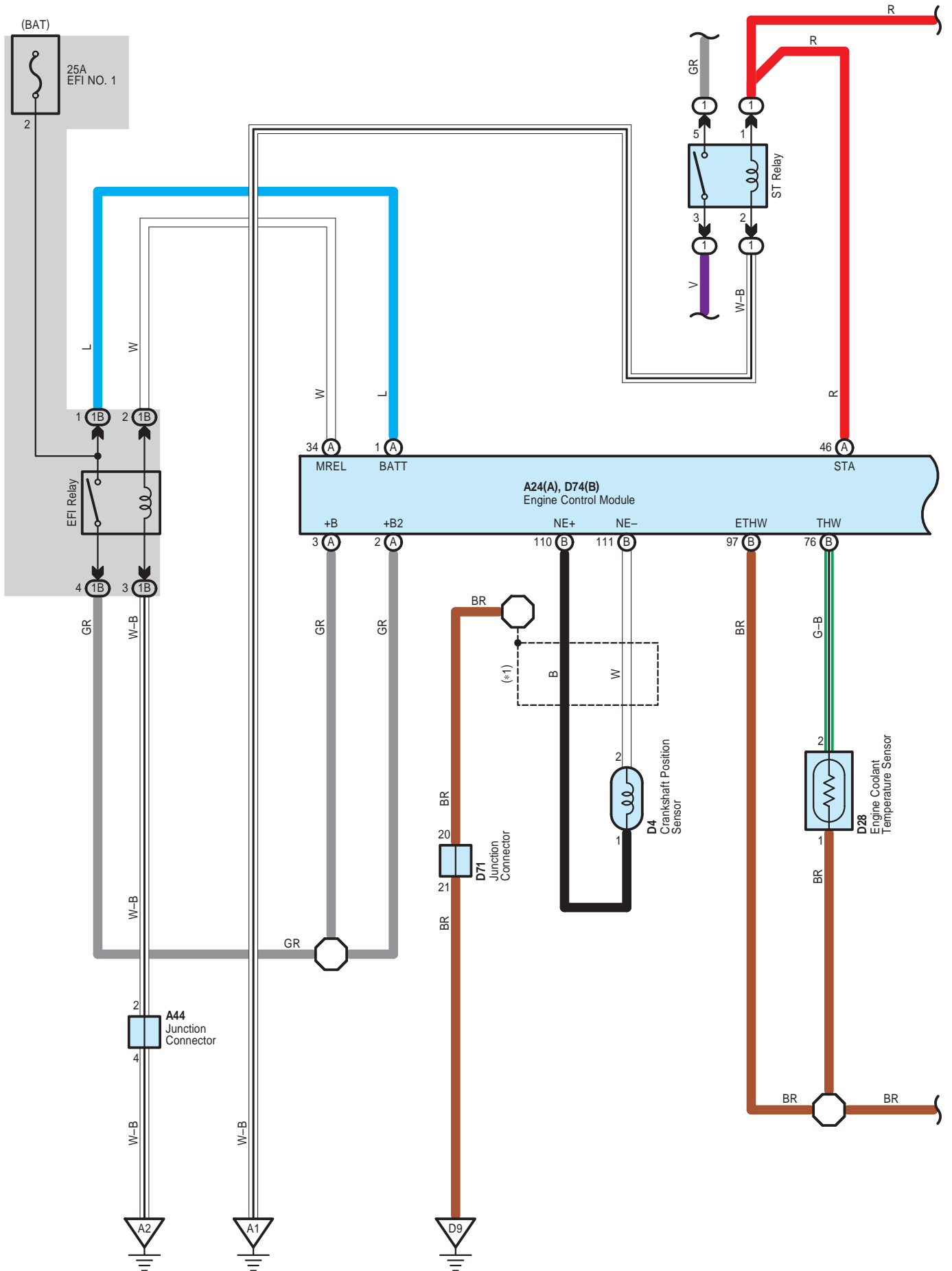

Electronically Controlled Transmission and A/T Indicator <1GR-FE>

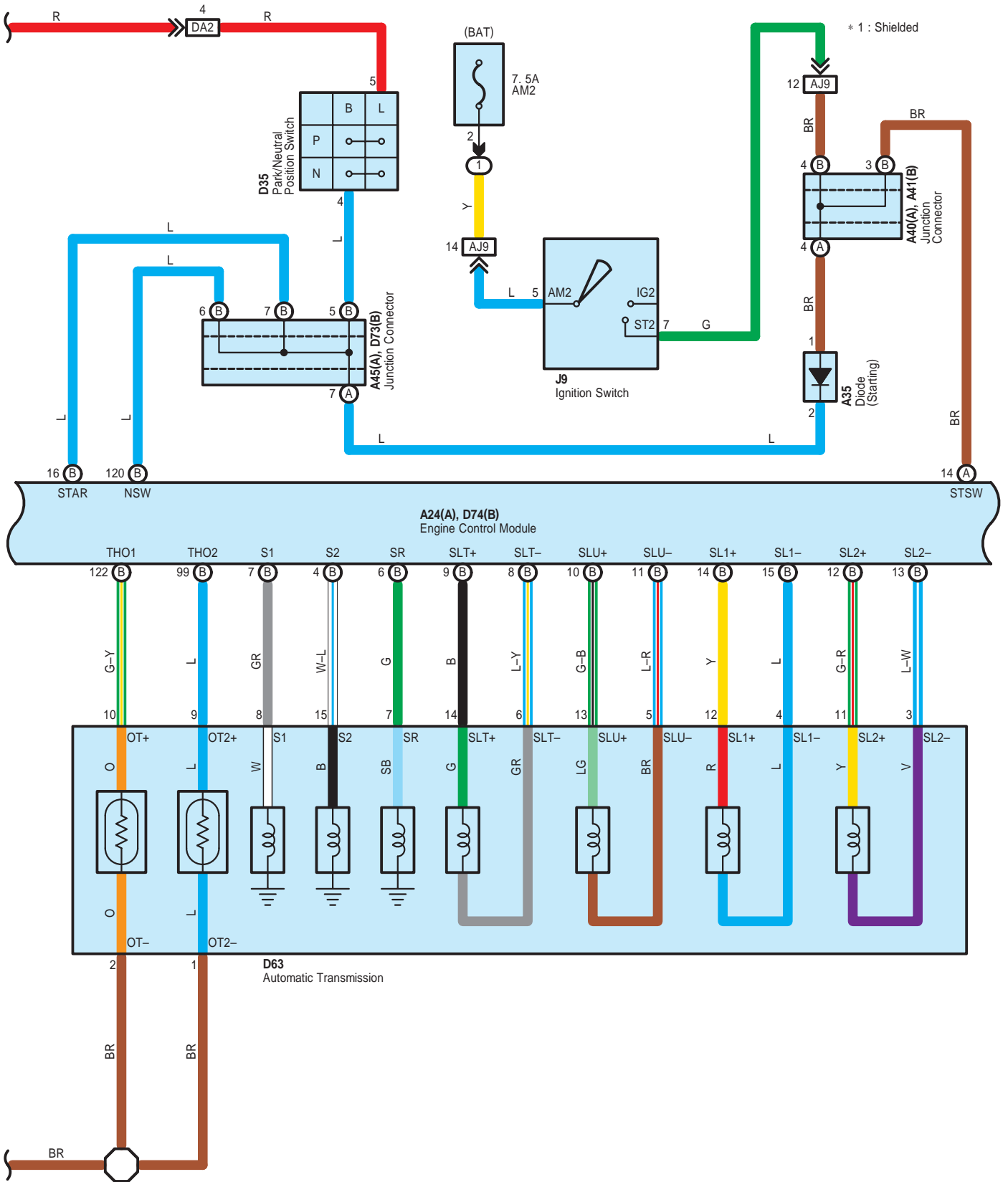

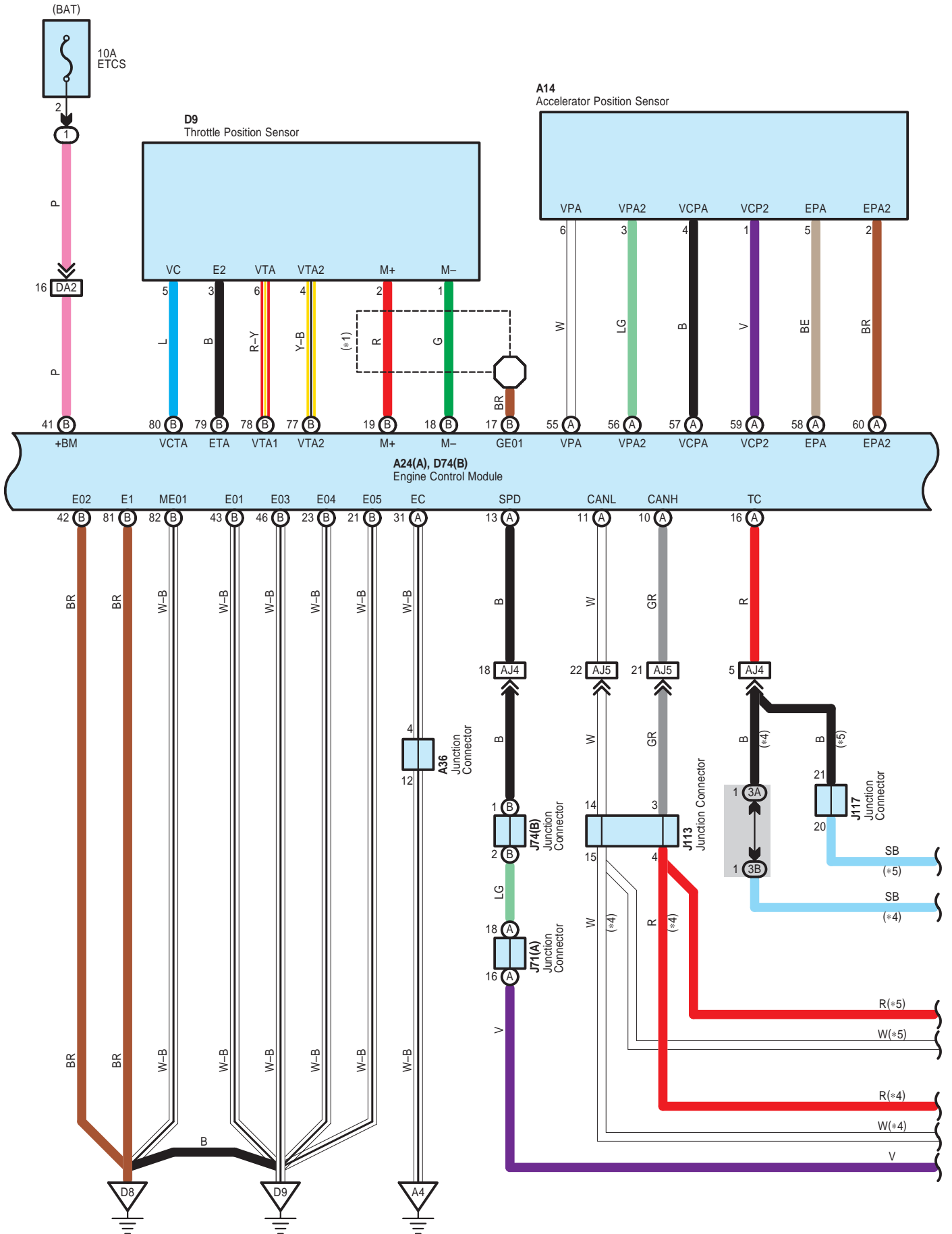

Electronically Controlled Transmission and A/T Indicator <1GR-FE>

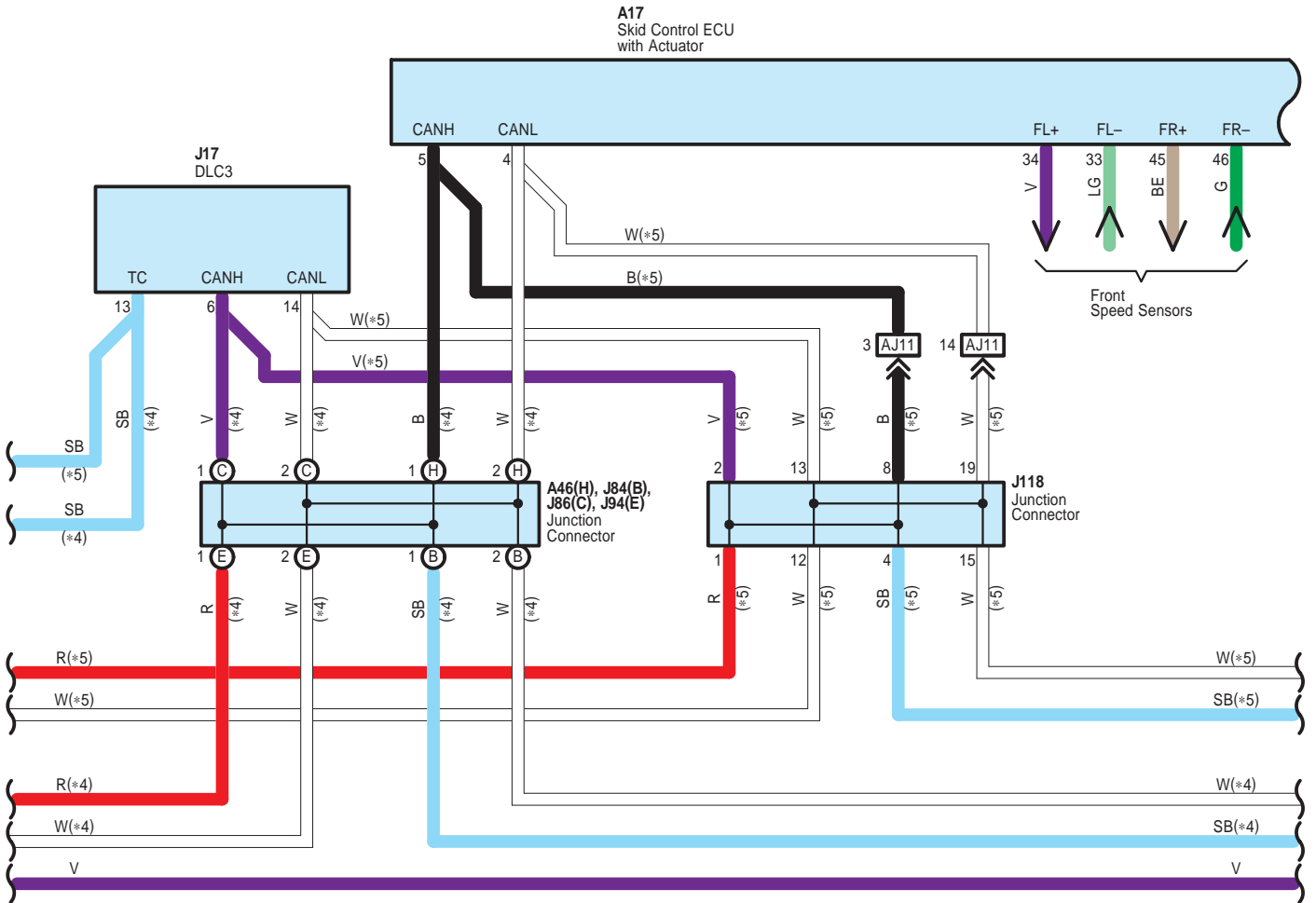
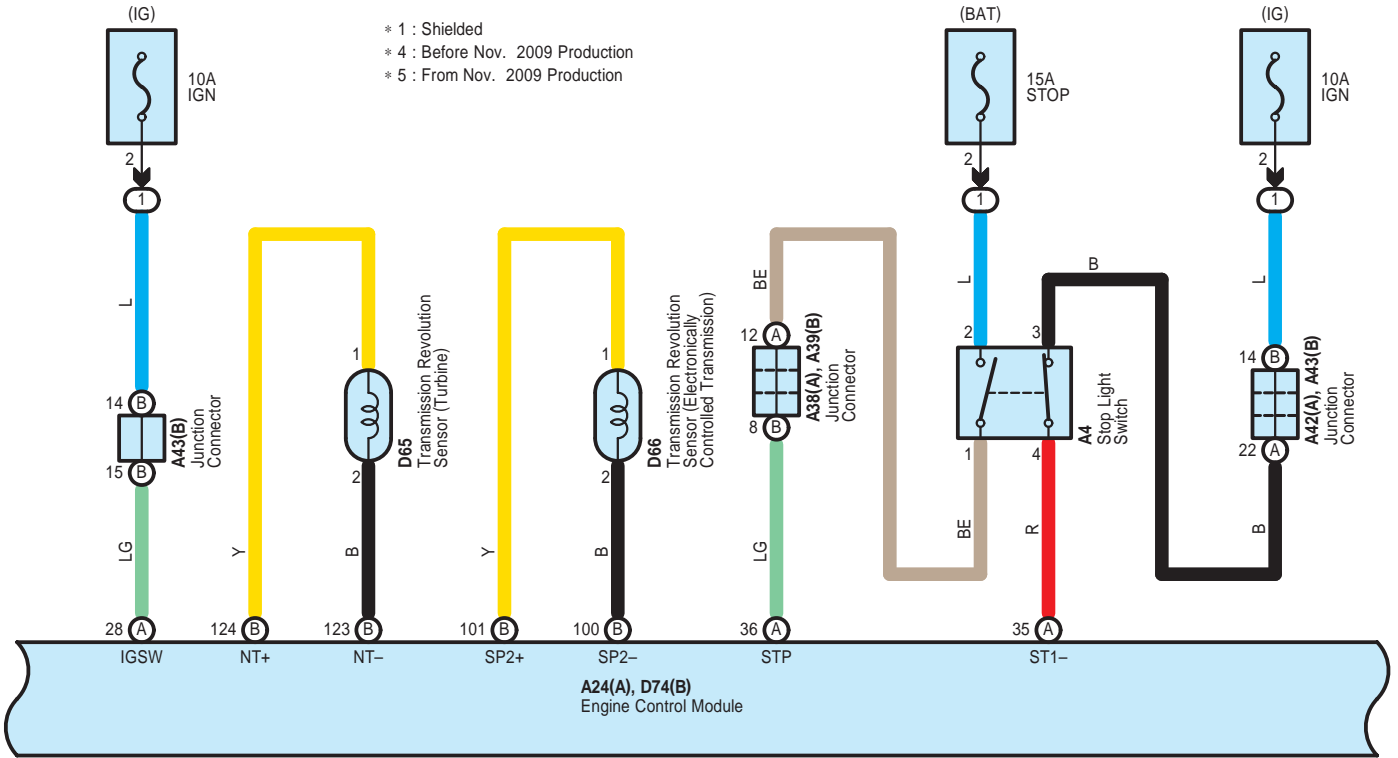

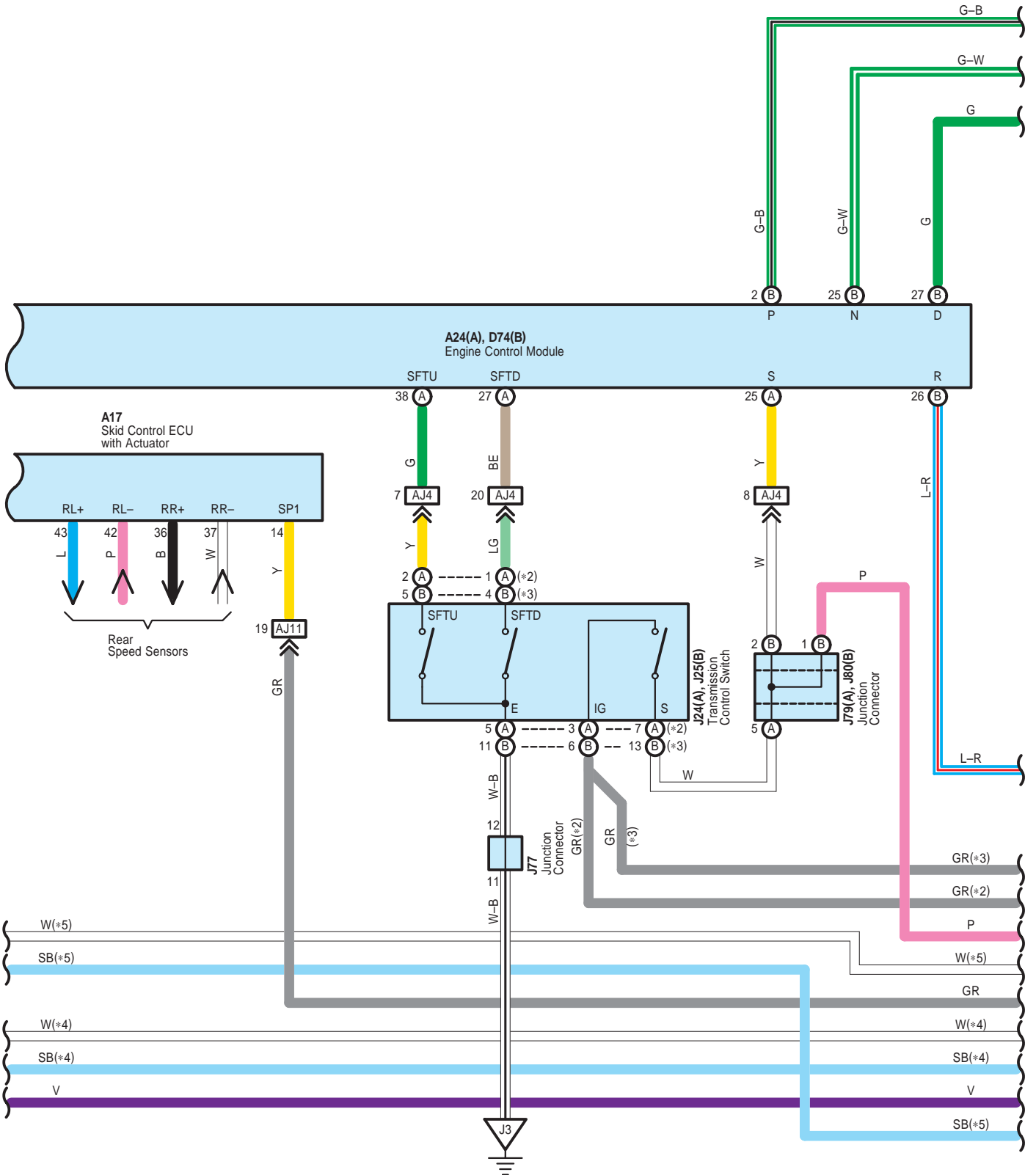

Electronically Controlled Transmission and A/T Indicator <1GR-FE>

- * 2 : Floor Shift
- * 3 : Column Shift
- * 4 : Before Nov. 2009 Production
- * 5 : From Nov. Production

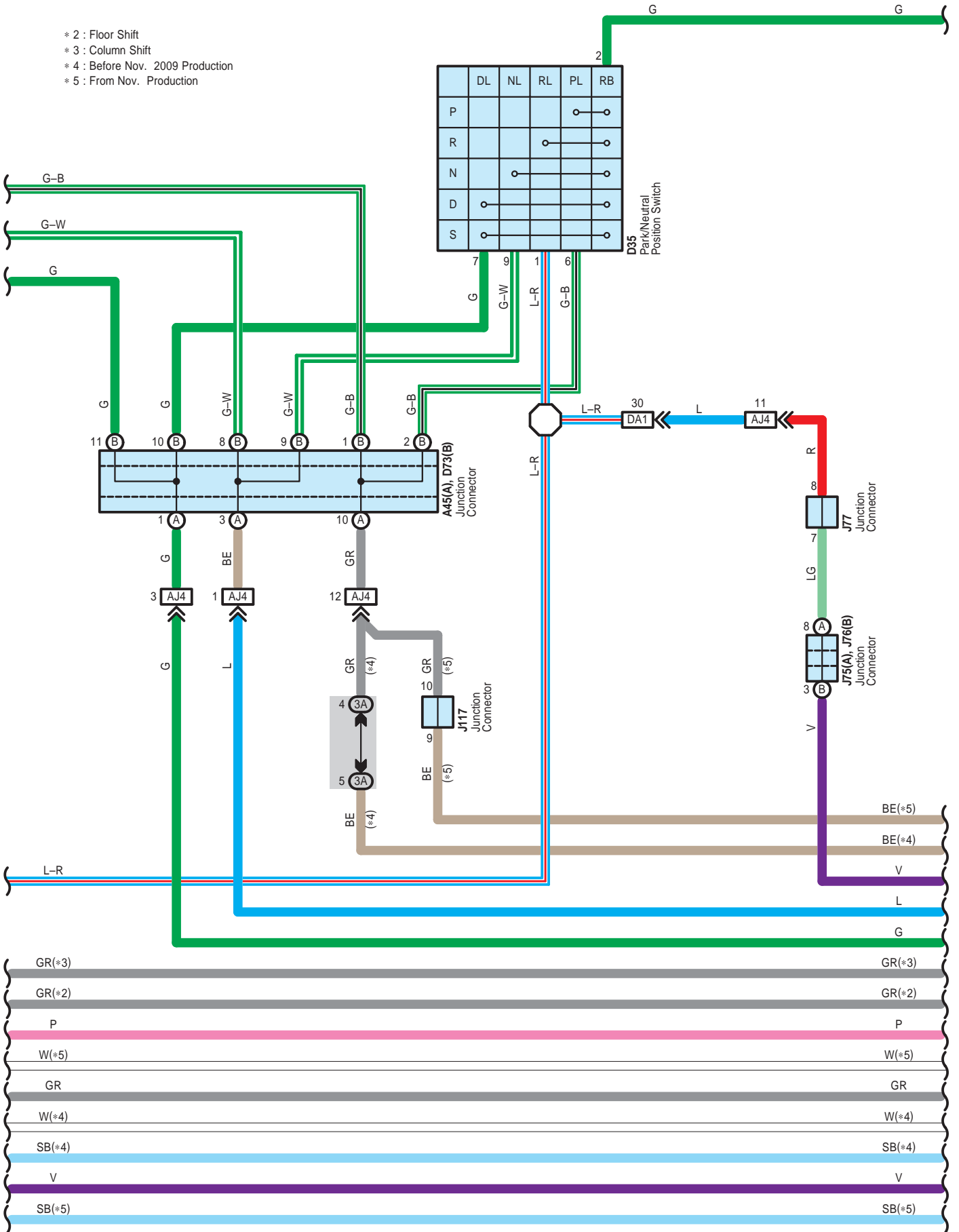

Electronically Controlled Transmission and A/T Indicator <1GR-FE>

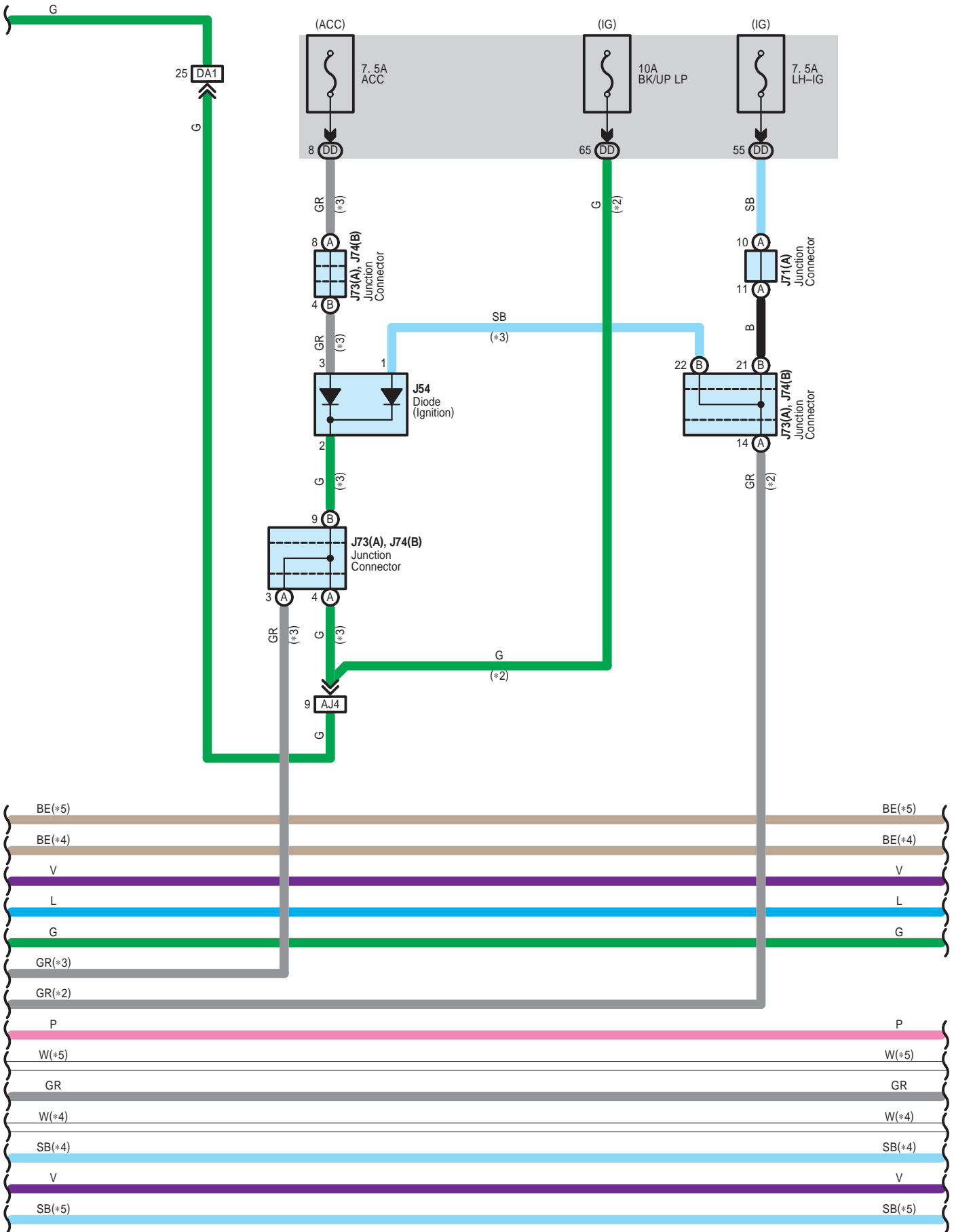

Electronically Controlled Transmission and A/T Indicator <1GR-FE>

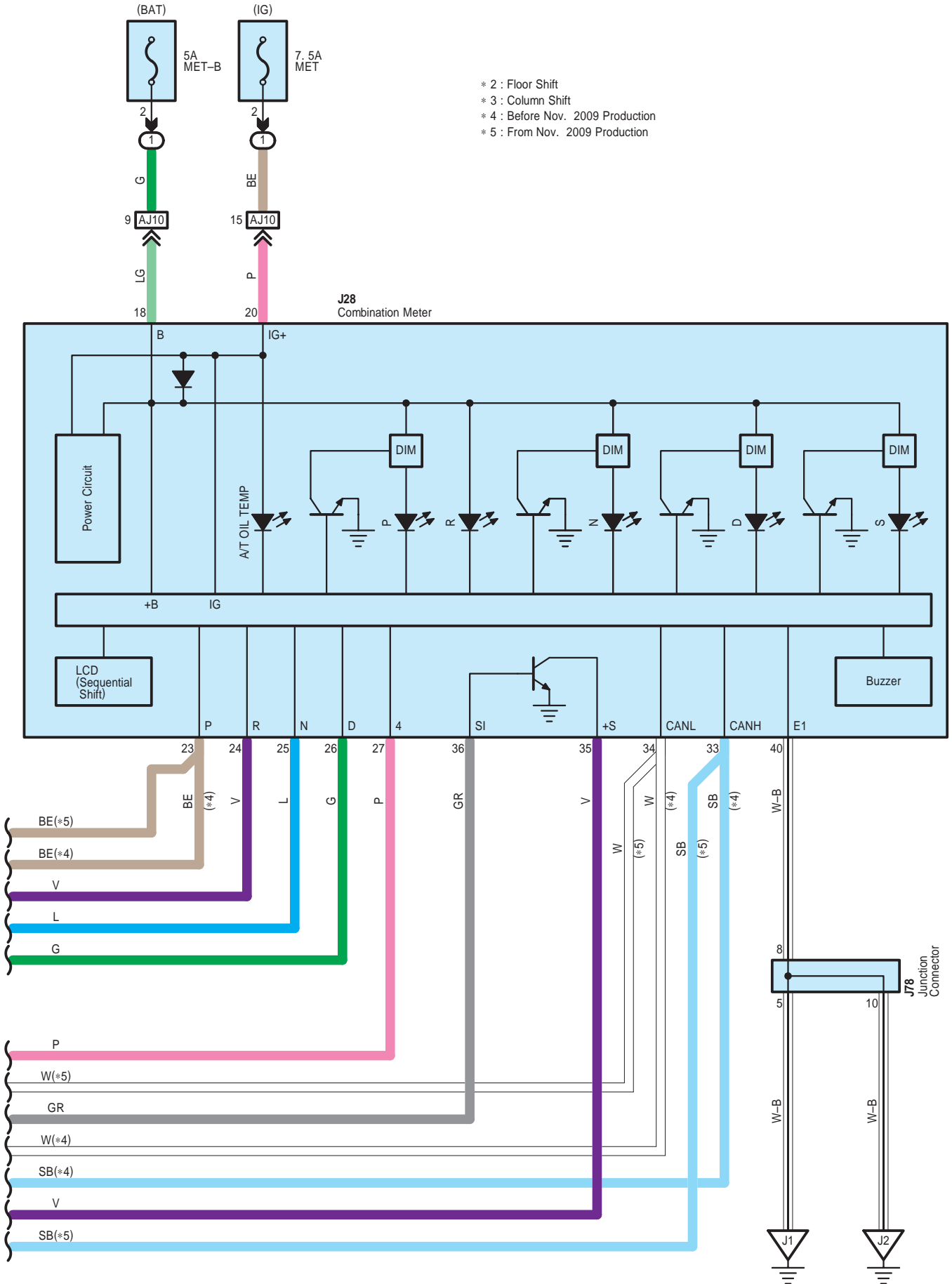

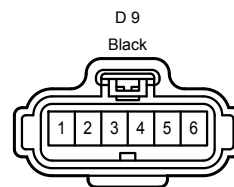
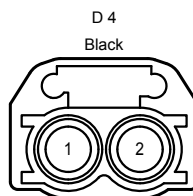
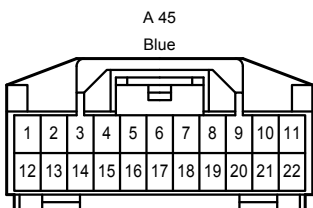
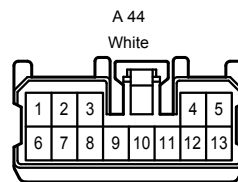
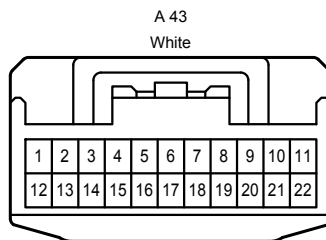
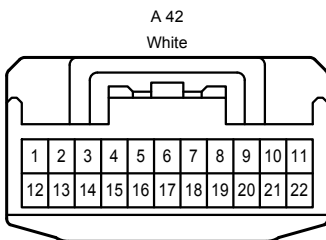
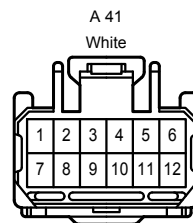
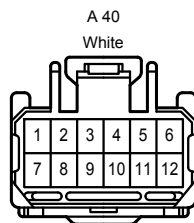
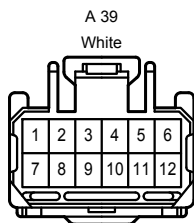
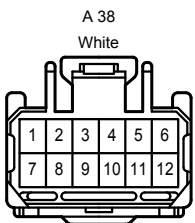
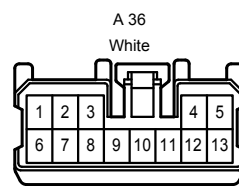
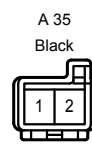
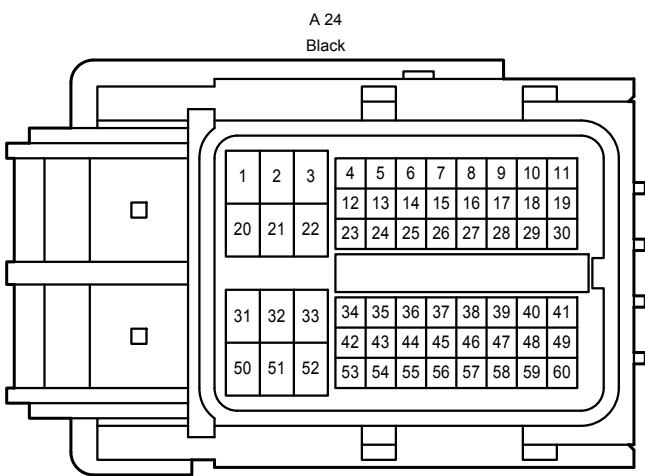
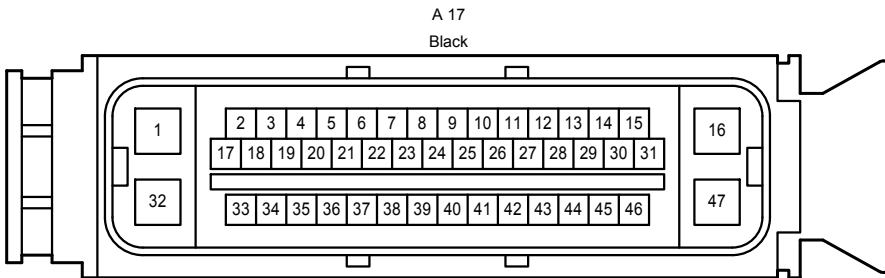
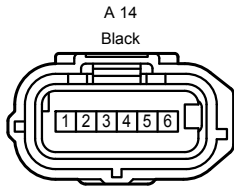
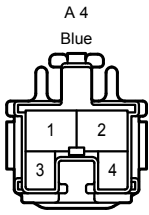

Electronically Controlled Transmission and A/T Indicator <1GR-FE>

D 28
Dark Gray



D 35
Gray

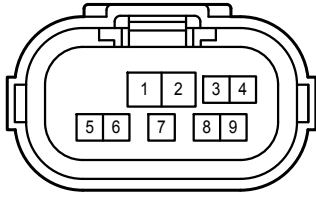

D 63
Gray

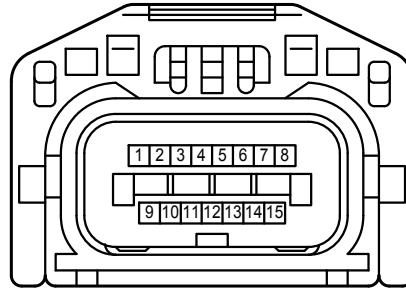

D 65
Black

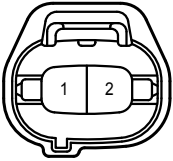

D 66
Black

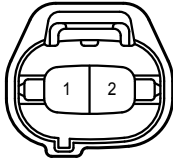

D 71
White

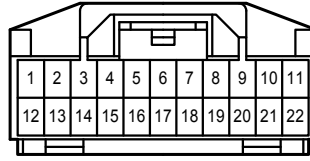

D 73
Blue

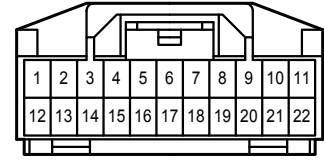

D 74
Black

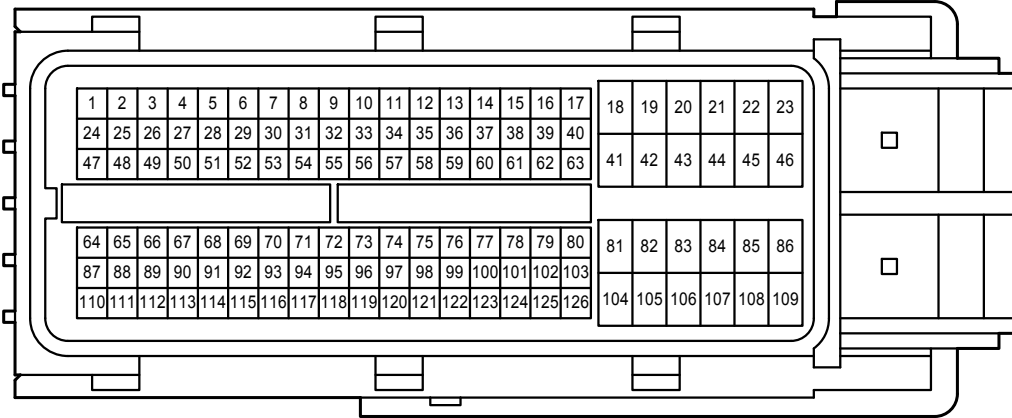

J 9
White

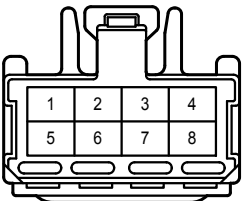

J 17
White

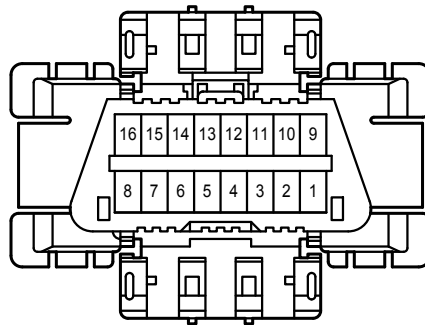

J 24
White

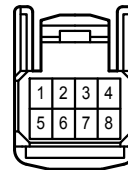

J 25
White

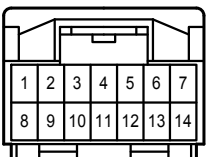

J 28
White

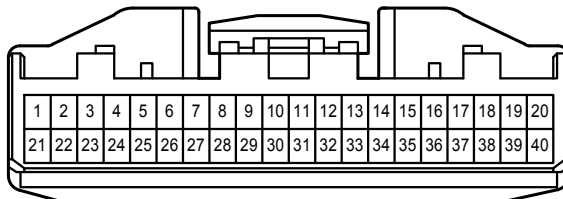

J 54
Orange



J 71
Black

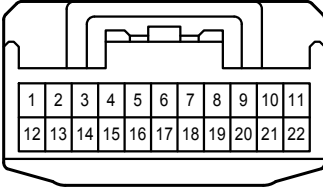

J 73
Black

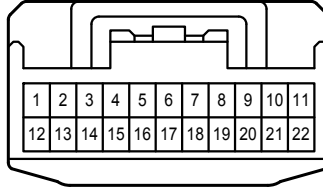

J 74
Black

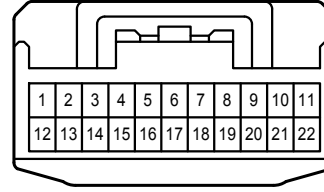

J 75
White

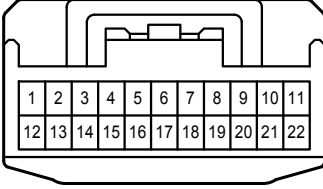

J 76
White

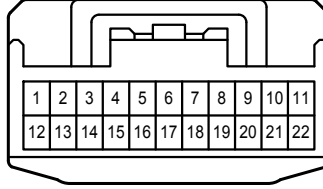

J 77
Gray

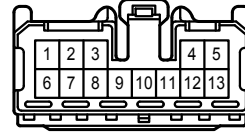

J 78
White

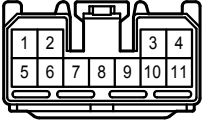

J 79
White

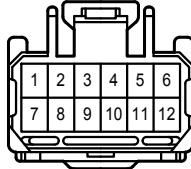

J 80
White

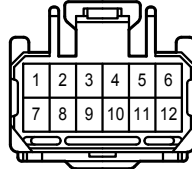

J 84
White

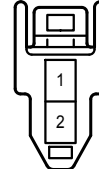

J 86
White

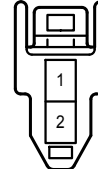

J 94
White

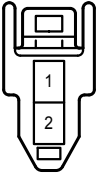

J113
Gray

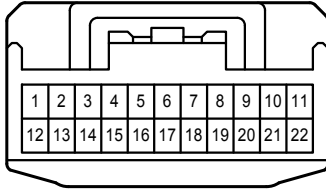

J117
Black

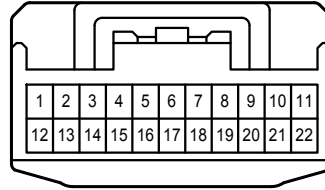

J118
Gray

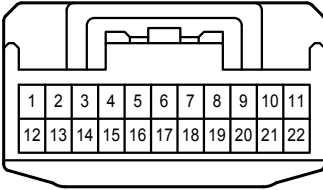

1B
White

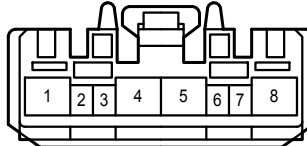

3A
Black

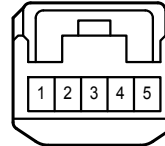

3B
White

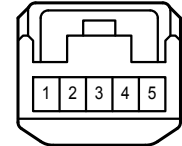

DD
White

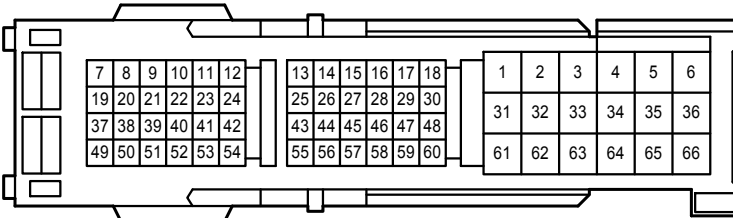

AJ4
White

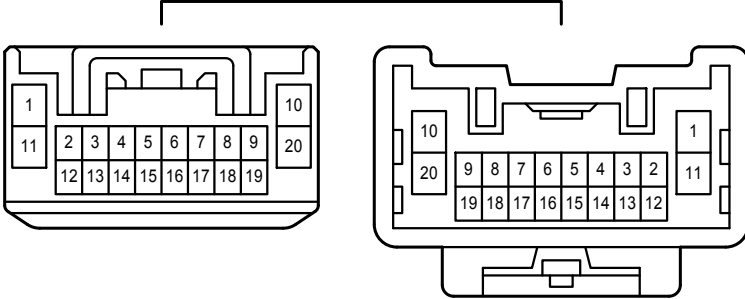

AJ5
White

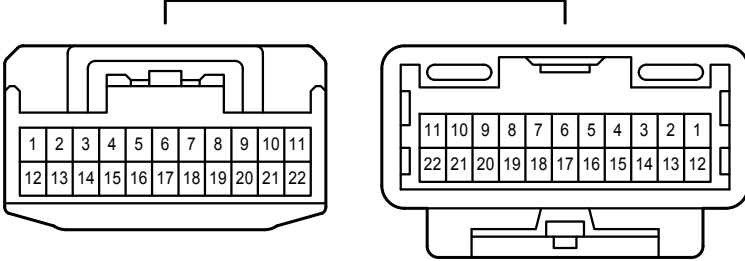

AJ9
Gray

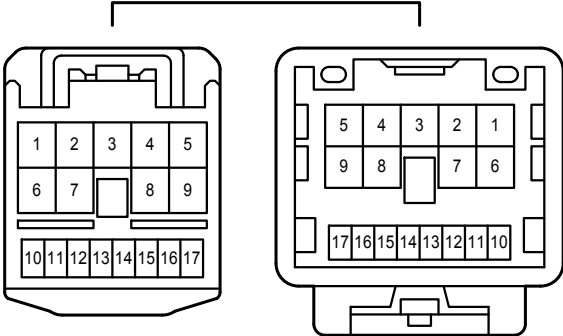

AJ10
Gray

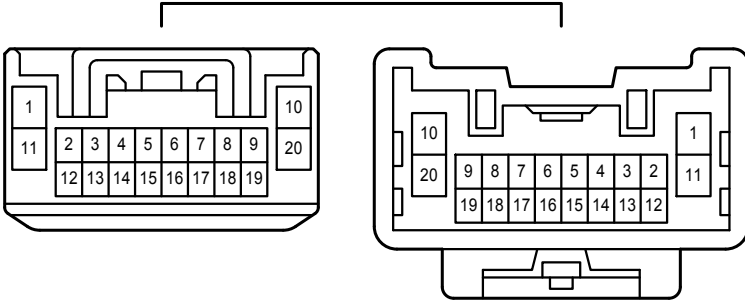

Electronically Controlled Transmission and A/T Indicator <1GR-FE>

AJ11
Gray

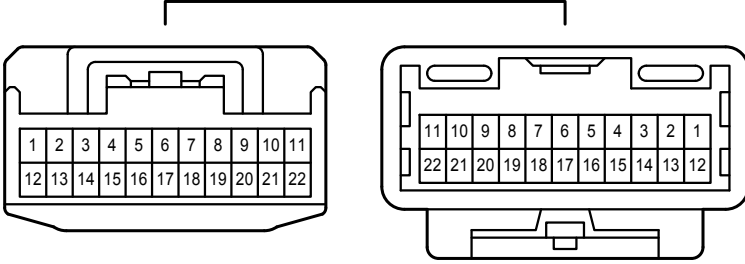

DA1
White

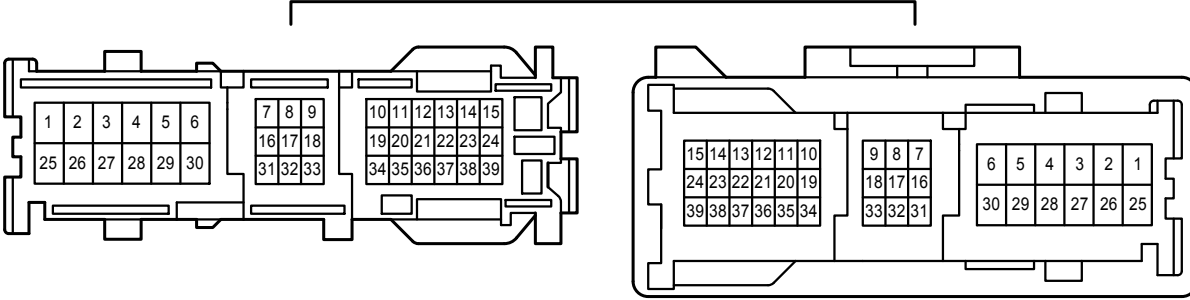

DA2
White

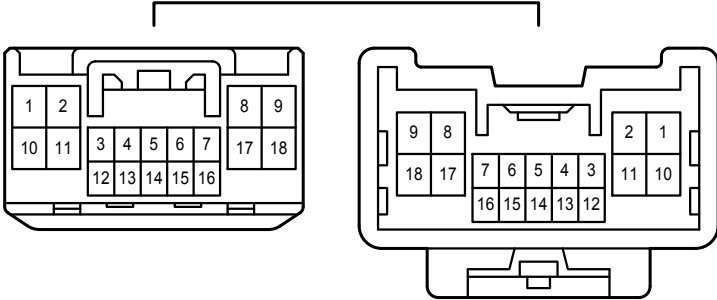

Electronically Controlled Transmission and A/T Indicator <1UR-FE>

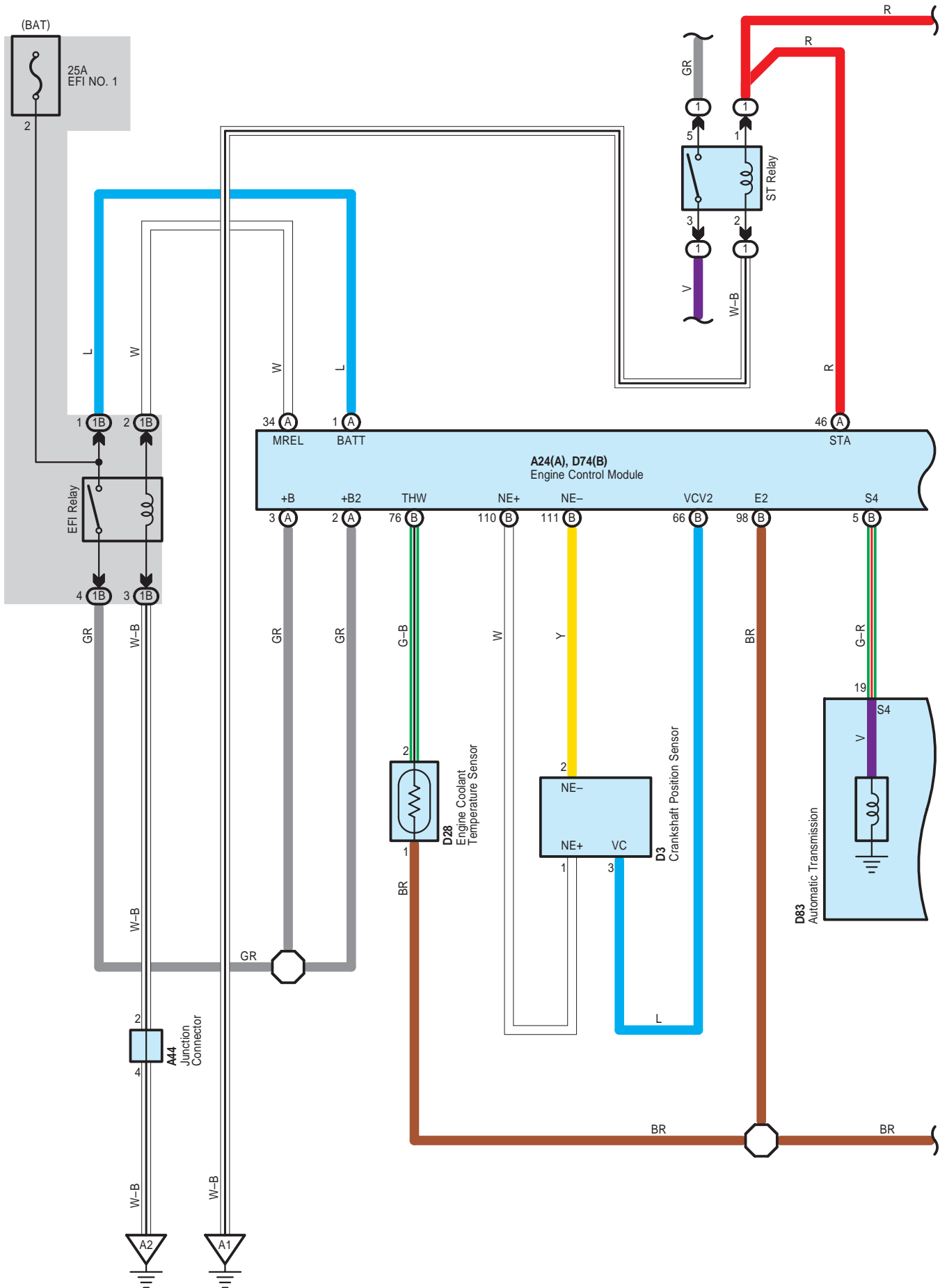

Electronically Controlled Transmission and A/T Indicator <1UR-FE>

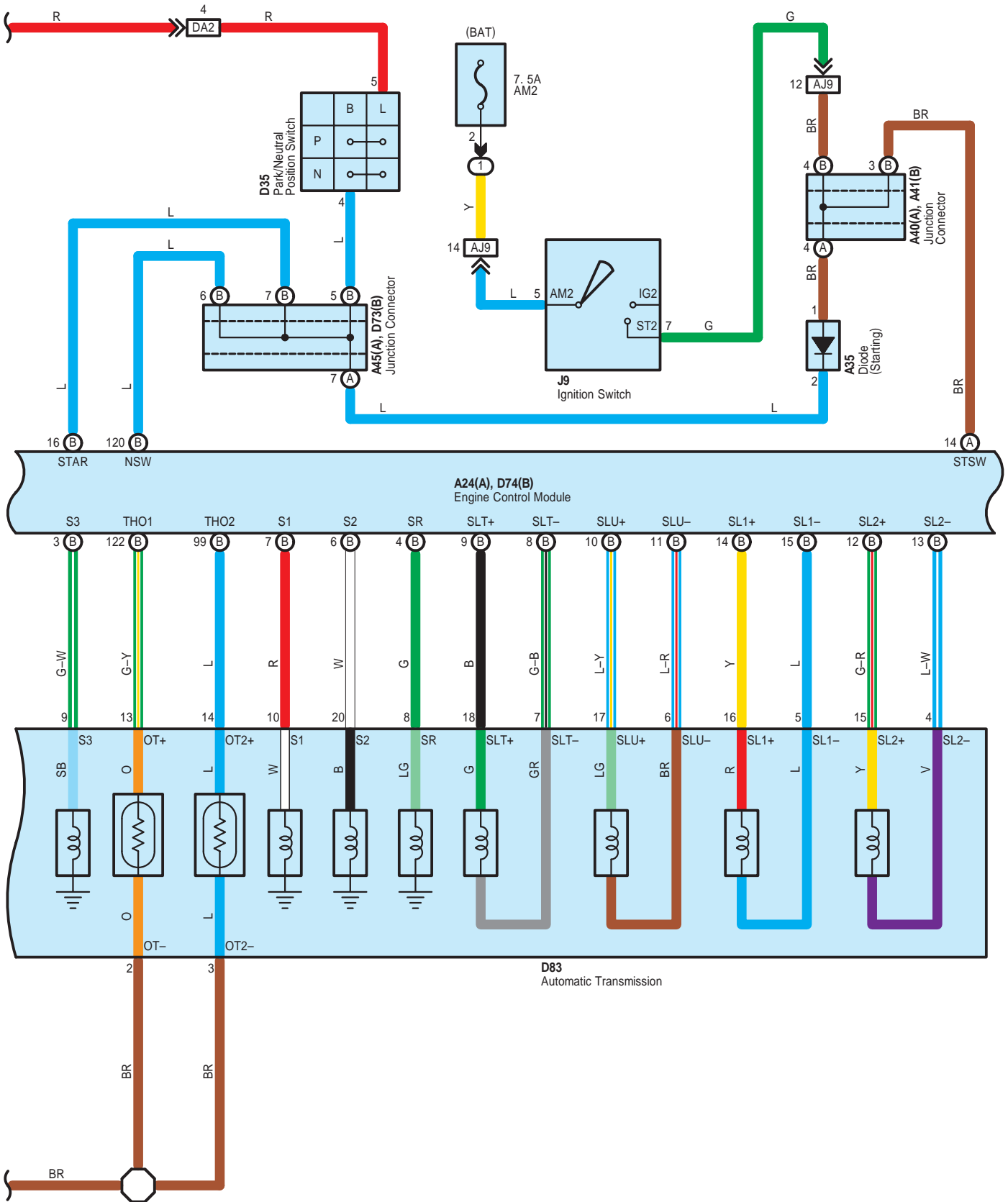

Electronically Controlled Transmission and A/T Indicator <1UR-FE>

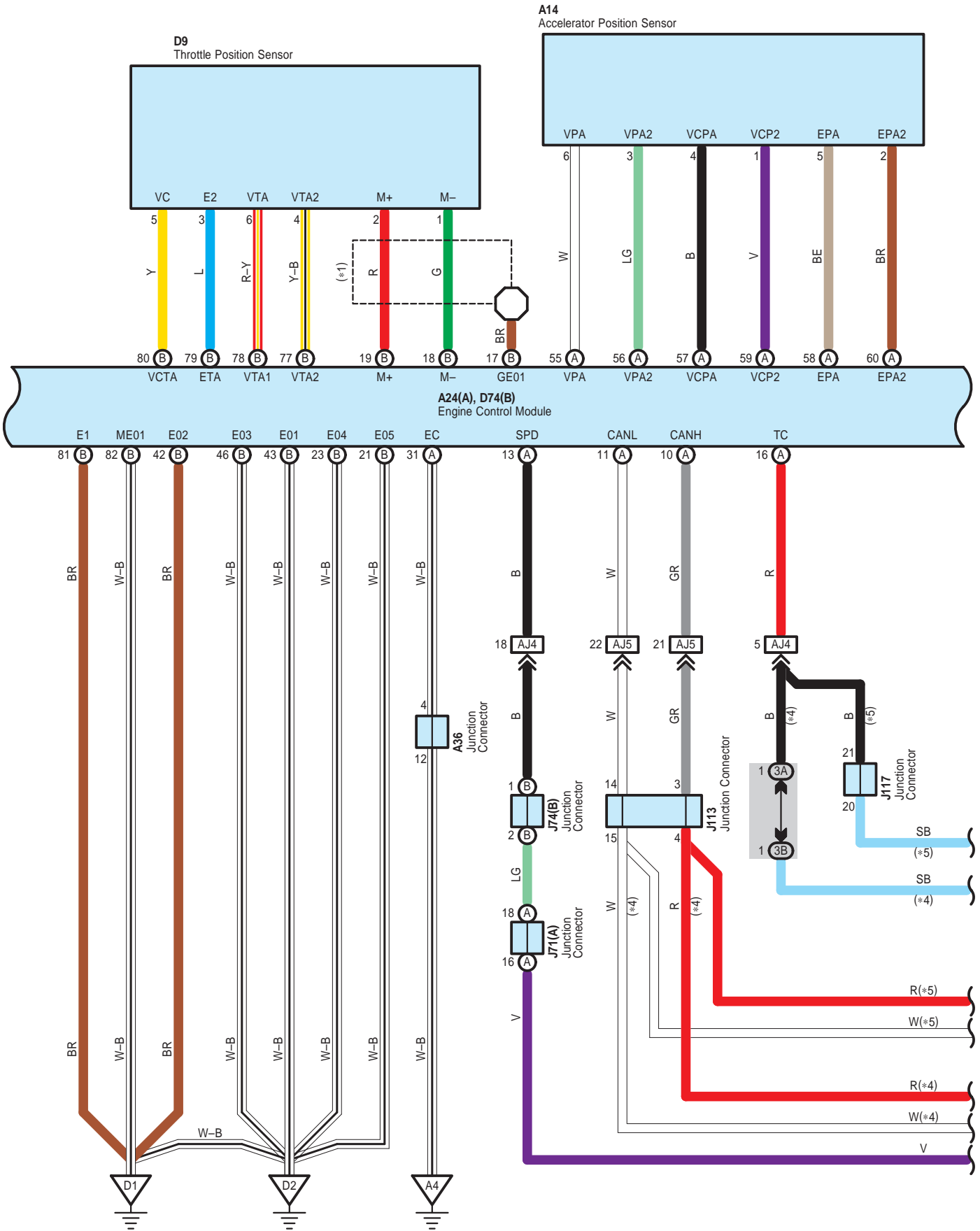

Electronically Controlled Transmission and A/T Indicator <1UR-FE>

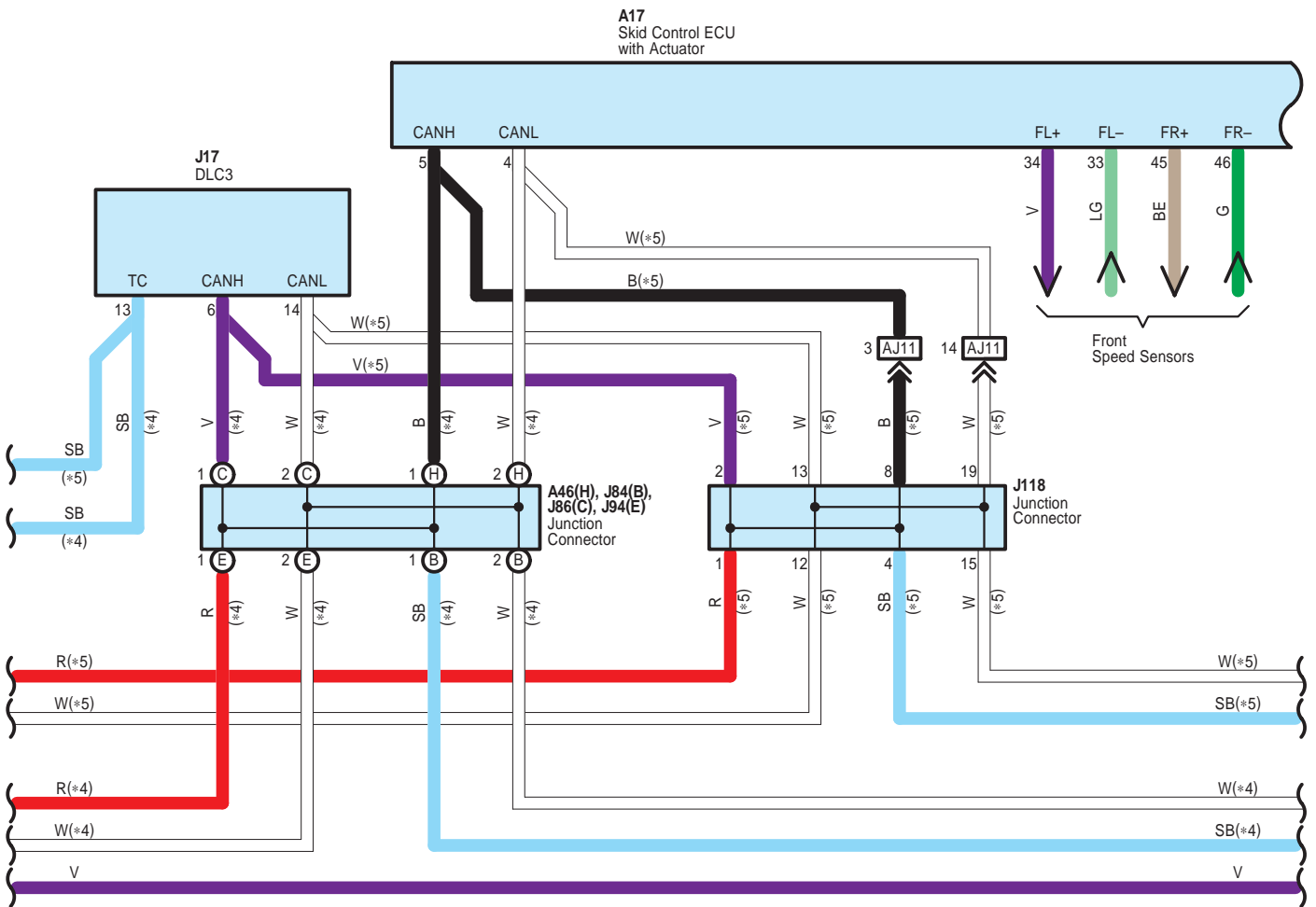
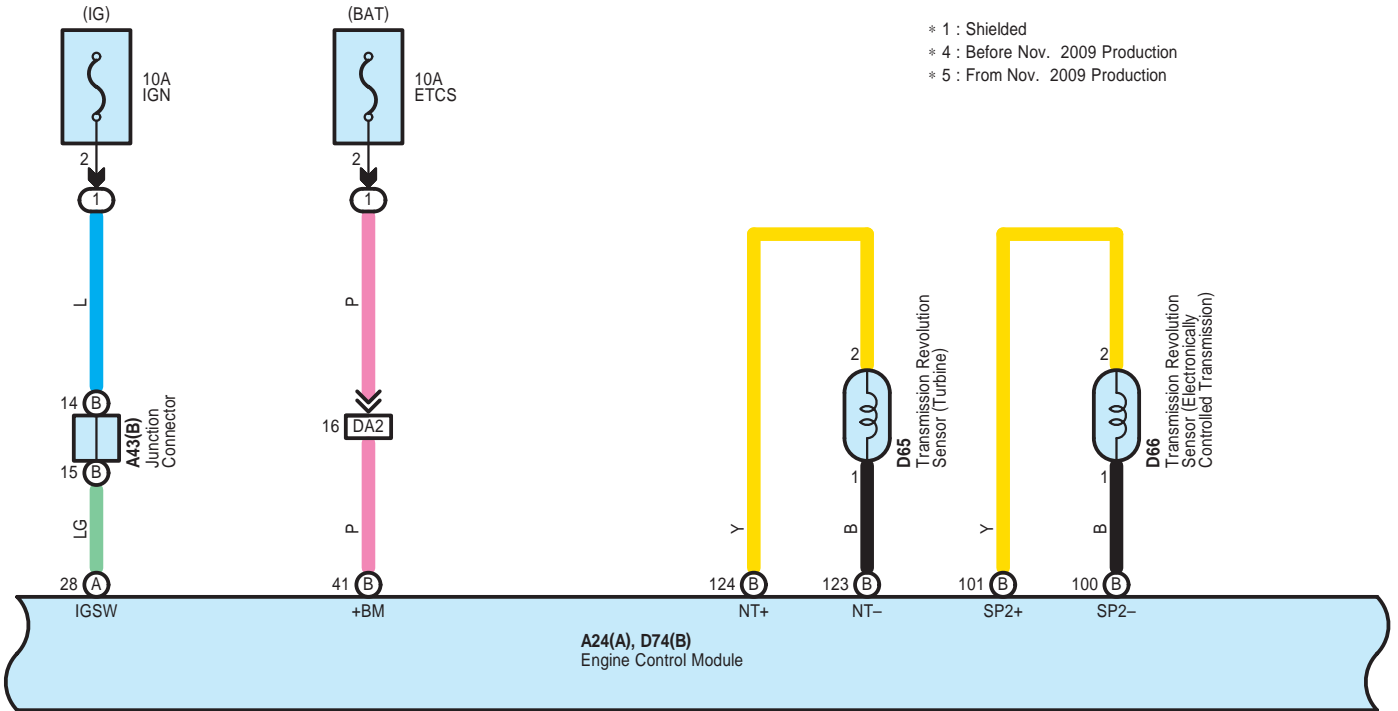

Electronically Controlled Transmission and A/T Indicator <1UR-FE>

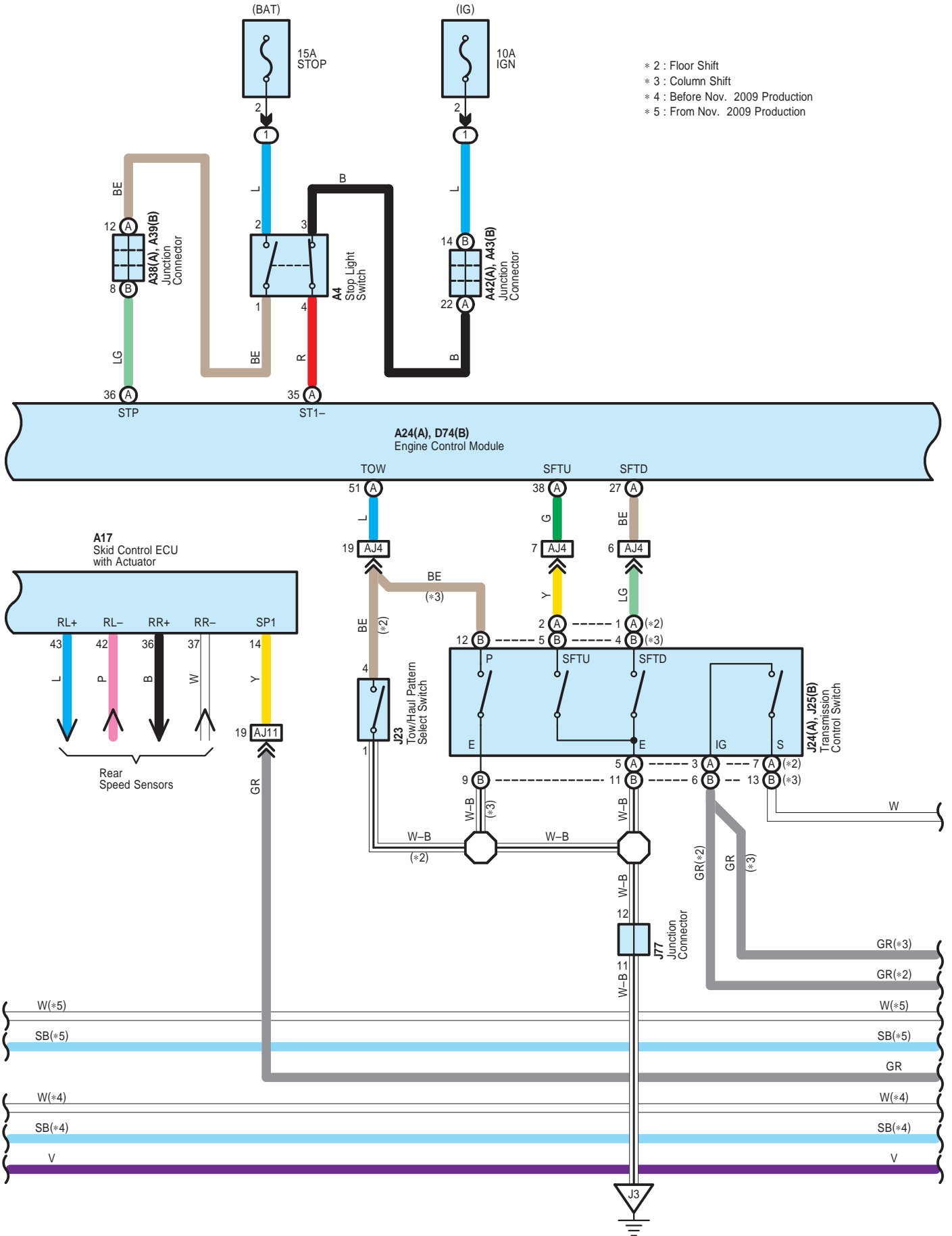

Electronically Controlled Transmission and A/T Indicator <1UR-FE>

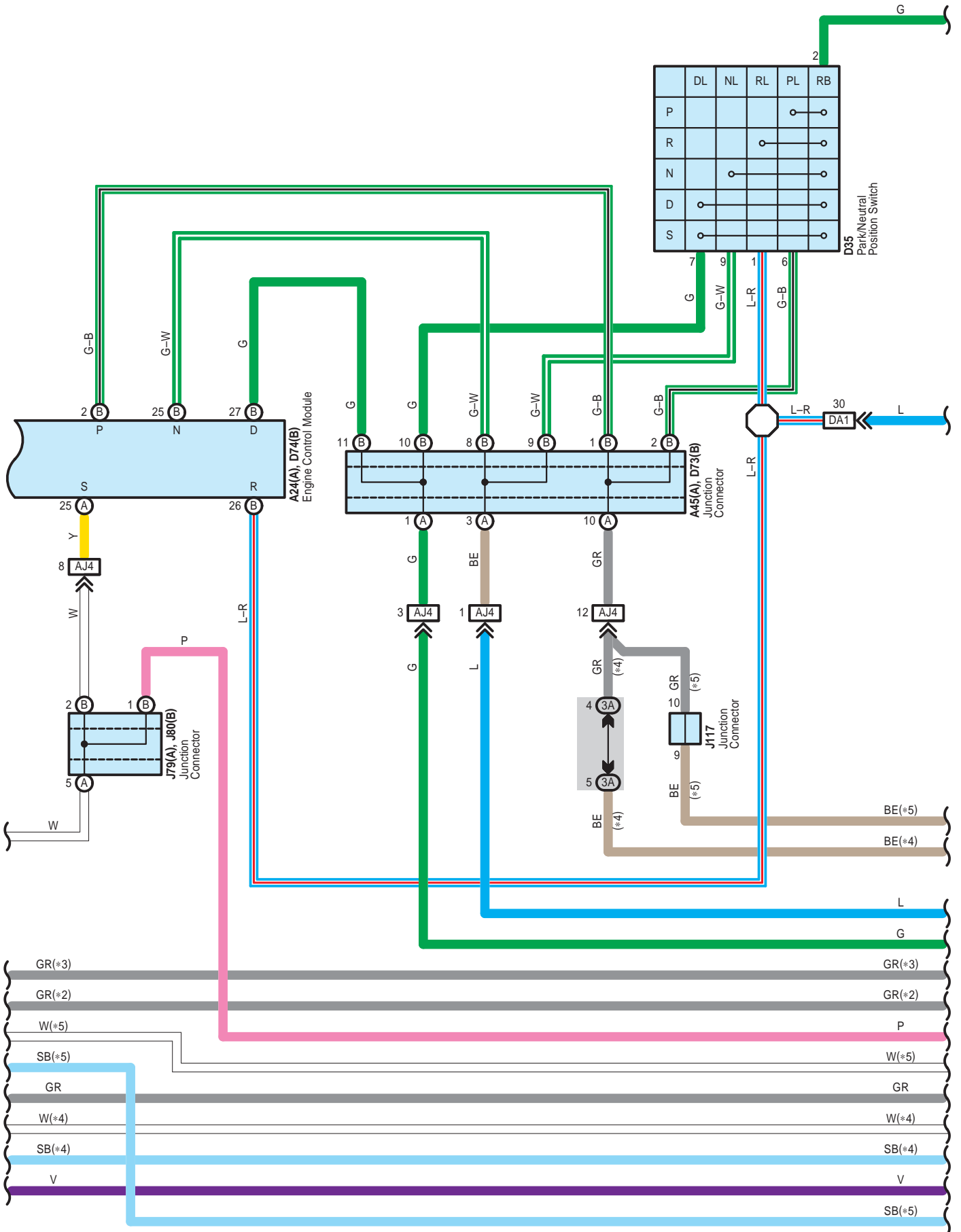

Electronically Controlled Transmission and A/T Indicator <1UR-FE>

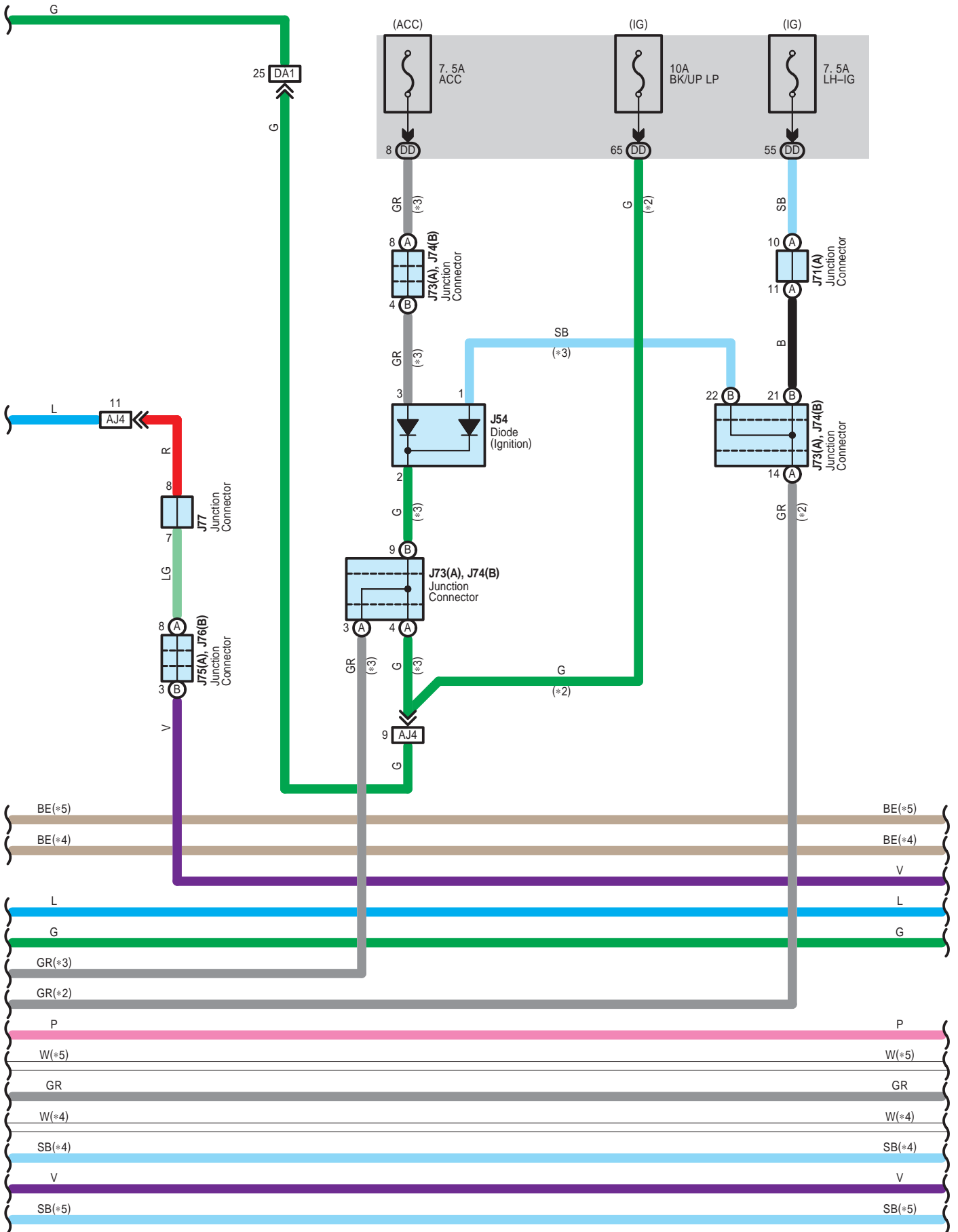

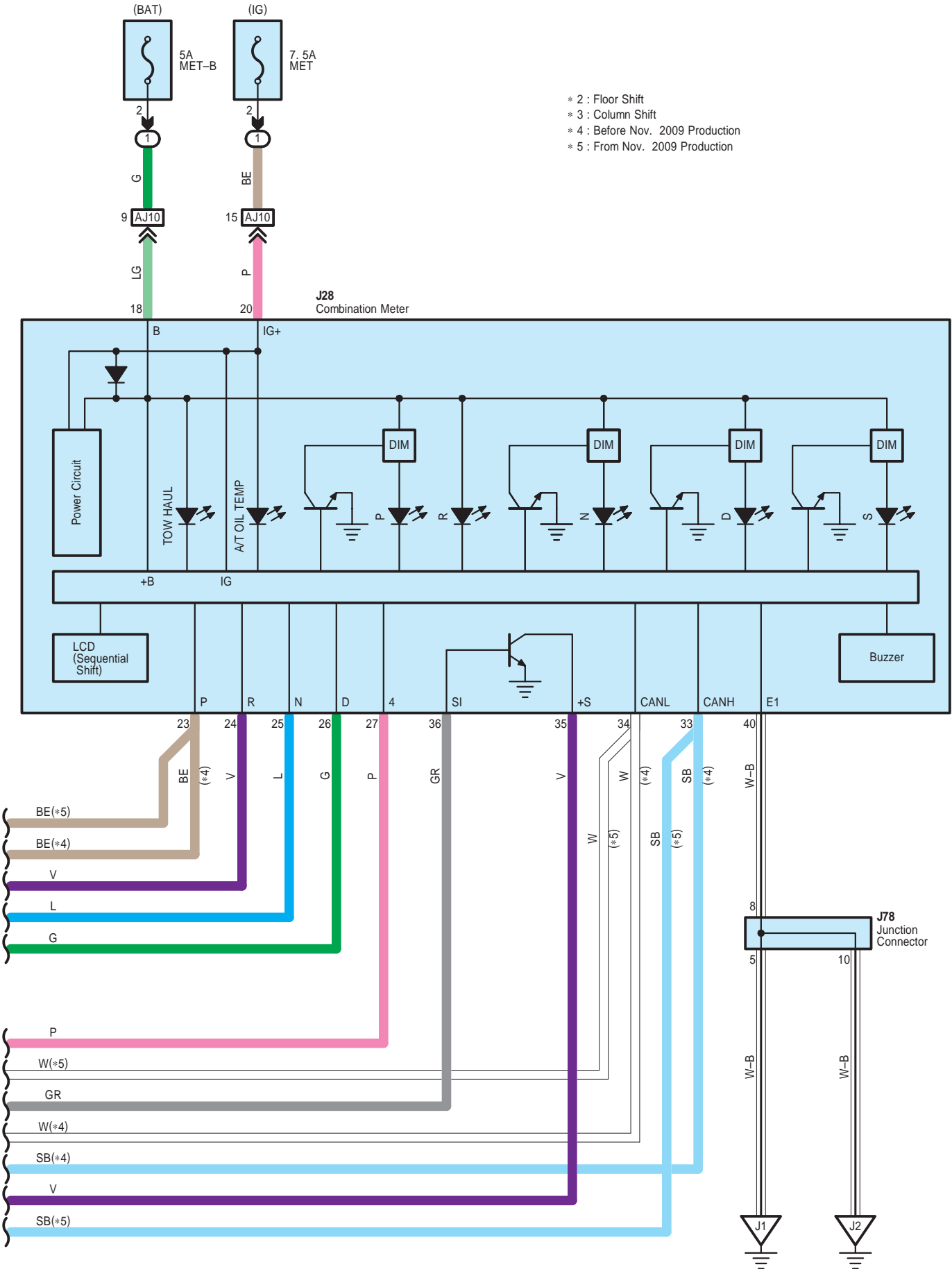

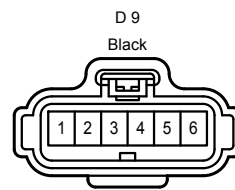
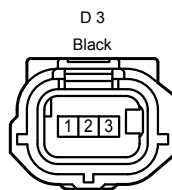
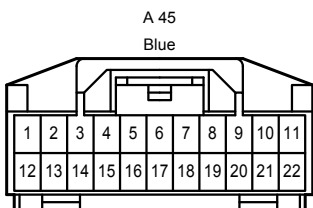
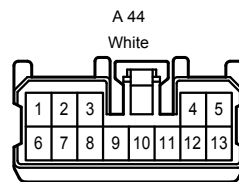
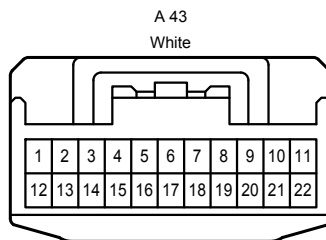
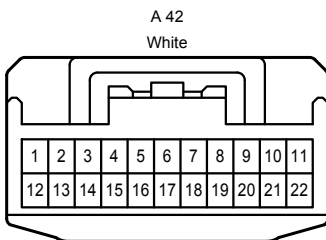
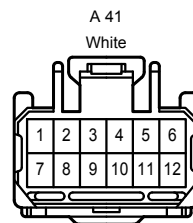
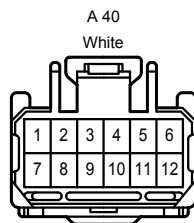
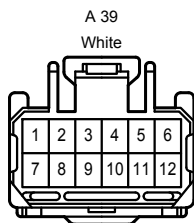
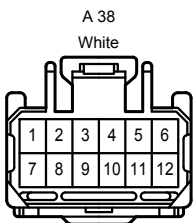
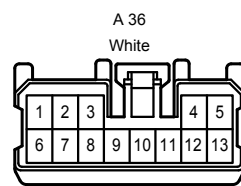
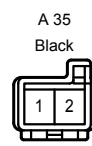
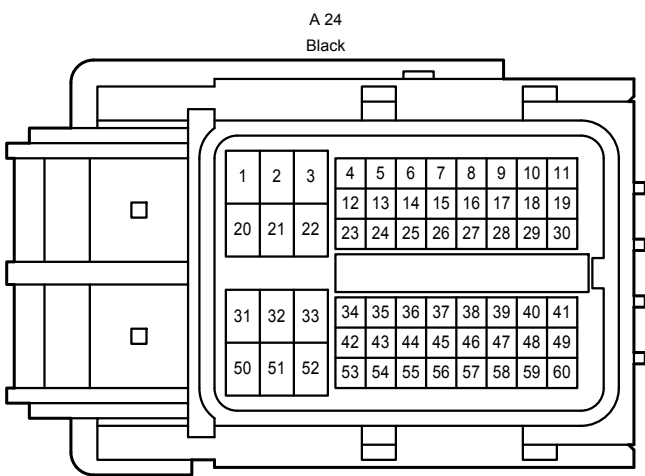
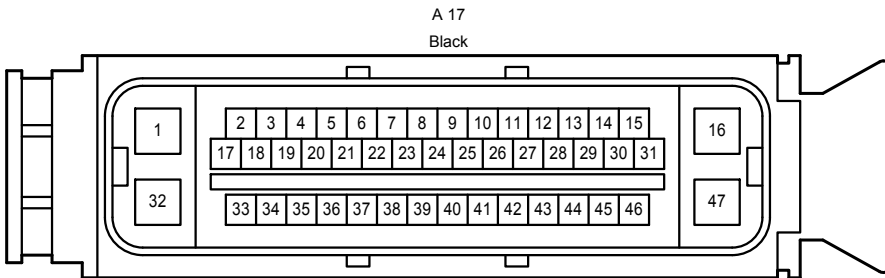
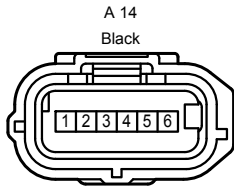
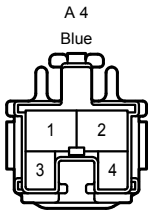

Electronically Controlled Transmission and A/T Indicator <1UR-FE>

D 28
Dark Gray



D 35
Gray

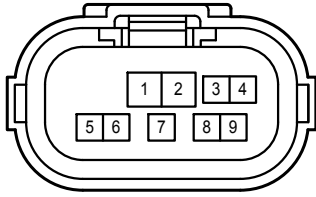

D 65
Black

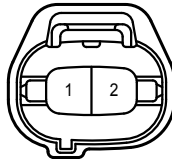

D 66
Black

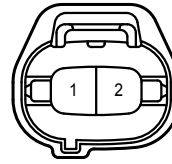

D 73
Blue

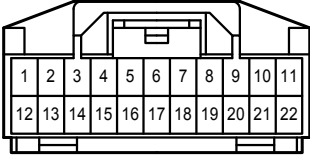

D 74
Black

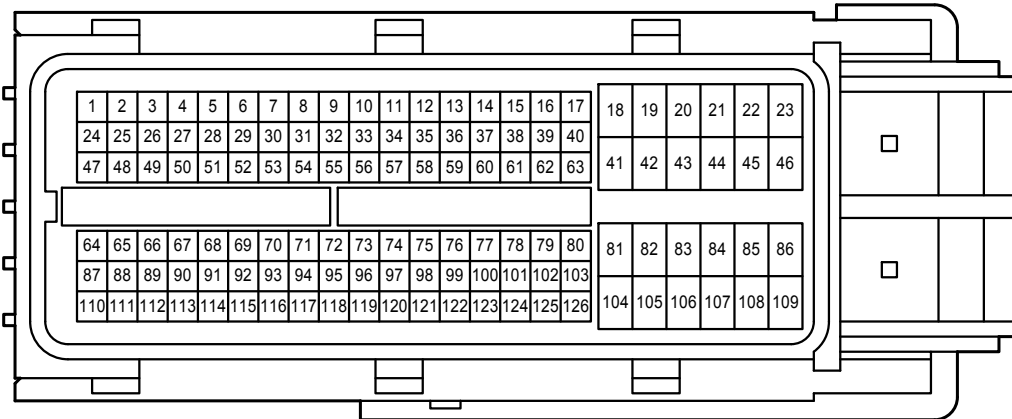

D 83

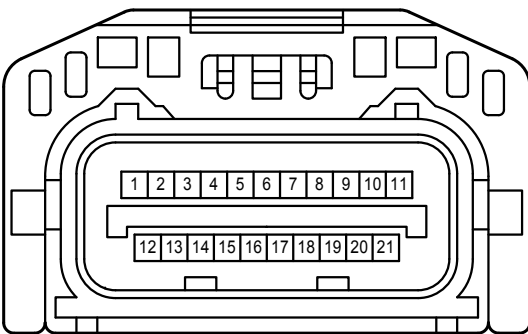

J 9
White

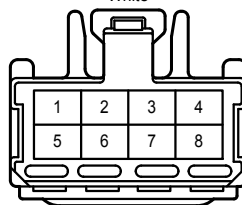

J 17
White

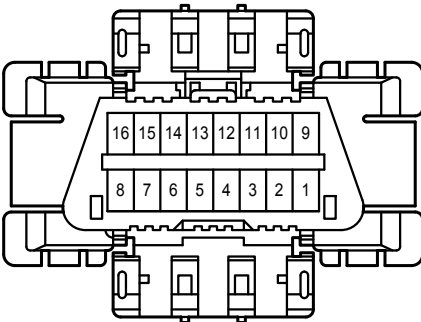

J 23
Black

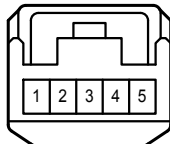

J 24
White

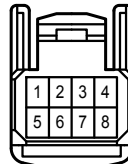

J 25
White

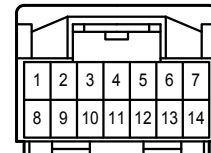

Electronically Controlled Transmission and A/T Indicator <1UR-FE>

J 28
White

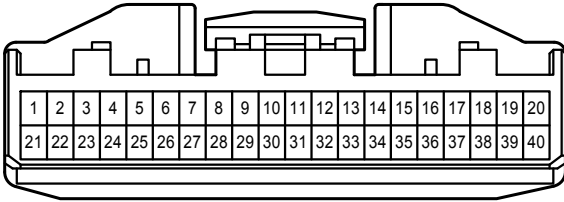

J 54
Orange

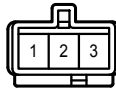

J 71
Black

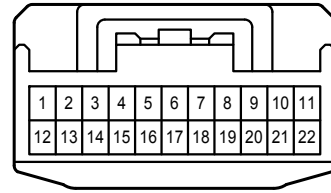

J 73
Black

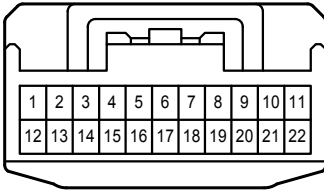

J 74
Black

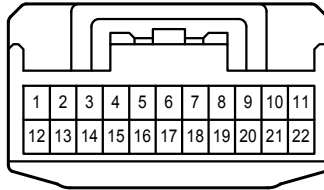

J 75
White

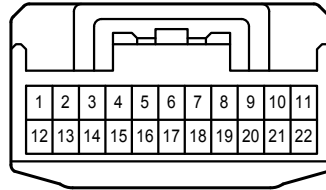

J 76
White

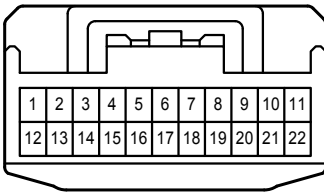

J 77
Gray

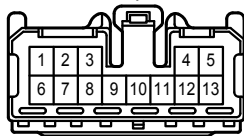

J 78
White

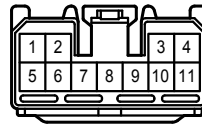

J 79
White

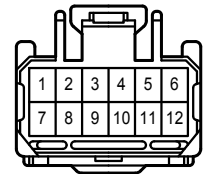

J 80
White

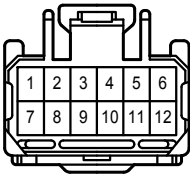

J 84
White

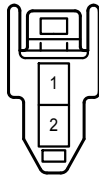

J 86
White

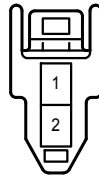

J 94
White

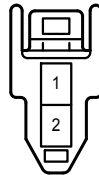

J113
Gray

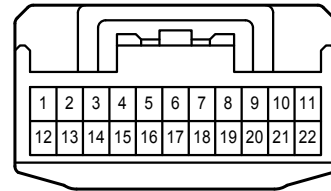

J117
Black

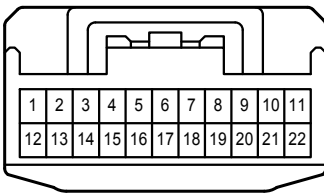

J118
Gray

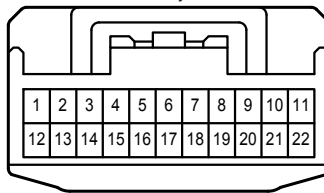

1B
White

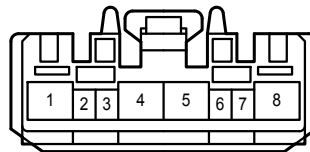

3A
Black

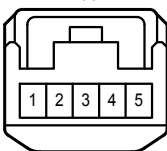

3B
White

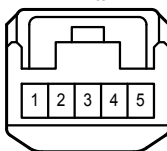

DD
White

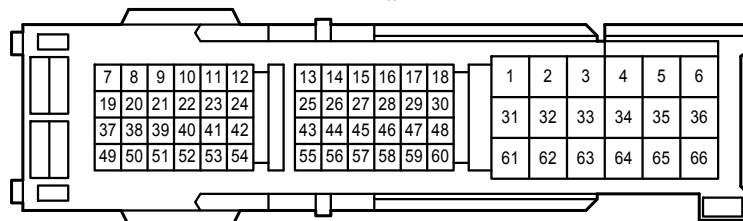

AJ4
White

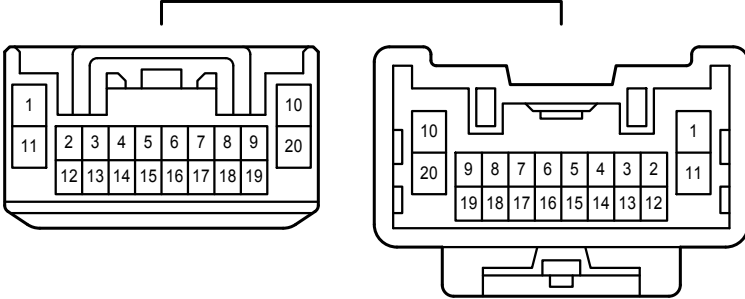

AJ5
White

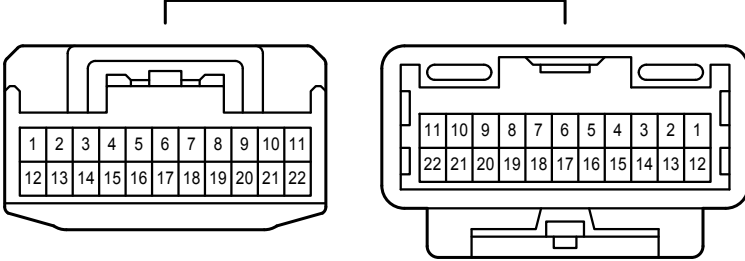

AJ9
Gray

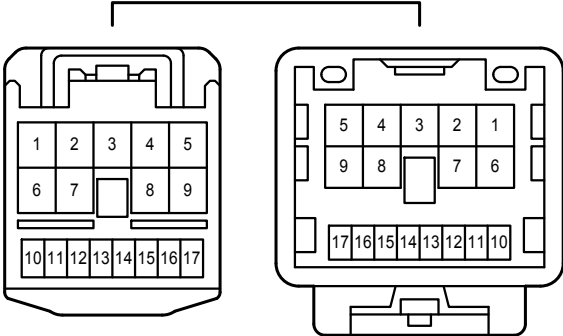

AJ10
Gray

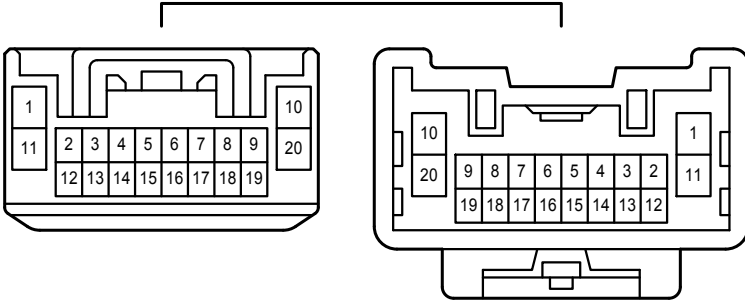

AJ11
Gray

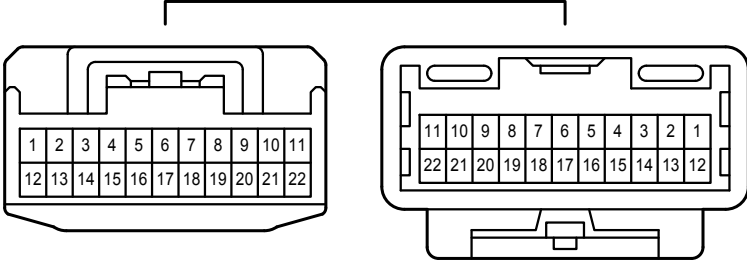

DA1
White

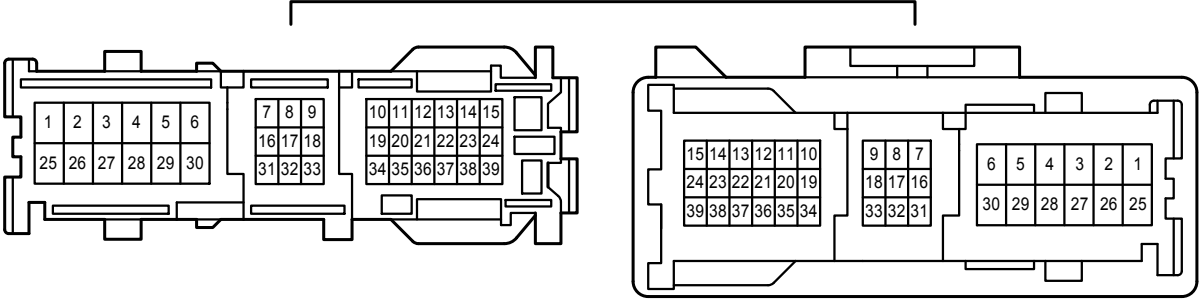

DA2
White

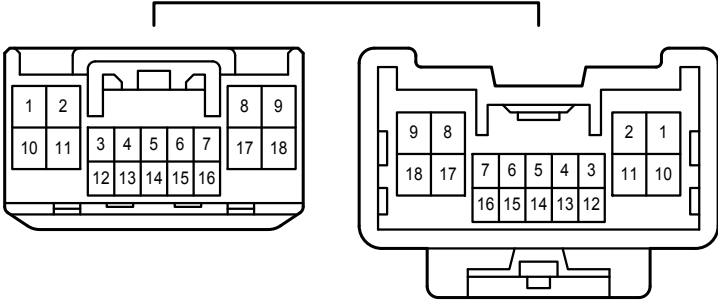

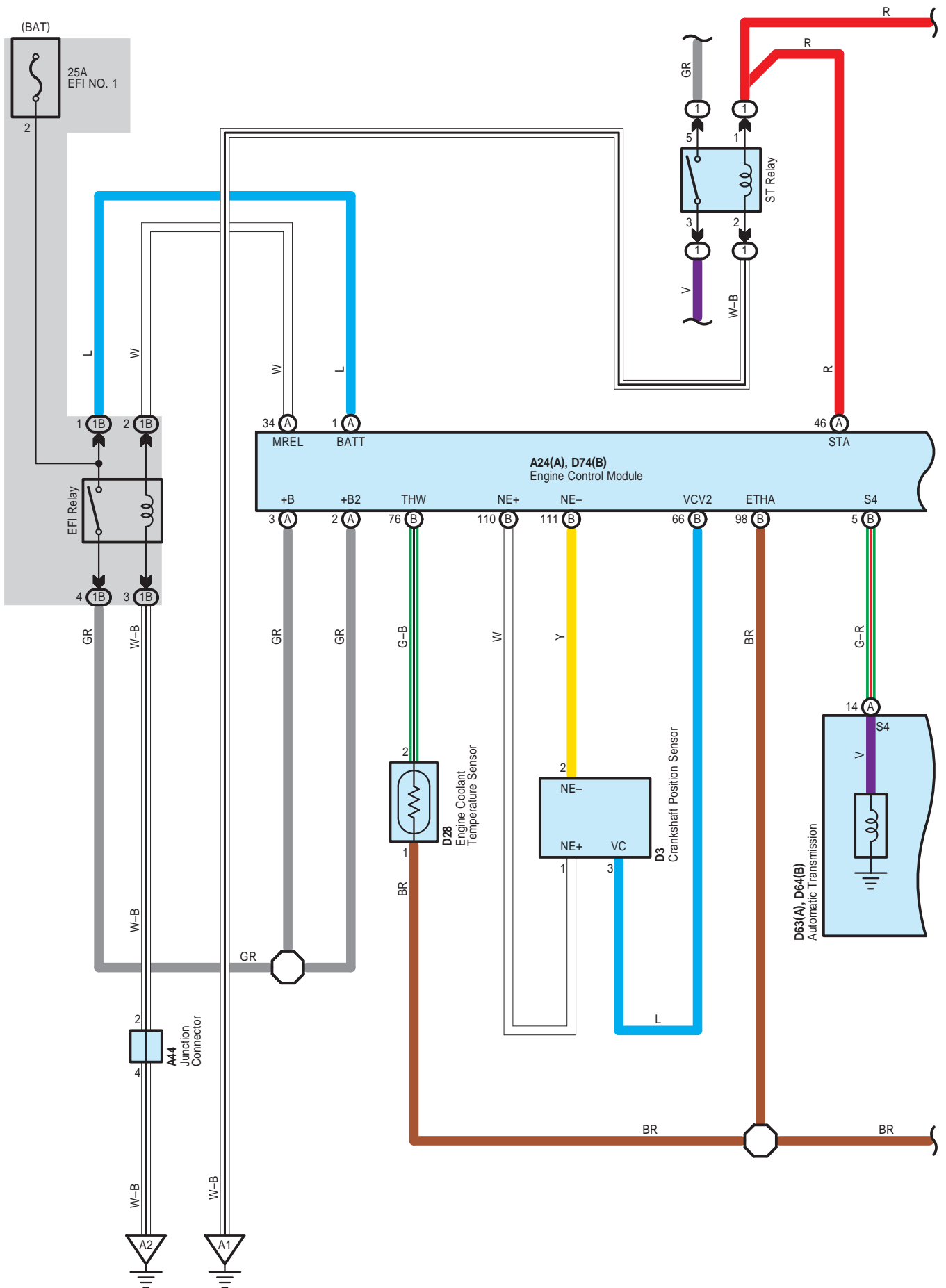

Electronically Controlled Transmission and A/T Indicator <3UR-FE, 3UR-FBE>

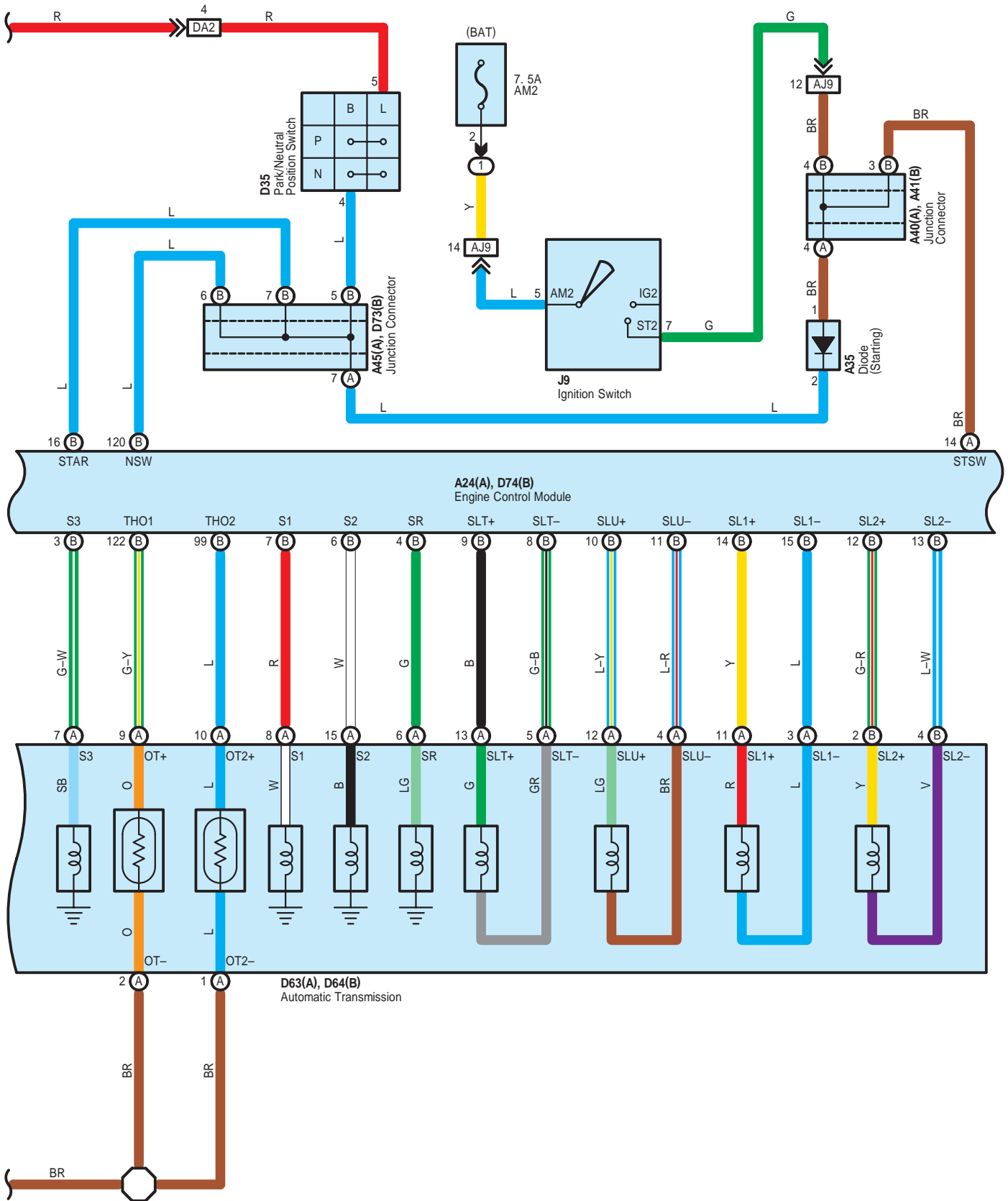

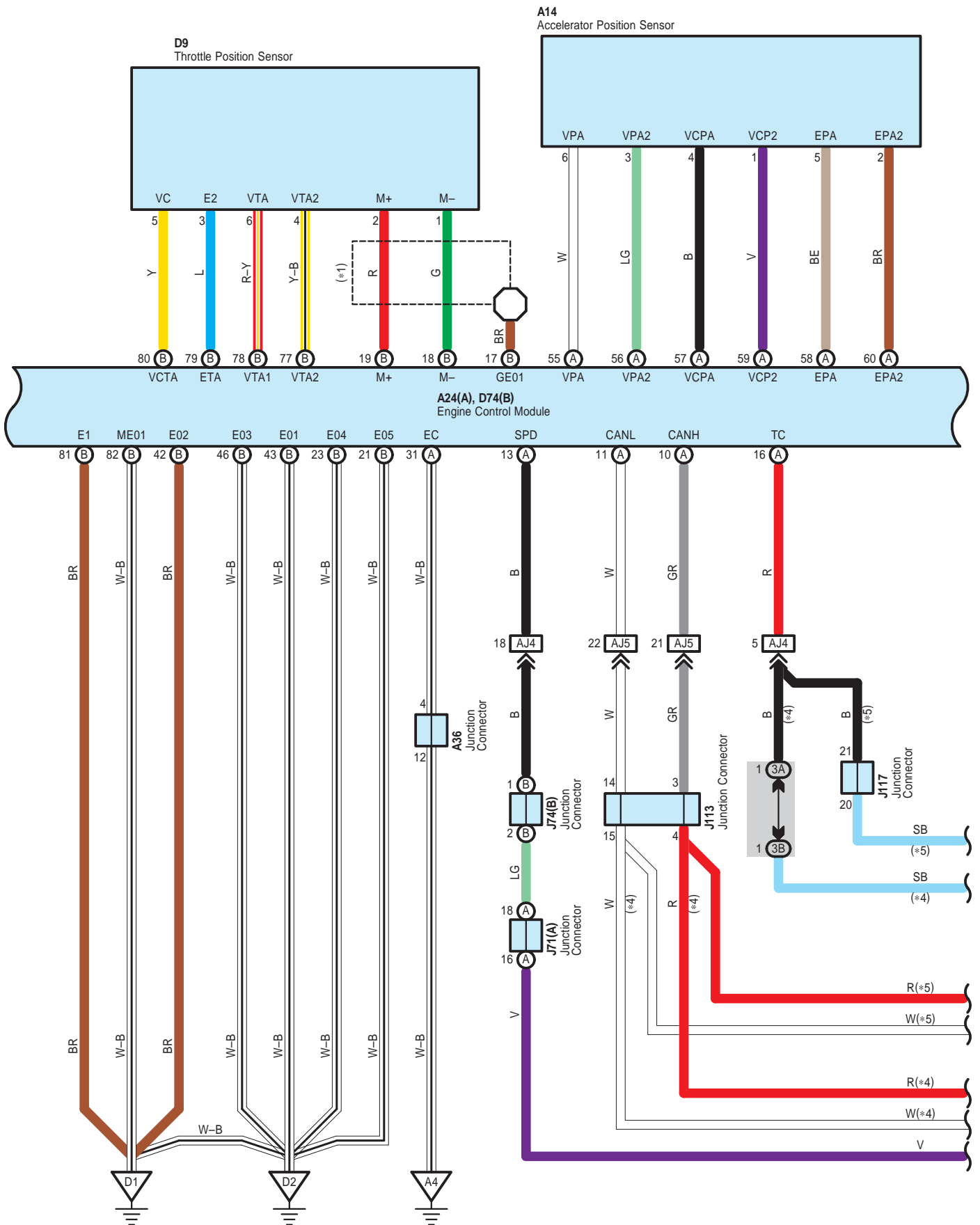

Electronically Controlled Transmission and A/T Indicator <3UR-FE, 3UR-FBE>

- * 1 : Shielded
- * 4 : Before Nov. 2009 Production
- * 5 : From Nov. 2009 Production

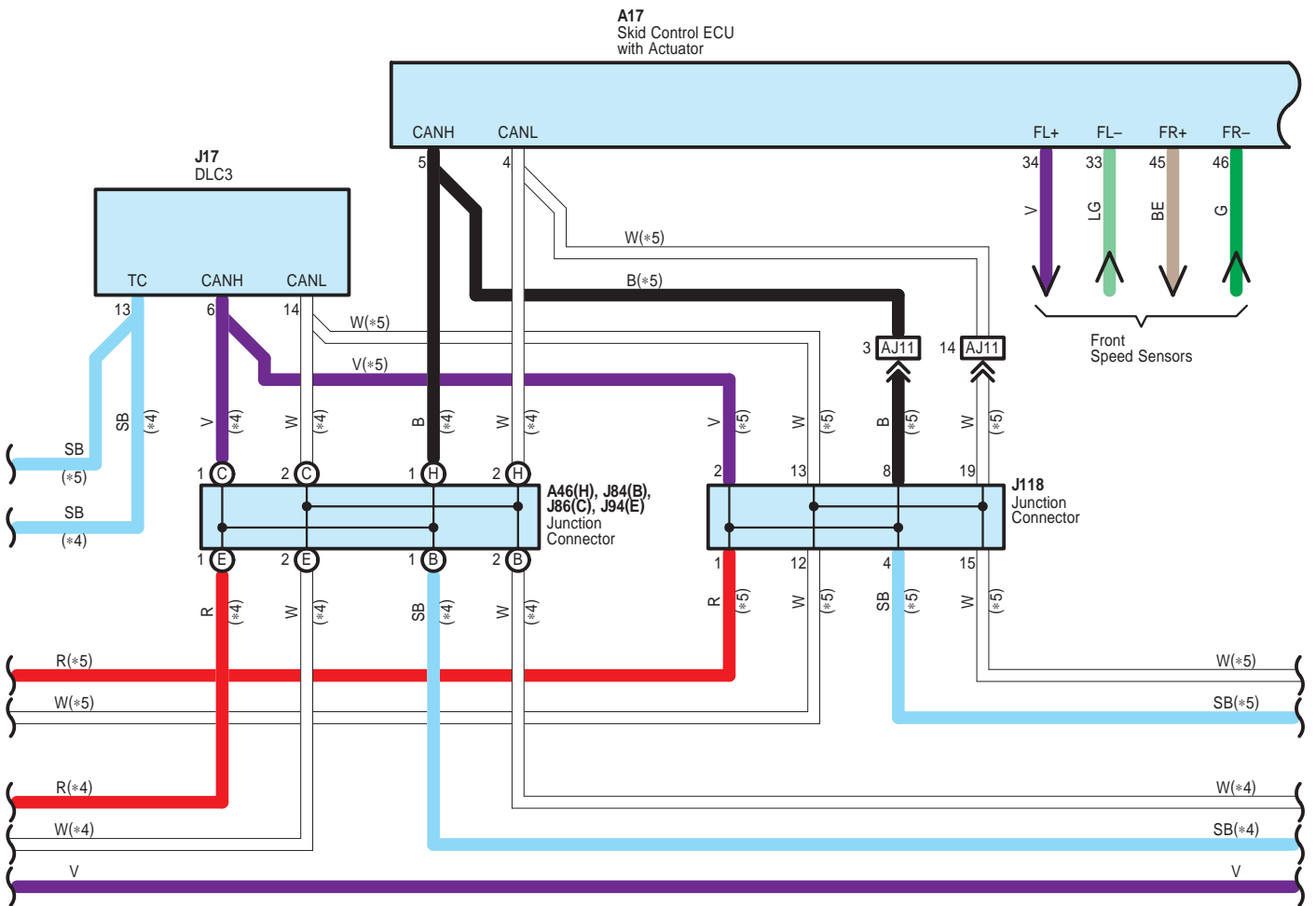
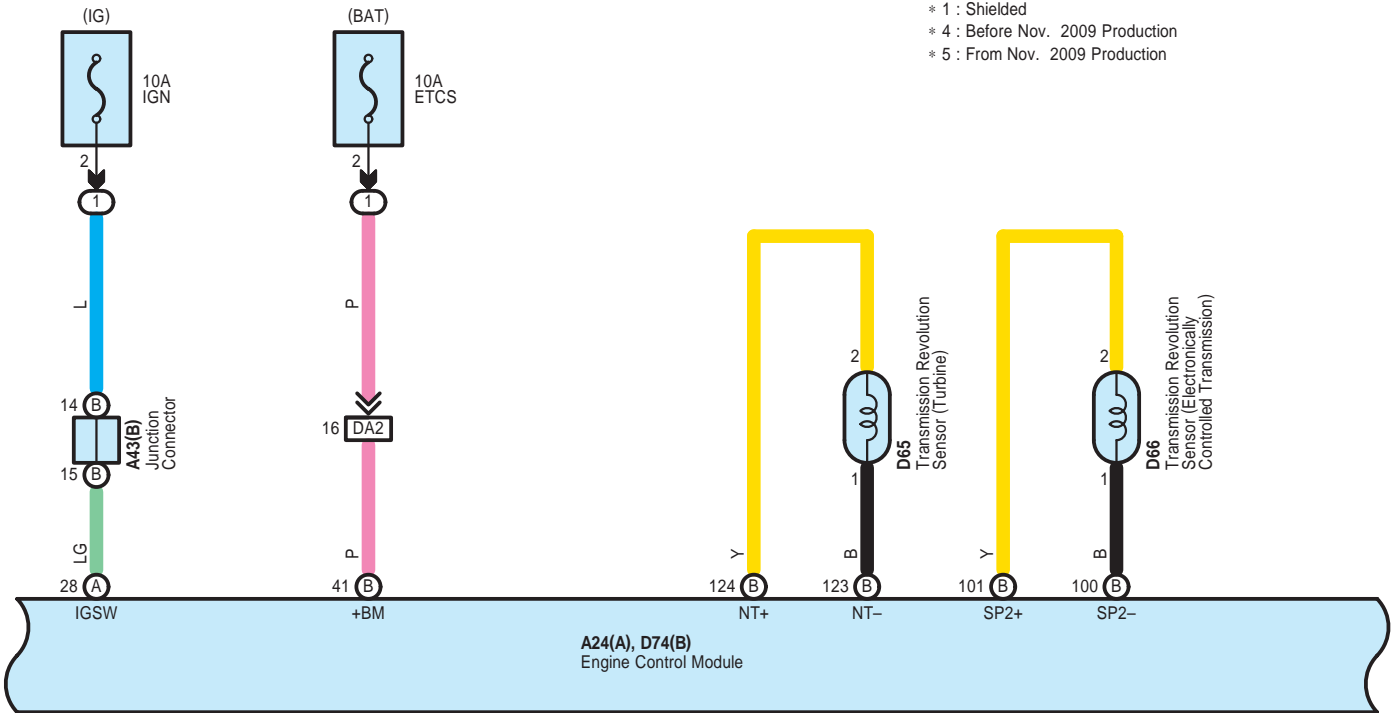

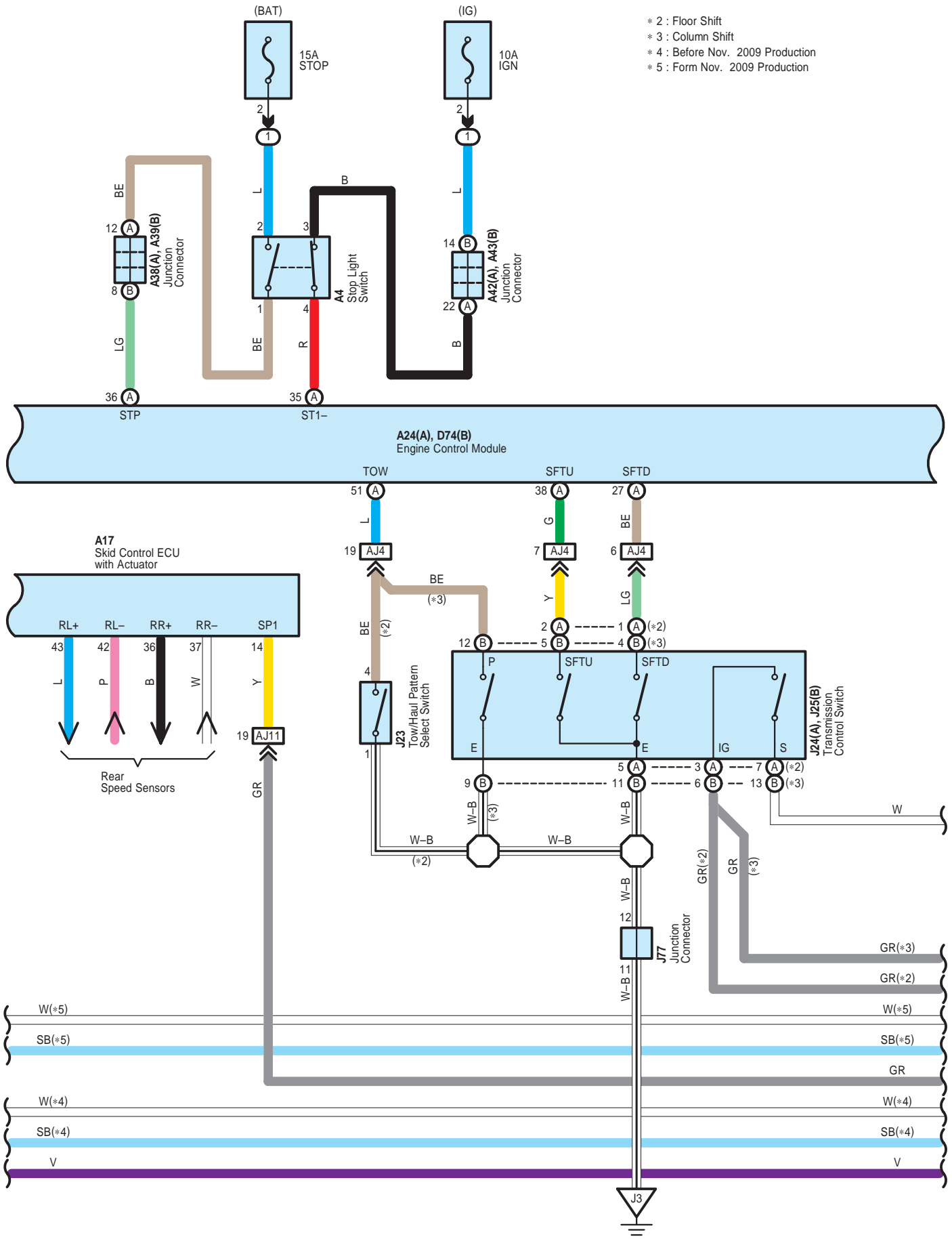

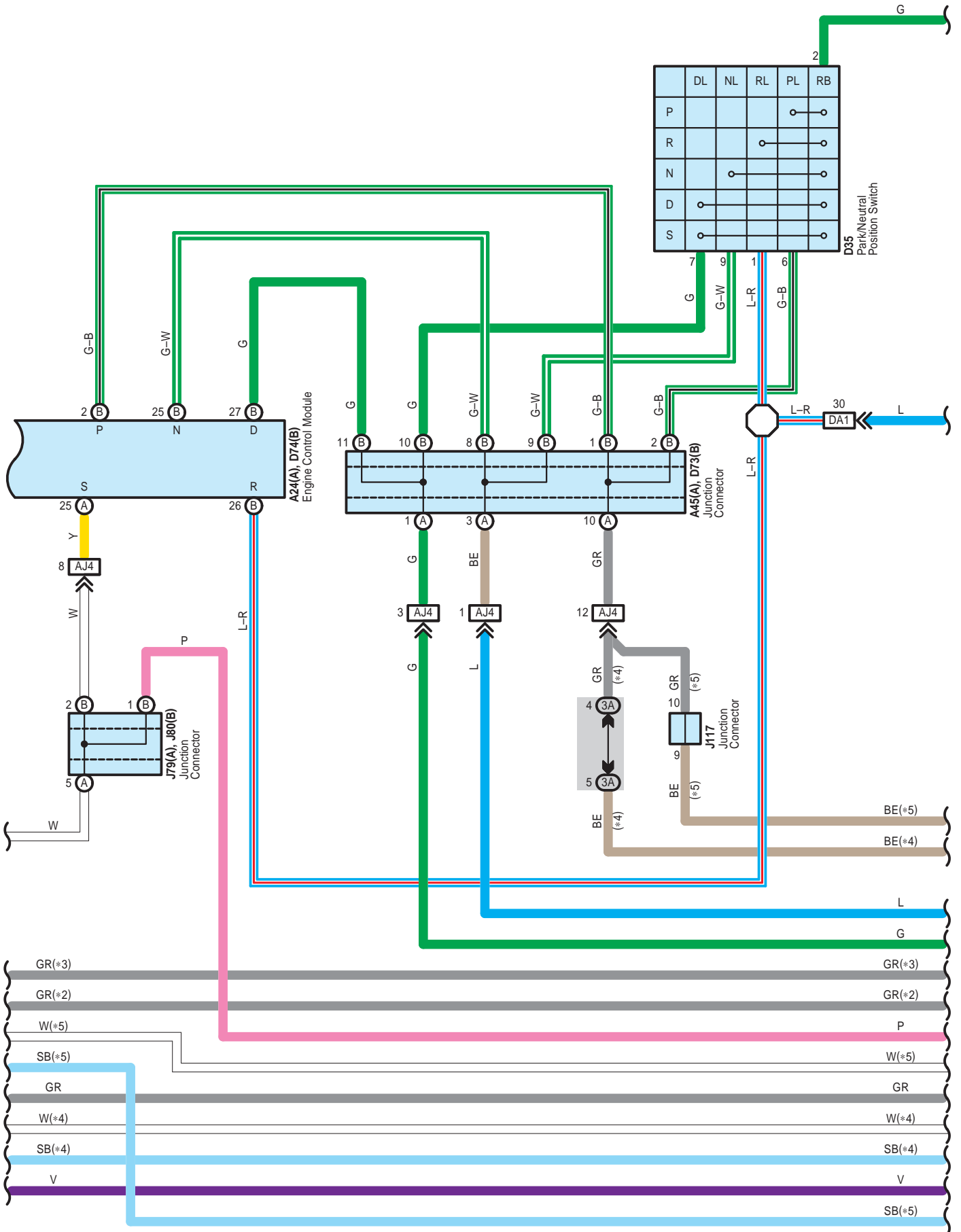

Electronically Controlled Transmission and A/T Indicator <3UR-FE, 3UR-FBE>

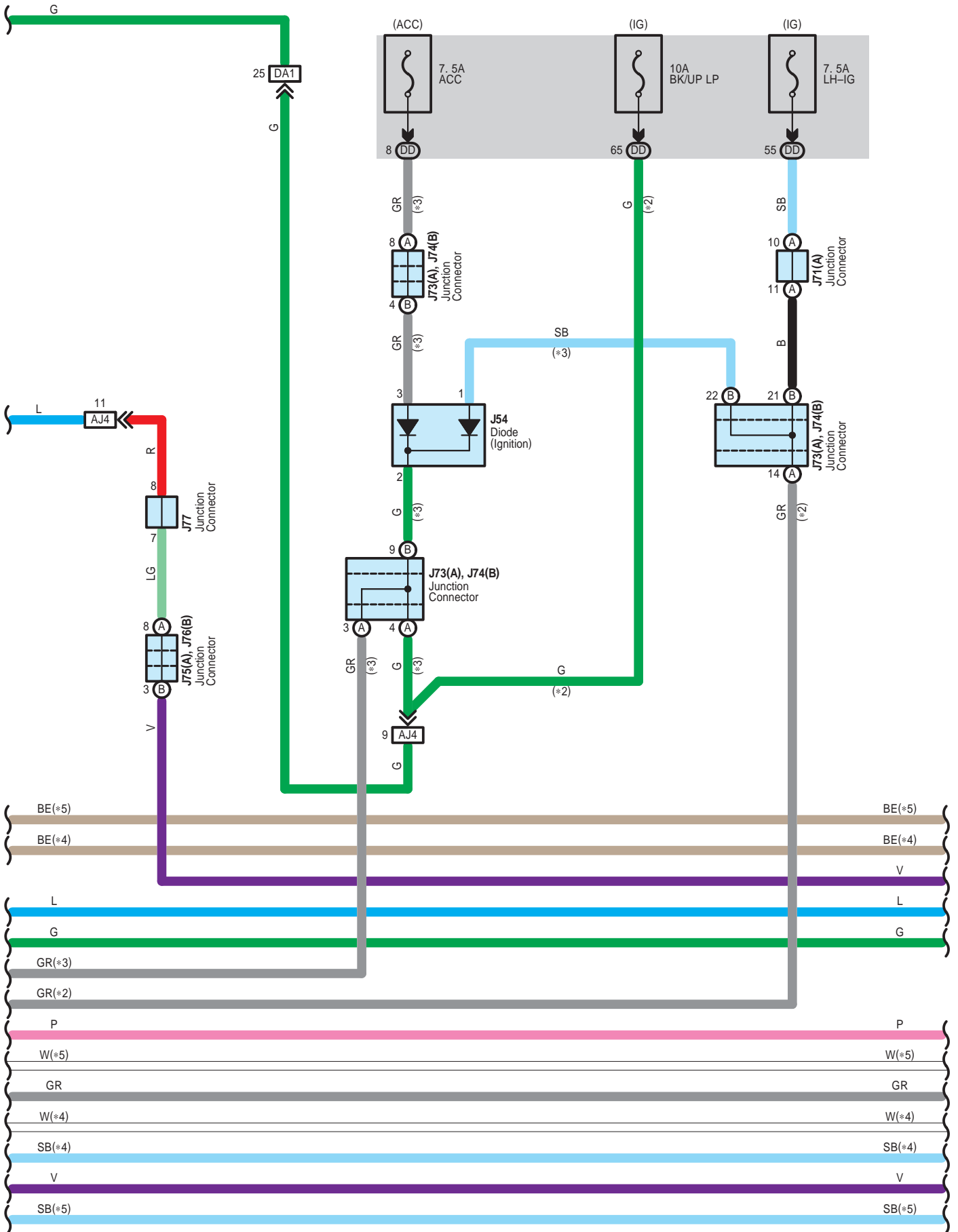

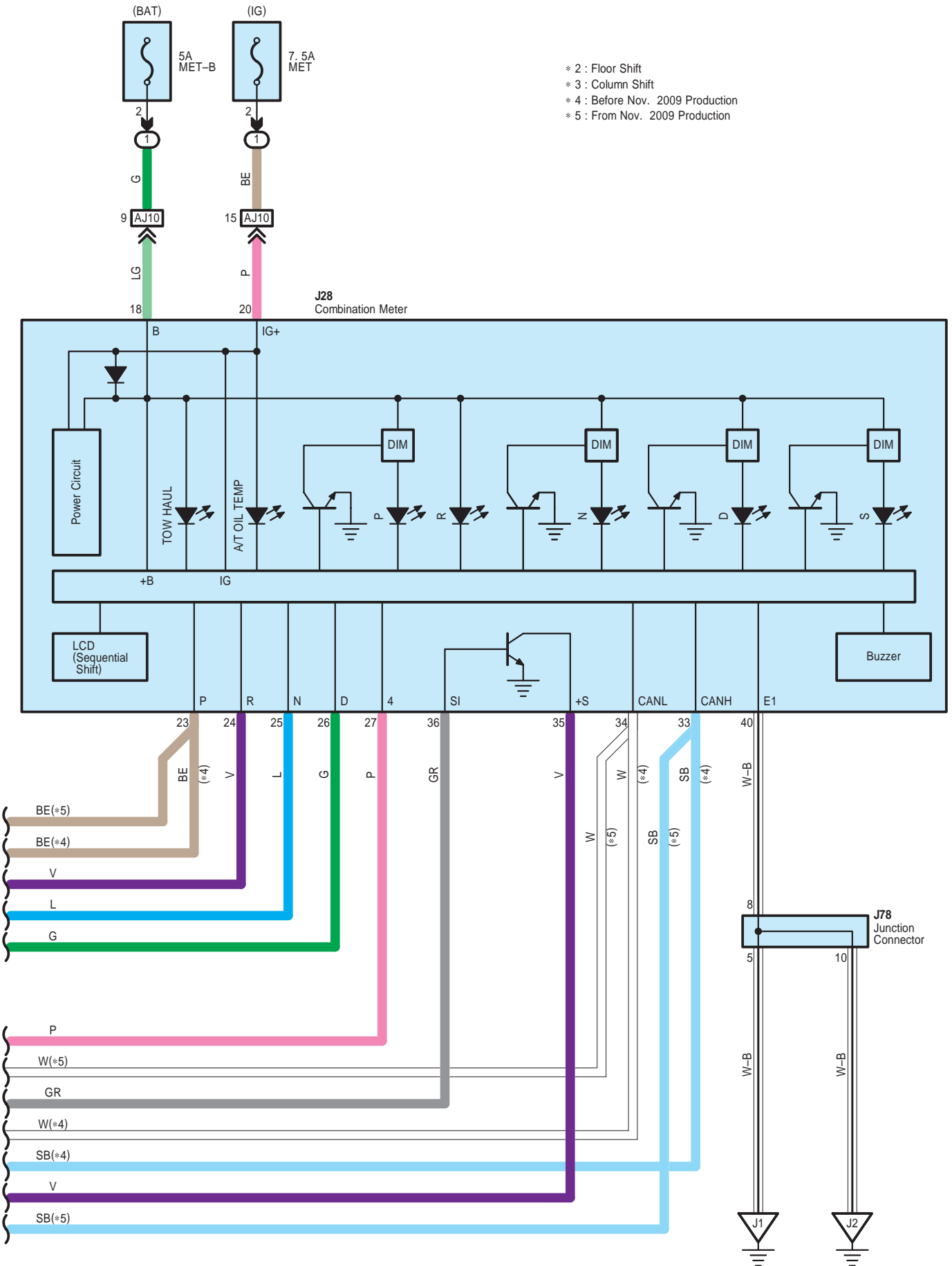

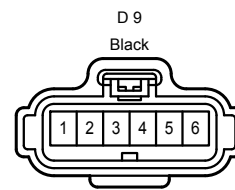
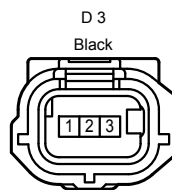
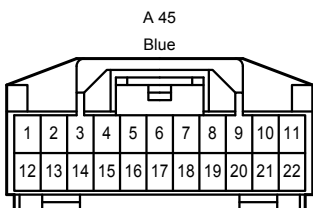
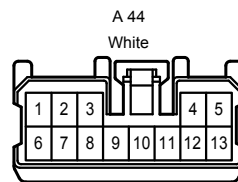
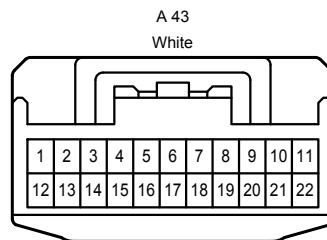
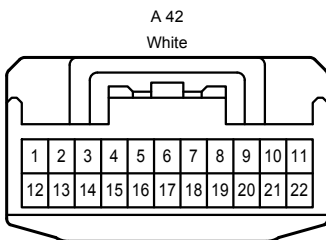
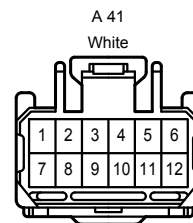
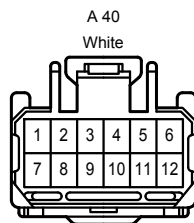
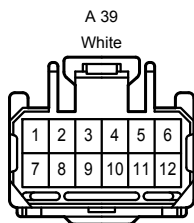
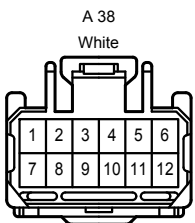
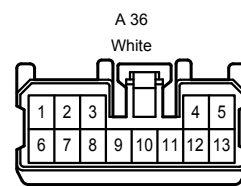
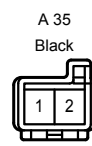
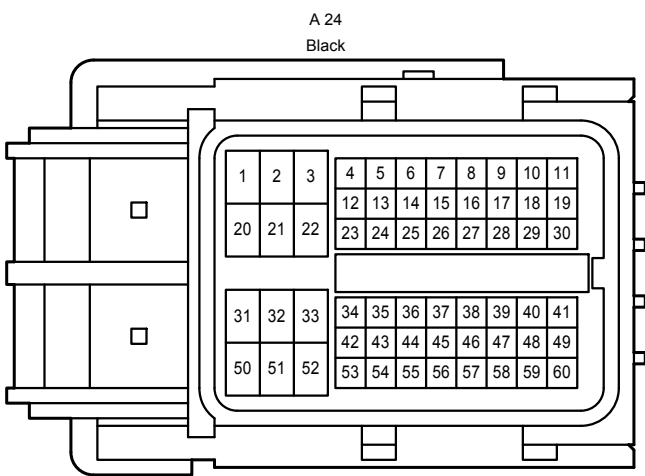
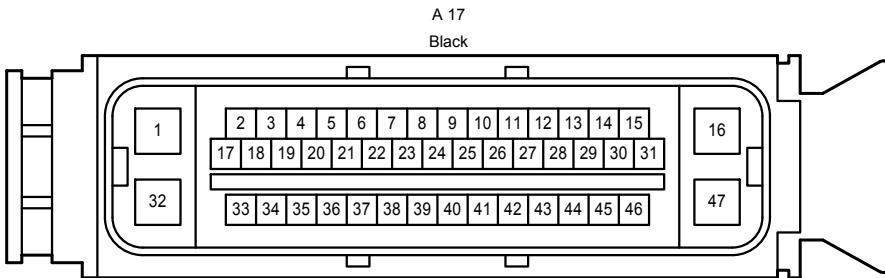
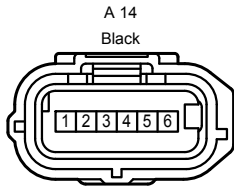
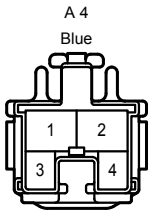

Electronically Controlled Transmission and A/T Indicator <3UR-FE, 3UR-FBE>

D 28
Dark Gray



D 35
Gray

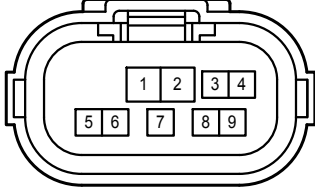

D 63
Gray

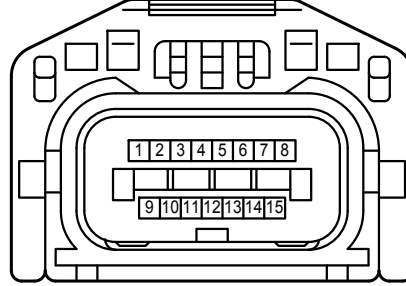

D 64
Gray

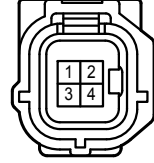

D 65
Black

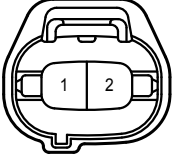

D 66
Black

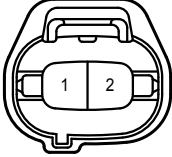

D 73
Blue

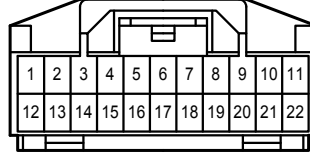

D 74
Black

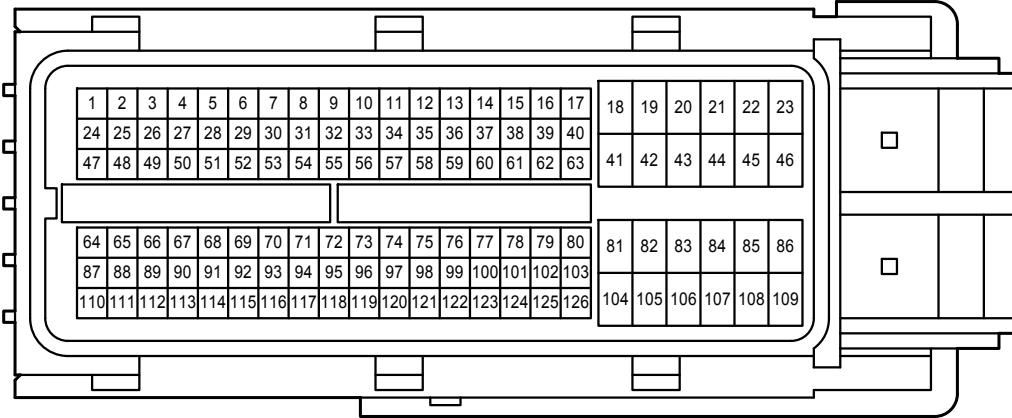

J 9
White

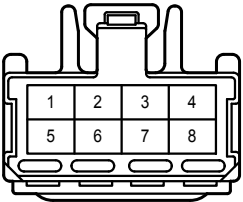

J 17
White

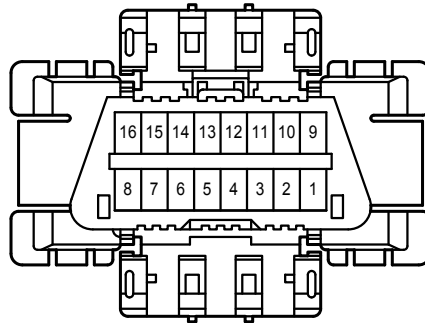

J 23
Black

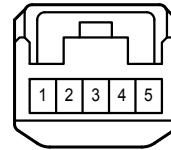

J 24
White

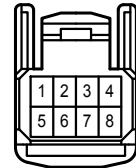

J 25
White

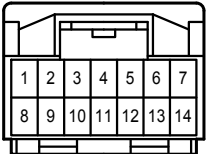

J 28
White

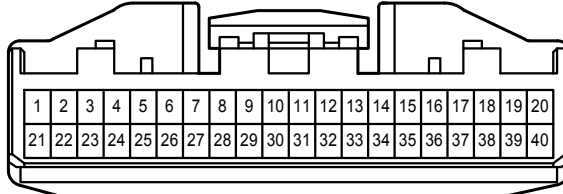

J 54
Orange

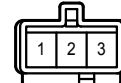

J 71
Black

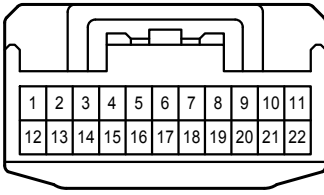

J 73
Black

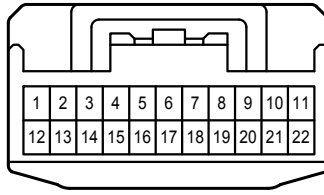

J 74
Black

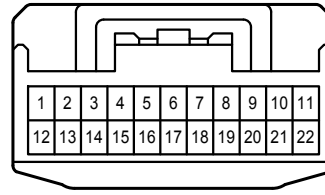

J 75
White

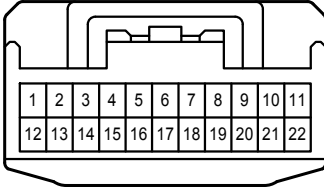

J 76
White

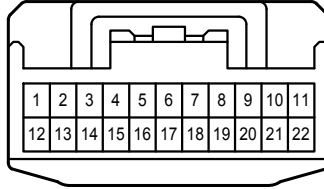

J 77
Gray

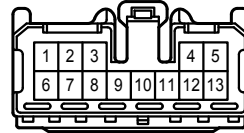

J 78
White

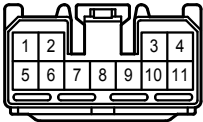

J 79
White

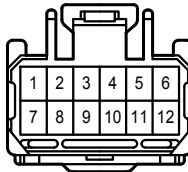

J 80
White

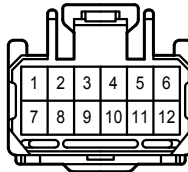

J 84
White

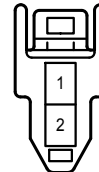

J 86
White

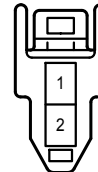

J 94
White

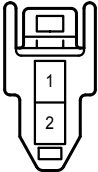

J113
Gray

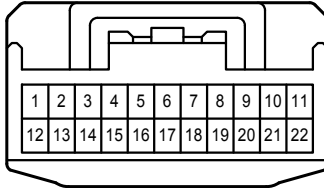

J117
Black

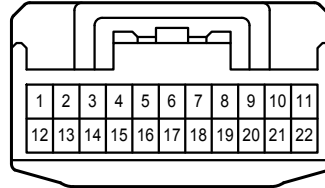

J118
Gray

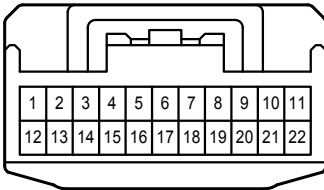

1B
White

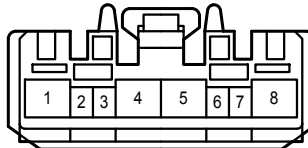

3A
Black

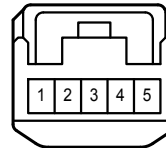

3B
White

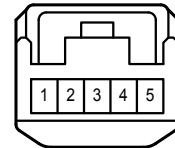

DD
White

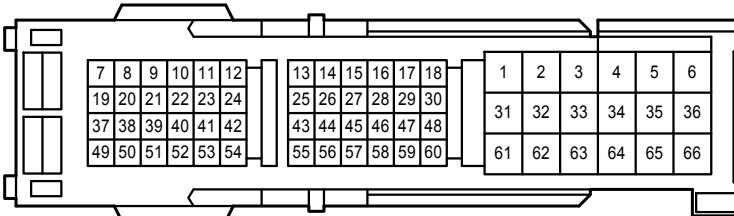

AJ4
White

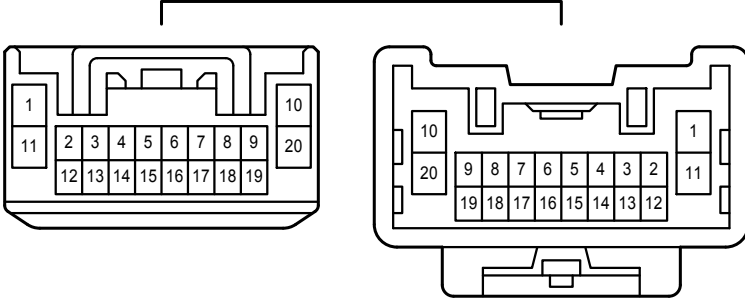

AJ5
White

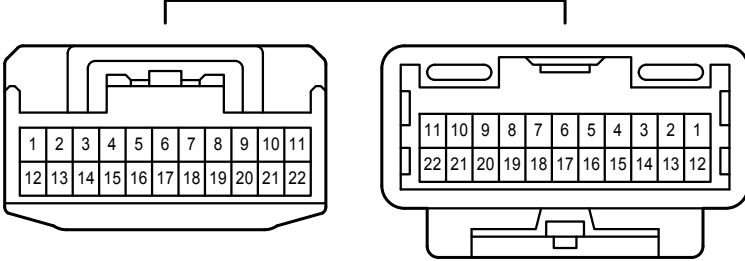

AJ9
Gray

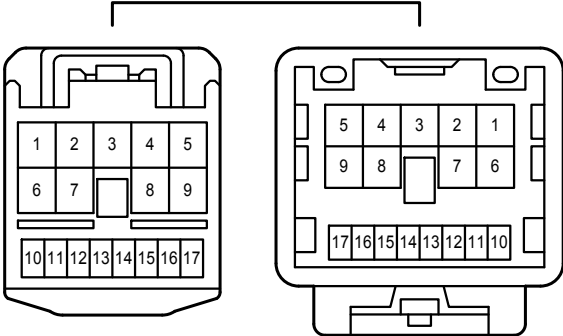

AJ10
Gray

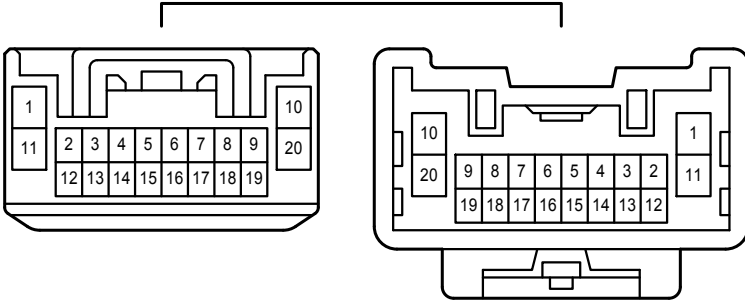

AJ11
Gray

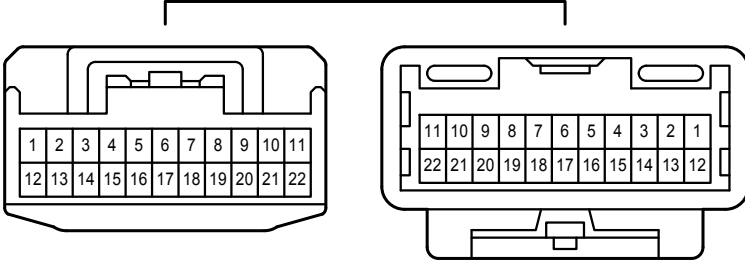

DA1
White

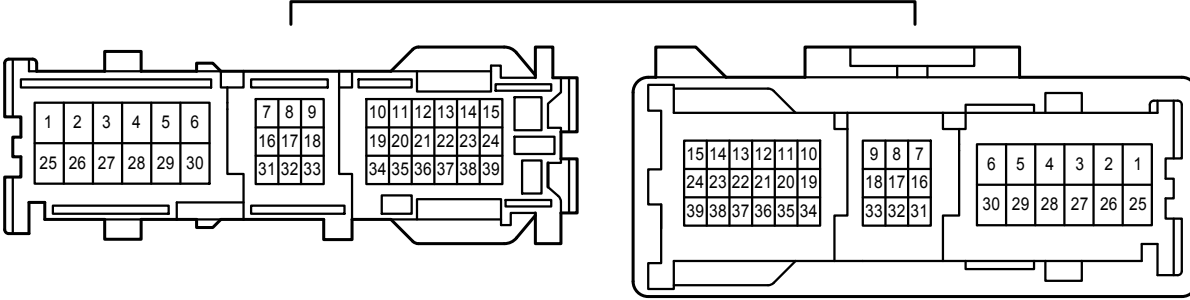

DA2
White

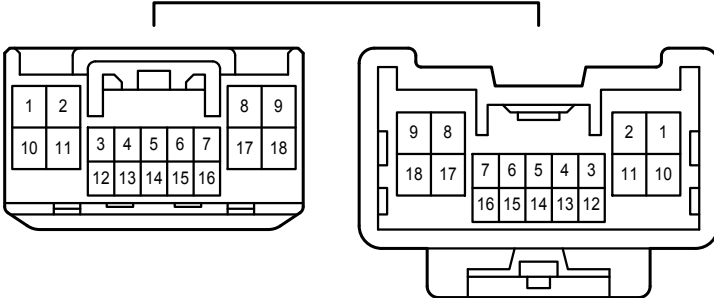

Engine Control <1GR-FE>

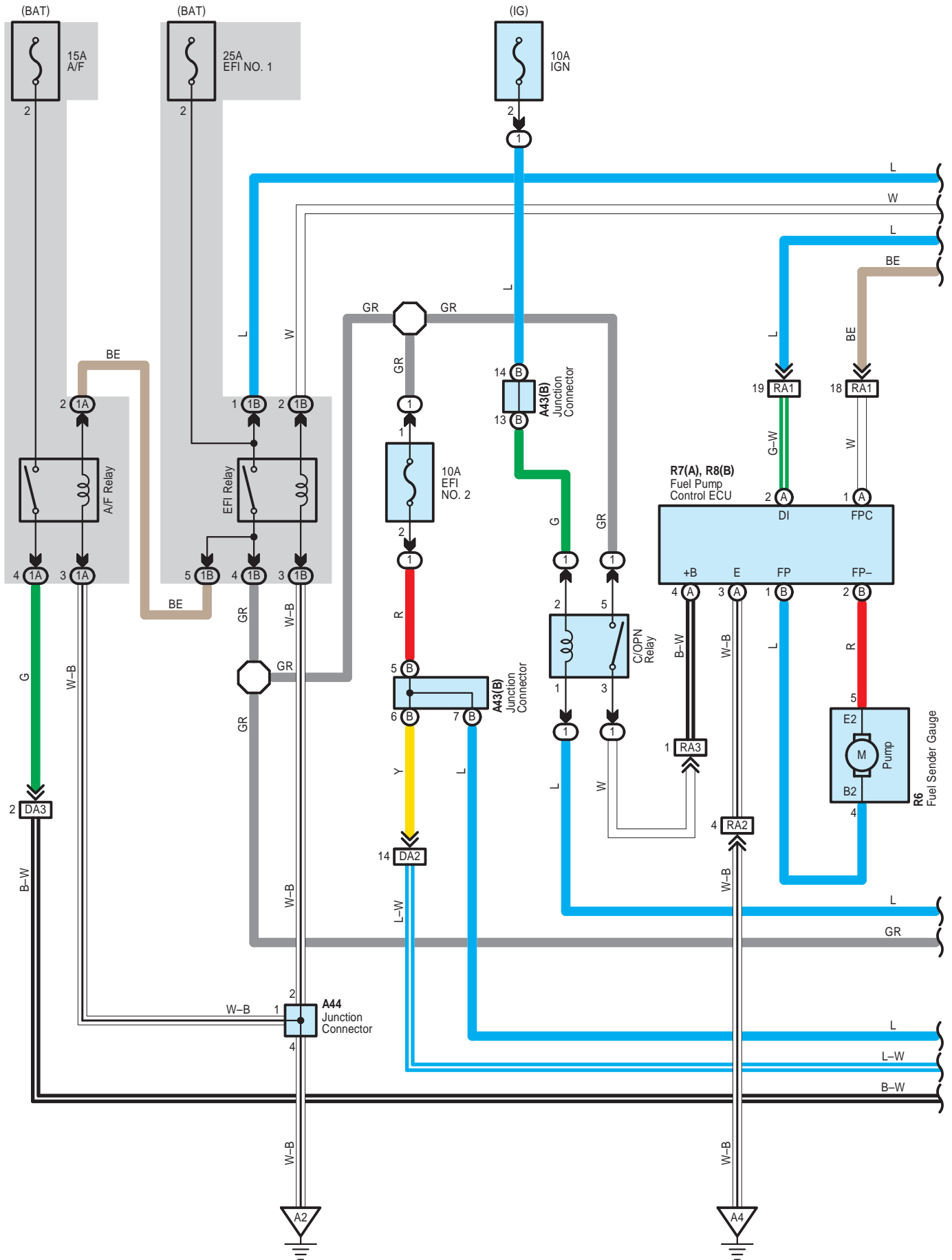

Engine Control <1GR-FE>

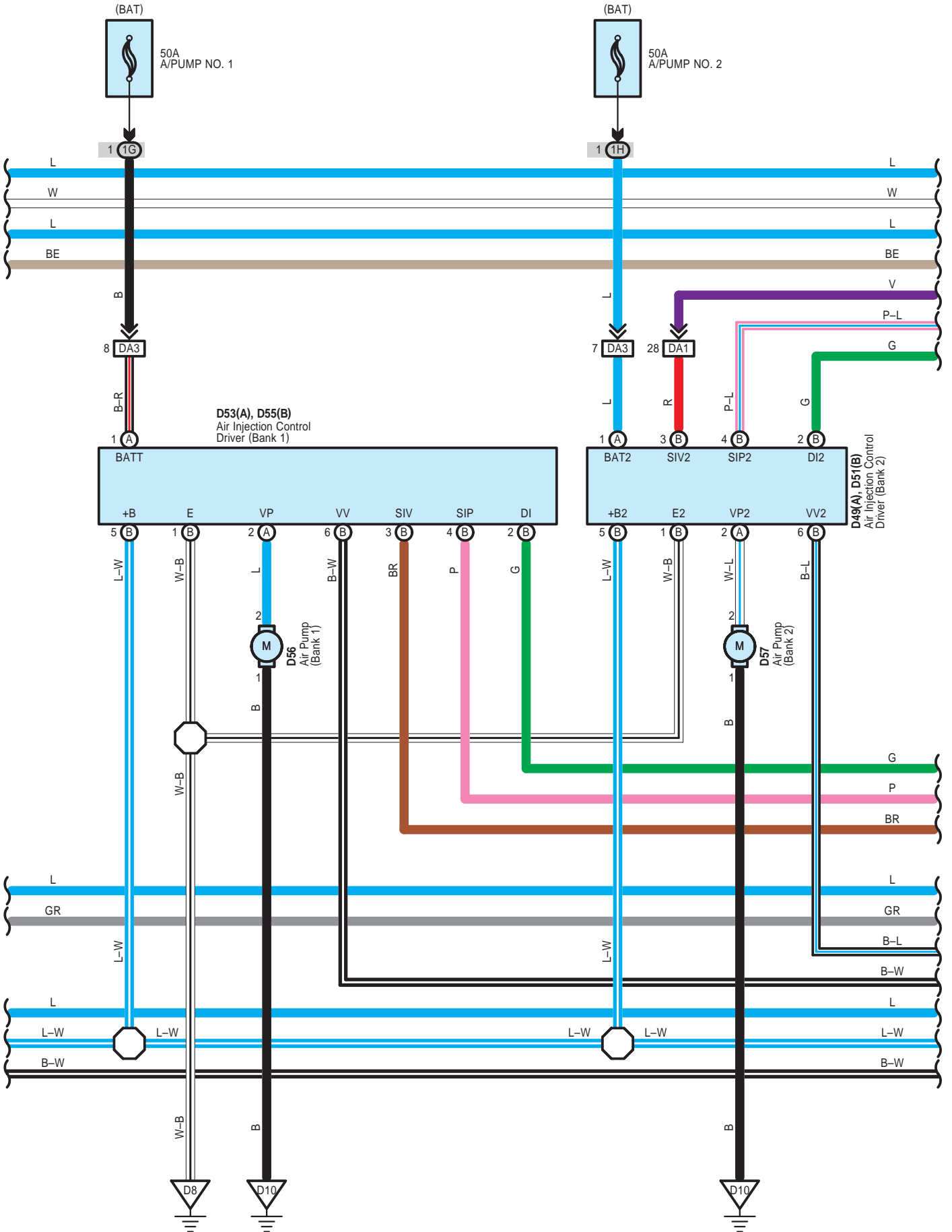

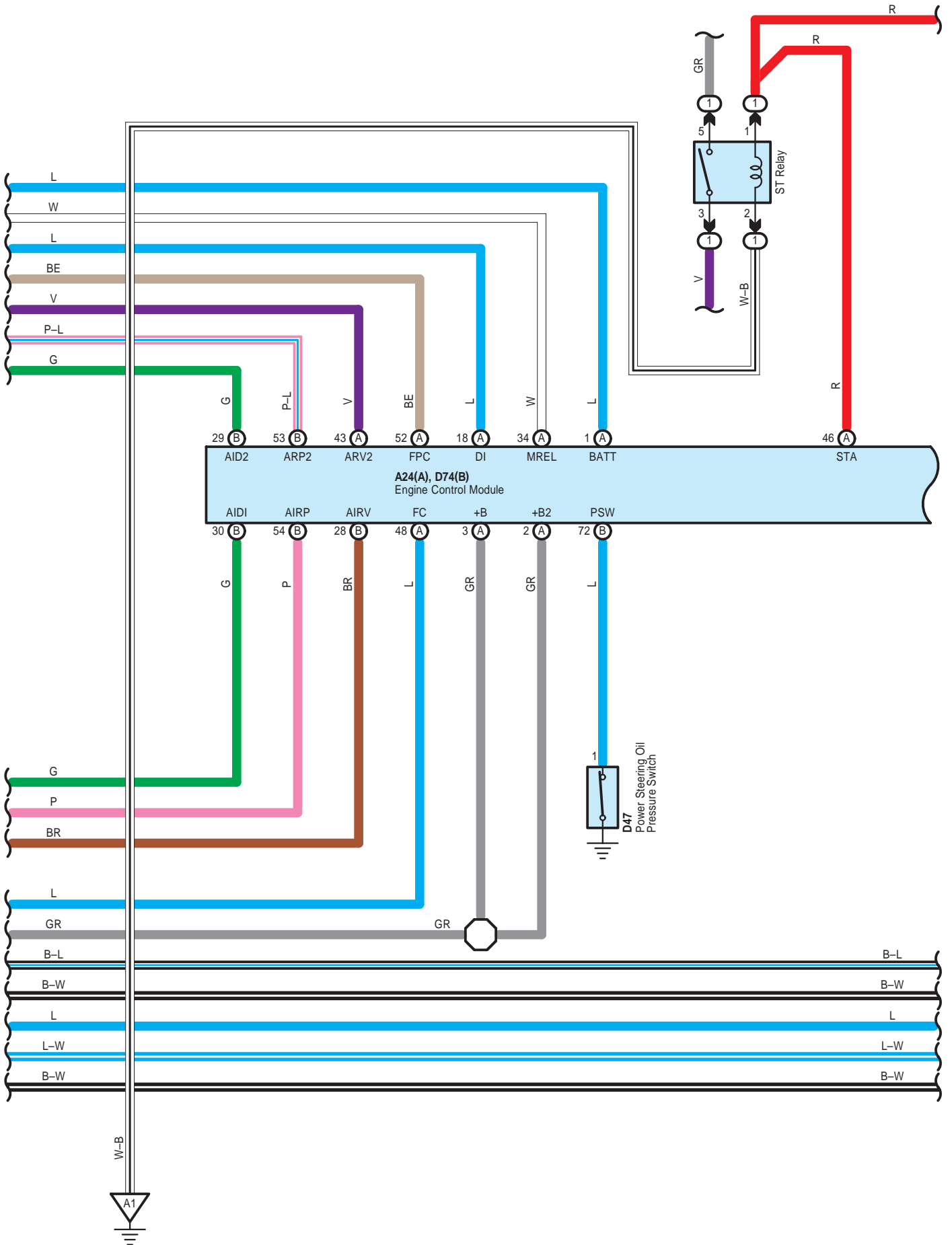

Engine Control <1GR-FE>

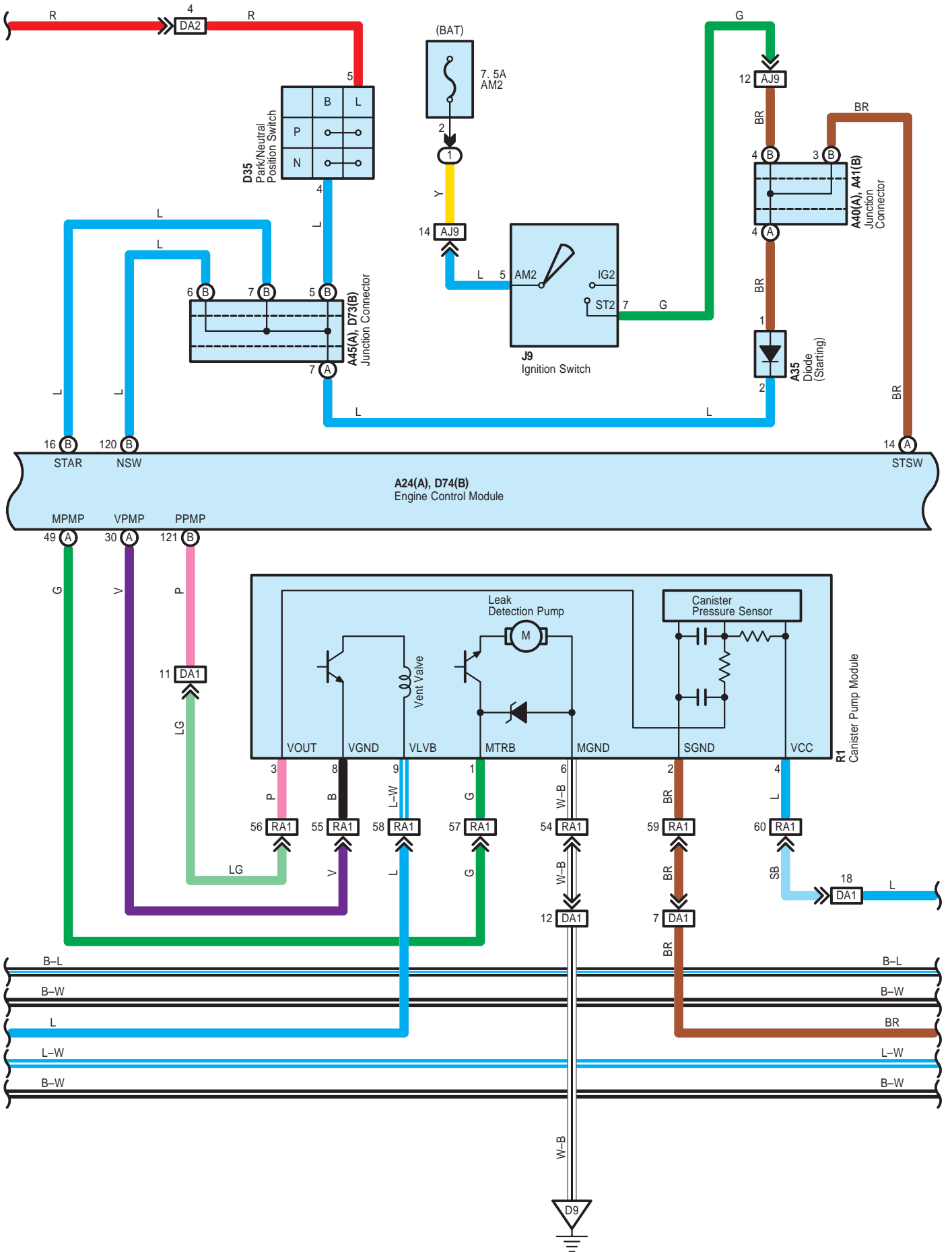

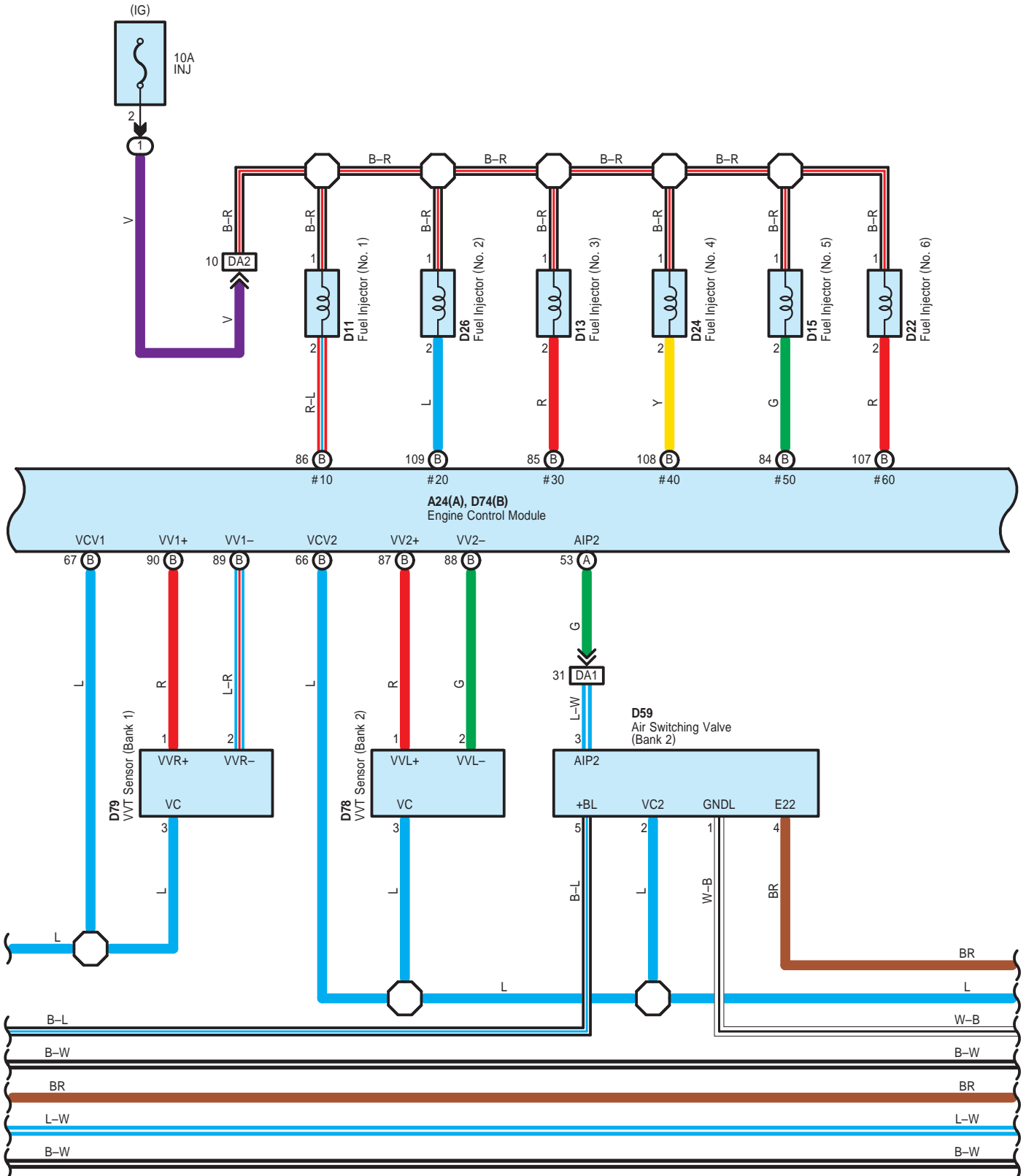

Engine Control <1GR-FE>

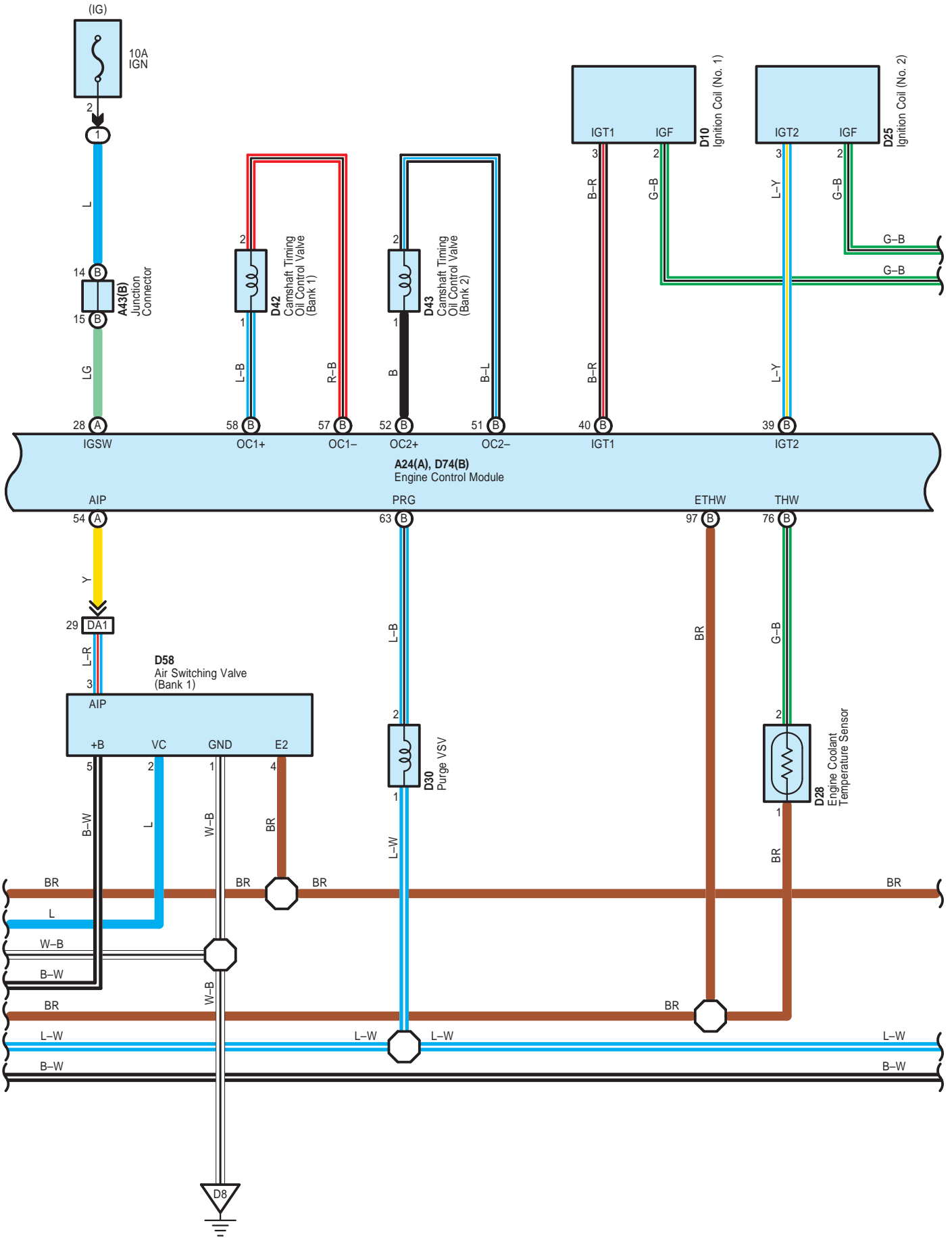

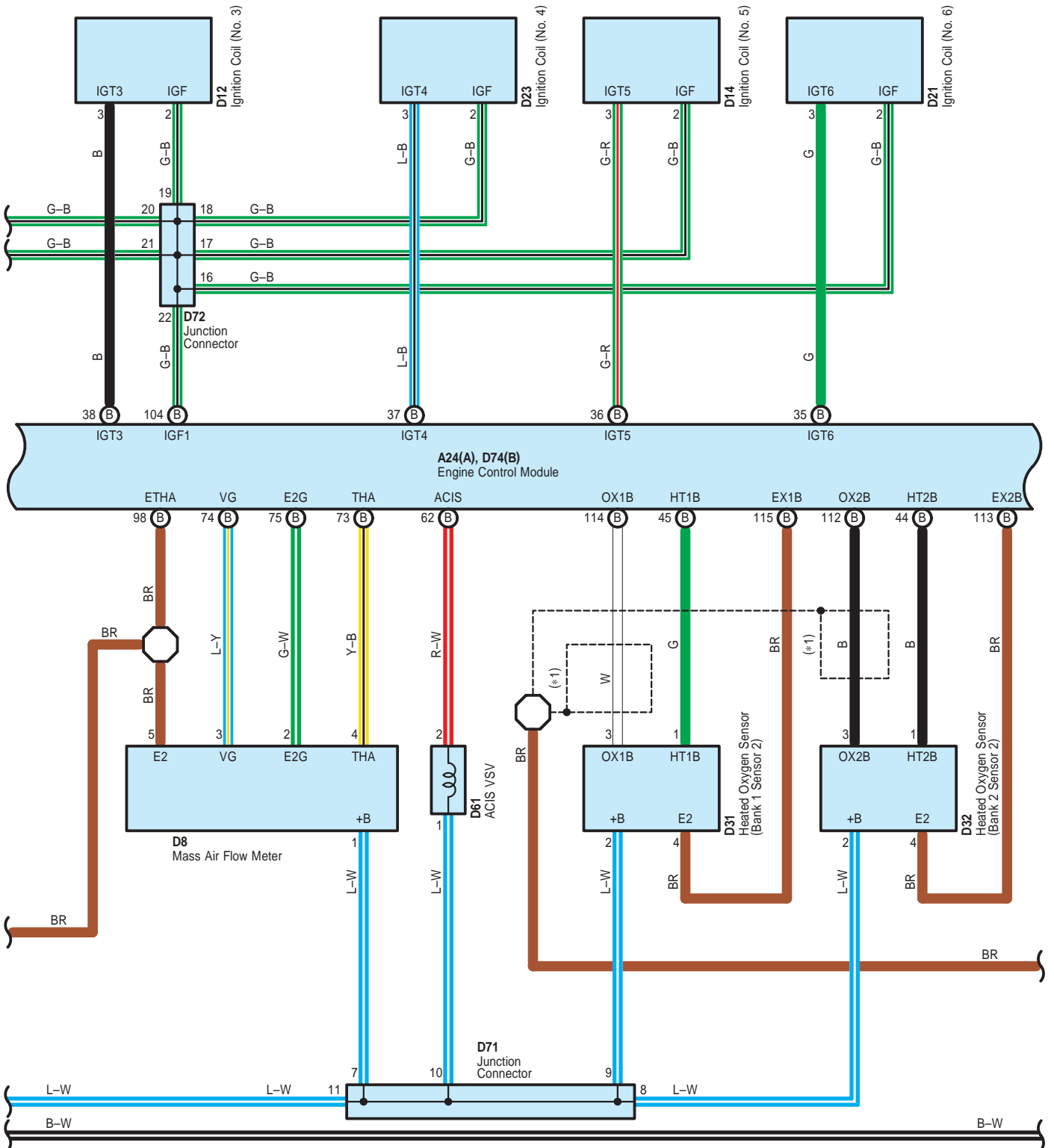

* 1 : Shielded

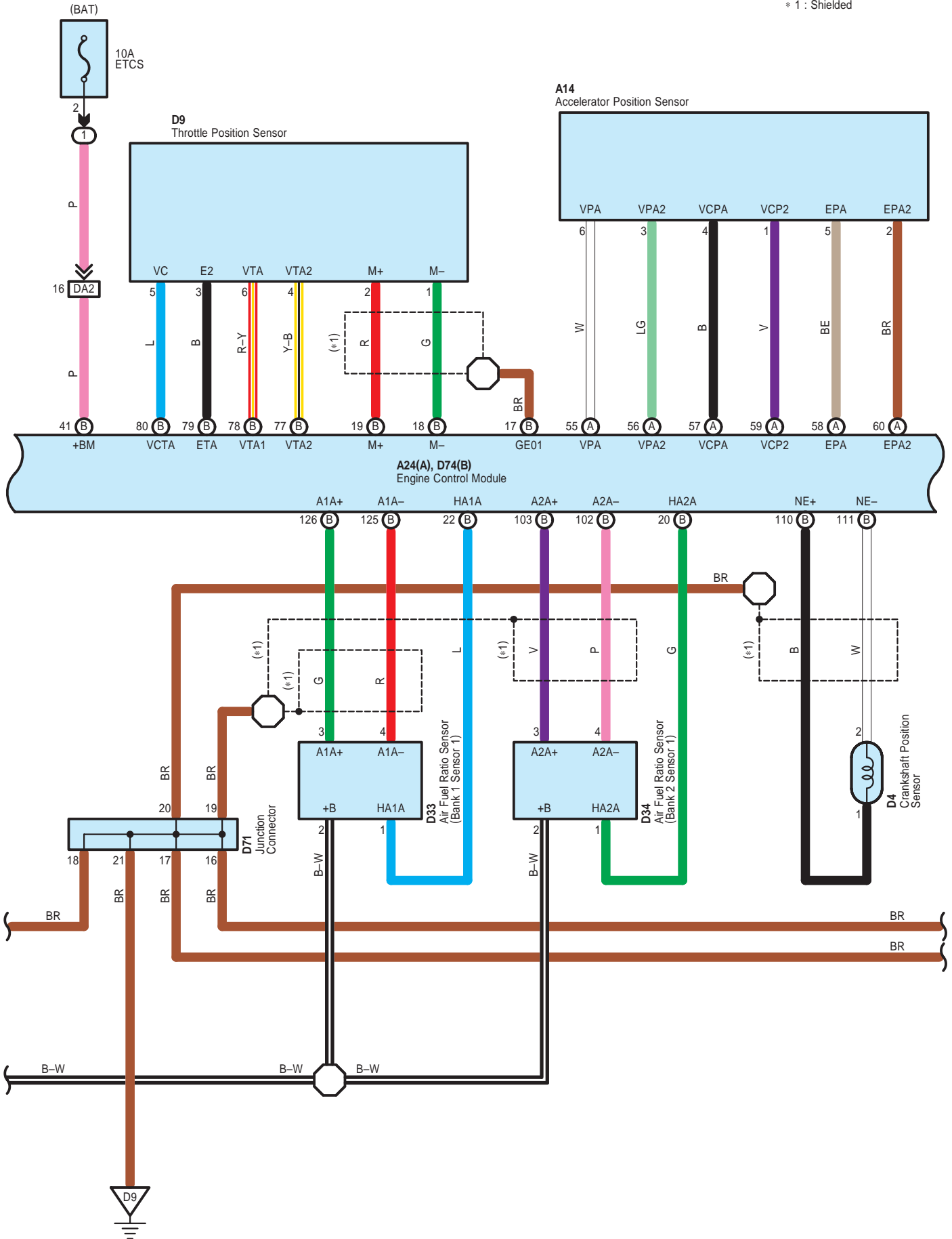

Engine Control <1GR-FE>

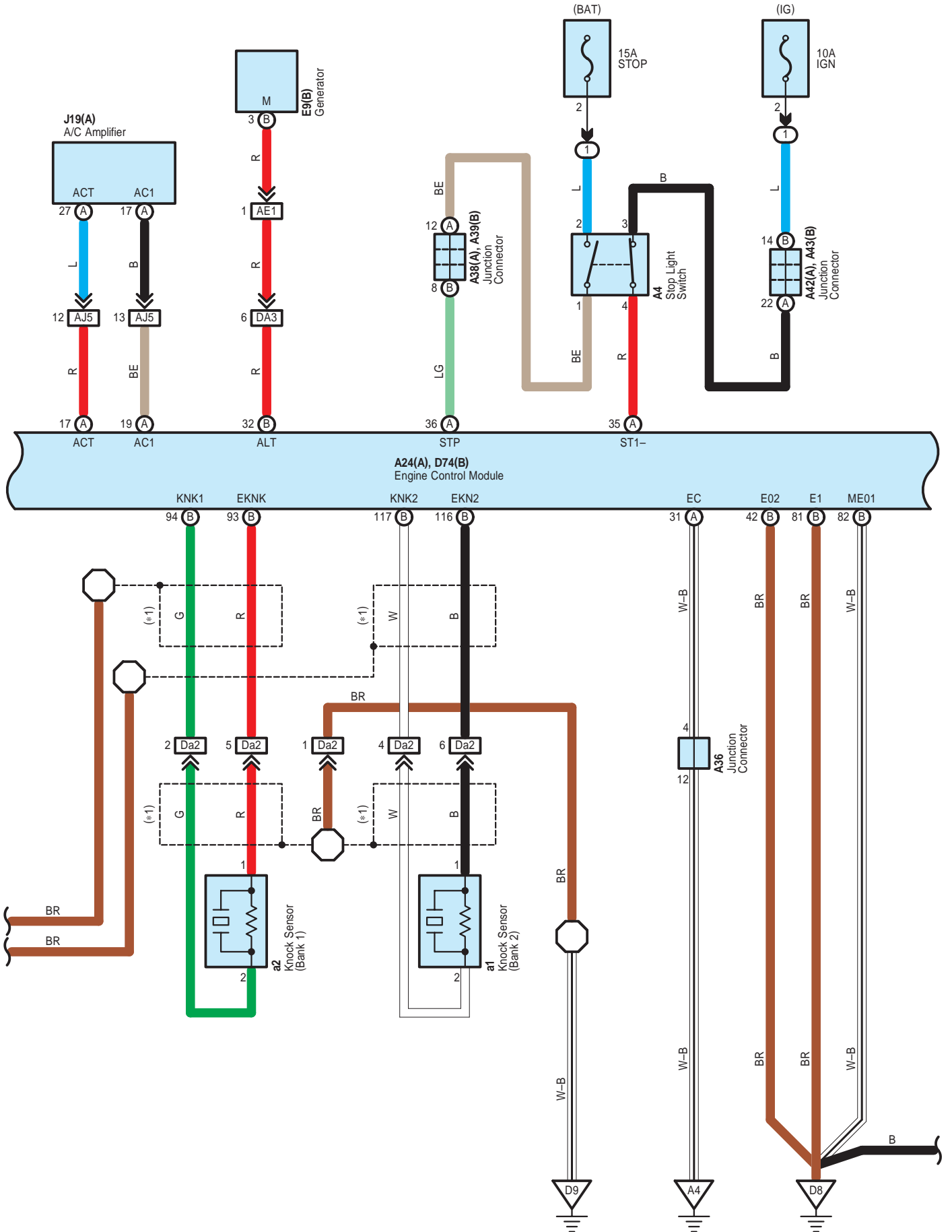

- * 1 : Shielded
- * 2 : Before Nov. 2009 Production
- * 3 : From Nov. 2009 Production

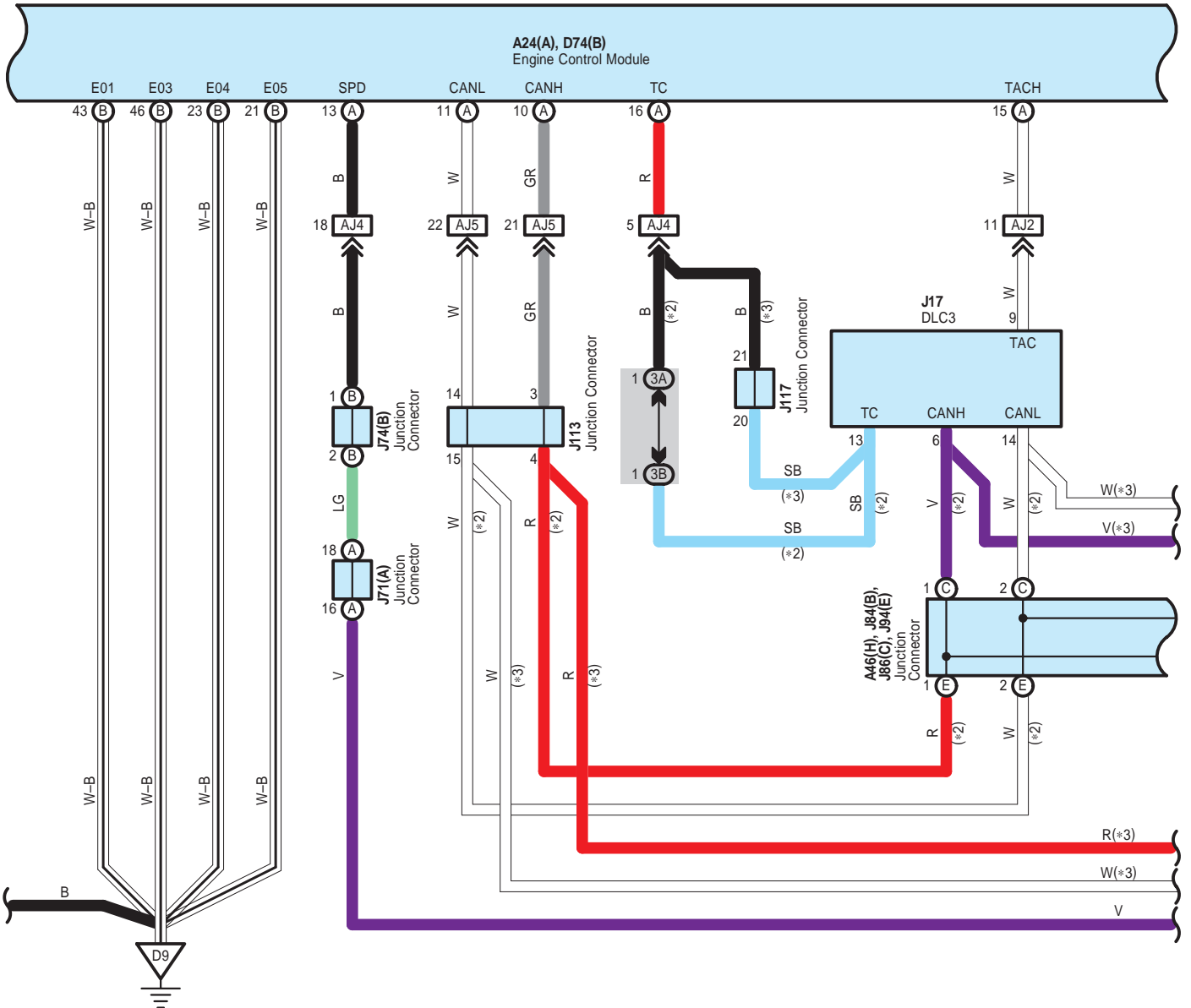

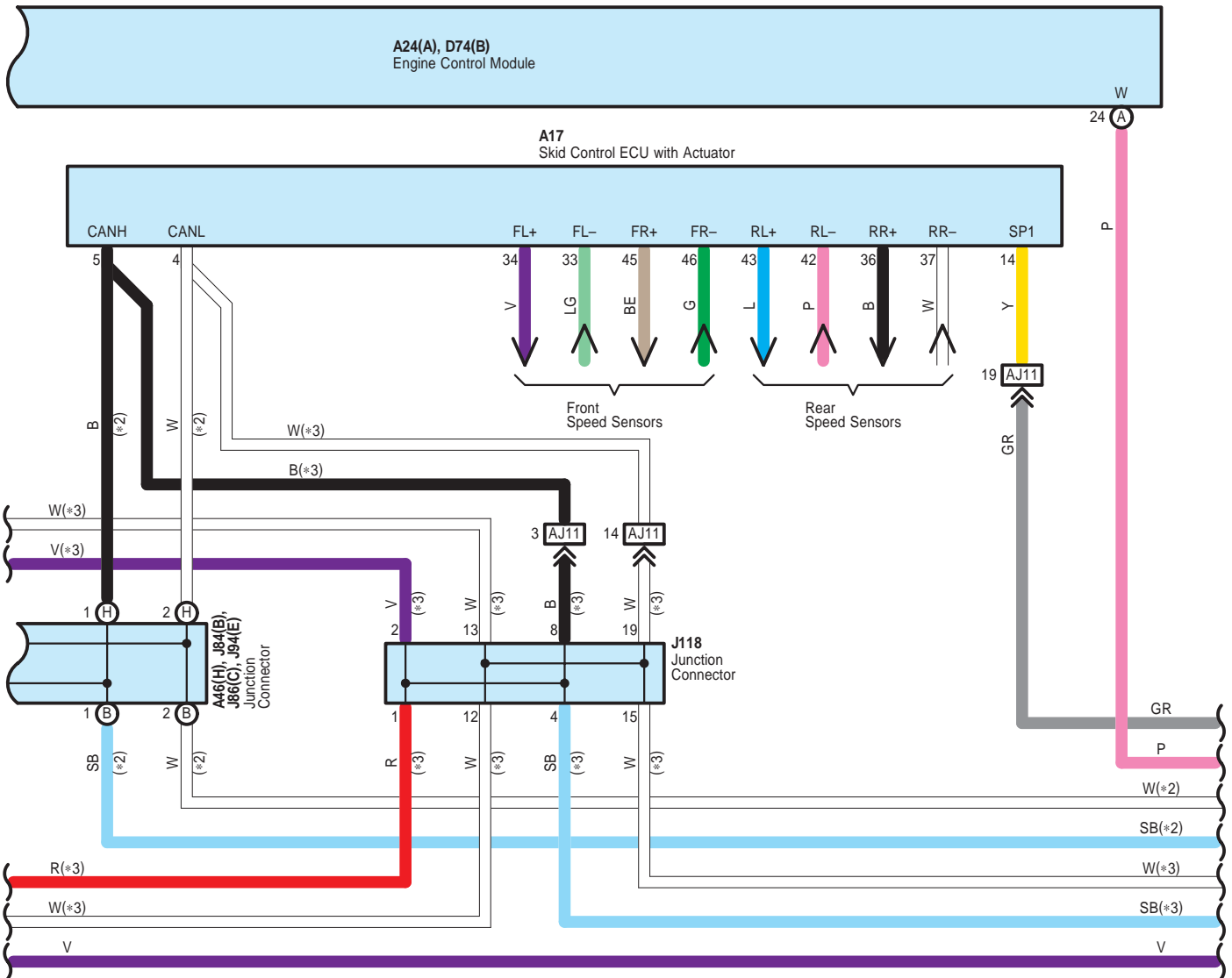

Engine Control <1GR-FE>

* 2 : Before Nov. 2009 Production
 * 3 : From Nov. 2009 Production

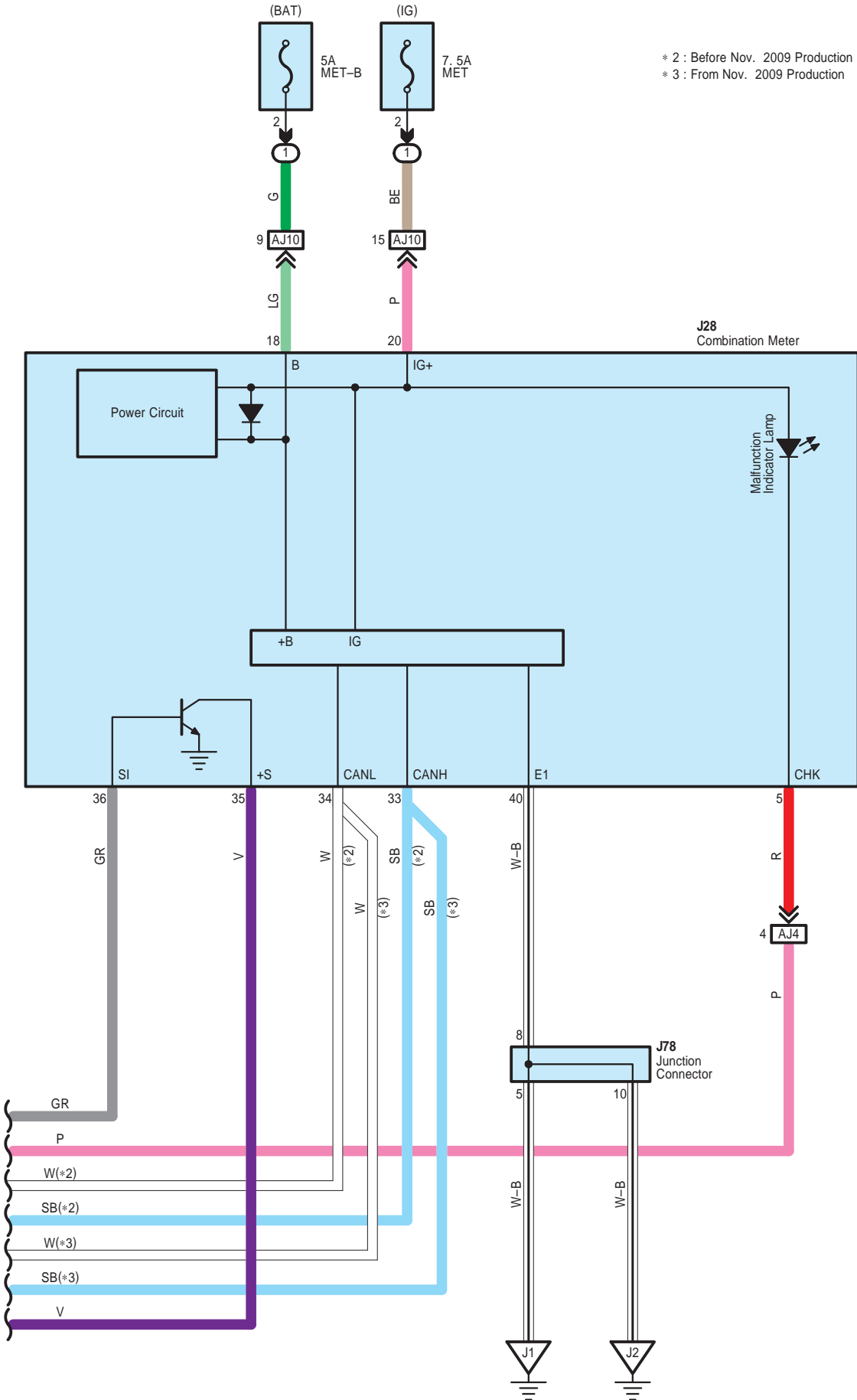

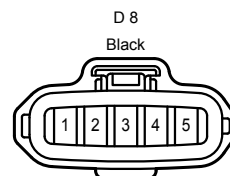
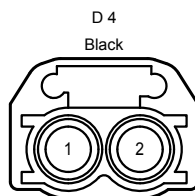
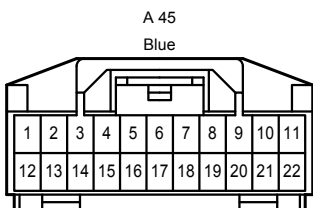
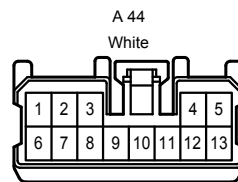
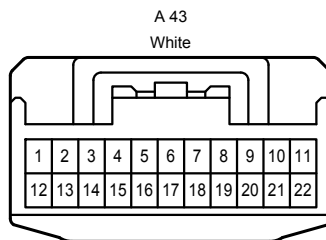
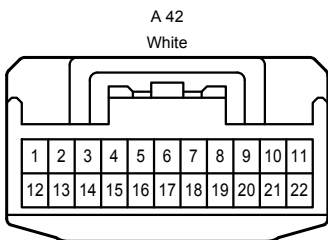
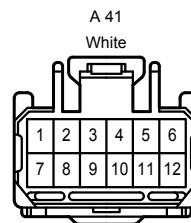
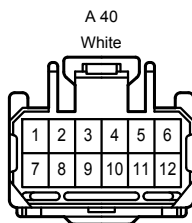
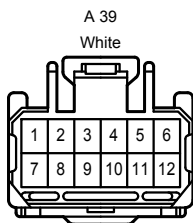
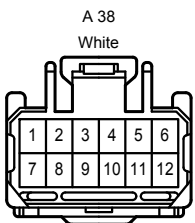
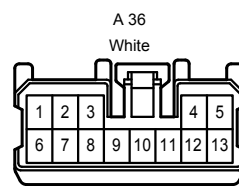
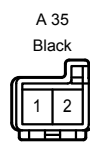
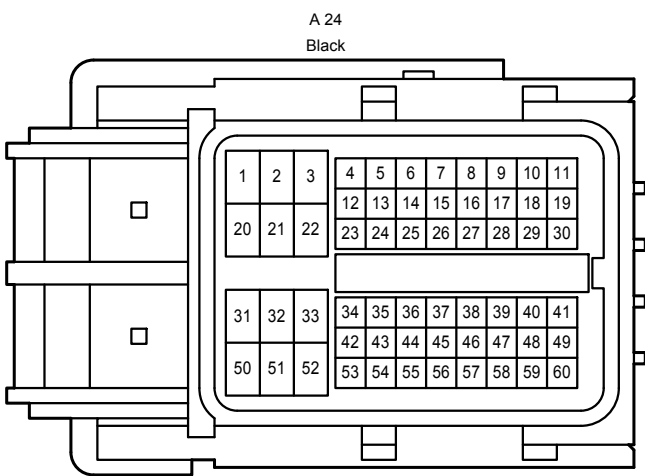
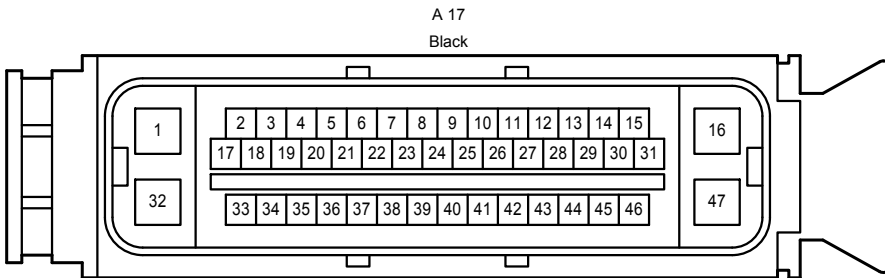
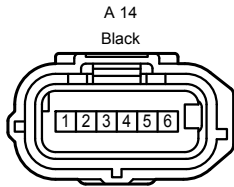
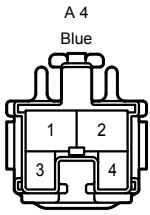

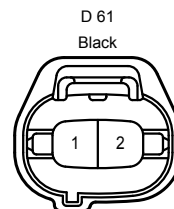
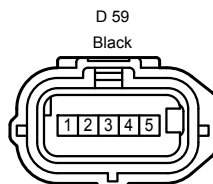
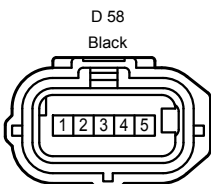
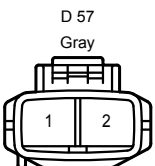
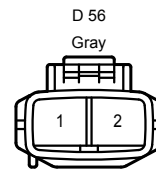
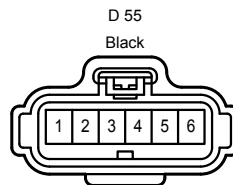
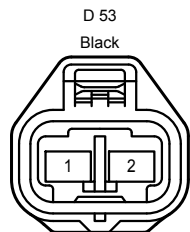
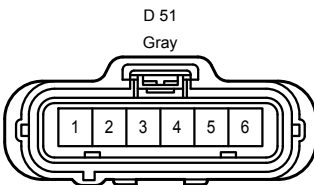
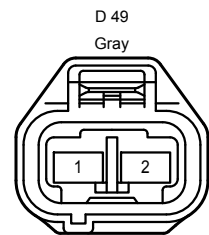
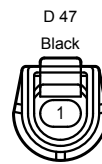
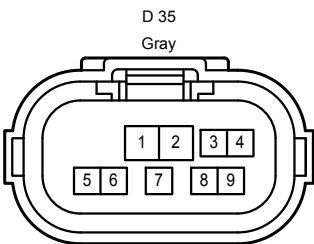
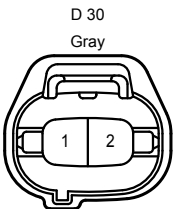
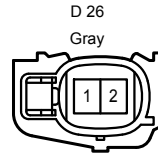
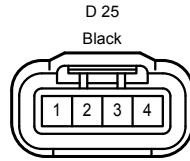
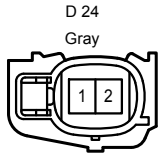
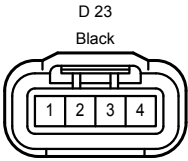
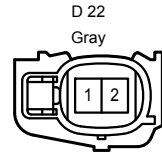
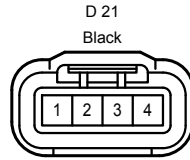
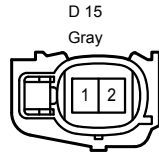
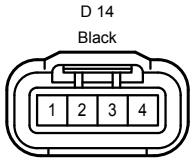
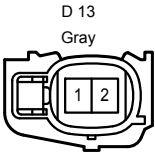
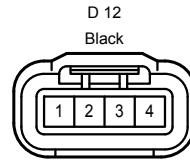
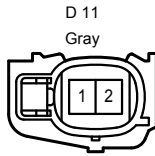
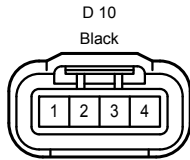
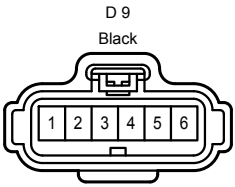

D 71
White

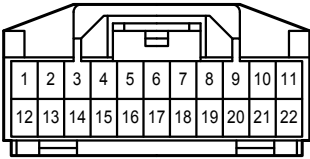

D 72
White

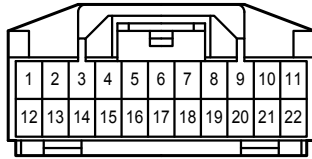

D 73
Blue

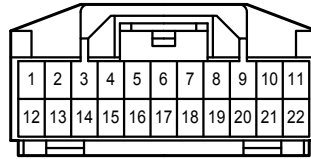

D 74
Black

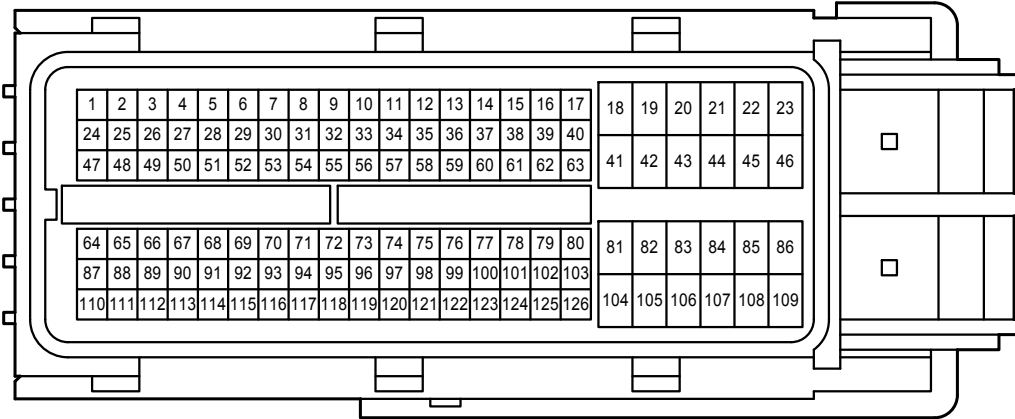

D 78
Black

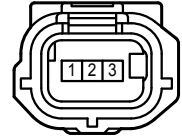

D 79
Black

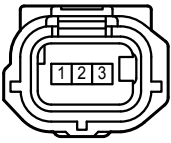

E 9
Black



J 9
White

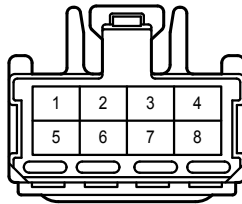

J 17
White

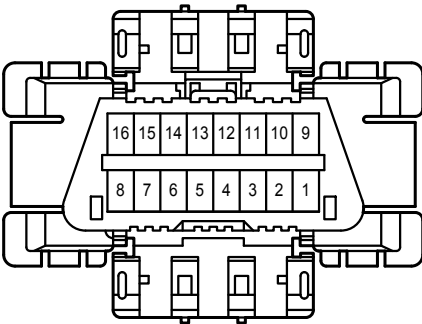

J 19
White

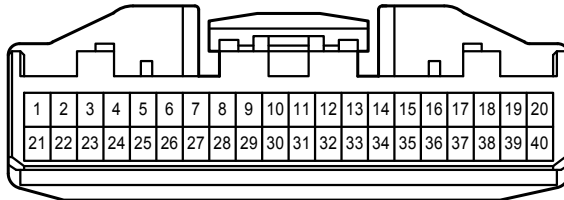

J 28
White

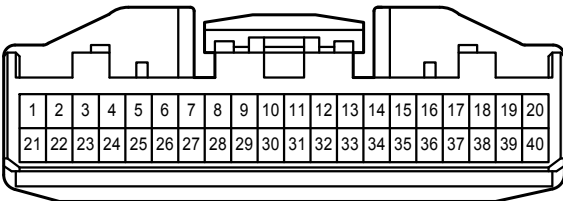

J 71
Black

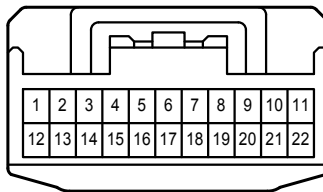

J 74
Black

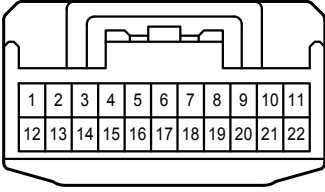

J 78
White

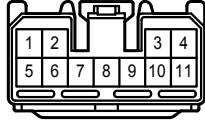

J 84
White

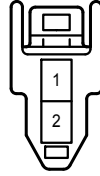

J 86
White

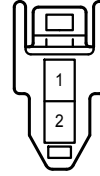

J 94
White

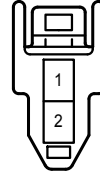

J113
Gray

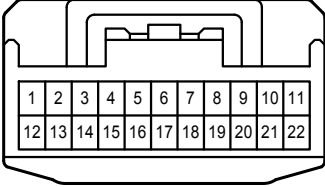

J117
Black

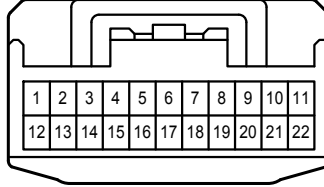

J118
Gray

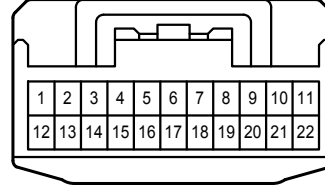

R 1
Black



R 6
White



R 7
Black



R 8
Gray

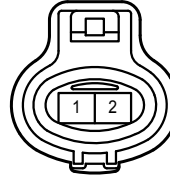

a 1
Black

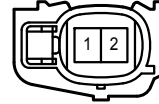

a 2
Gray

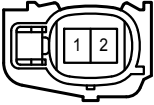

1A
White

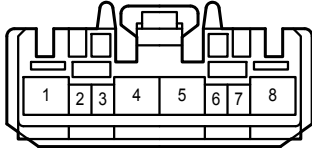

1B
White

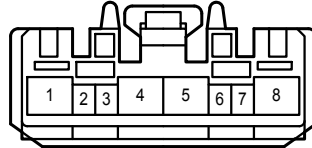

1G

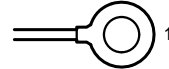

1H

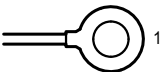

3A
Black

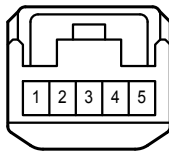

3B
White

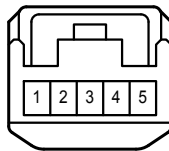

AE1
Gray

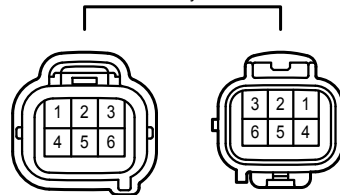

AJ2
White

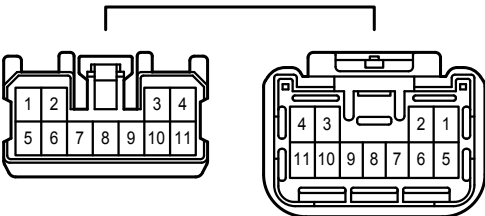

AJ4
White

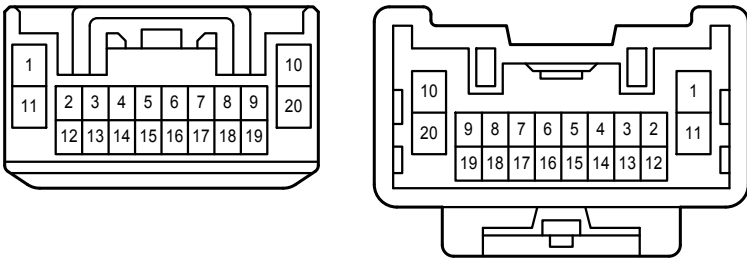

AJ5
White

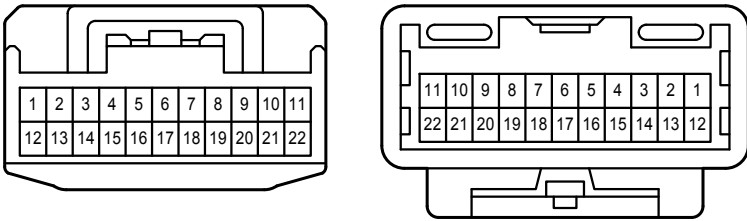

AJ9
Gray

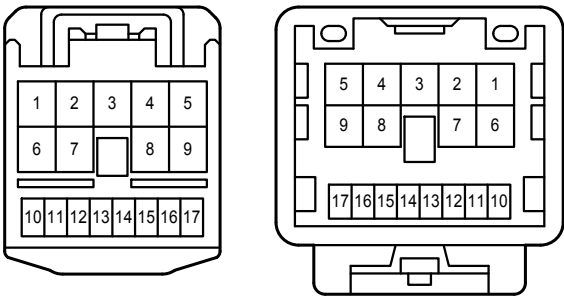

AJ10
Gray

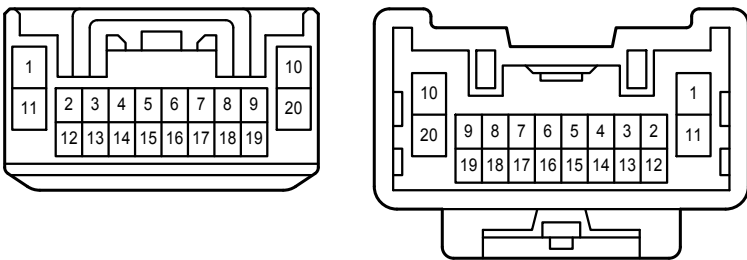

AJ11
Gray

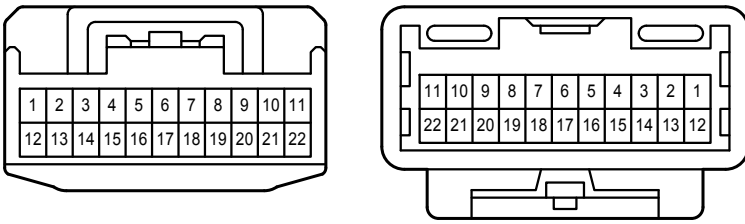

DA1
White

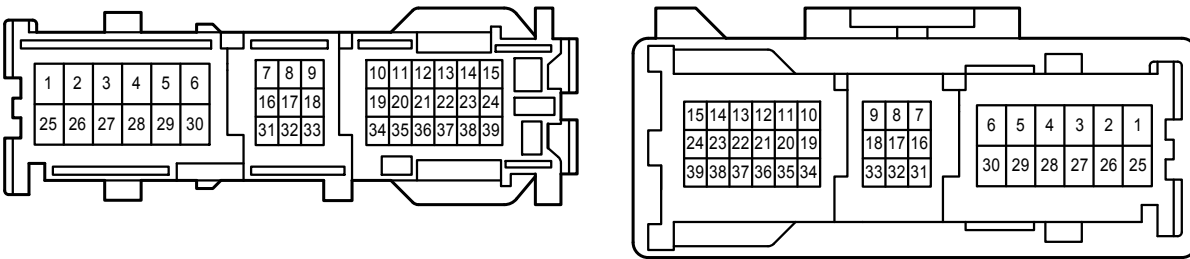

DA2
White

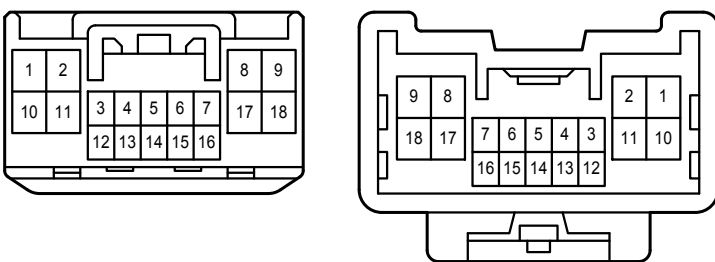

DA3
White

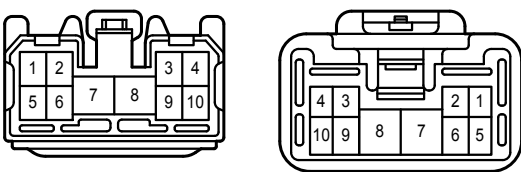

Da2
Gray

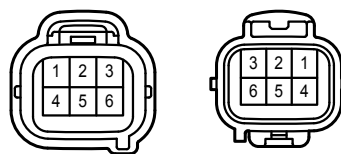

RA1
White

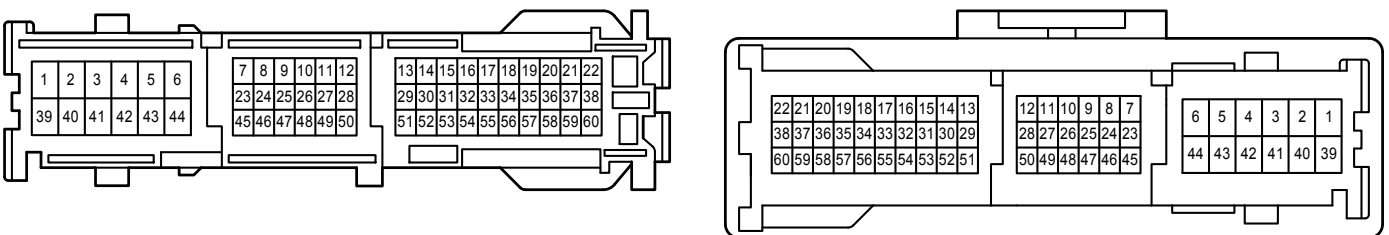

RA2
White

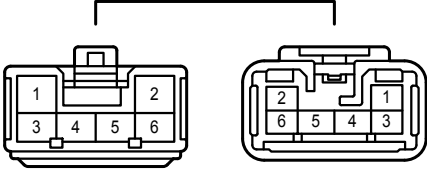

RA3
White

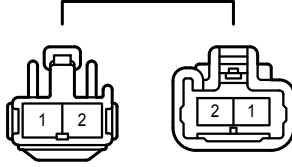

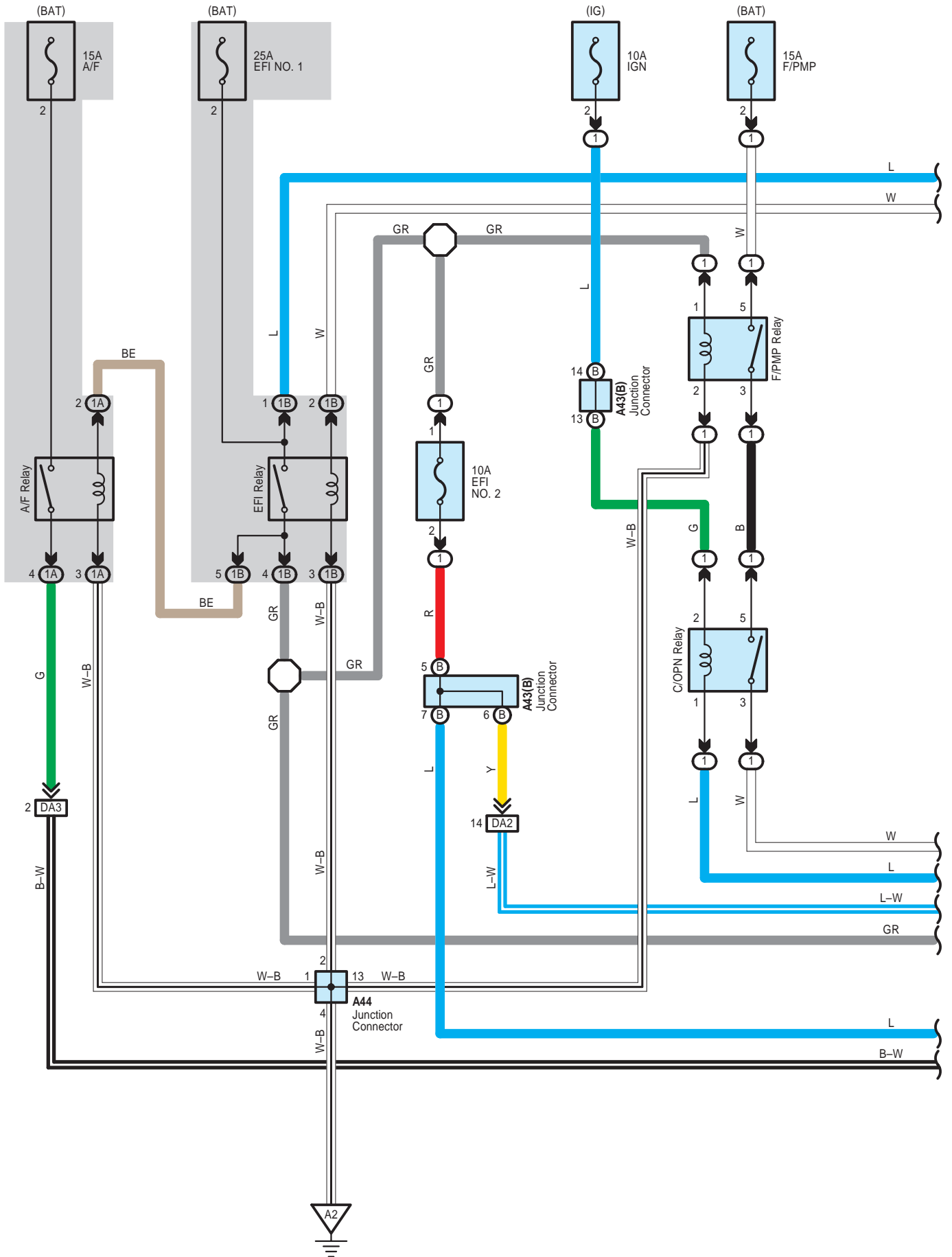

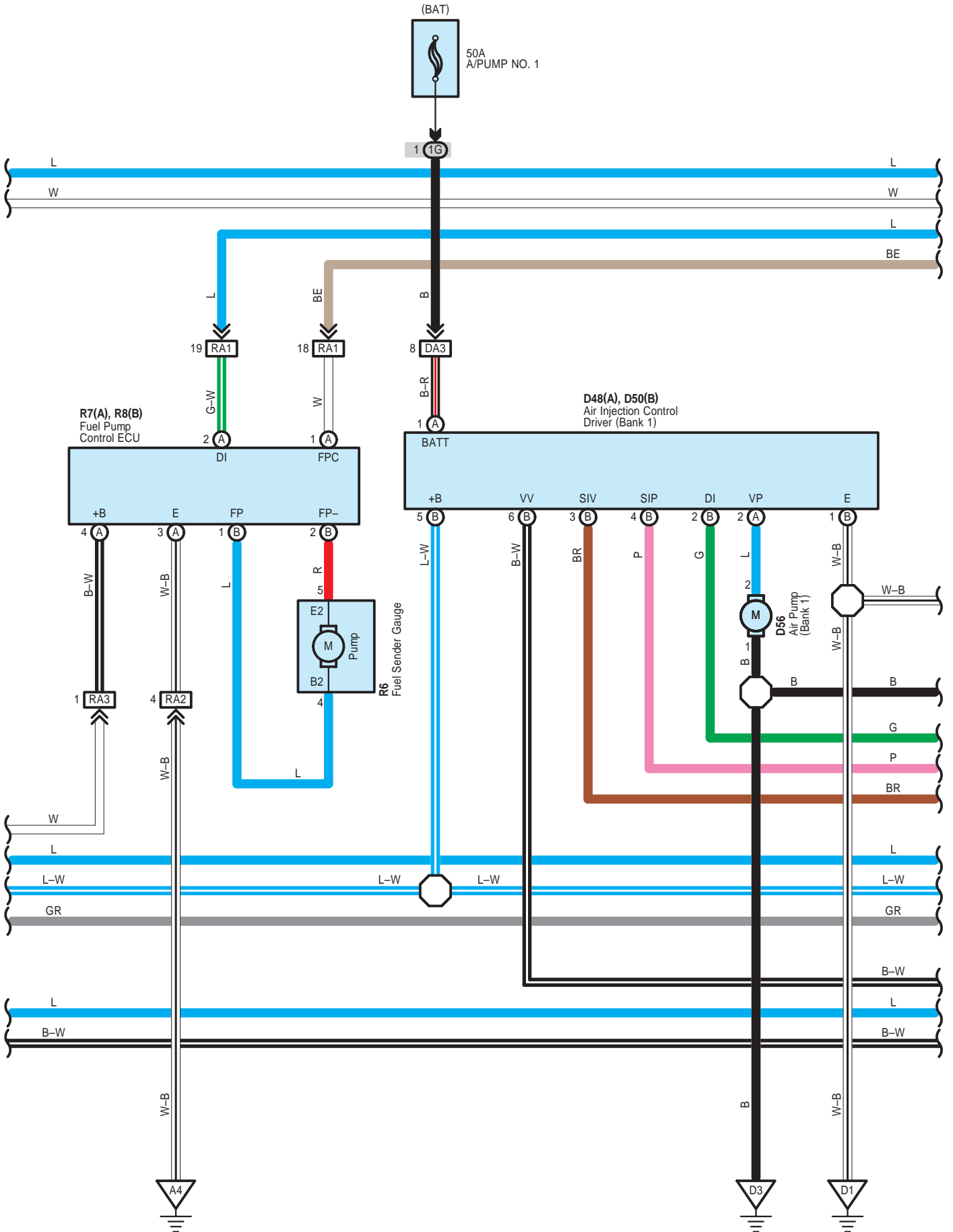

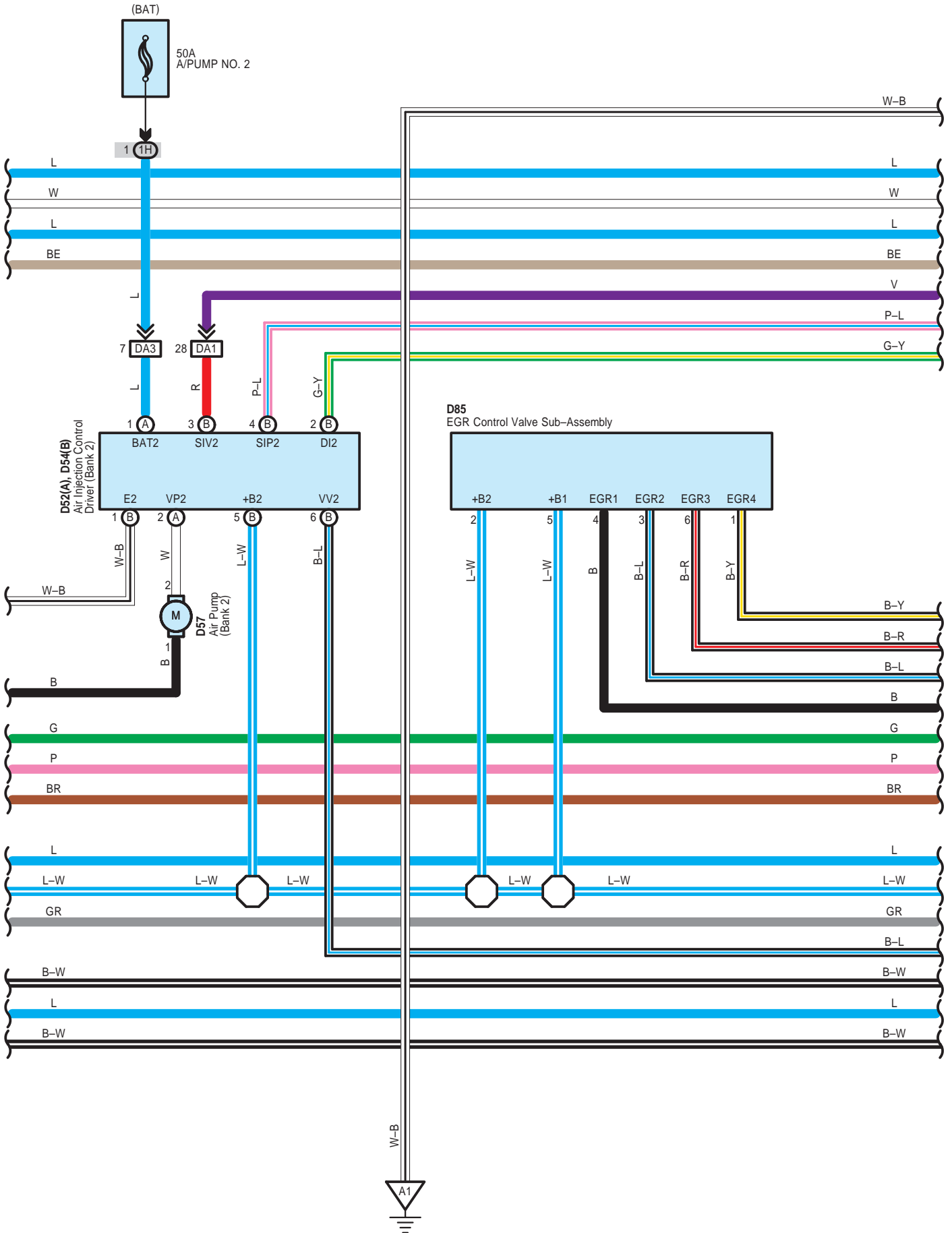

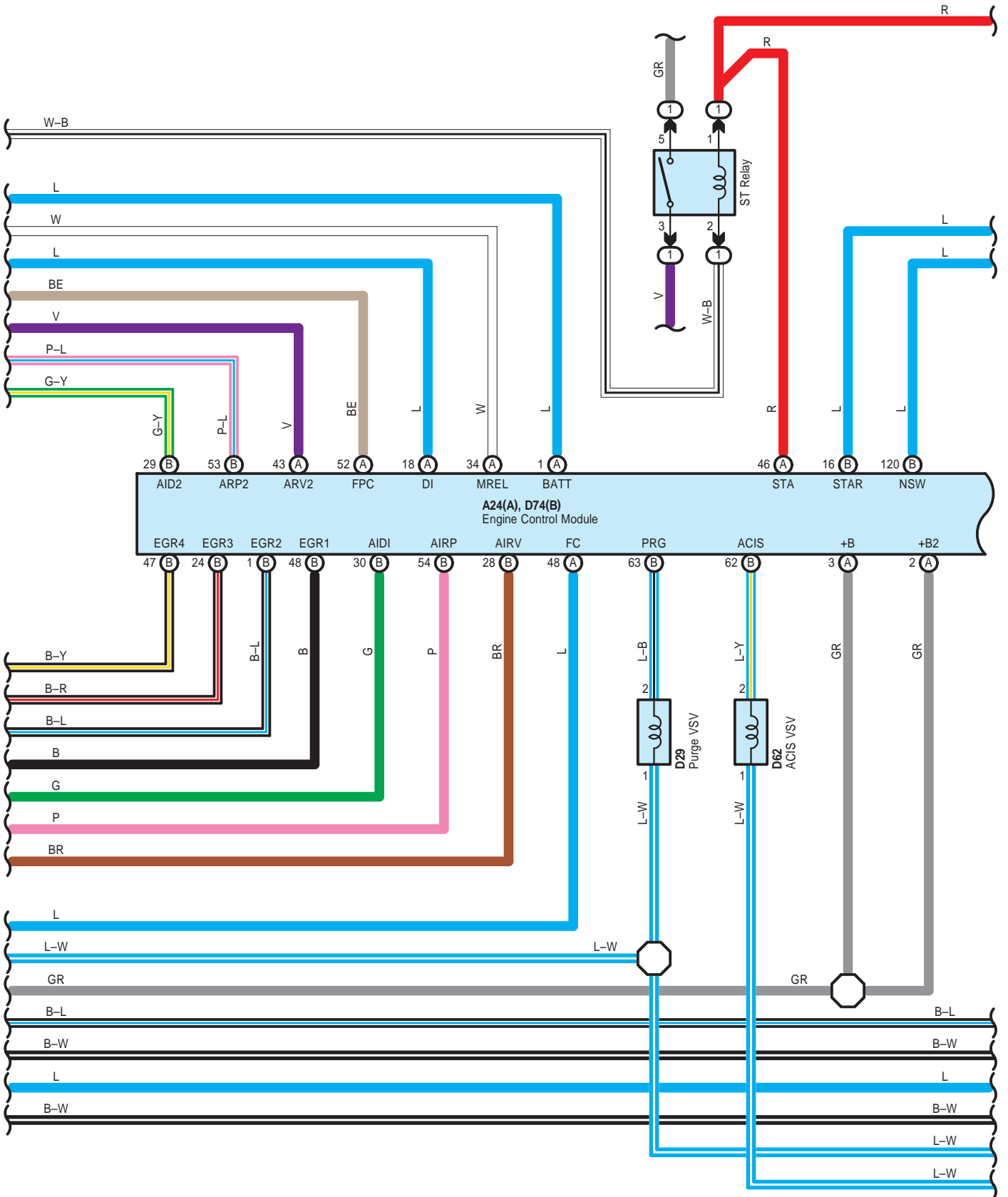

Engine Control <1UR-FE>

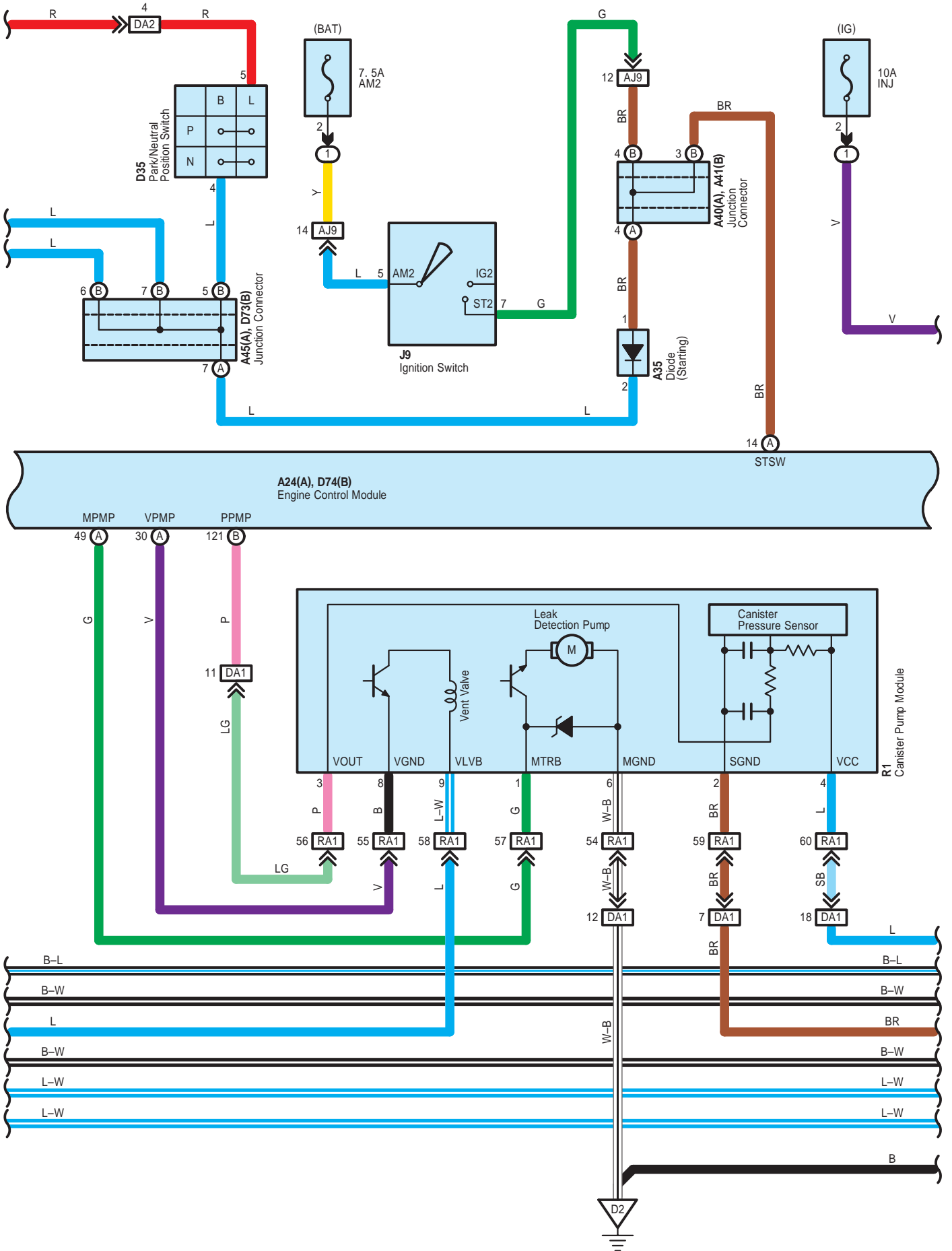

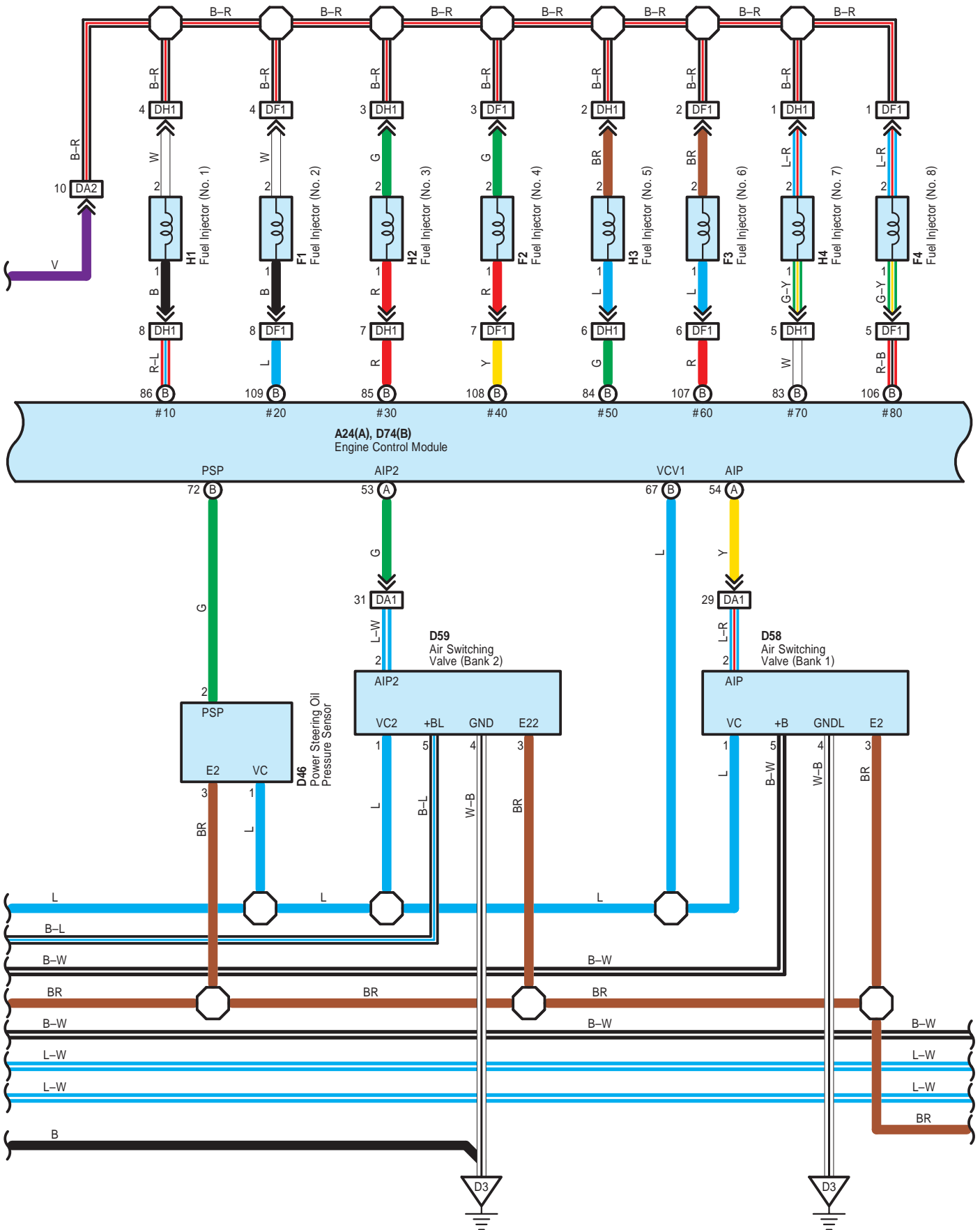

Engine Control <1UR-FE>

* 1 : Shielded

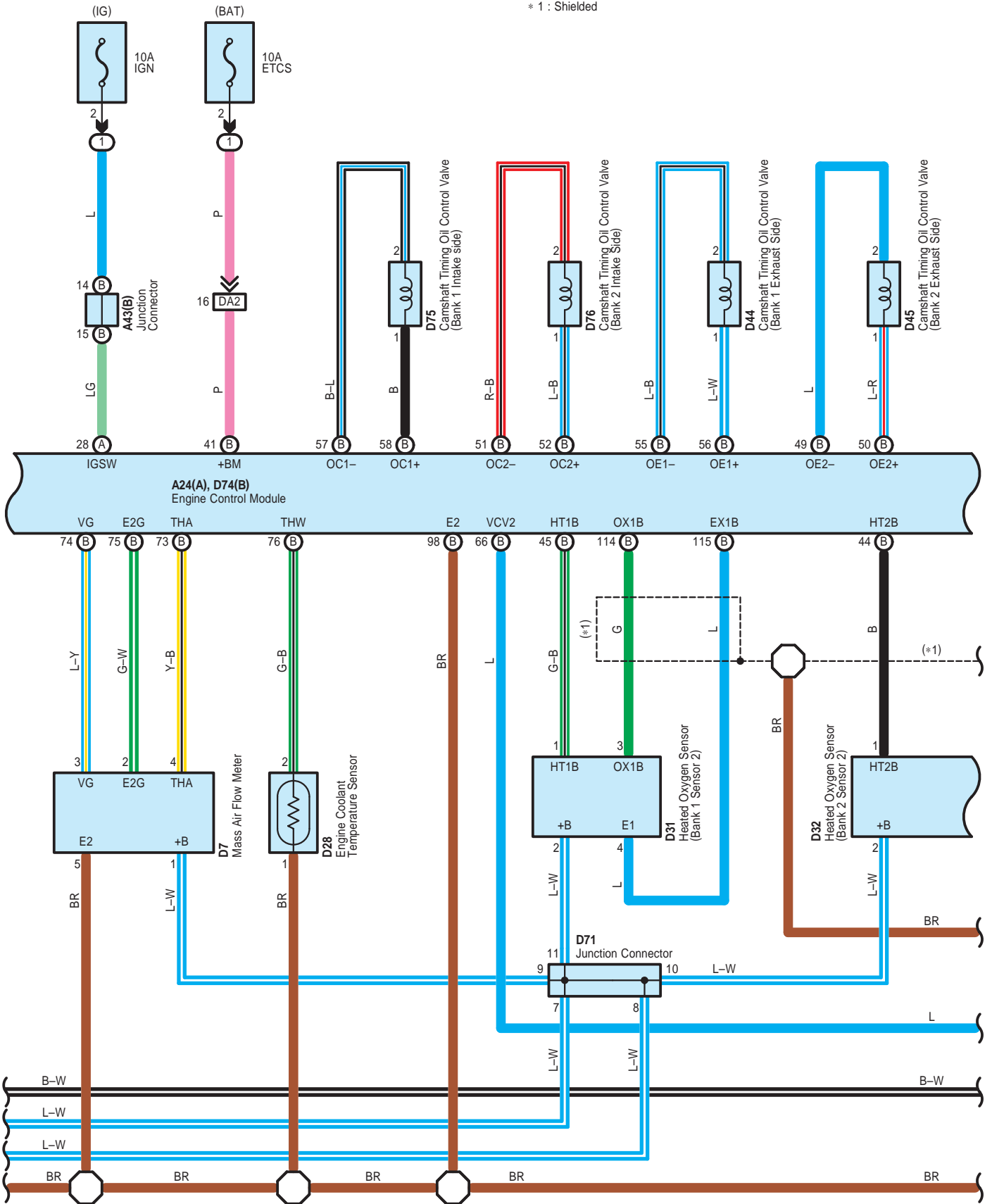

Engine Control <1UR-FE>

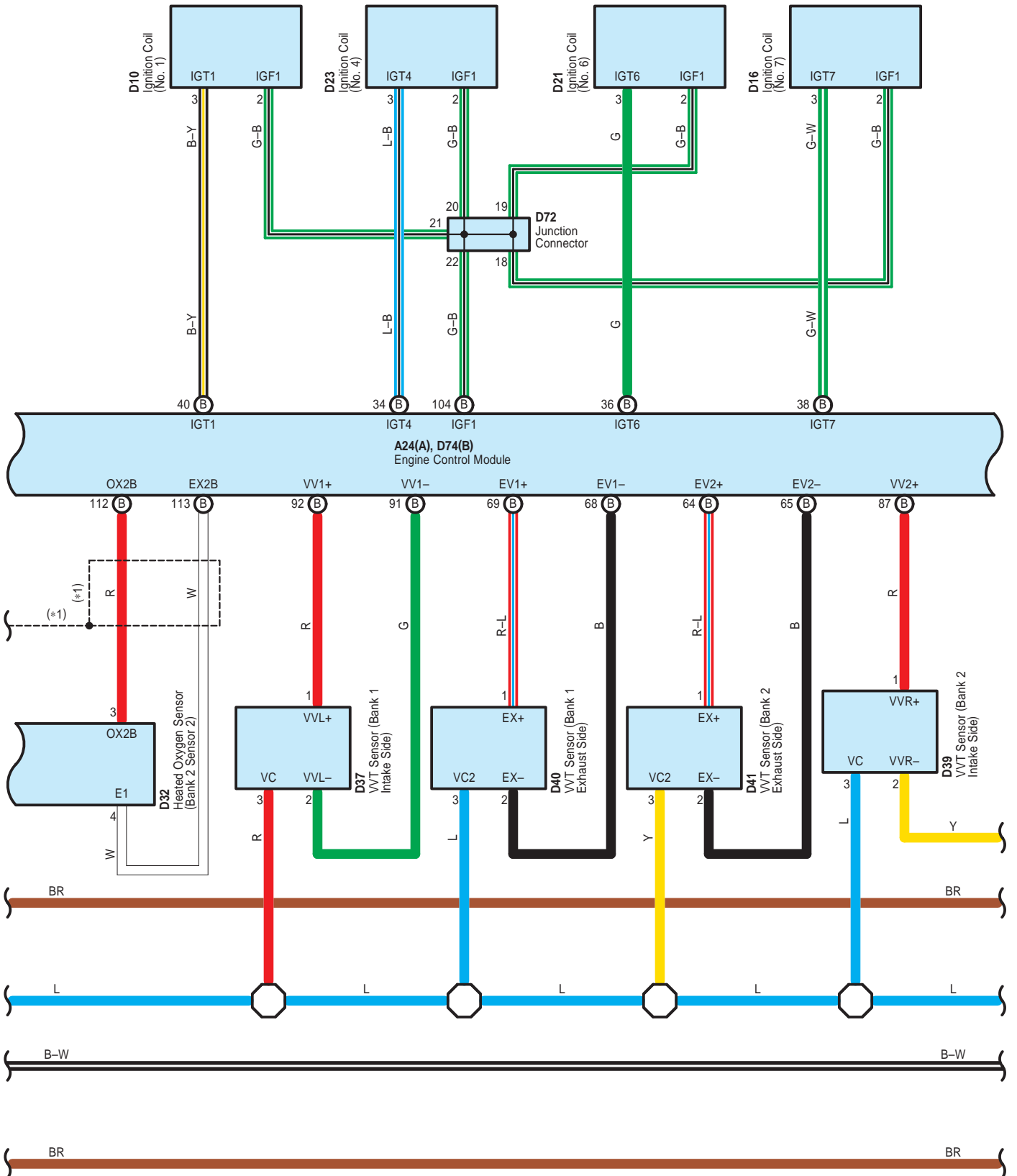

Engine Control <1UR-FE>

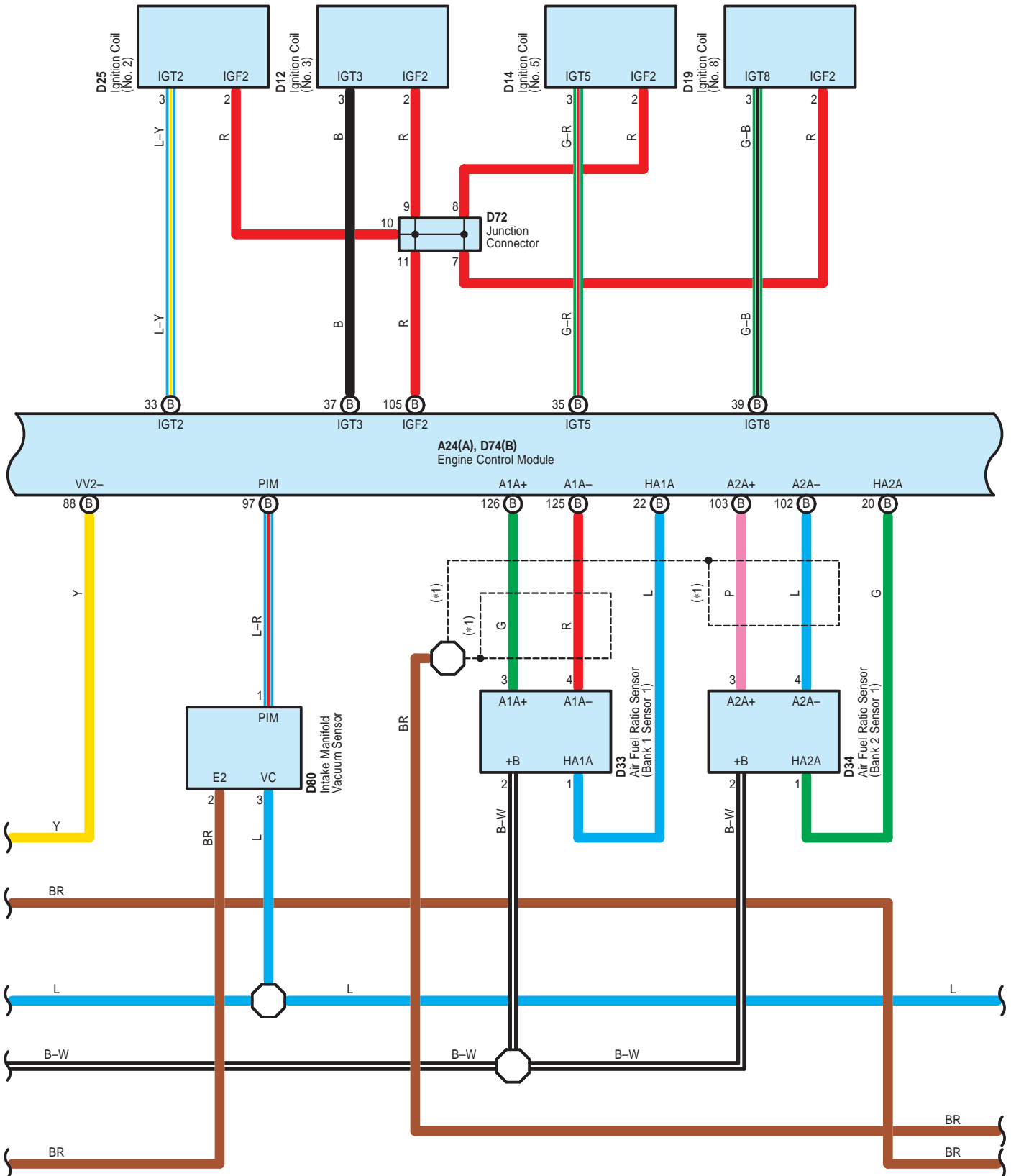

* 1 : Shielded

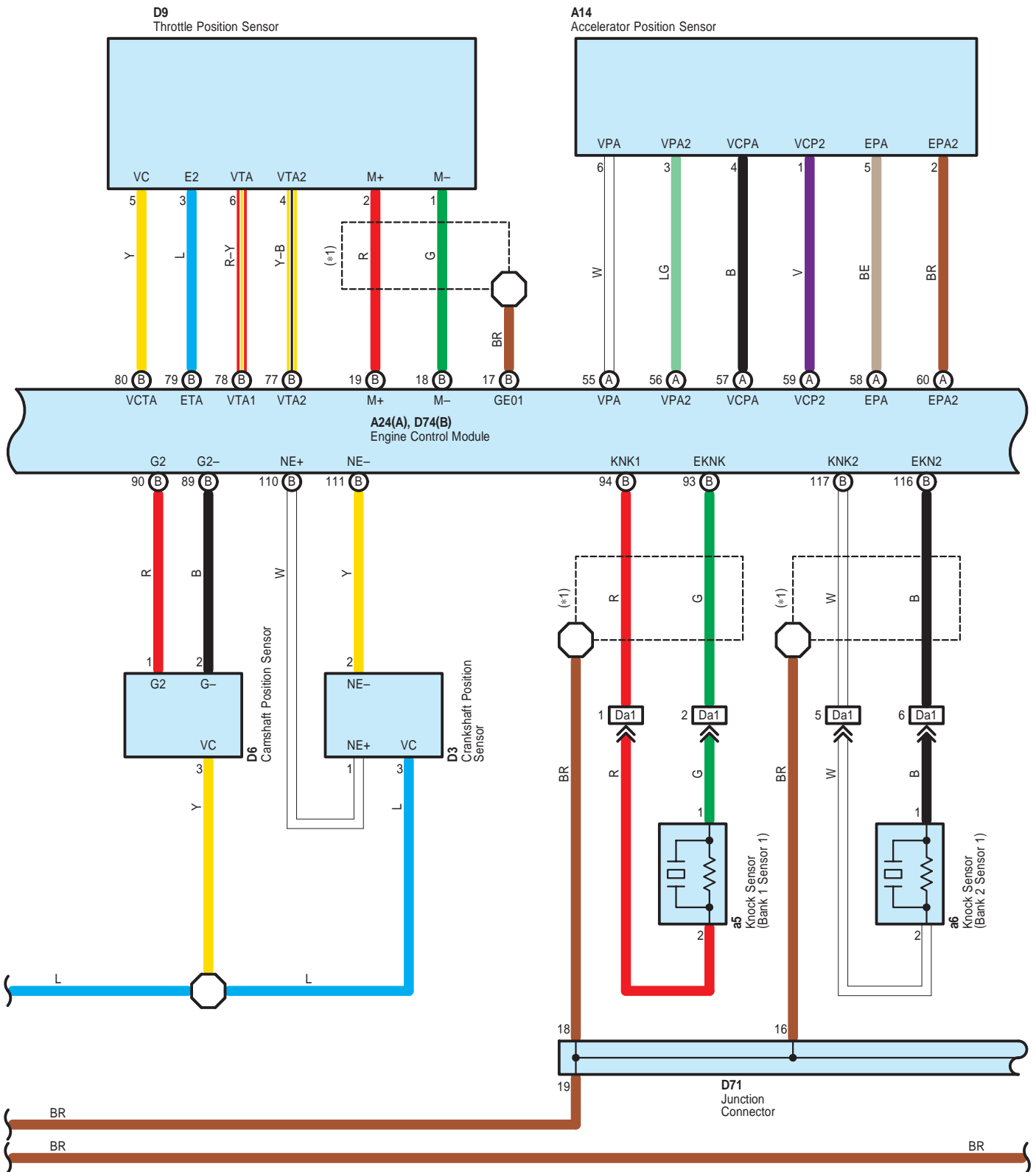

- * 1 : Shielded
- * 2 : Before Nov. 2009 Production
- * 3 : From Nov. 2009 Production

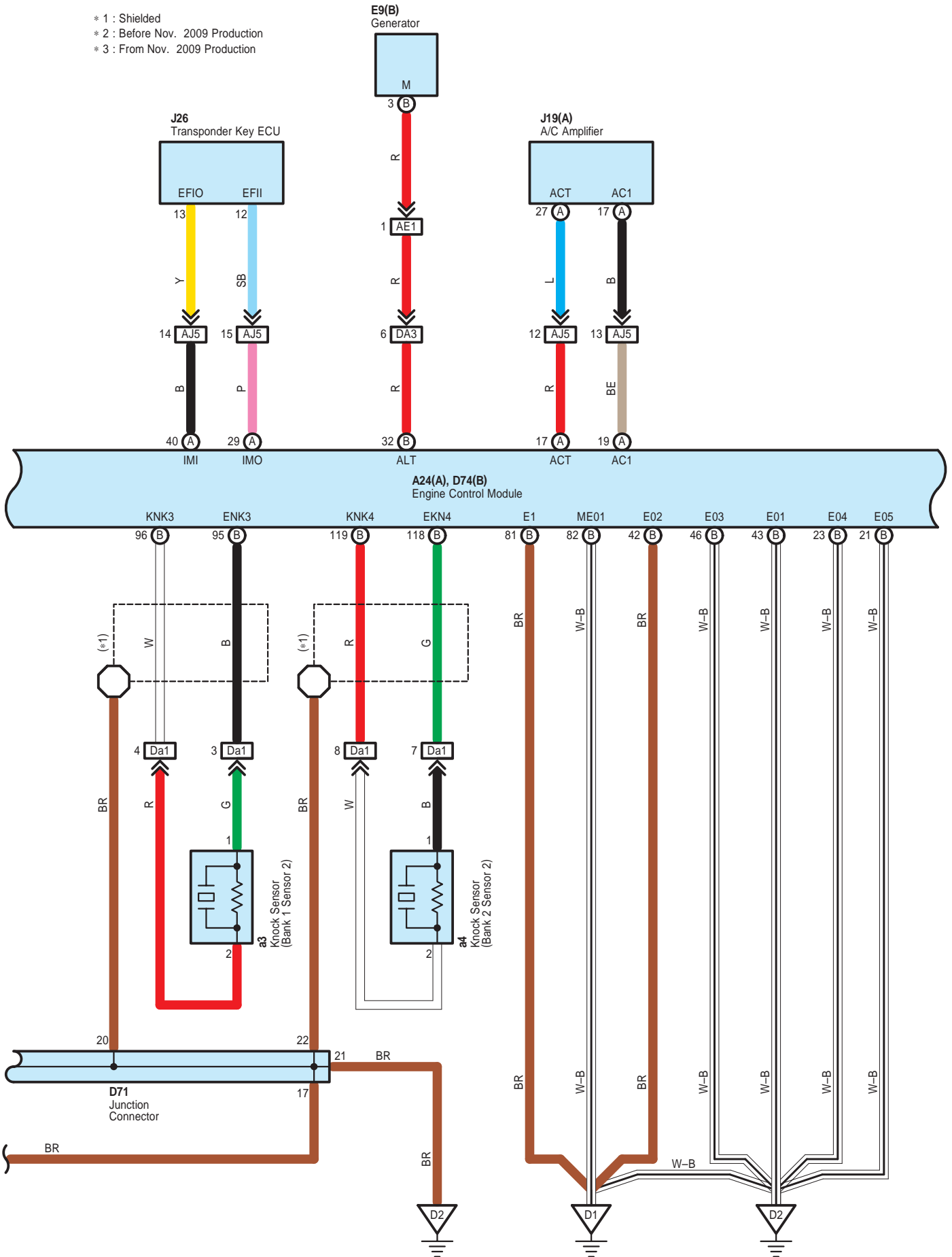

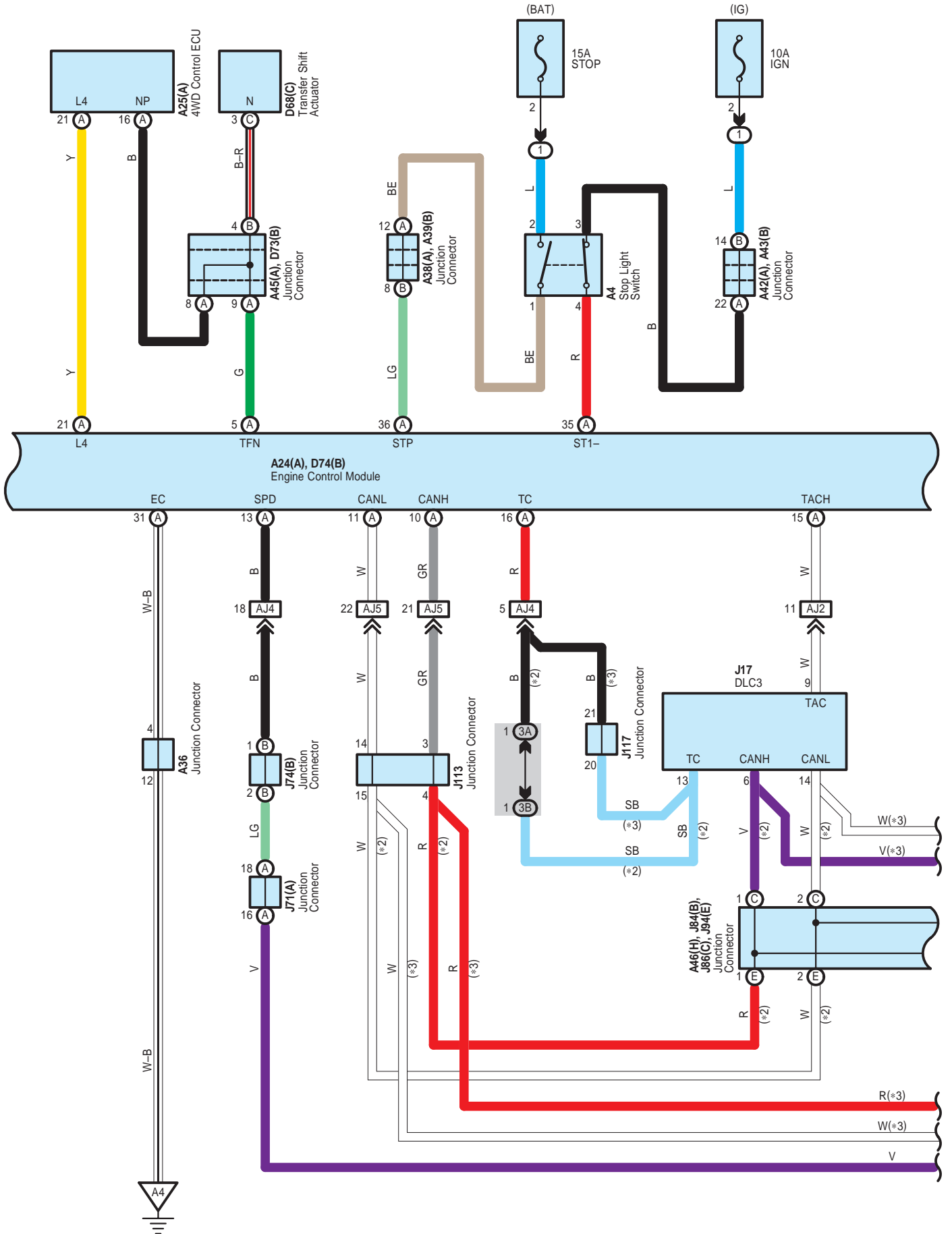

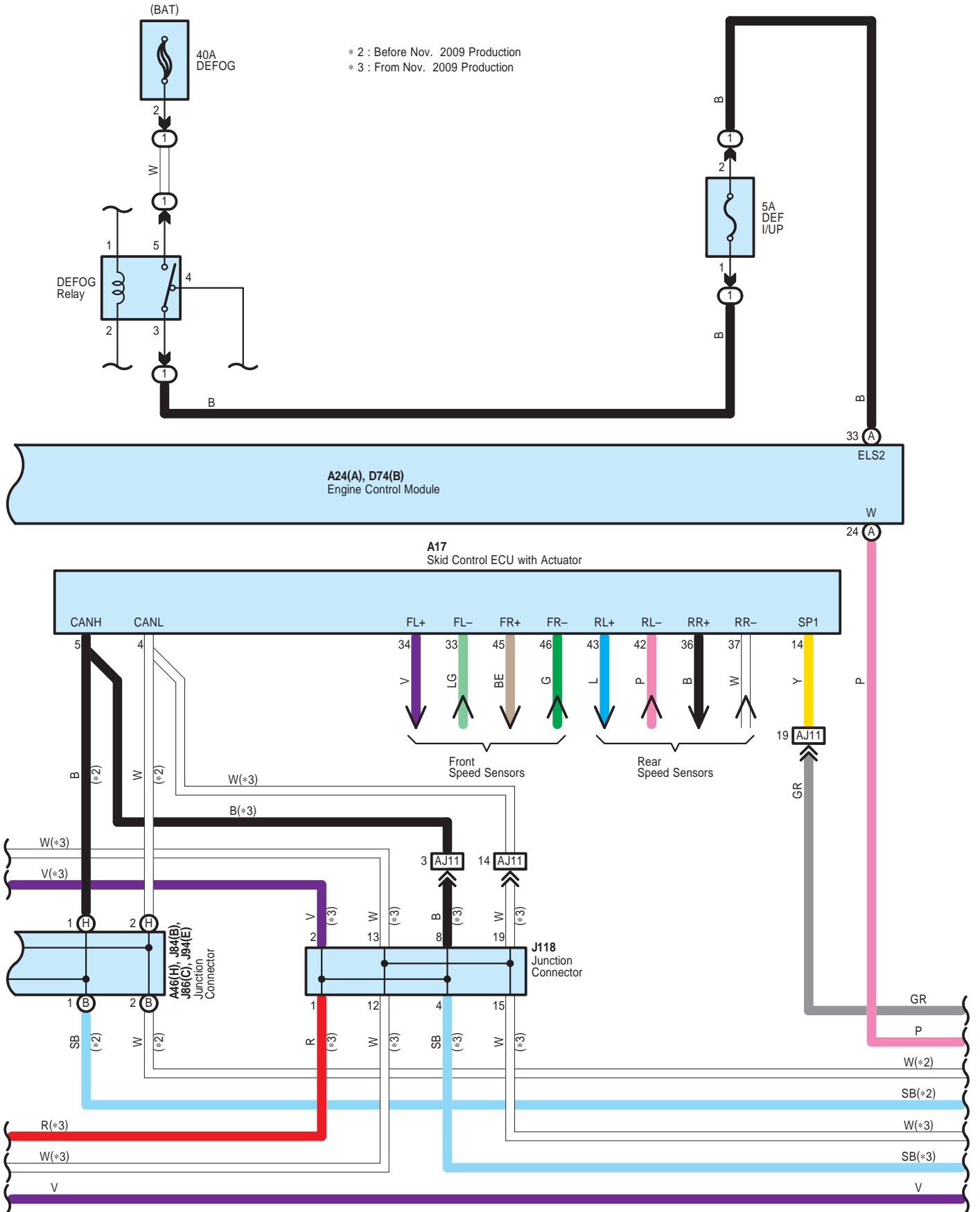

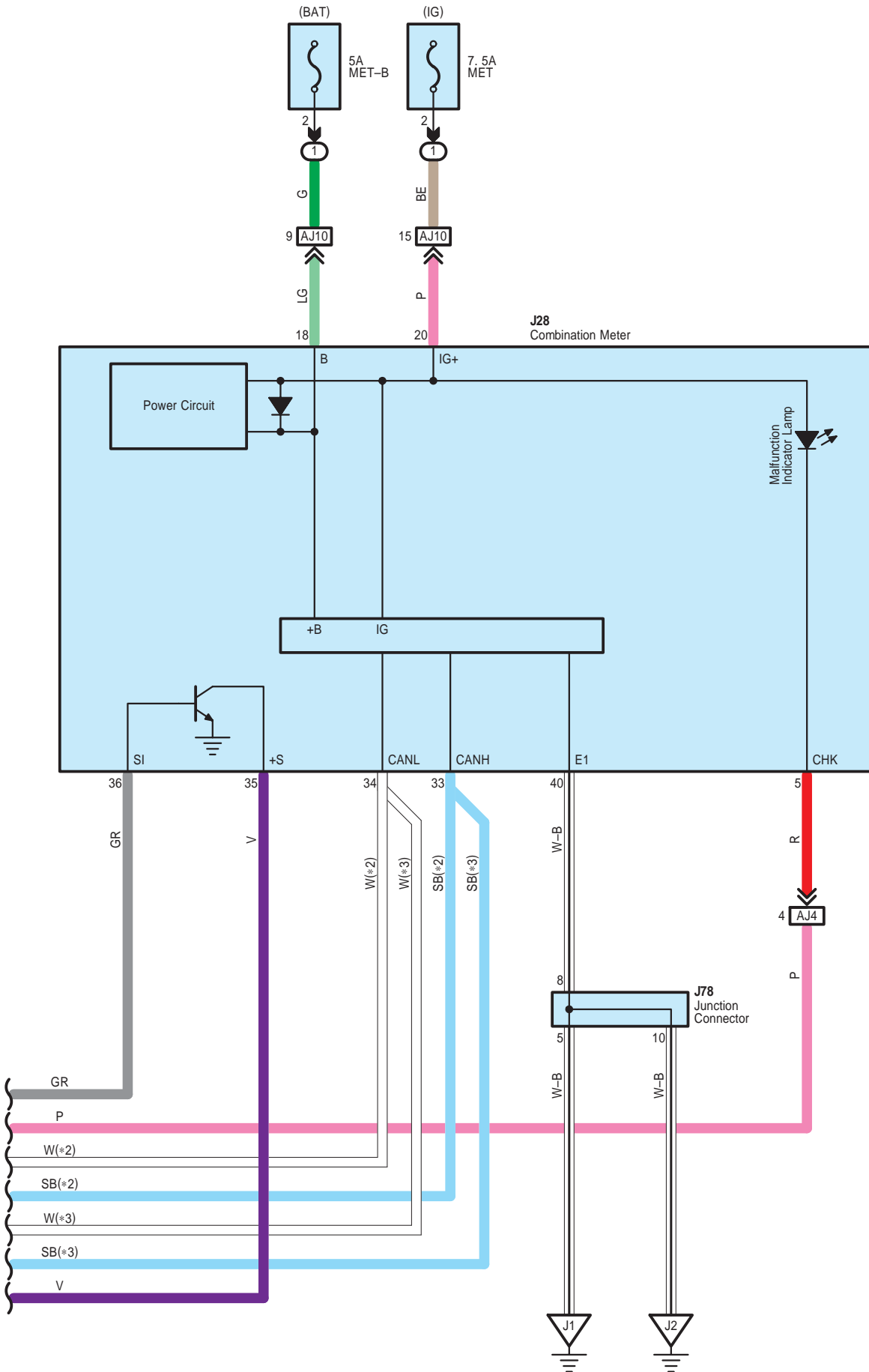

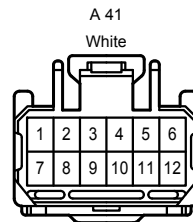
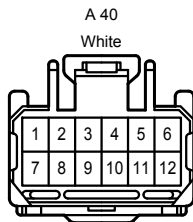
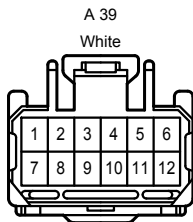
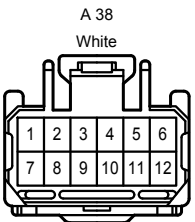
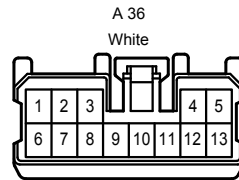
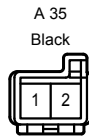
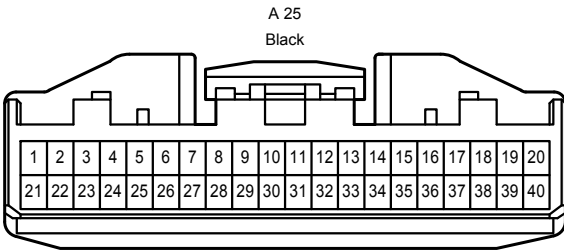
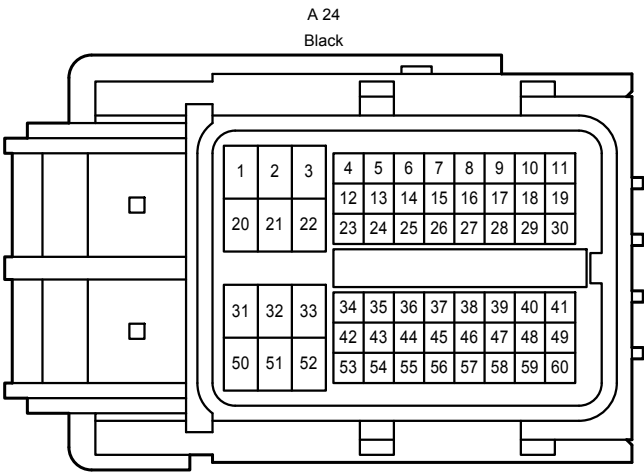
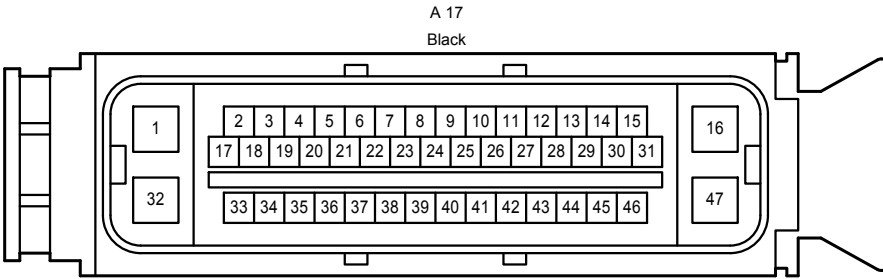
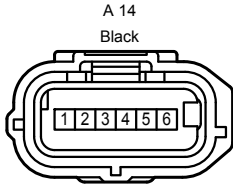
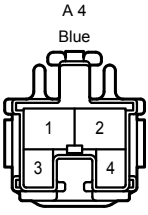

Engine Control <1UR-FE>

A 42
White

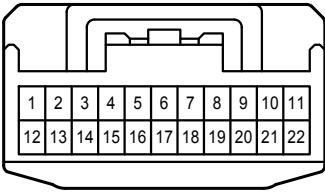

A 43
White

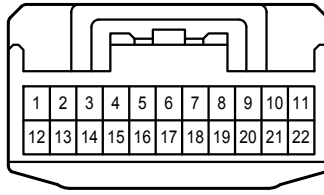

A 44
White

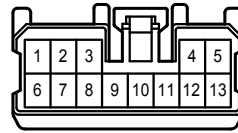

A 45
Blue

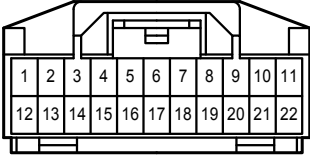

A 46
White

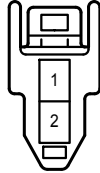

D 3
Black



D 6
Black

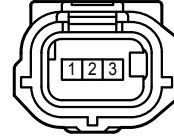

D 7
Black



D 9
Black

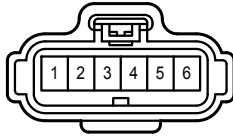

D 10
Black

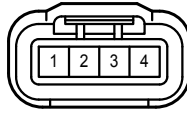

D 12
Black

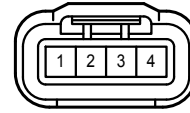

D 14
Black

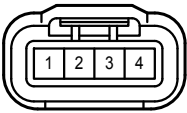

D 16
Black

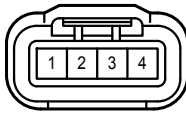

D 19
Black

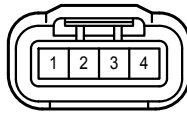

D 21
Black

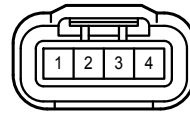

D 23
Black

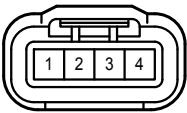

D 25
Black

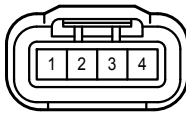

D 28
Dark Gray



D 29
Black

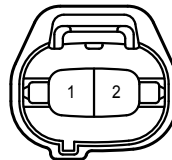

D 31
Dark Gray



D 32
Dark Gray



D 33
Dark Gray



D 34
Dark Gray



D 35
Gray

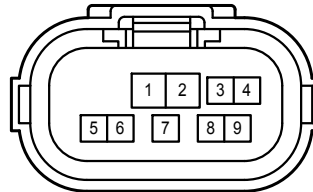

D 37
Black

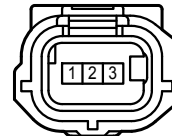

D 39
Black

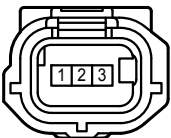

D 40
Black

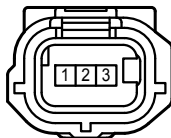

D 41
Black

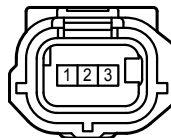

D 44
Black



D 45
Black



D 46
Gray

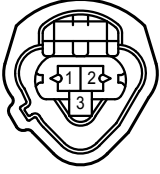

D 48
Black

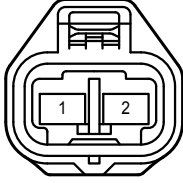

D 50
Black

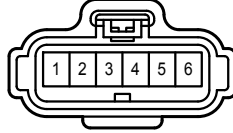

D 52
Gray

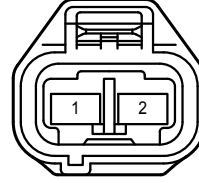

D 54
Gray

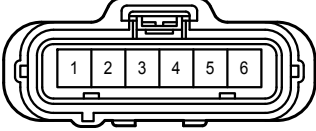

D 56
Gray



D 57
Gray



D 58
Black

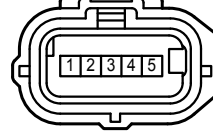

D 59
Black



D 62
Black

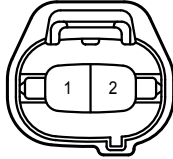

D 68
Dark Gray

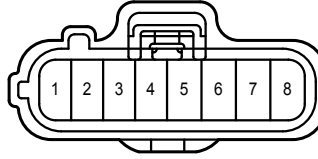

D 71
White

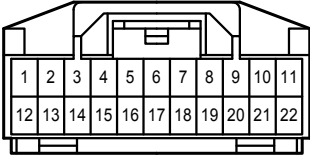

D 72
White

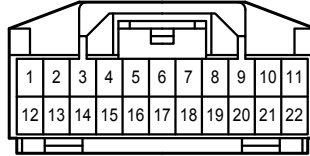

D 73
Blue

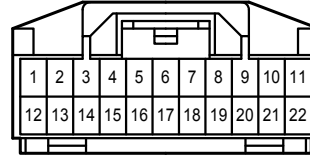

D 74
Black

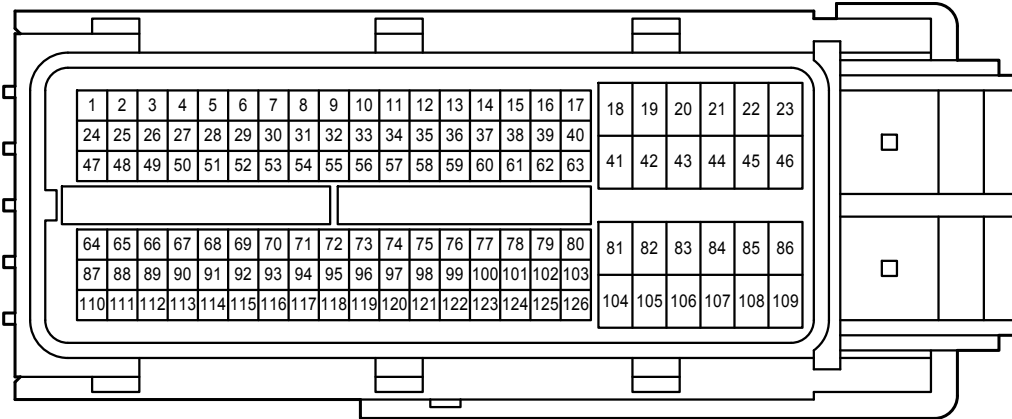

D 75
Black



D 76
Black



D 80
Black

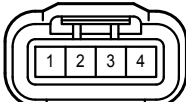

D 85



E 9
Black



F 1
Black



F 2

Black

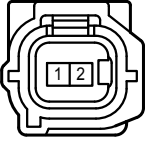

F 3

Black



F 4

Black



H 1

Black



H 2

Black

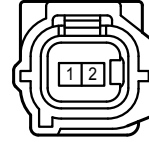

H 3

Black

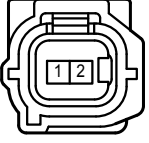

H 4

Black

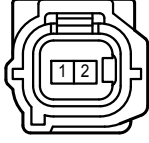

J 9

White

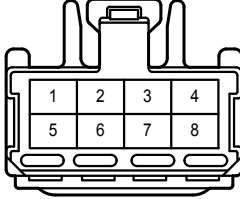

J 17

White

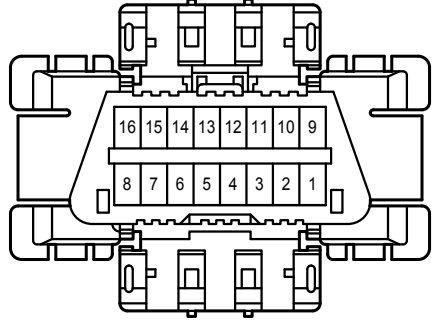

J 19

White

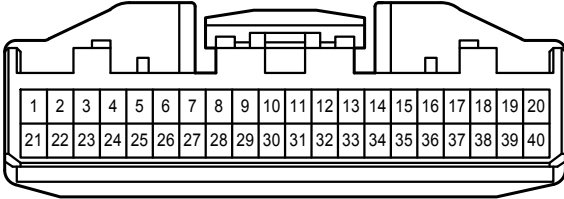

J 26

White

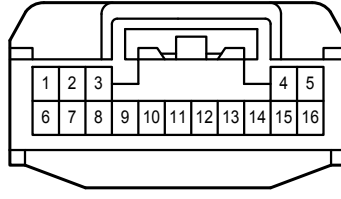

J 28

White

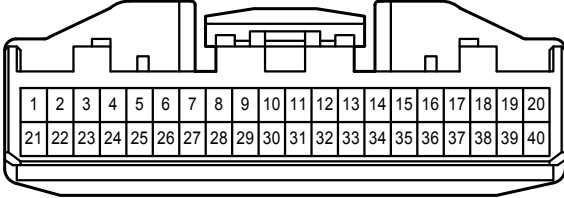

J 71

Black

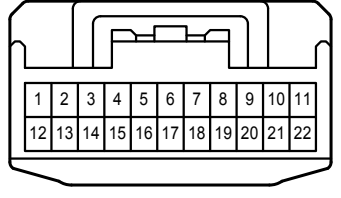

J 74

Black

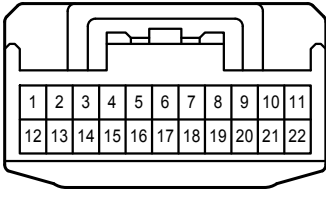

J 78

White

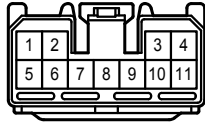

J 84

White

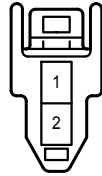

J 86

White

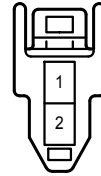

J 94

White

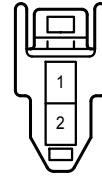

J 113

Gray

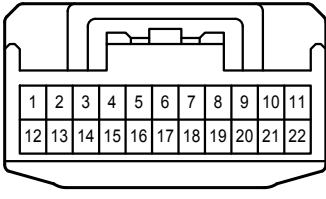

J 117

Black

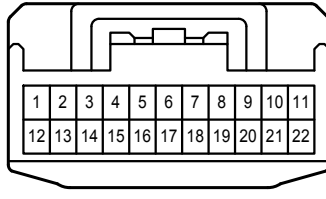

J 118

Gray

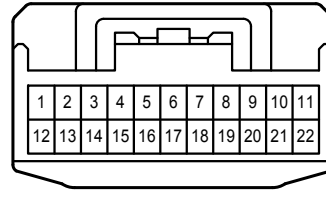

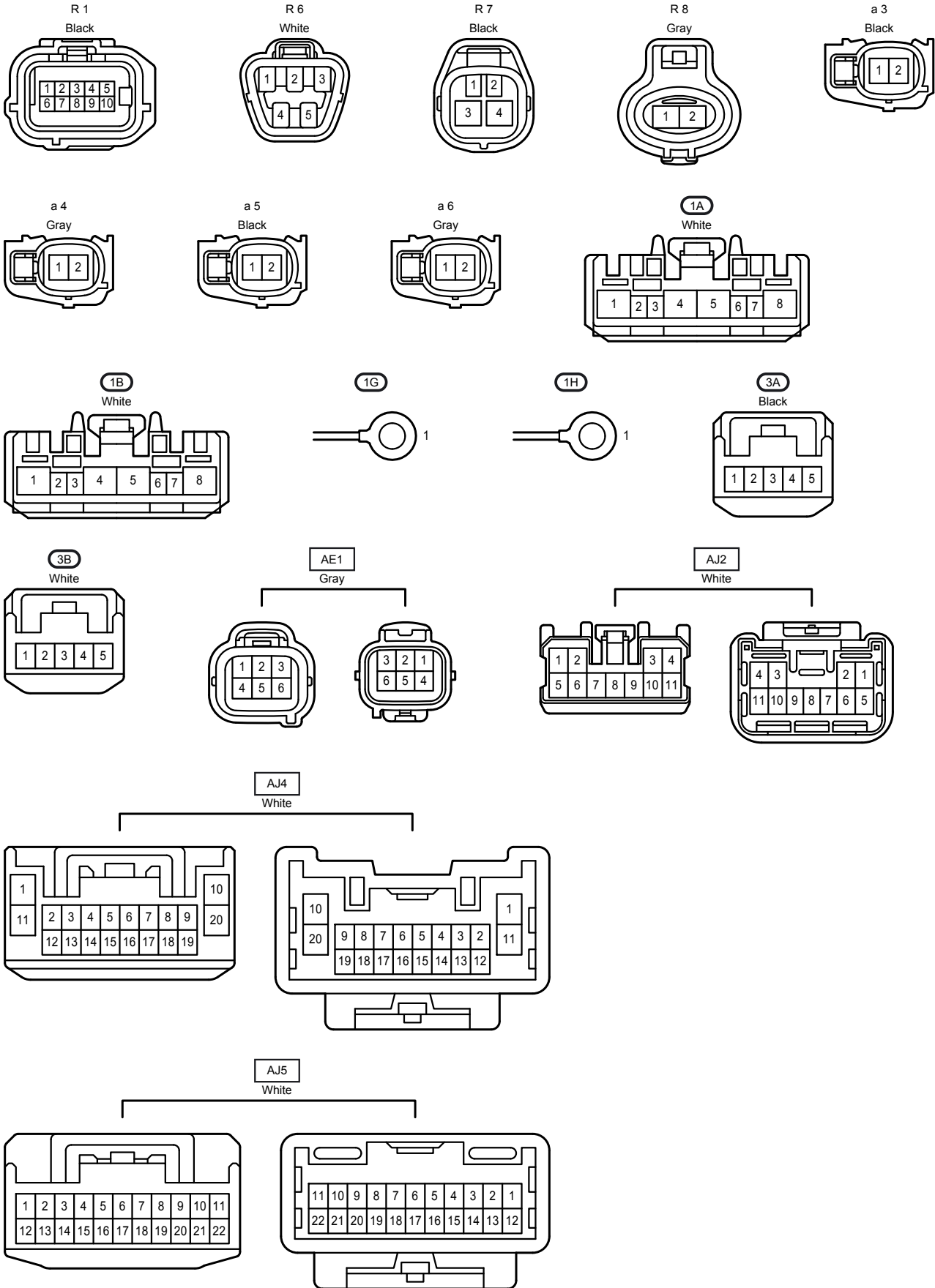

AJ9
Gray

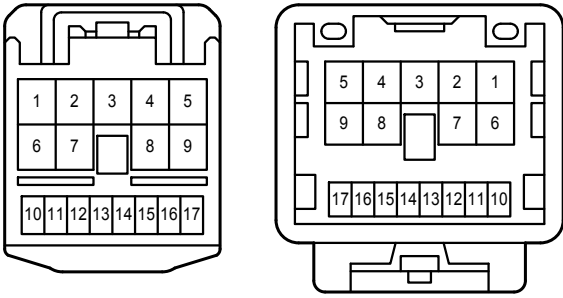

AJ10
Gray

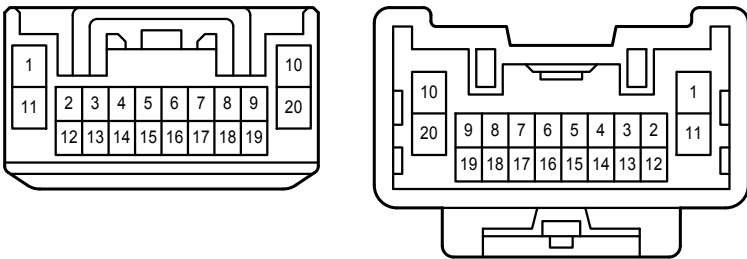

AJ11
Gray

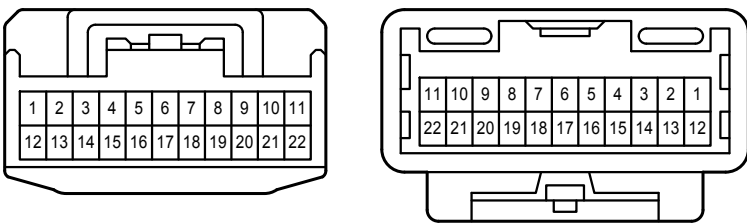

DA1
White

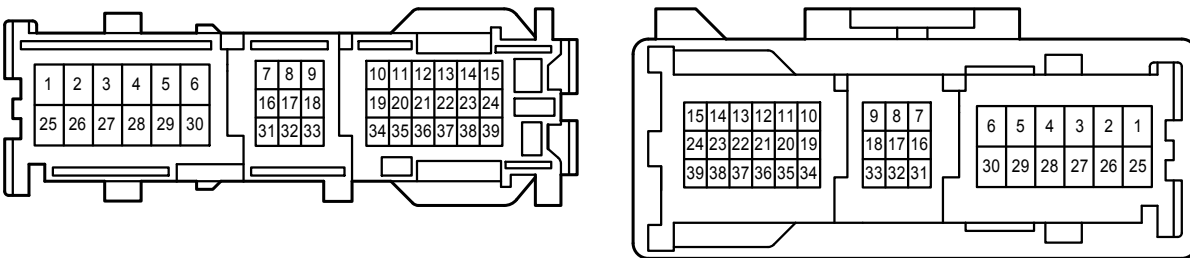

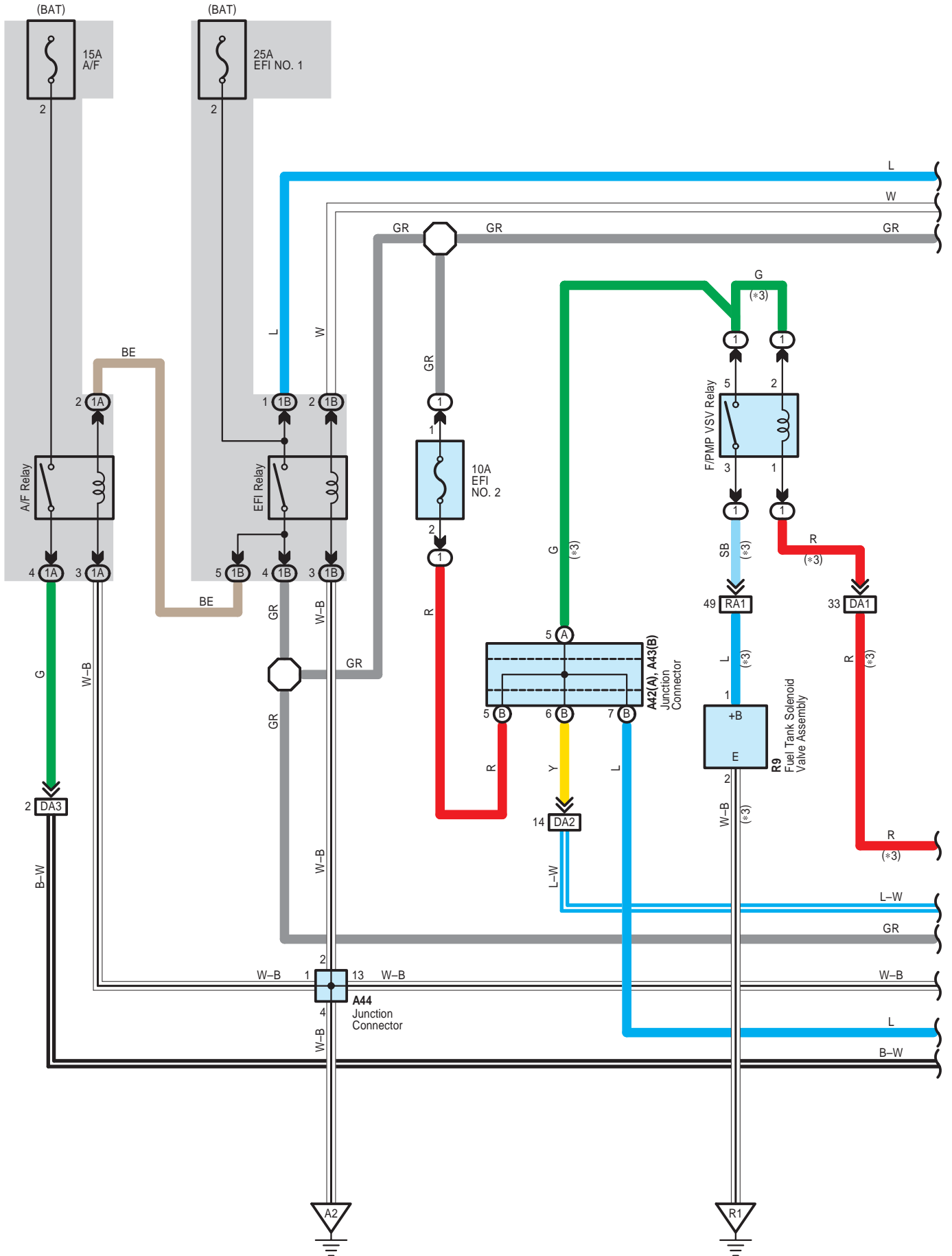

Engine Control <3UR-FE, 3UR-FBE>

* 2 : 3UR-FE
 * 3 : 3UR-FBE

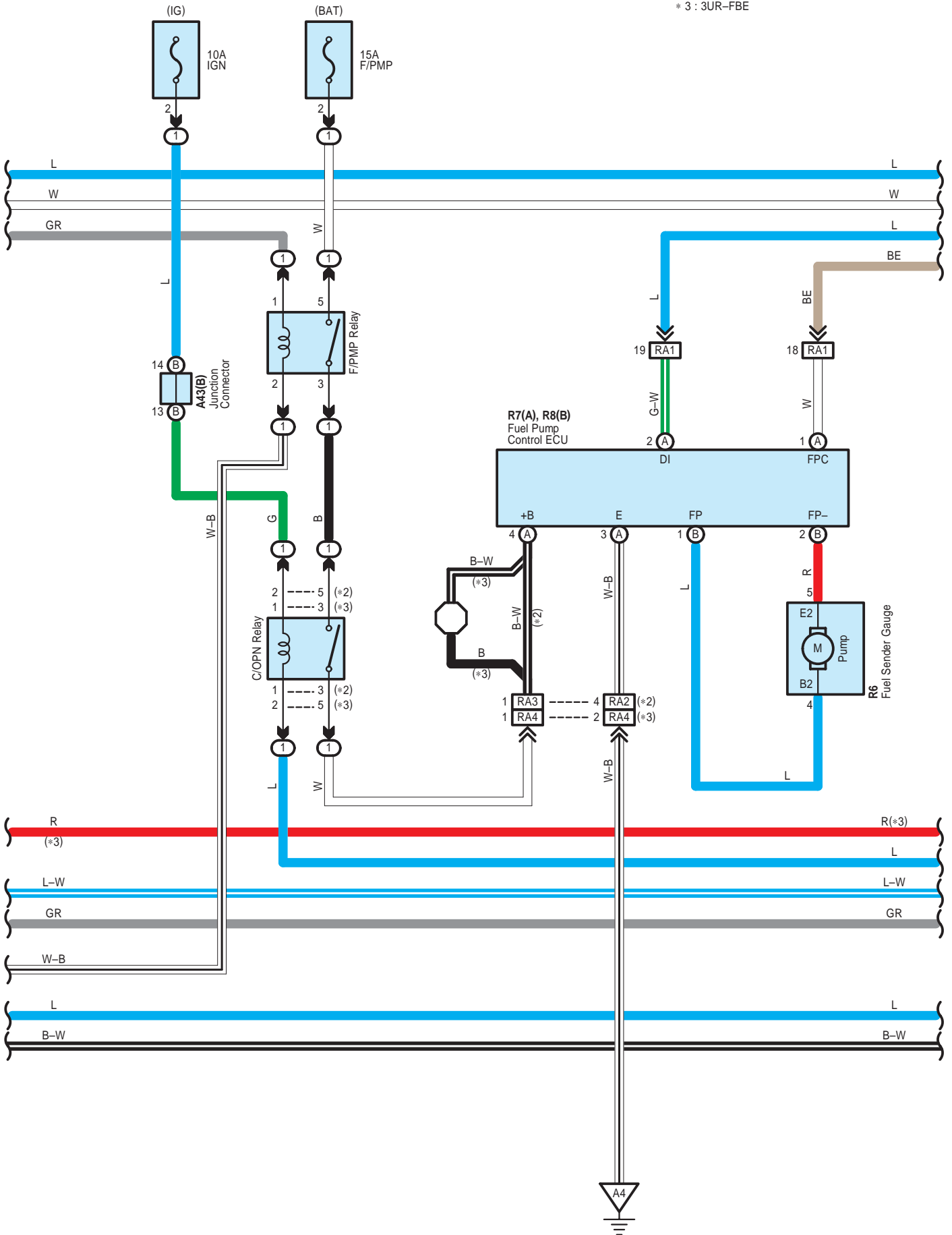

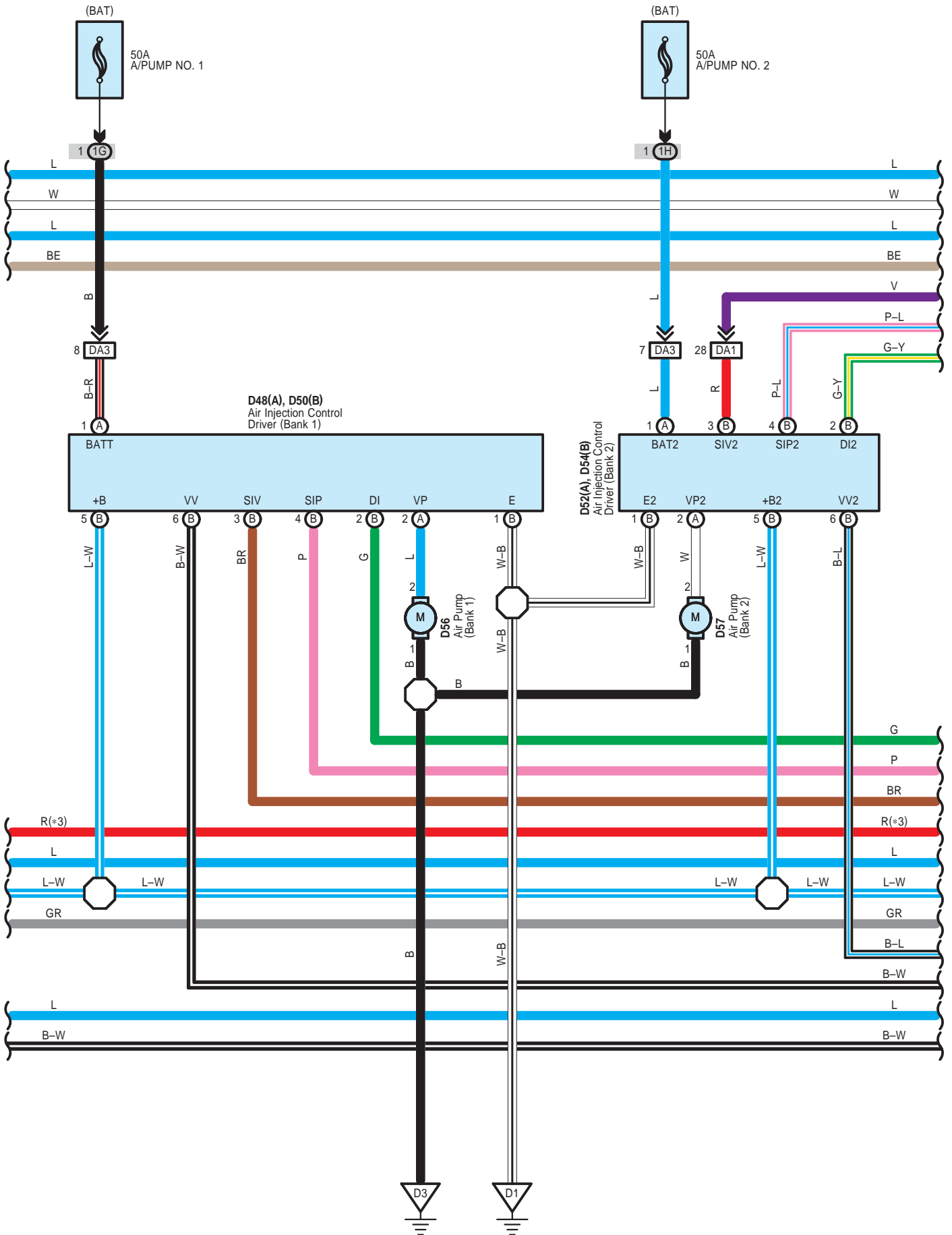

* 3 : 3UR-FBE

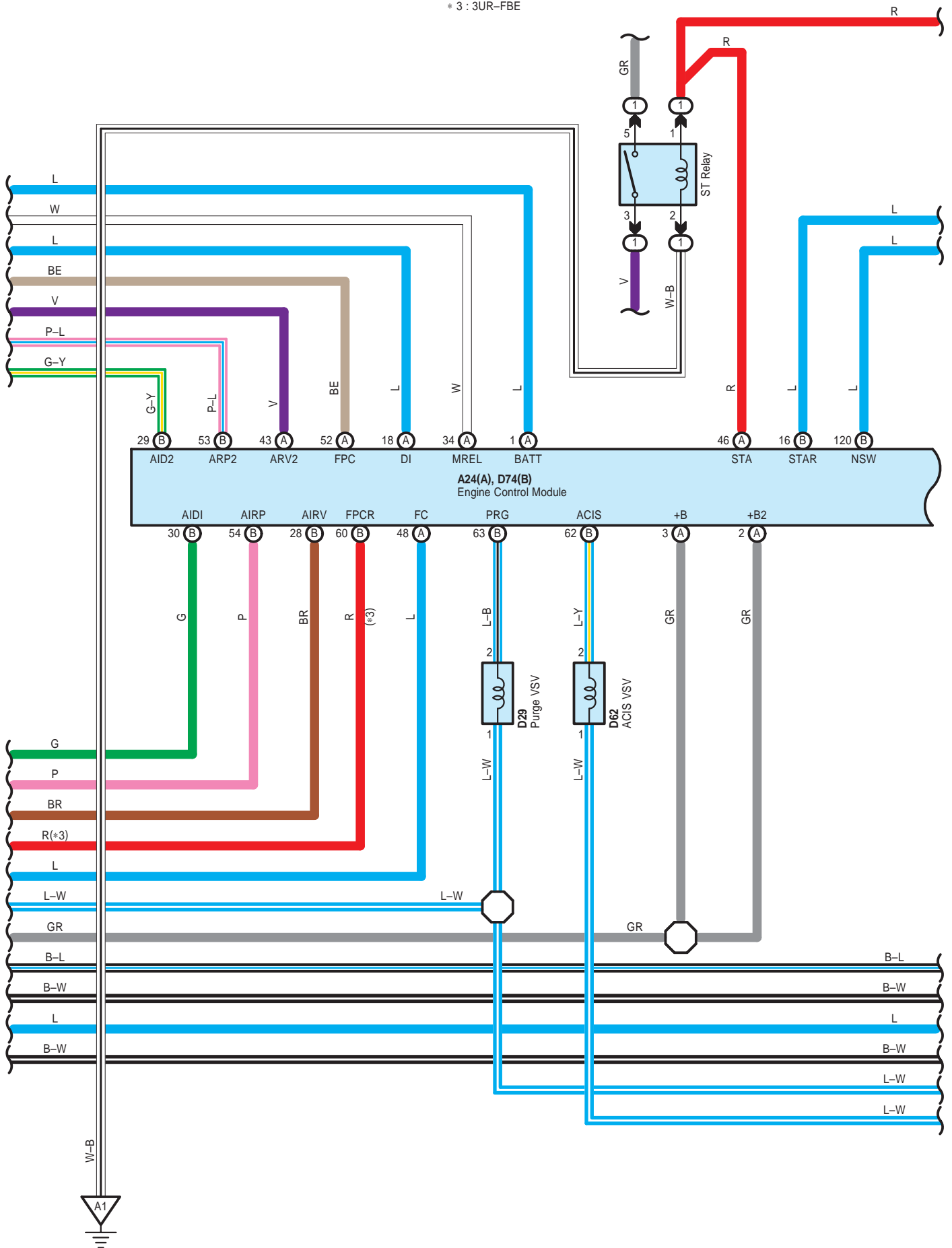

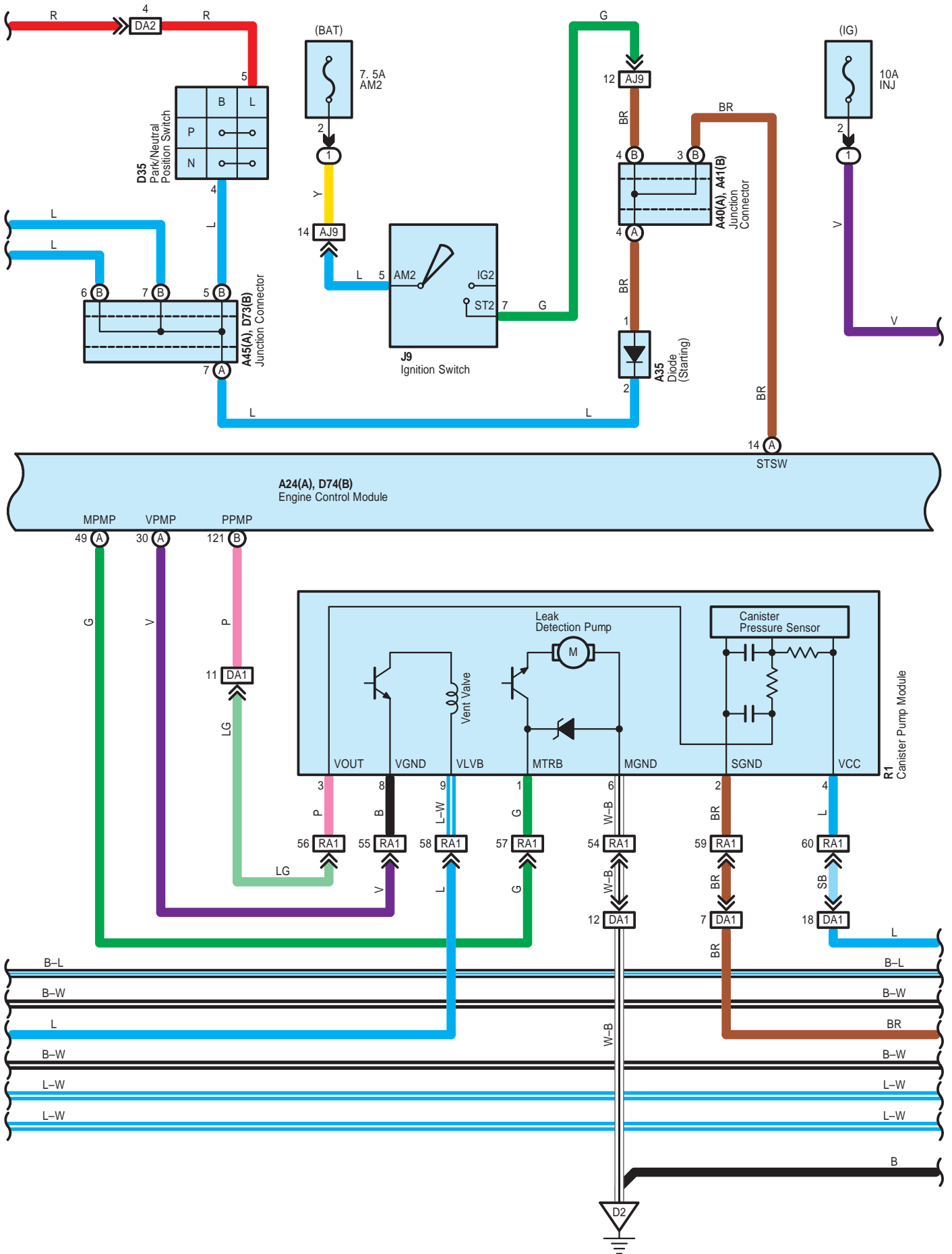

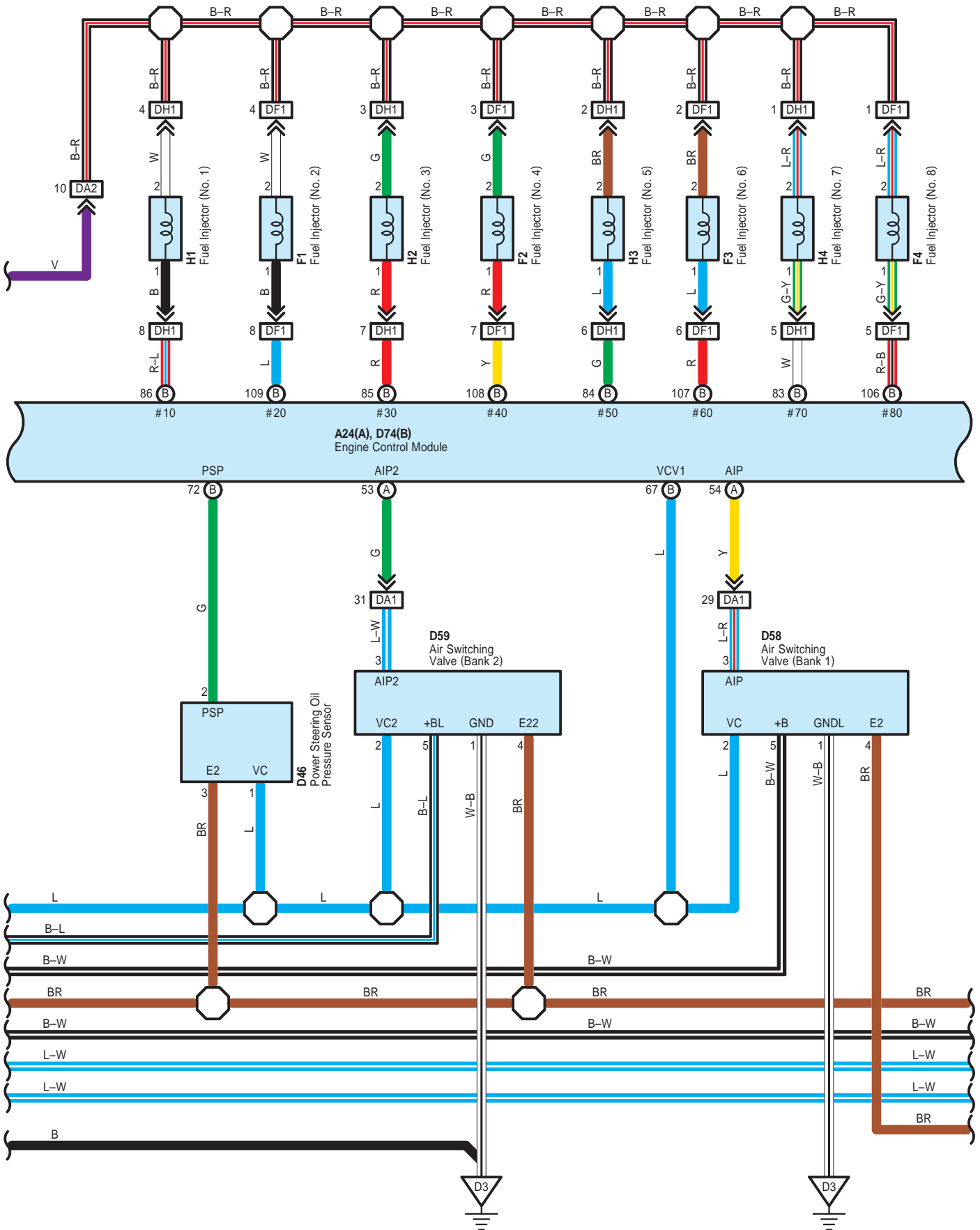

Engine Control <3UR-FE, 3UR-FBE>

* 1 : Shielded

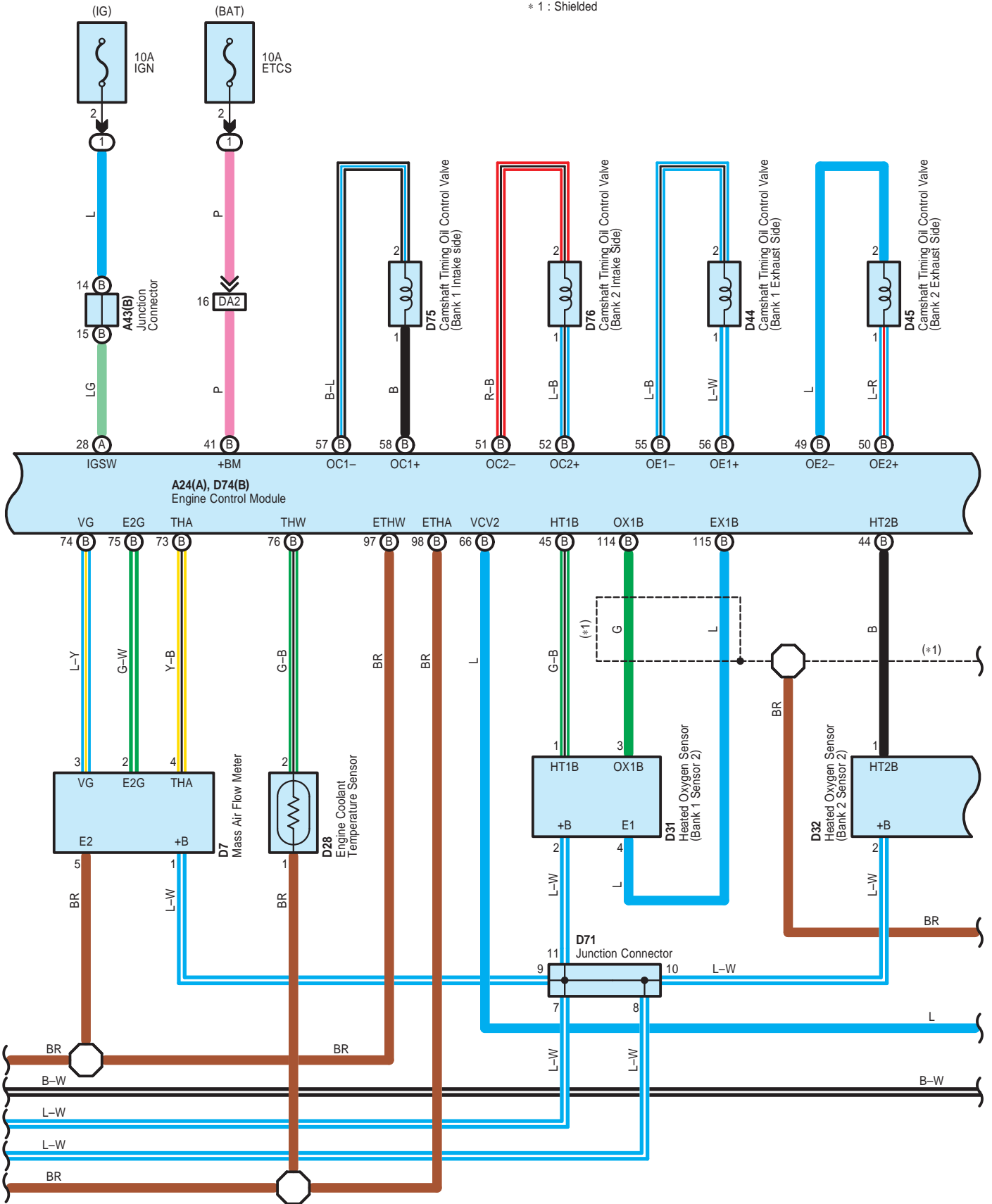

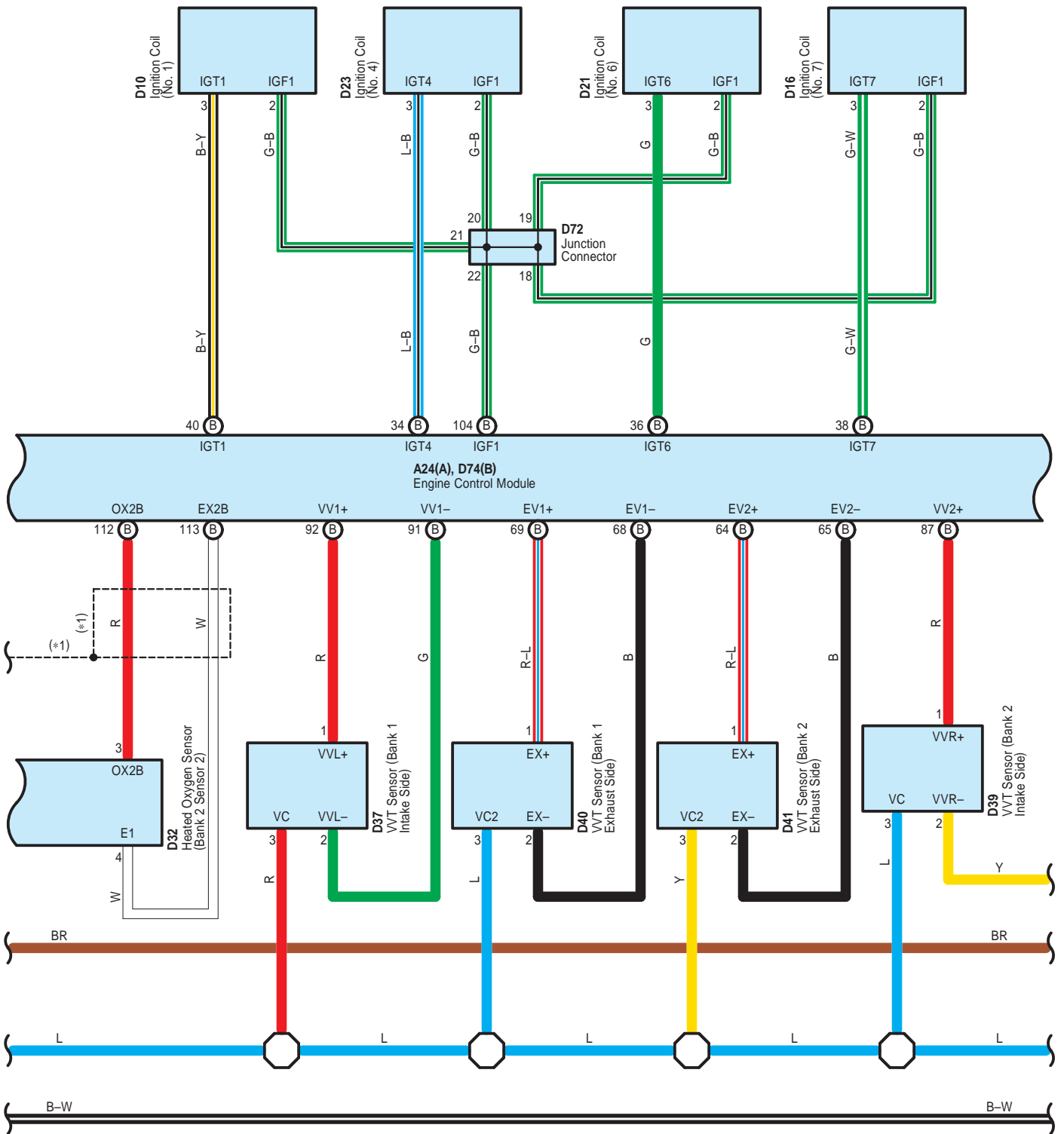

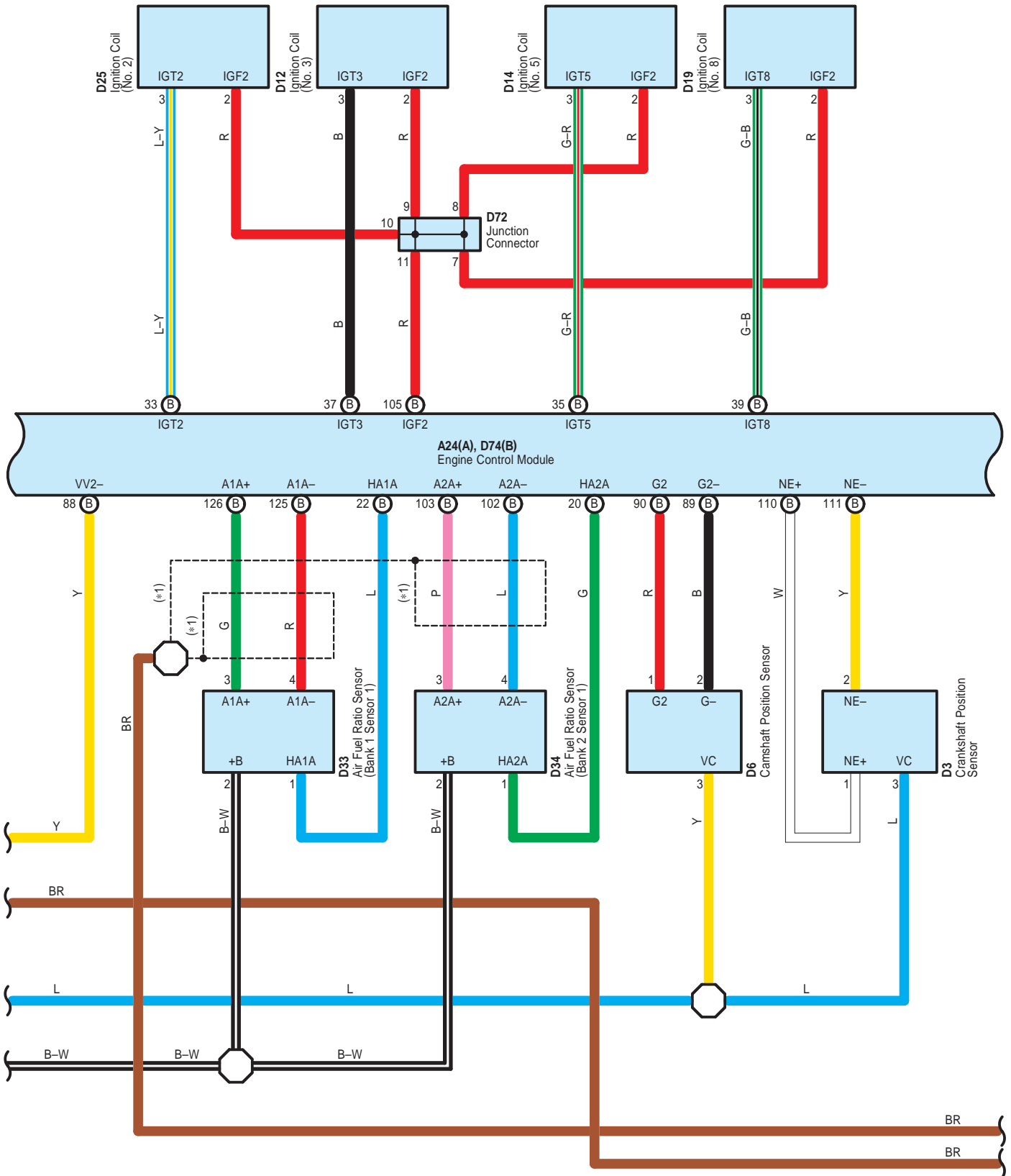

* 1 : Shielded

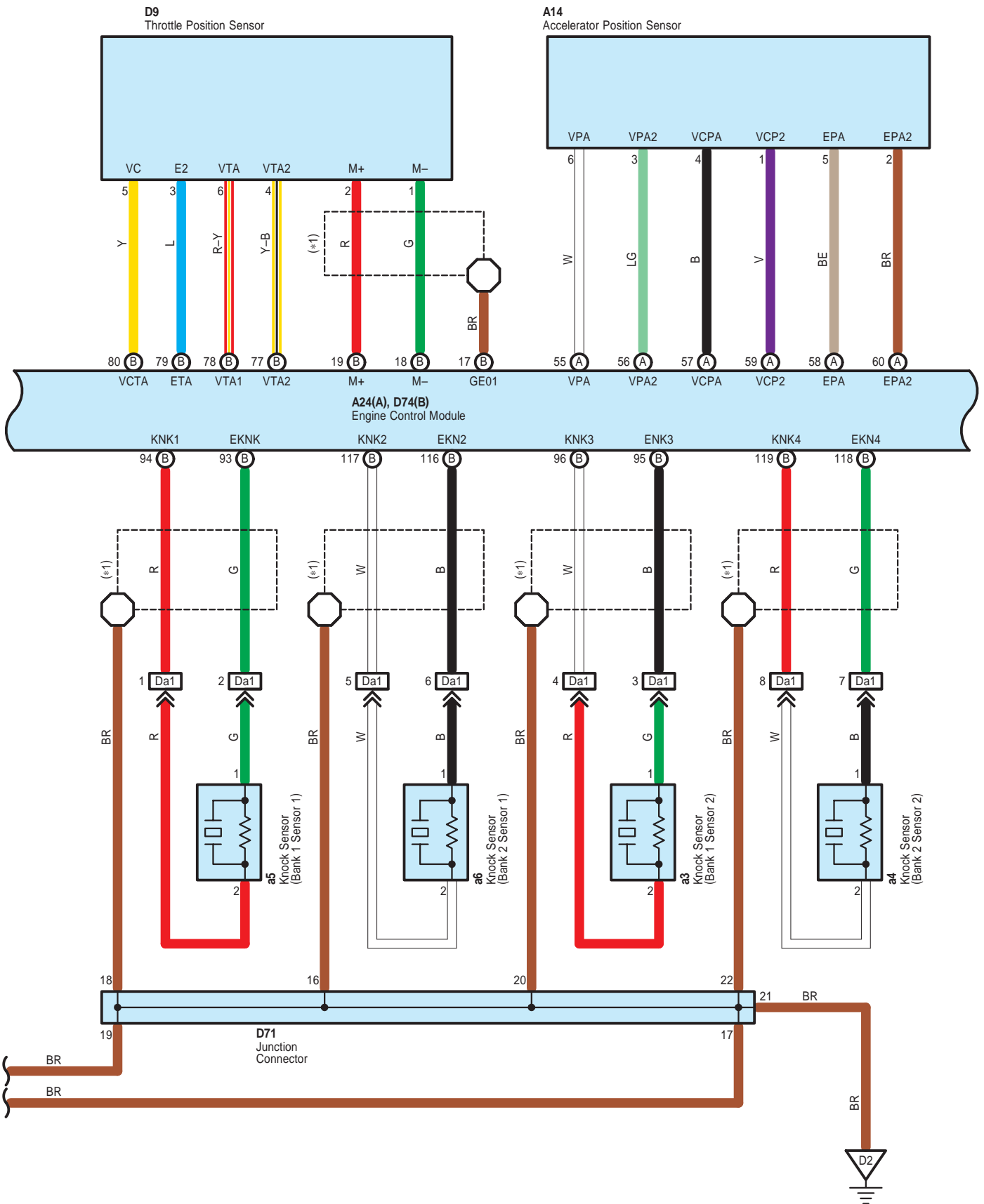

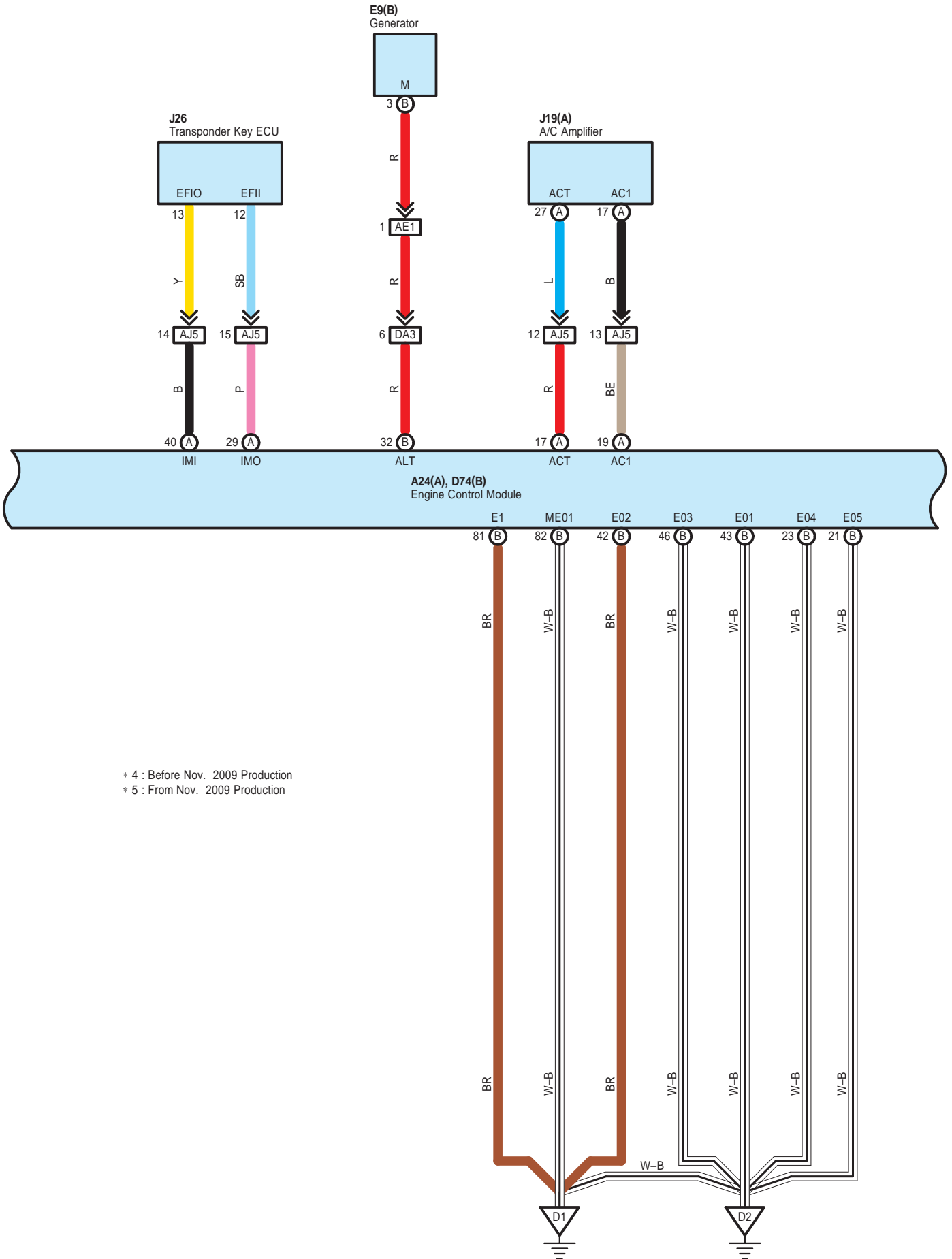

* 4 : Before Nov. 2009 Production
 * 5 : From Nov. 2009 Production

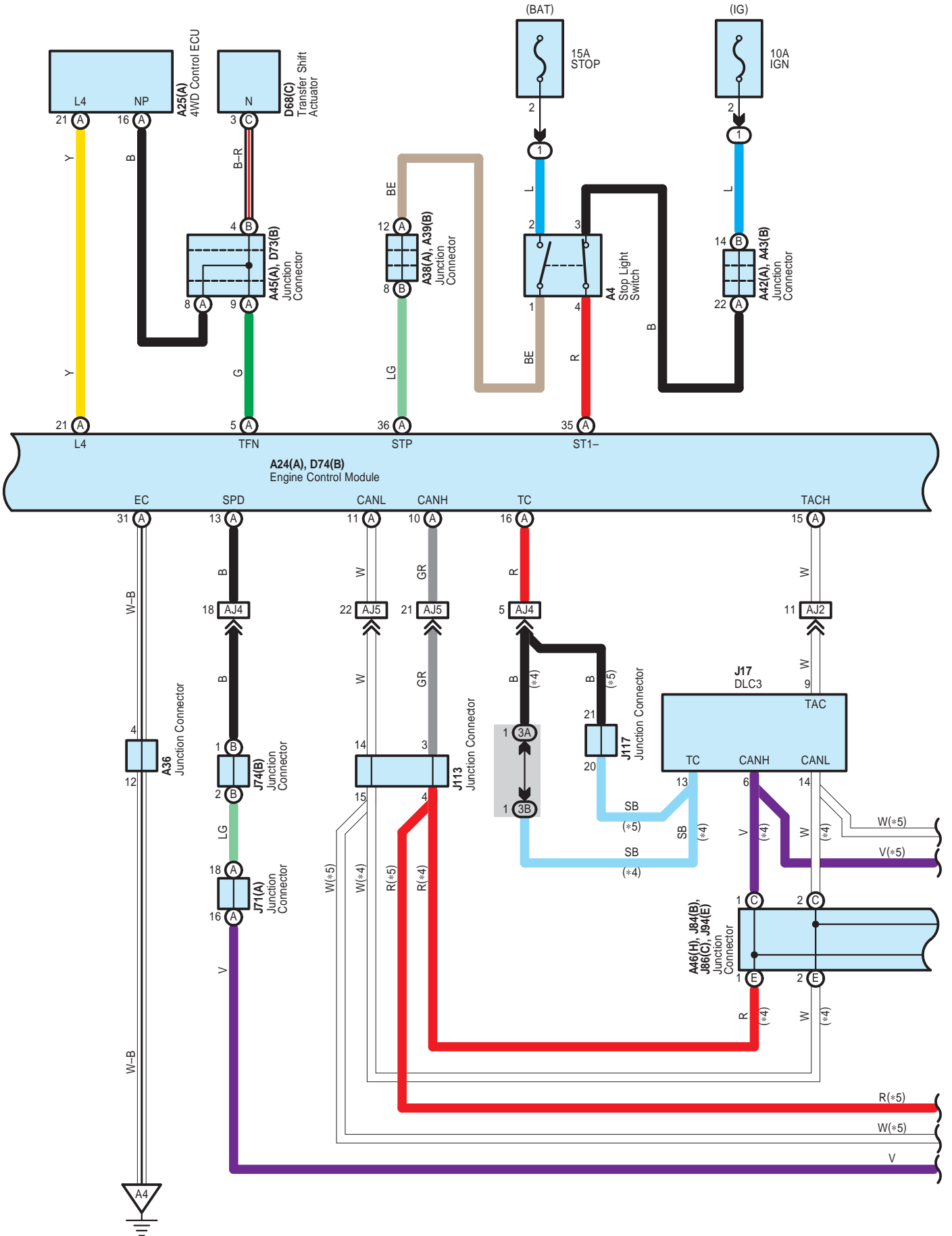

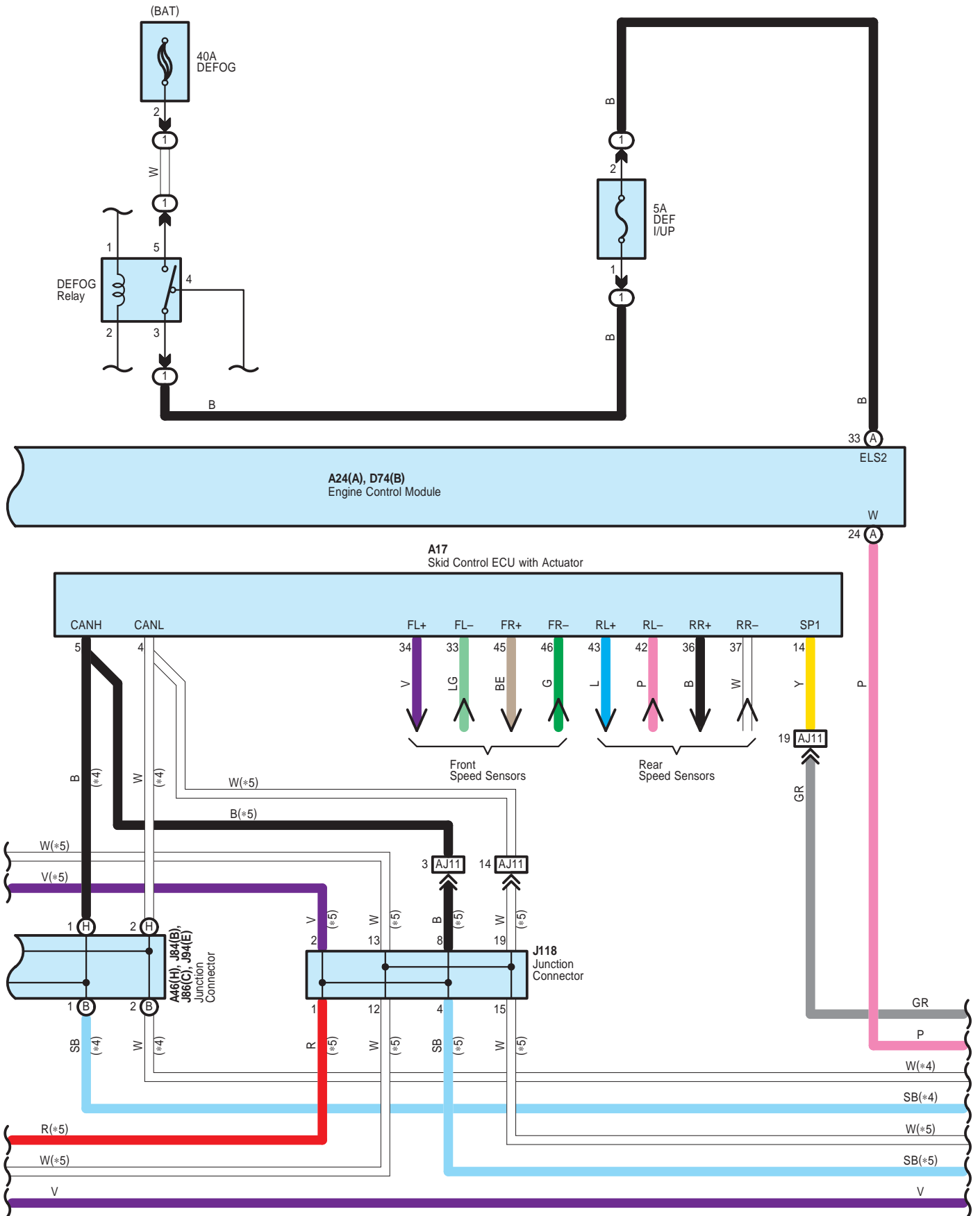

Engine Control <3UR-FE, 3UR-FBE>

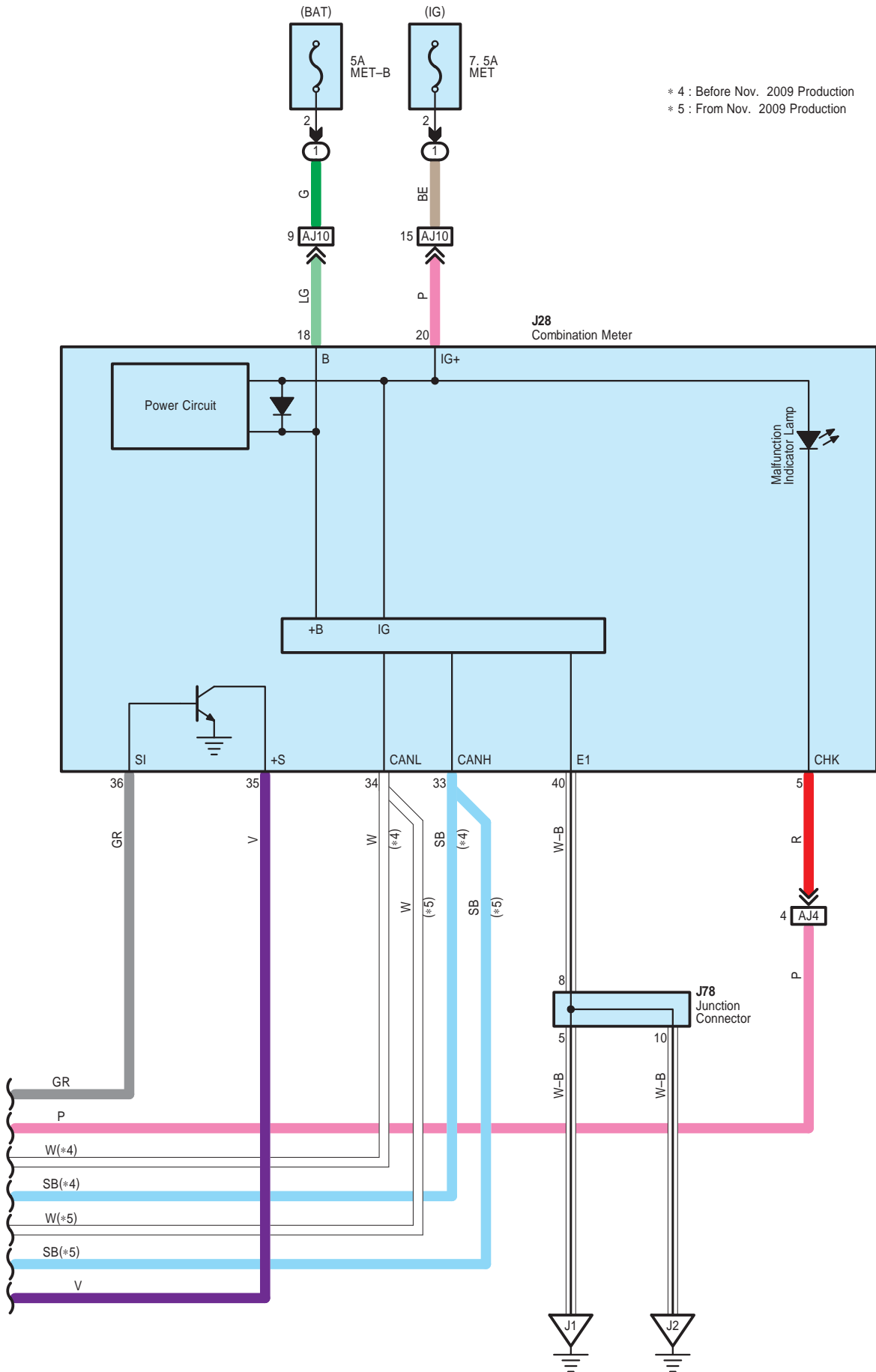

* 4 : Before Nov. 2009 Production
 * 5 : From Nov. 2009 Production

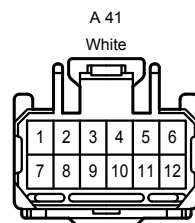
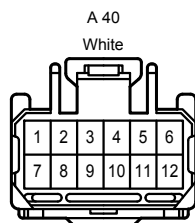
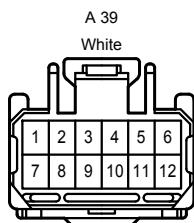
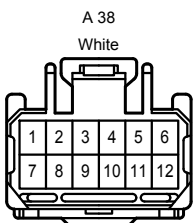
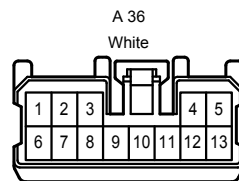
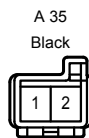
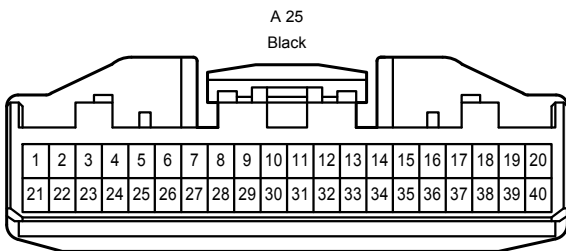
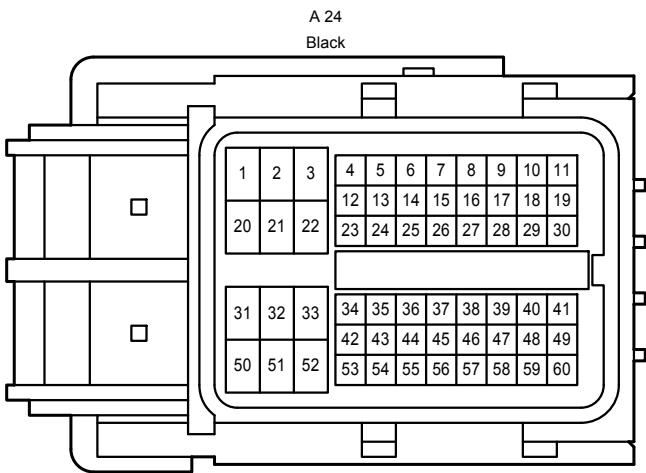
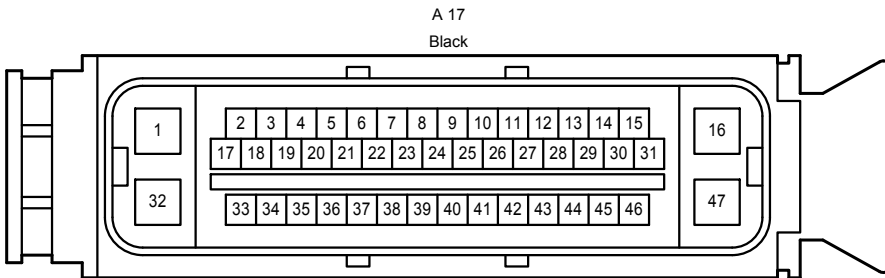
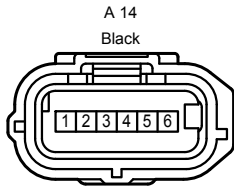
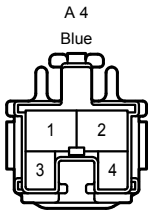

A 42
White

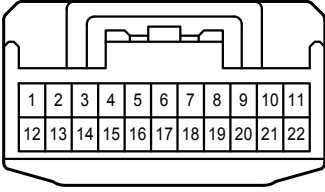

A 43
White

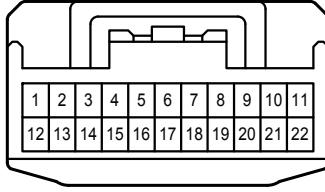

A 44
White

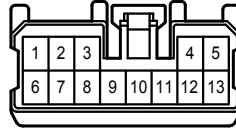

A 45
Blue

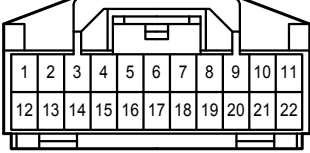

A 46
White

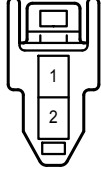

D 3
Black



D 6
Black

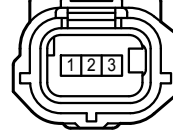

D 7
Black



D 9
Black

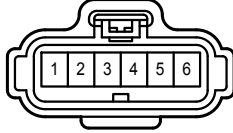

D 10
Black

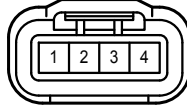

D 12
Black

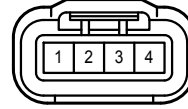

D 14
Black

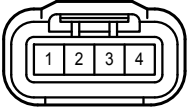

D 16
Black

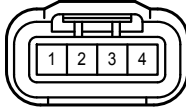

D 19
Black

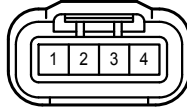

D 21
Black

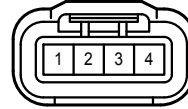

D 23
Black

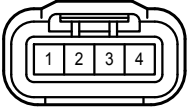

D 25
Black

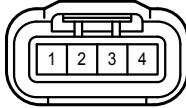

D 28
Dark Gray



D 29
Black

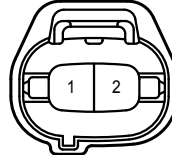

D 31
Dark Gray



D 32
Dark Gray



D 33
Dark Gray



D 34
Dark Gray



D 35
Gray

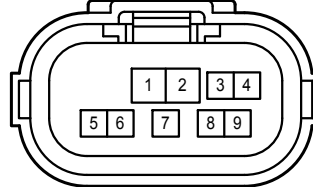

D 37
Black

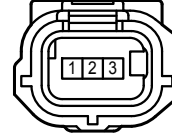

D 39
Black



D 40
Black



D 41
Black

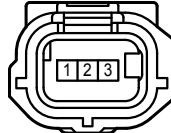

D 44
Black



D 45
Black



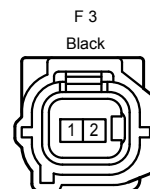
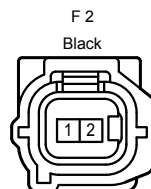
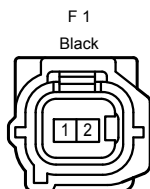
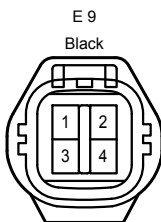
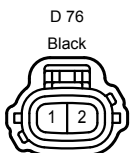
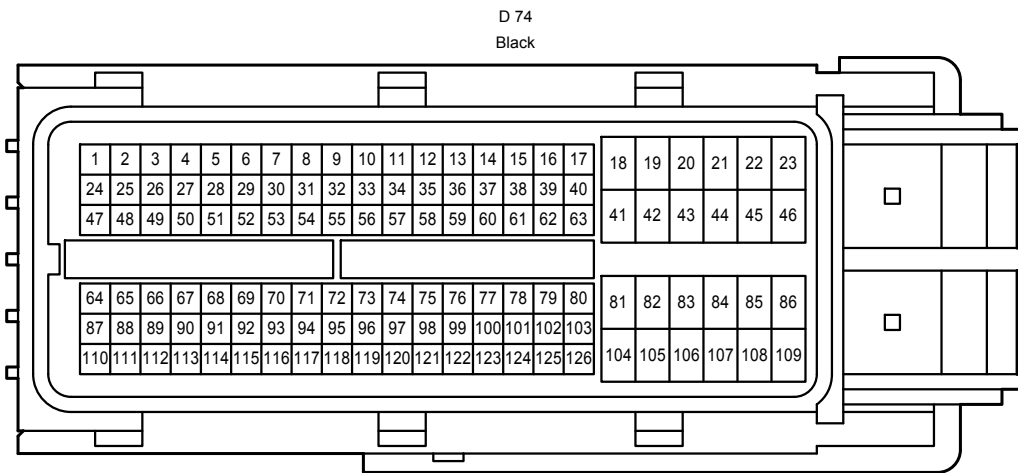
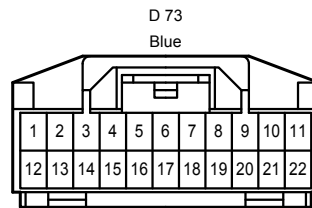
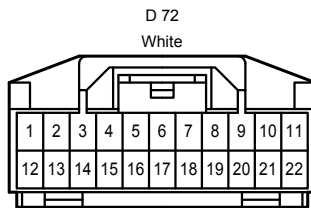
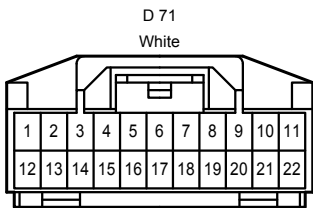
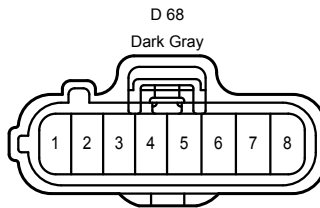
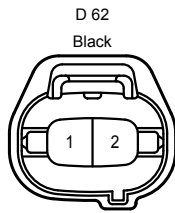
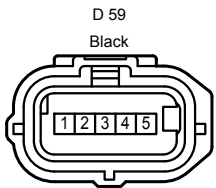
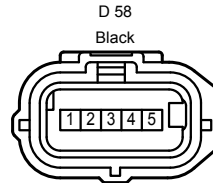
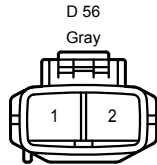
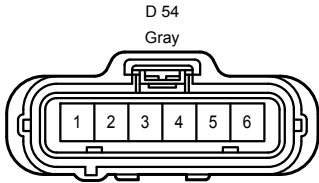
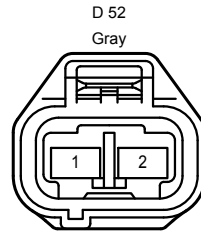
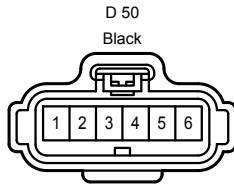
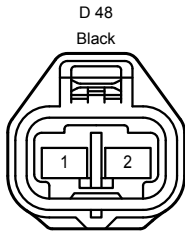
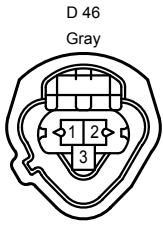

Engine Control <3UR-FE, 3UR-FBE>

F 4

Black

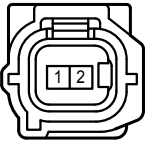

H 1

Black

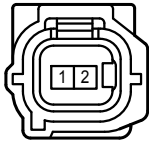

H 2

Black

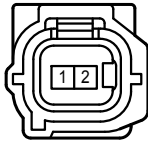

H 3

Black

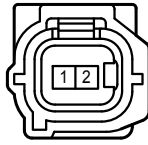

H 4

Black

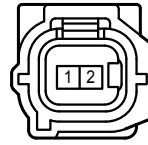

J 9

White

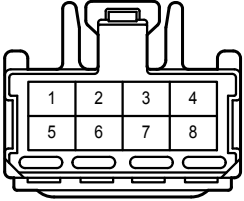

J 17

White

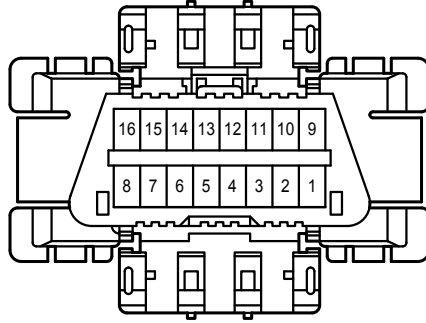

J 19

White

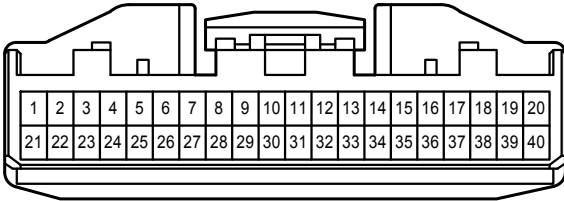

J 26

White

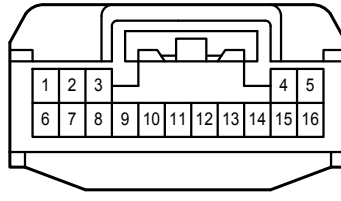

J 28

White

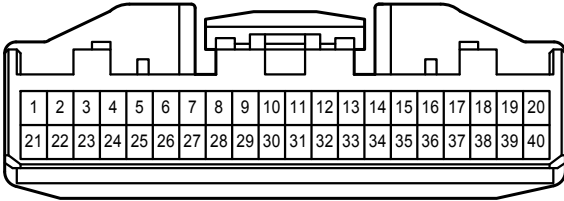

J 71

Black

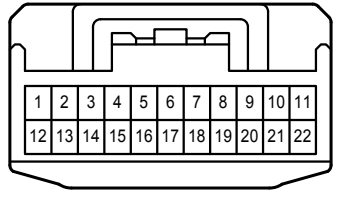

J 74

Black

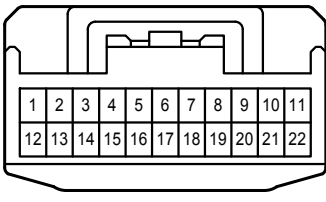

J 78

White

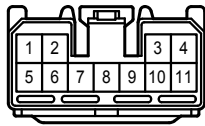

J 84

White

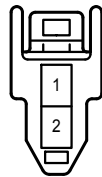

J 86

White

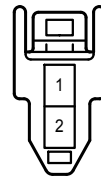

J 94

White

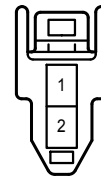

J 113

Gray

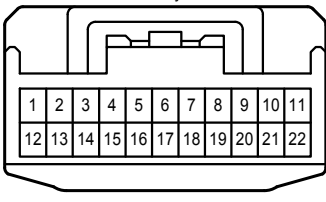

J 117

Black

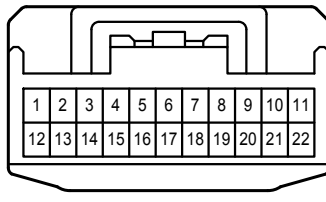

J 118

Gray

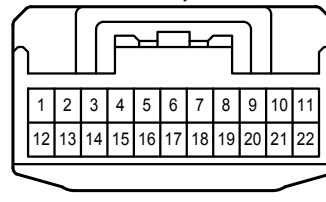

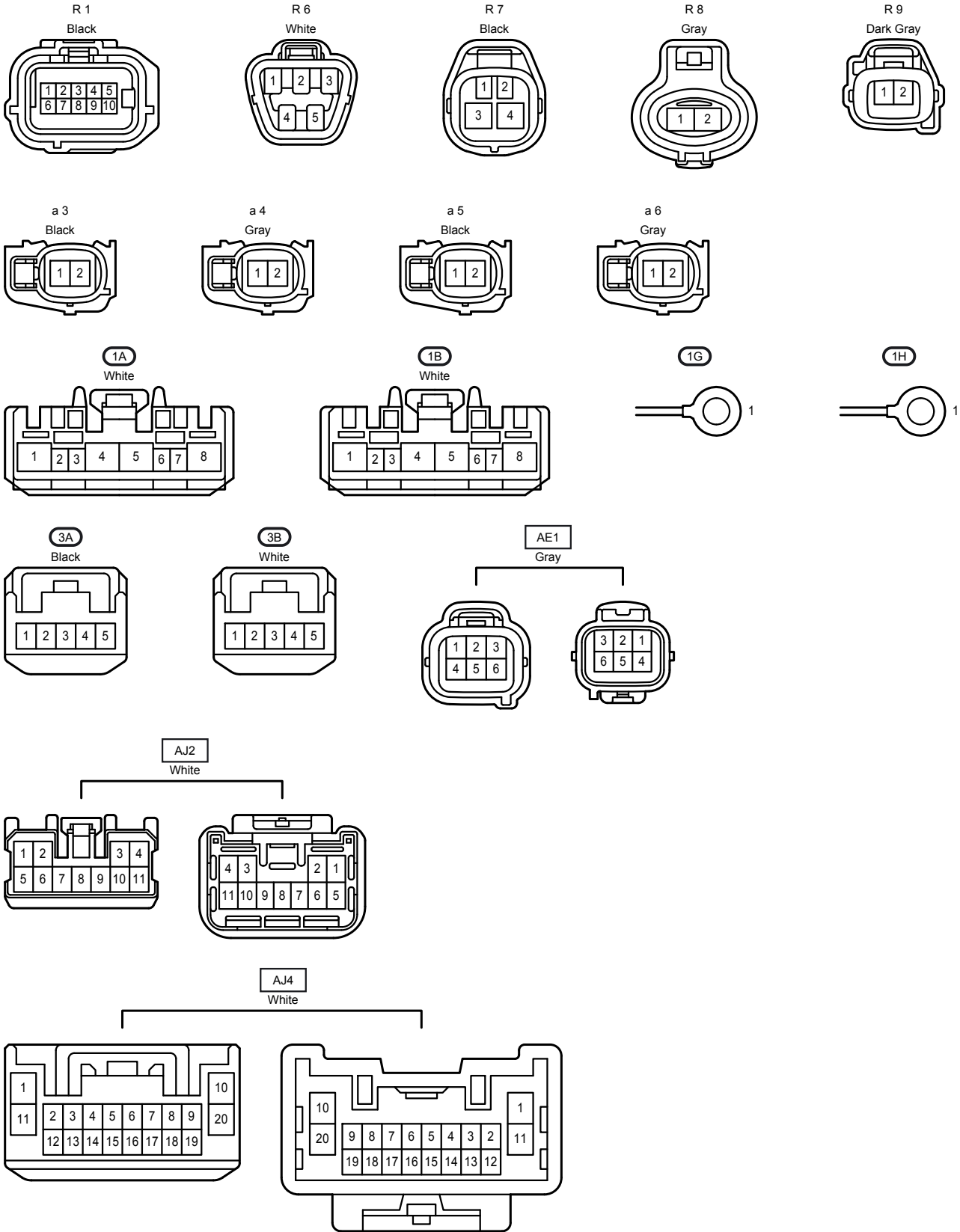

AJ5
White

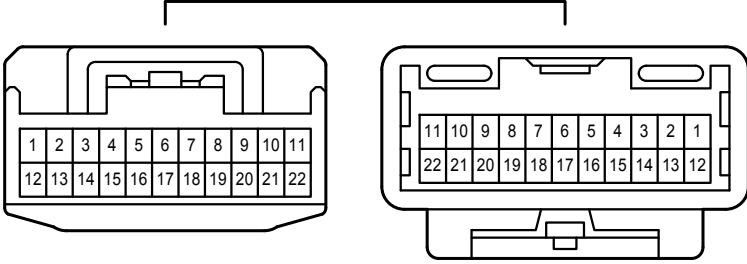

AJ9
Gray

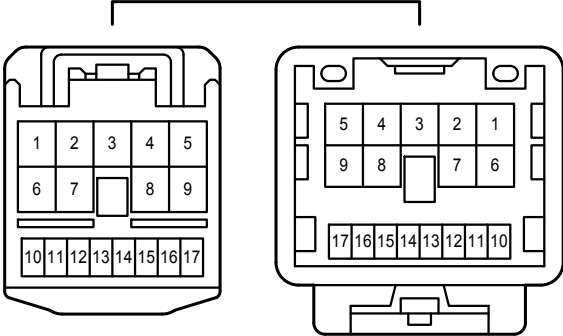

AJ10
Gray

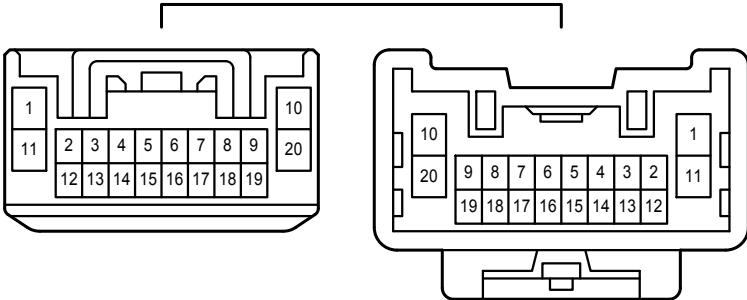

AJ11
Gray

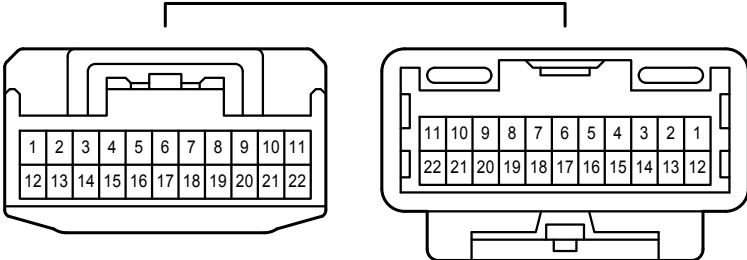

DA1
White

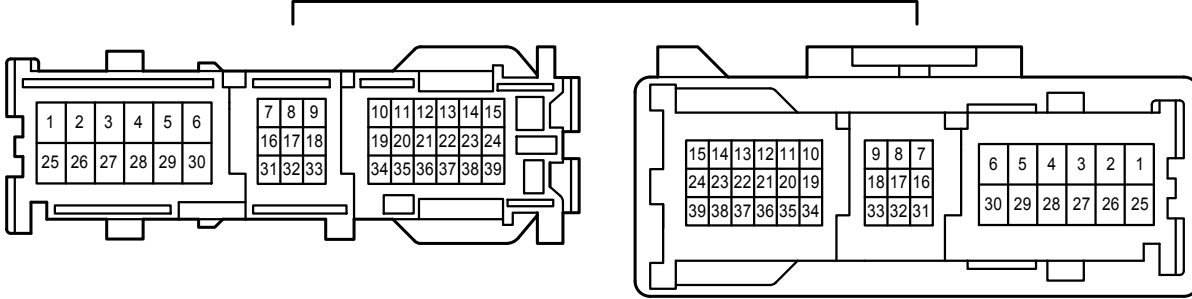

DA2
White

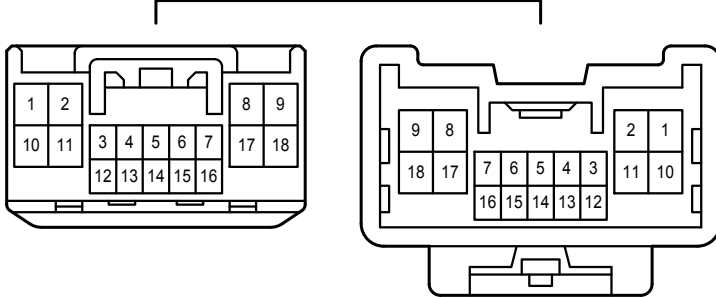

DA3
White

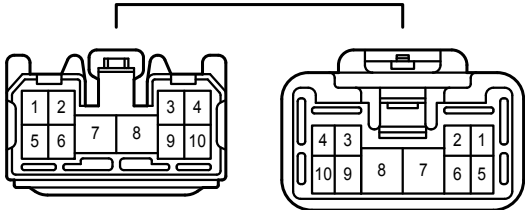

DF1
Gray

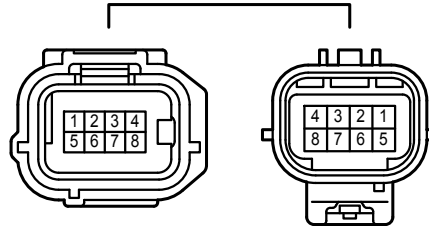

DH1
Gray

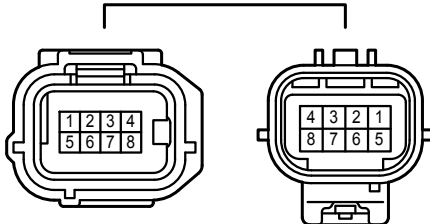

Da1
Gray

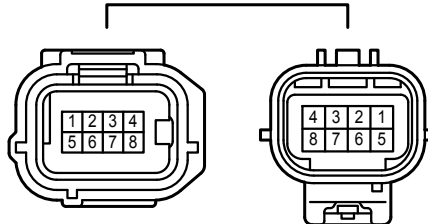

RA1
White

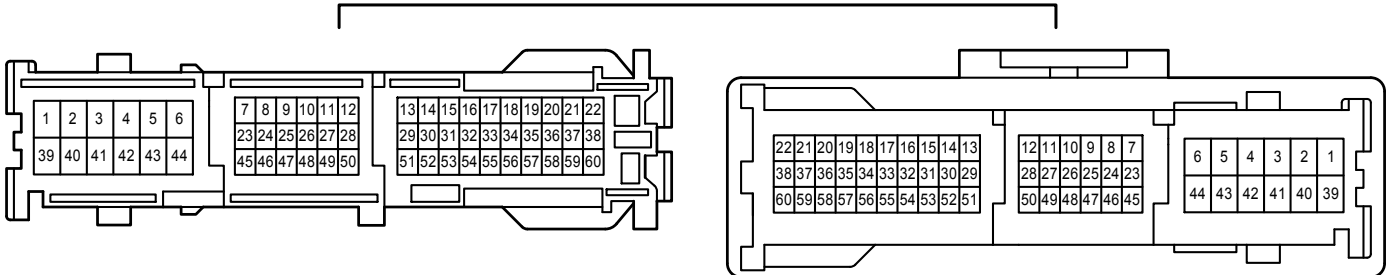

RA2
White

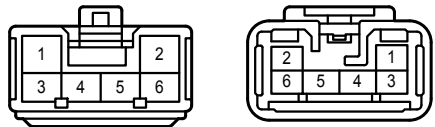

RA3
White

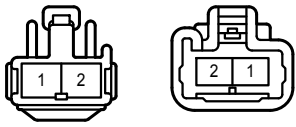

RA4
White

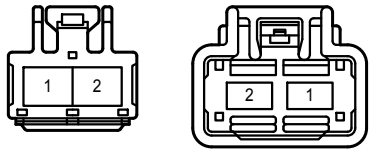

Engine Immobiliser System

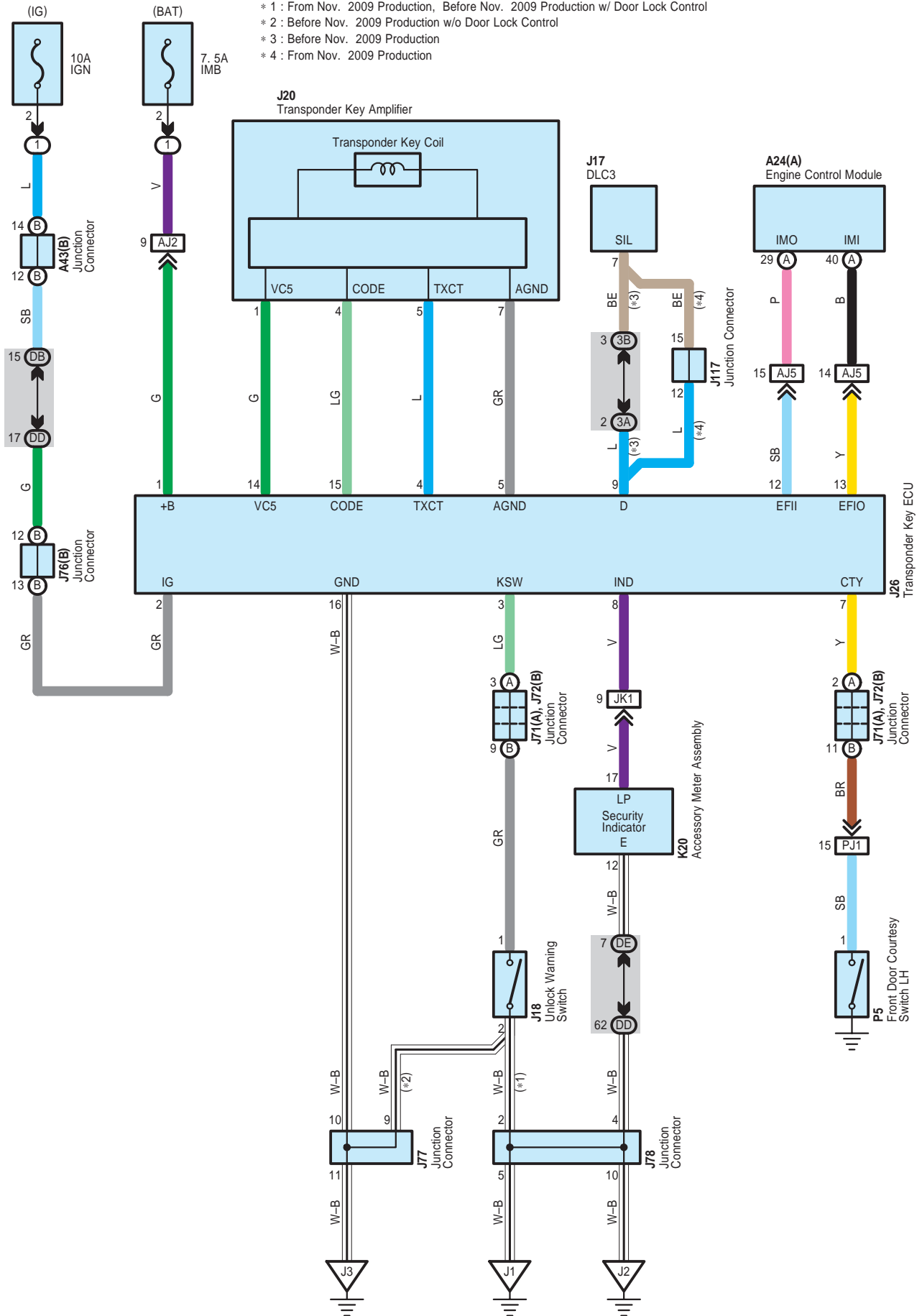

Engine Immobiliser System

A 24
Black

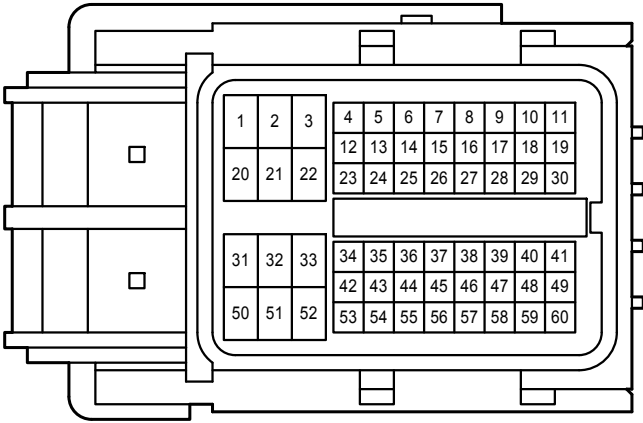

A 43
White

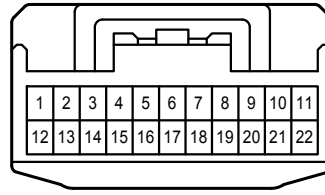

J 17
White

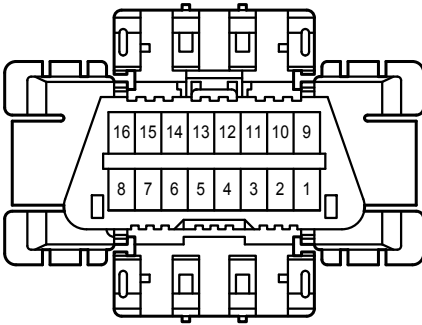

J 18
White



J 20
Black

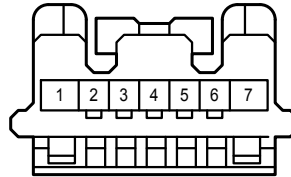

J 26
White

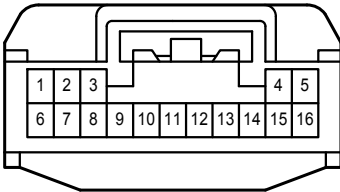

J 71
Black

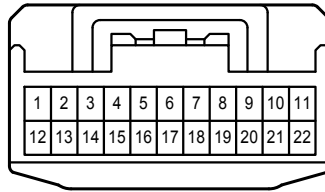

J 72
Black

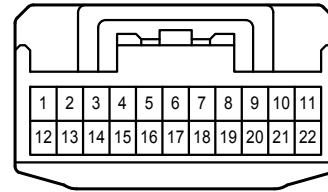

J 76
White

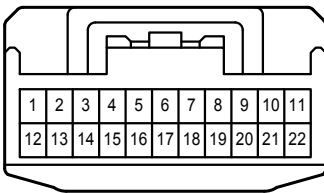

J 77
Gray

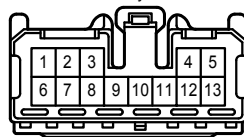

J 78
White



J117
Black

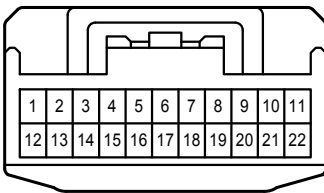

K 20
White

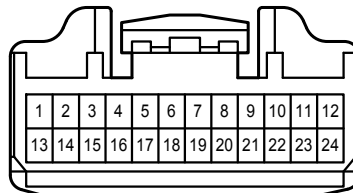

P 5
White



3A
Black

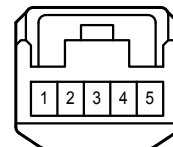

Engine Immobiliser System

3B

White

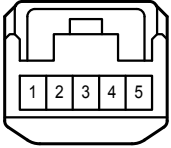

DB

White

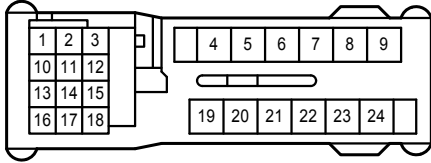

DD

White

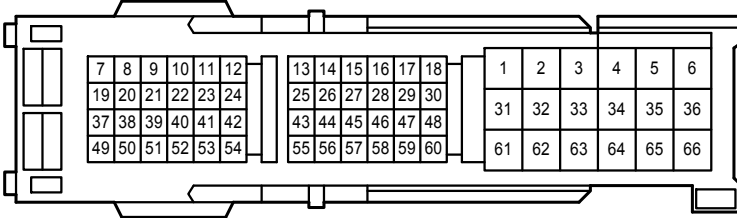

DE

White

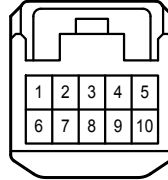

AJ2

White

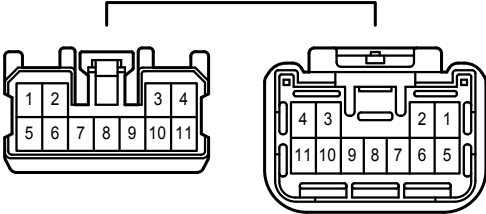

AJ5

White

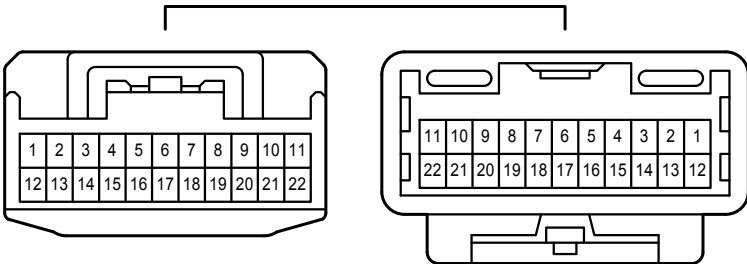

JK1

White

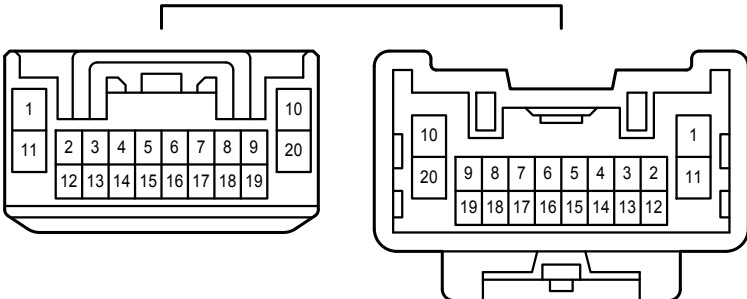

PJ1
Black

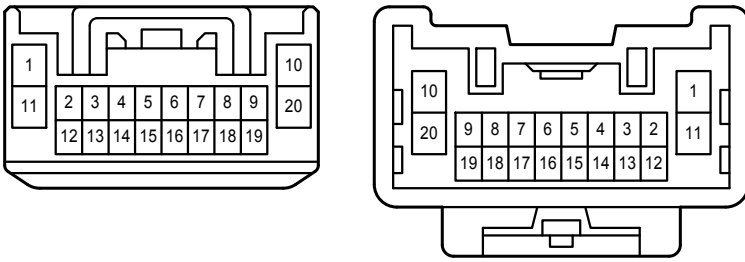

Front Fog Light

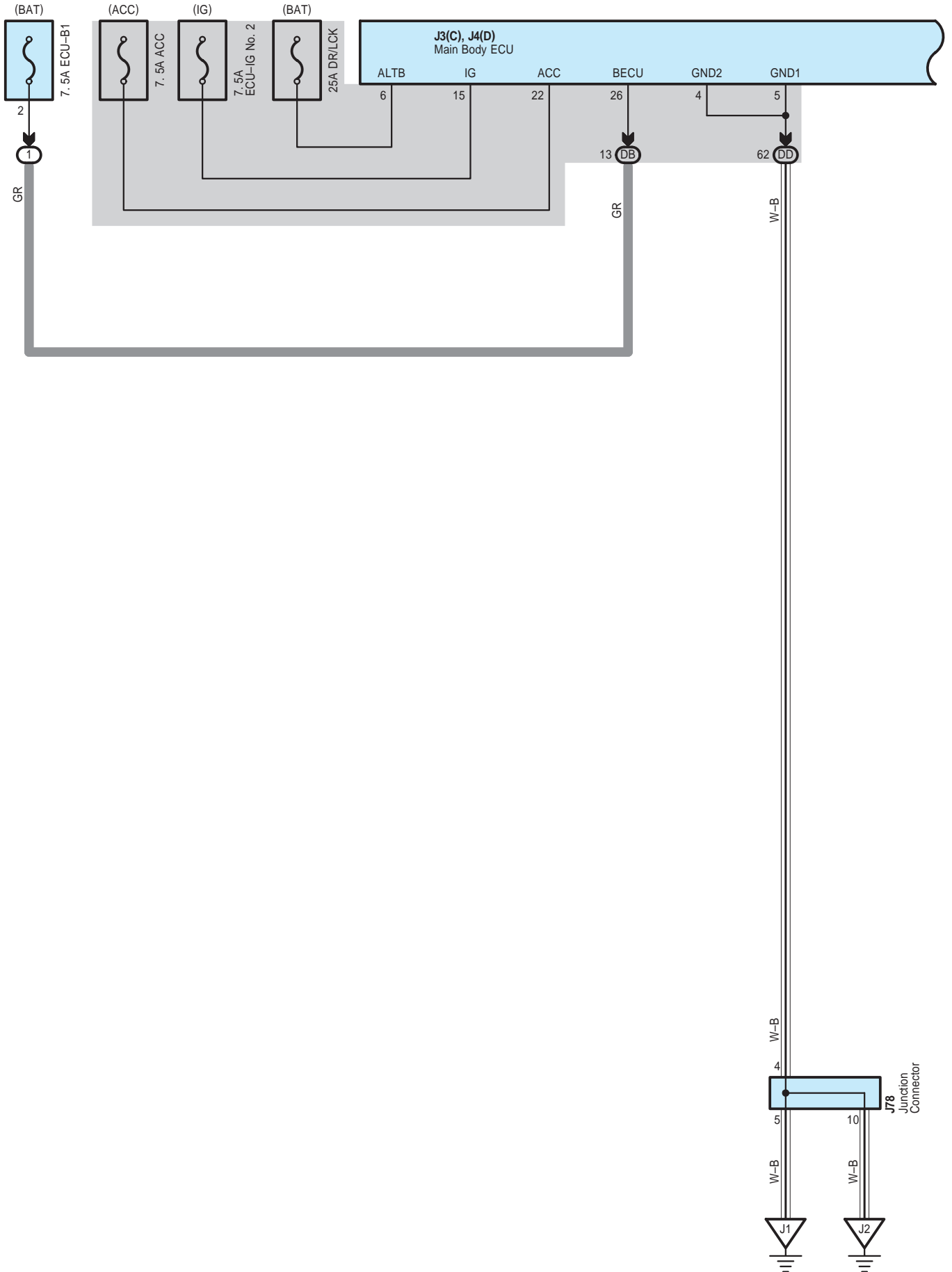

Front Fog Light

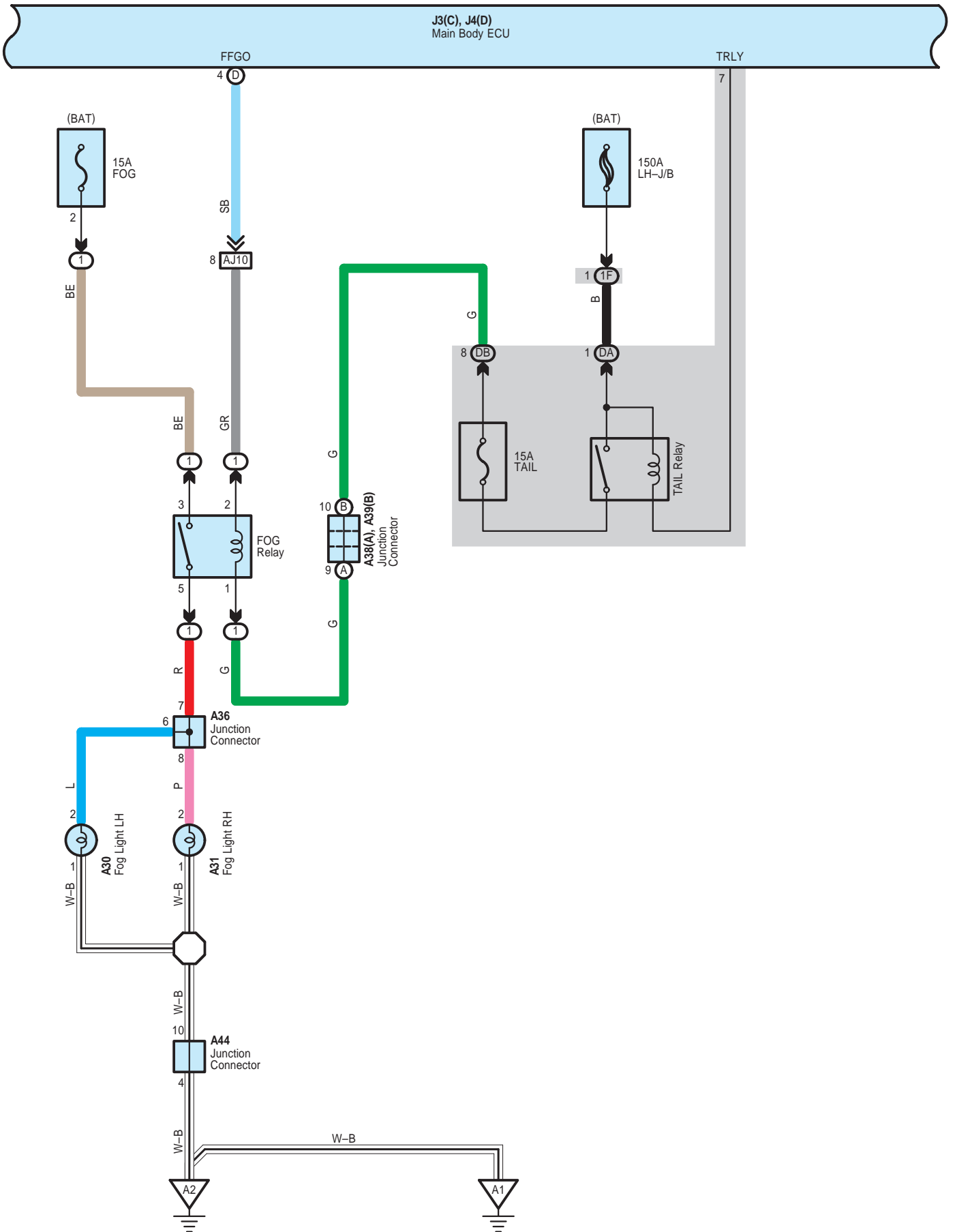

Front Fog Light

* 1 : w/ Seat Position Memory

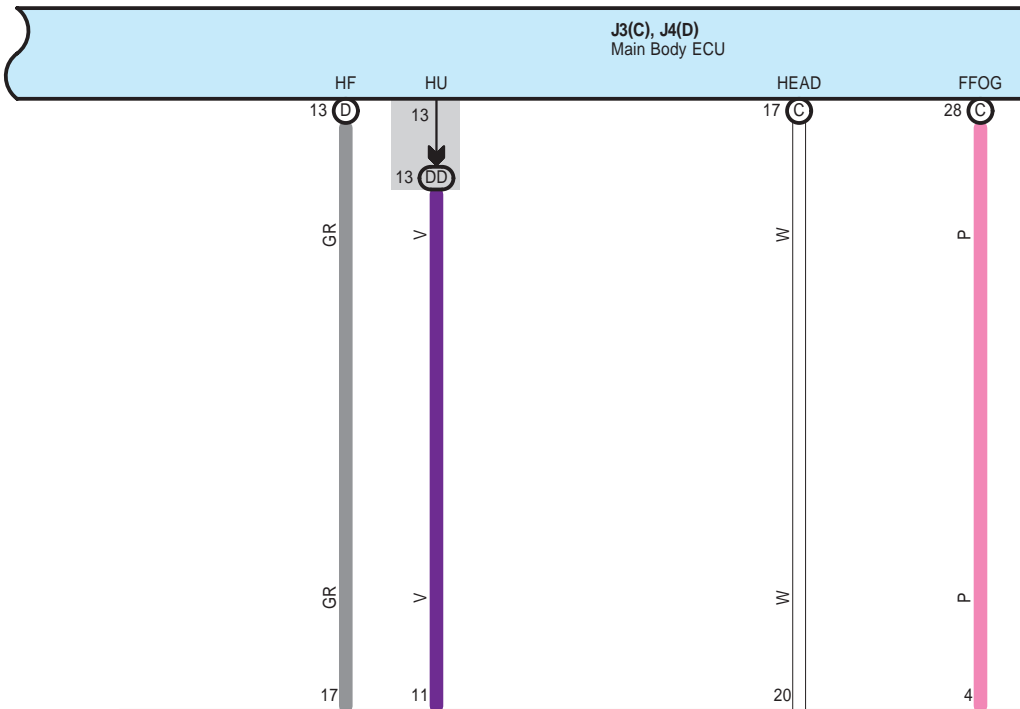

		HF	HU	HL	EL	T	H	A	BFG	LFG
Light Control Switch	OFF									
	Tail				○—○					
	Head				○—○	○—○	○—○			
	AUTO				○—○			○—○		
Dimmer Switch	Flash	○—○	○—○	○—○						
	Low			○—○	○—○					
	High		○—○		○—○					
Fog Light Switch	OFF									
	On								○—○	○—○

J10 Headlight Dimmer Switch Assembly

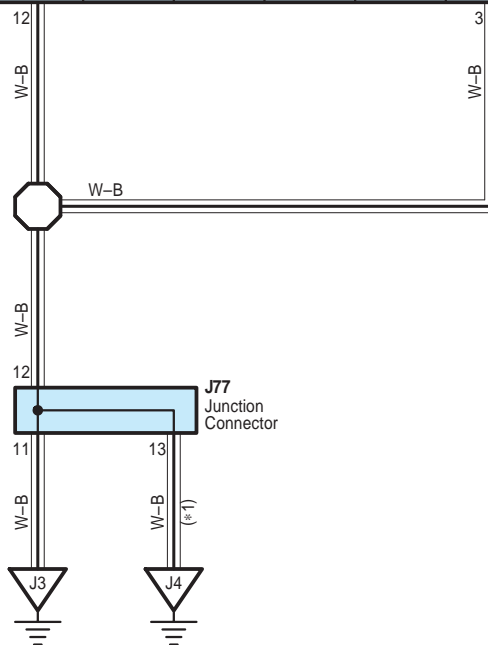

Front Fog Light

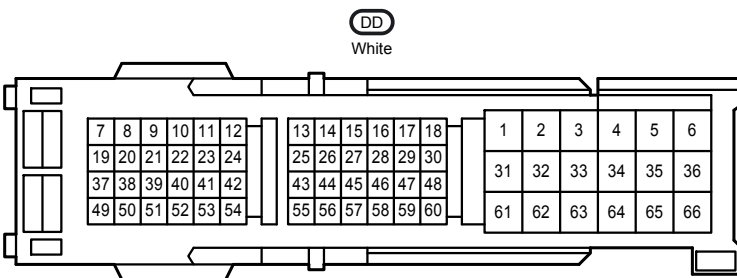
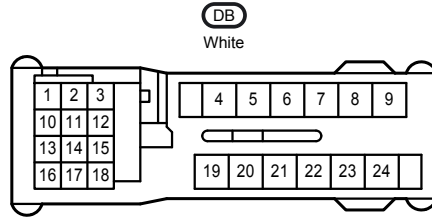
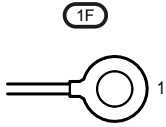
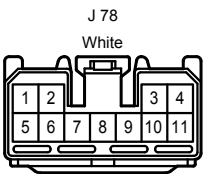
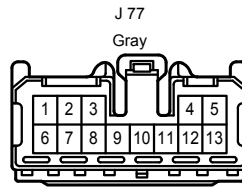
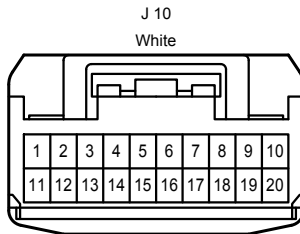
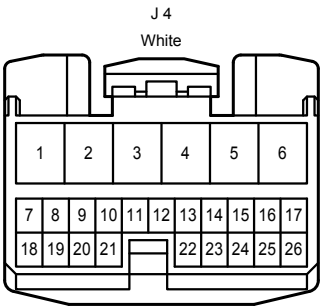
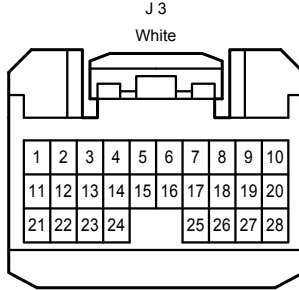
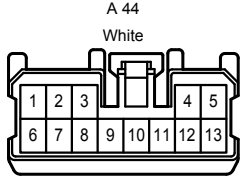
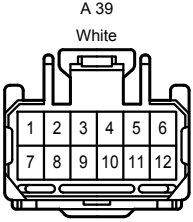
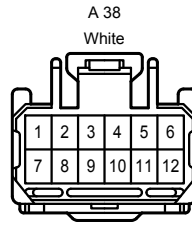
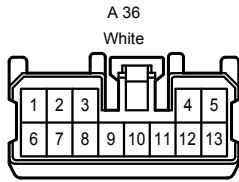
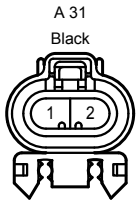
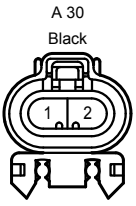

Front Fog Light

AJ10
Gray

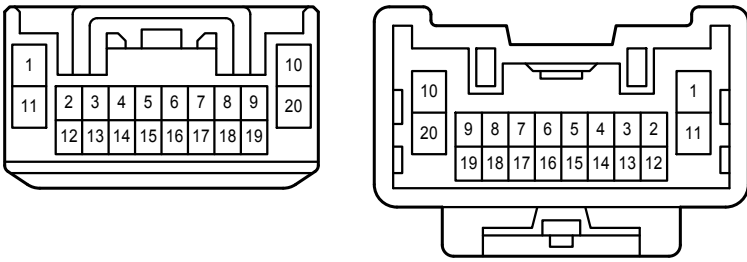

Front Window Deicer

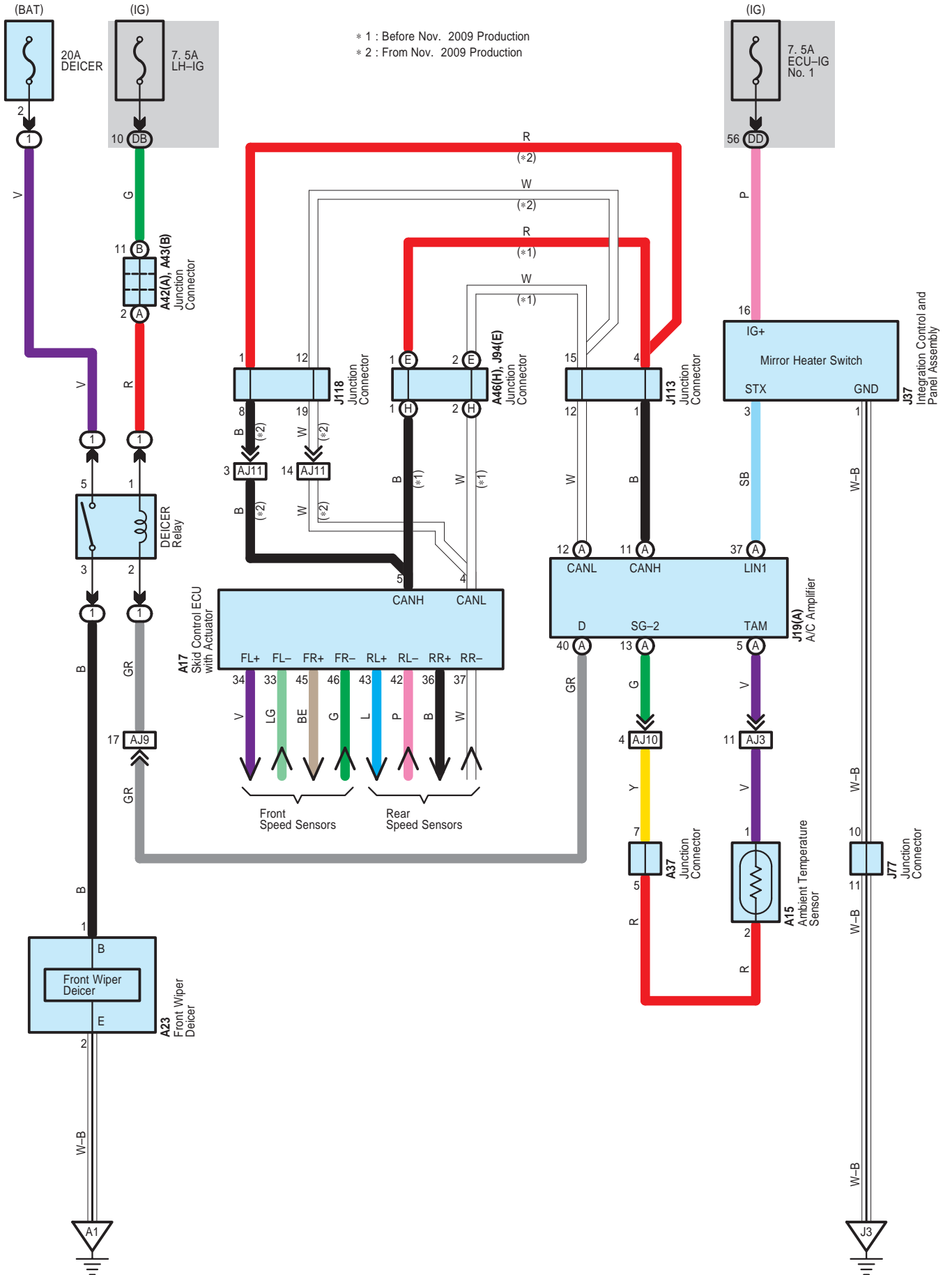

Front Window Deicer

A 15

Black



A 17

Black

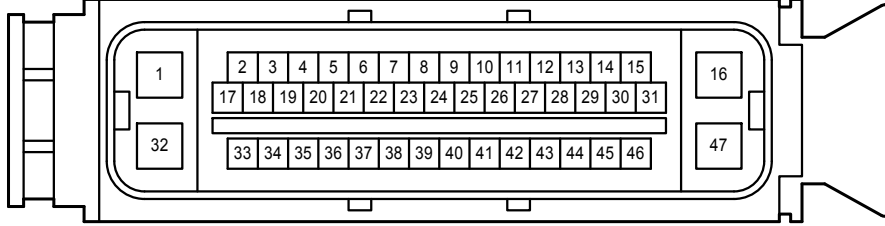

A 23

Black

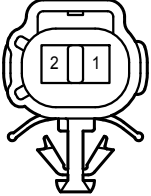

A 37

White

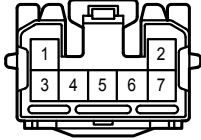

A 42

White

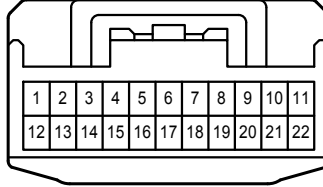

A 43

White

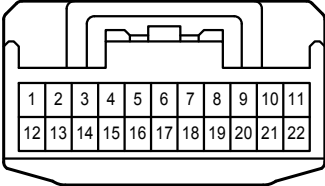

A 46

White

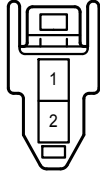

J 19

White

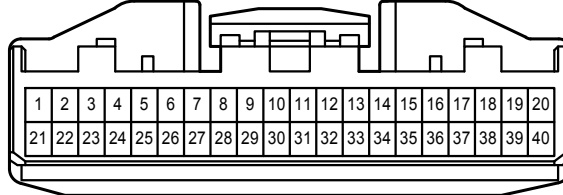

J 37

White

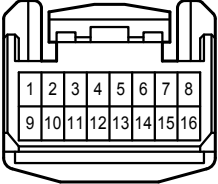

J 77

Gray

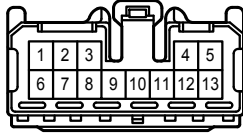

J 94

White

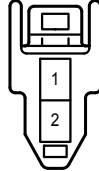

J113

Gray

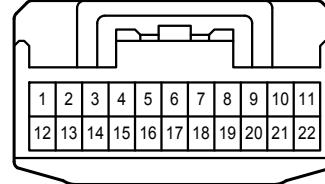

J118

Gray

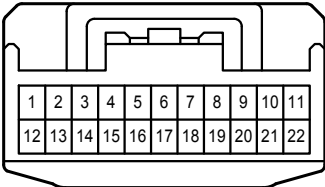

DB

White

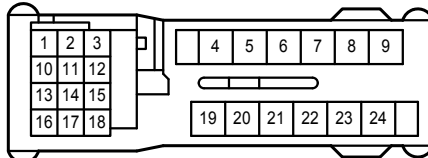

DD

White

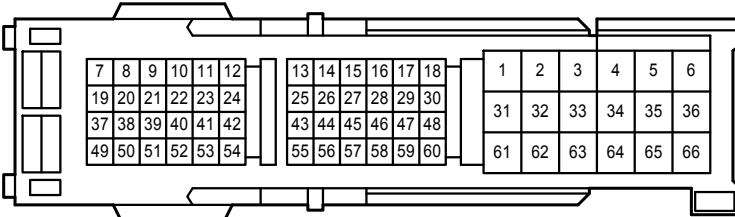

AJ3
White

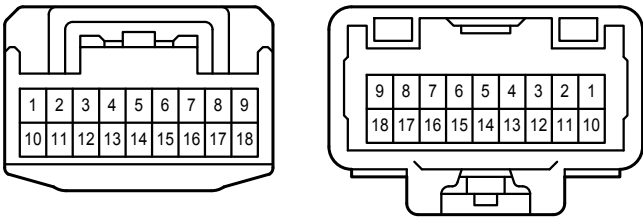

AJ9
Gray

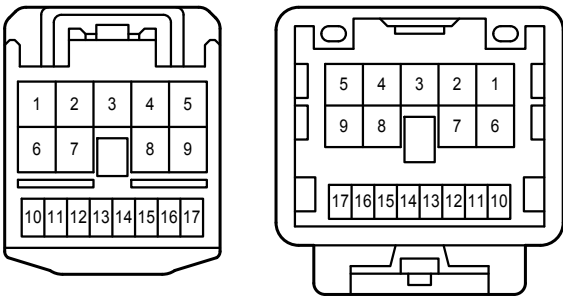

AJ10
Gray

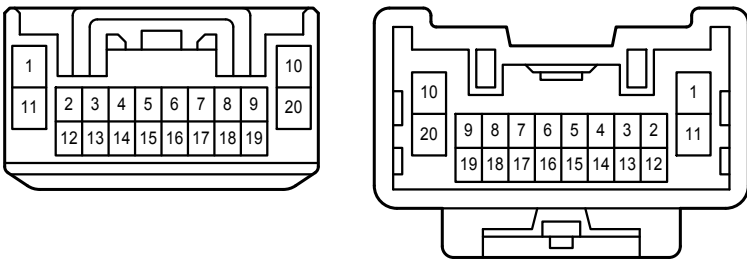

AJ11
Gray

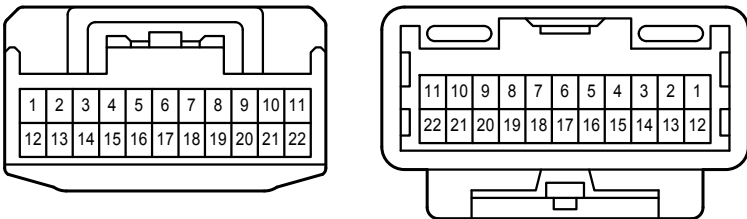

Front Wiper and Washer <w/ Intermittent Wiper>

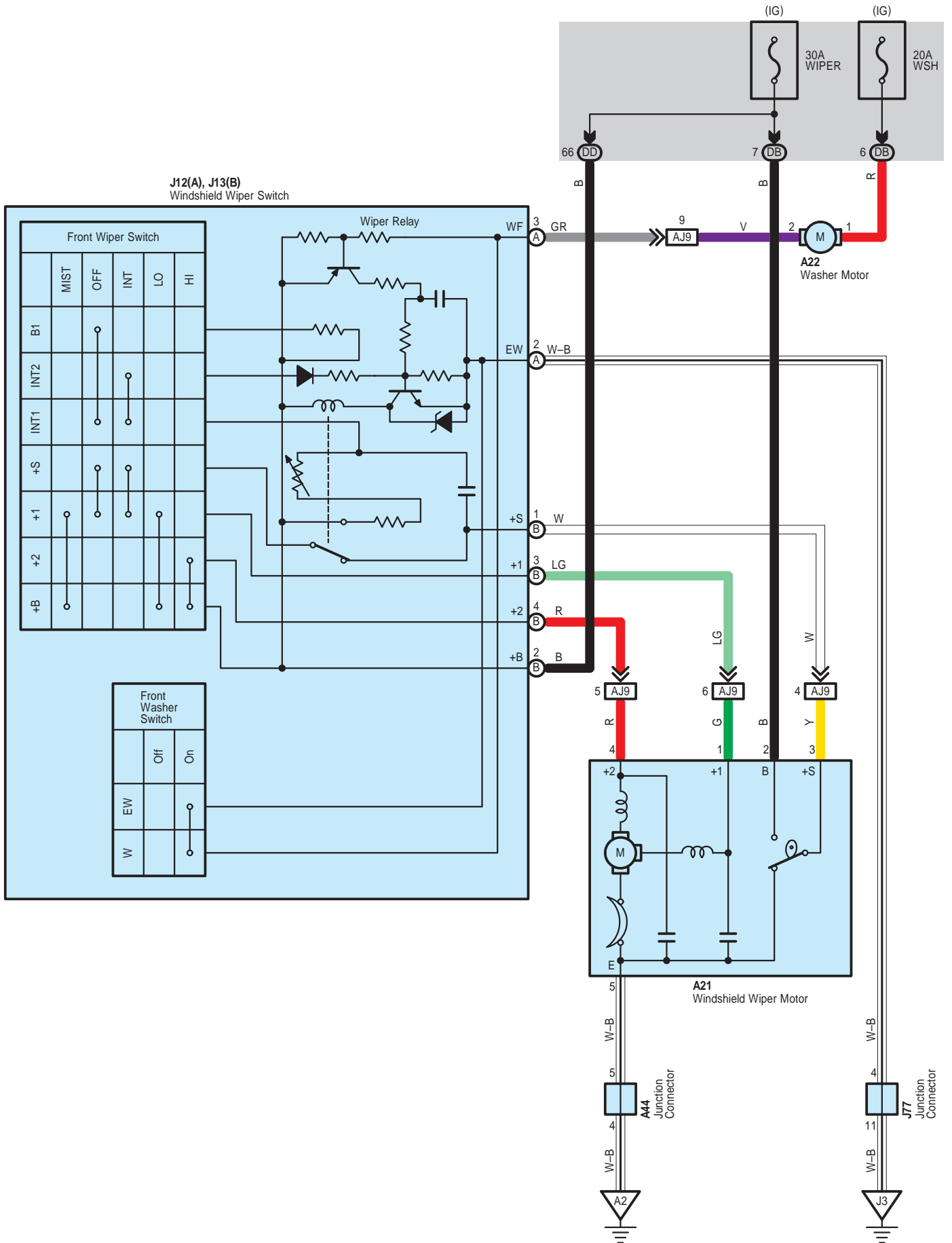

Front Wiper and Washer <w/ Intermittent Wiper>

A 21
Black

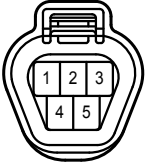

A 22
Black

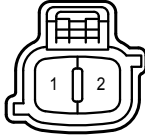

A 44
White

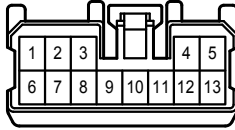

J 12
White

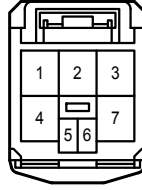

J 13
White

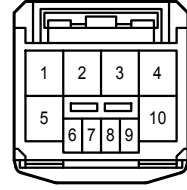

J 77
Gray

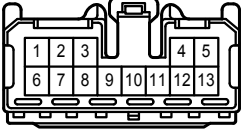

DB
White

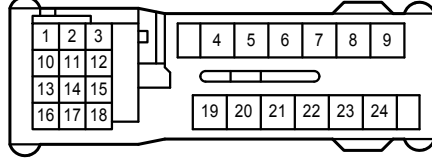

DD
White

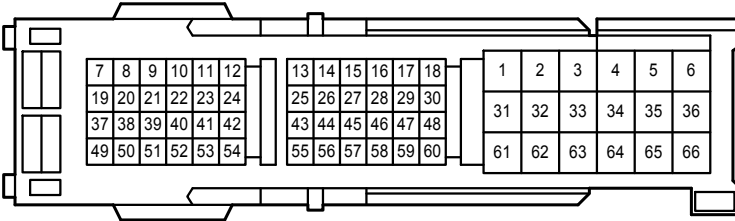

AJ9
Gray

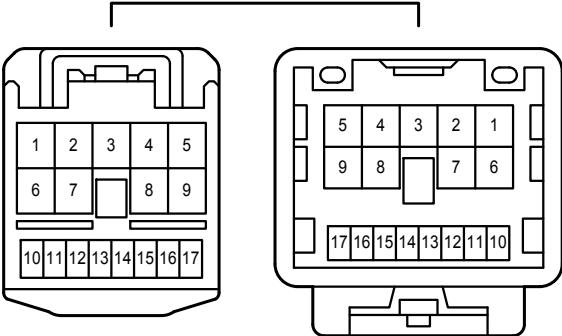

Front Wiper and Washer <w/o Intermittent Wiper>

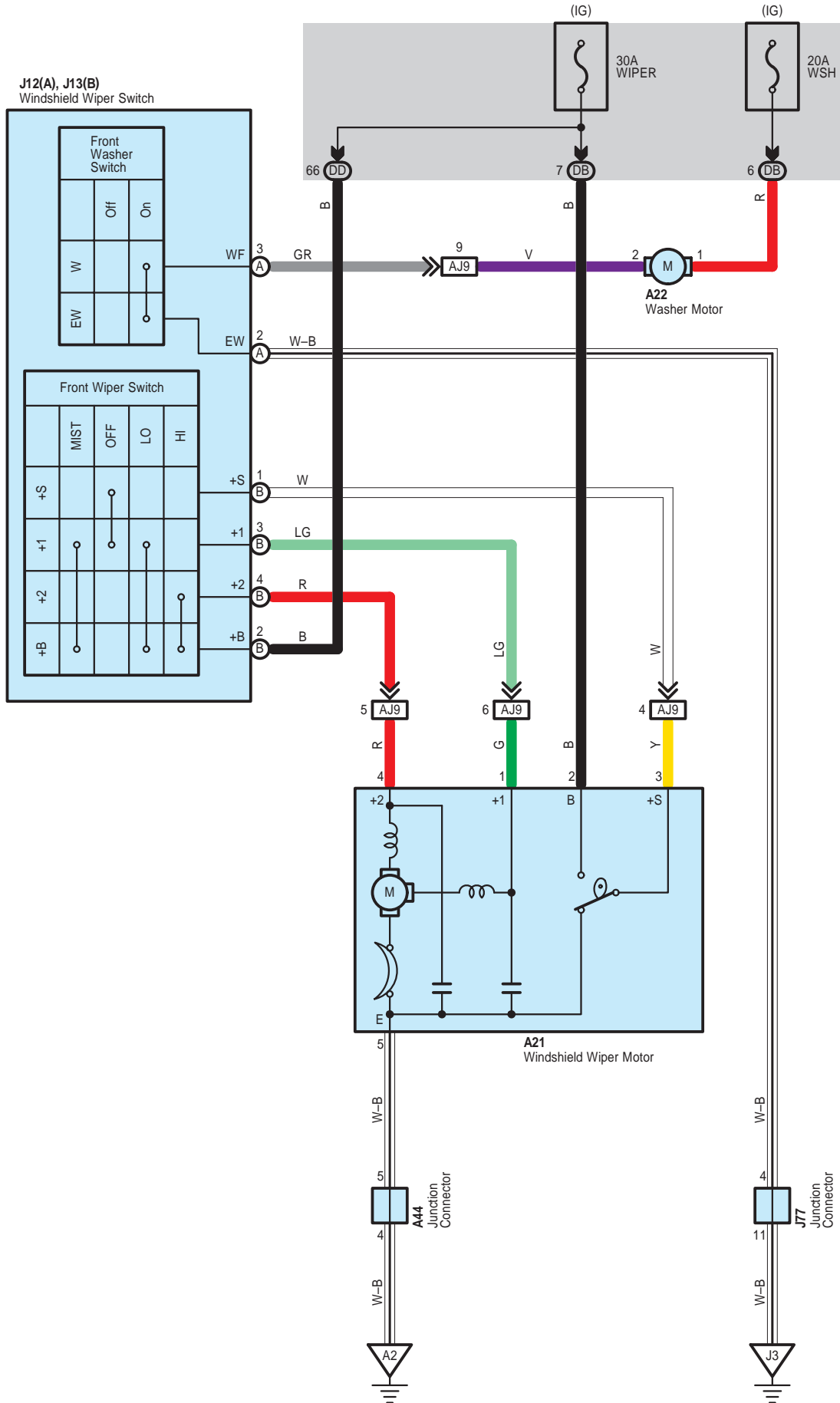

Front Wiper and Washer <w/o Intermittent Wiper>

A 21

Black

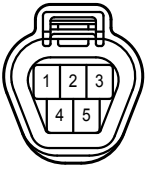

A 22

Black

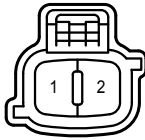

A 44

White

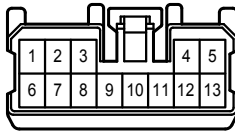

J 12

White

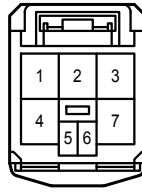

J 13

White

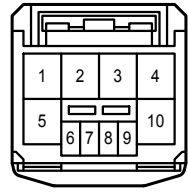

J 77

Gray

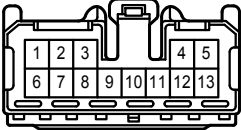

DB

White

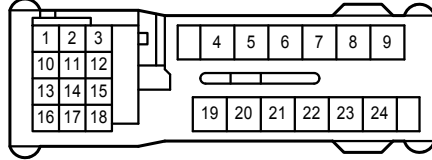

DD

White

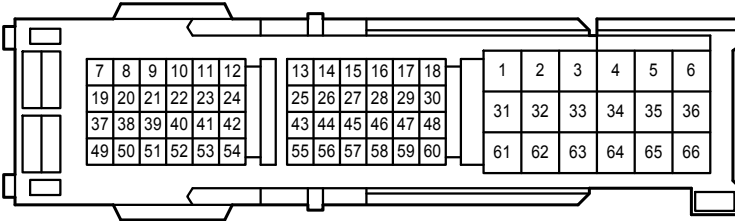

AJ9

Gray

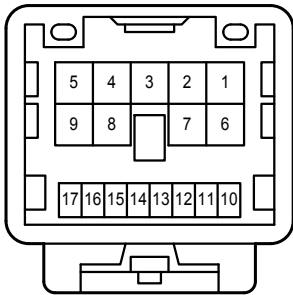
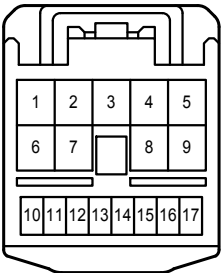

Garage Door Opener

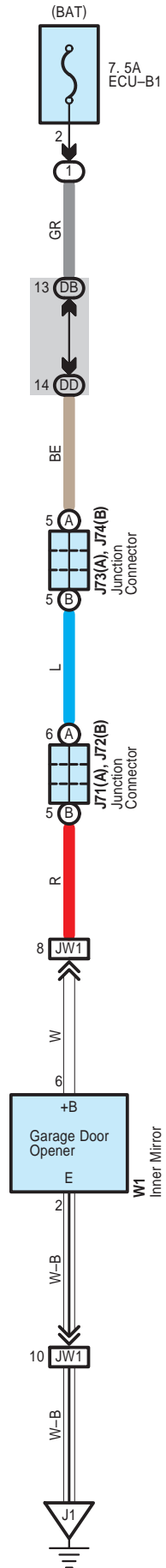

Garage Door Opener

J 71
Black

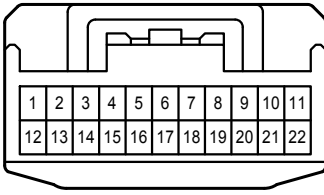

J 72
Black

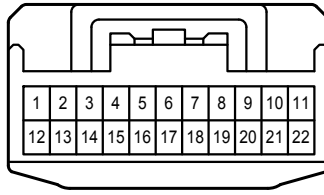

J 73
Black

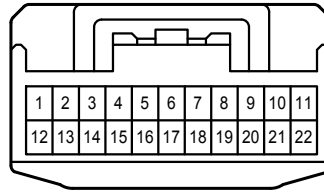

J 74
Black

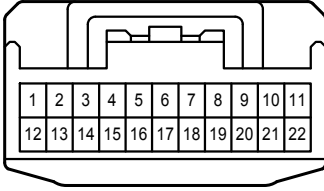

W 1
Black

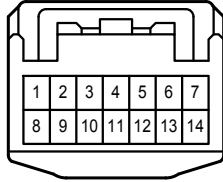

DB
White

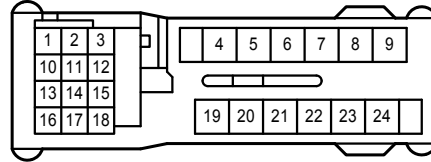

DD
White

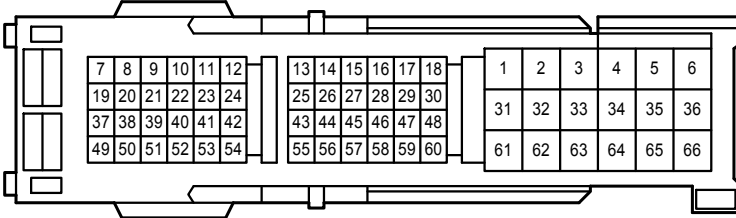

JW1
White

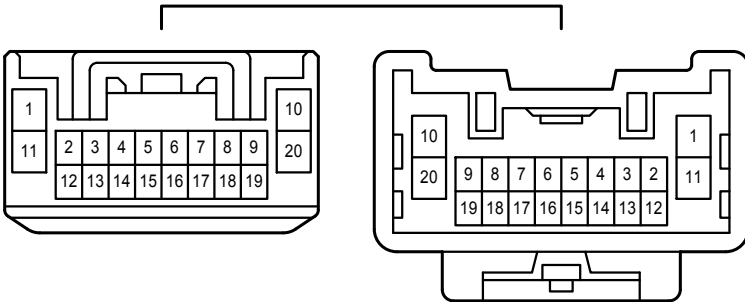

Ground Point

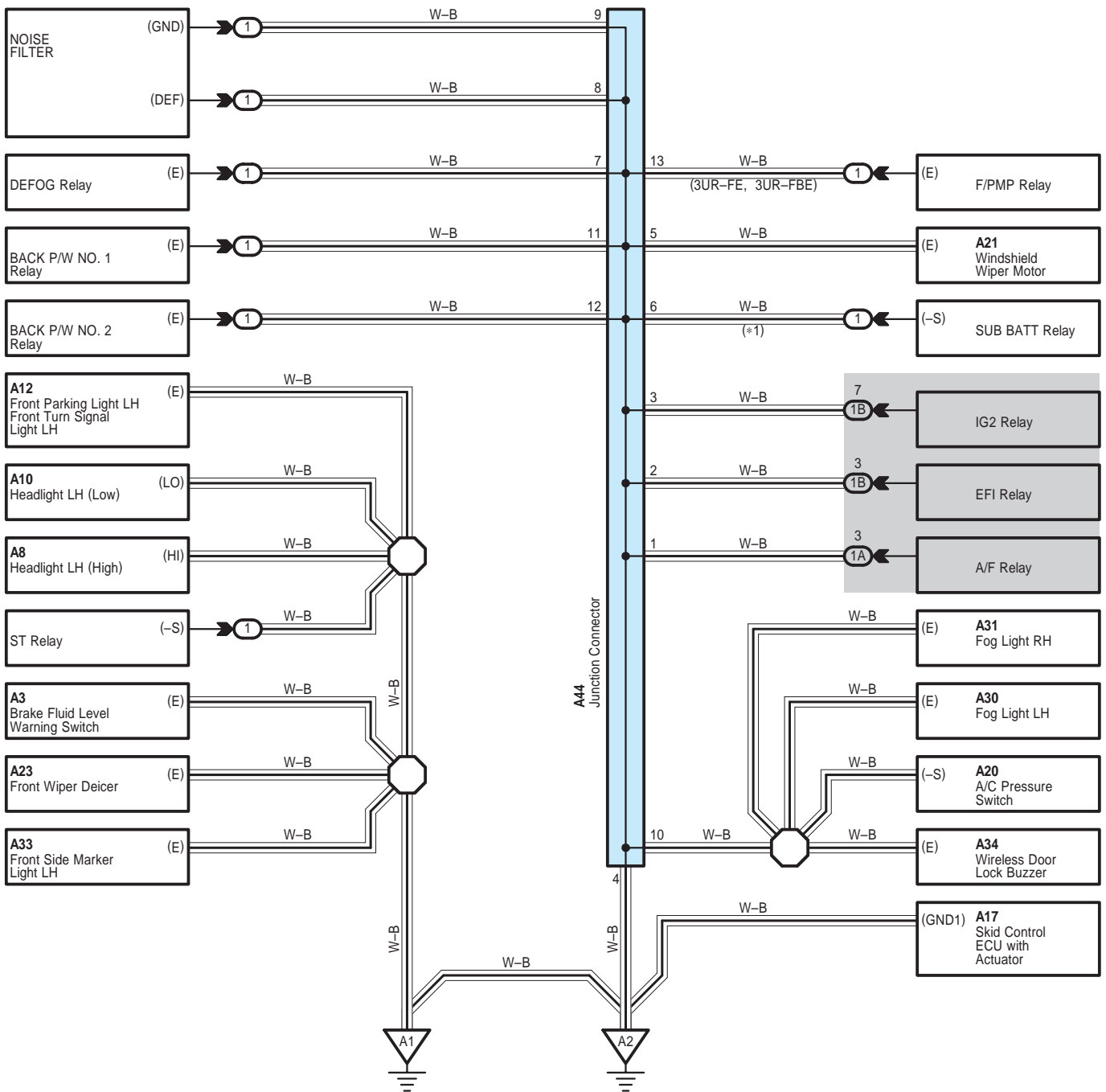

Ground Point

- * 1 : Towing Package
- * 2 : Except Towing Package
- * 8 : Except 3UR-FBE
- * 9 : 3UR-FBE

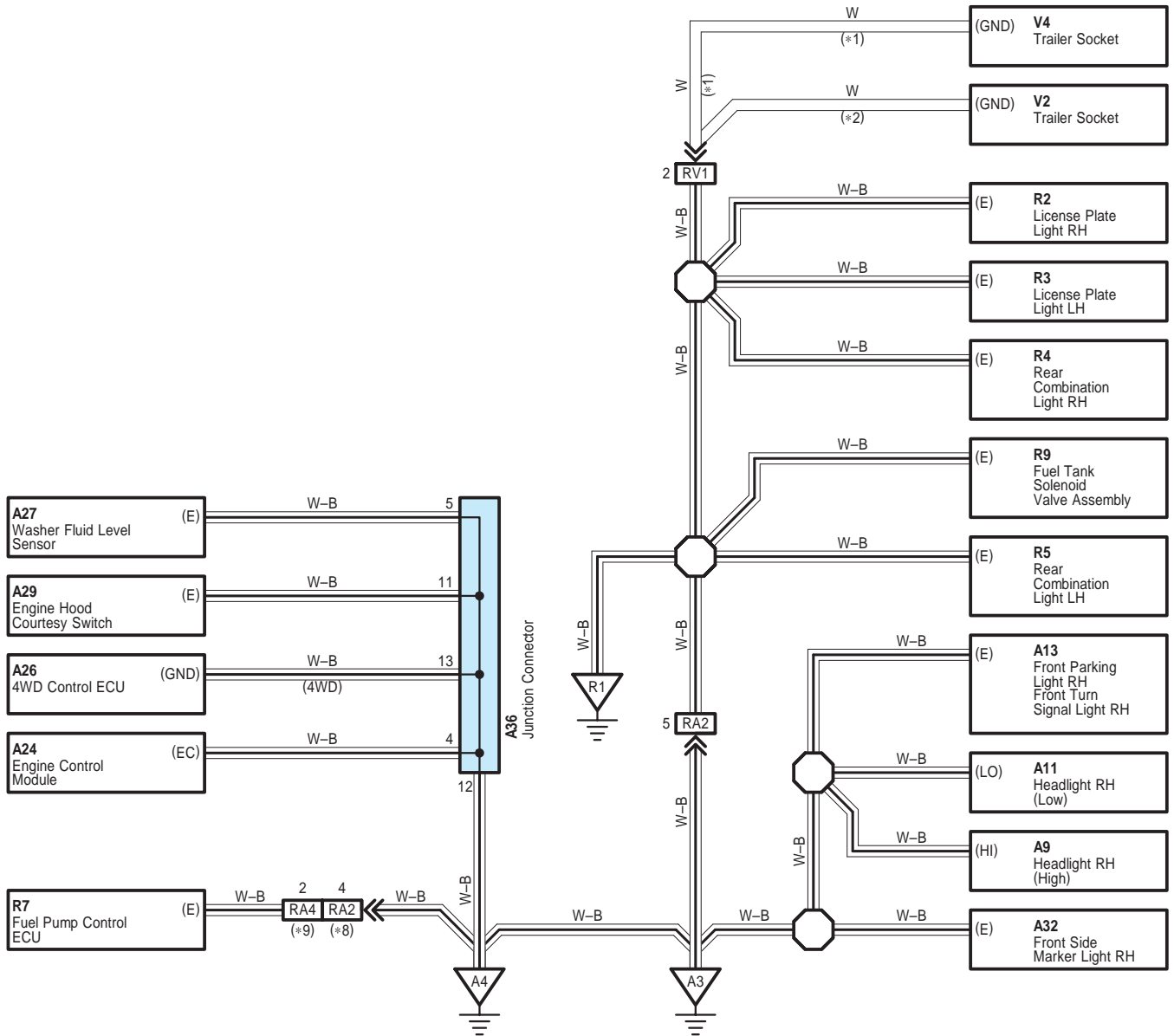

Ground Point

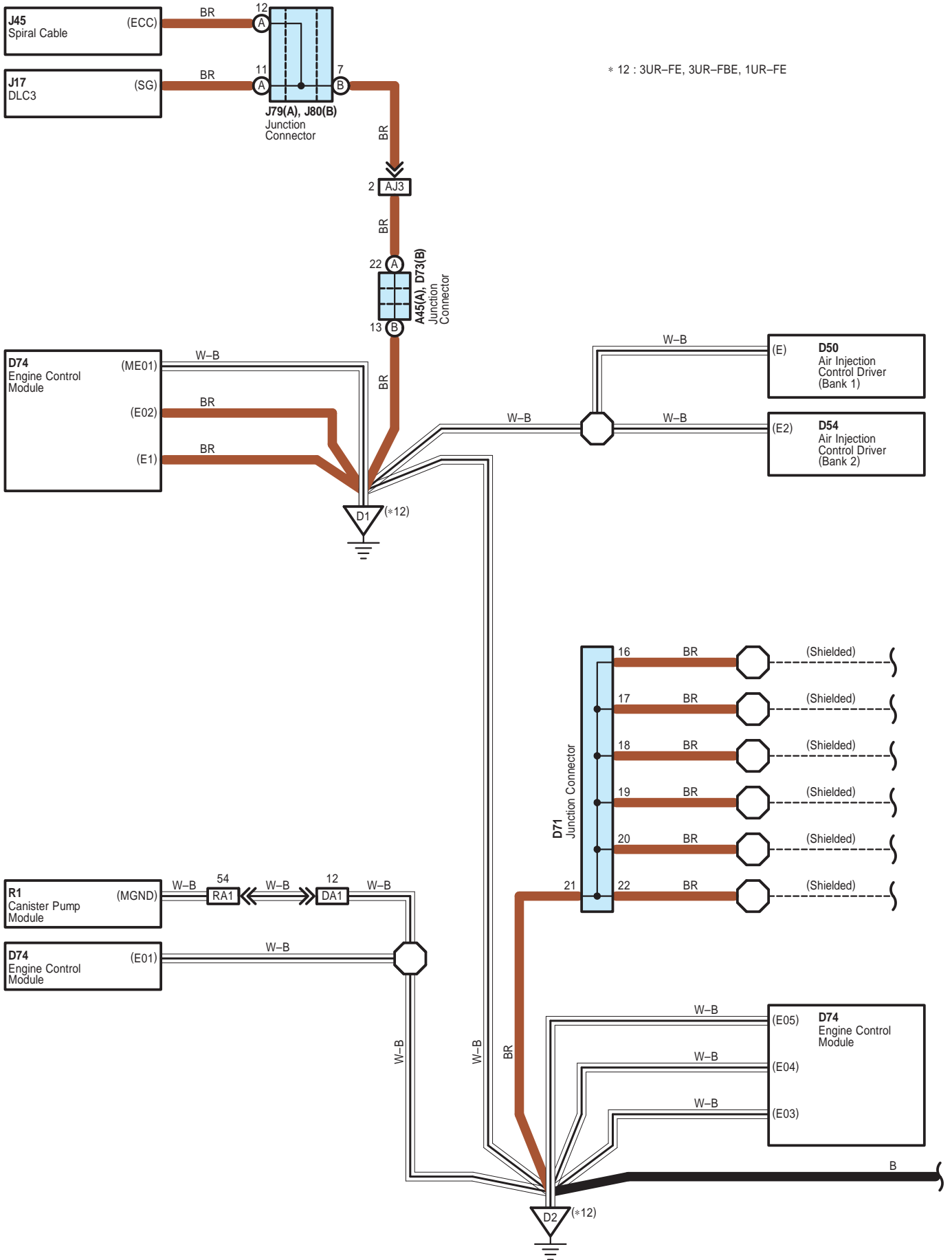

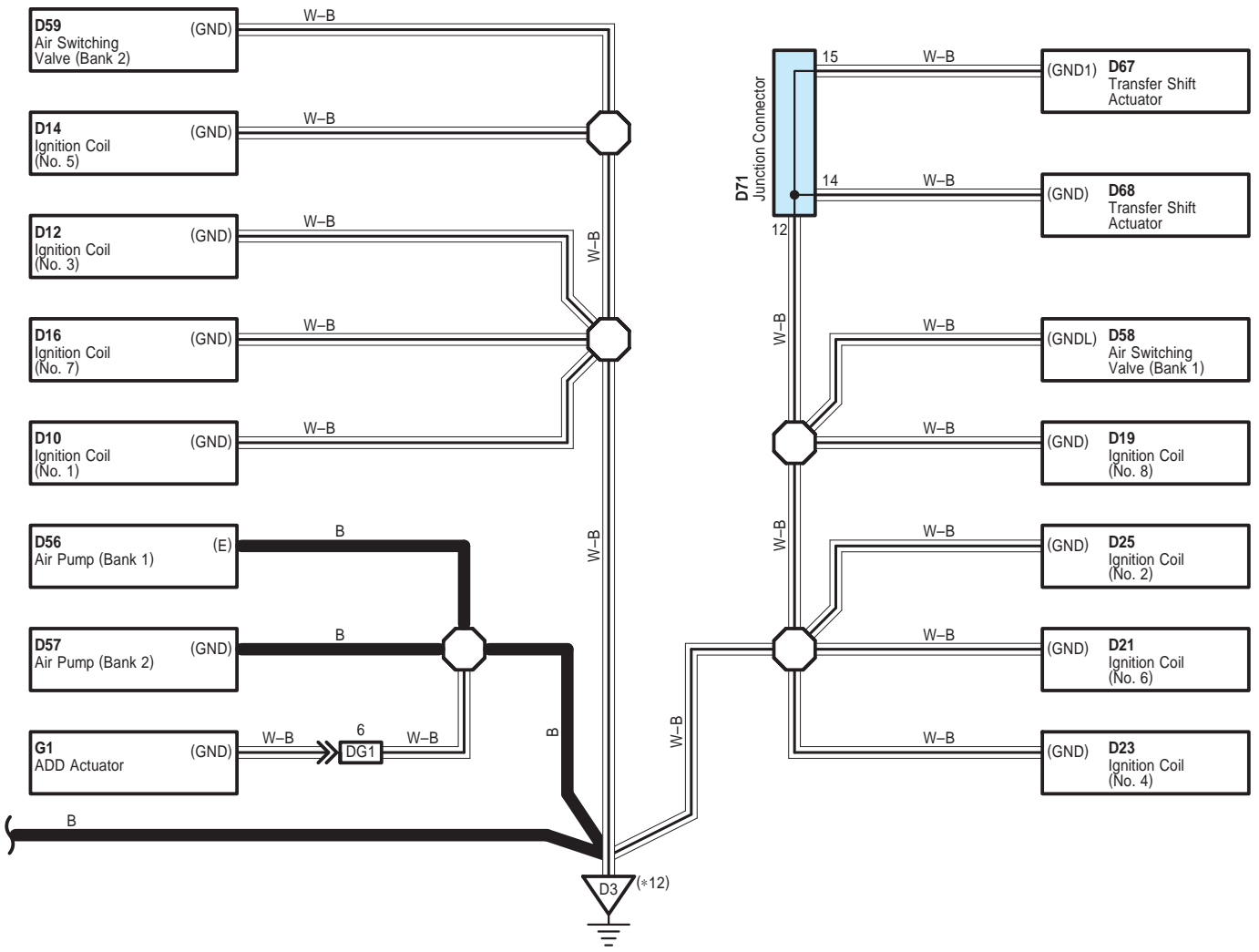

Ground Point

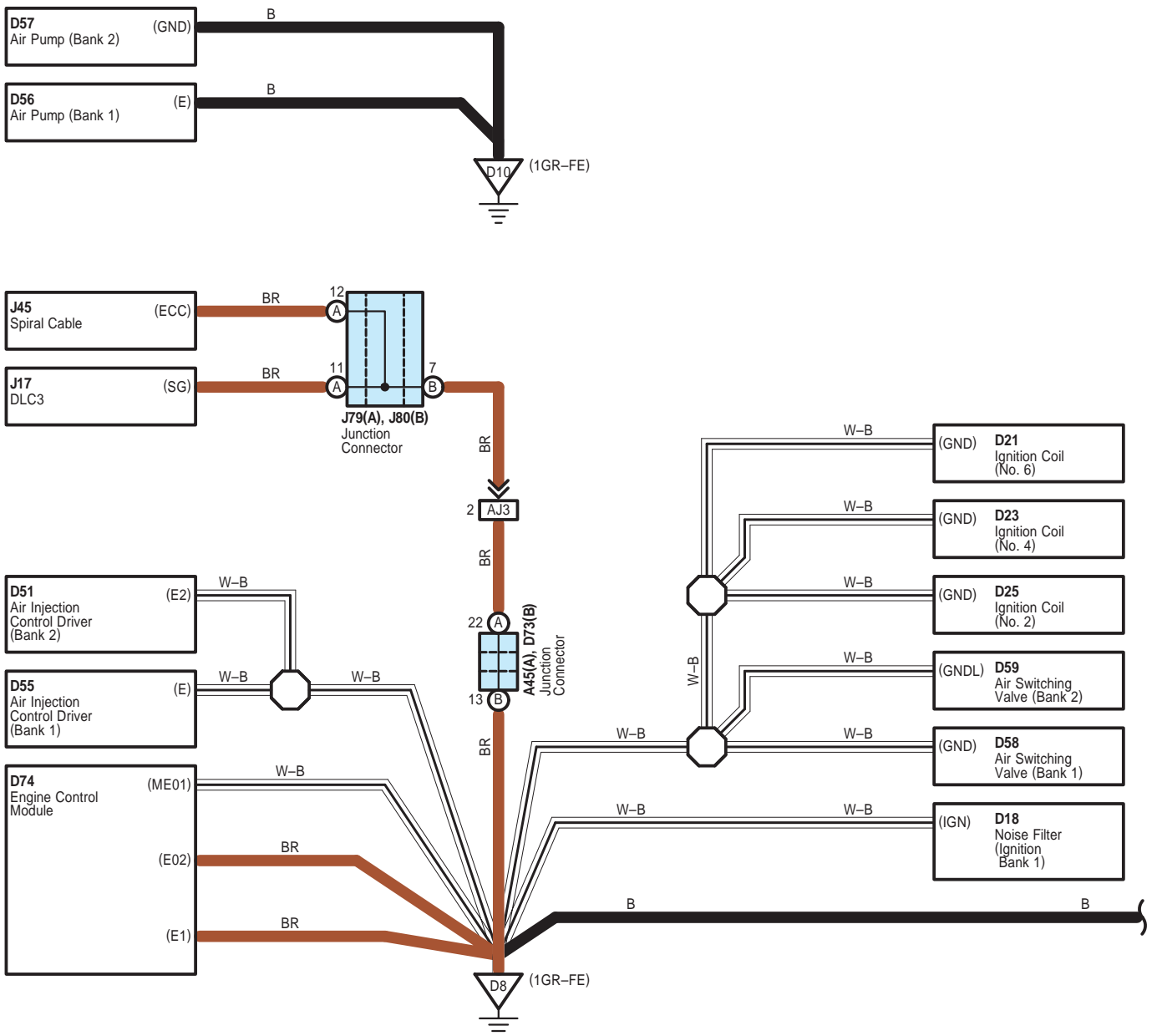

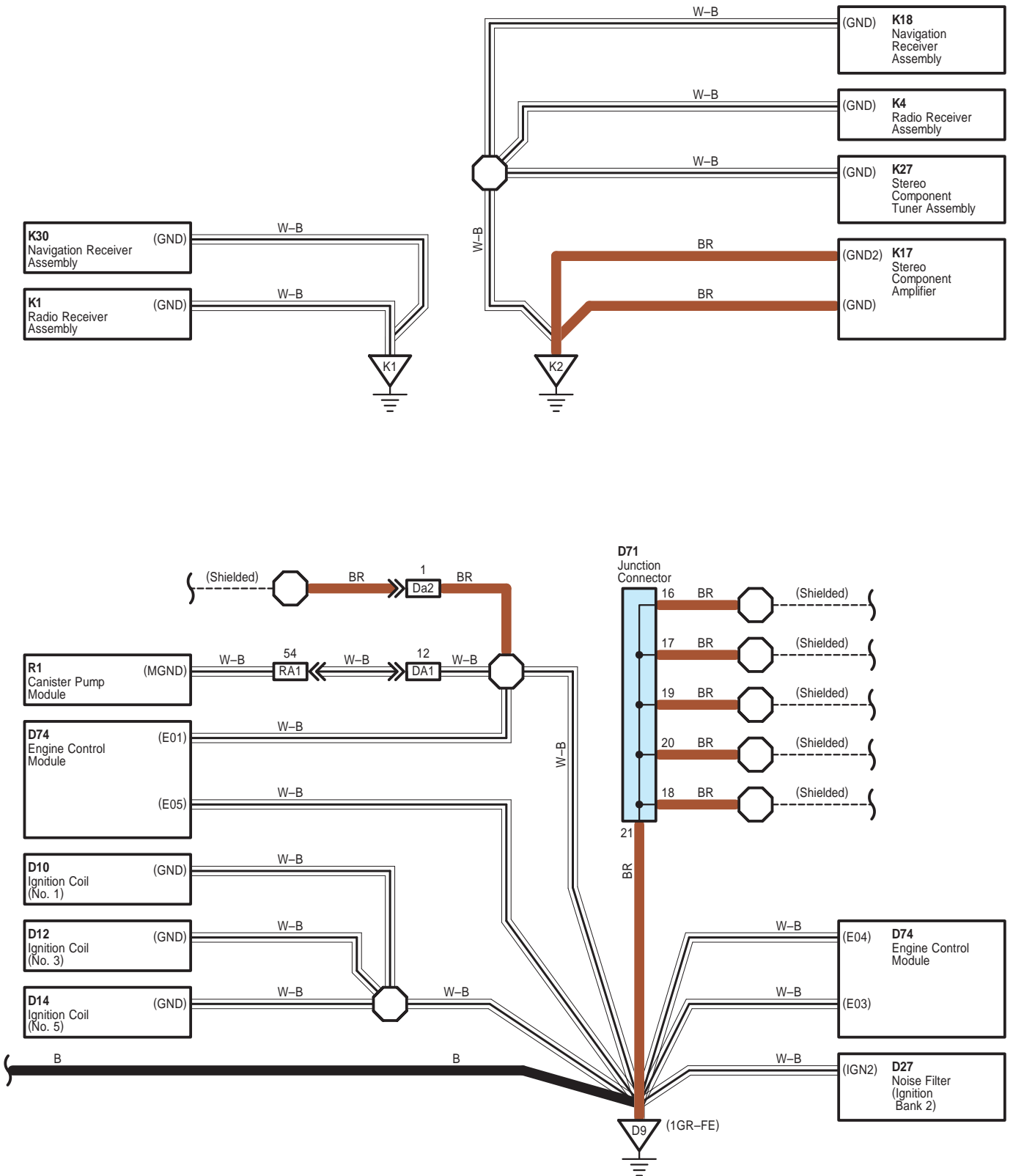

Ground Point

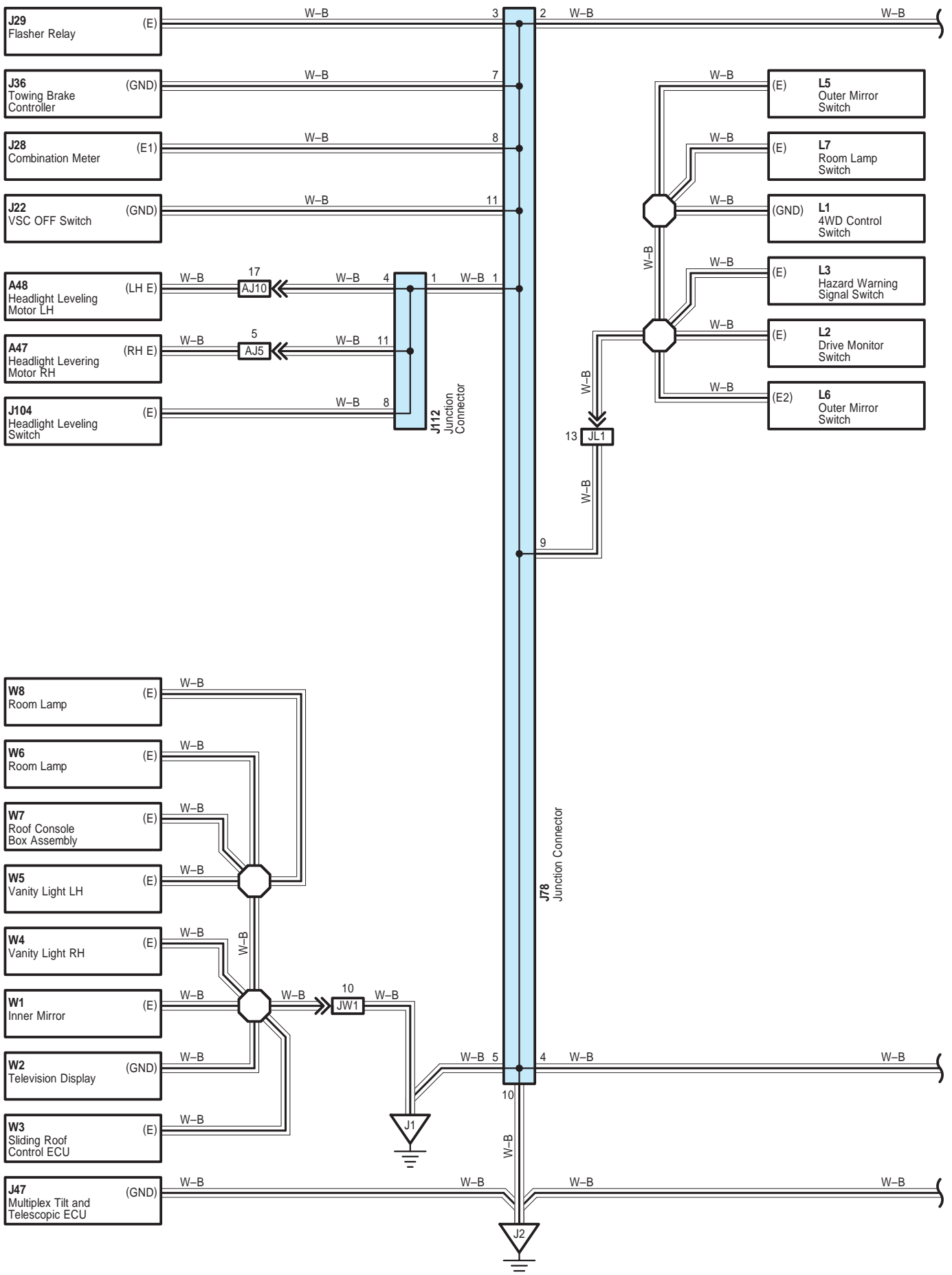

Ground Point

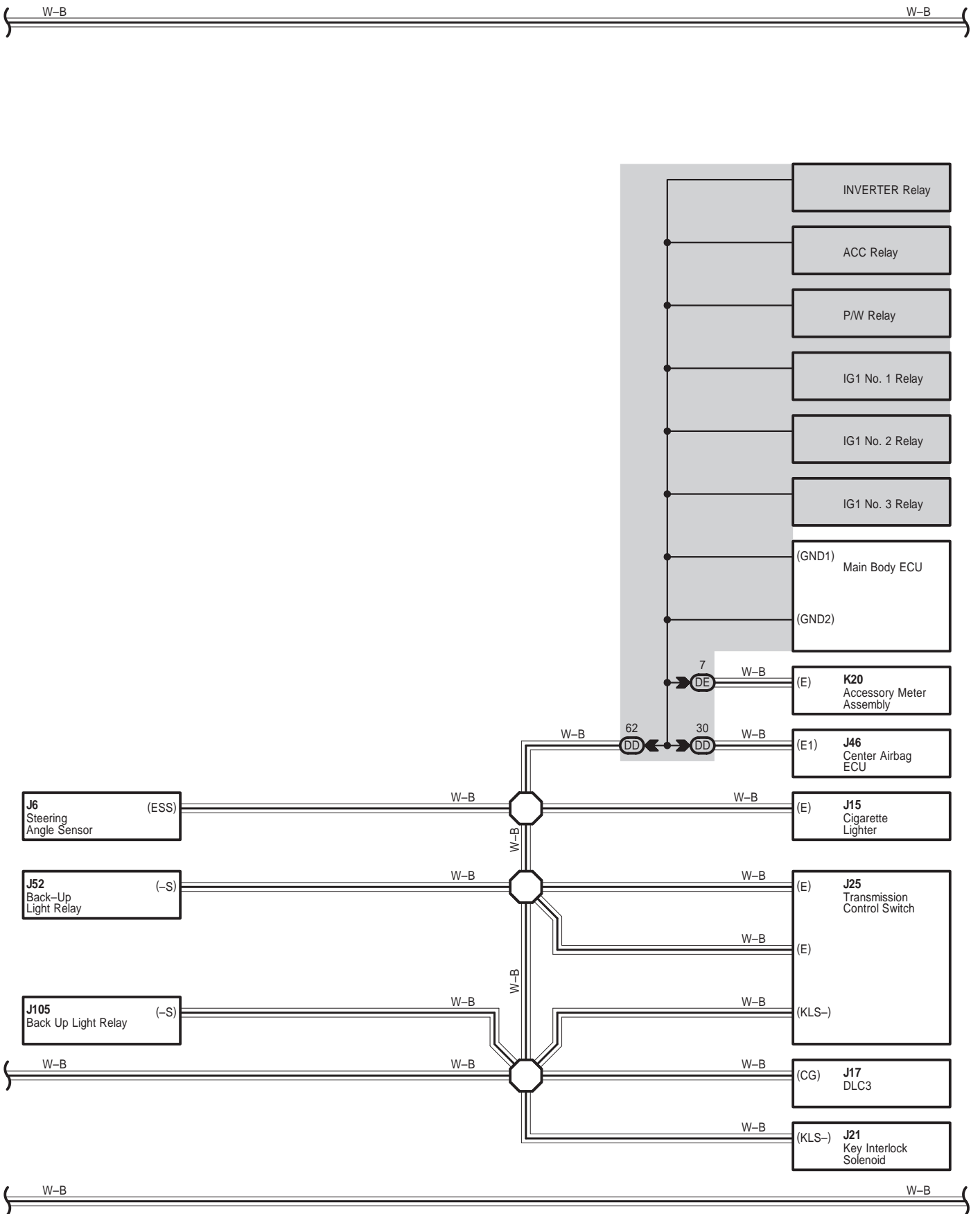

Ground Point

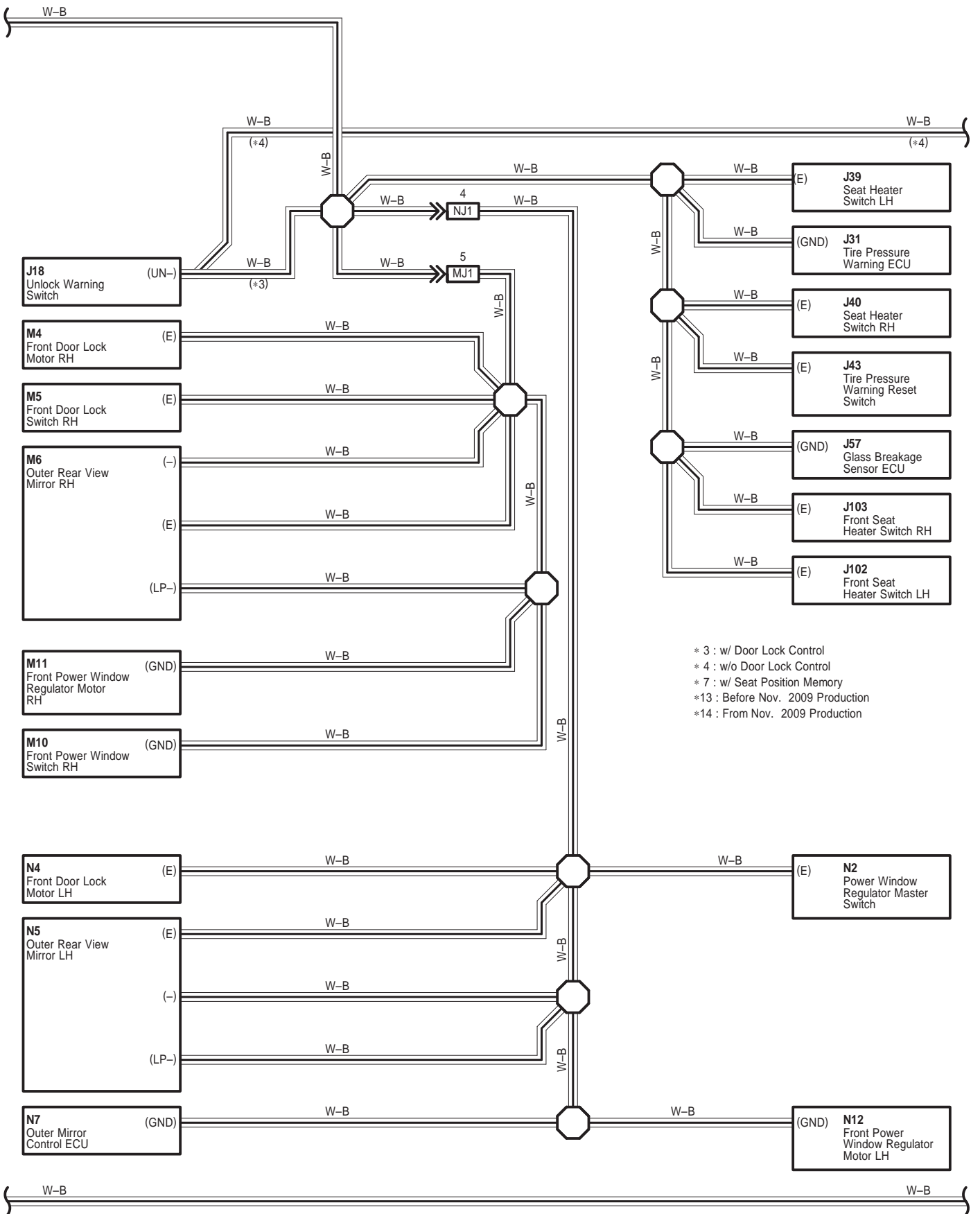

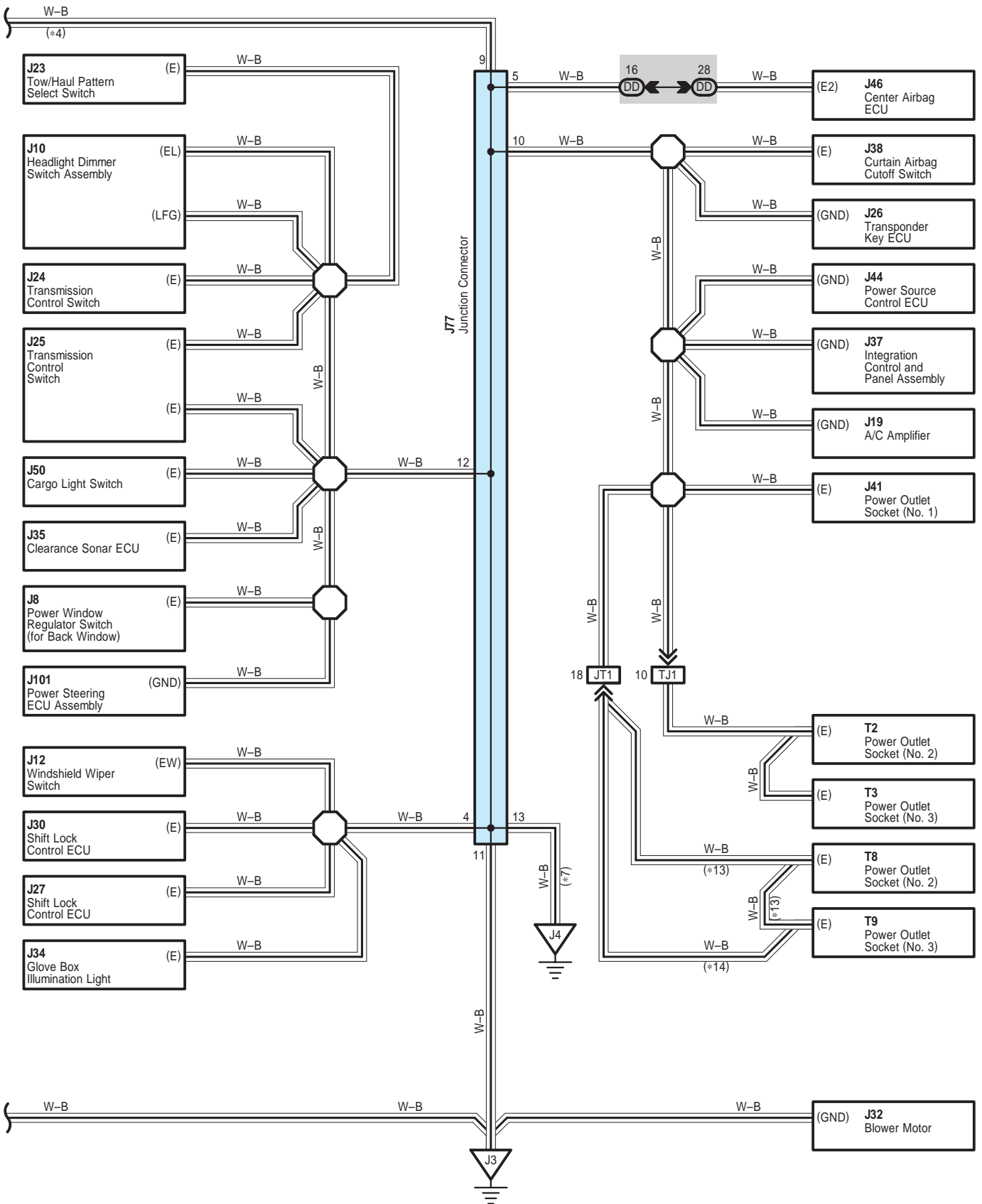

Ground Point

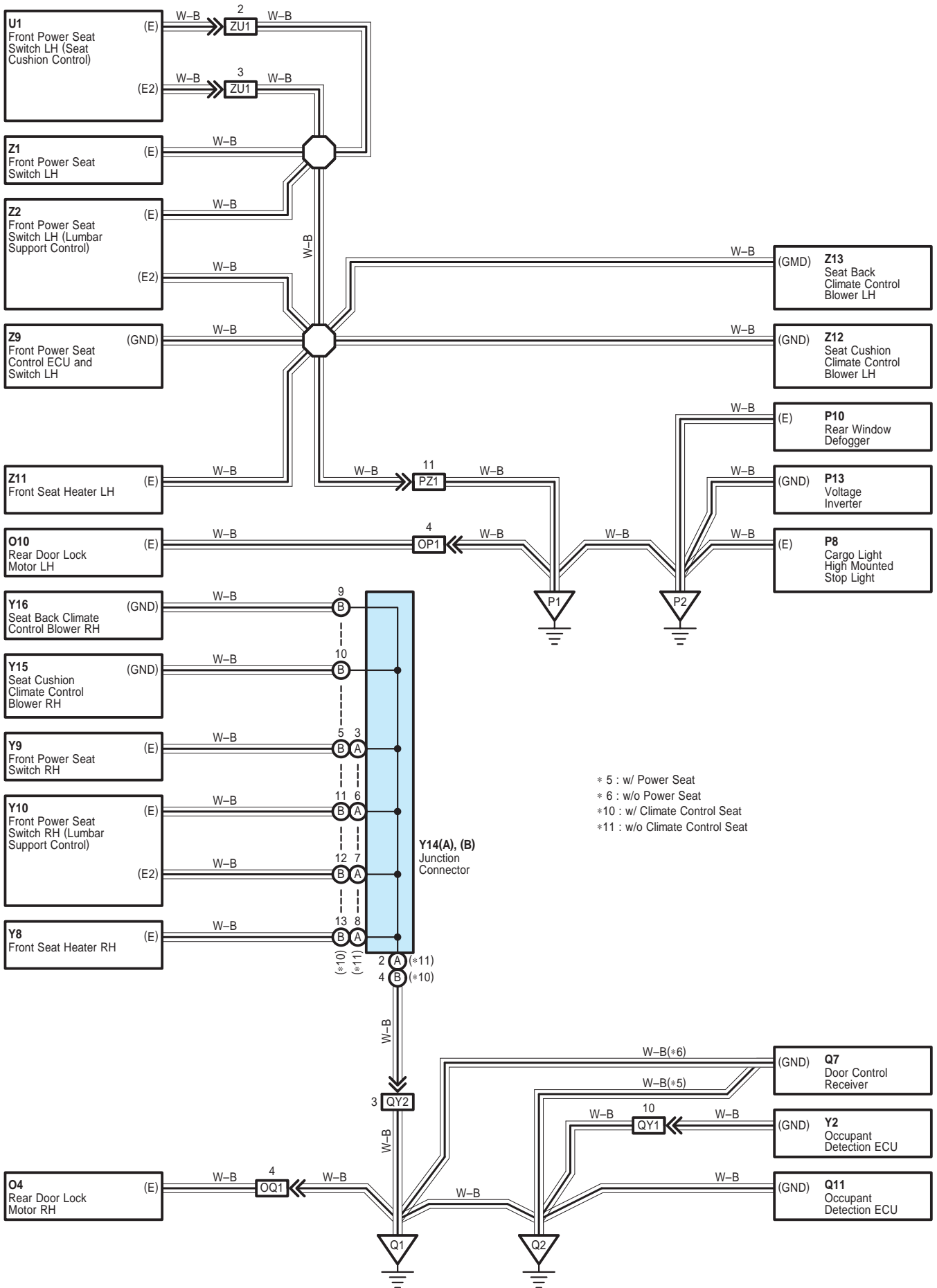

Ground Point

A 36
White

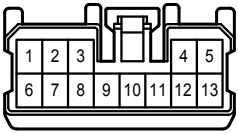

A 44
White

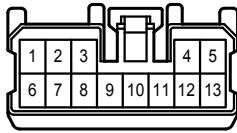

A 45
Blue

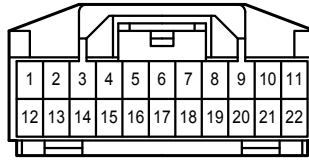

D 71
White

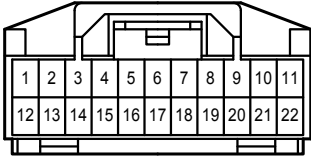

D 73
Blue

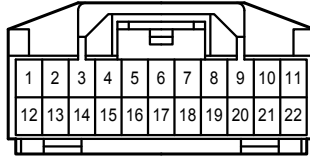

J 77
Gray

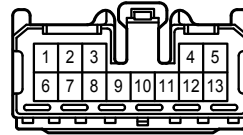

J 78
White

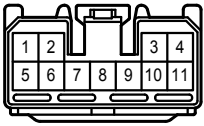

J 79
White

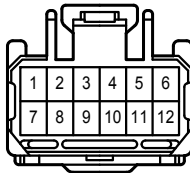

J 80
White

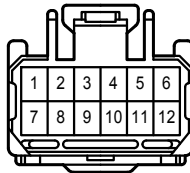

J112
White

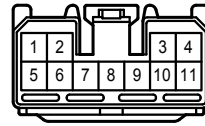

Y 14
White

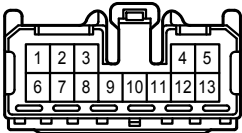

1A
White

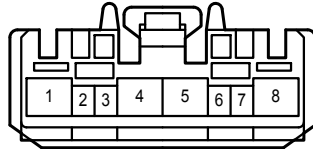

1B
White

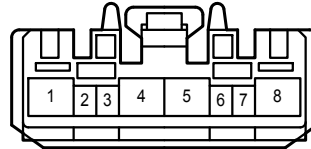

DD
White

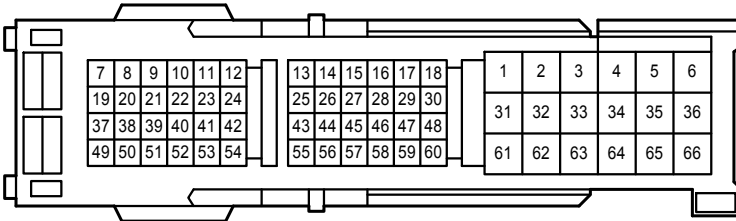

DE
White

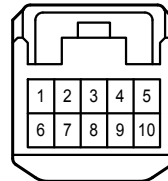

AJ3
White

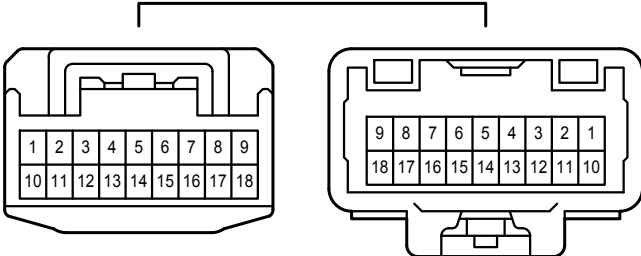

AJ5
White

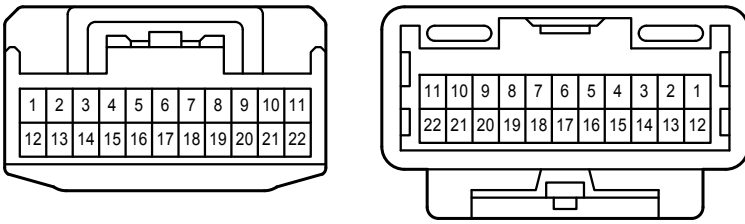

AJ10
Gray

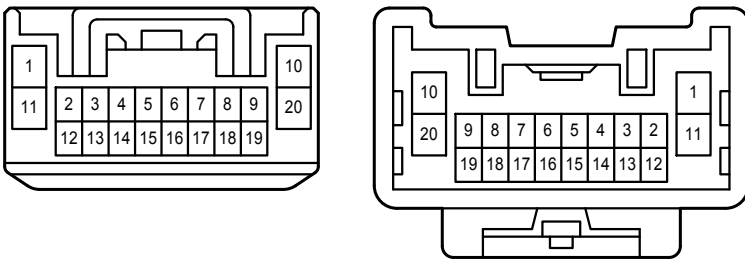

DA1
White

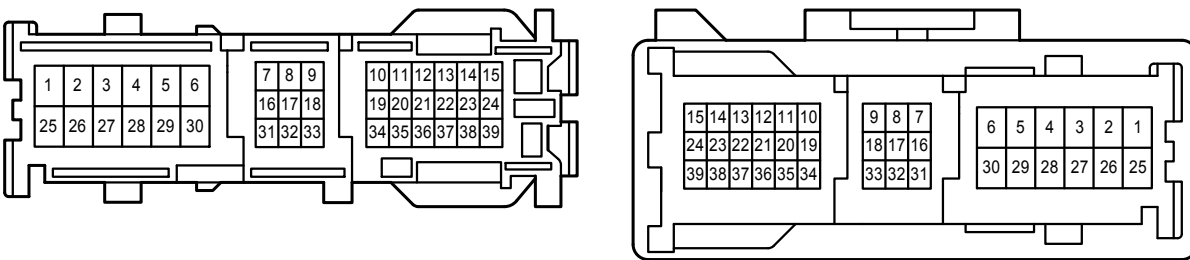

DG1
Black

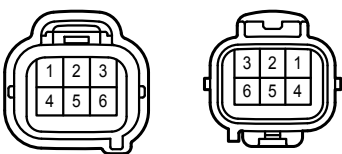

Da2
Gray

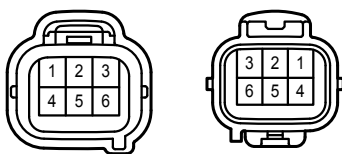

JL1
White

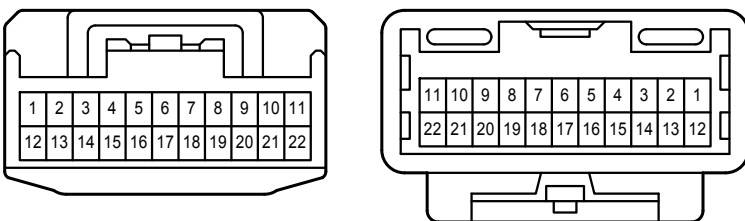

JT1
Black

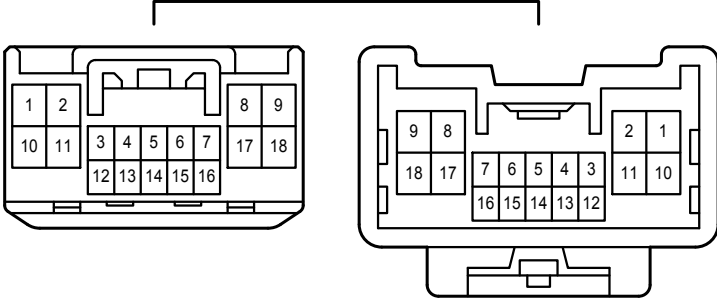

JW1
White

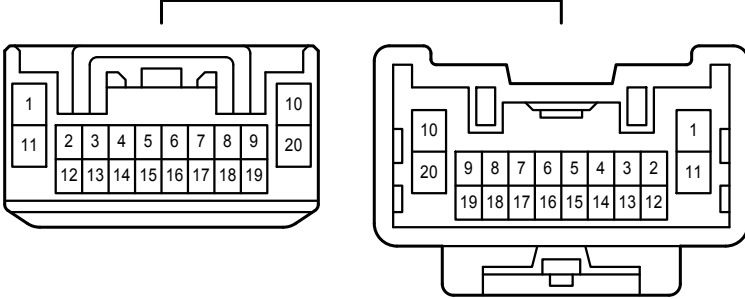

KW1
White

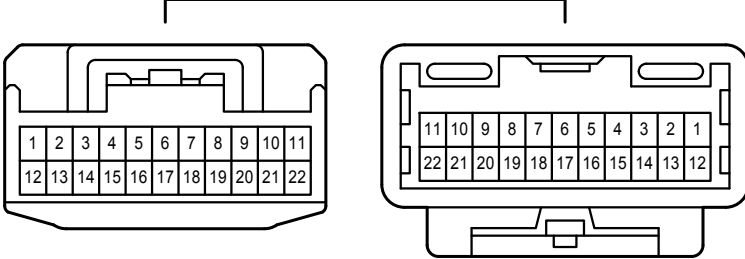

MJ1
Blue

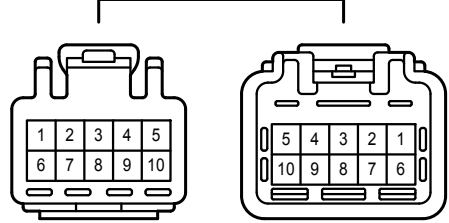

NJ1
Blue

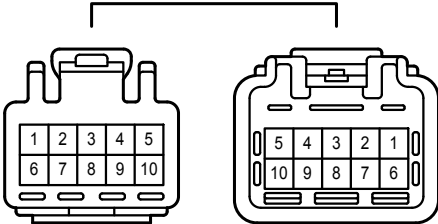

OP1
White

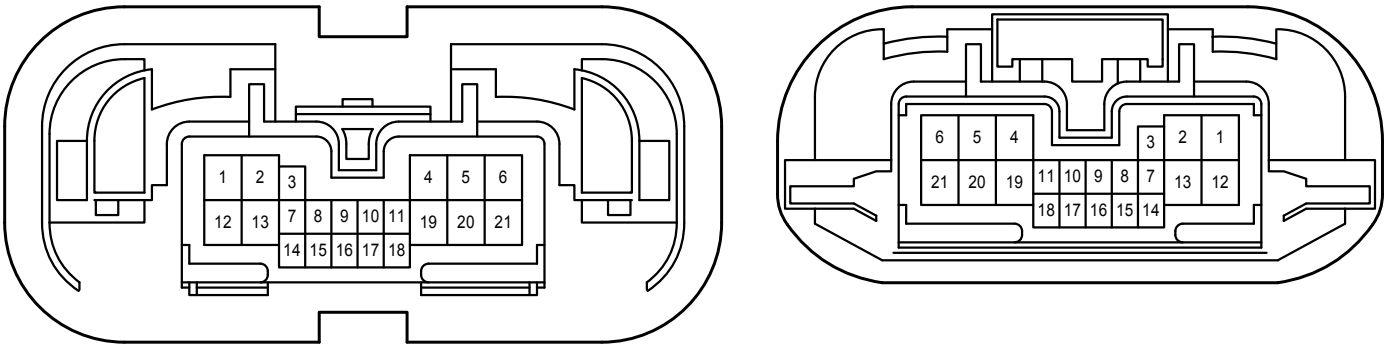

OQ1
White

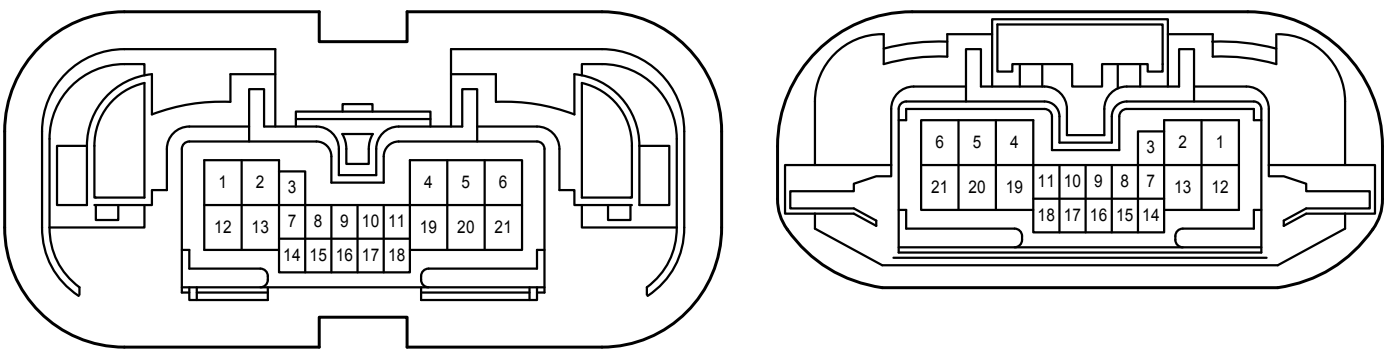

PZ1
White

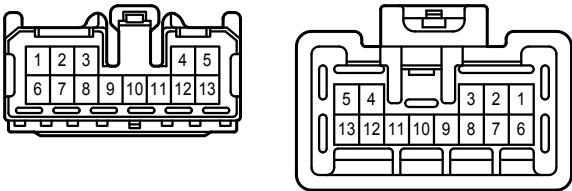

QY1
White

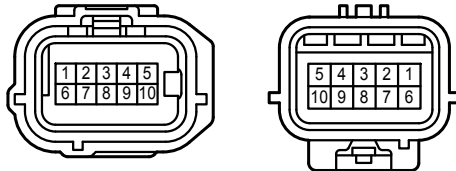

QY2
White

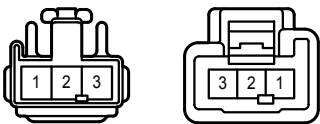

Ground Point

RA1
White

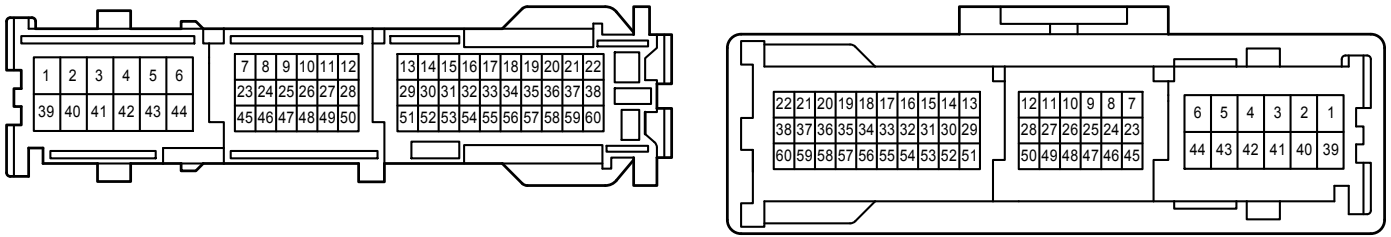

RA2
White

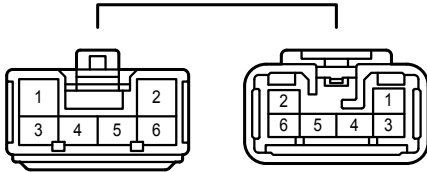

RA4
White

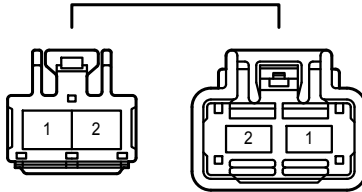

RV1
Gray

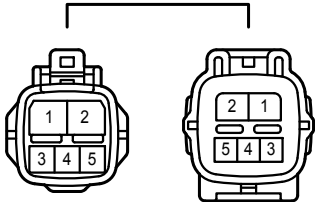

TJ1
White

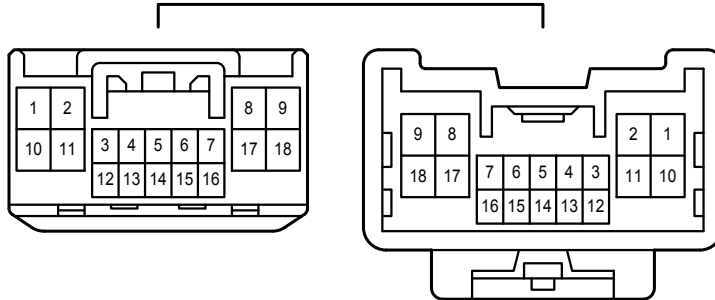

ZU1
White

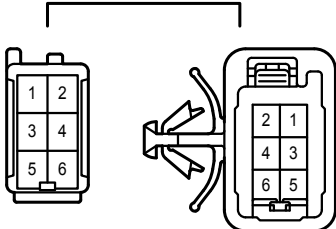

Headlight Beam Level Control

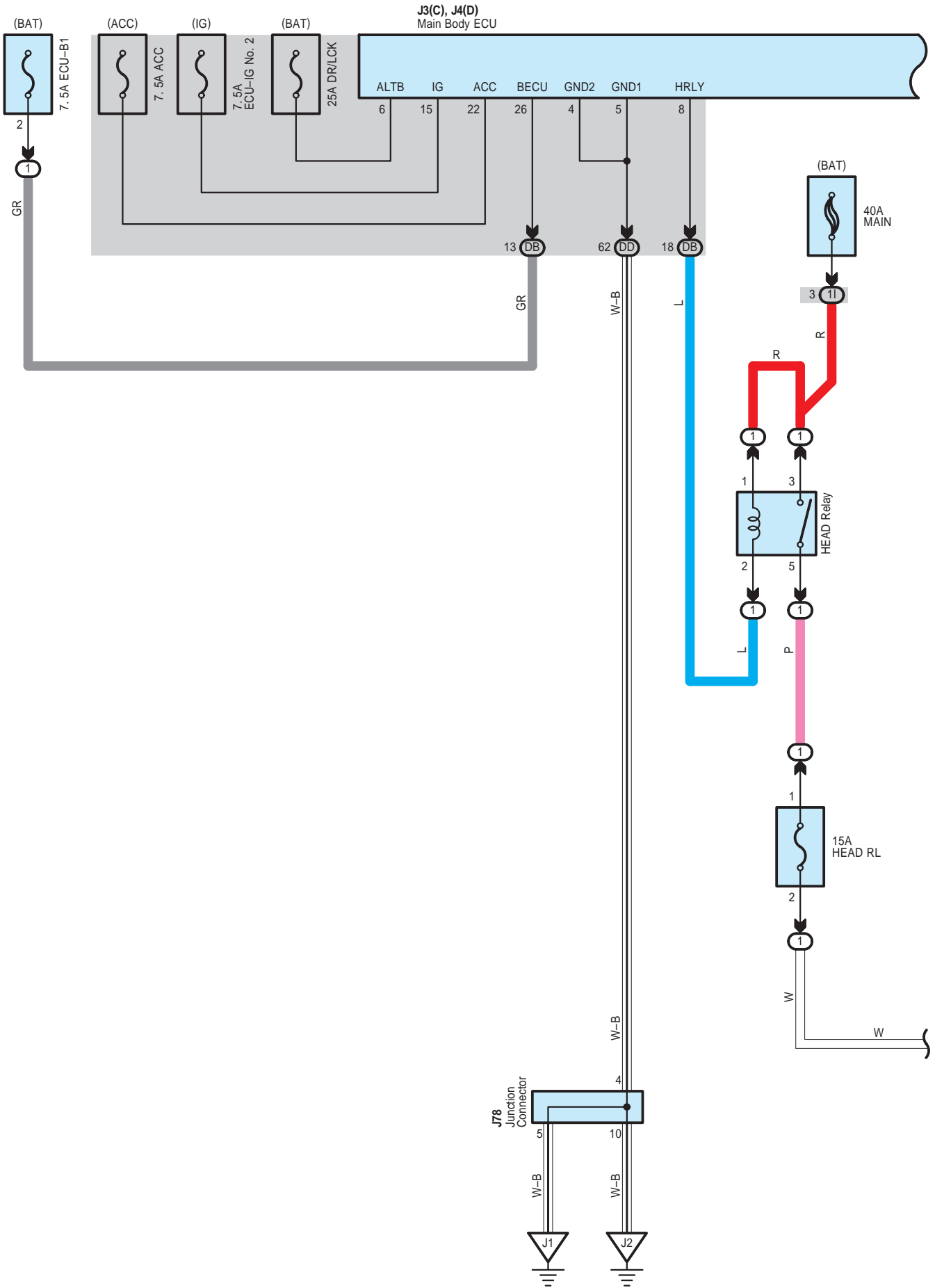

Headlight Beam Level Control

J3(C), J4(D)
Main Body ECU

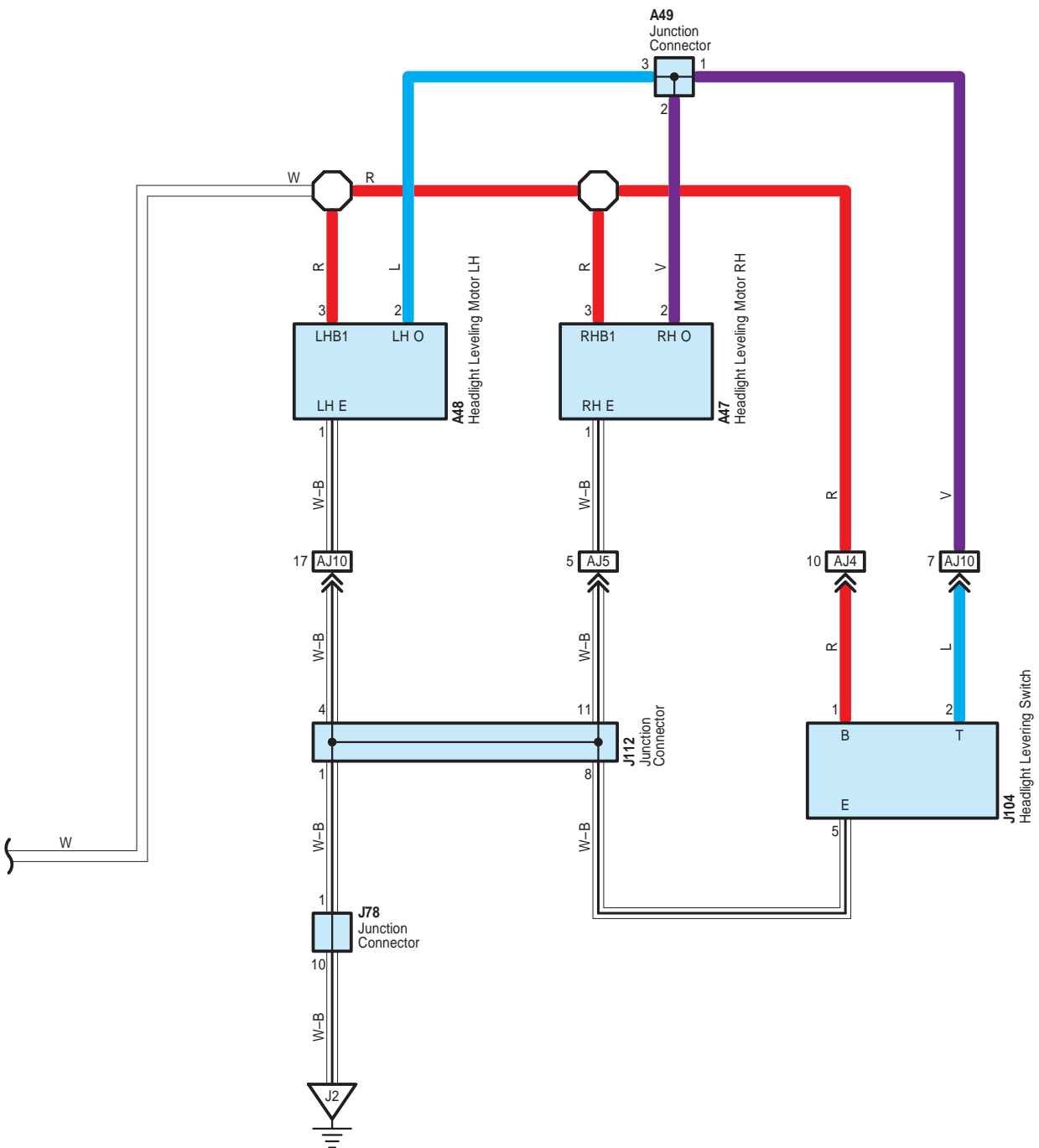

Headlight Beam Level Control

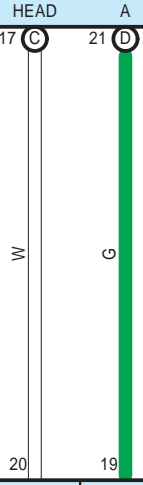
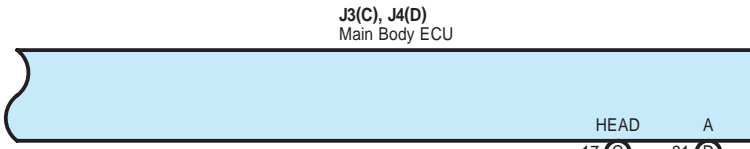

		EL	T	H	A
Light Control Switch	OFF				
	Tail	○	○		
	Head	○	○	○	
	AUTO	○			○

J10
Headlight Dimmer Switch Assembly

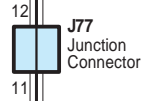

Headlight Beam Level Control

A 47

Black



A 48

Black

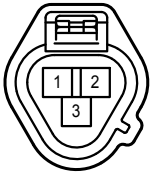

A 49

White

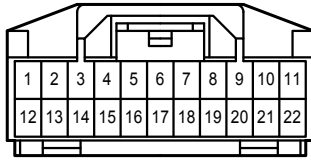

J 3

White

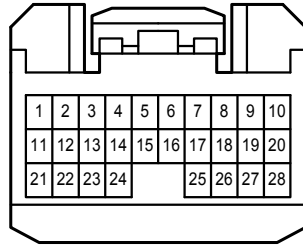

J 4

White

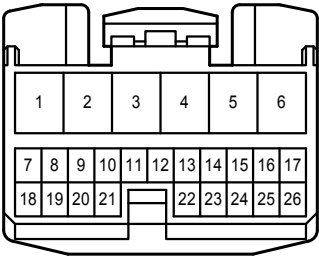

J 10

White

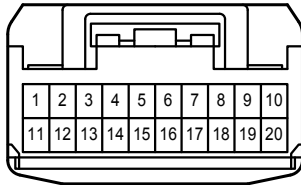

J 77

Gray

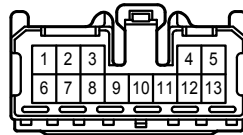

J 78

White

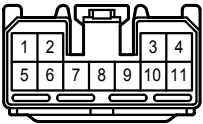

J104

Black

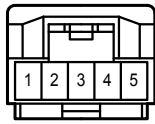

J112

White

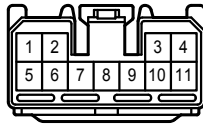

11

White

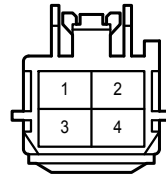

DB

White

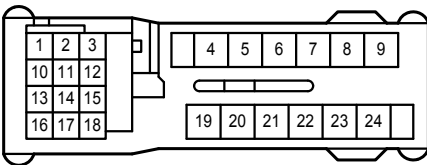

DD

White

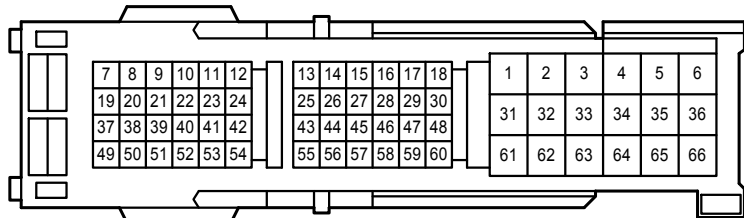

AJ4

White

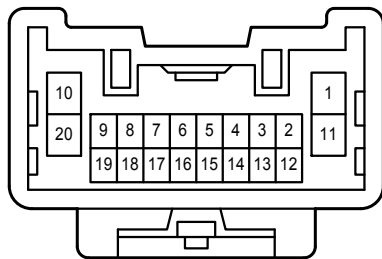
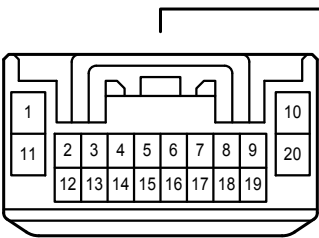

Headlight Beam Level Control

AJ5
White

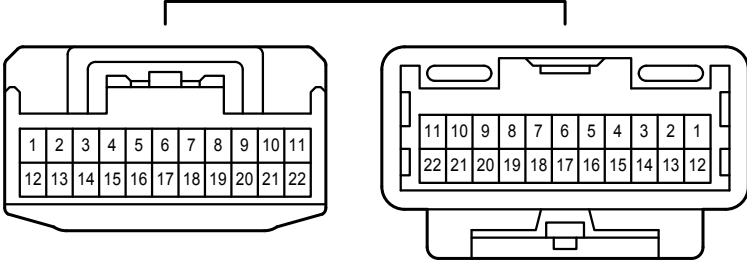

AJ10
Gray

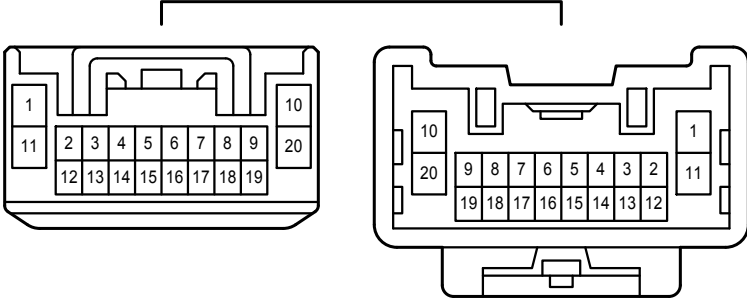

Headlight

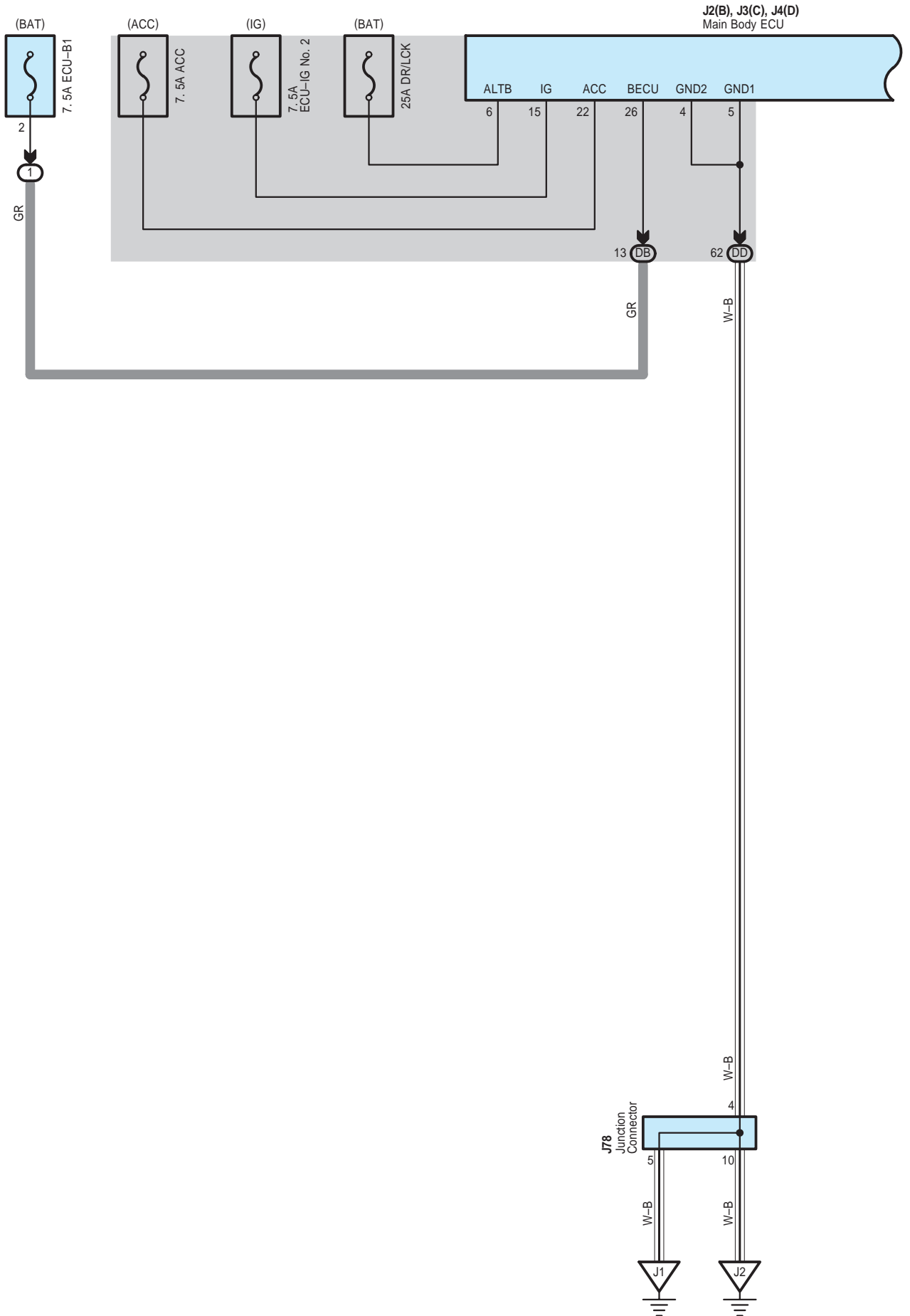

Headlight

J2(B), J3(C), J4(D)
Main Body ECU

A24(A), D74(B)
Engine Control Module

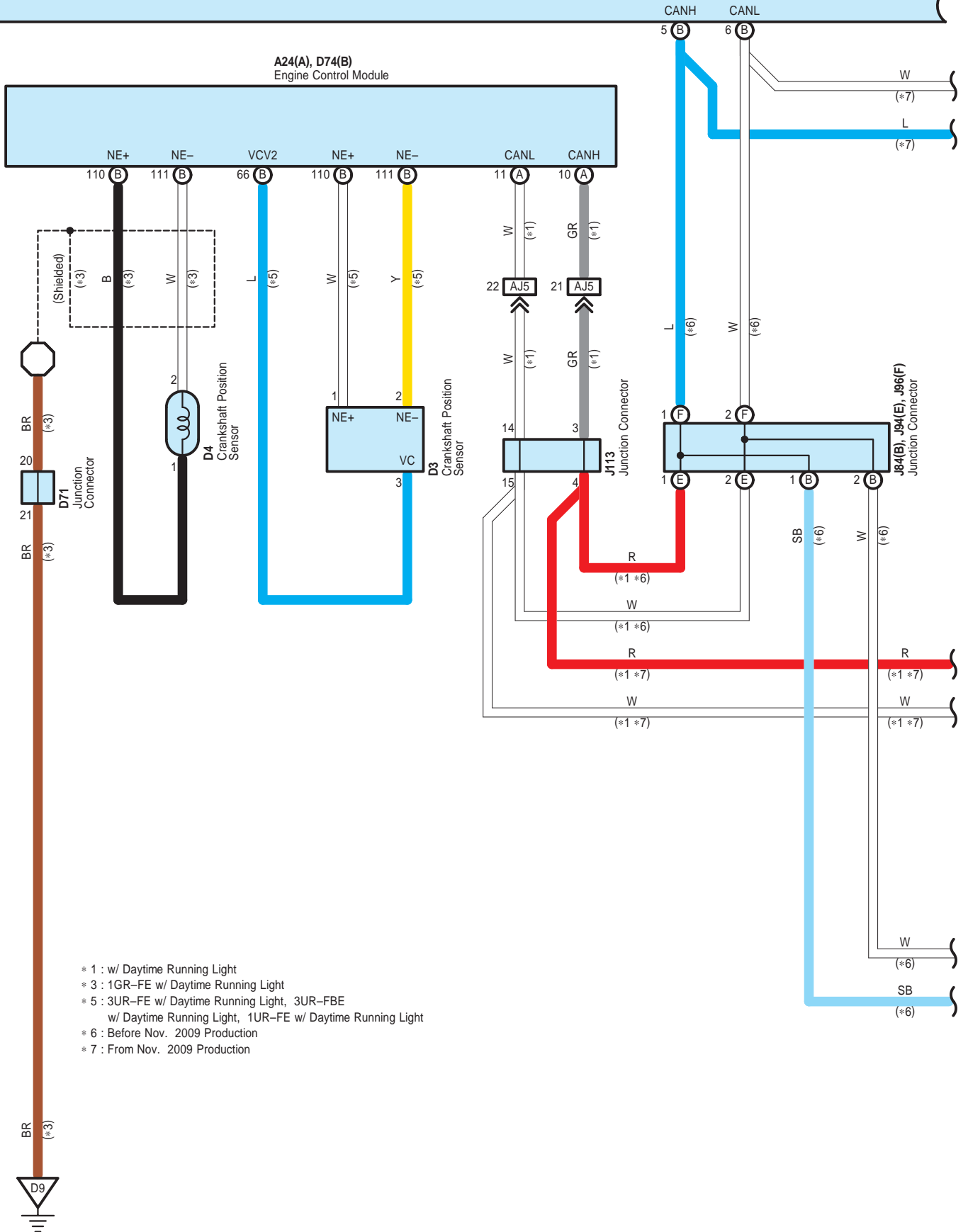

- * 1 : w/ Daytime Running Light
- * 3 : 1GR-FE w/ Daytime Running Light
- * 5 : 3UR-FE w/ Daytime Running Light, 3UR-FBE w/ Daytime Running Light, 1UR-FE w/ Daytime Running Light
- * 6 : Before Nov. 2009 Production
- * 7 : From Nov. 2009 Production

Headlight

J2(B), J3(C), J4(D)
Main Body ECU

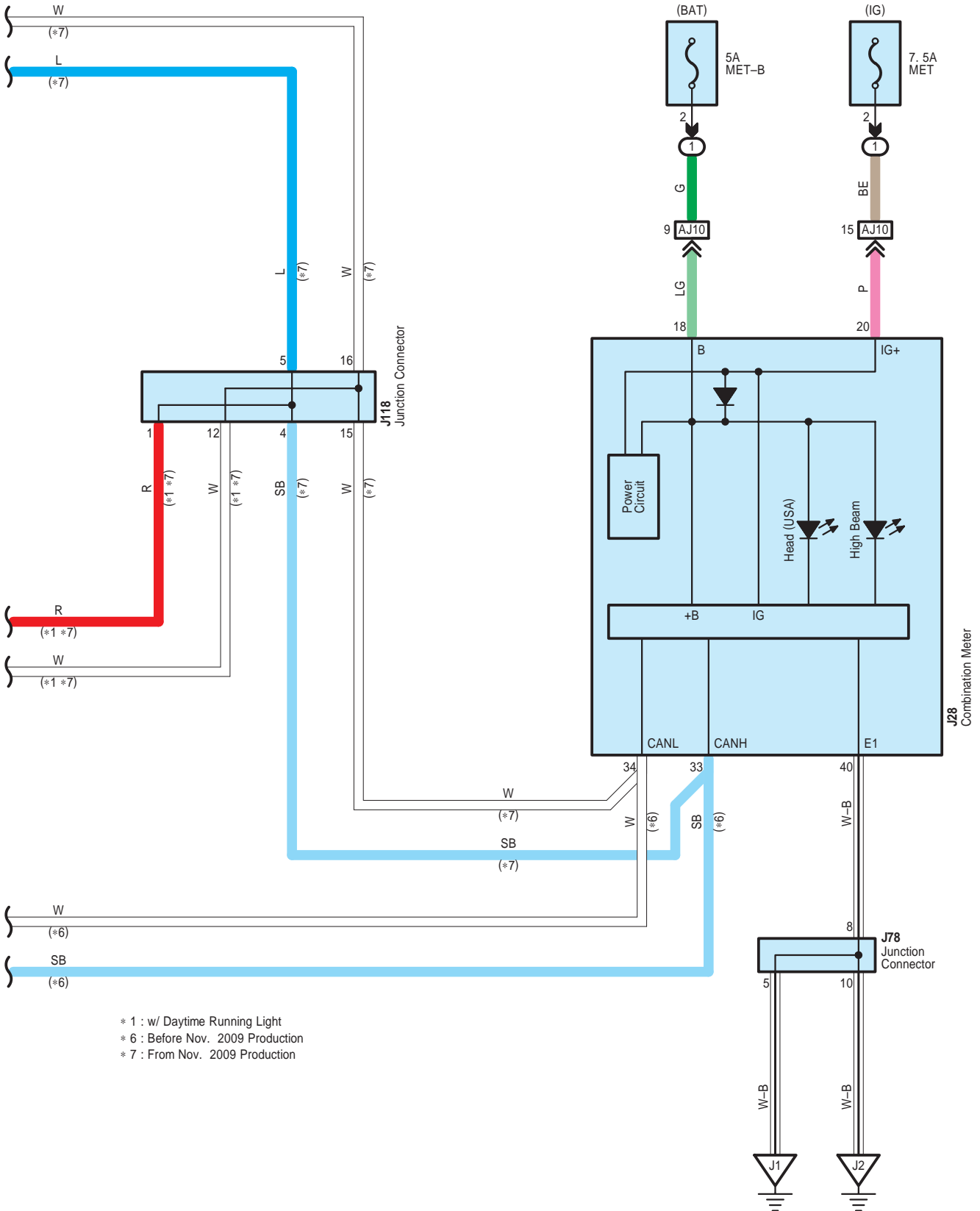

- * 1 : w/ Daytime Running Light
- * 6 : Before Nov. 2009 Production
- * 7 : From Nov. 2009 Production

Headlight

J2(B), J3(C), J4(D)
Main Body ECU

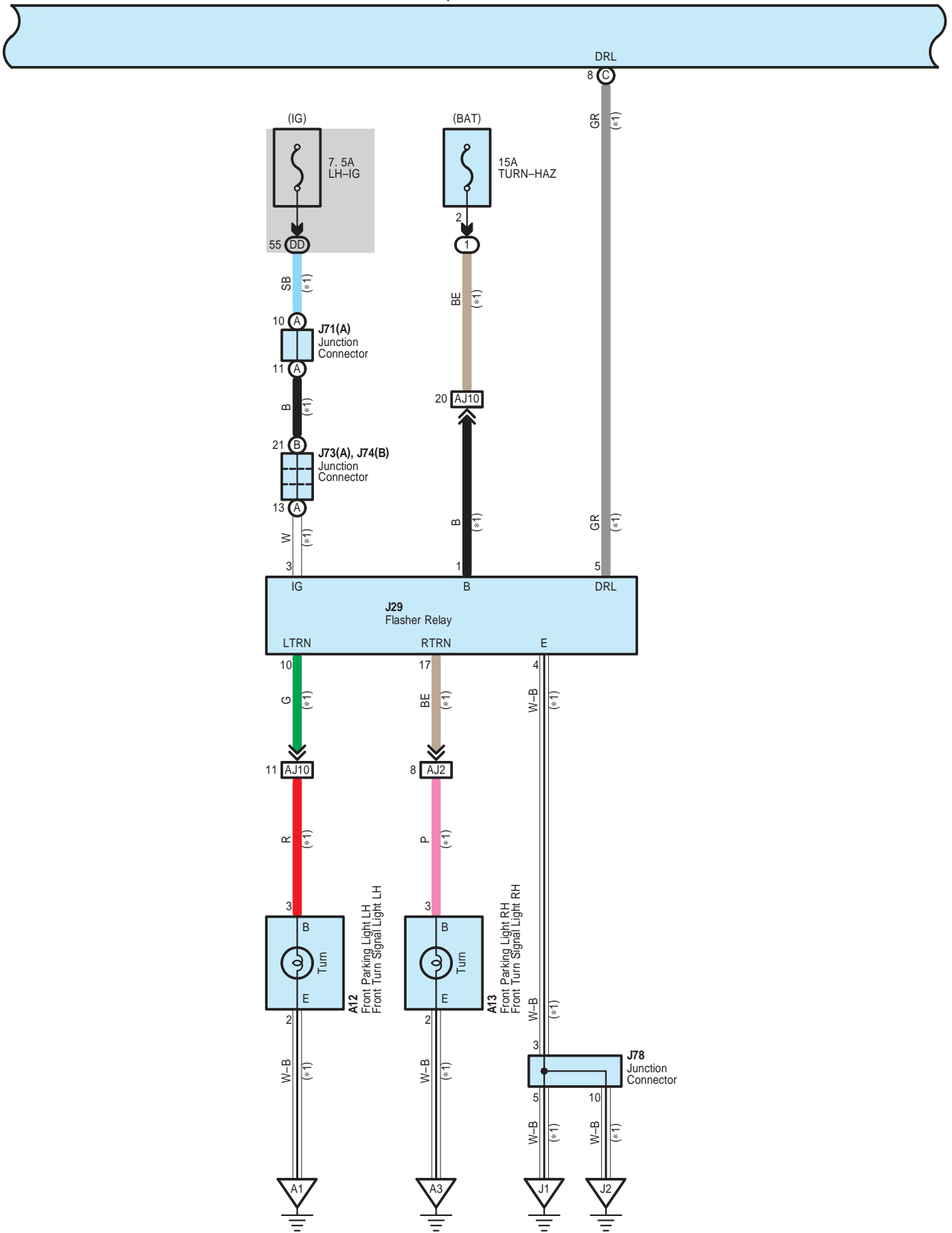

Headlight

J2(B), J3(C), J4(D)
Main Body ECU

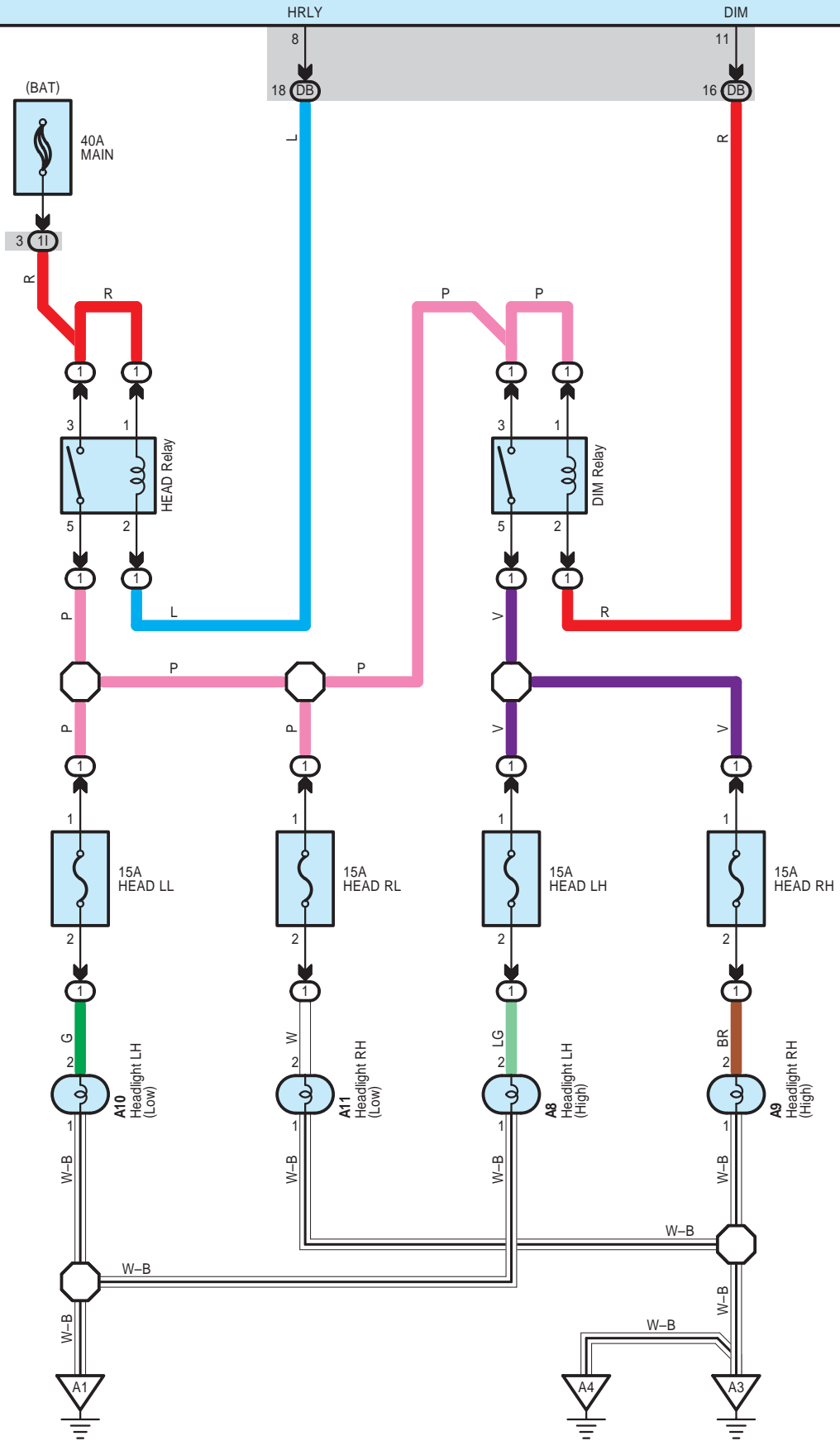

Headlight

J2(B), J3(C), J4(D)
Main Body ECU

* 1 : w/ Daytime Running Light
* 4 : w/ Seat Position Memory

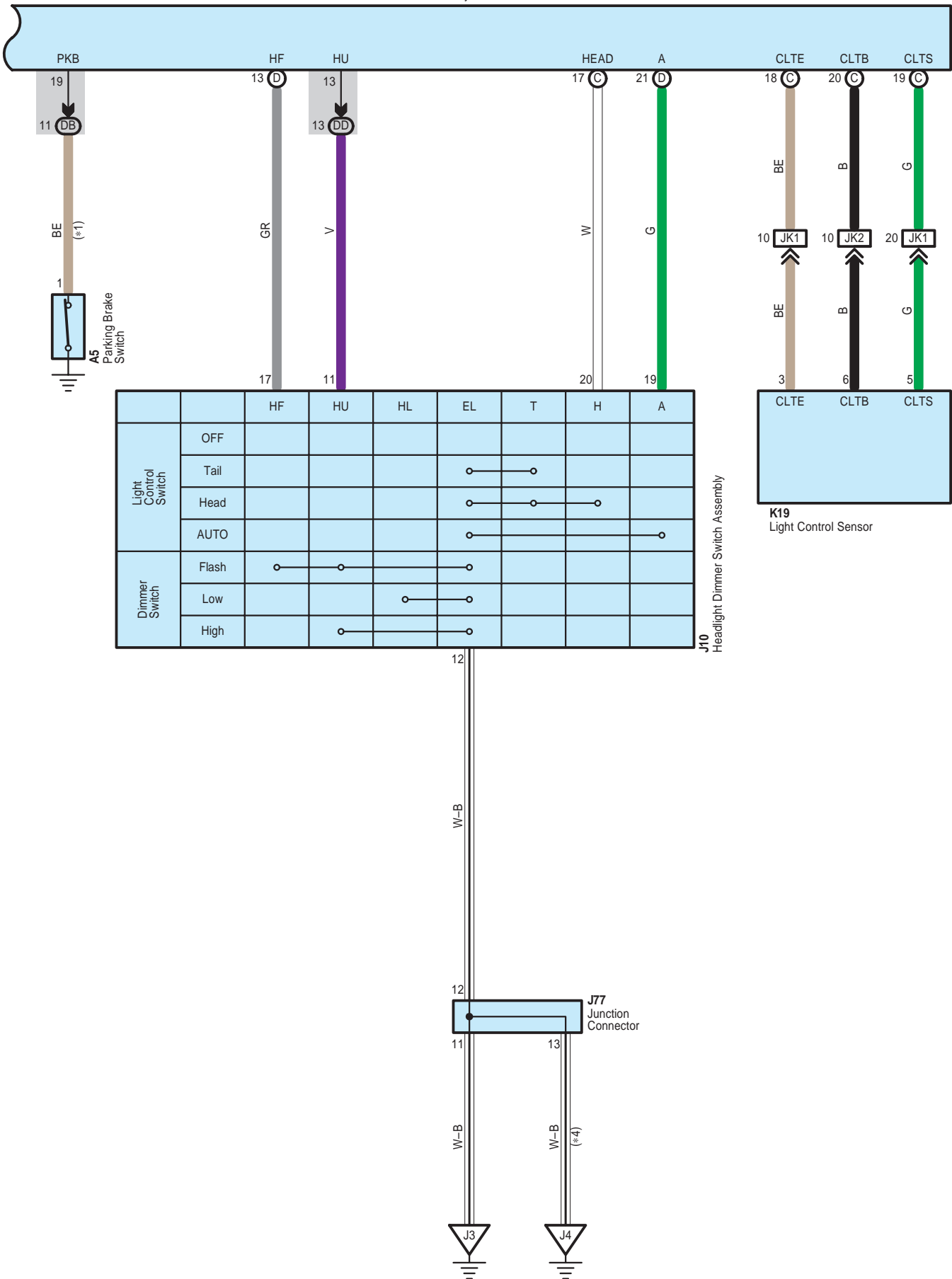

Headlight

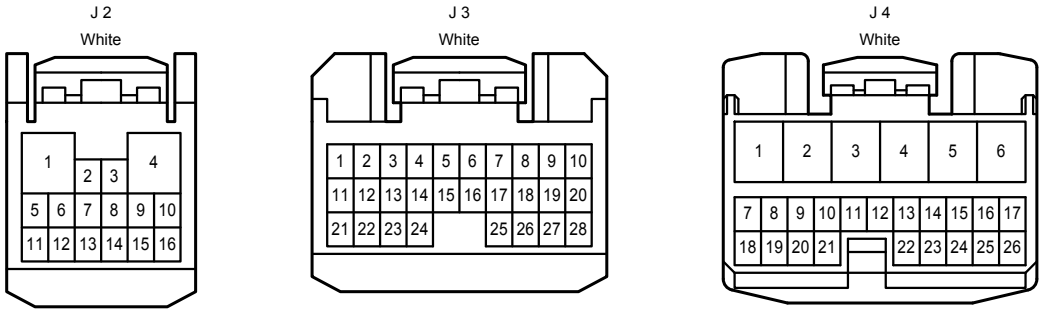
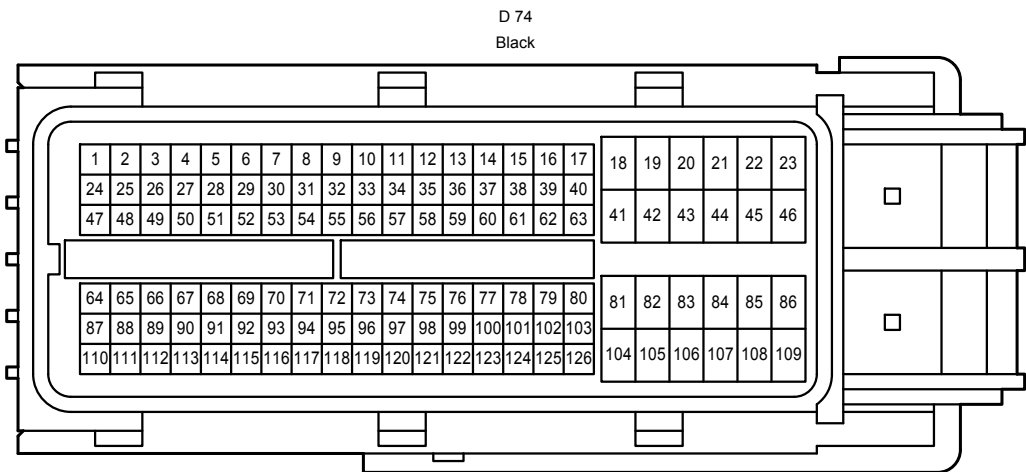
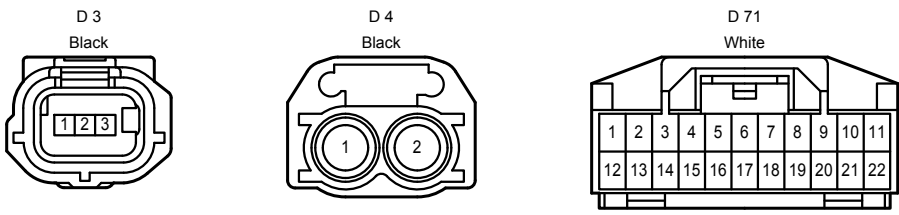
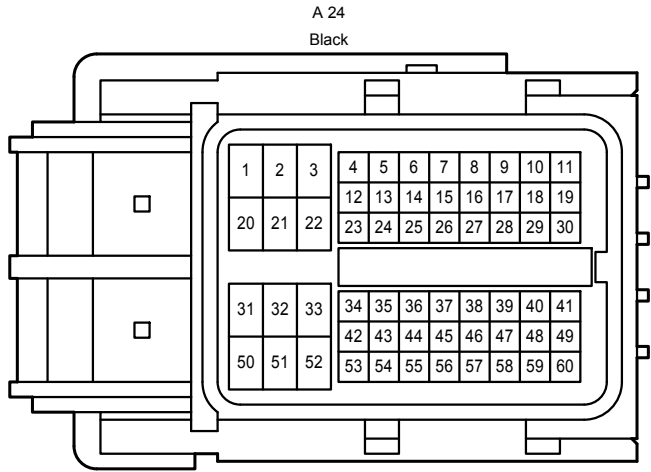
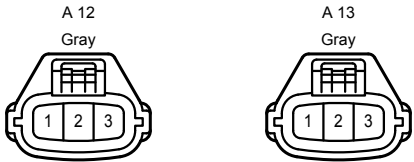
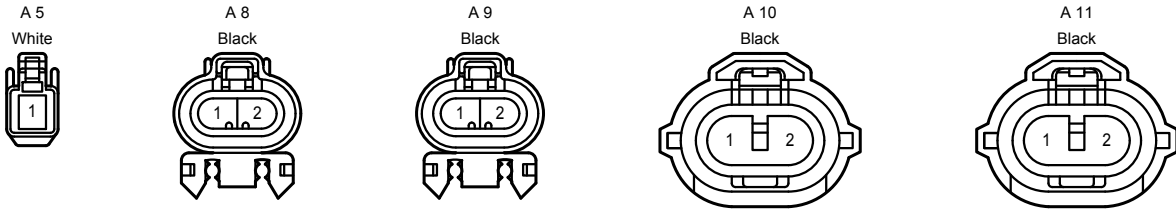

Headlight

J 10
White

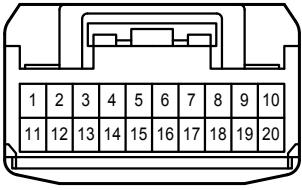

J 28
White

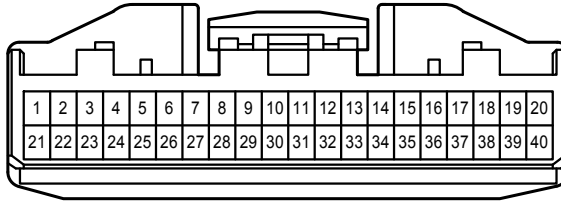

J 29
White

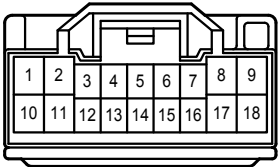

J 71
Black

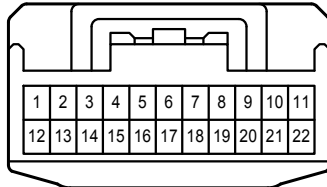

J 73
Black

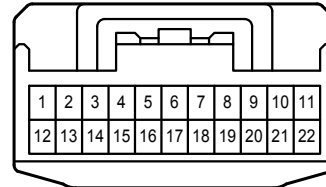

J 74
Black

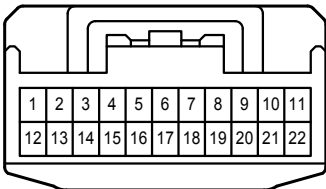

J 77
Gray

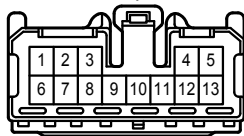

J 78
White

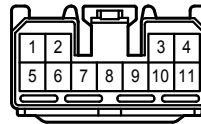

J 84
White

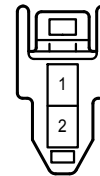

J 94
White

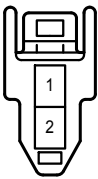

J 96
White

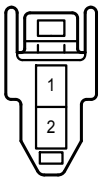

J113
Gray

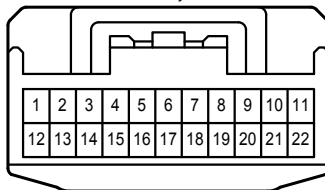

J118
Gray

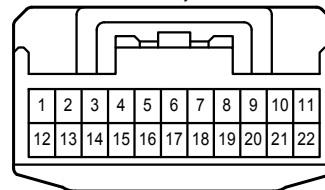

K 19
Black

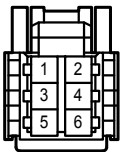

11
White

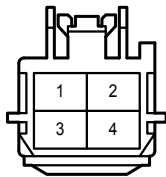

DB
White

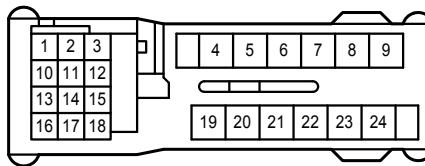

DD
White

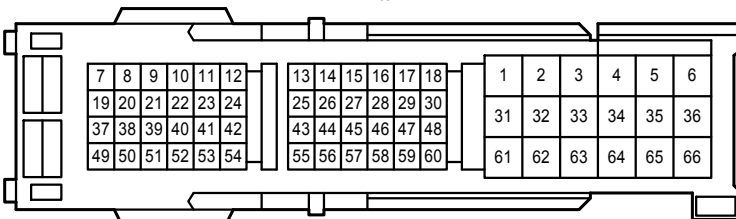

AJ2
White

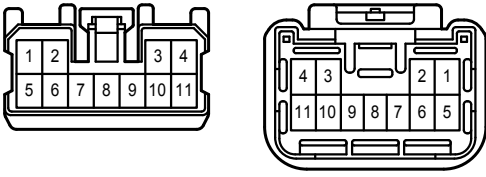

AJ5
White

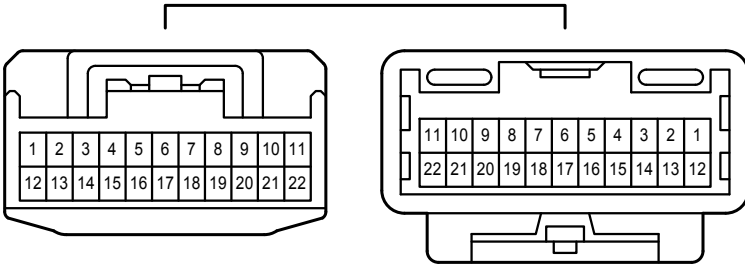

AJ10
Gray

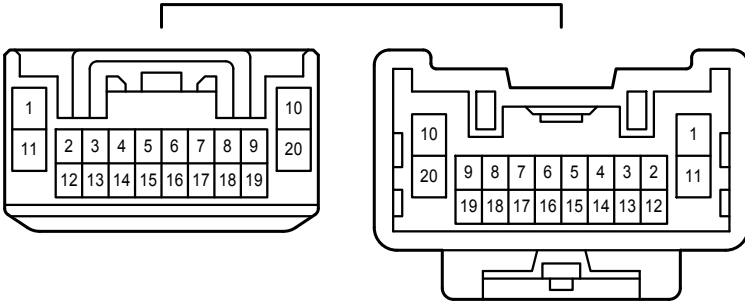

JK1
White

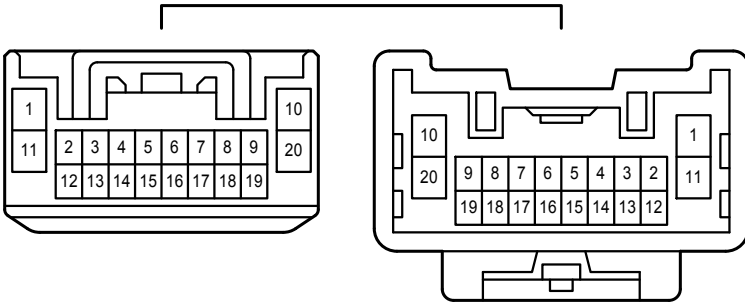

JK2
White

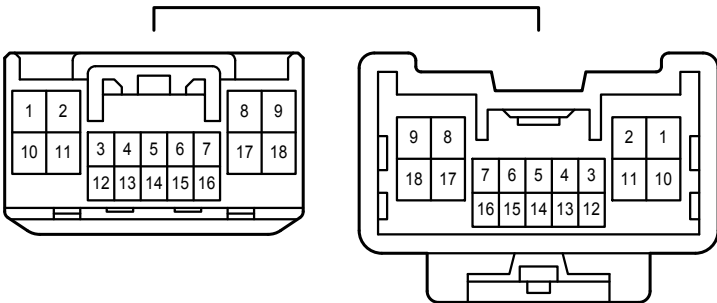

Horn

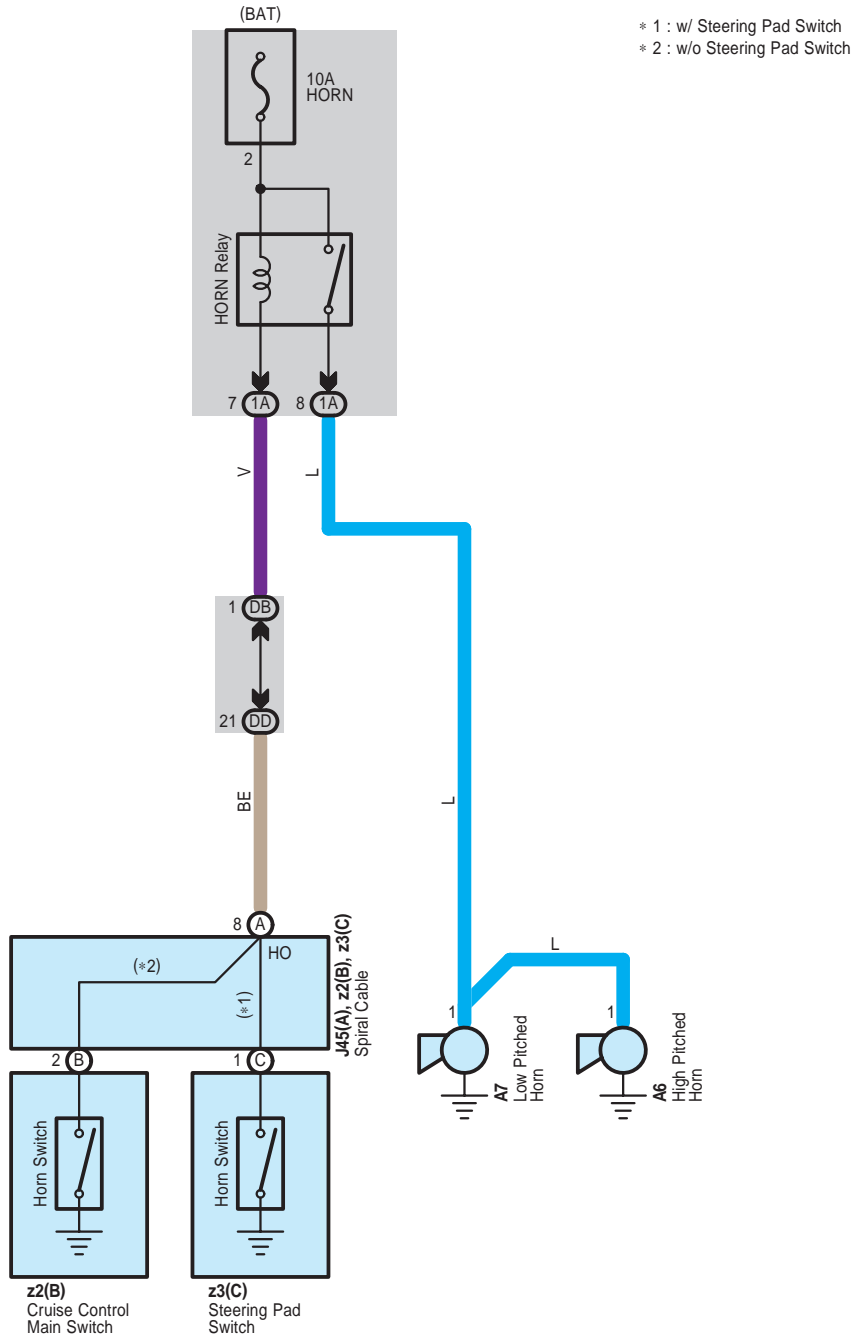

Horn

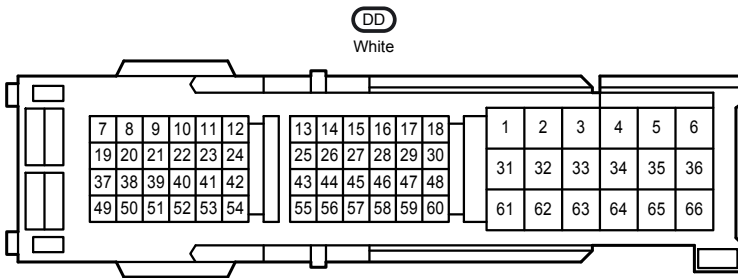
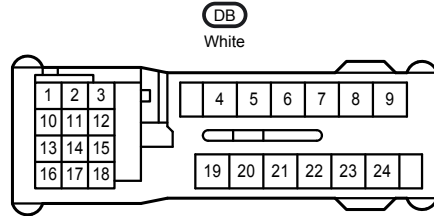
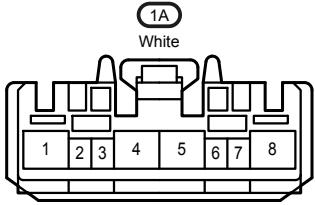
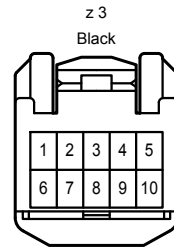
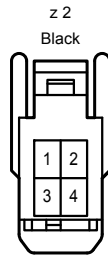
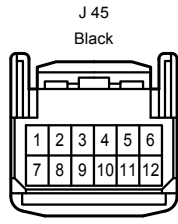
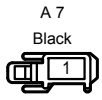
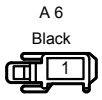

Ignition <1GR-FE>

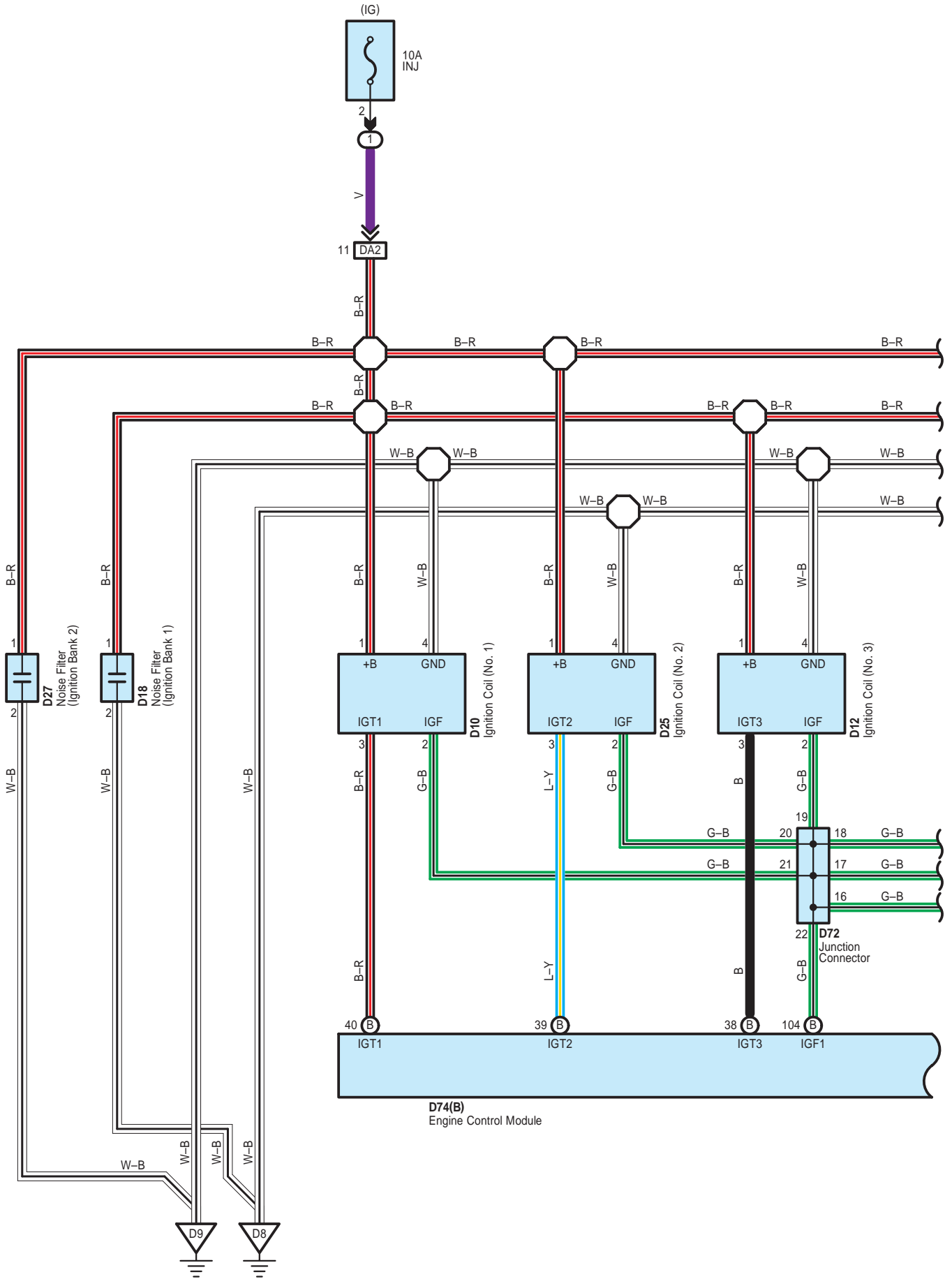

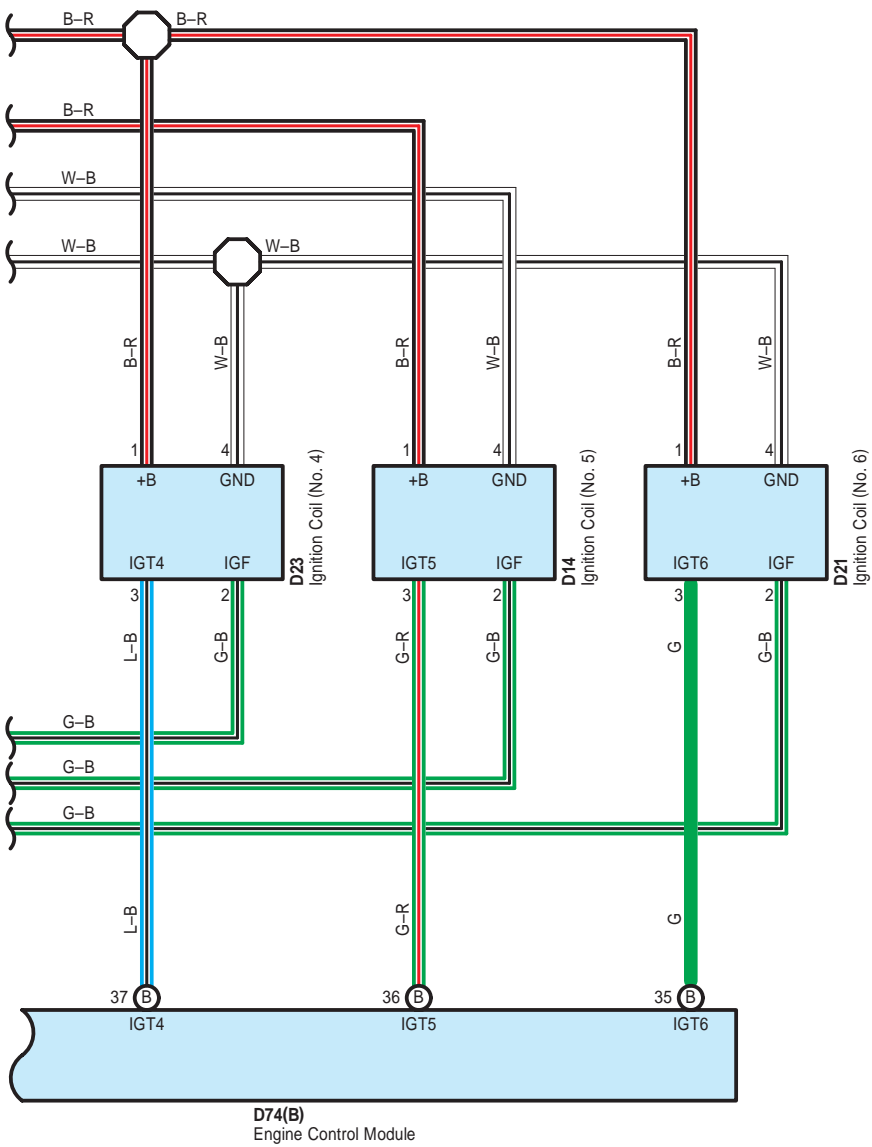

Ignition <1GR-FE>

D 10

Black

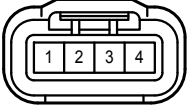

D 12

Black

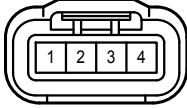

D 14

Black

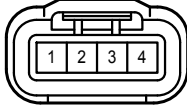

D 18

Gray



D 21

Black

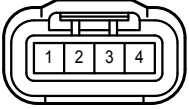

D 23

Black

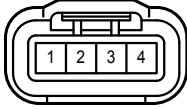

D 25

Black

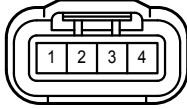

D 27

Gray



D 72

White

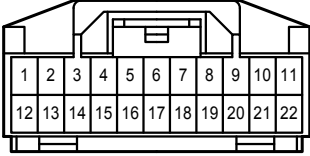

D 74

Black

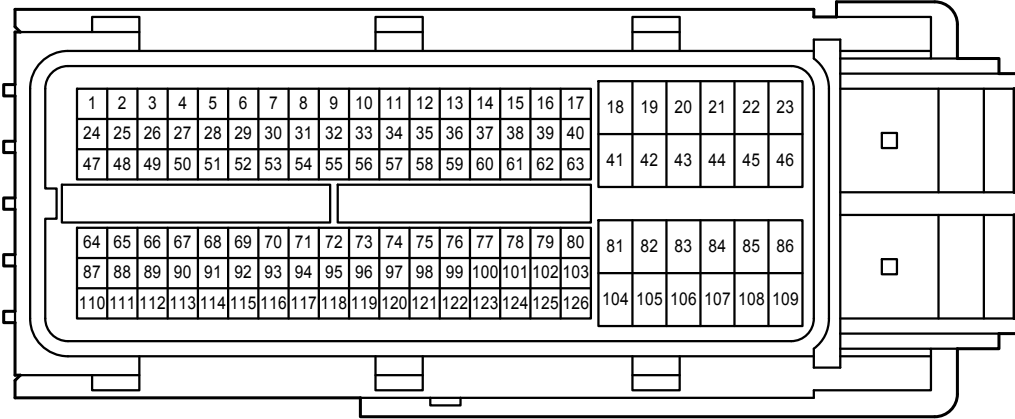

DA2

White

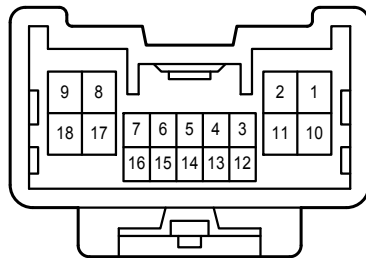
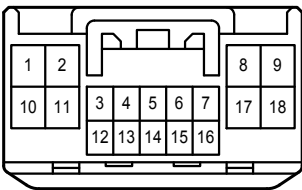

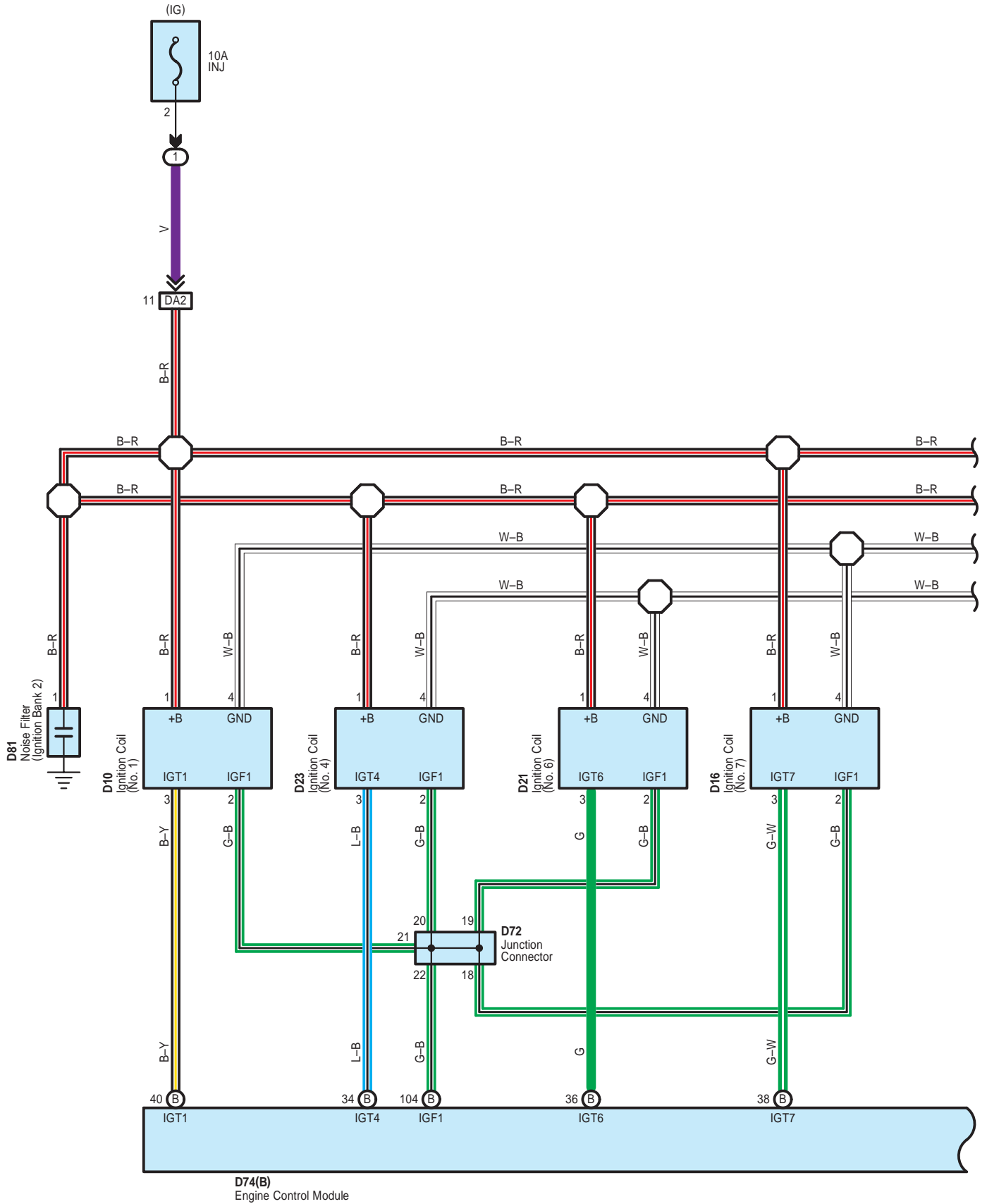

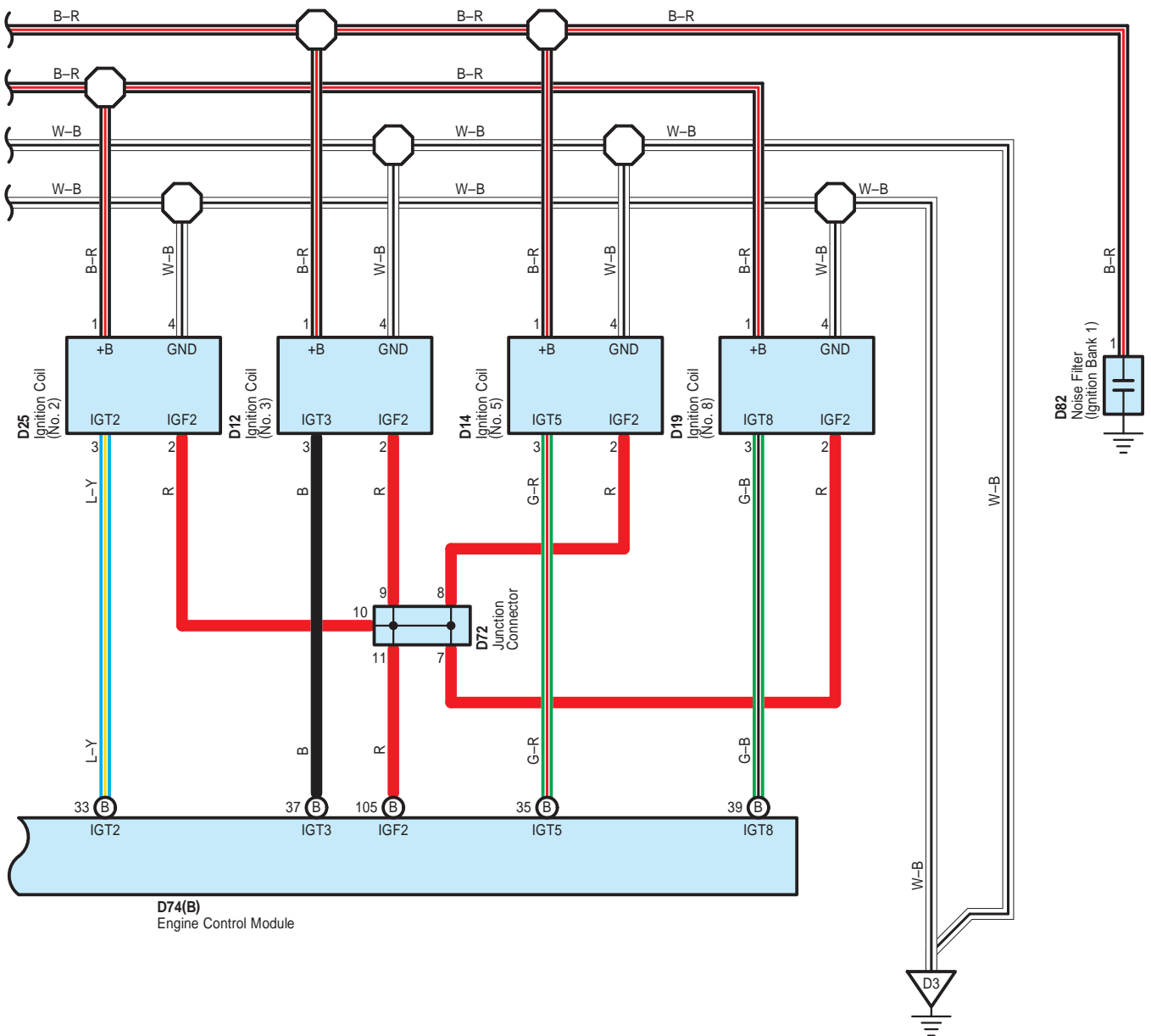

Ignition <1UR-FE>

D 10

Black

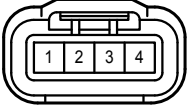

D 12

Black

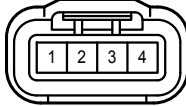

D 14

Black

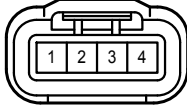

D 16

Black

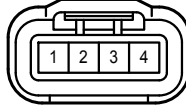

D 19

Black

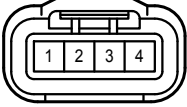

D 21

Black

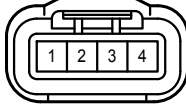

D 23

Black

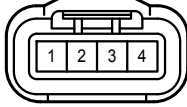

D 25

Black

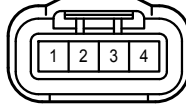

D 72

White

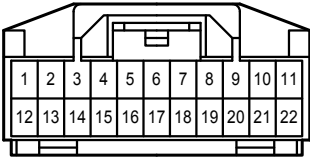

D 74

Black

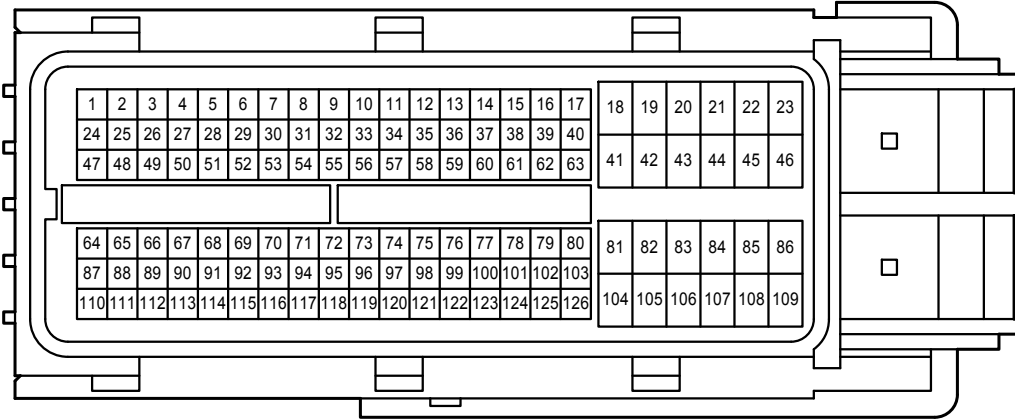

D 81

Gray

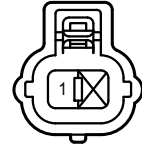

D 82

Gray

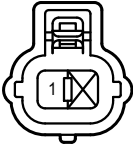

DA2

White

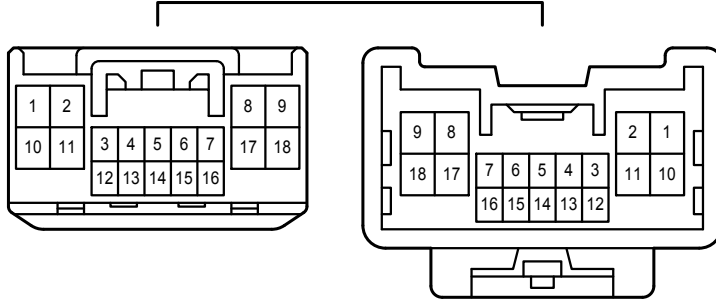

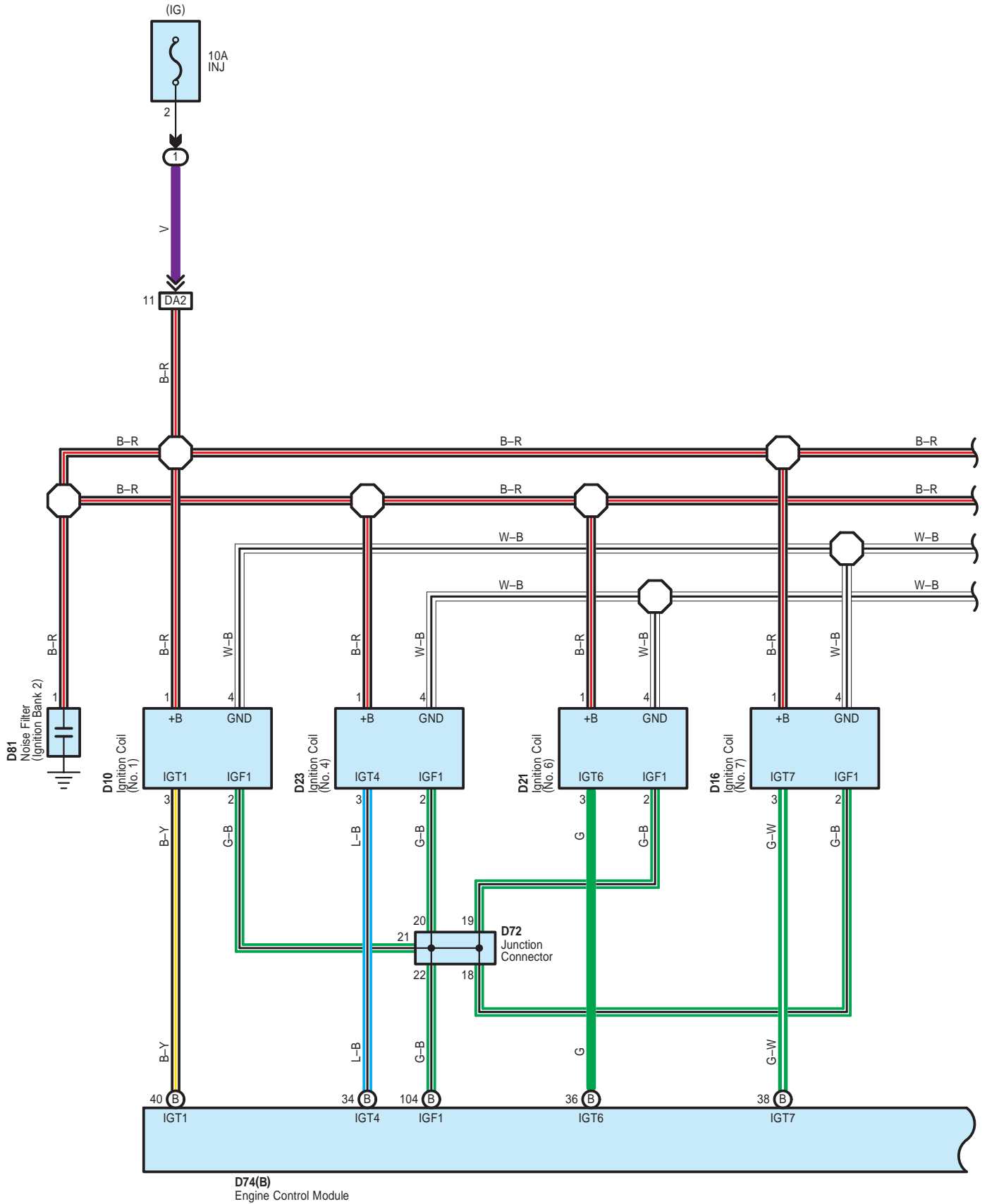

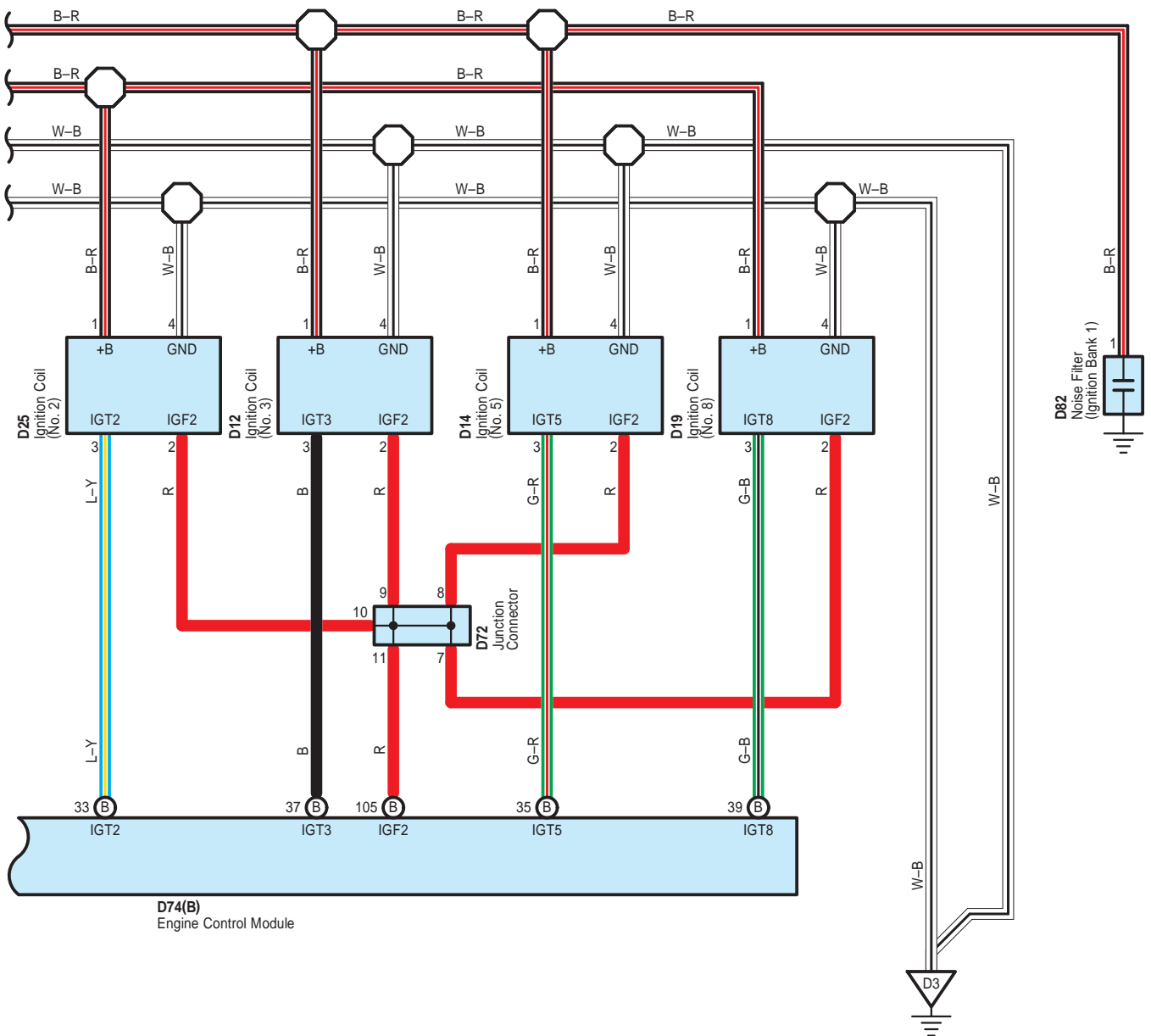

Ignition <3UR-FE, 3UR-FBE>

D 10

Black

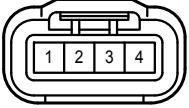

D 12

Black

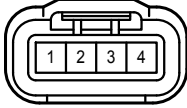

D 14

Black

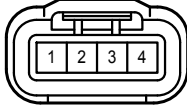

D 16

Black

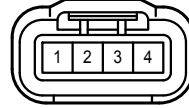

D 19

Black

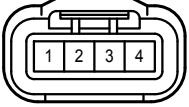

D 21

Black

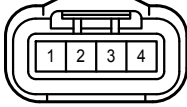

D 23

Black

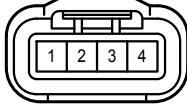

D 25

Black

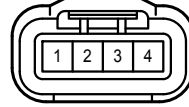

D 72

White

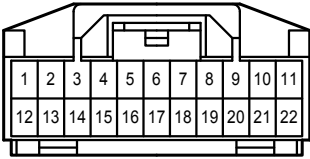

D 74

Black

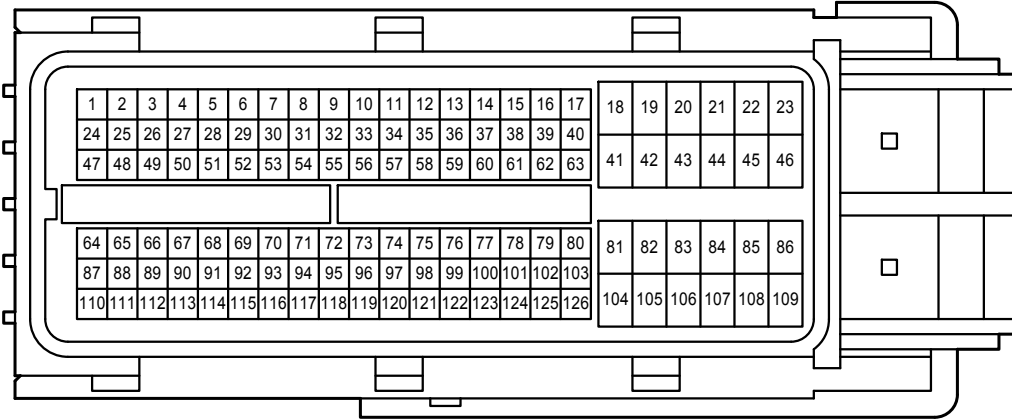

D 81

Gray

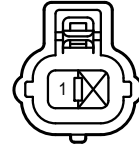

D 82

Gray

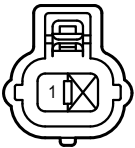

DA2

White

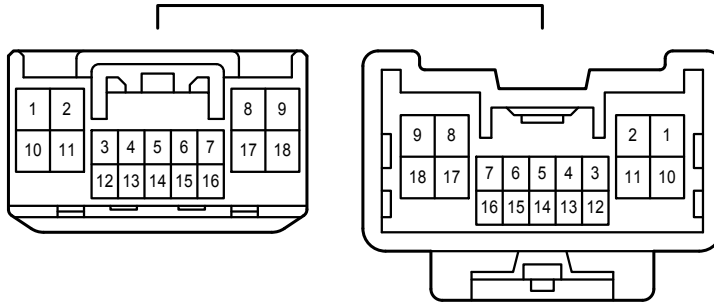

Illumination

*12 : Before Nov. 2009 Production
 *14 : w/ Curtain Airbag Cutoff Switch

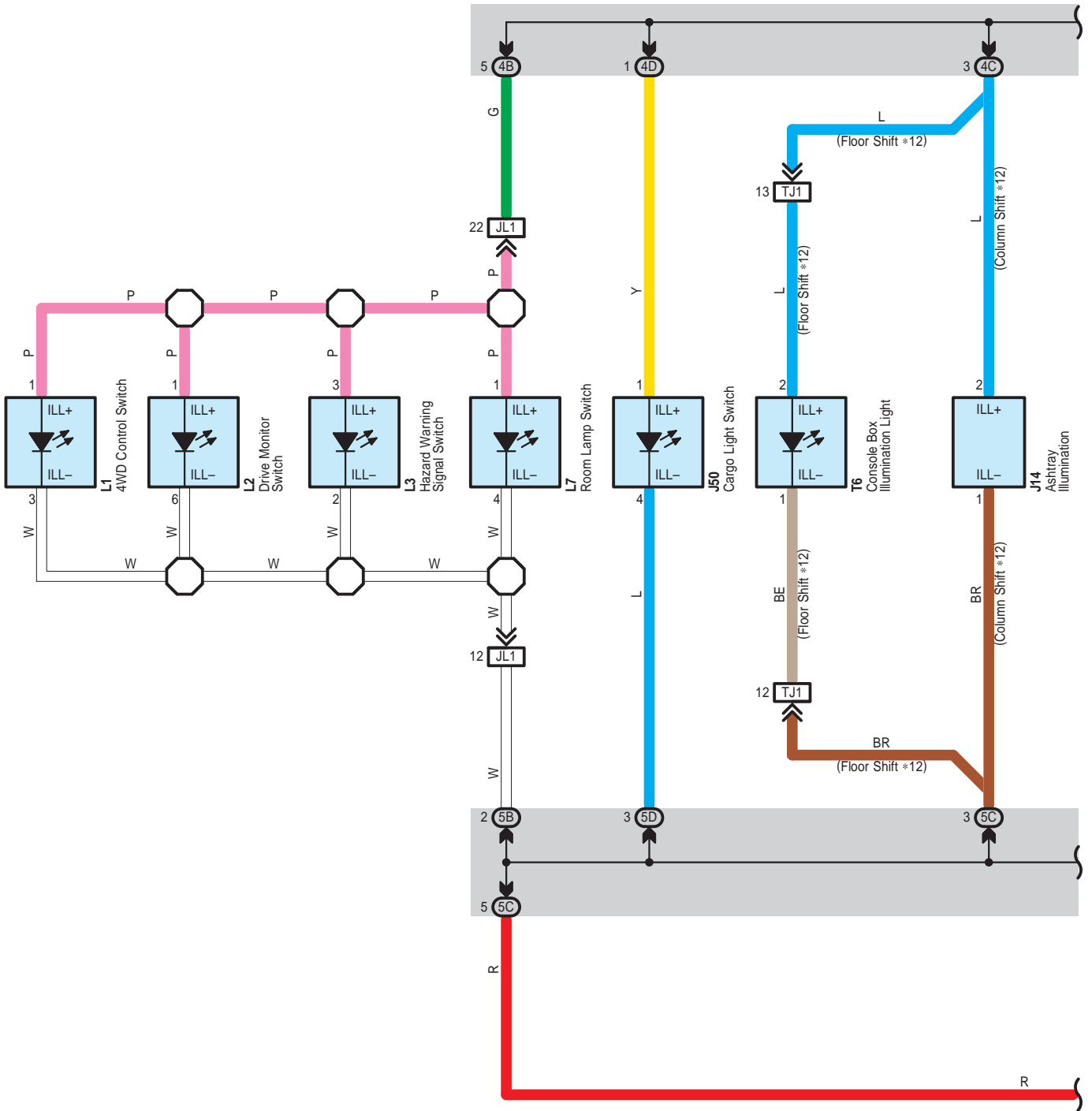

Illumination

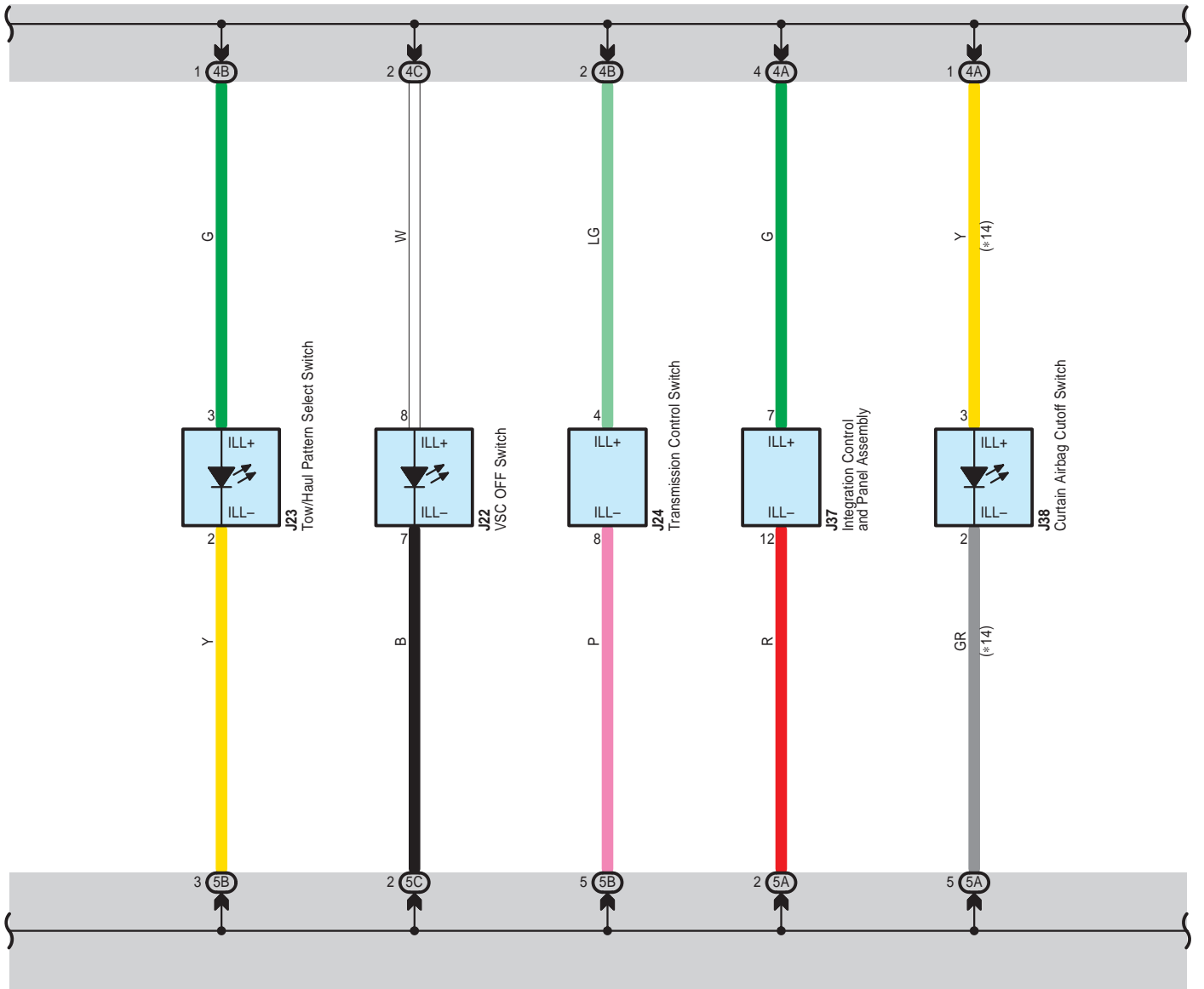

Illumination

- * 9 : w/ Climate Control Seat
- *10 : w/o Climate Control Seat
- *11 : w/ Headlight Leveling

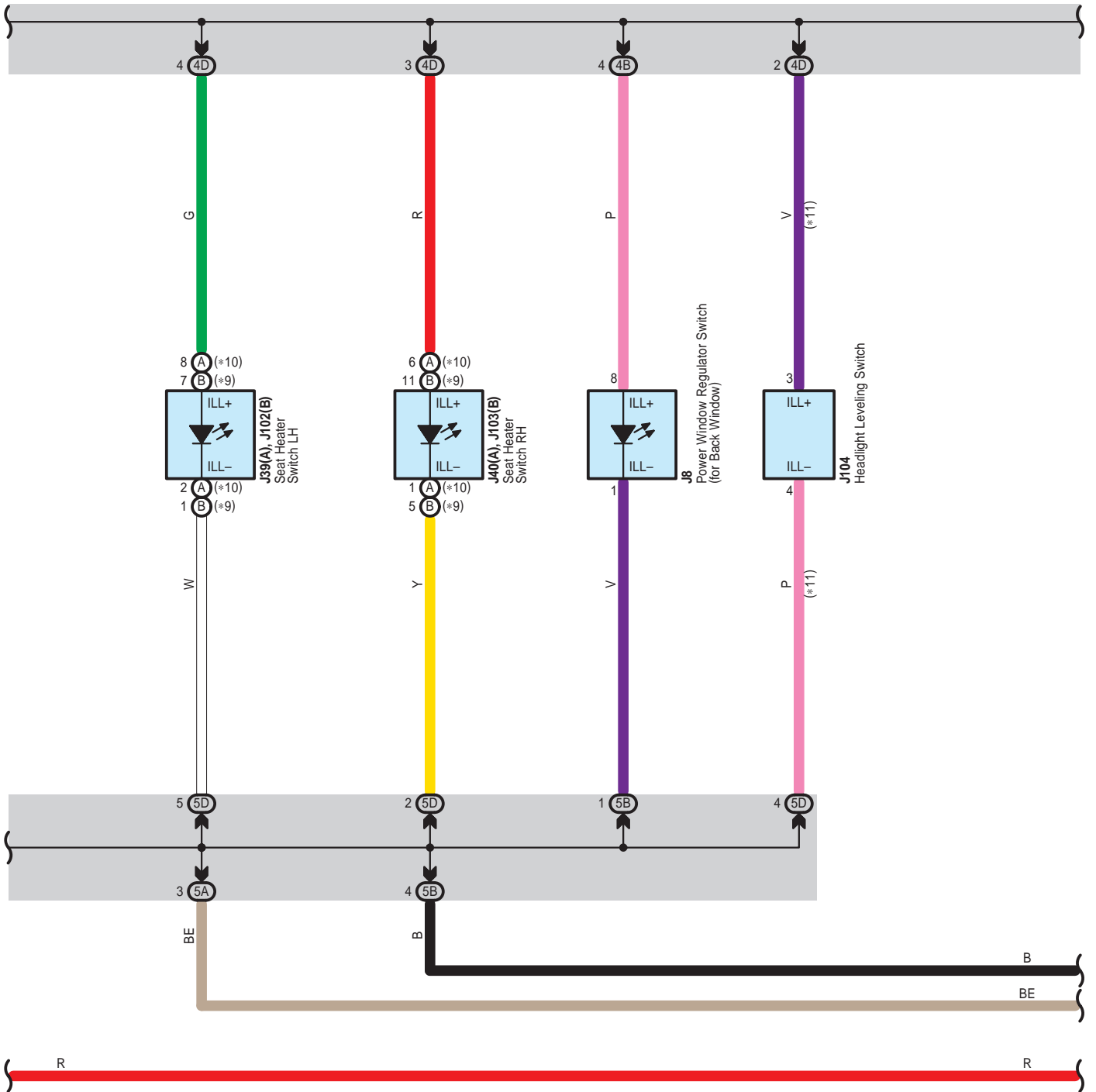

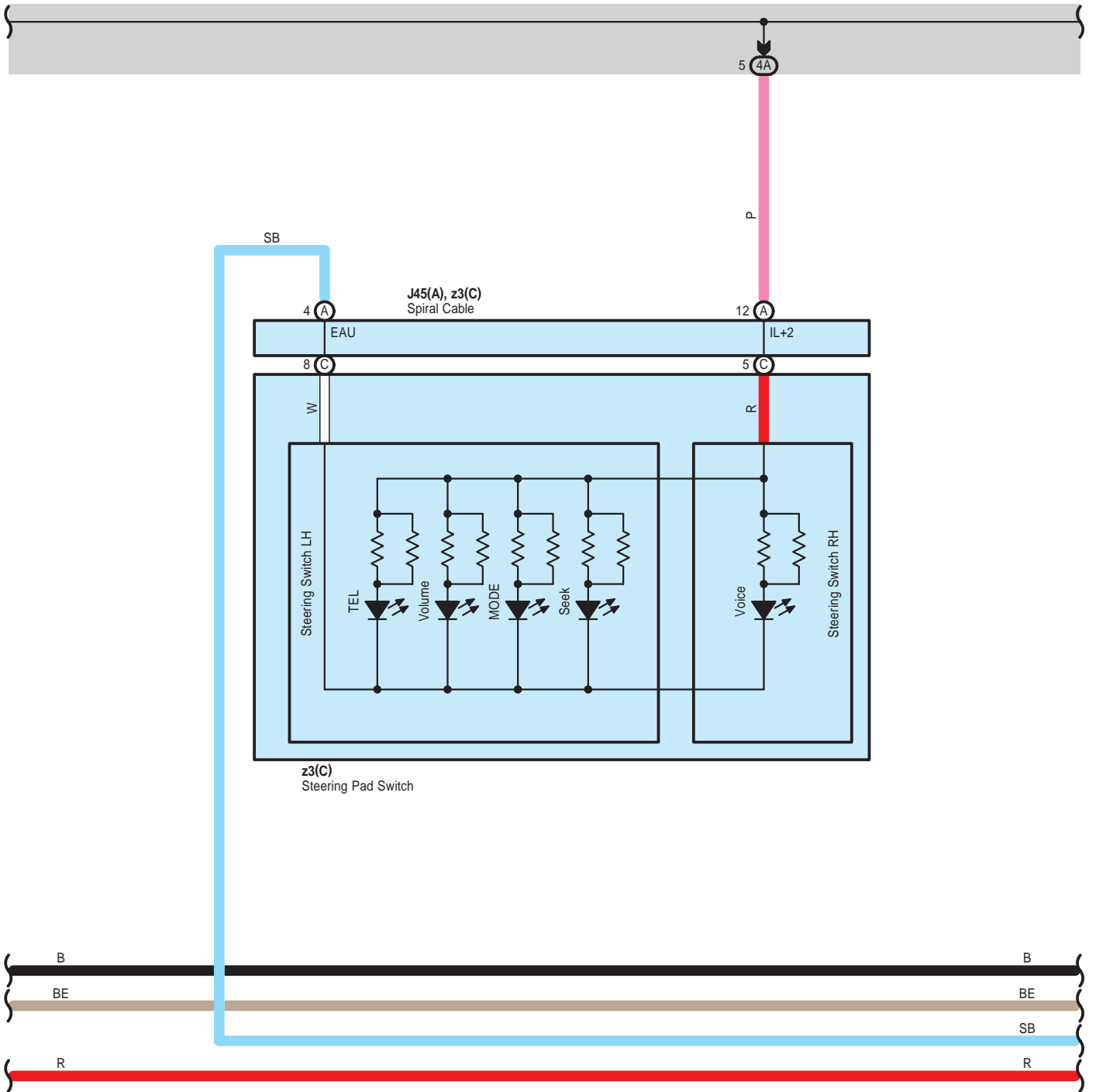

Illumination

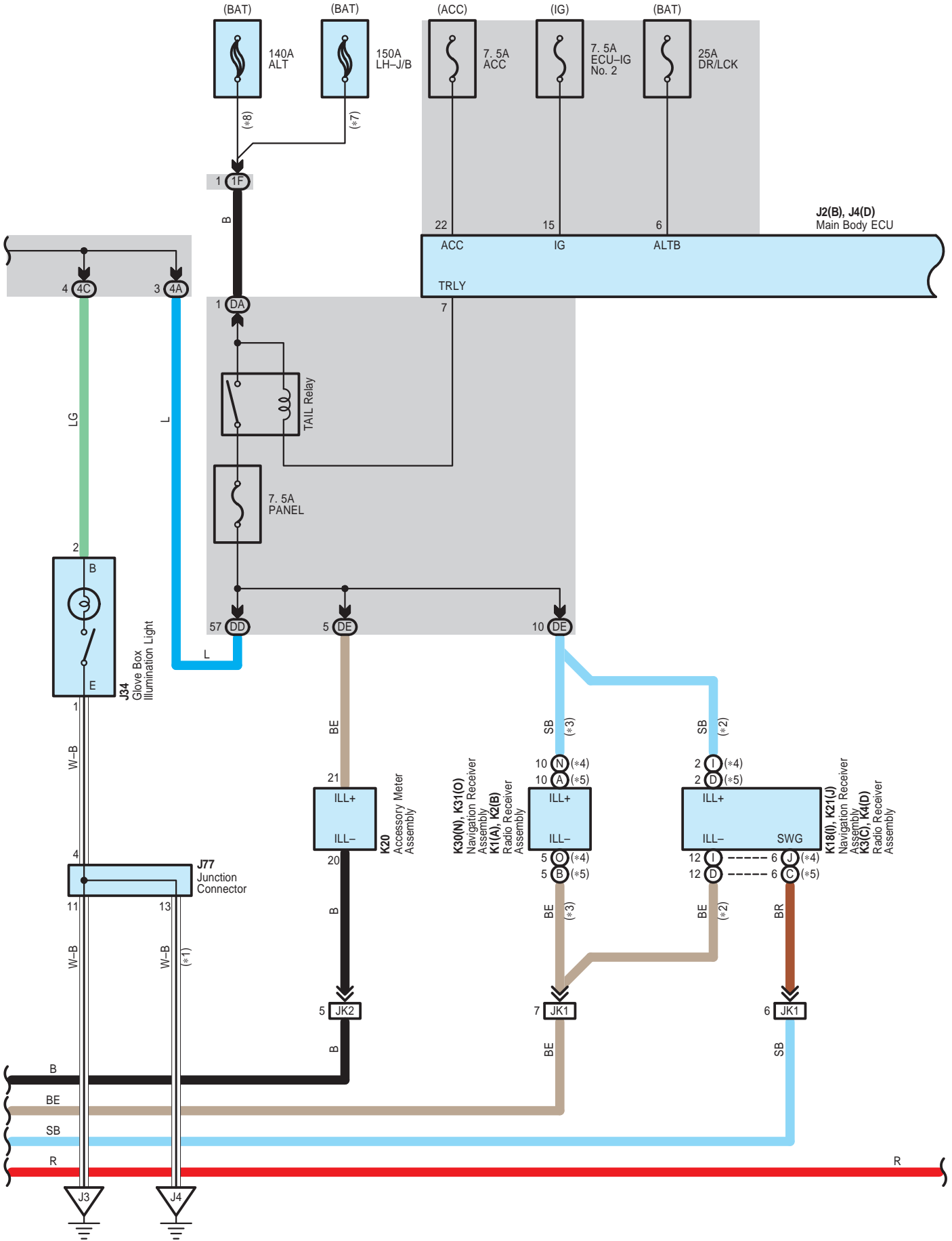

Illumination

- * 1 : w/ Seat Position Memory
- * 2 : Separate Type Amplifier
- * 3 : Built-in Type Amplifier
- * 4 : w/ Navigation System
- * 5 : w/o Navigation System
- * 7 : 3UR-FE, 3UR-FBE, 1UR-FE
- * 8 : 1GR-FE
- *12 : Before Nov. 2009 Production
- *13 : From Nov. 2009 Production

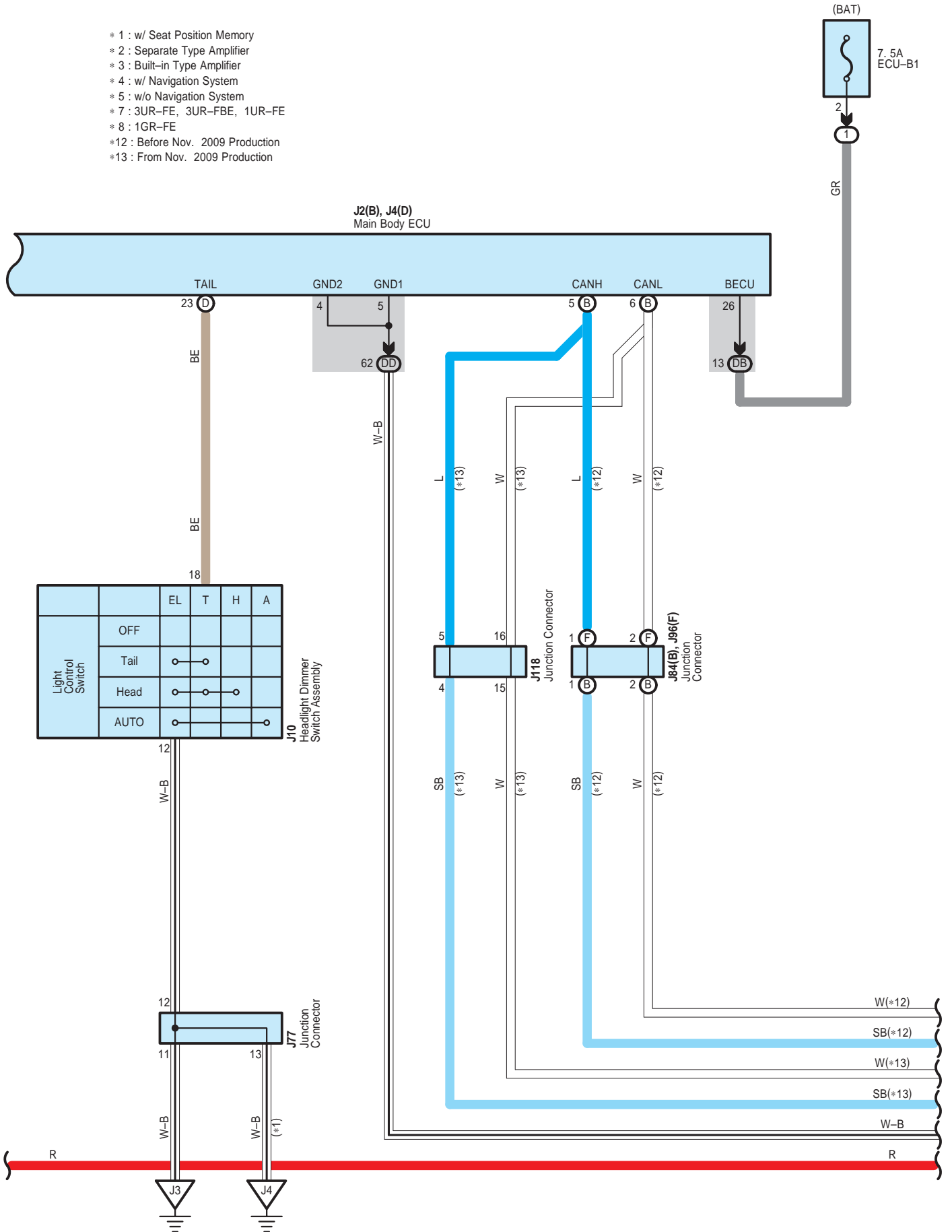

Illumination

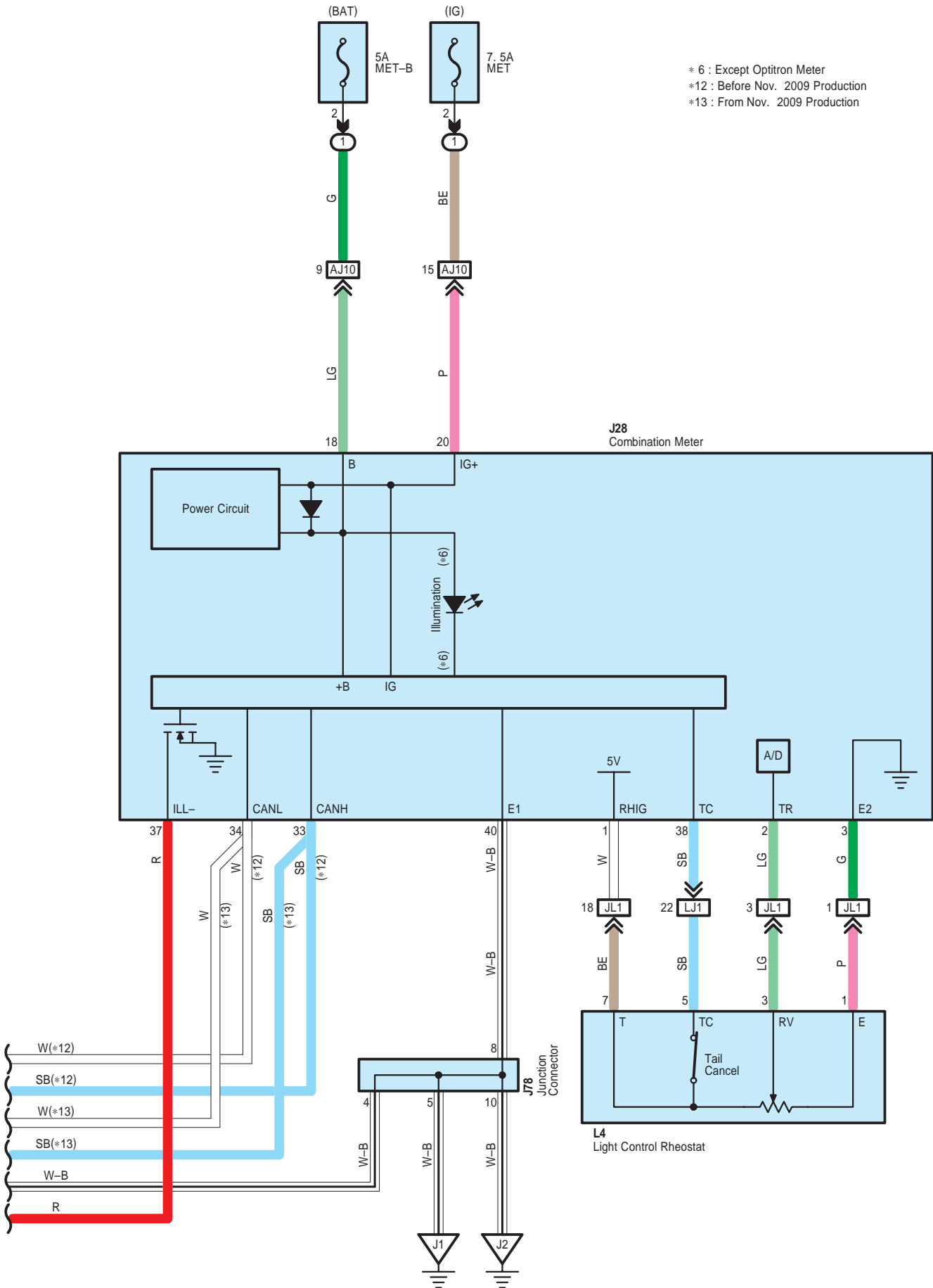

* 6 : Except Optitron Meter
 *12 : Before Nov. 2009 Production
 *13 : From Nov. 2009 Production

illumination

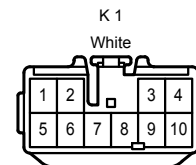
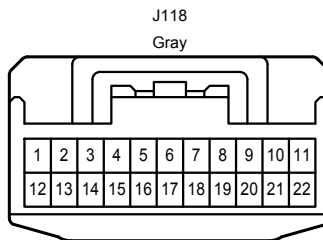
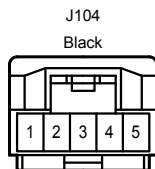
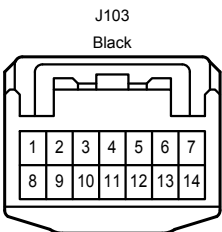
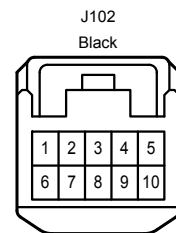
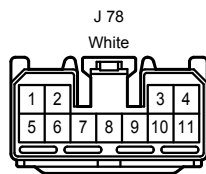
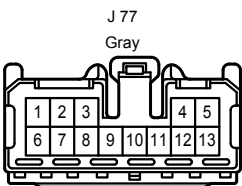
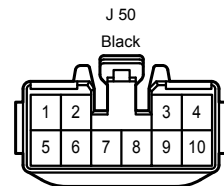
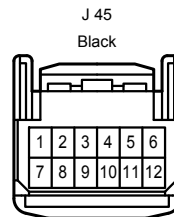
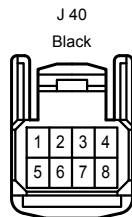
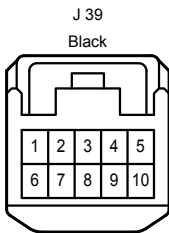
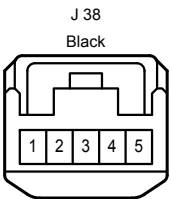
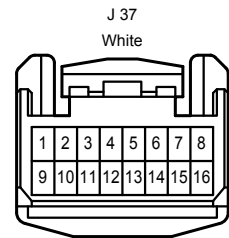
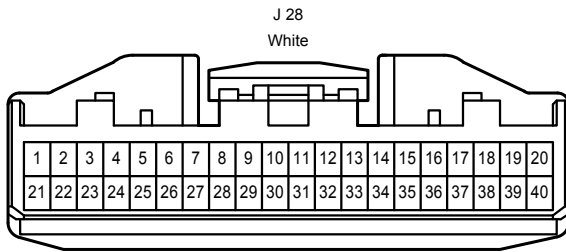
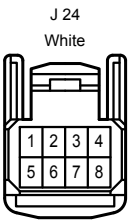
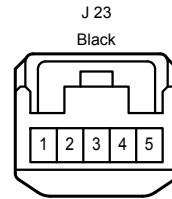
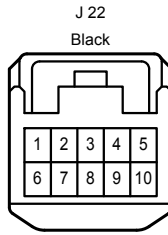
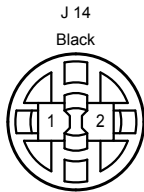
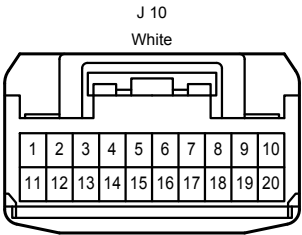
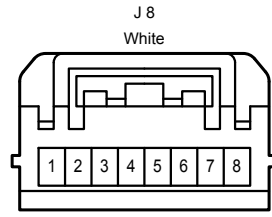
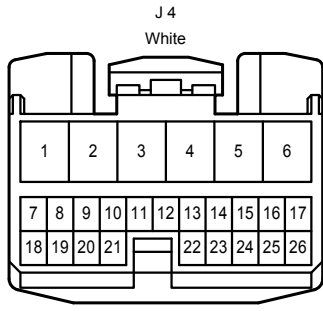
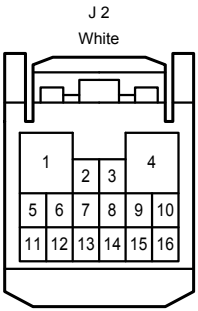

Illumination

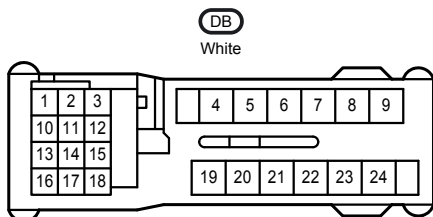
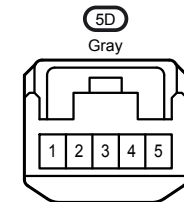
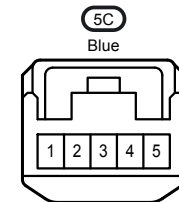
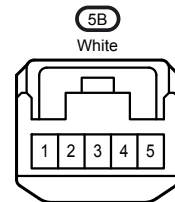
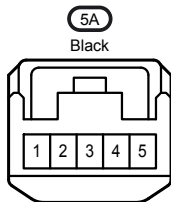
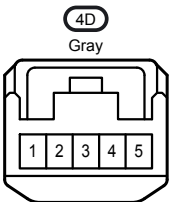
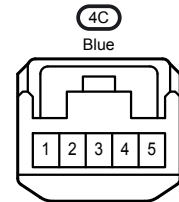
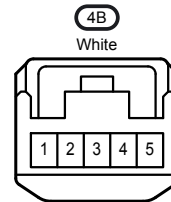
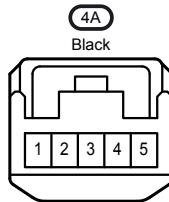
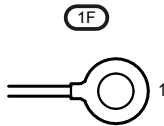
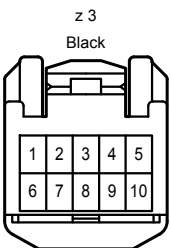
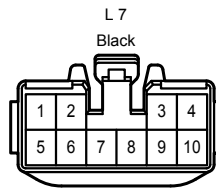
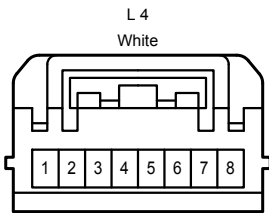
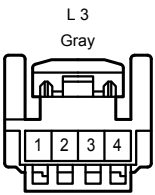
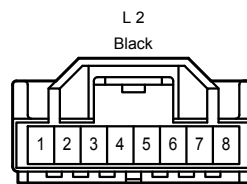
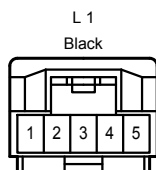
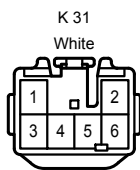
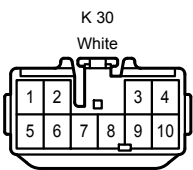
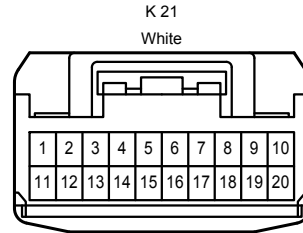
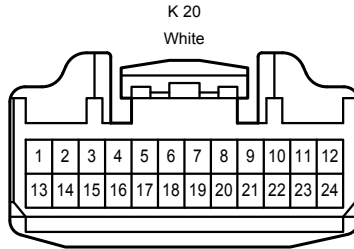
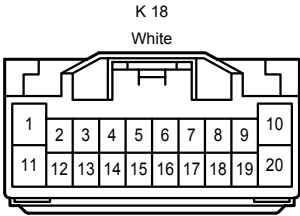
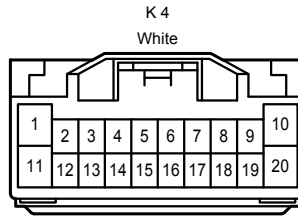
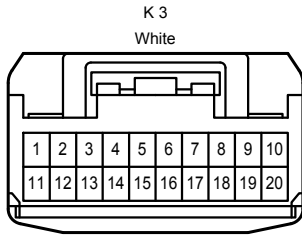
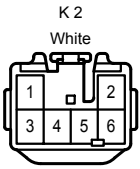

DD

White

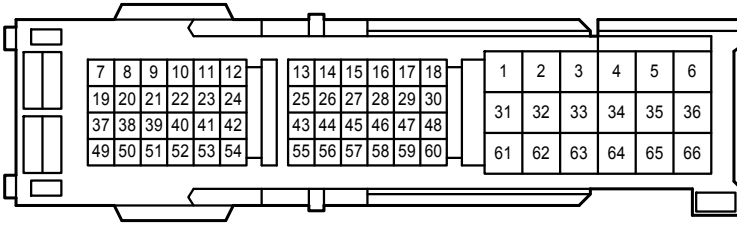

DE

White

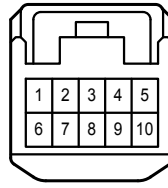

AJ10

Gray

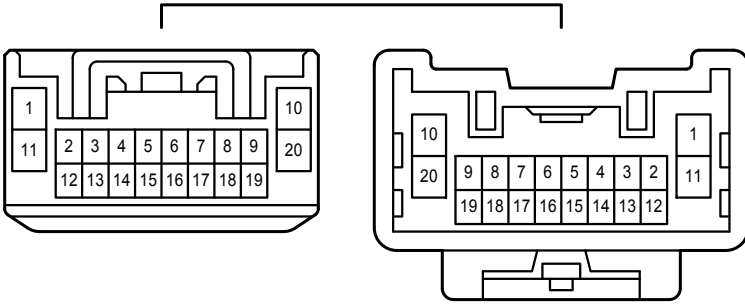

JK1

White

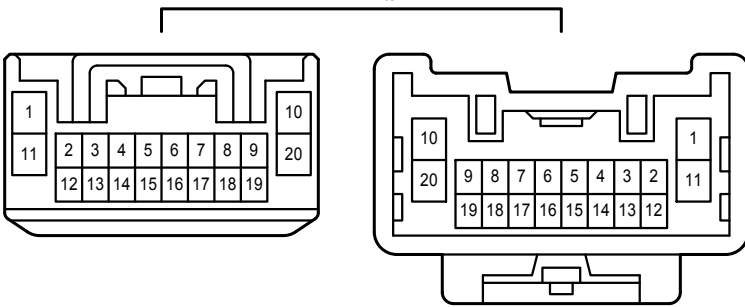

JK2

White

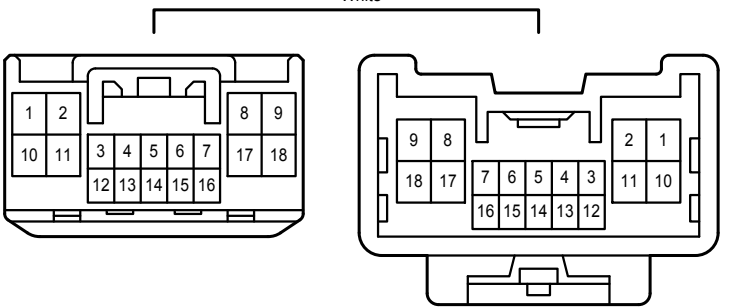

JL1

White

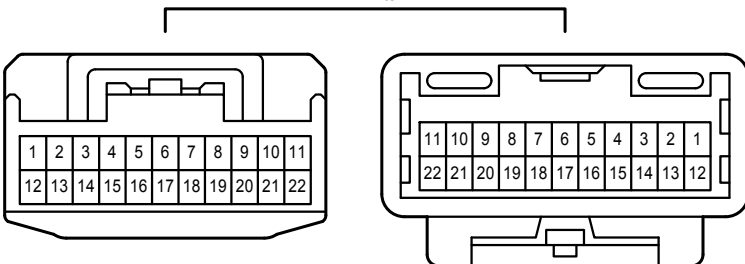

Interior Light

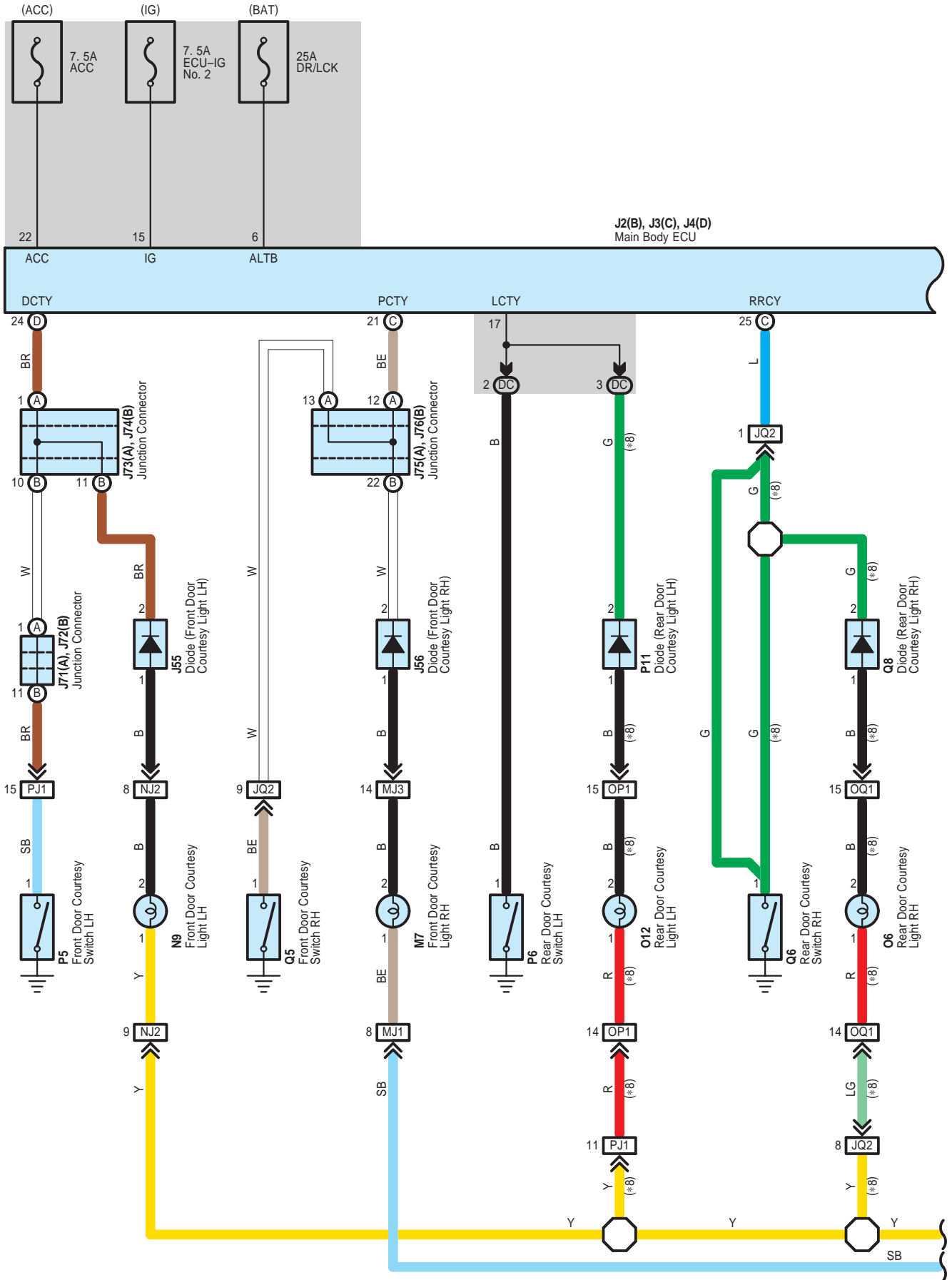

Interior Light

- * 1 : w/ Engine Immobiliser System
- * 2 : w/o Engine Immobiliser System
- * 3 : Except Regular Cab
- * 4 : Regular Cab
- * 8 : w/ Rear Door Courtesy Light

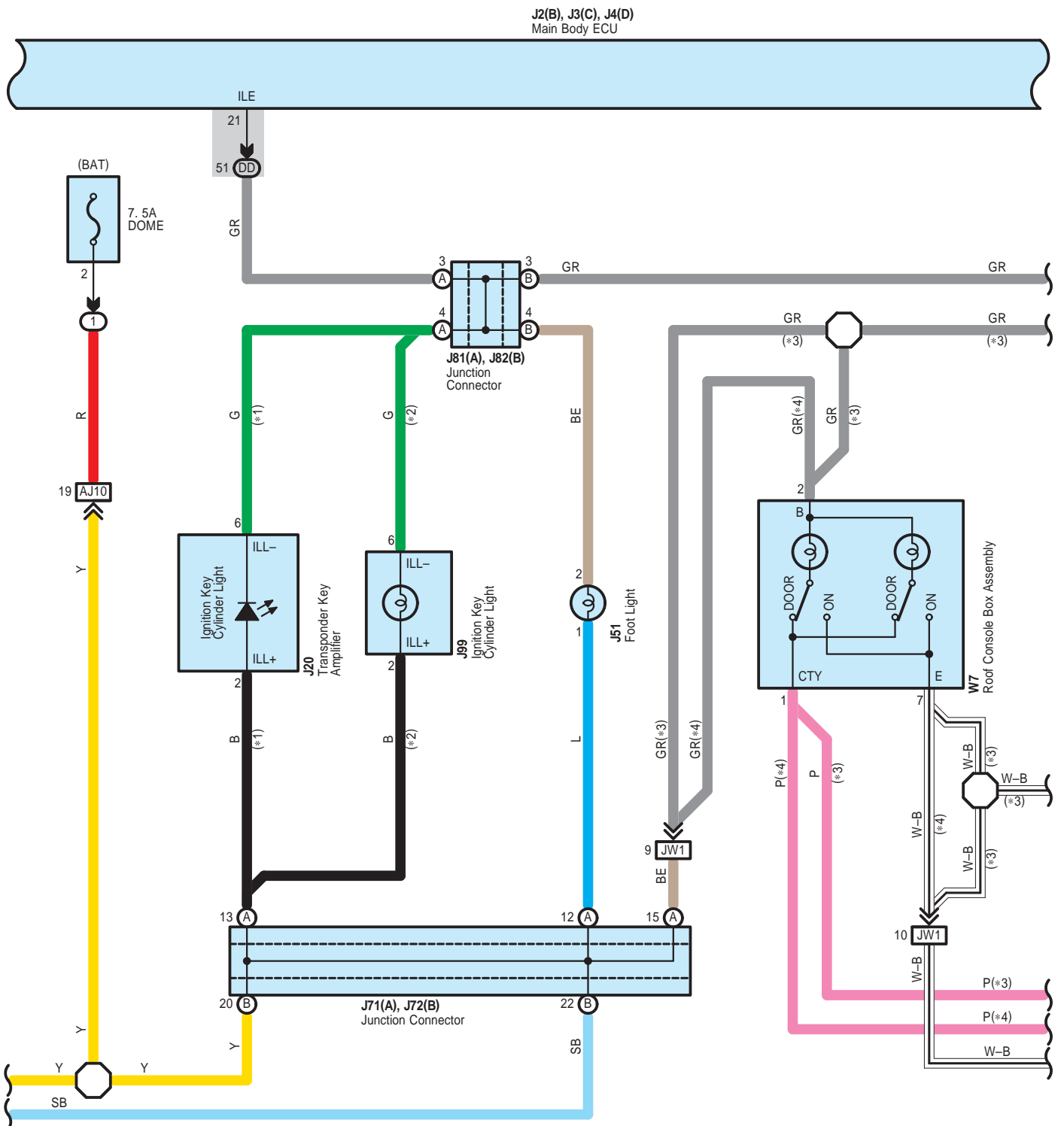

Interior Light

- * 3 : Except Regular Cab
- * 4 : Regular Cab
- * 5 : w/ Seat Position Memory
- * 6 : w/ Rear Seat Entertainment System
- * 7 : w/o Rear Seat Entertainment System
- * 9 : Before Nov. 2009 Production
- * 10 : From Nov. 2009 Production

J2(B), J3(C), J4(D)
Main Body ECU

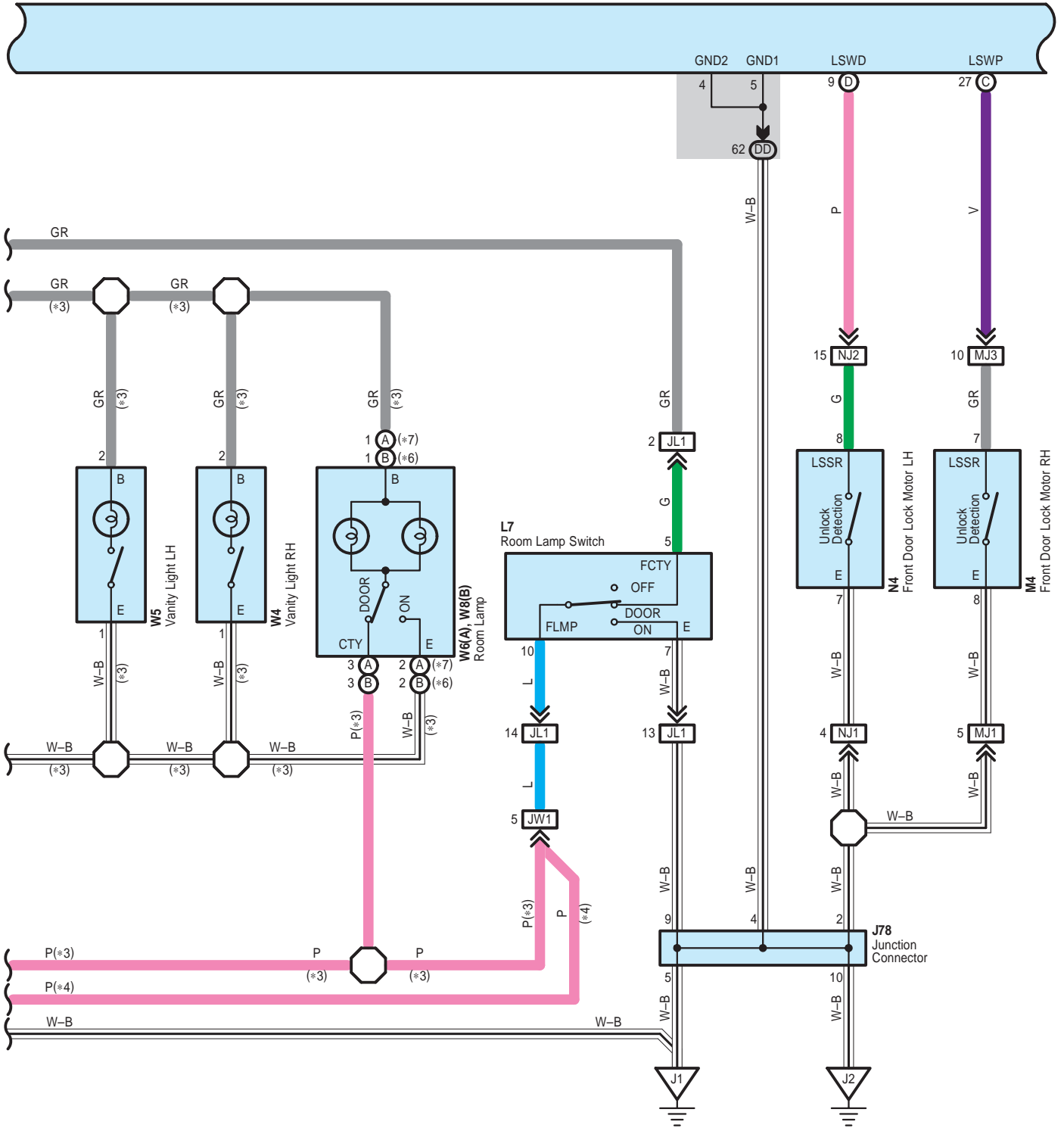

Interior Light

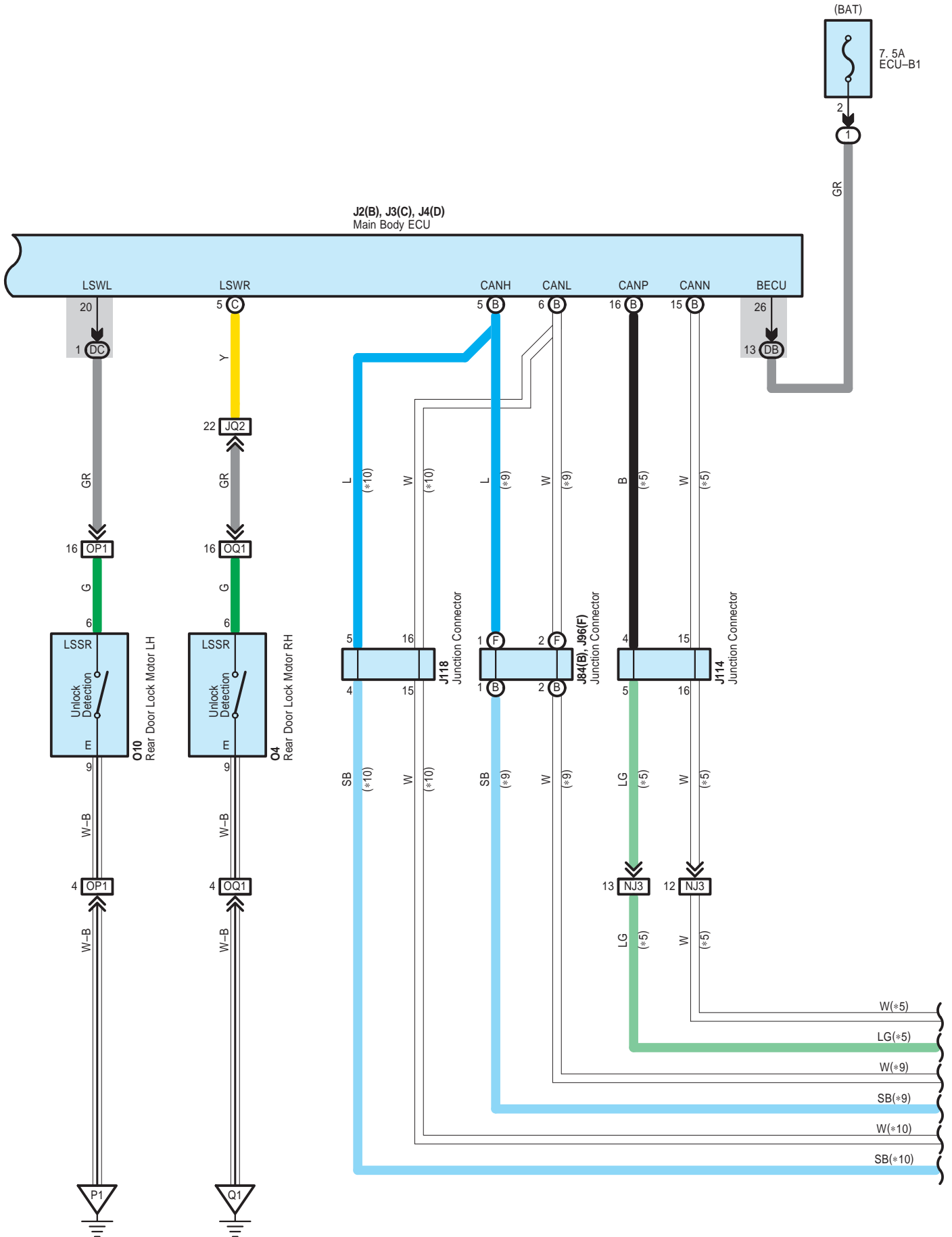

Interior Light

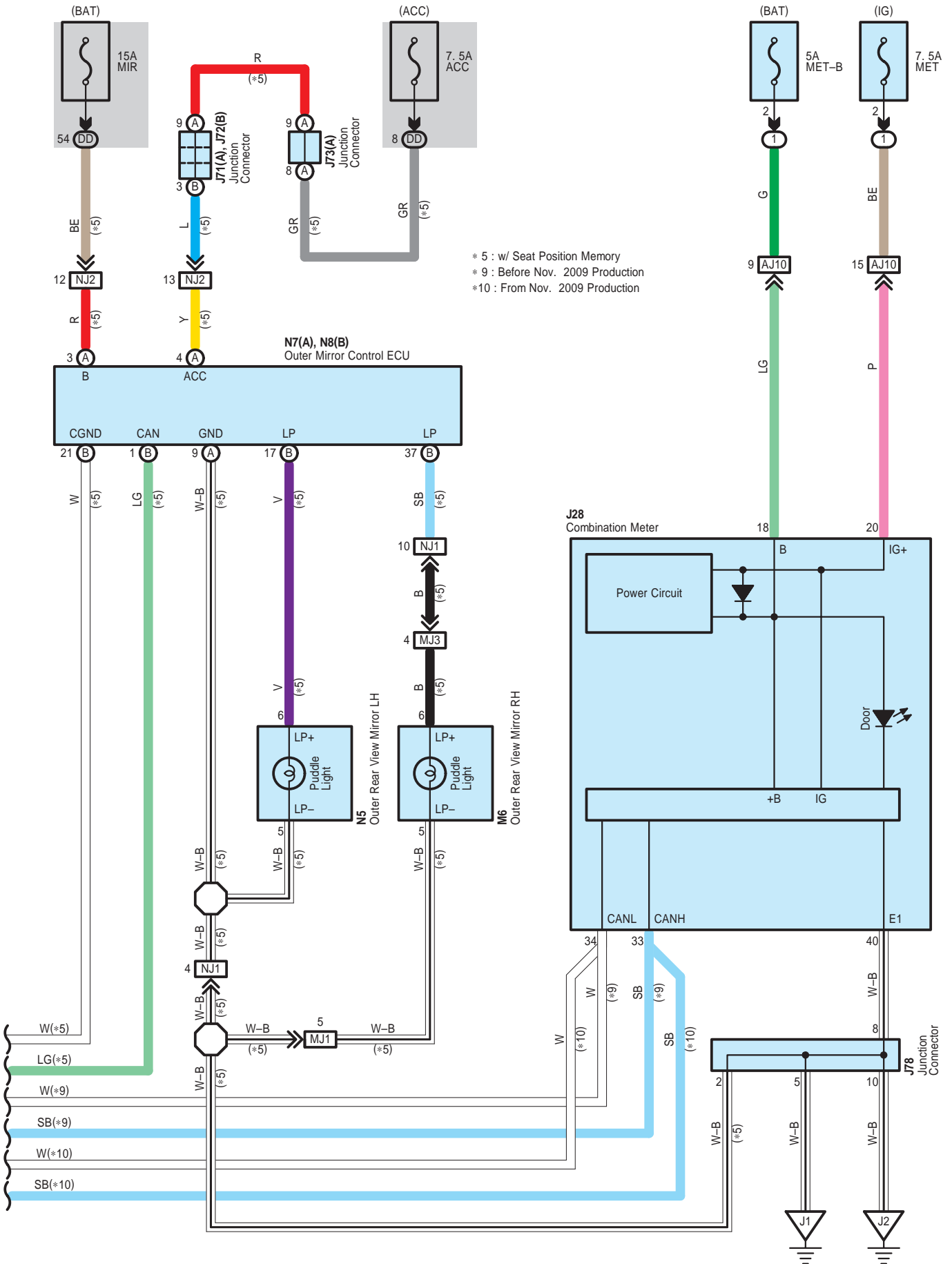

Interior Light

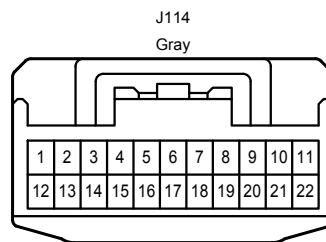
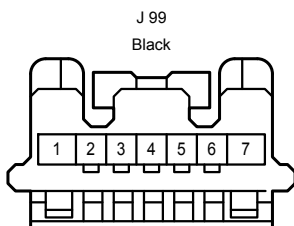
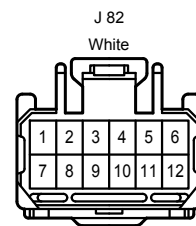
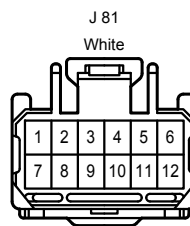
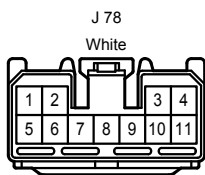
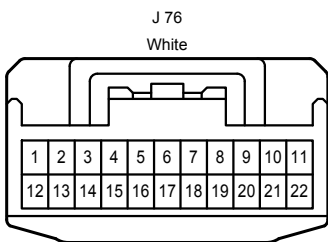
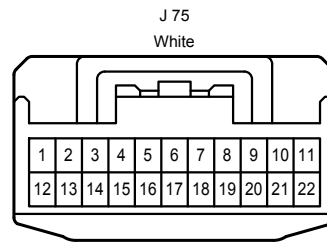
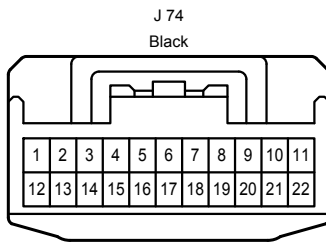
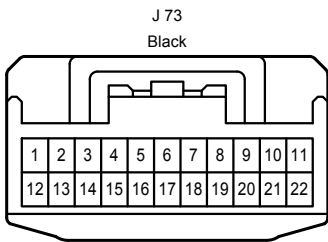
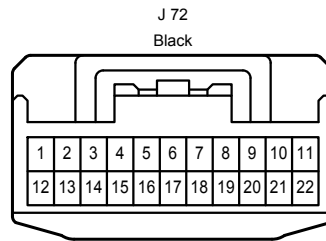
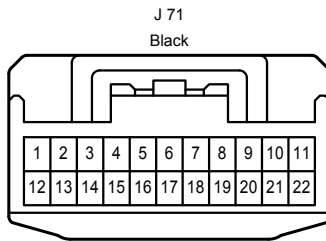
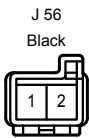
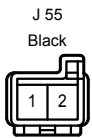
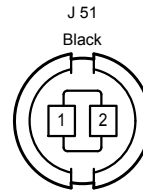
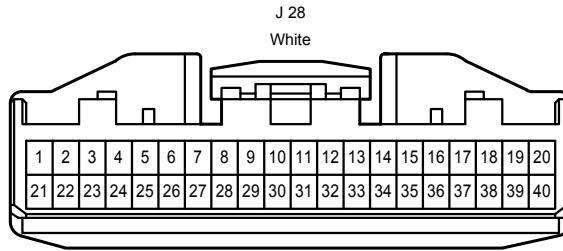
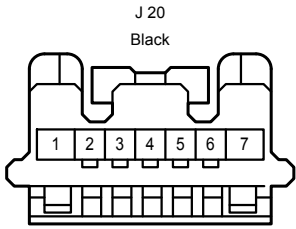
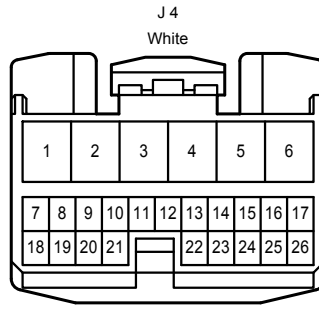
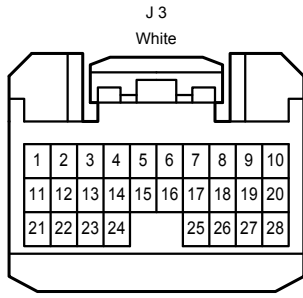
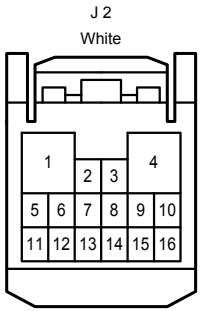

Interior Light

J118
Gray

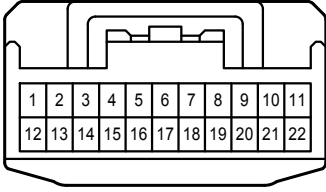

L 7
Black

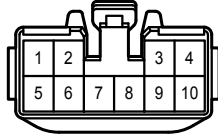

M 4
White

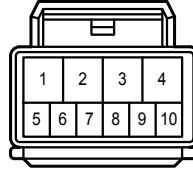

M 6
White

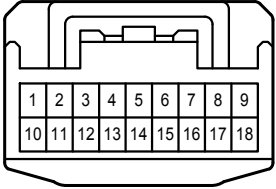

M 7
White



N 4
White

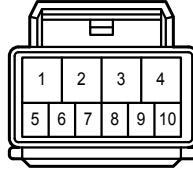

N 5
White

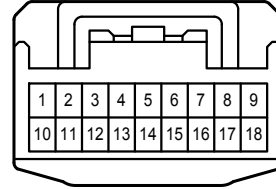

N 7
White

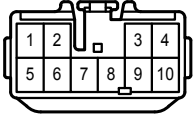

N 8
White

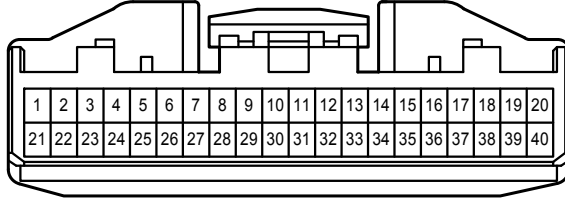

N 9
White



O 4
White

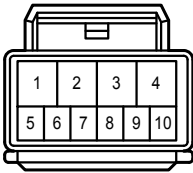

O 6
White



O 10
White

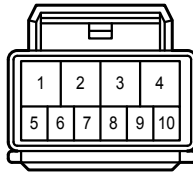

O 12
White



P 5
White



P 6
White



P 11
Black



Q 5
White



Q 6
White



Q 8
Black



W 4
White



W 5
White



W 6
White

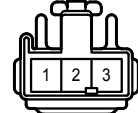

W 7
White

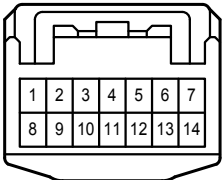

W 8
White

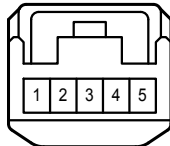

DB
White

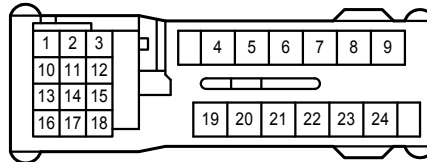

Interior Light

DC
White

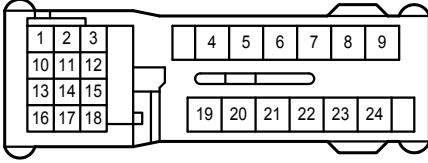

DD
White

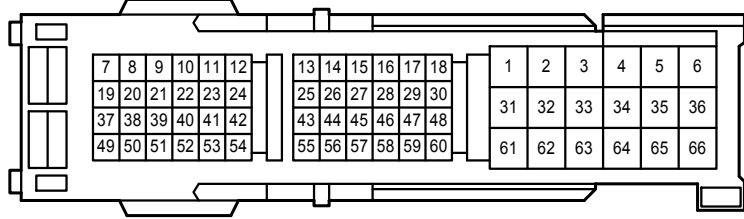

AJ10
Gray

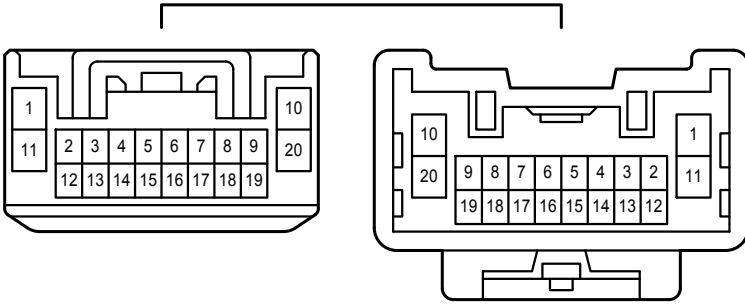

JL1
White

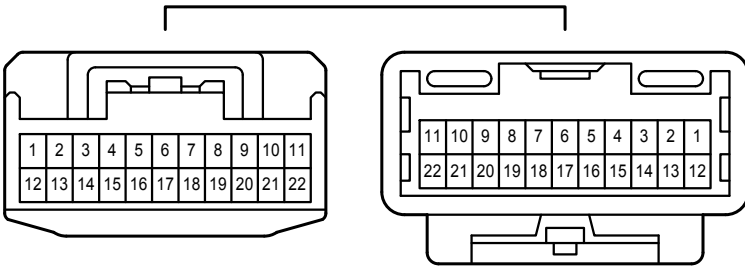

JQ2
Gray

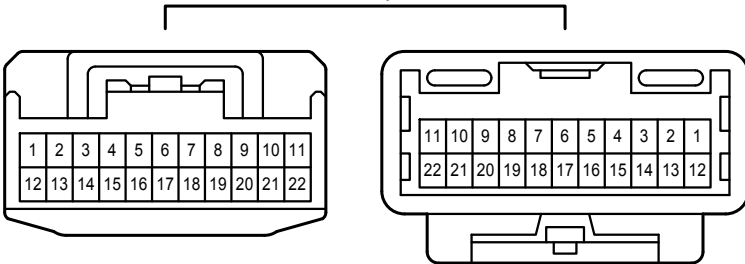

JW1
White

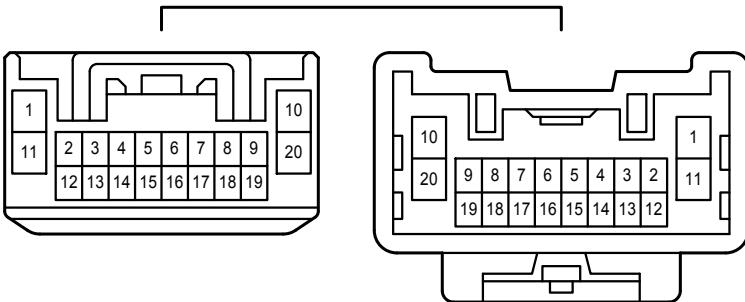

MJ1
Blue

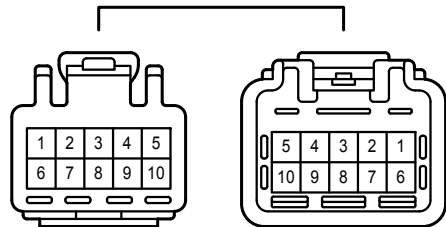

Interior Light

MJ3
Blue

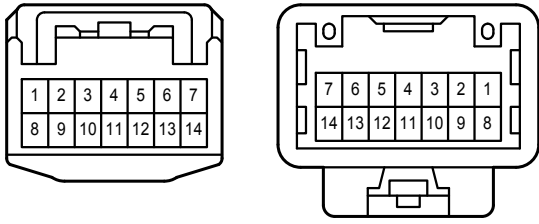

NJ1
Blue

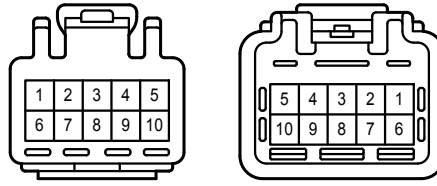

NJ2
Blue

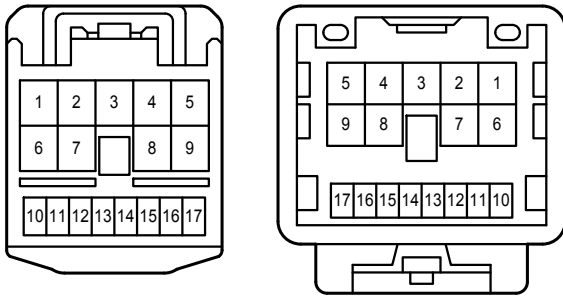

NJ3
Blue

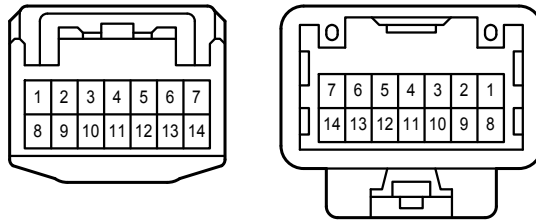

OP1
White

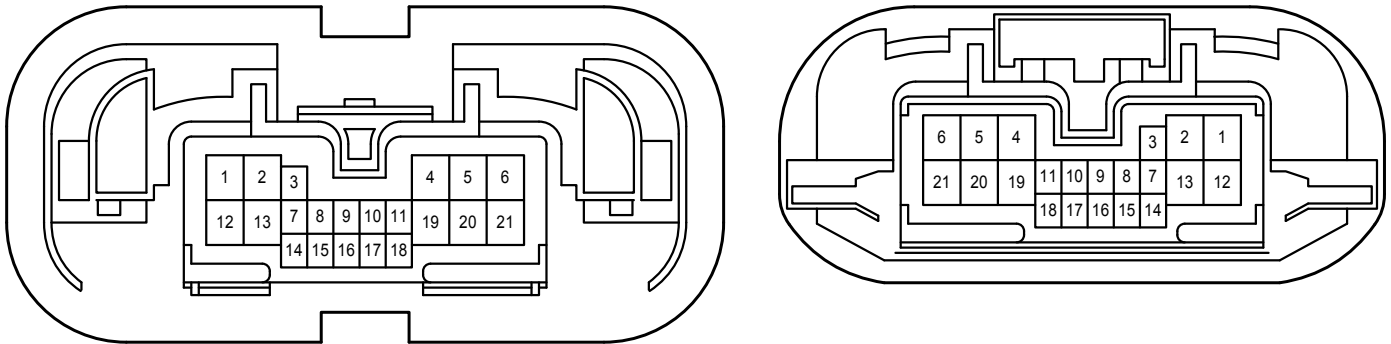

OQ1
White

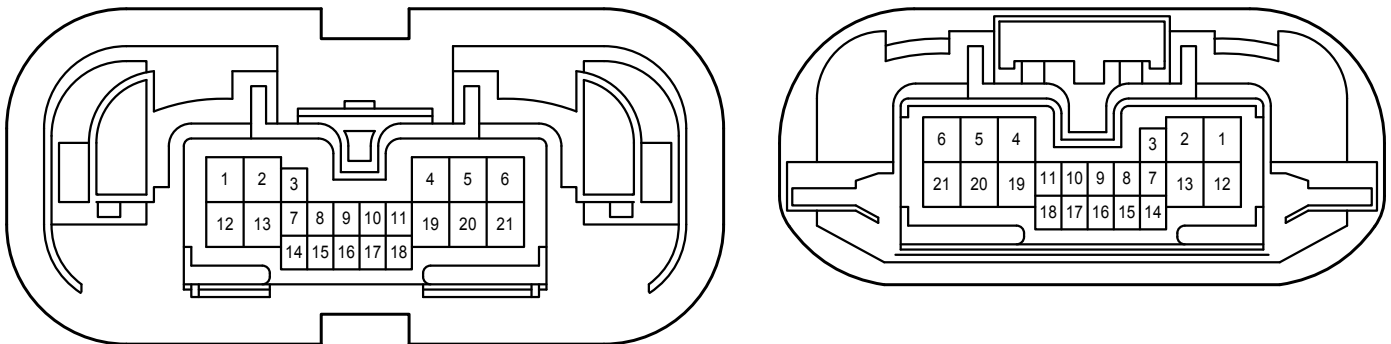

Interior Light

PJ1
Black

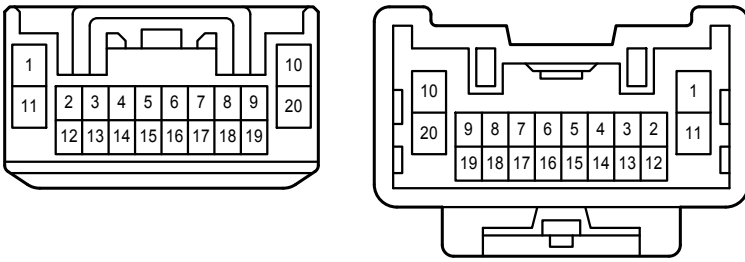

Key Reminder , Seat Belt Warning

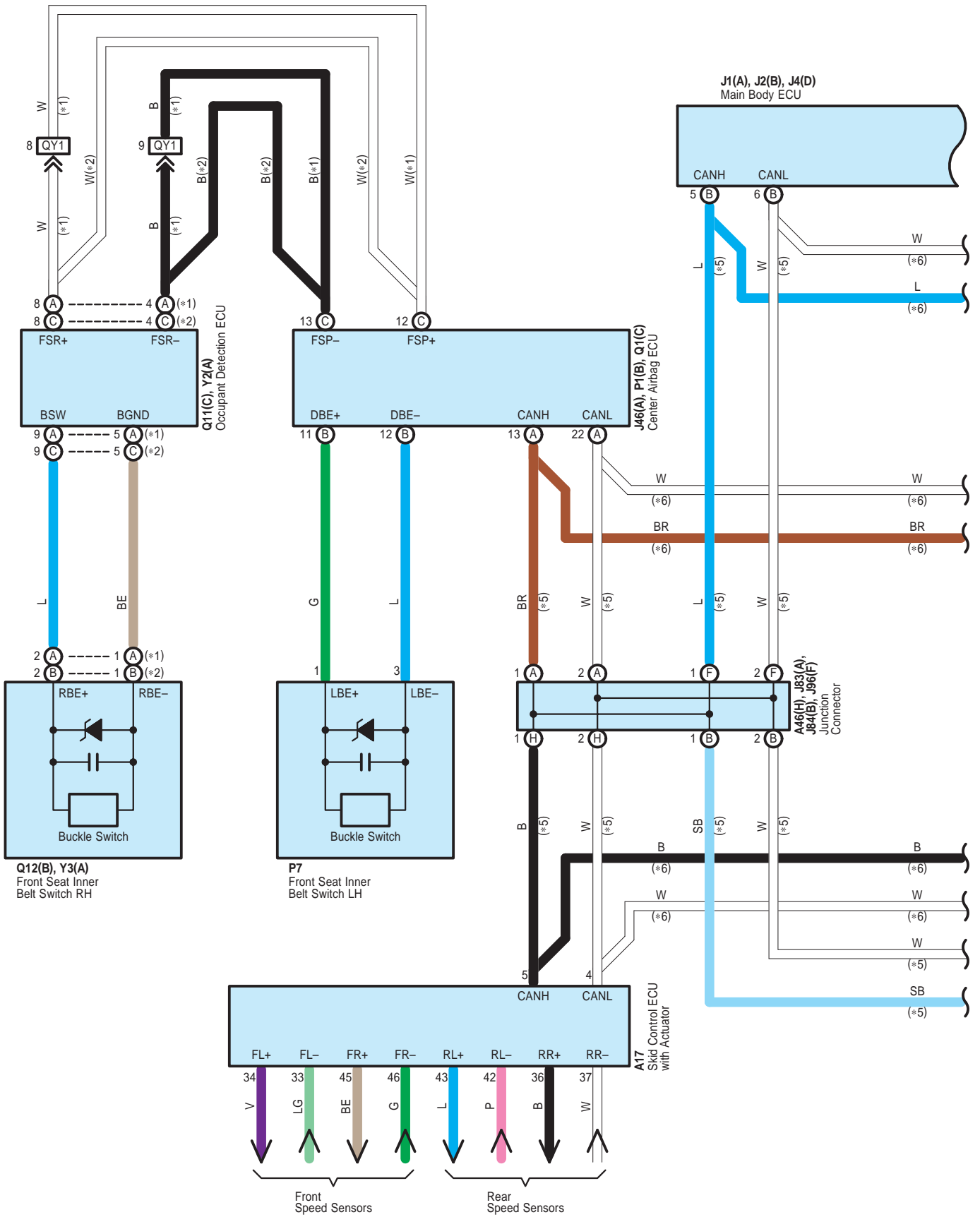

Key Reminder , Seat Belt Warning

J1(A), J2(B), J4(D)
Main Body ECU

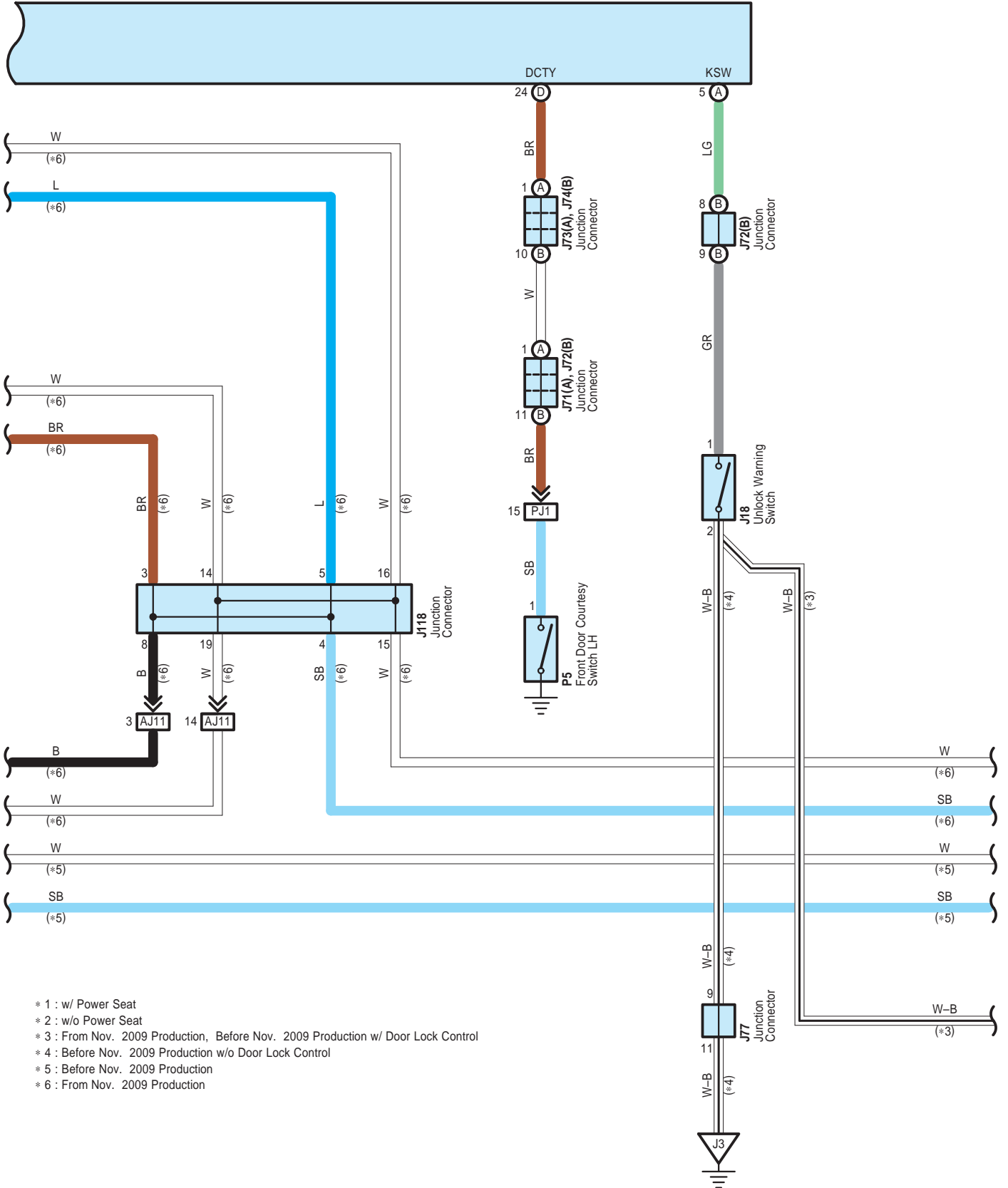

- * 1 : w/ Power Seat
- * 2 : w/o Power Seat
- * 3 : From Nov. 2009 Production, Before Nov. 2009 Production w/ Door Lock Control
- * 4 : Before Nov. 2009 Production w/o Door Lock Control
- * 5 : Before Nov. 2009 Production
- * 6 : From Nov. 2009 Production

Key Reminder , Seat Belt Warning

- * 3 : From Nov. 2009 Production,
Before Nov. 2009 Production w/ Door Lock Control
- * 5 : Before Nov. 2009 Production
- * 6 : From Nov. 2009 Production

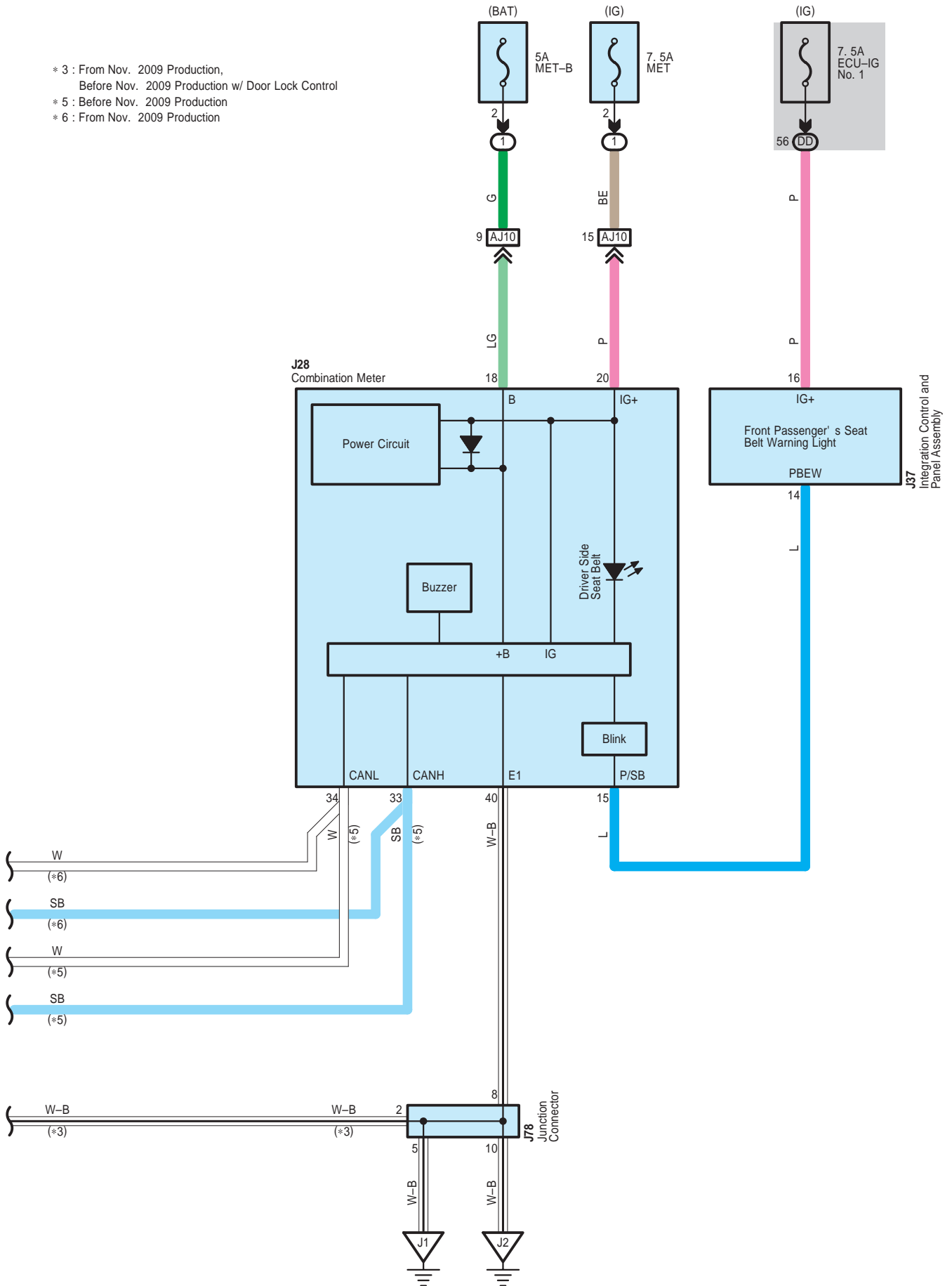

Key Reminder , Seat Belt Warning

A 17
Black

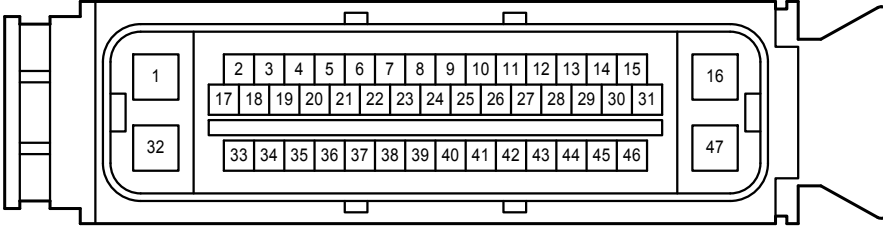

A 46
White

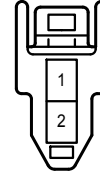

J 1
White

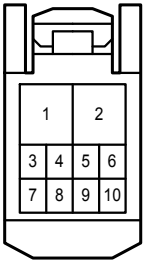

J 2
White

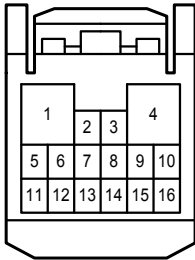

J 4
White

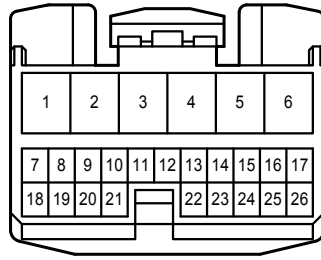

J 18
White



J 28
White

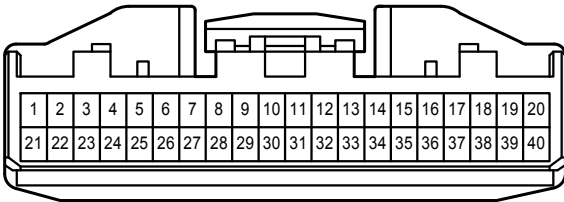

J 37
White

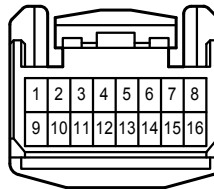

J 46
Yellow

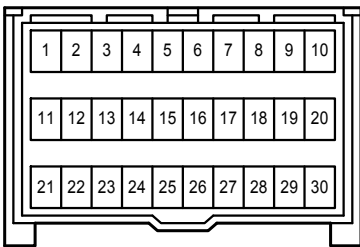

J 71
Black

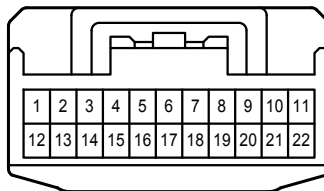

J 72
Black

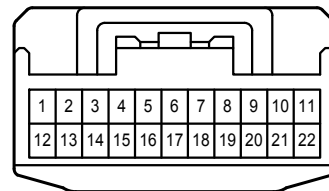

J 73
Black

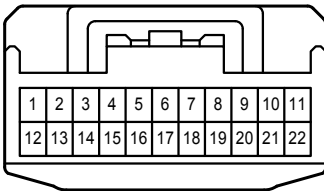

J 74
Black

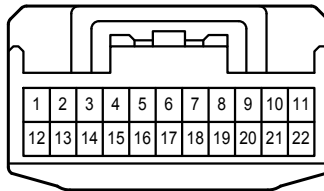

J 77
Gray

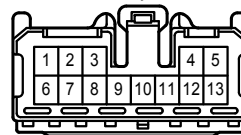

J 78
White



J 83
White

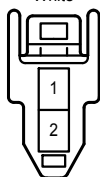

J 84
White

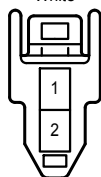

J 96
White

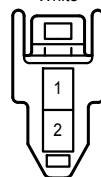

J 118
Gray

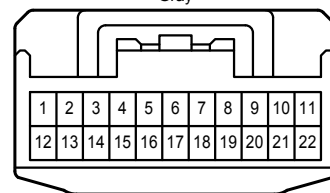

Key Reminder , Seat Belt Warning

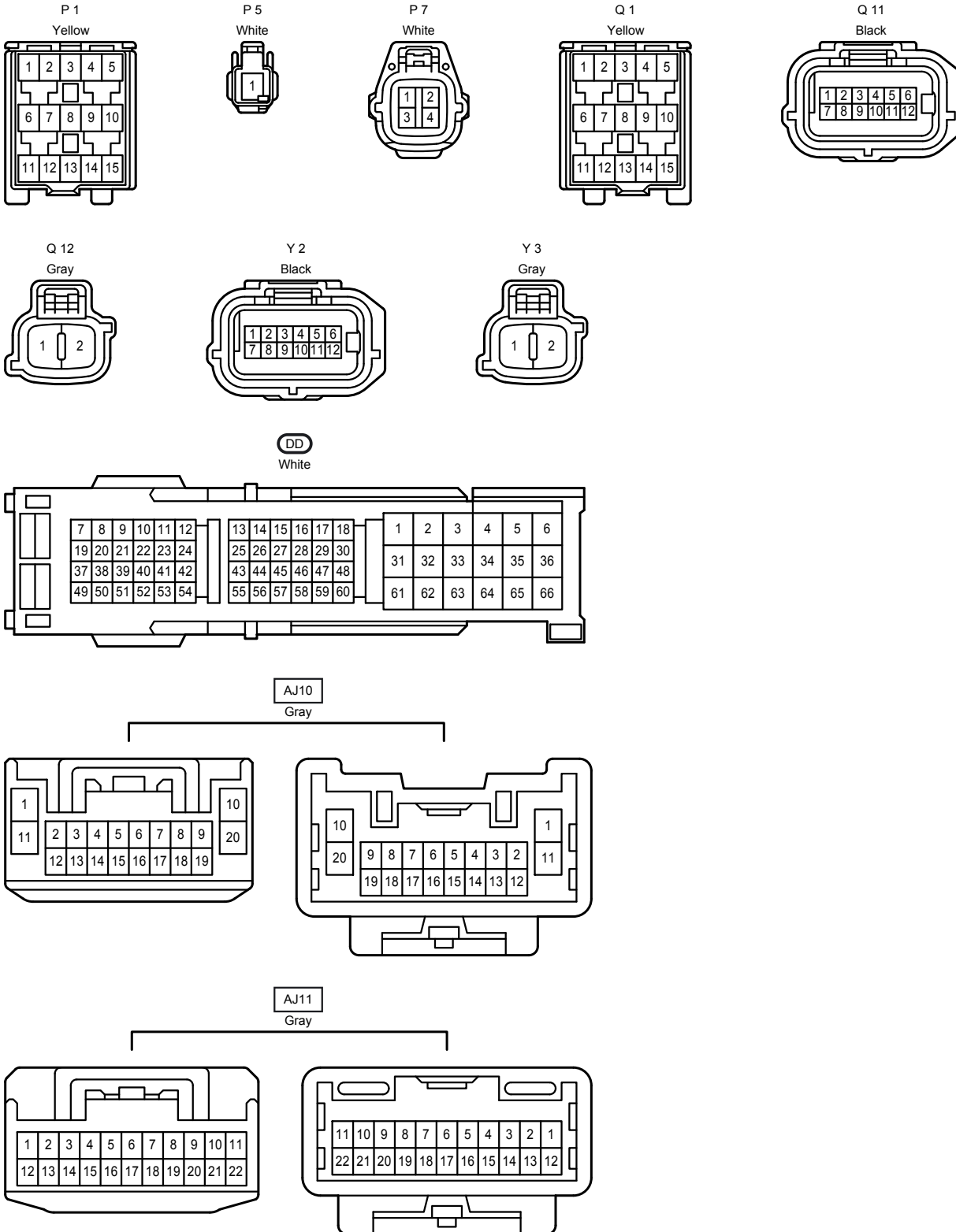

PJ1
Black

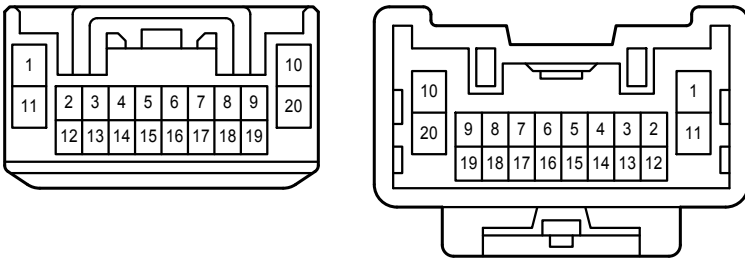

QY1
White

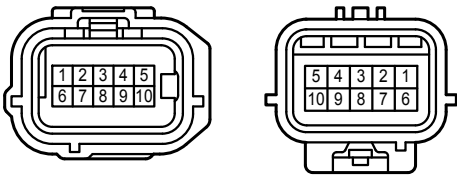

Mirror Heater

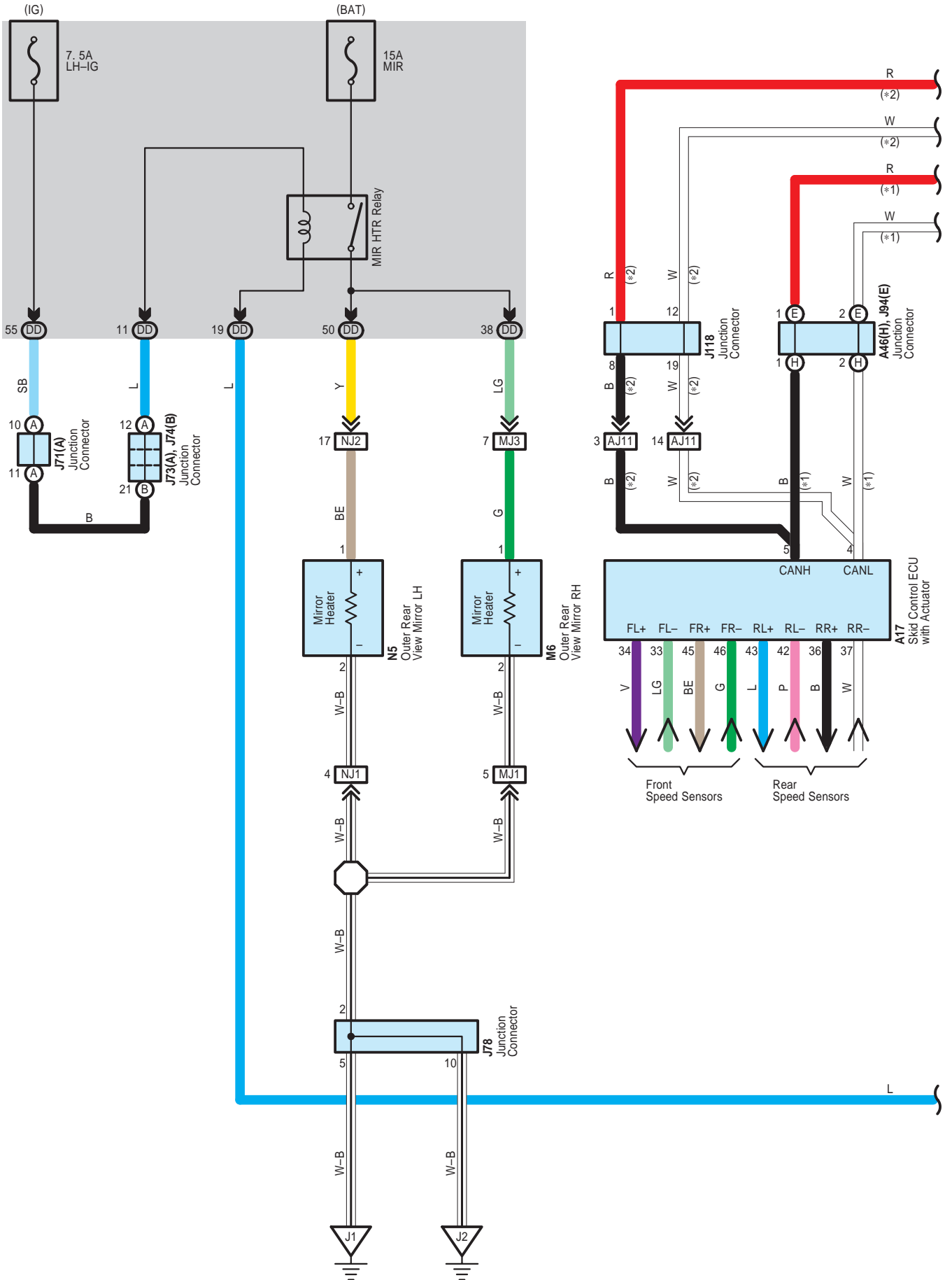

Mirror Heater

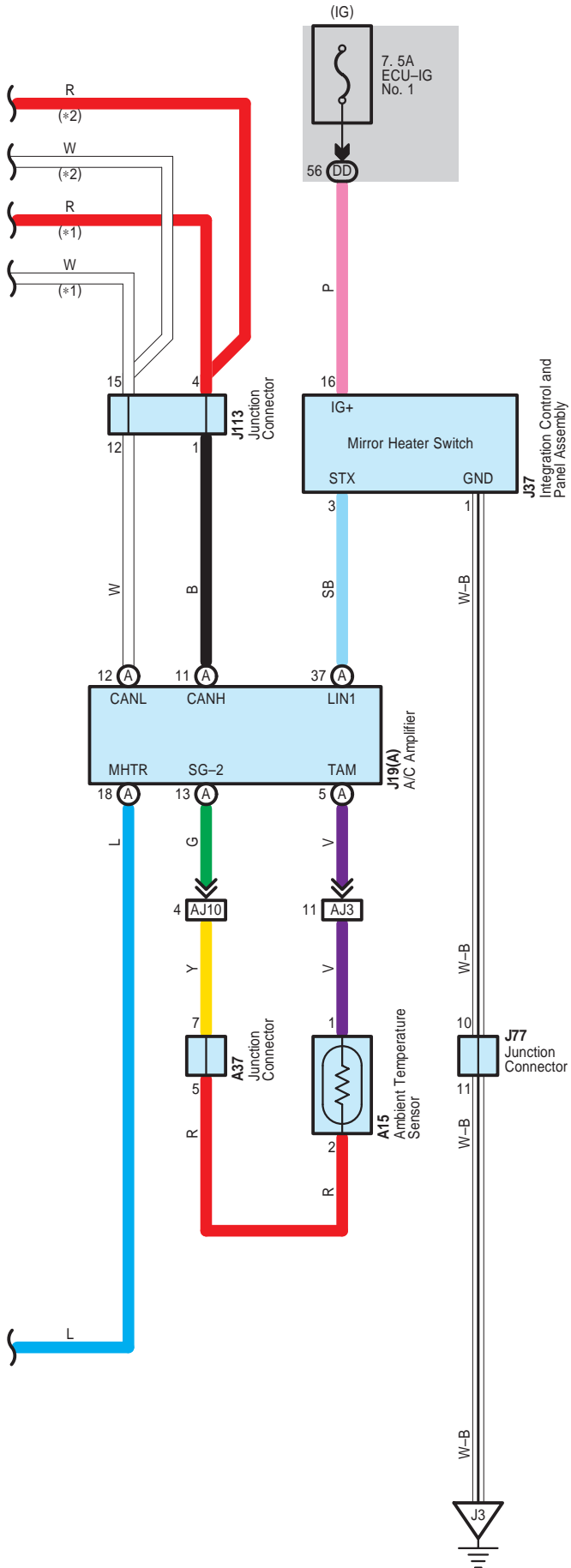

* 1 : Before Nov. 2009 Production
 * 2 : From Nov. 2009 Production

Mirror Heater

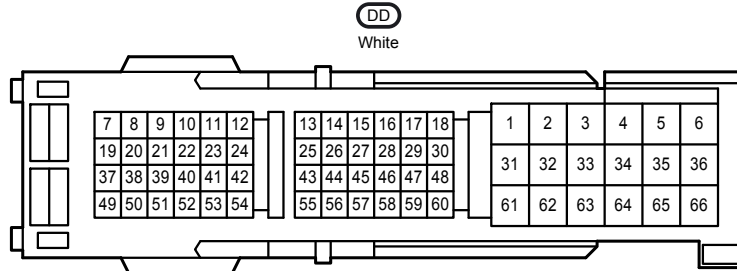
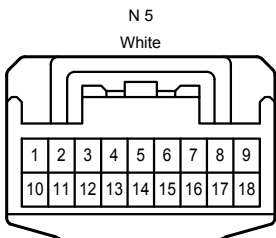
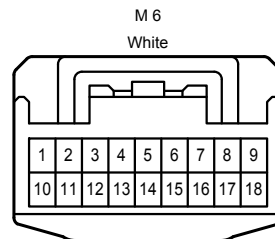
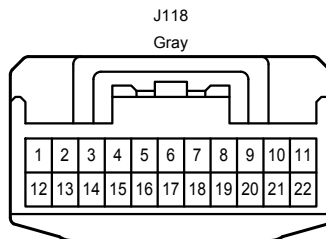
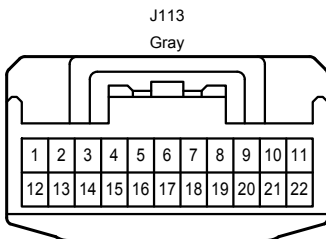
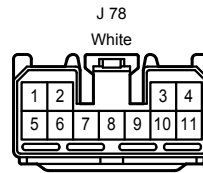
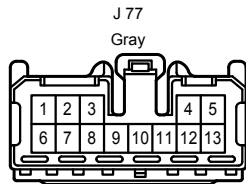
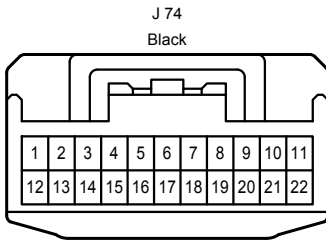
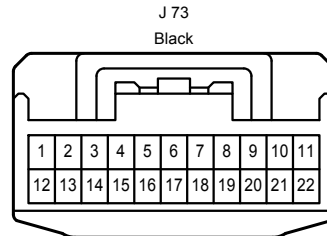
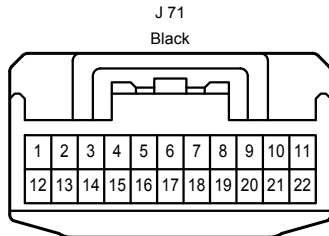
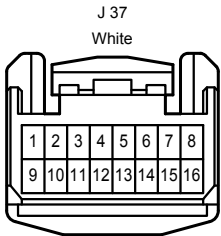
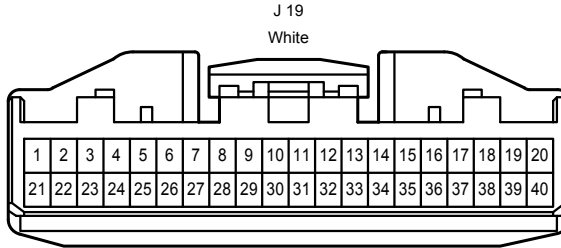
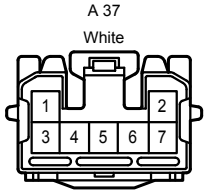
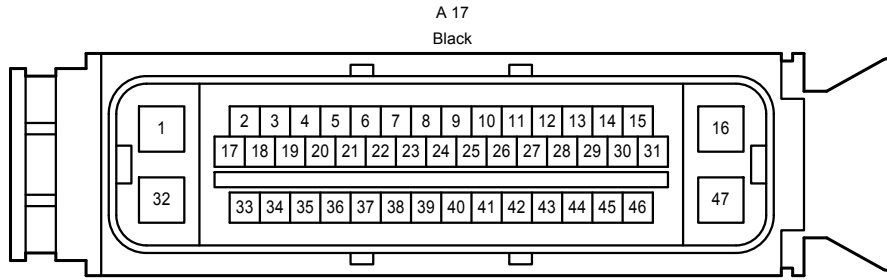

Mirror Heater

AJ3
White

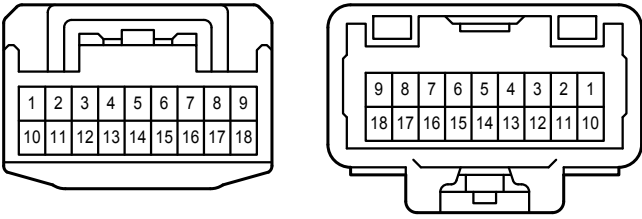

AJ10
Gray

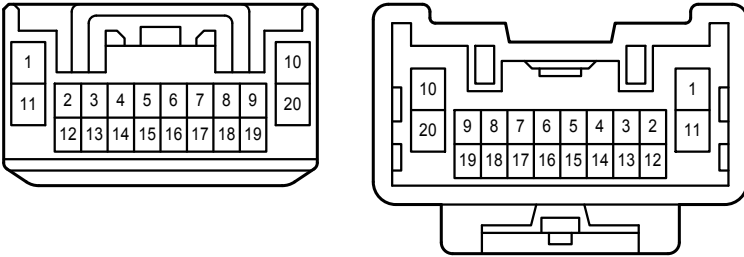

AJ11
Gray

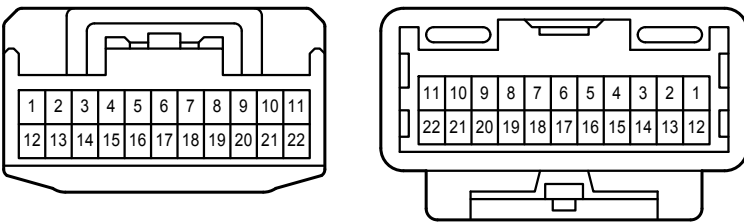

MJ1
Blue

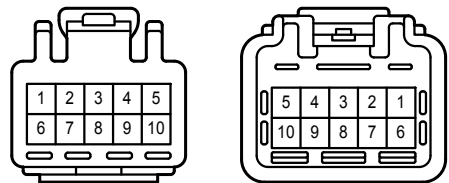

MJ3
Blue

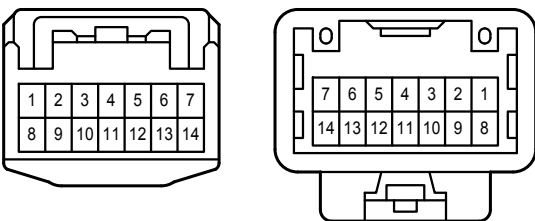

NJ1
Blue

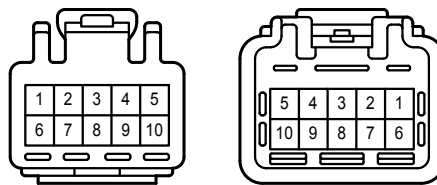

NJ2
Blue

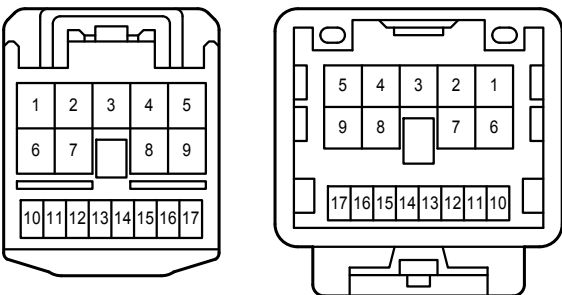

Multi Mode 4WD

* 1 : Before Nov. 2009 Production
 * 2 : From Nov. 2009 Production

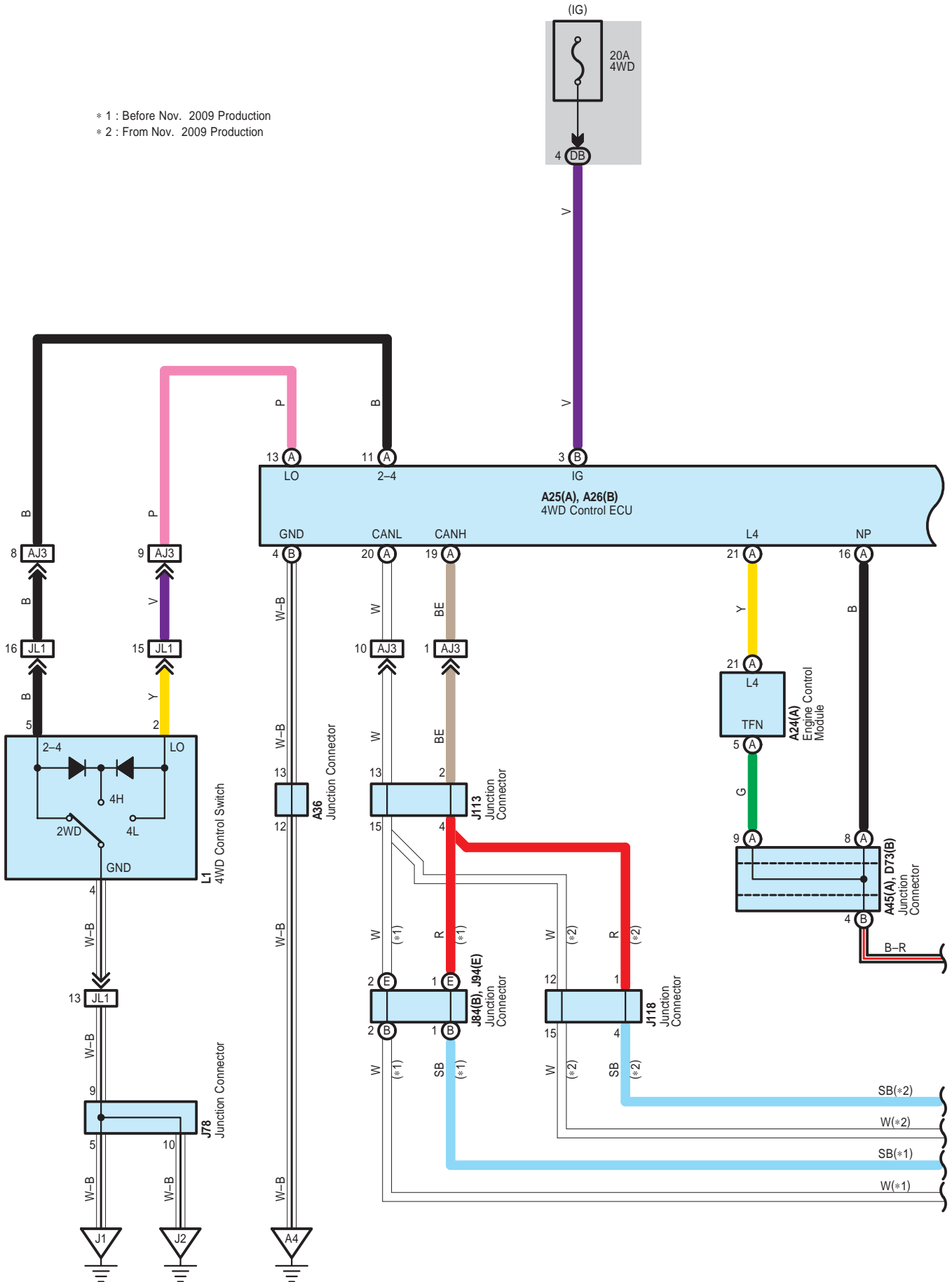

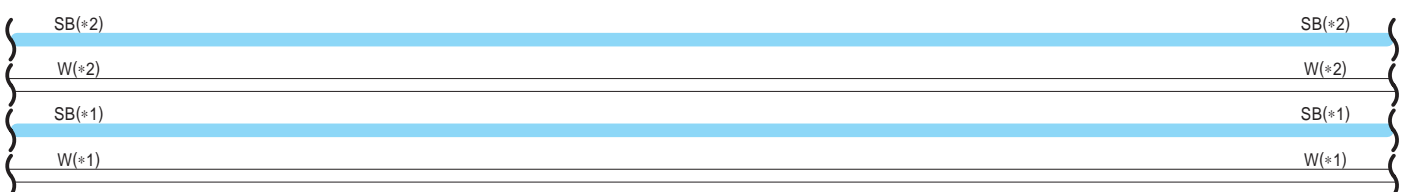
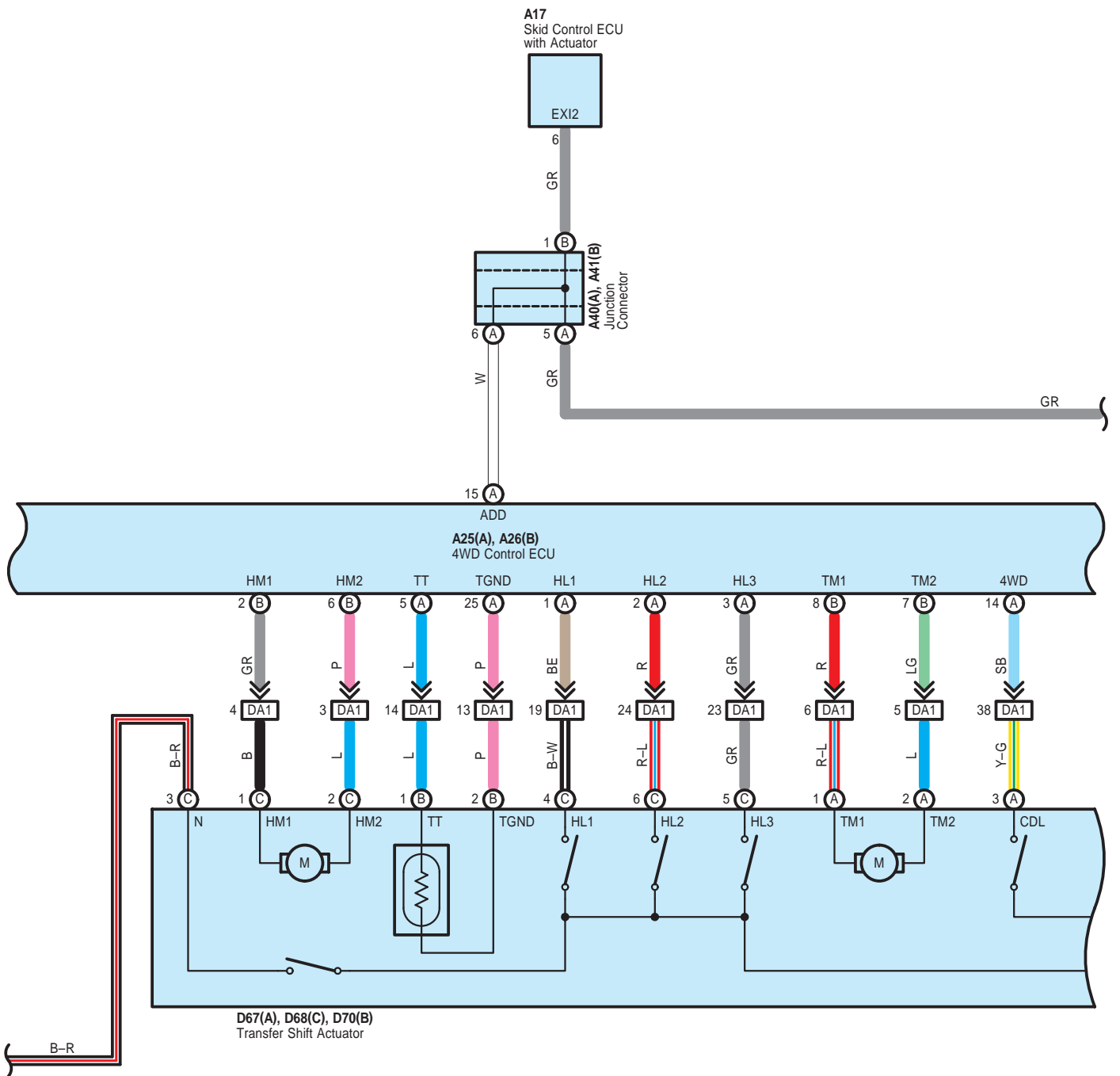

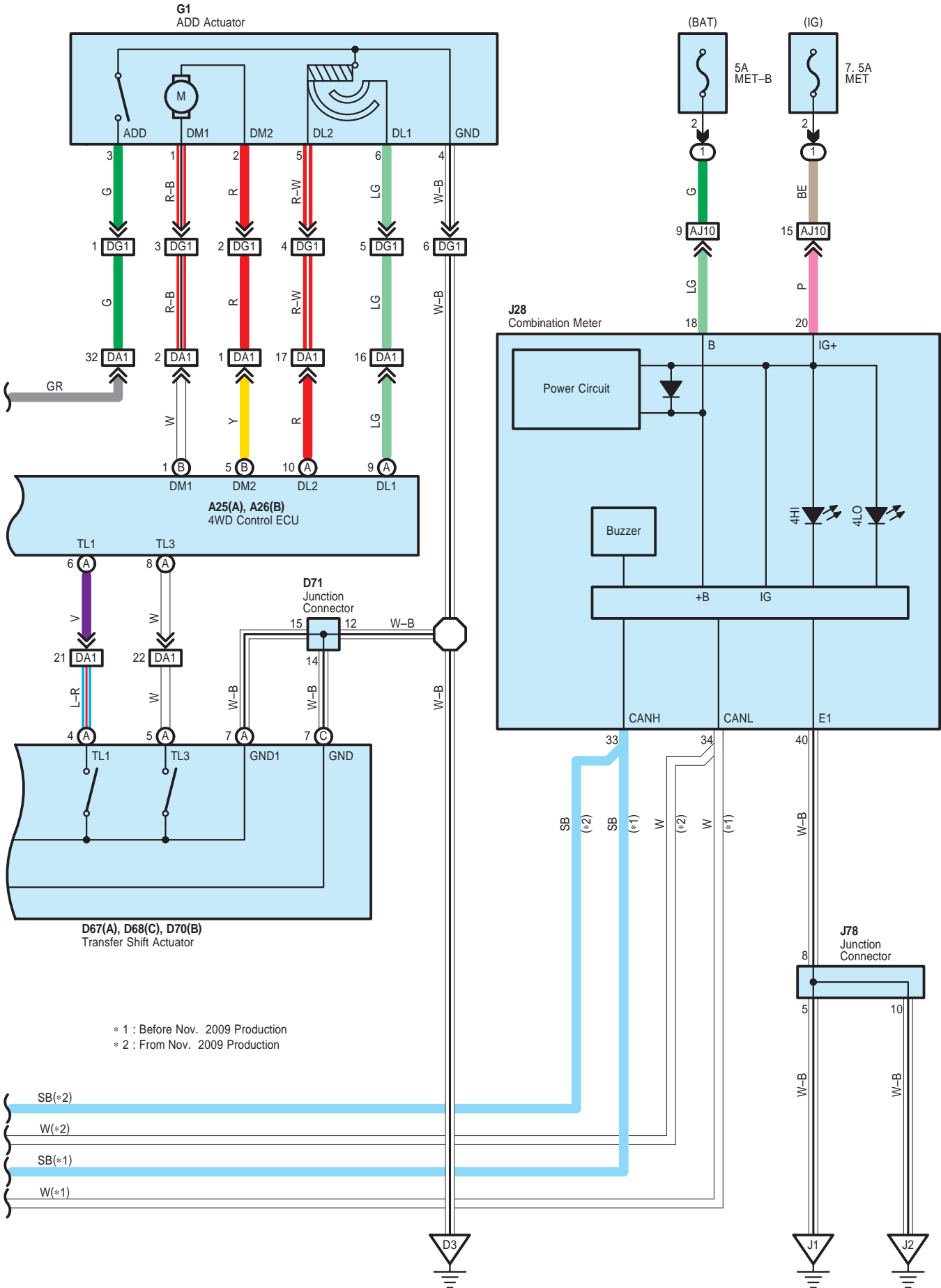

A 17
Black

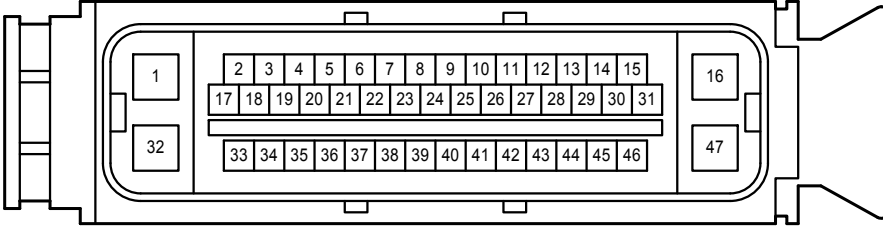

A 24
Black

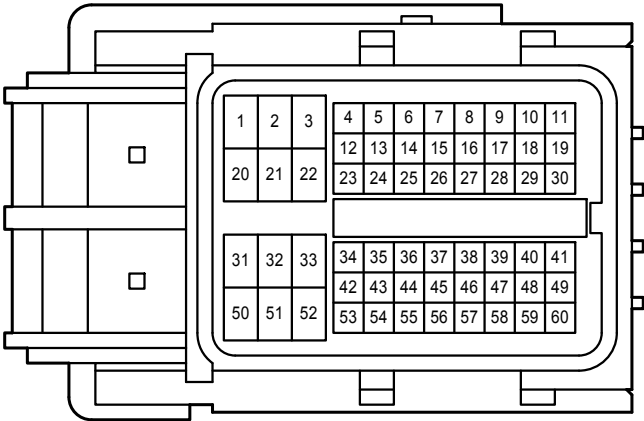

A 25
Black

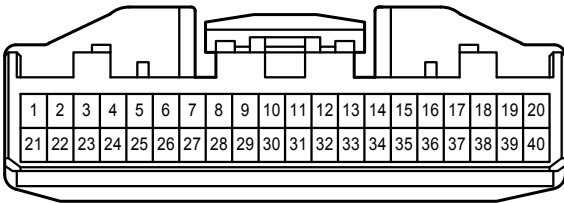

A 26
Black

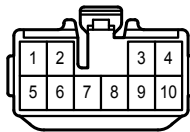

A 36
White

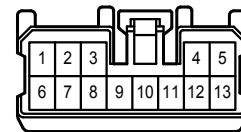

A 40
White

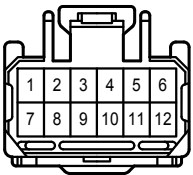

A 41
White

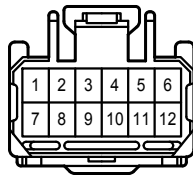

A 45
Blue

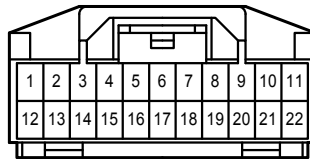

D 67
Black

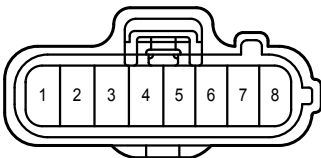

D 68
Dark Gray

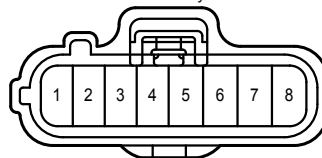

D 70
Black



D 71
White

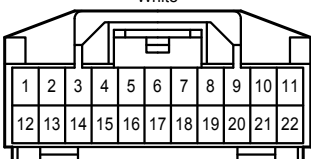

D 73
Blue

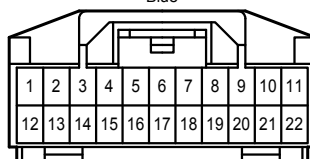

G 1
Black

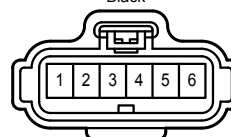

Multi Mode 4WD

J 28
White

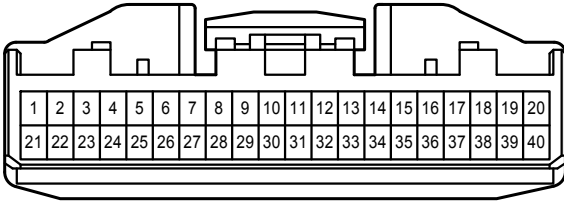

J 78
White

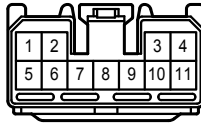

J 84
White

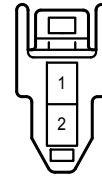

J 94
White

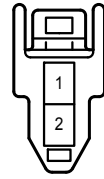

J113
Gray

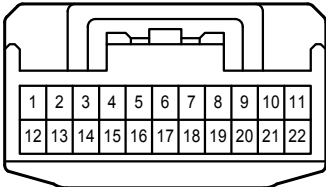

J118
Gray

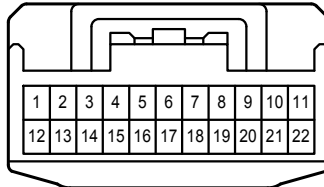

L 1
Black

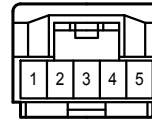

DB
White

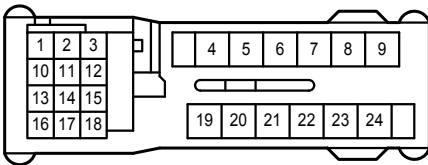

AJ3
White

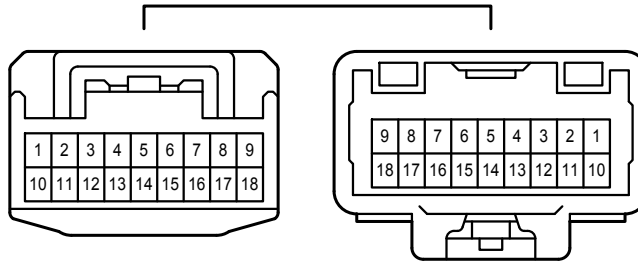

AJ10
Gray

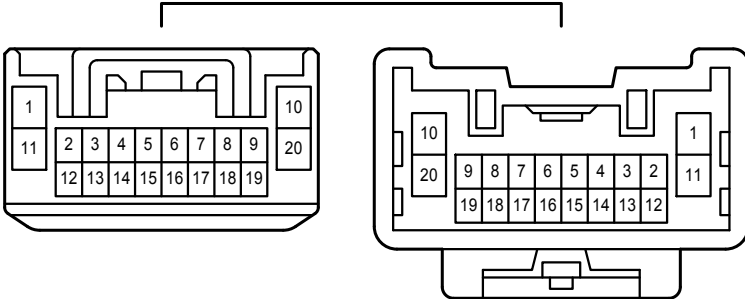

DA1
White

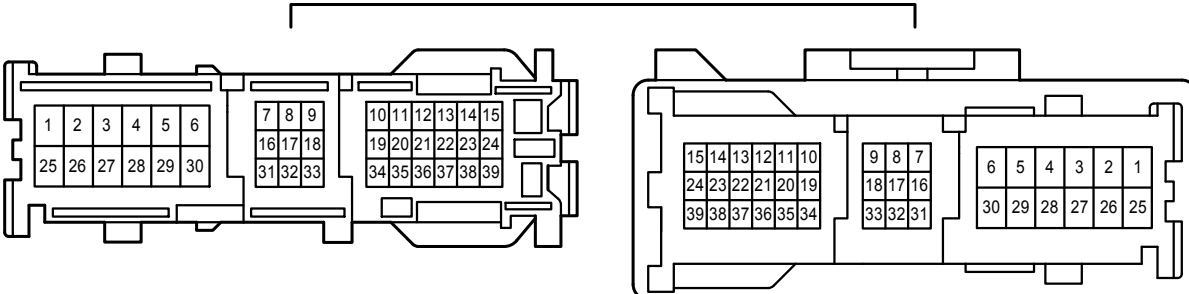

Multi Mode 4WD

DG1
Black

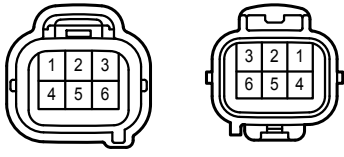

JL1
White

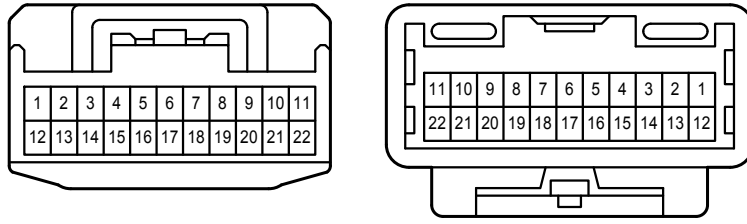

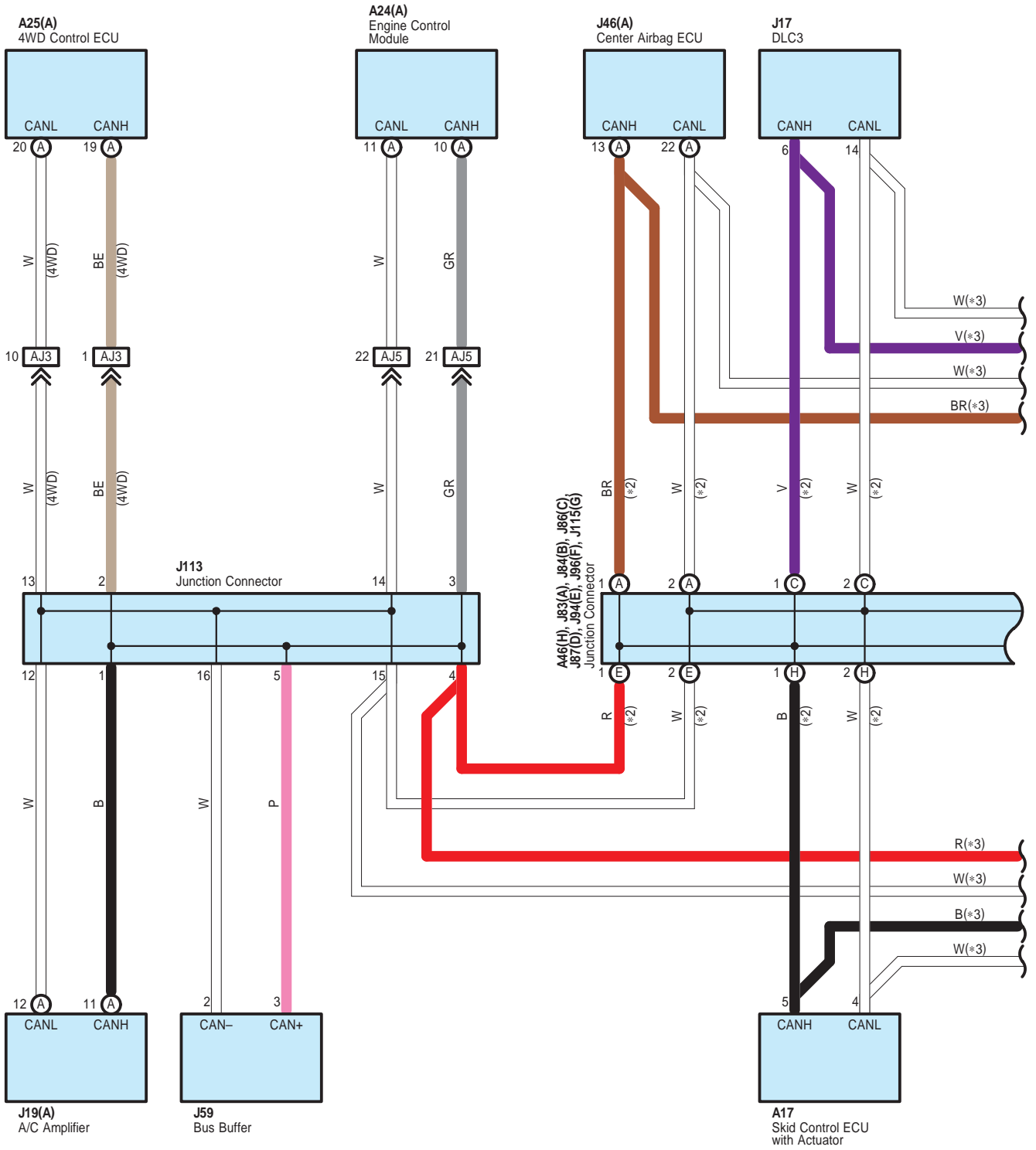

Multiplex Communication System <CAN>

* 2 : Before Nov. 2009 Production
 * 3 : From Nov. 2009 Production

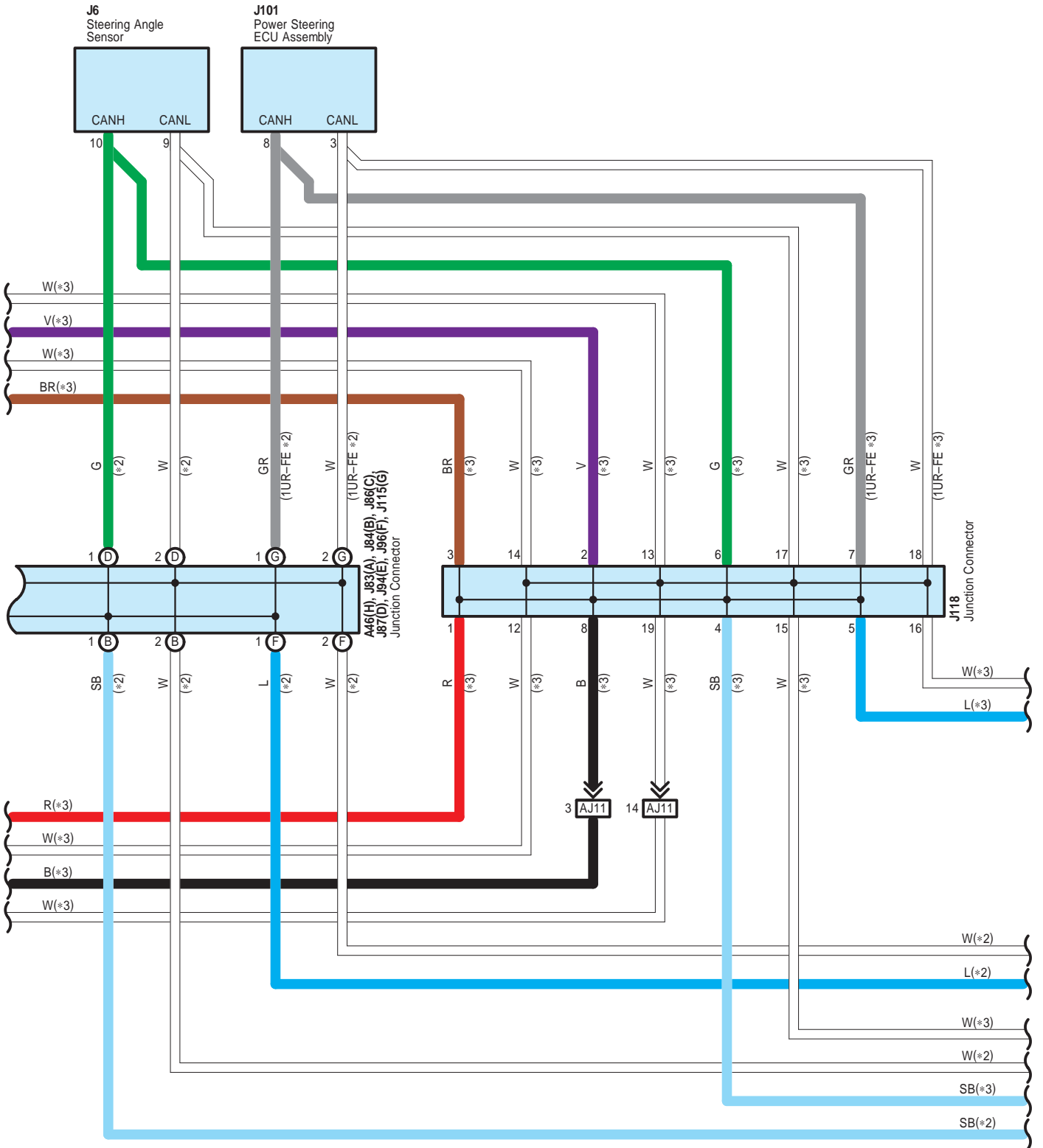

Multiplex Communication System <CAN>

- * 1 : w/ Seat Position Memory
- * 2 : Before Nov. 2009 Production
- * 3 : From Nov. 2009 Production

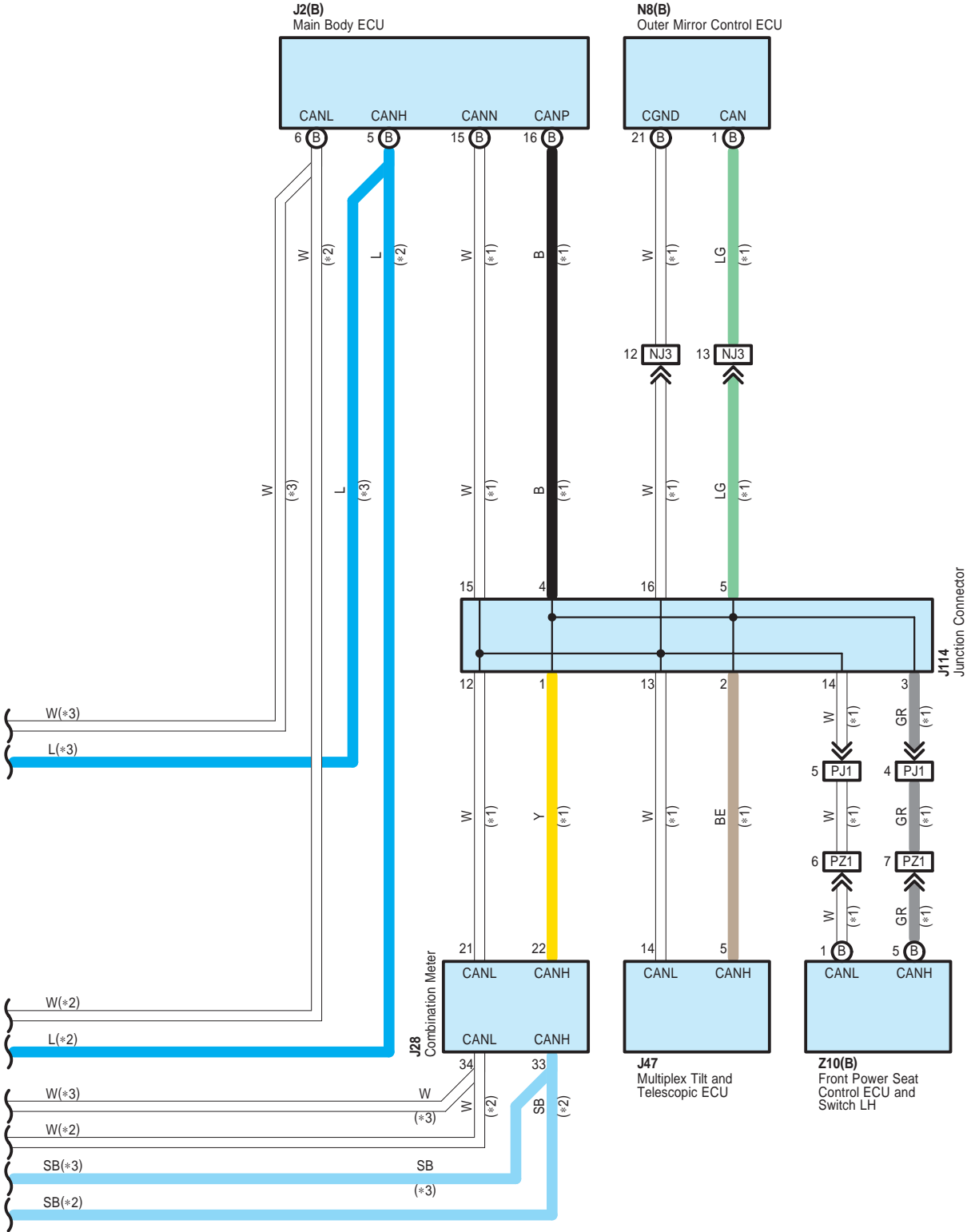

A 17
Black

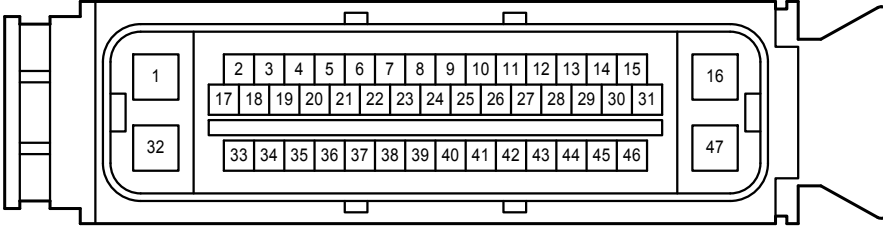

A 24
Black

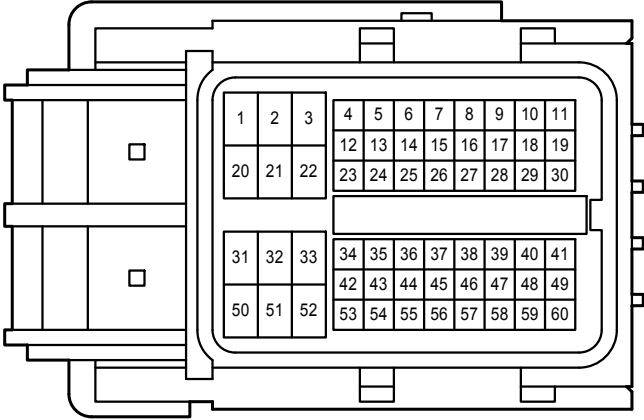

A 25
Black

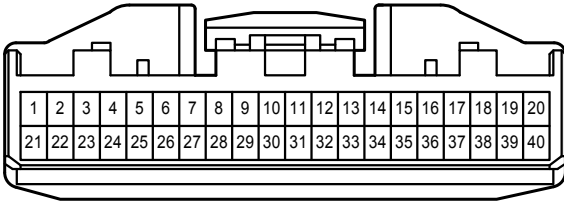

A 46
White

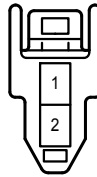

J 2
White

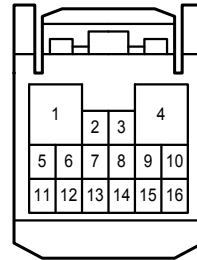

J 6
Gray

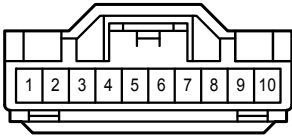

J 17
White

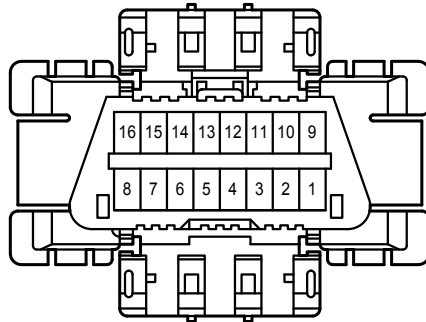

J 19
White

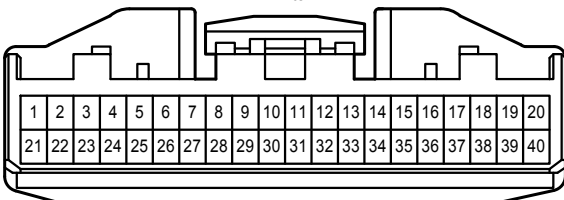

J 28
White

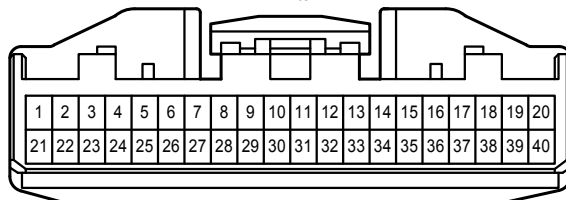

Multiplex Communication System <CAN>

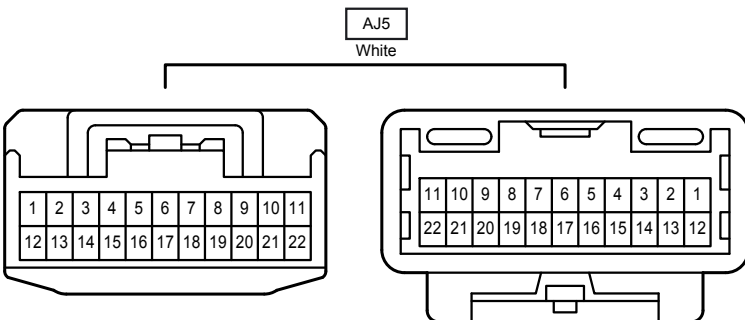
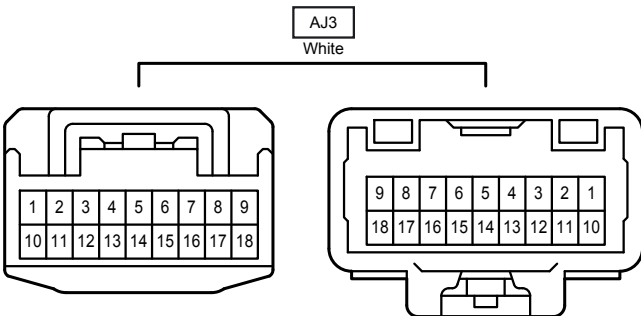
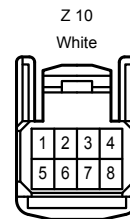
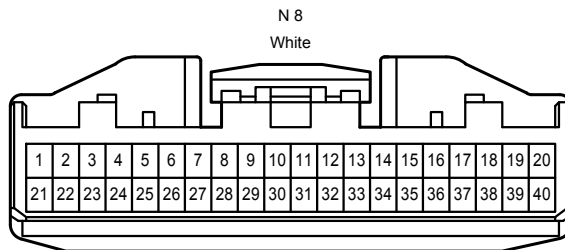
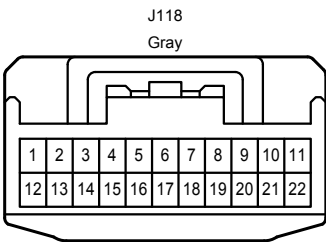
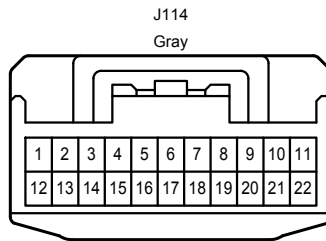
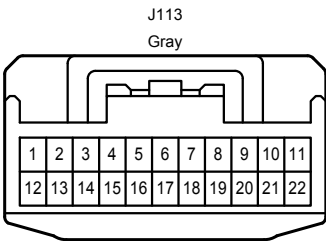
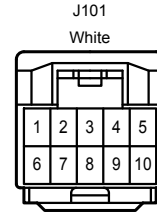
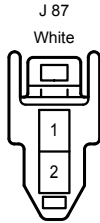
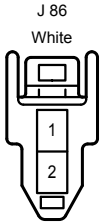
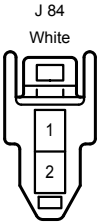
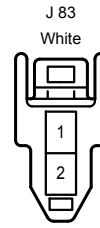
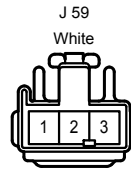
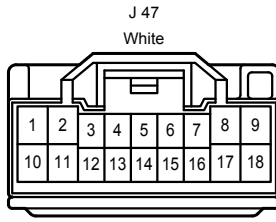
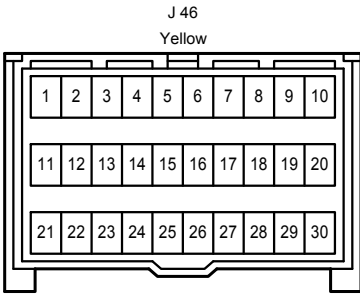

AJ11
Gray

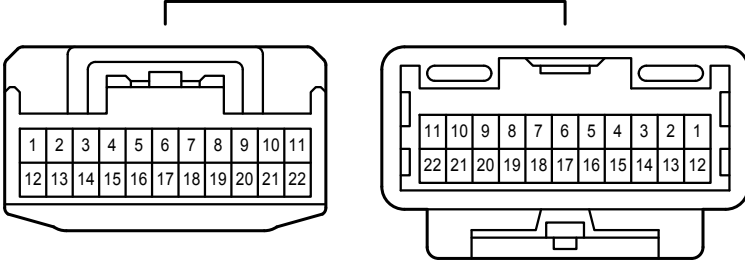

NJ3
Blue

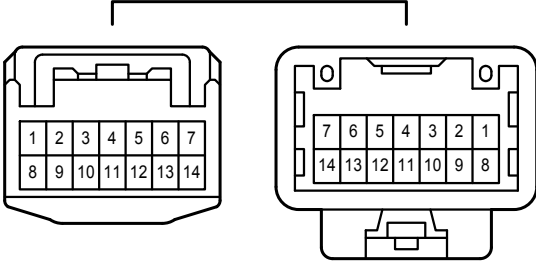

PJ1
Black

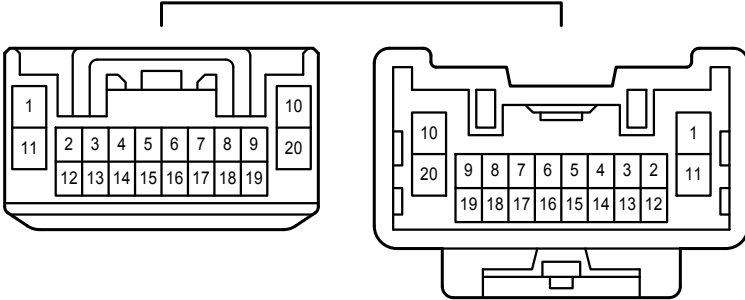

PZ1
White

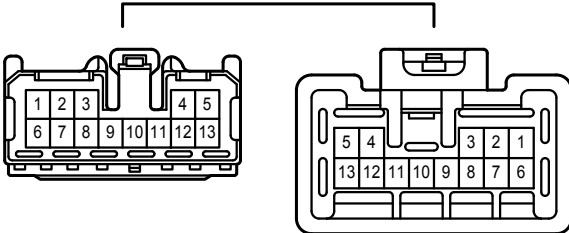

Parking Assist <Intuitive Parking Assist>

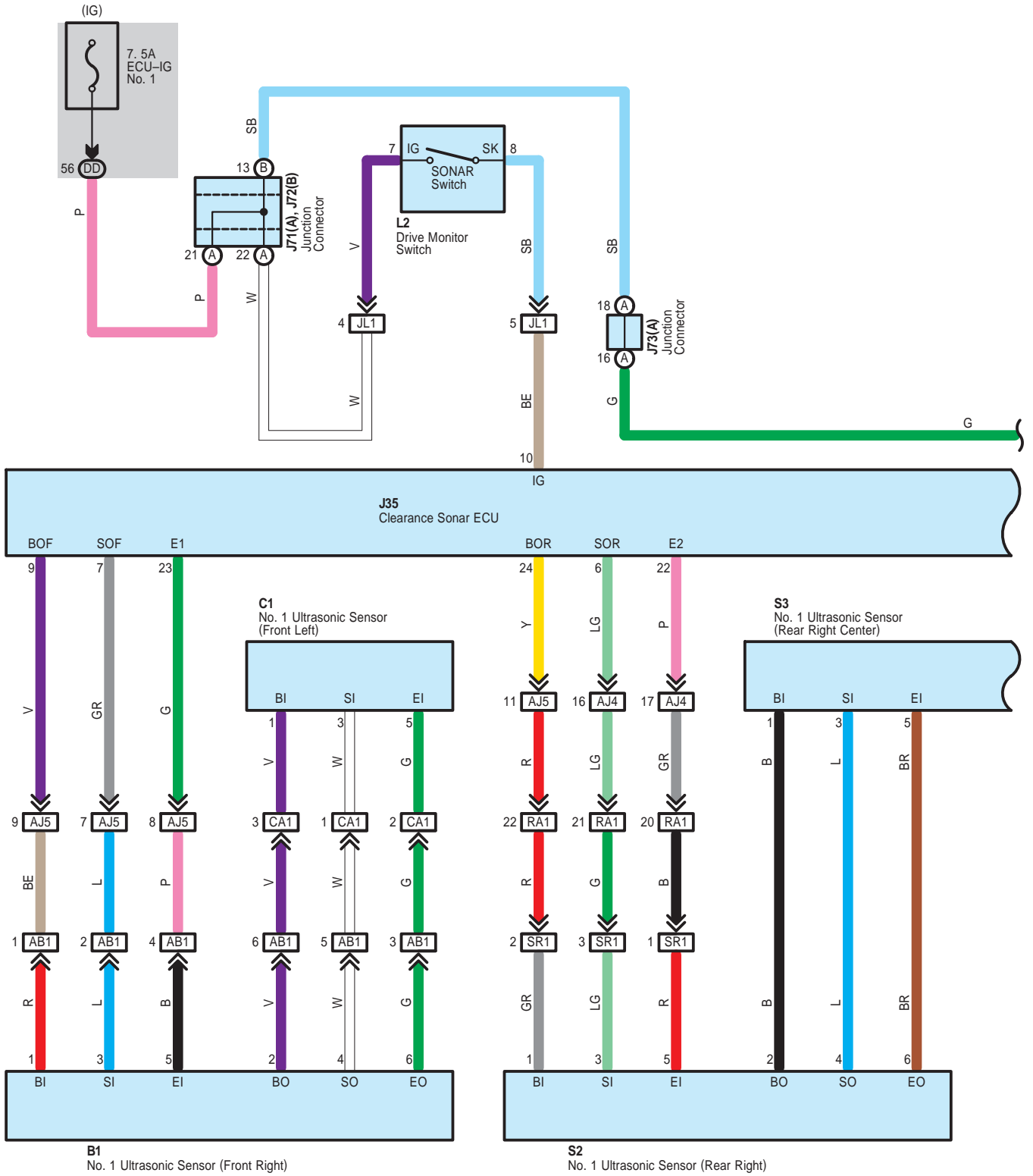

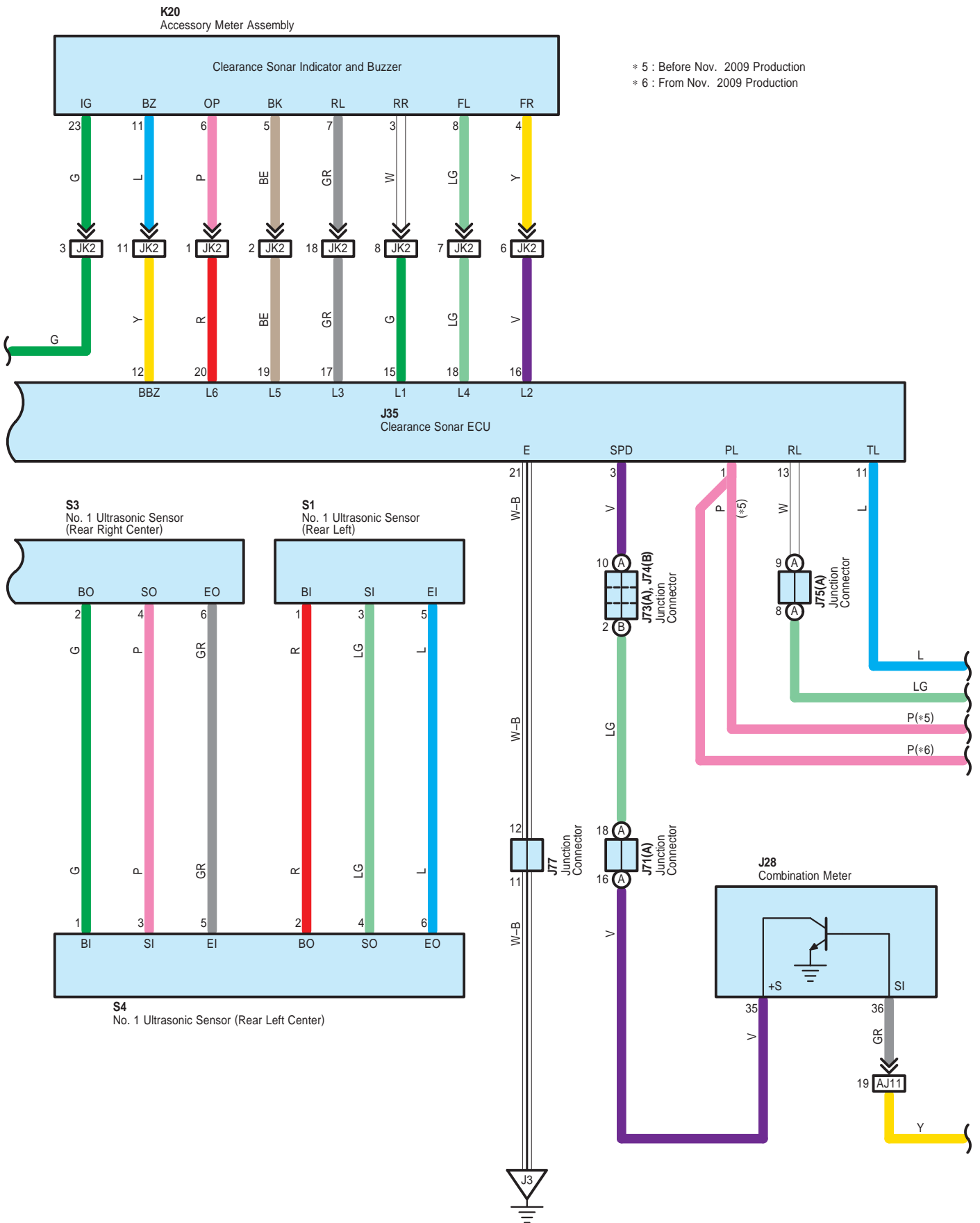

Parking Assist <Intuitive Parking Assist>

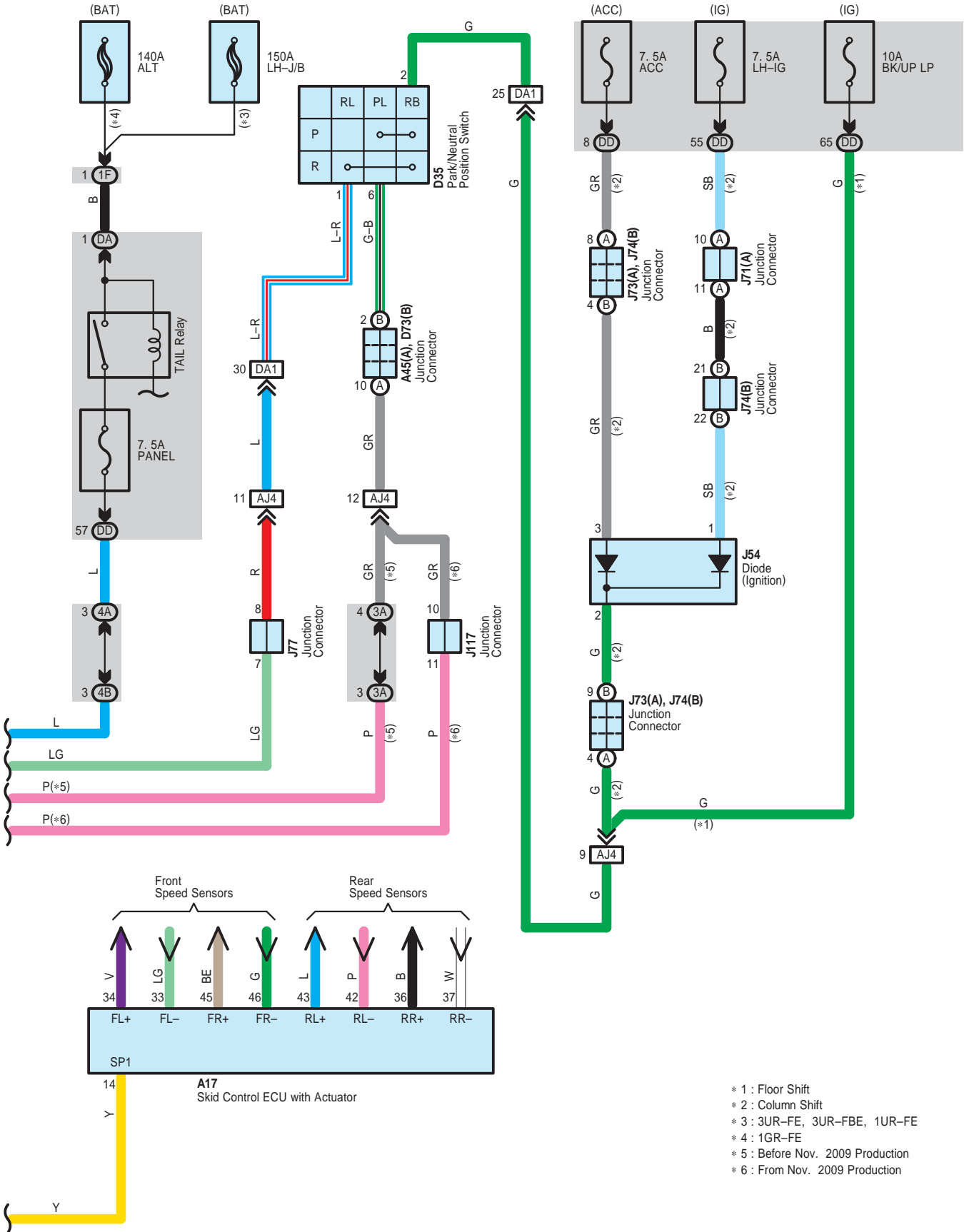

Parking Assist <Intuitive Parking Assist>

A 17
Black

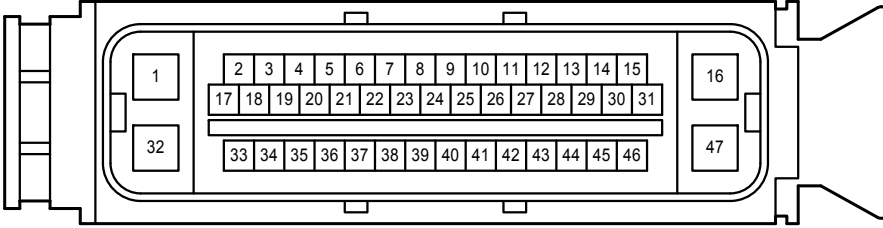

A 45
Blue

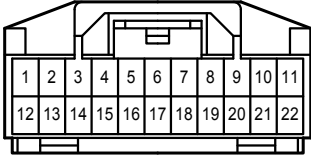

B 1
Black



C 1
Black

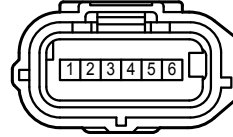

D 35
Gray

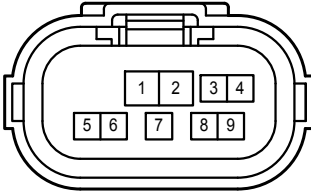

D 73
Blue

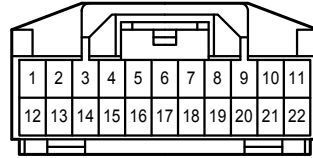

J 28
White

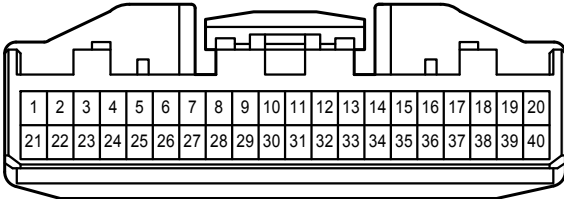

J 35
White

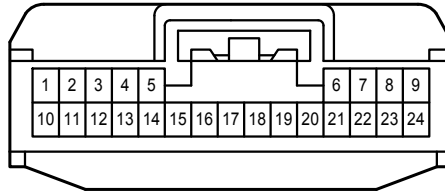

J 54
Orange

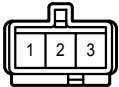

J 71
Black

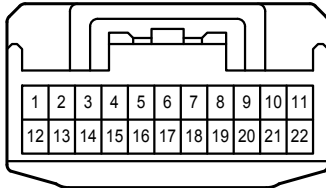

J 72
Black

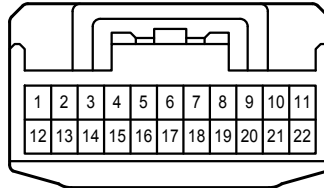

J 73
Black

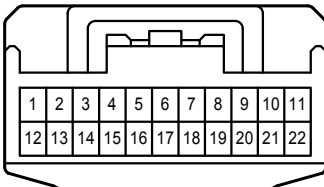

J 74
Black

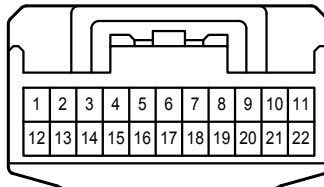

J 75
White

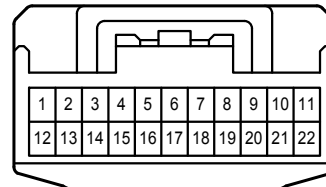

Parking Assist <Intuitive Parking Assist>

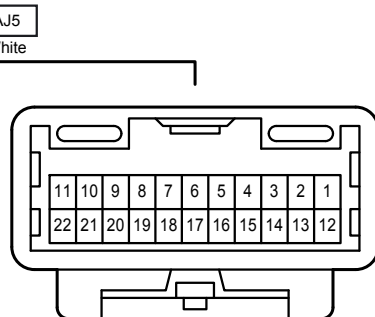
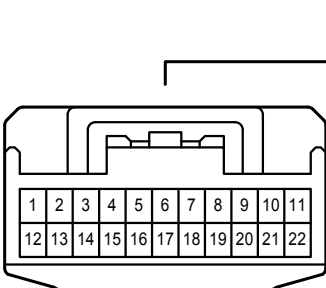
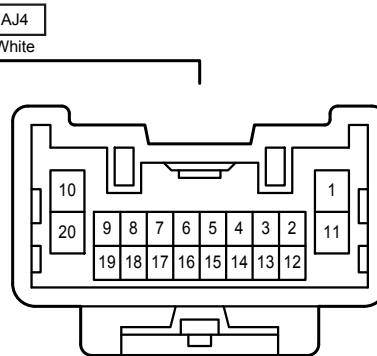
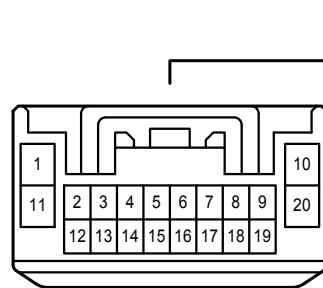
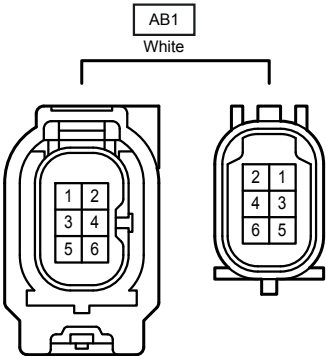
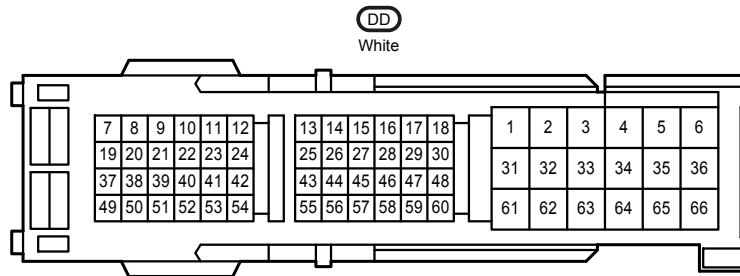
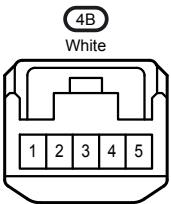
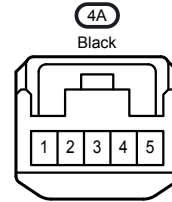
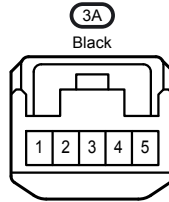
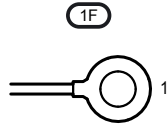
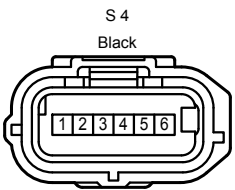
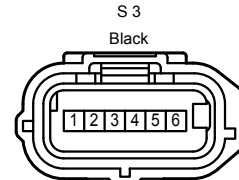
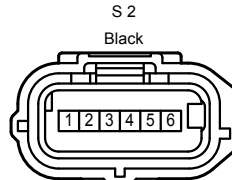
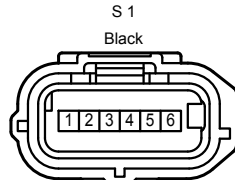
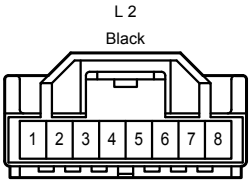
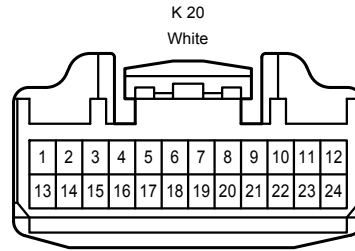
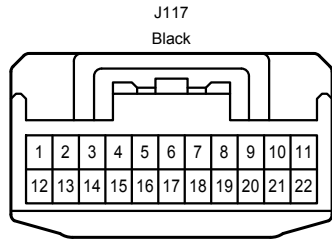
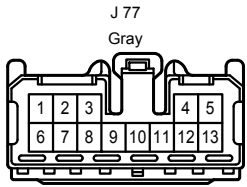

Parking Assist <Intuitive Parking Assist>

AJ11
Gray

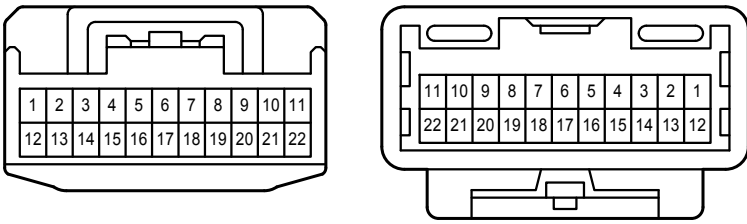

CA1
Black

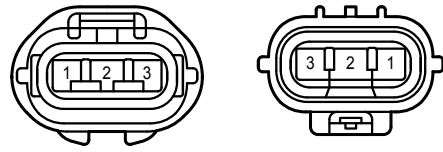

DA1
White

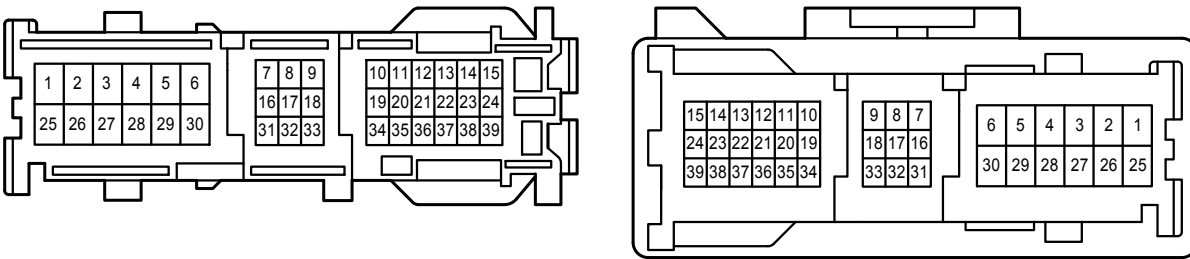

JK2
White

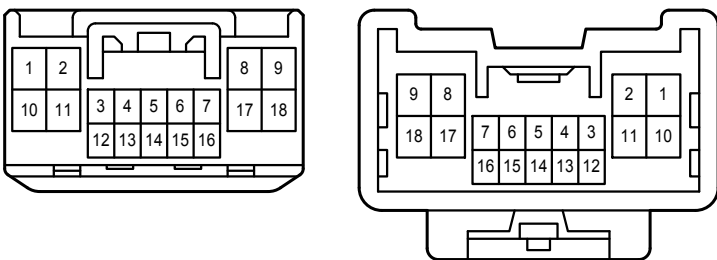

JL1
White

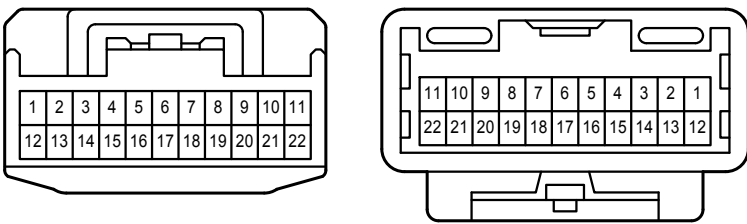

RA1
White

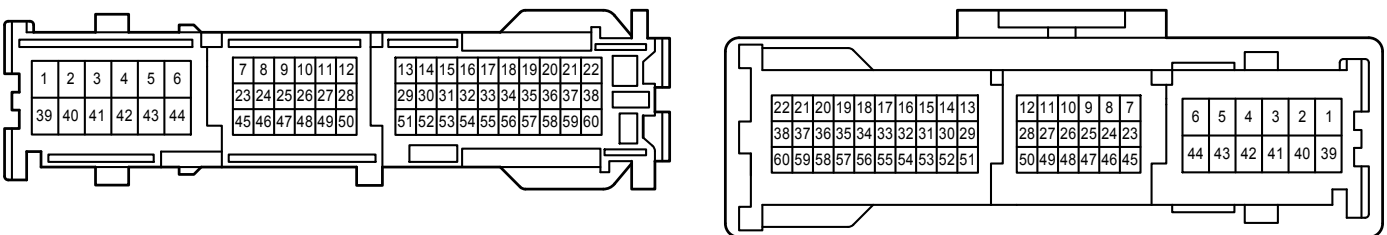

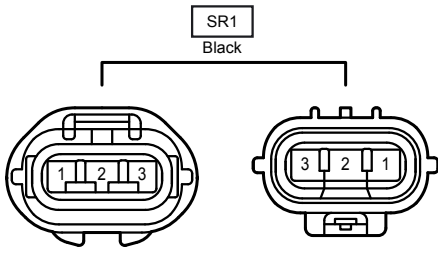

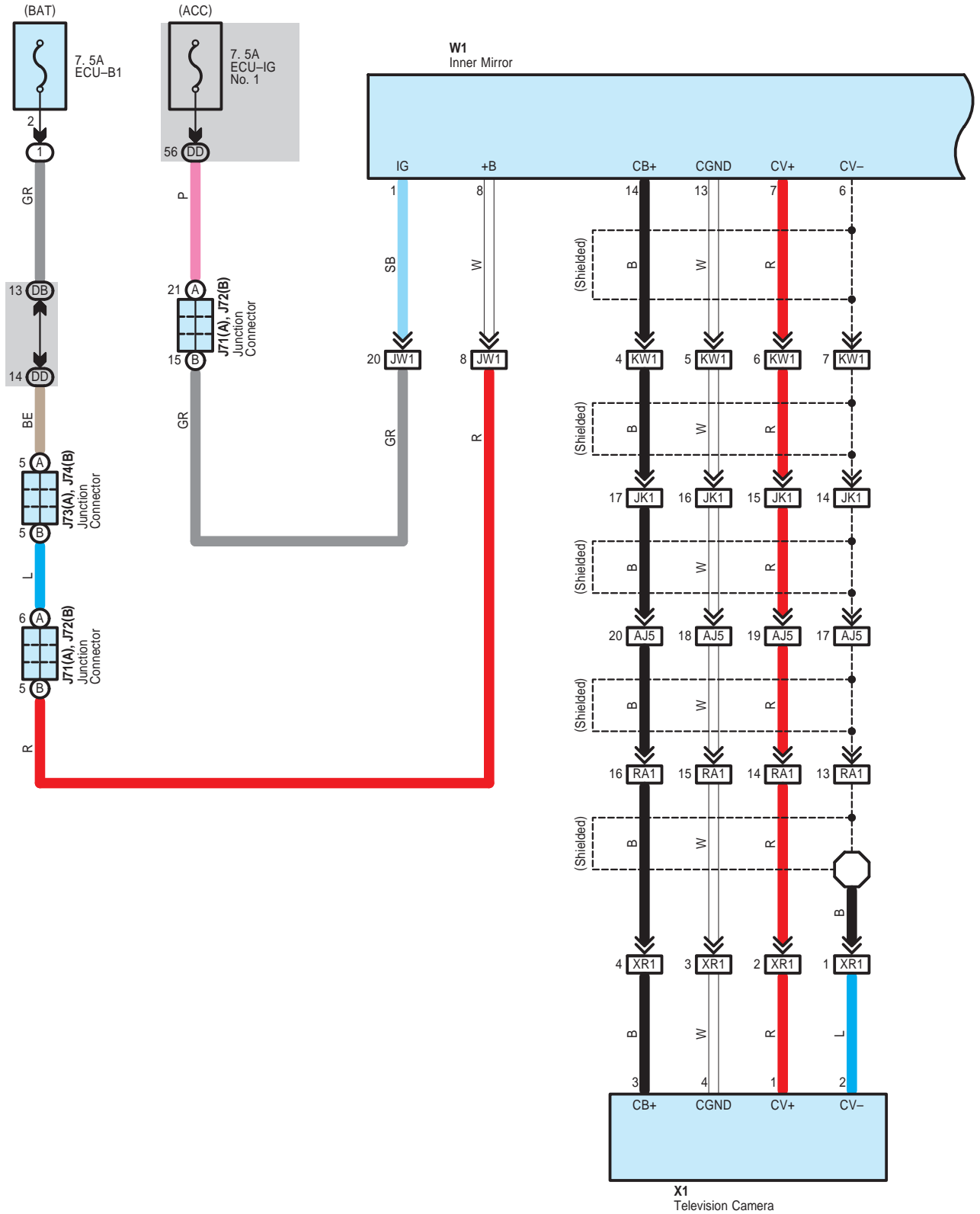

Parking Assist <Rear View Monitor w/o Navigation System>

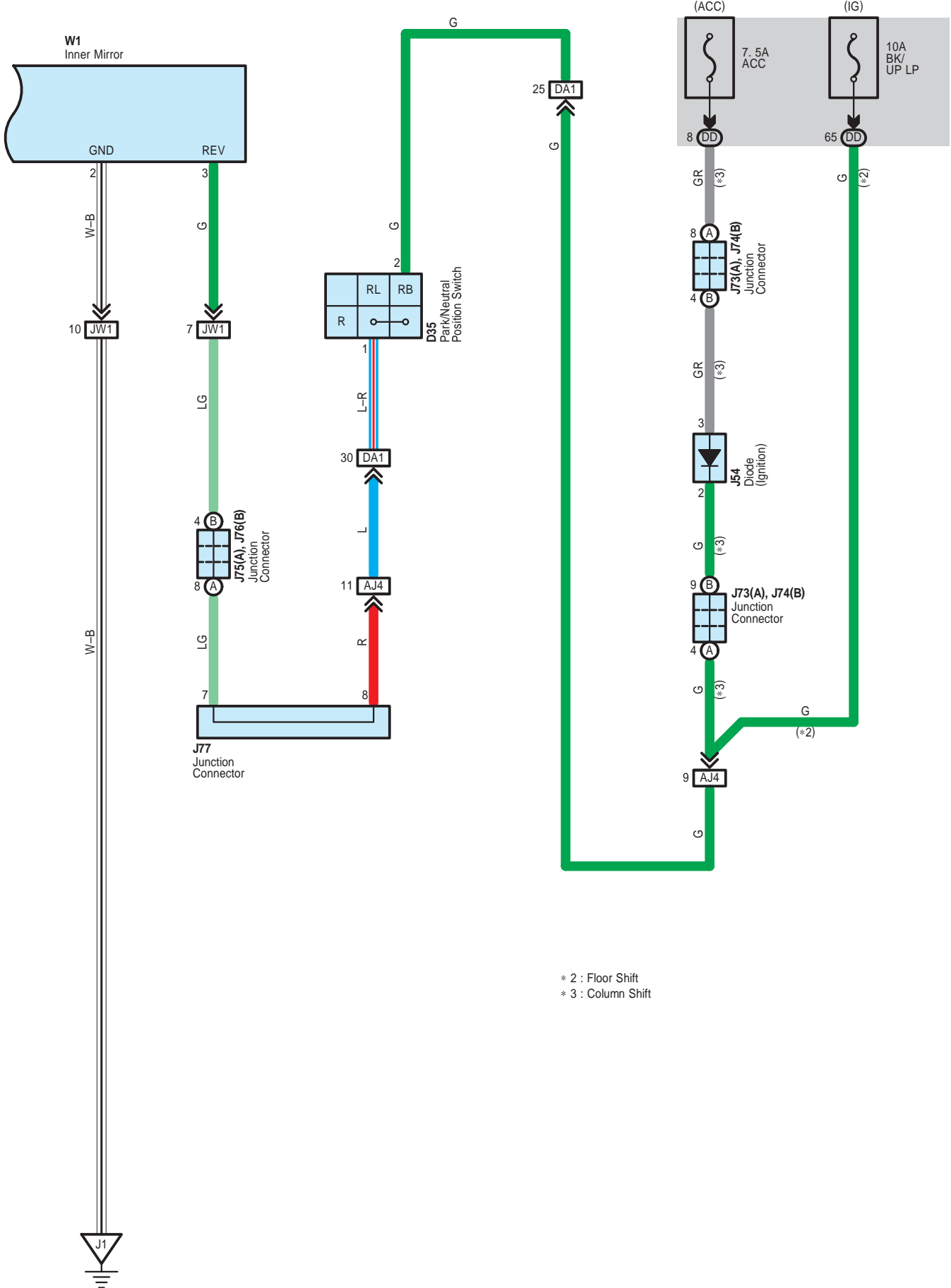

* 2 : Floor Shift
 * 3 : Column Shift

Parking Assist <Rear View Monitor w/o Navigation System>

D 35
Gray

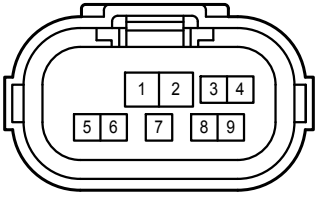

J 54
Orange

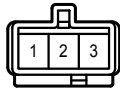

J 71
Black

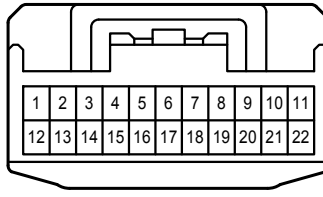

J 72
Black

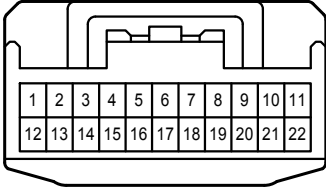

J 73
Black

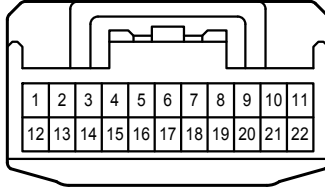

J 74
Black

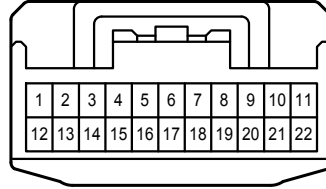

J 75
White

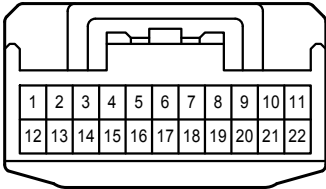

J 76
White

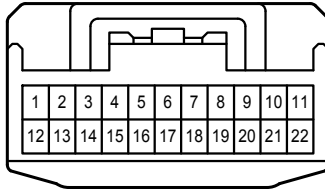

J 77
Gray

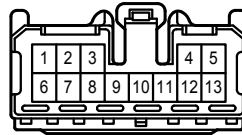

W 1
Black

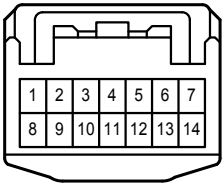

X 1
Dark Gray

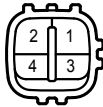

DB
White

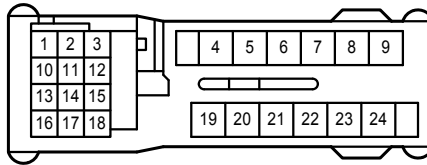

DD
White

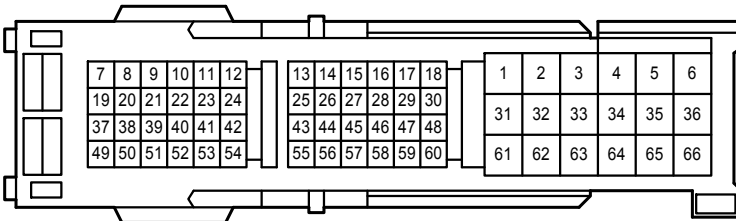

AJ4
White

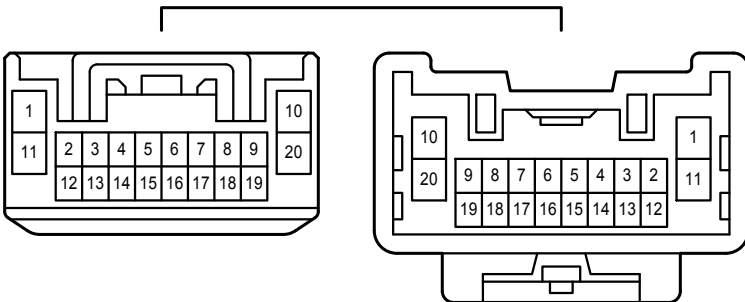

Parking Assist <Rear View Monitor w/o Navigation System>

AJ5
White

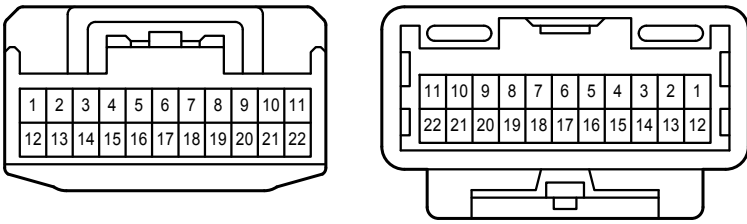

DA1
White

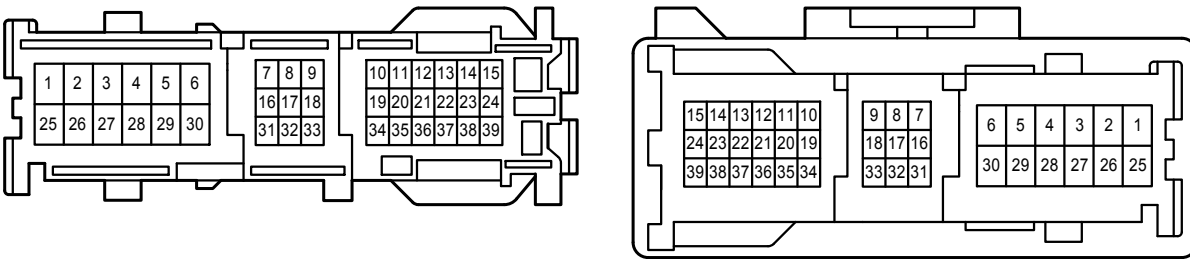

JK1
White

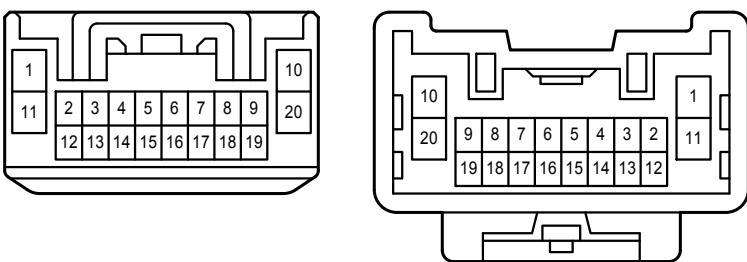

JW1
White

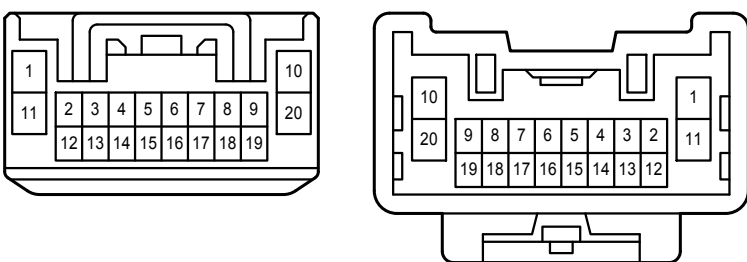

KW1
White

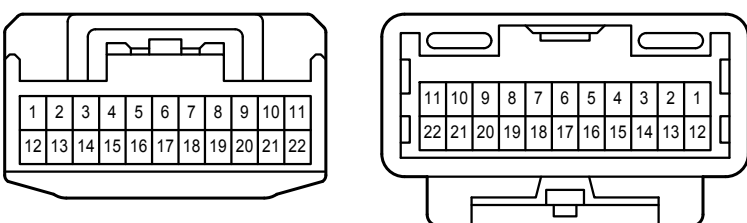

Parking Assist <Rear View Monitor w/o Navigation System>

RA1
White

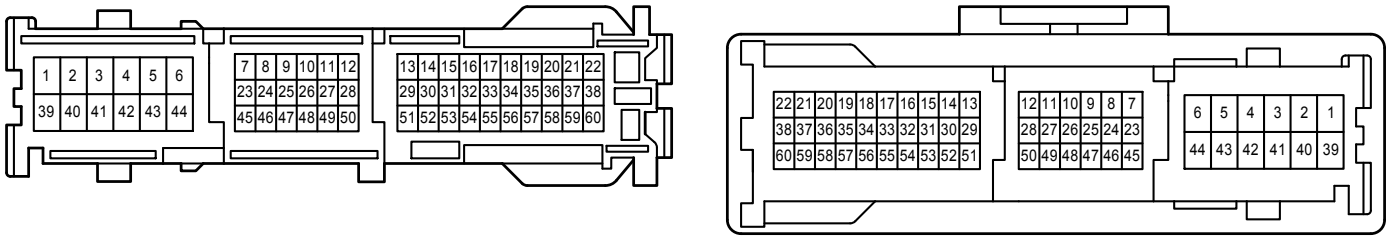

XR1
White

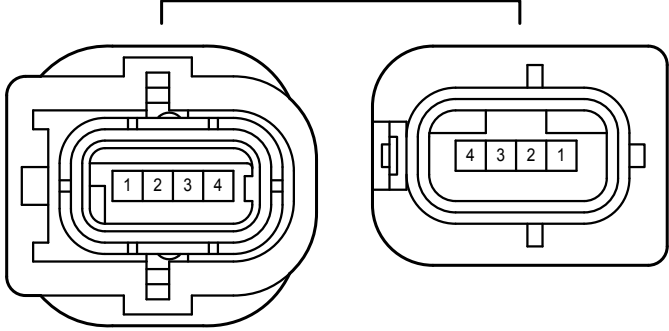

Power Outlet <115V>

* 1 : Floor Shift
 * 2 : Column Shift

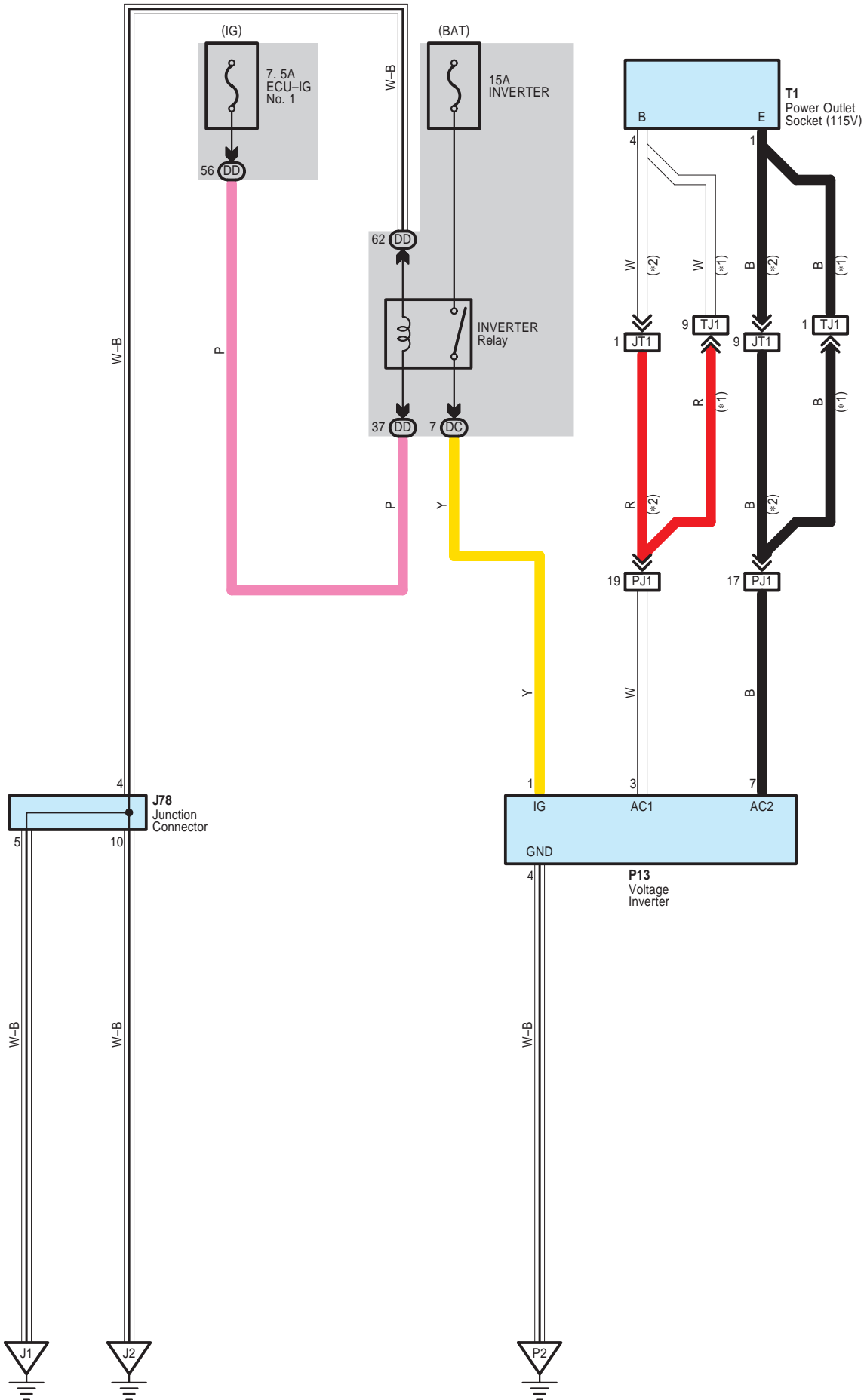

Power Outlet <115V>

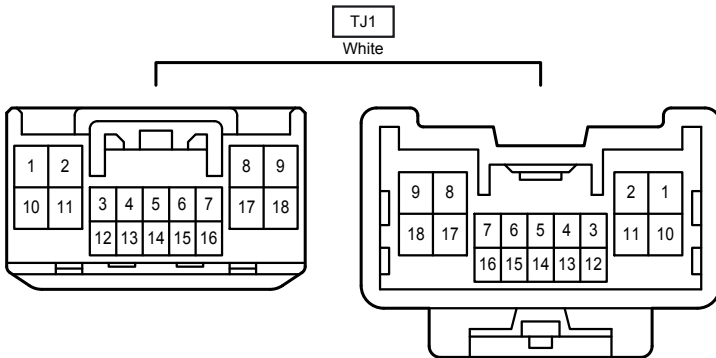
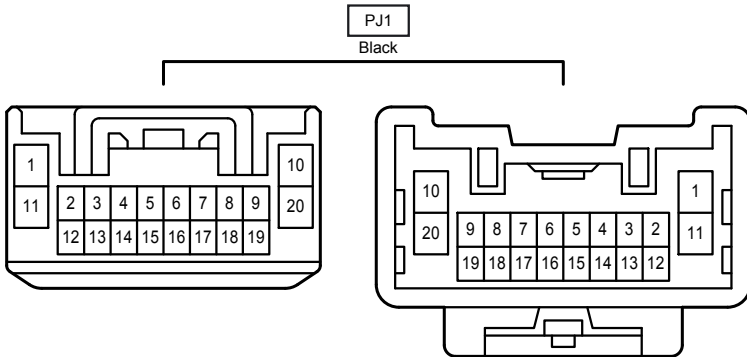
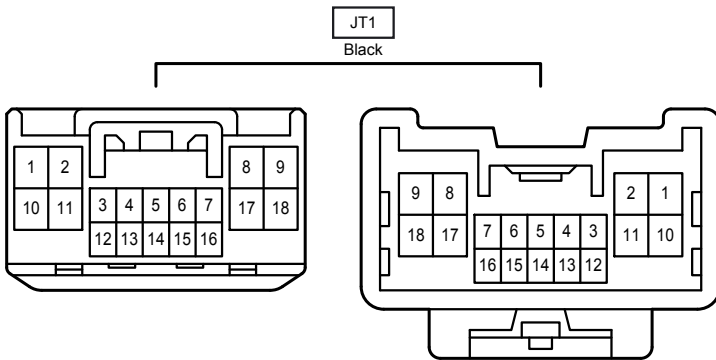
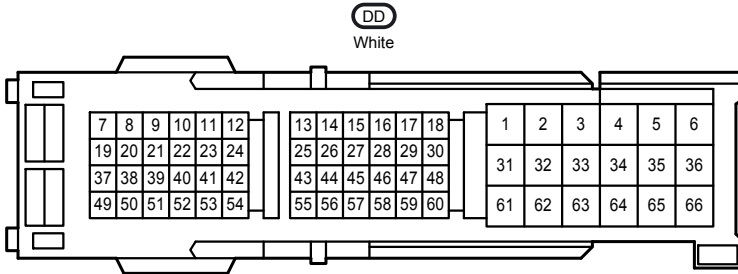
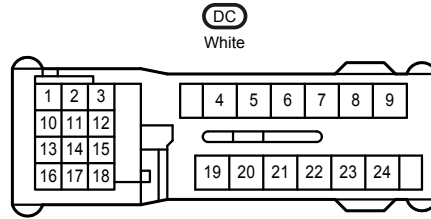
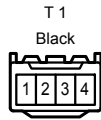
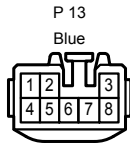
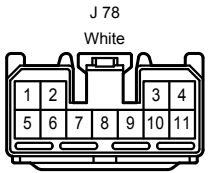

Power Outlet <12V>

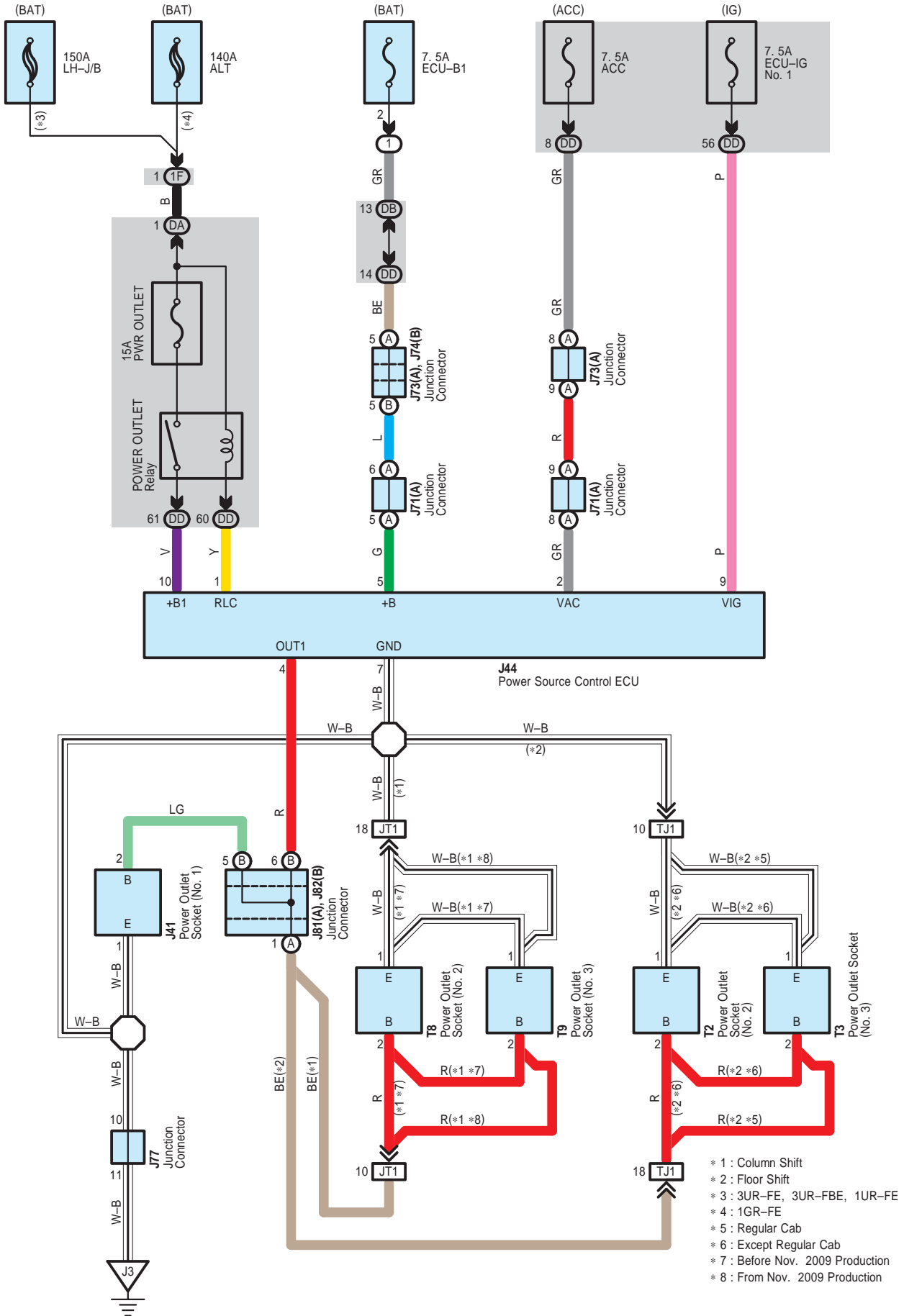

Power Outlet <12V>

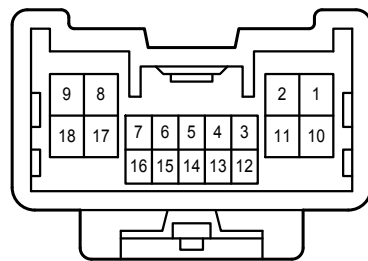
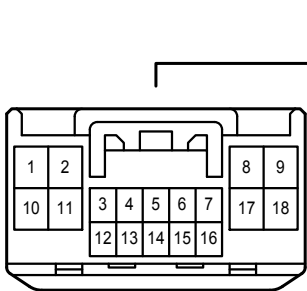
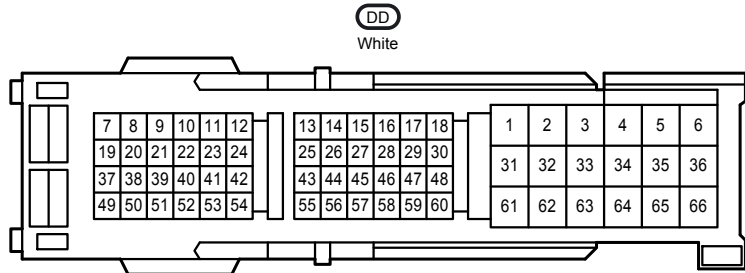
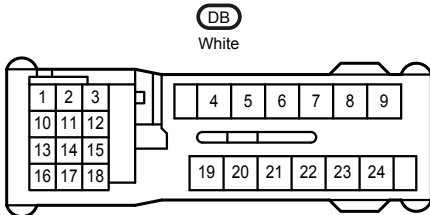
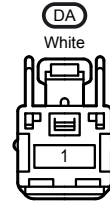
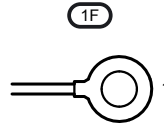
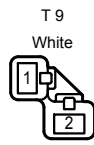
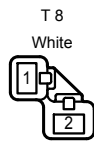
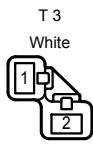
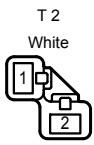
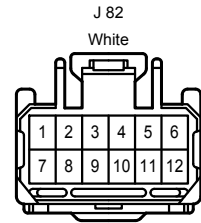
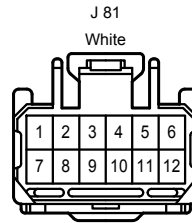
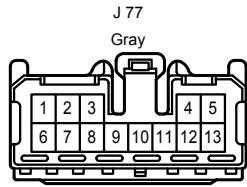
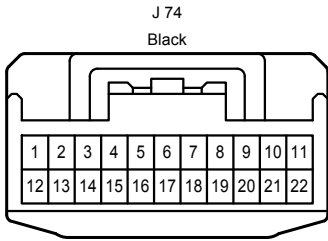
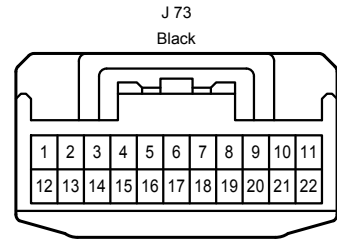
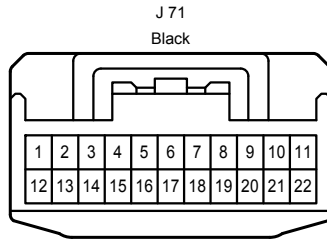
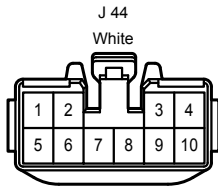
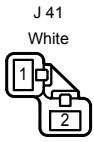

TJ1
White

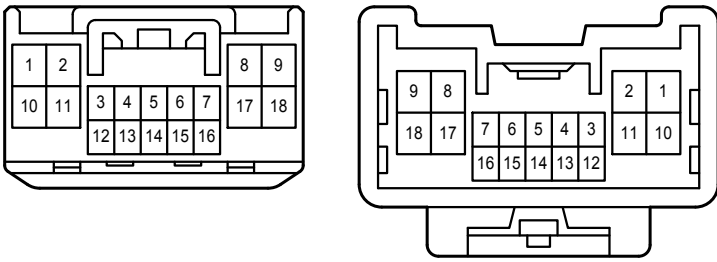

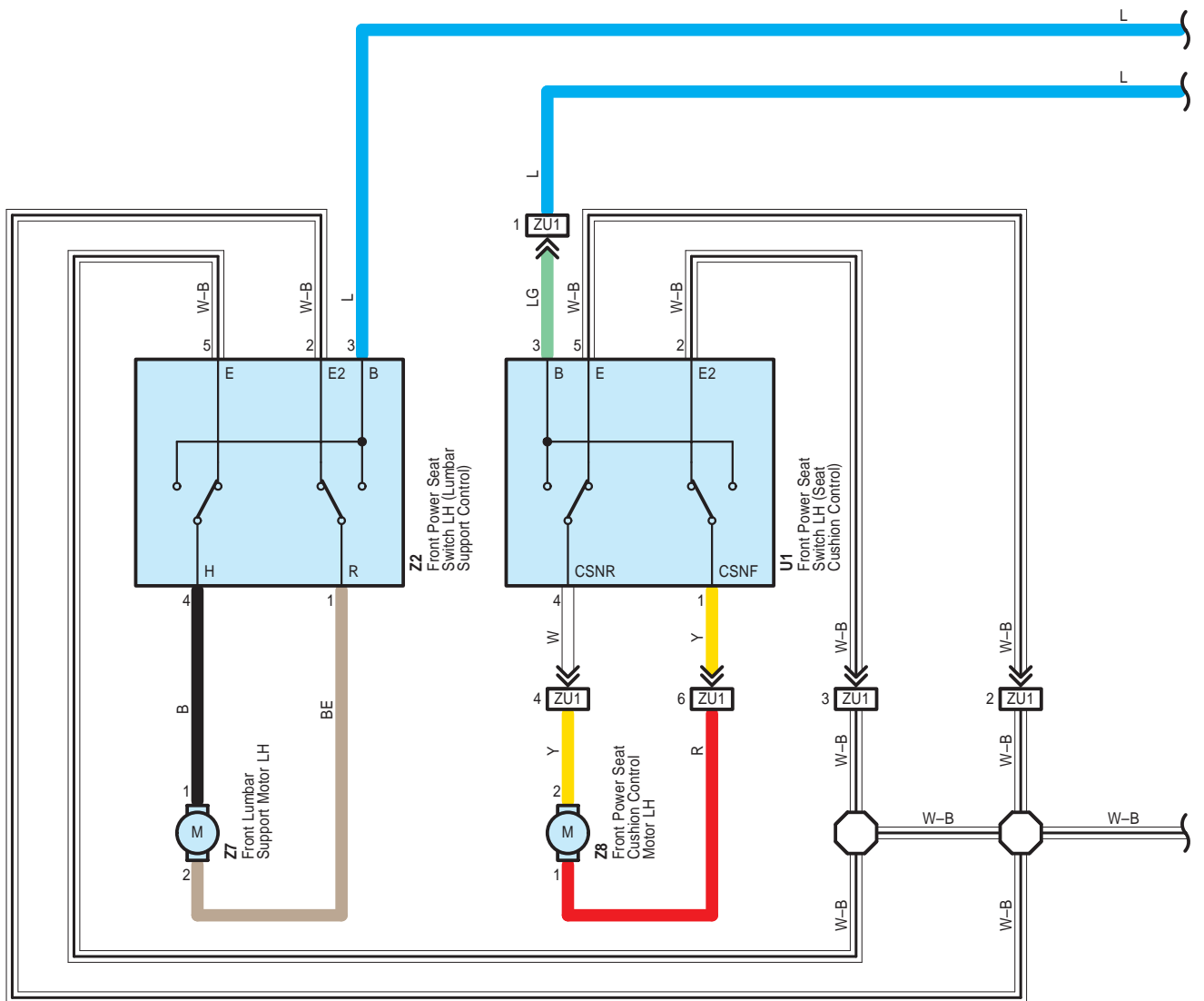

Power Seat <Driver's Seat w/ Seat Position Memory>

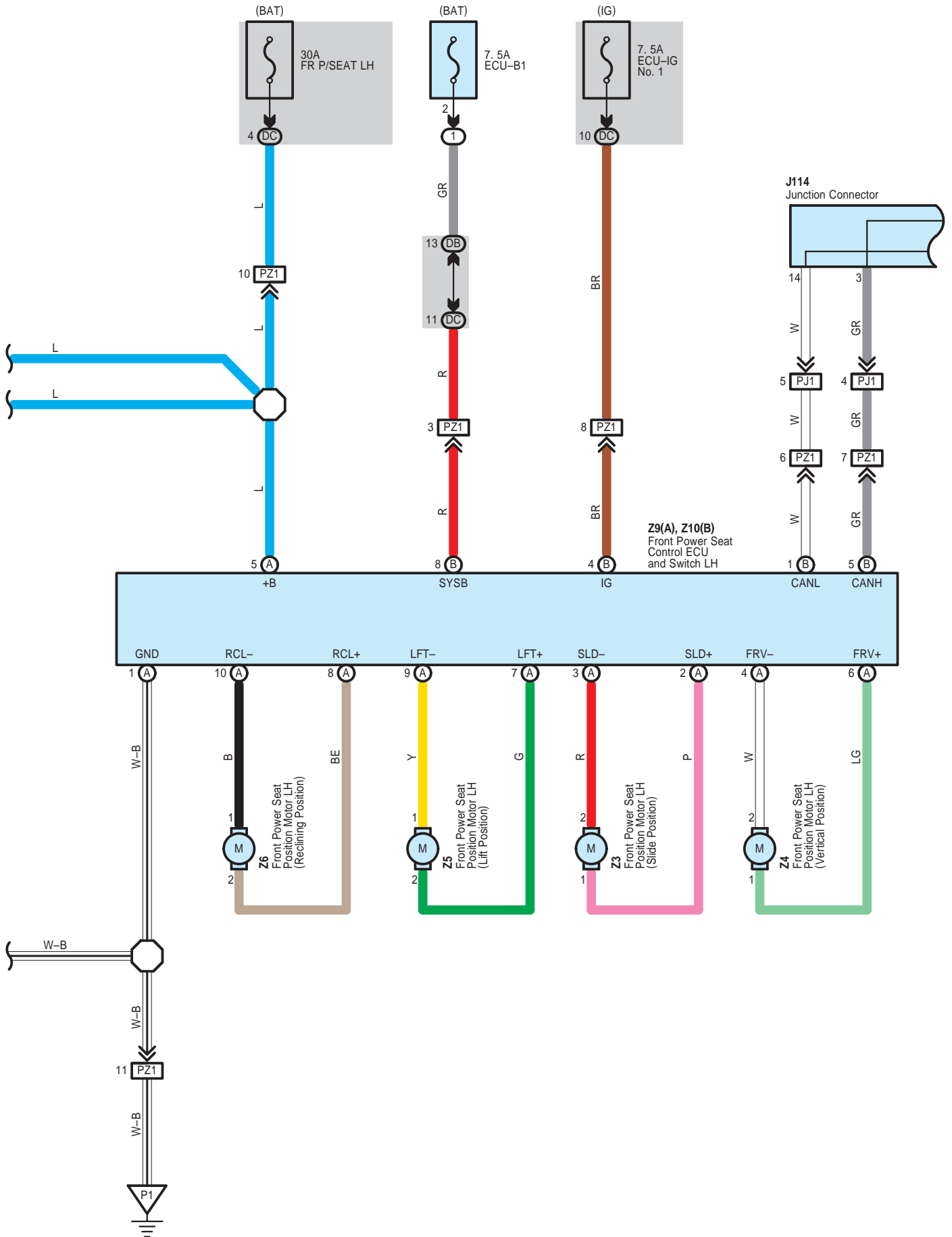

Power Seat <Driver's Seat w/ Seat Position Memory>

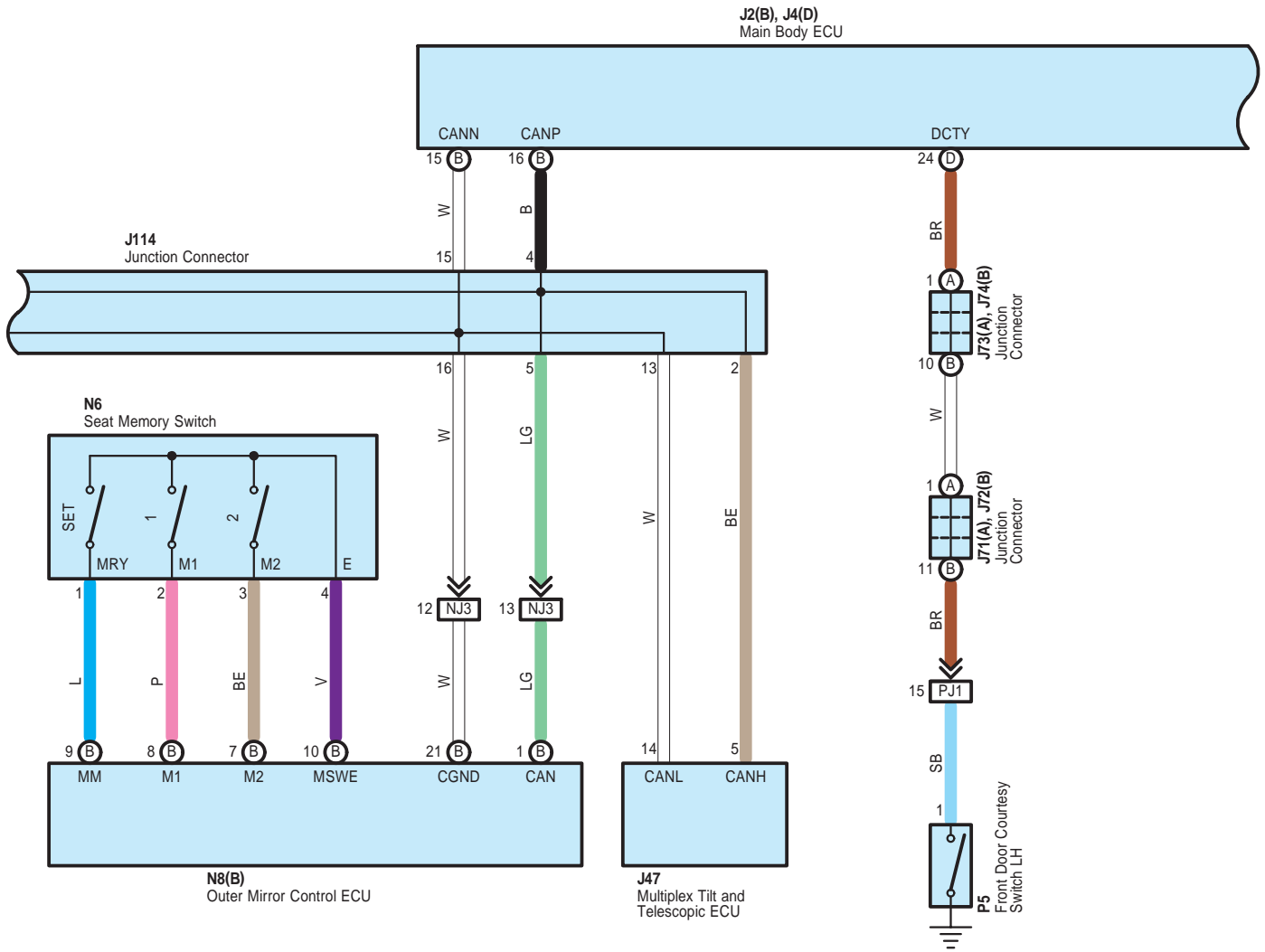

Power Seat <Driver's Seat w/ Seat Position Memory>

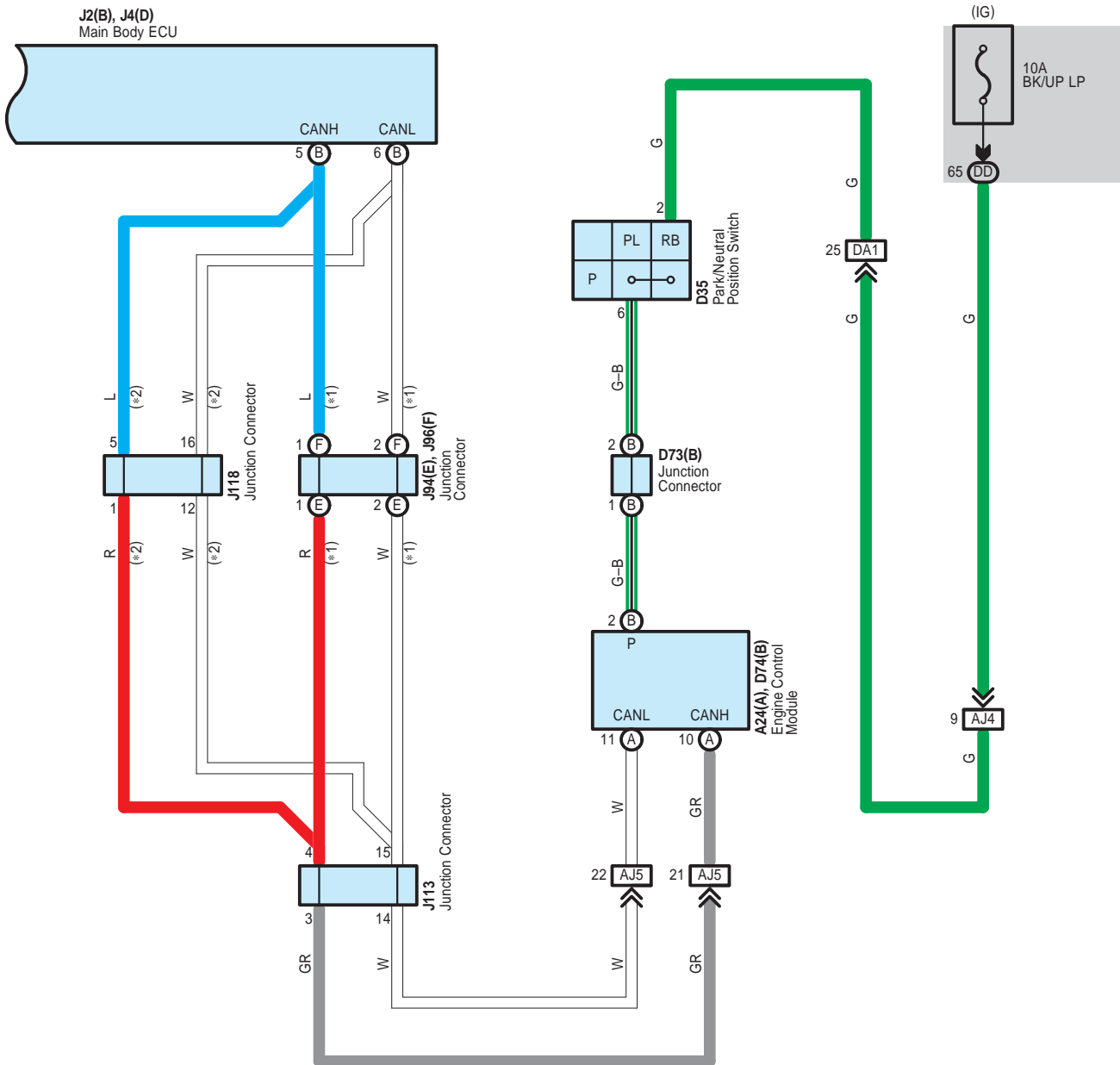

* 1 : Before Nov. 2009 Production
 * 2 : From Nov. 2009 Production

Power Seat <Driver's Seat w/ Seat Position Memory>

A 24
Black

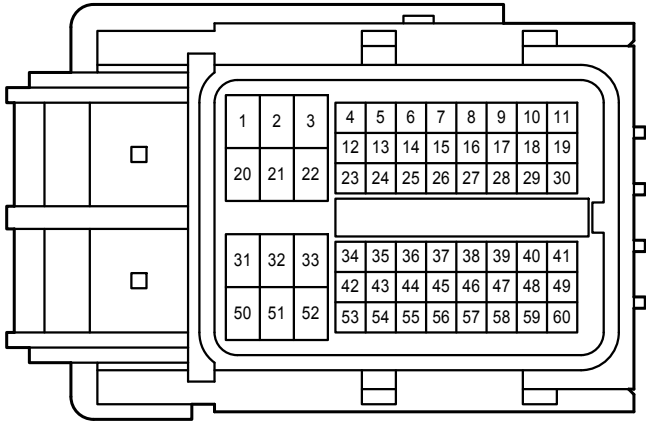

D 35
Gray

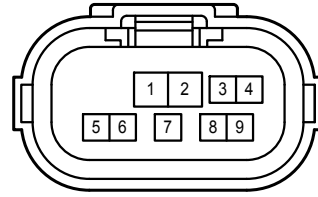

D 73
Blue

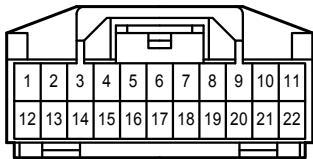

D 74
Black

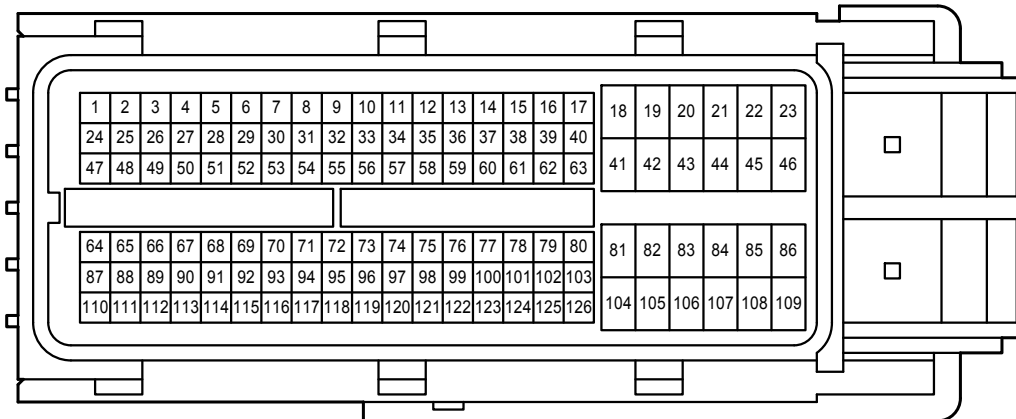

J 2
White

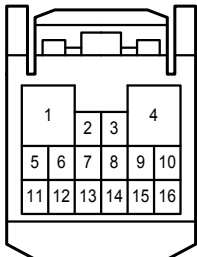

J 4
White

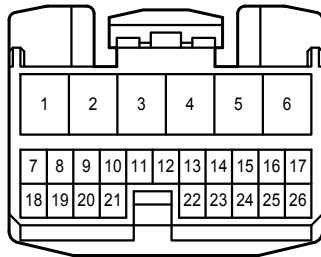

J 47
White

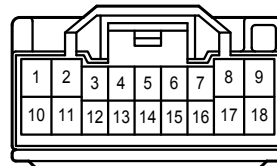

Power Seat <Driver's Seat w/ Seat Position Memory>

J 71
Black

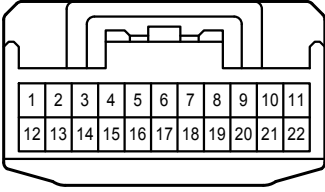

J 72
Black

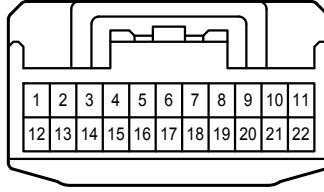

J 73
Black

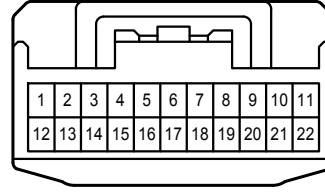

J 74
Black

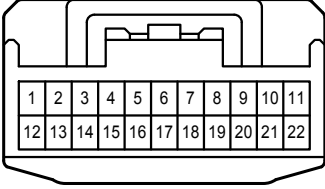

J 94
White

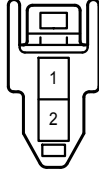

J 96
White

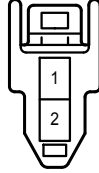

J113
Gray

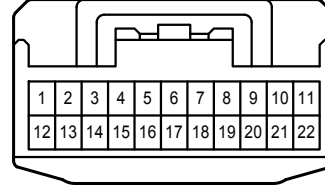

J114
Gray

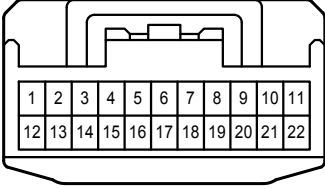

J118
Gray

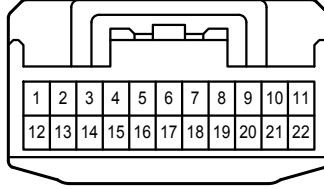

N 6
White



N 8
White

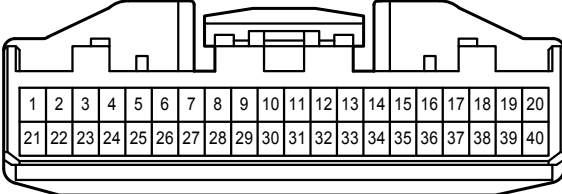

P 5
White



U 1
White

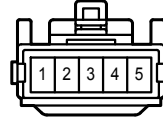

Z 2
White

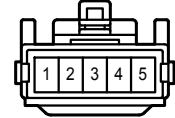

Z 3
White

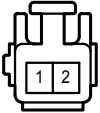

Z 4
White

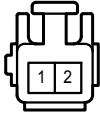

Z 5
White

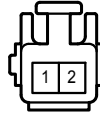

Z 6
White

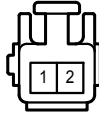

Z 7
White

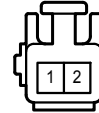

Z 8
White

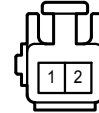

Z 9
White

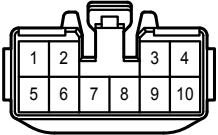

Z 10
White

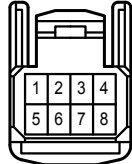

DB
White

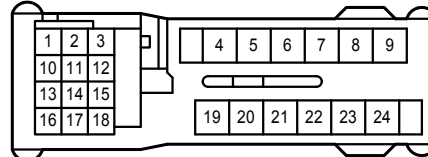

Power Seat <Driver's Seat w/ Seat Position Memory>

DC
White

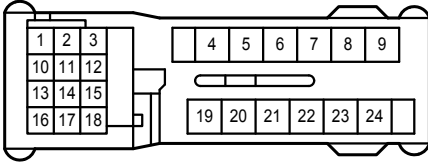

DD
White

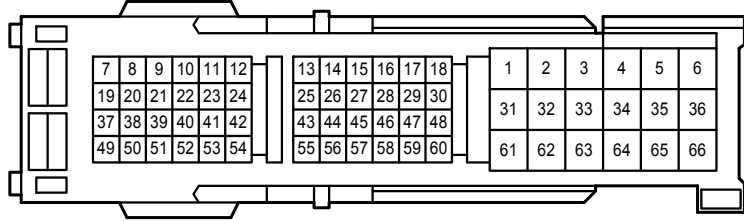

AJ4
White

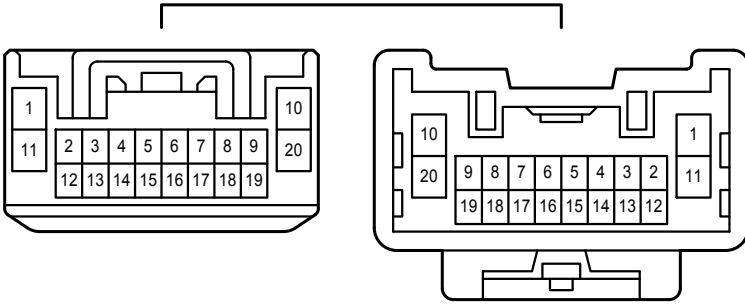

AJ5
White

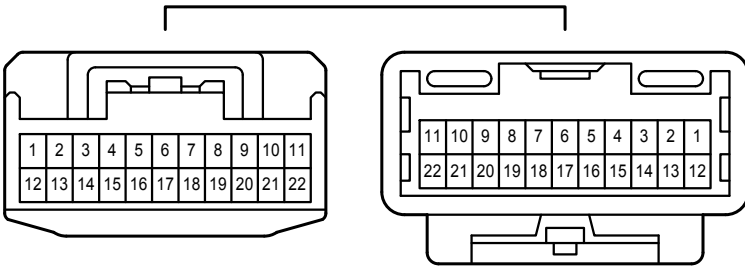

DA1
White

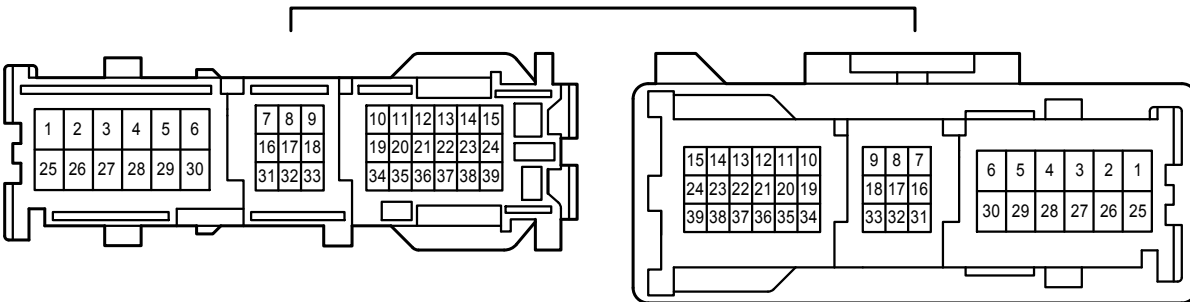

NJ3
Blue

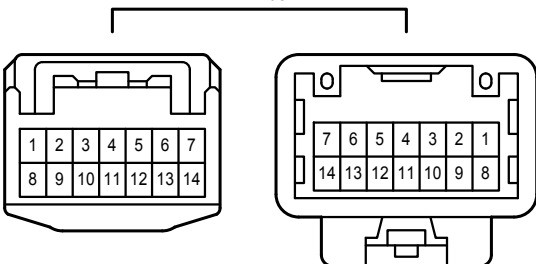

Power Seat <Driver's Seat w/ Seat Position Memory>

PJ1
Black

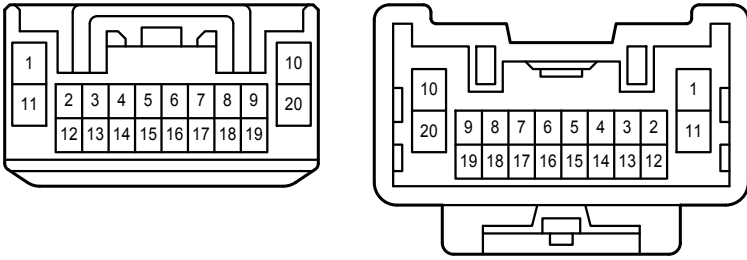

PZ1
White

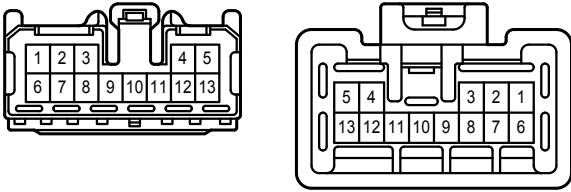

ZU1
White

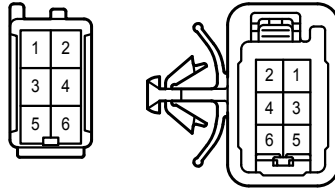

Power Seat <Driver's Seat w/o Seat Position Memory>

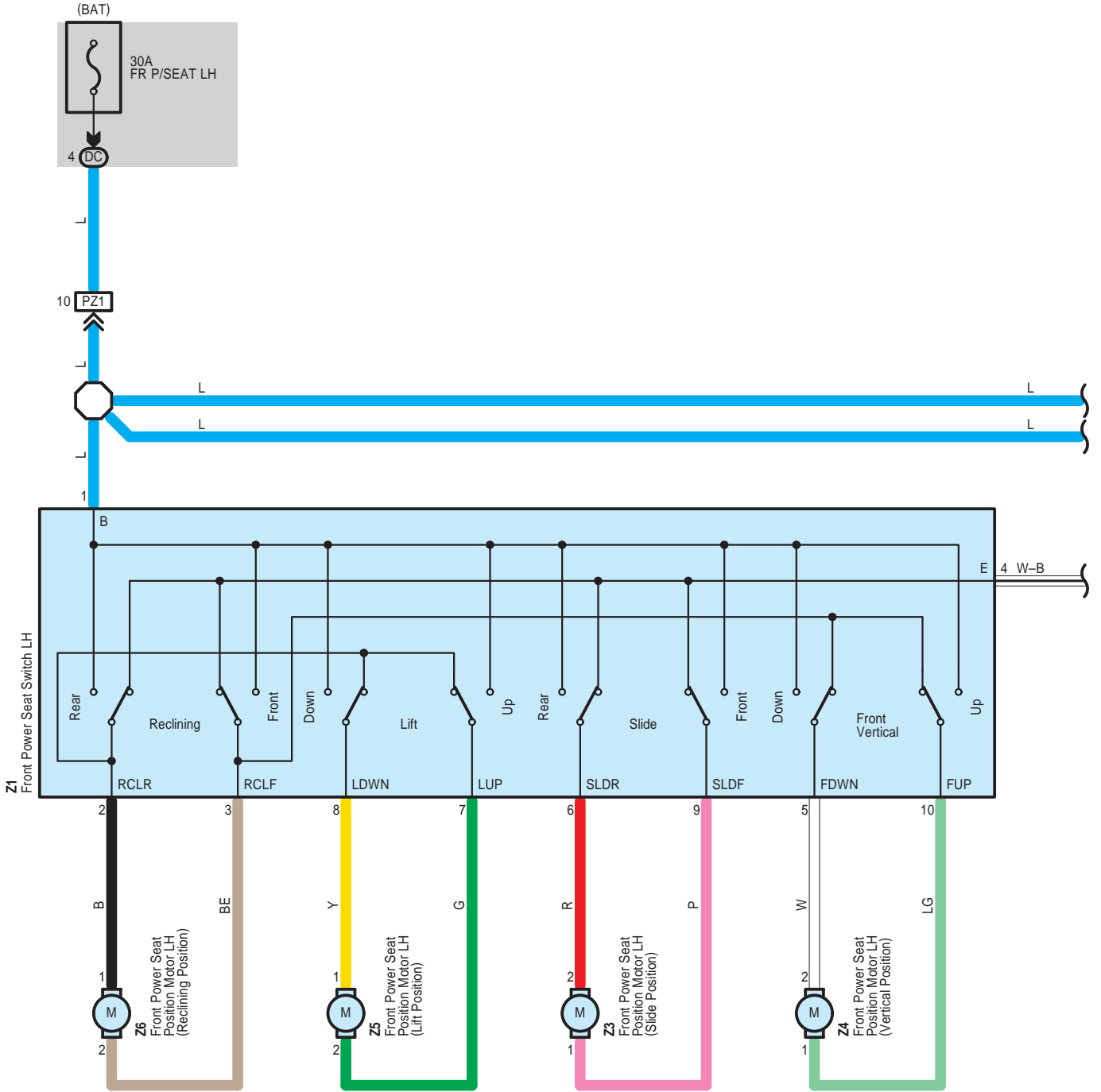

Power Seat <Driver's Seat w/o Seat Position Memory>

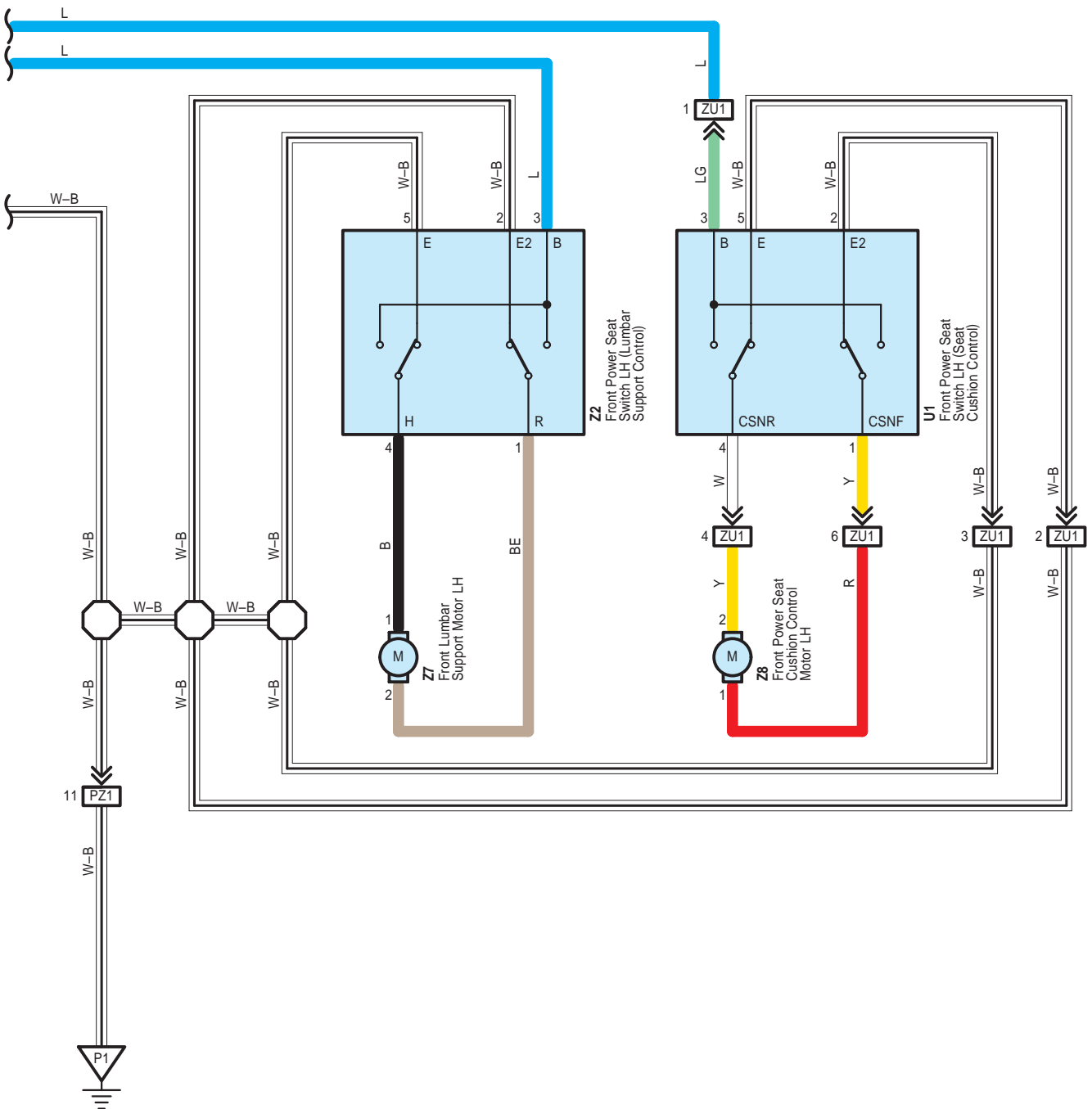

Power Seat <Driver's Seat w/o Seat Position Memory>

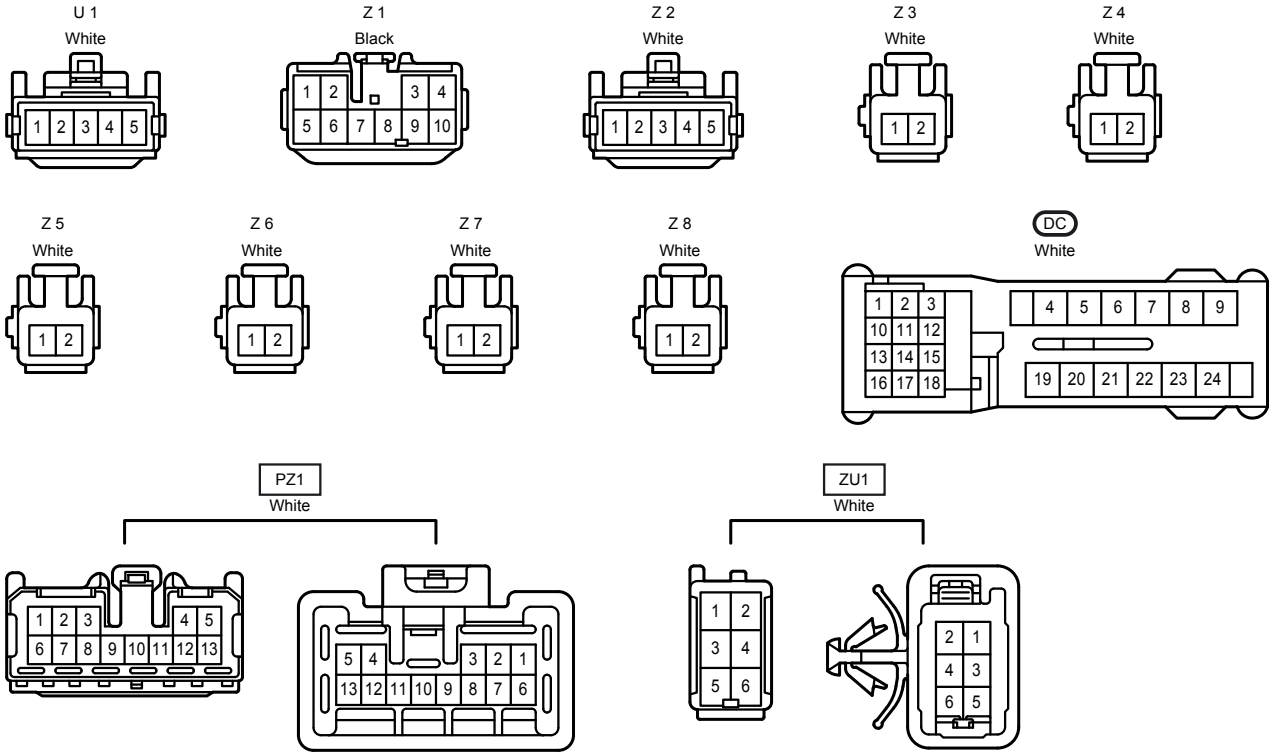

Power Seat <Front Passenger's Seat>

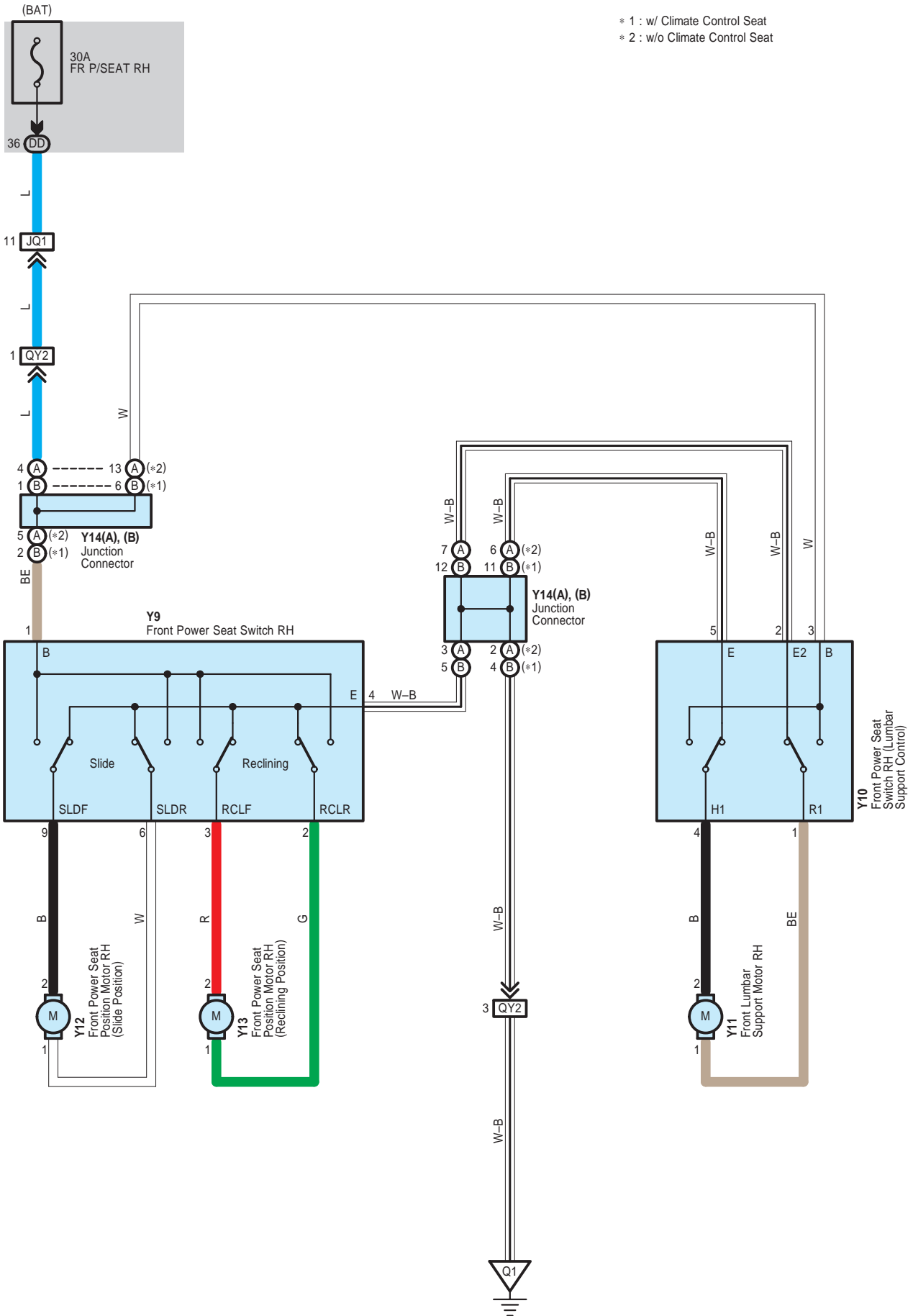

* 1 : w/ Climate Control Seat
 * 2 : w/o Climate Control Seat

Power Seat <Front Passenger's Seat>

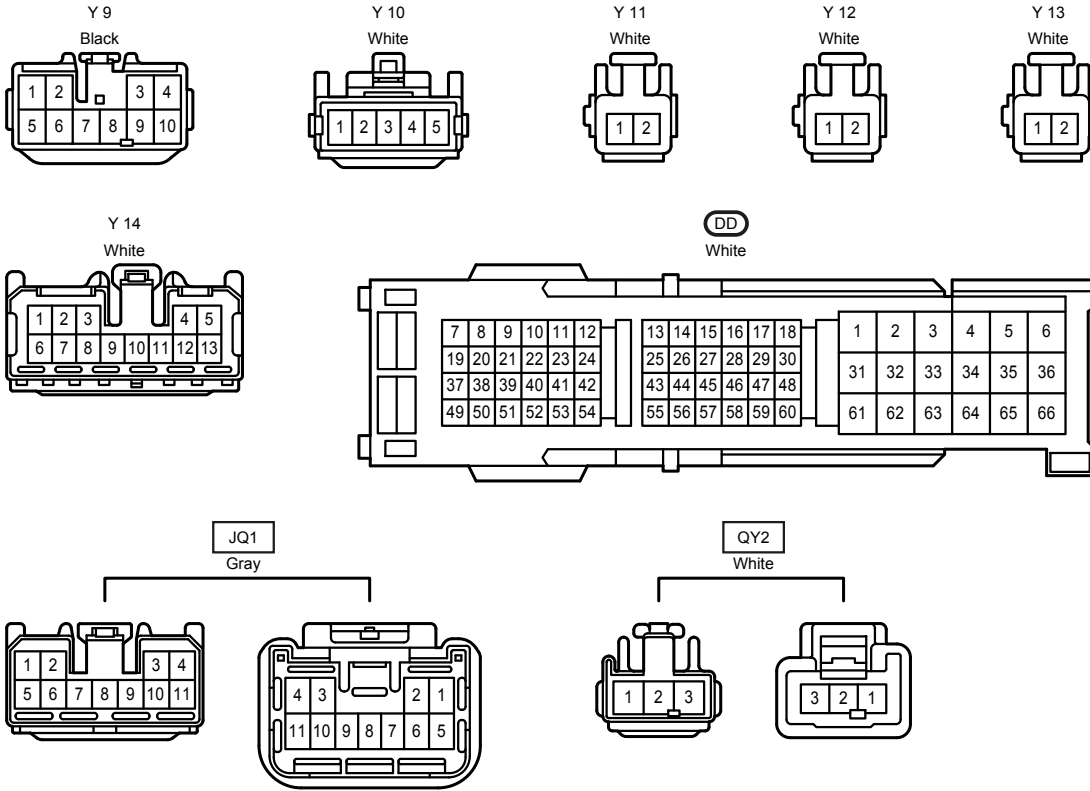

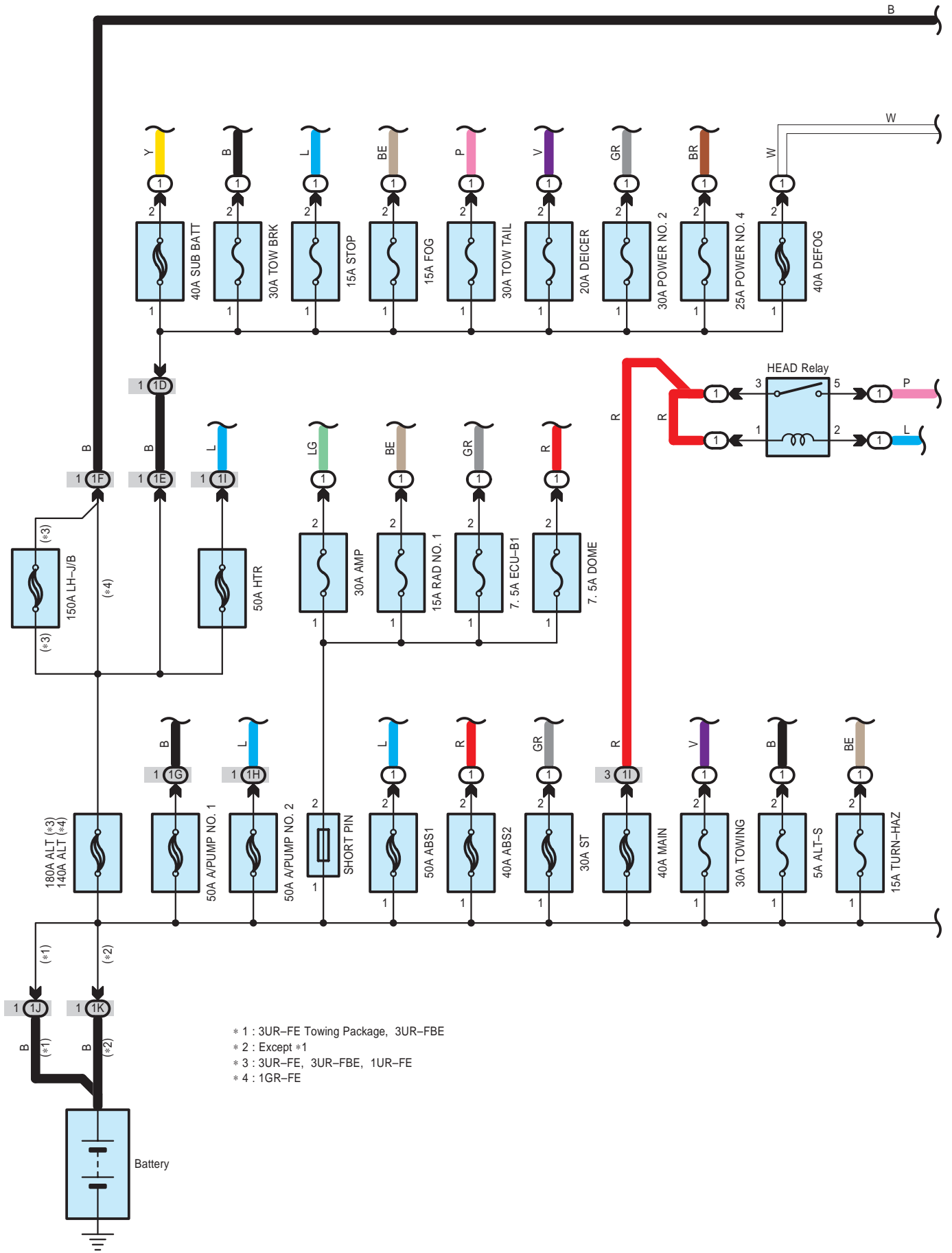

Power Source

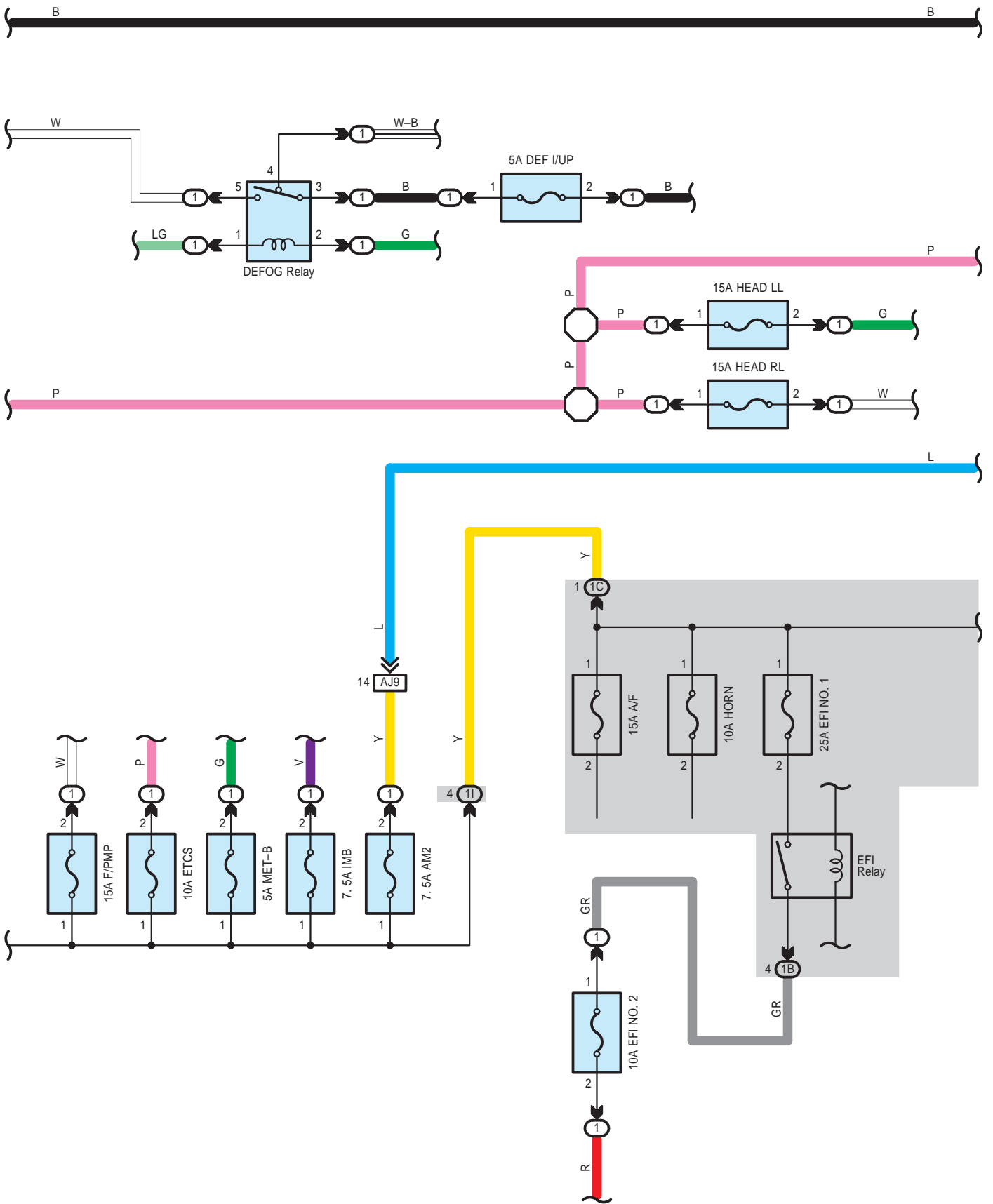

Power Source

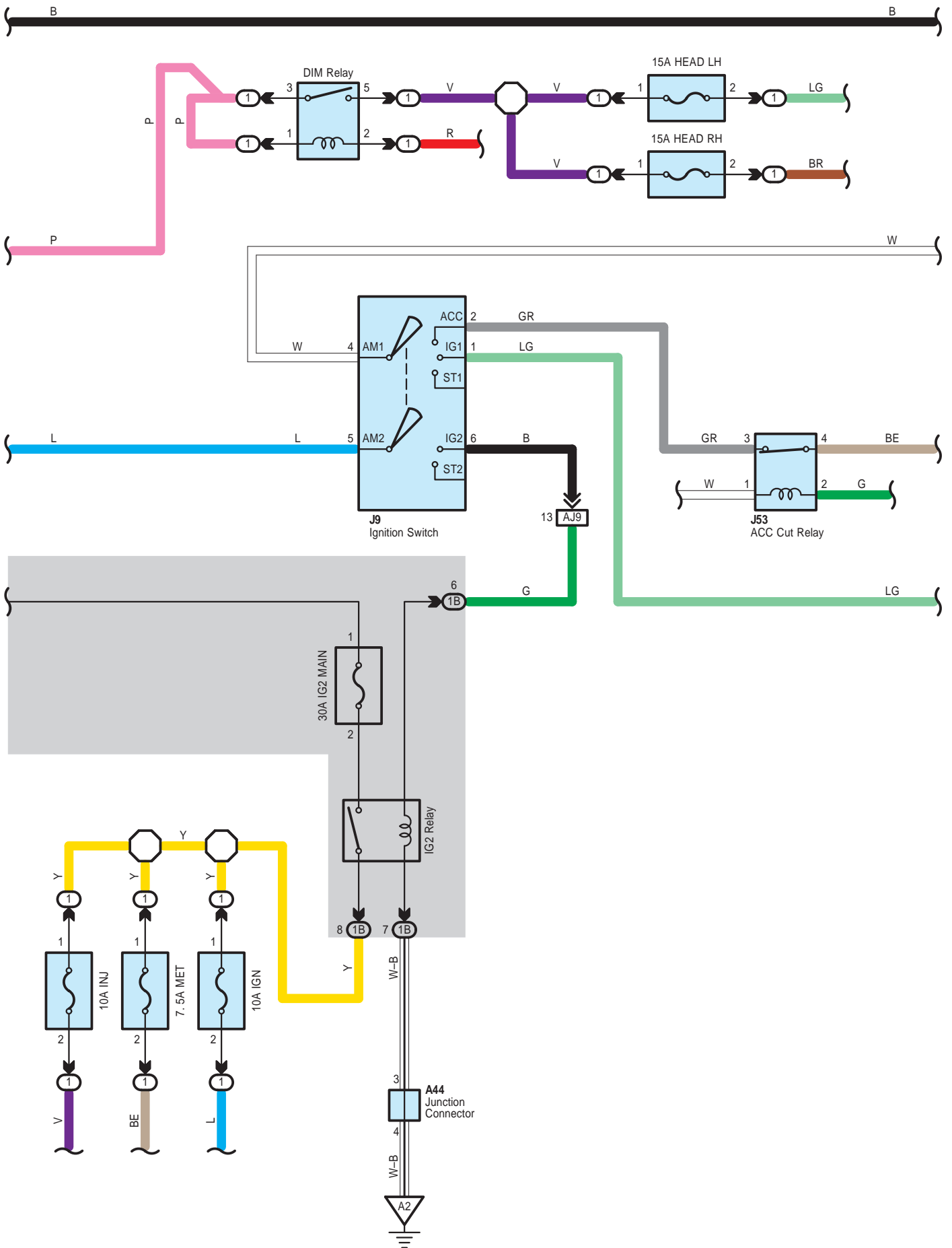

Power Source

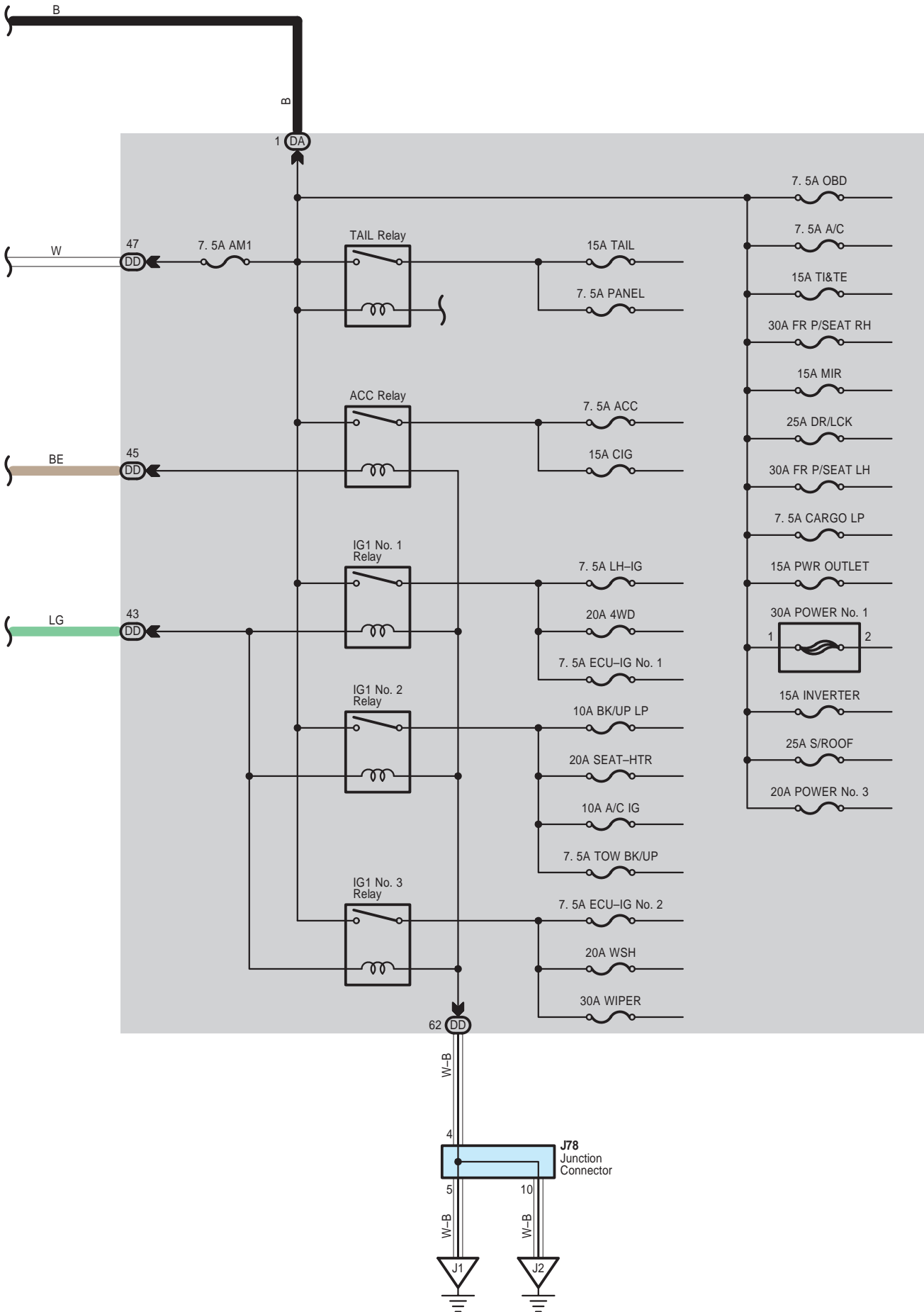

Power Source

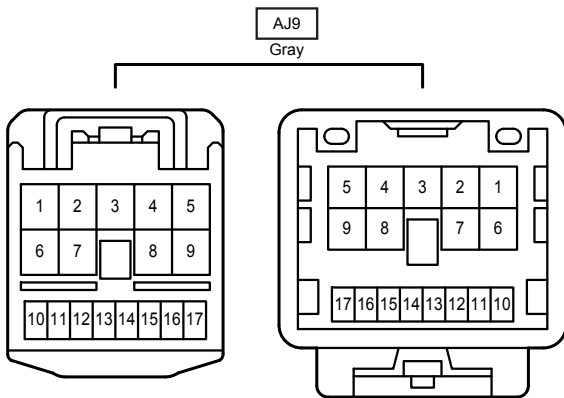
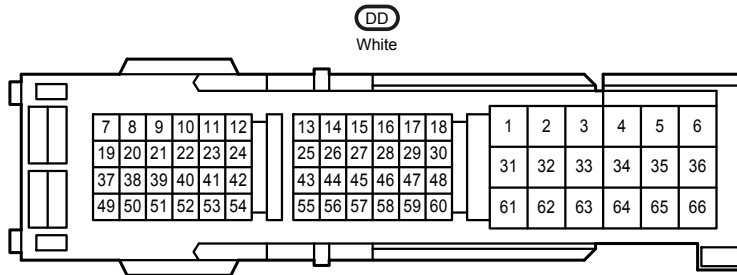
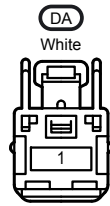
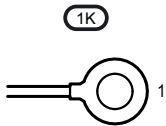
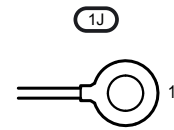
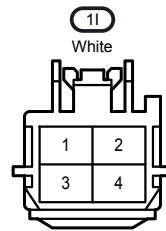
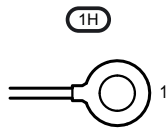
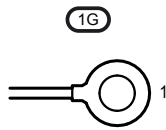
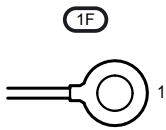
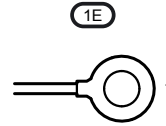
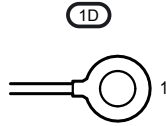
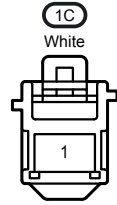
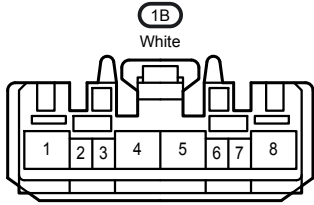
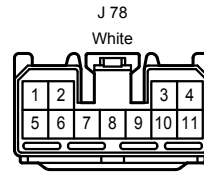
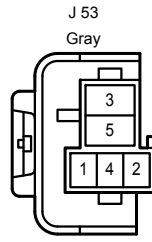
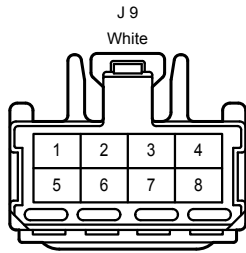
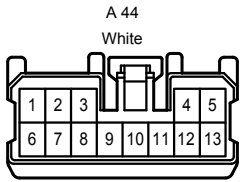

Power Steering

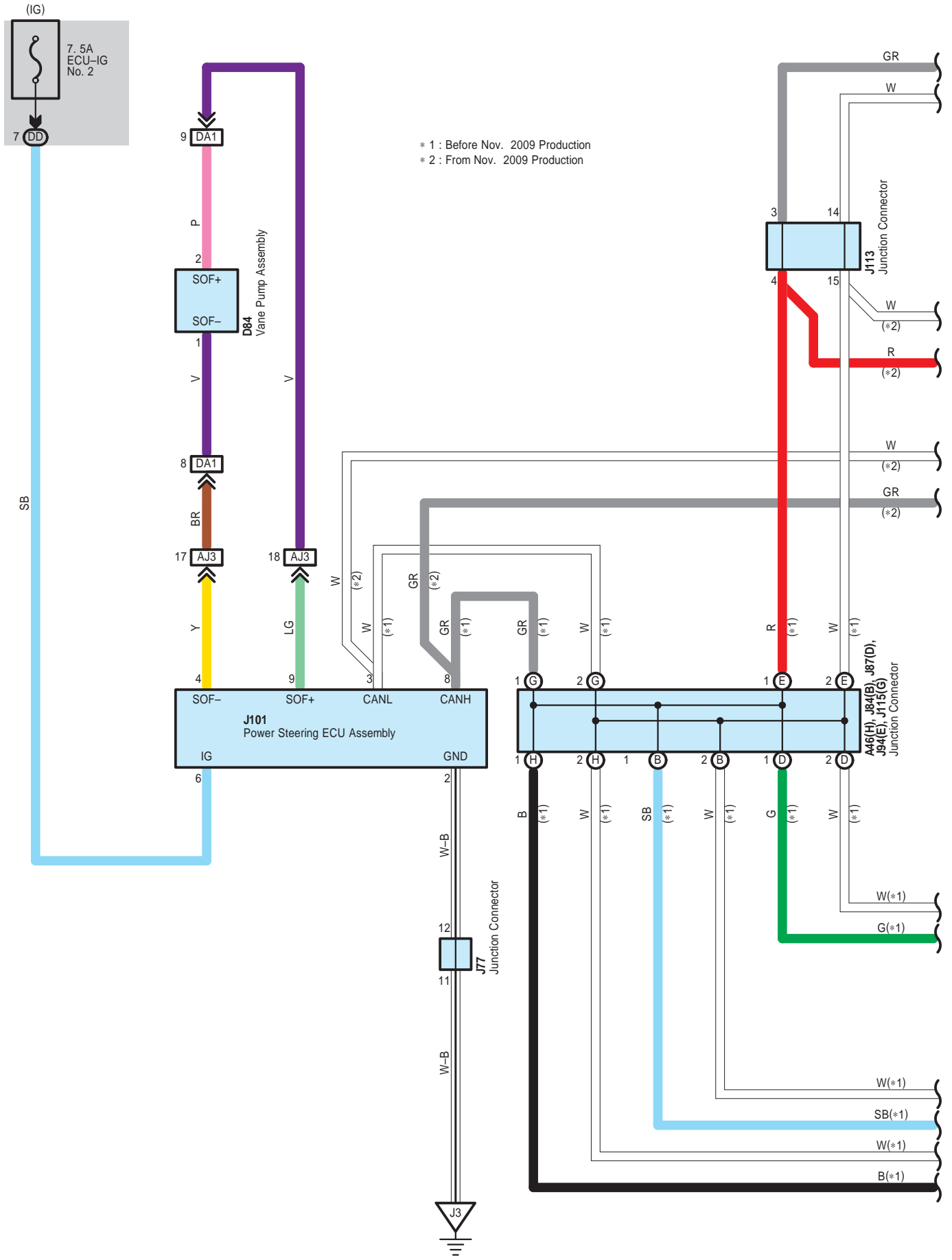

* 1 : Before Nov. 2009 Production
 * 2 : From Nov. 2009 Production

Power Steering

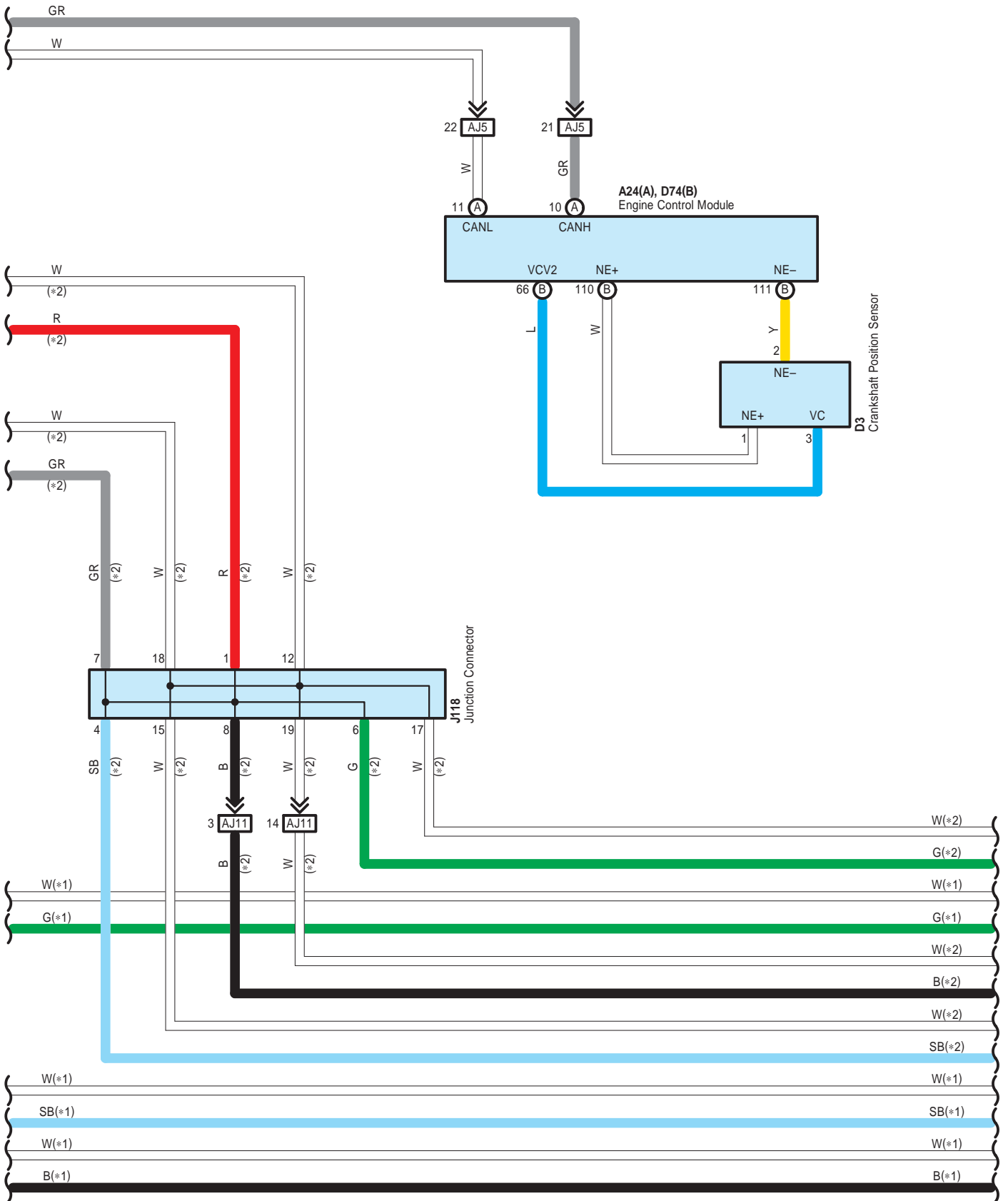

* 1 : Before Nov. 2009 Production
 * 2 : From Nov. 2009 Production

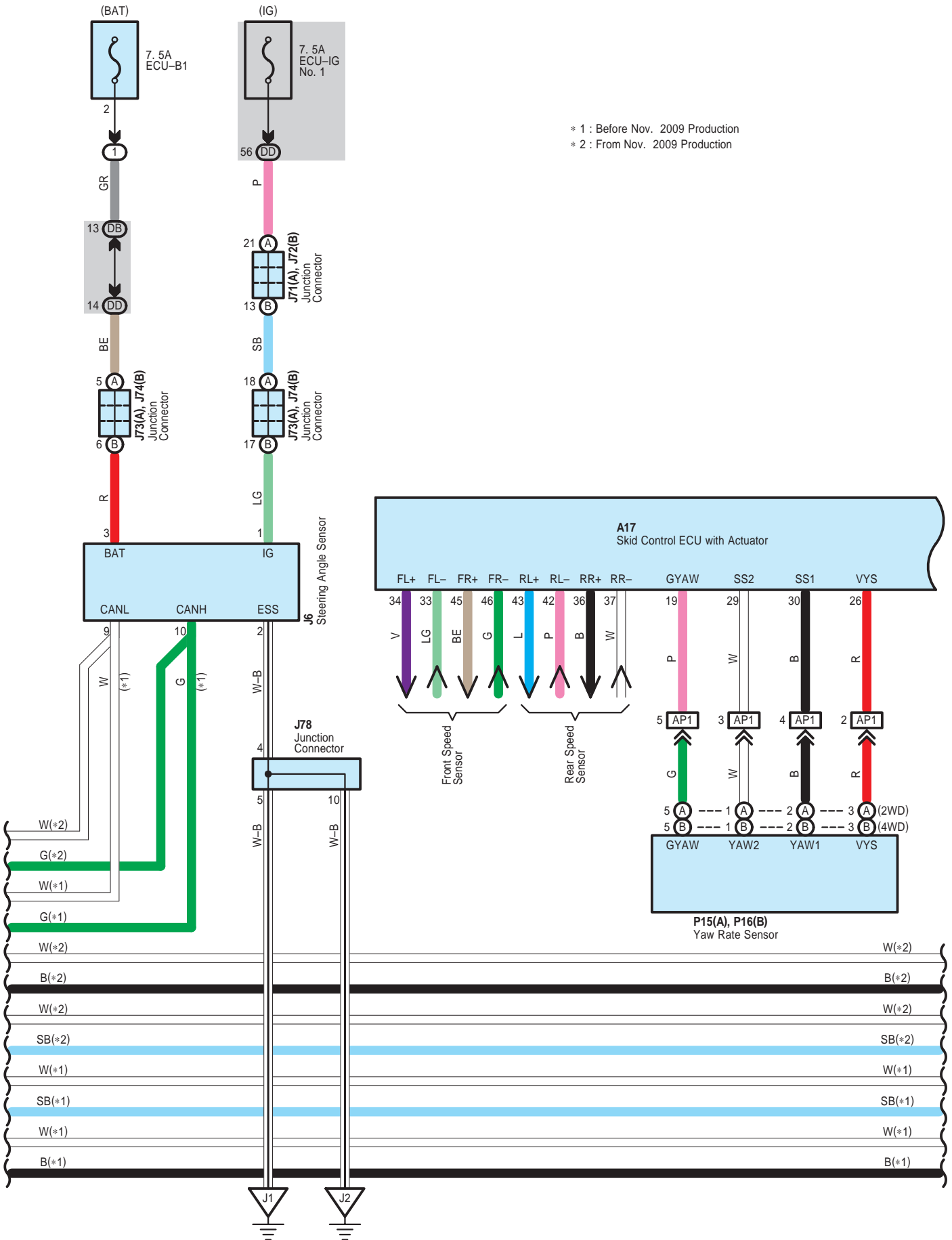

Power Steering

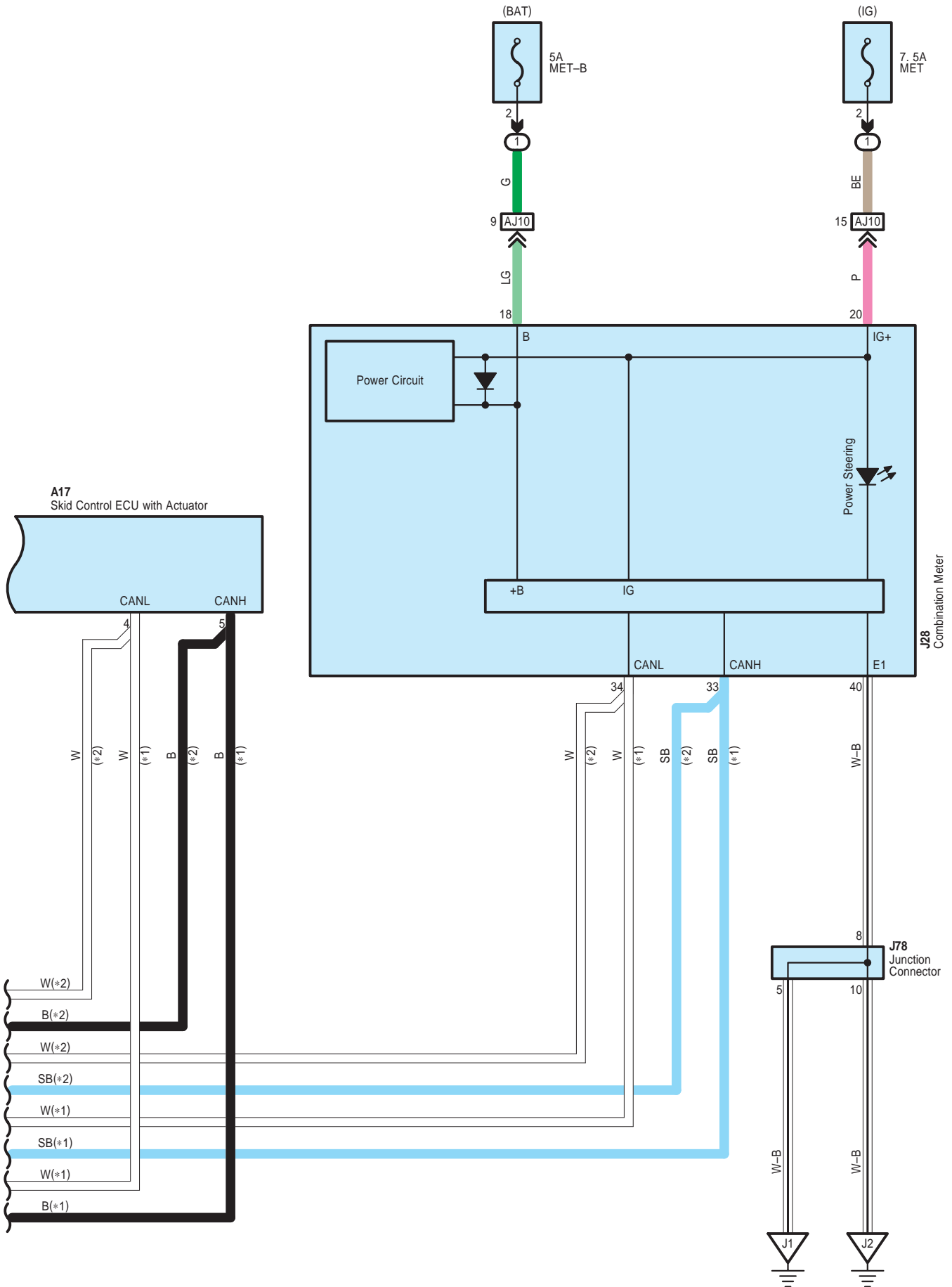

Power Steering

A 17
Black

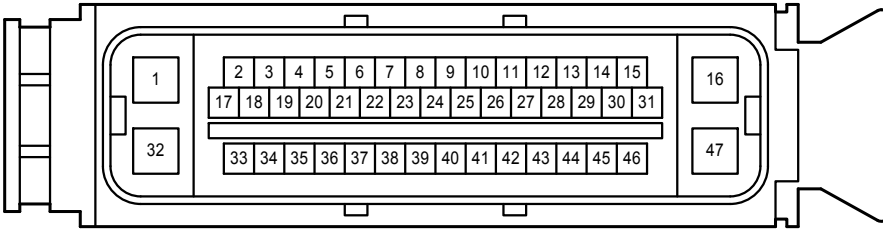

A 24
Black

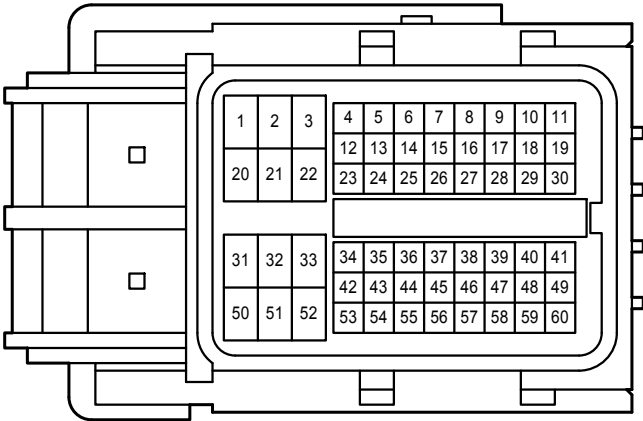

A 46
White

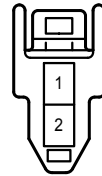

D 3
Black

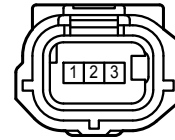

D 74
Black

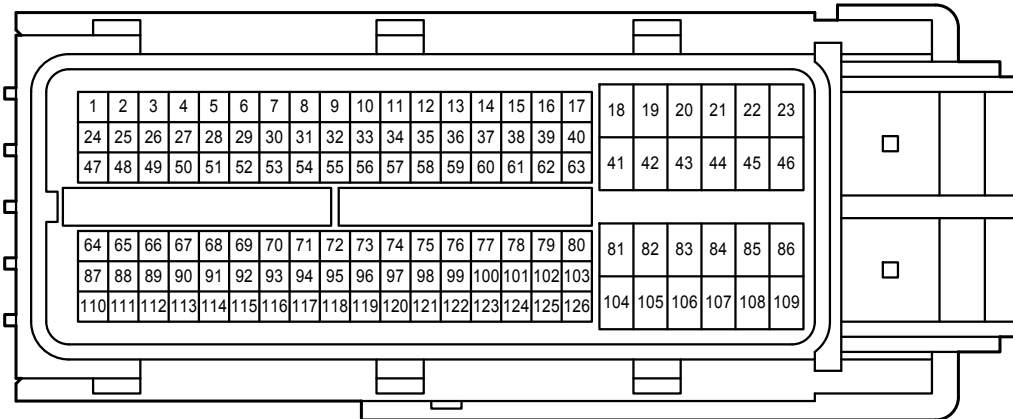

D 84

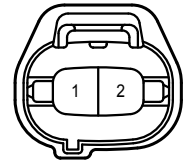

J 6
Gray

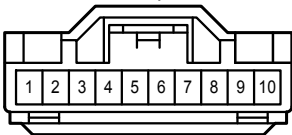

J 28
White

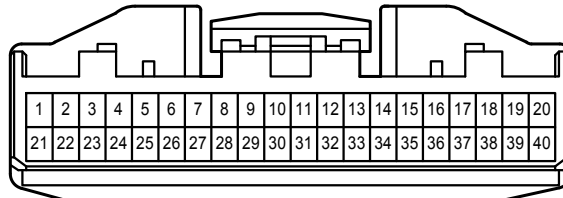

Power Steering

J 71
Black

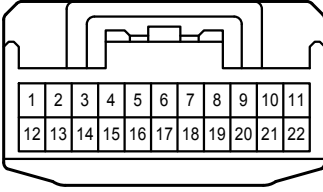

J 72
Black

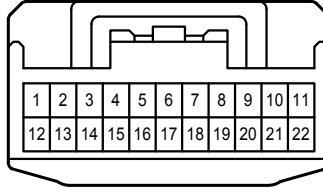

J 73
Black

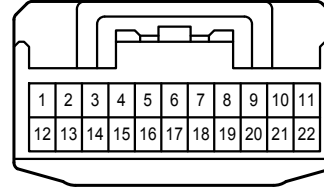

J 74
Black

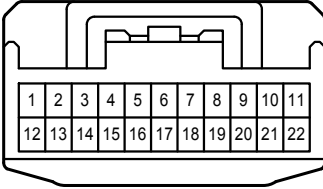

J 77
Gray

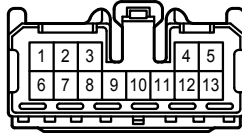

J 78
White



J 84
White

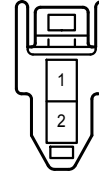

J 87
White

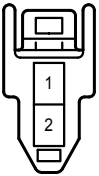

J 94
White

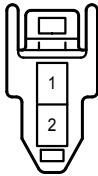

J101
White

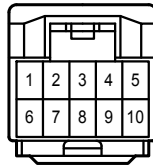

J113
Gray

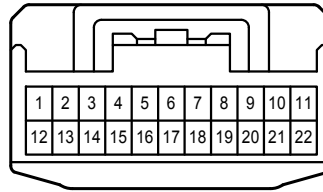

J115
White

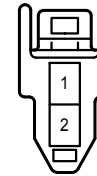

J118
Gray

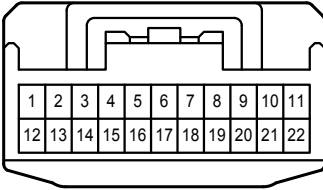

P 15
Black

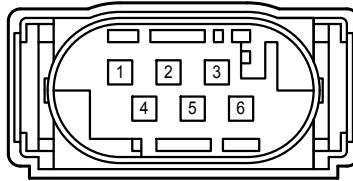

P 16
Black

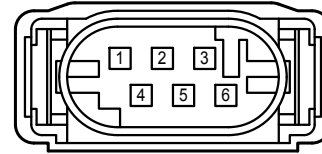

DB
White

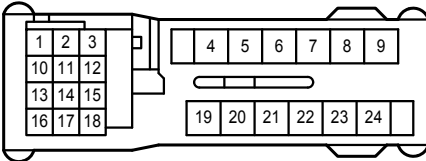

DD
White

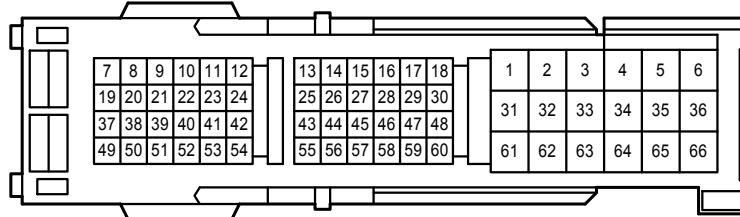

AJ3
White

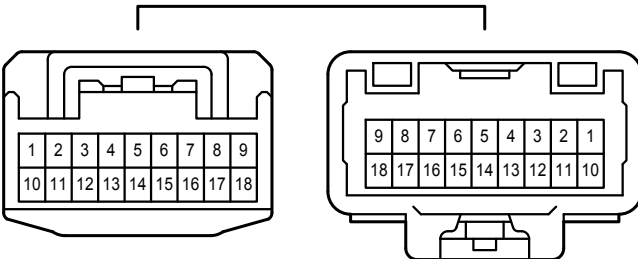

AJ5
White

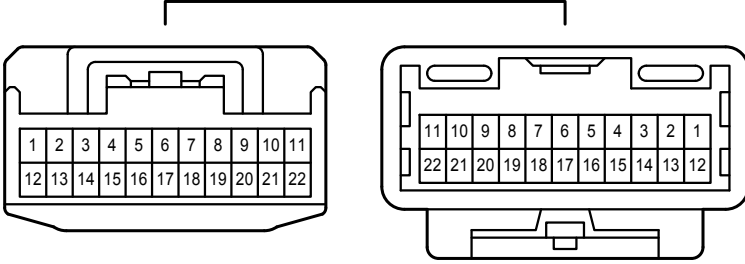

AJ10
Gray

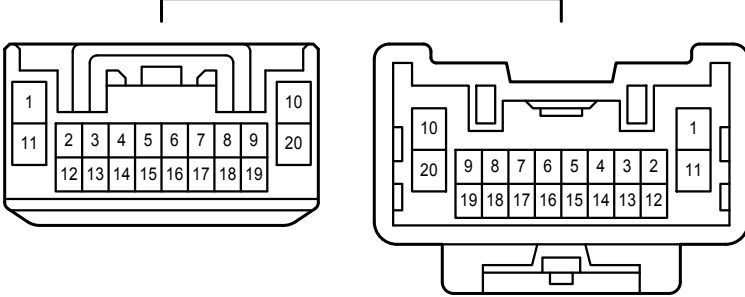

AJ11
Gray

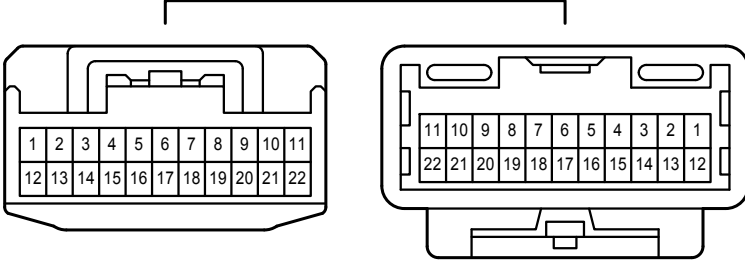

AP1
White

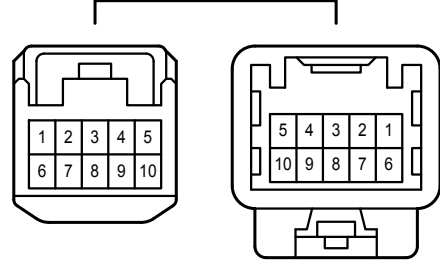

DA1
White

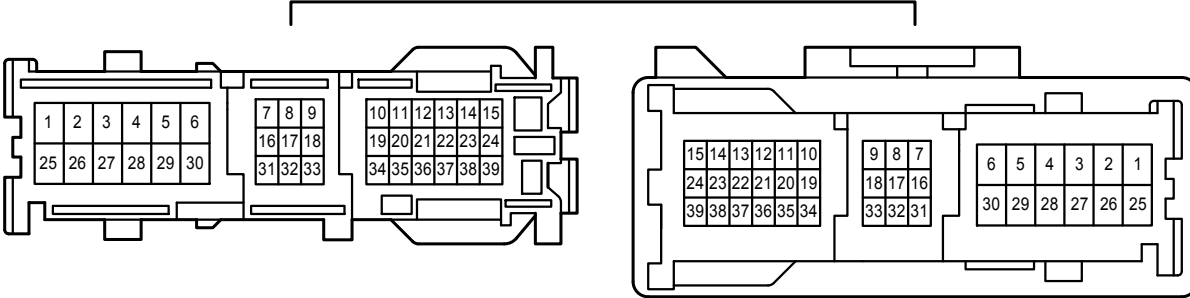

Power Tilt and Power Telescopic

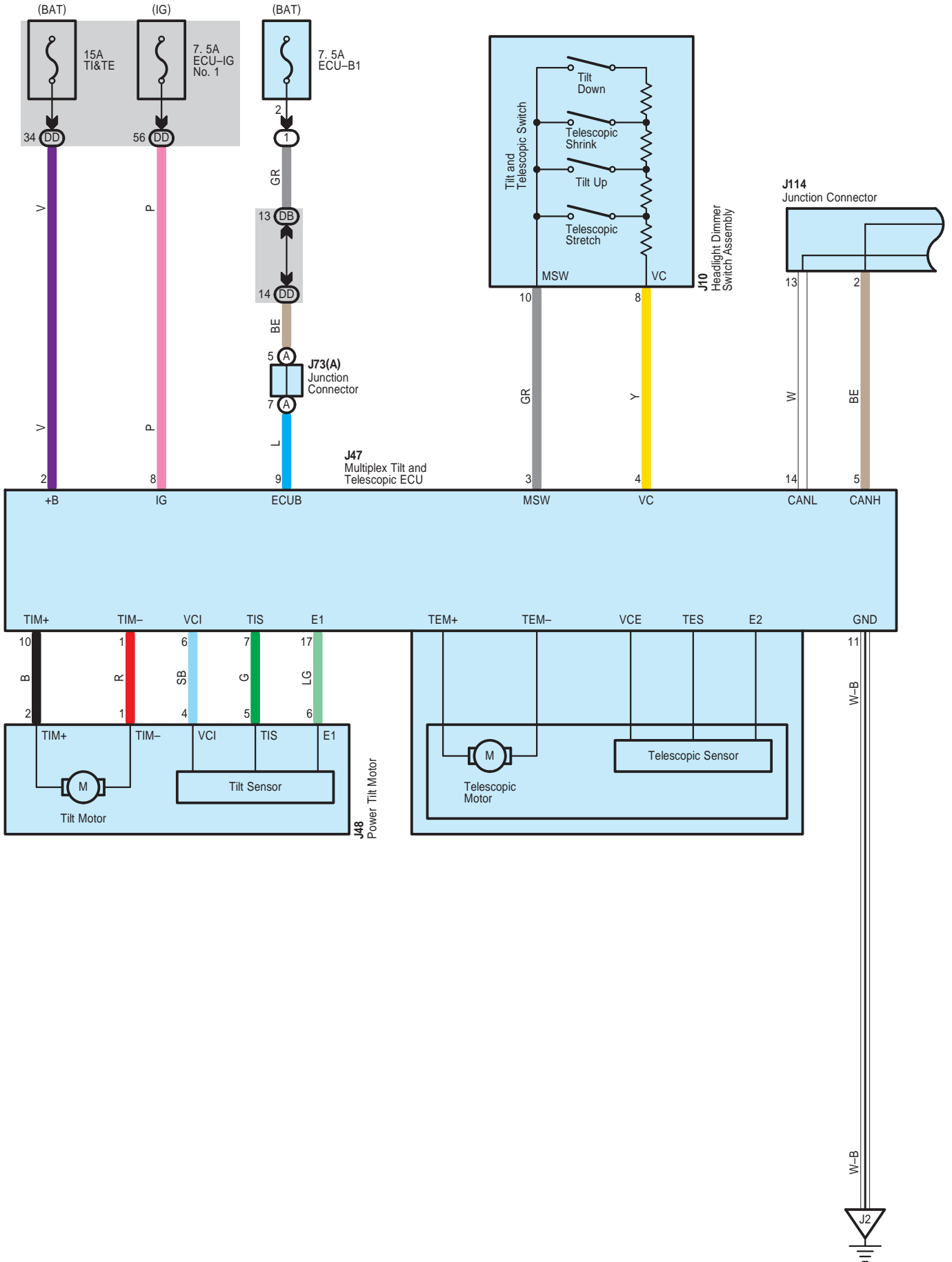

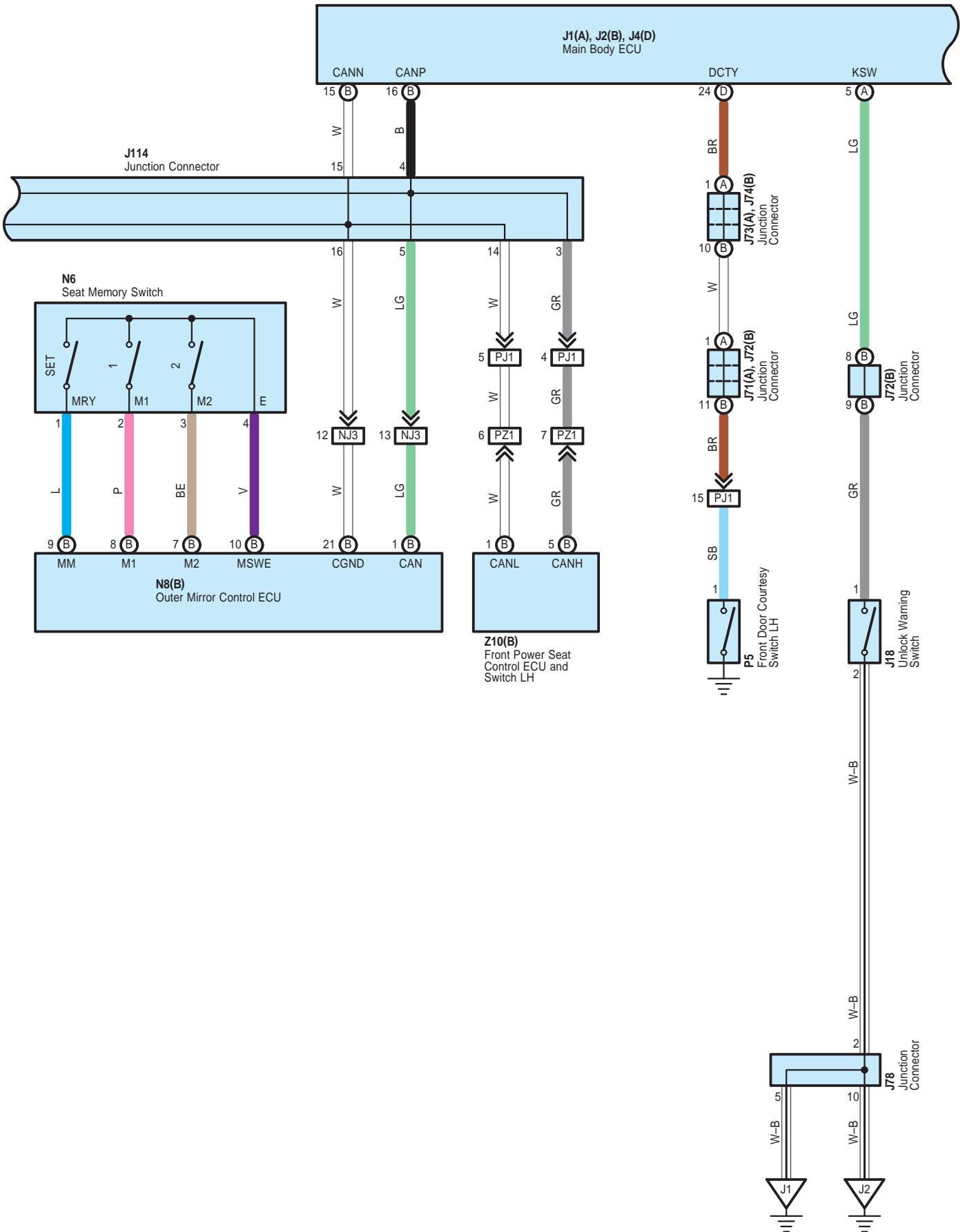

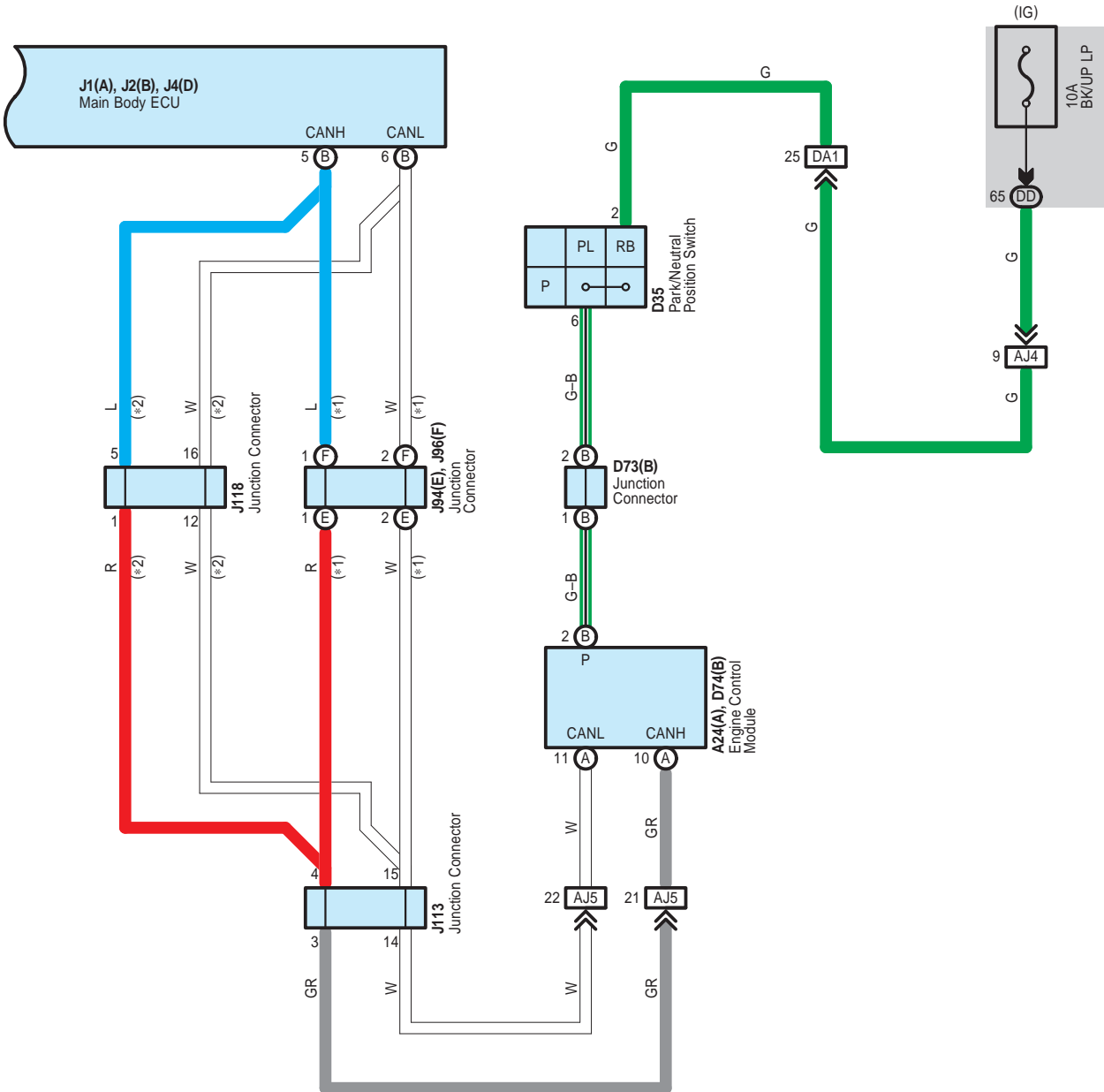

* 1 : Before Nov. 2009 Production
 * 2 : From Nov. 2009 Production

Power Tilt and Power Telescopic

A 24
Black

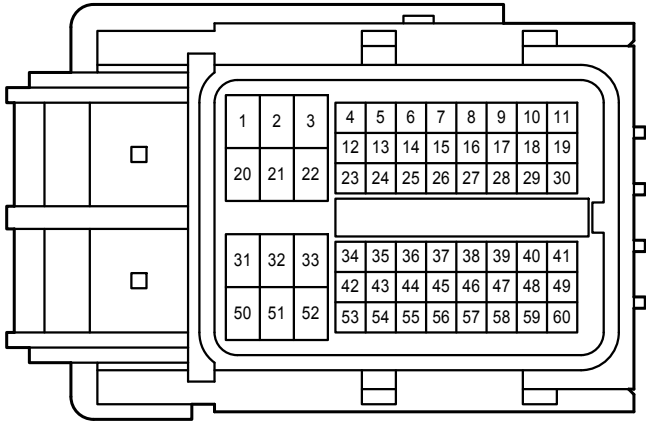

D 35
Gray

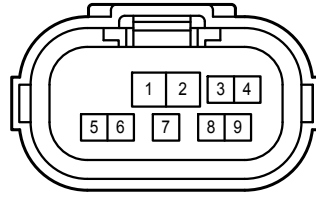

D 73
Blue

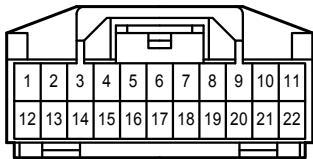

D 74
Black

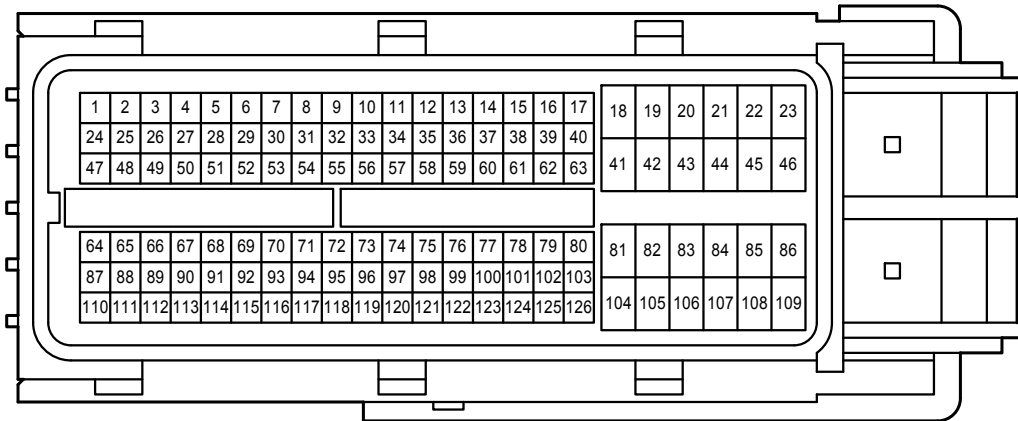

J 1
White

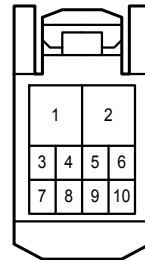

J 2
White

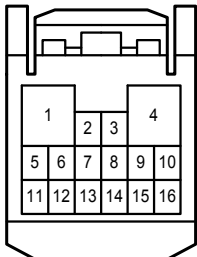

J 4
White

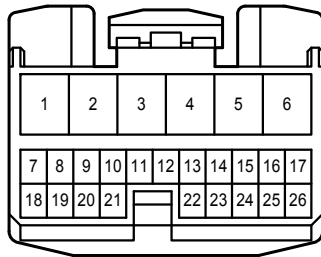

J 10
White

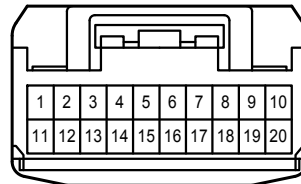

J 18
White



Power Tilt and Power Telescopic

J 47
White

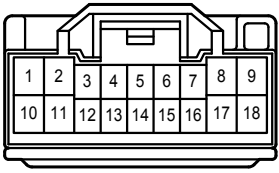

J 48
White

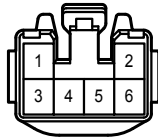

J 71
Black

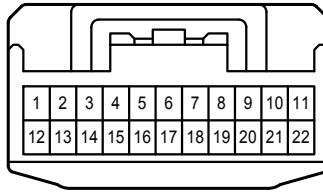

J 72
Black

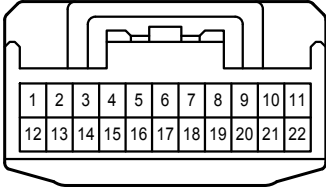

J 73
Black

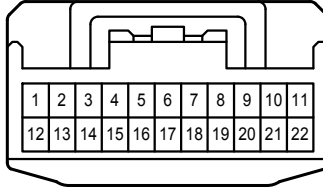

J 74
Black

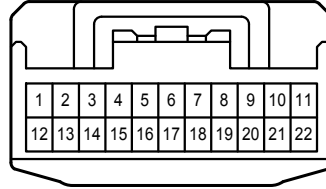

J 78
White

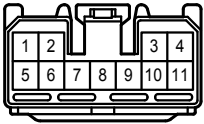

J 94
White

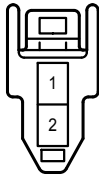

J 96
White

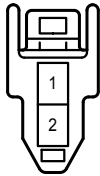

J113
Gray

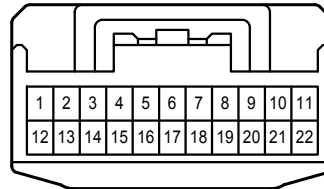

J114
Gray

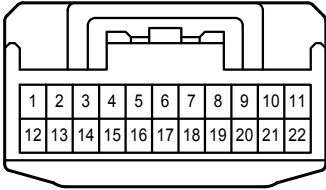

J118
Gray

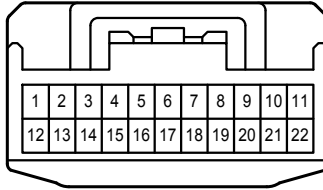

N 6
White



N 8
White

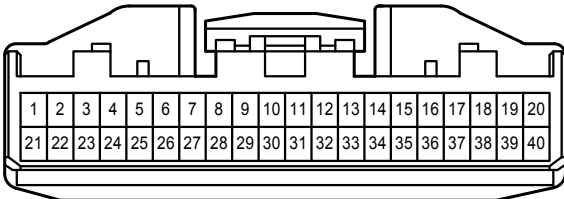

P 5
White



Z 10
White

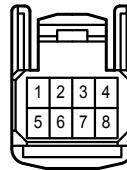

DB
White

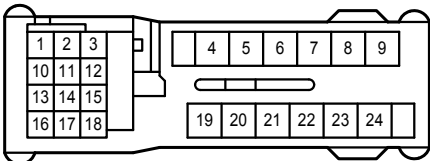

DD
White

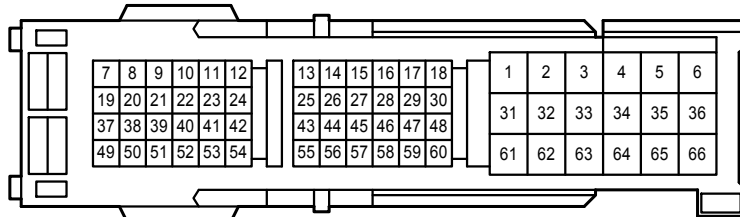

AJ4
White

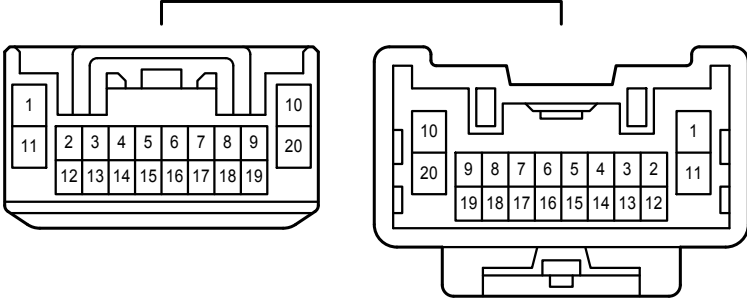

AJ5
White

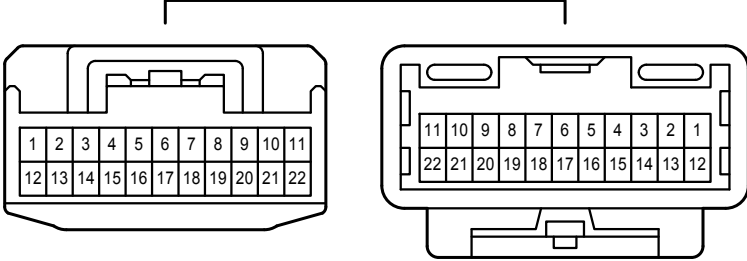

DA1
White

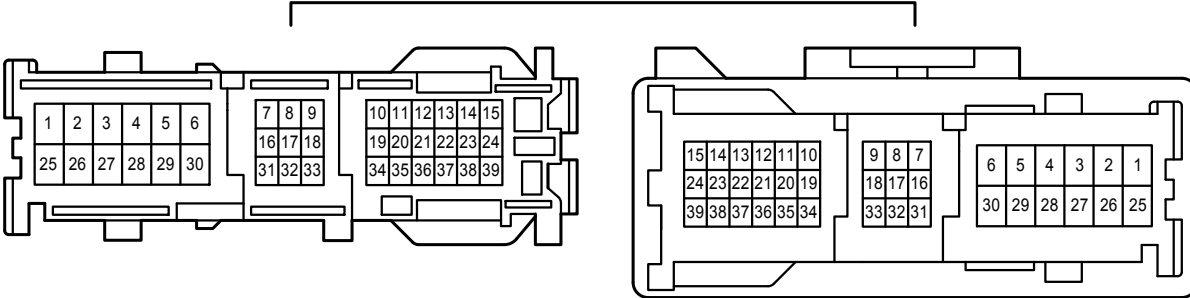

NJ3
Blue

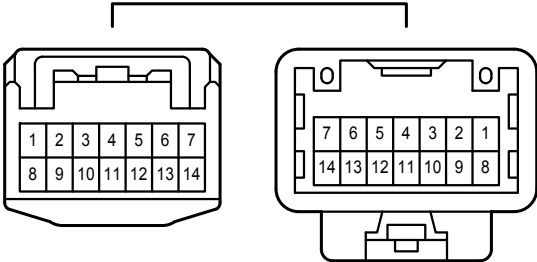

PJ1
Black

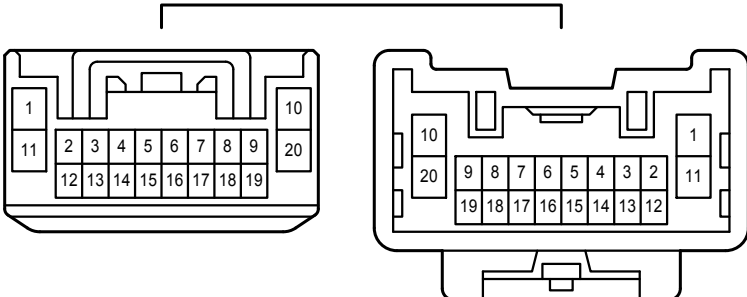

PZ1
White

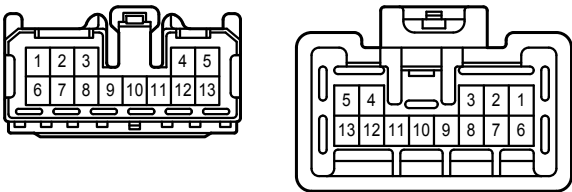

Power Window

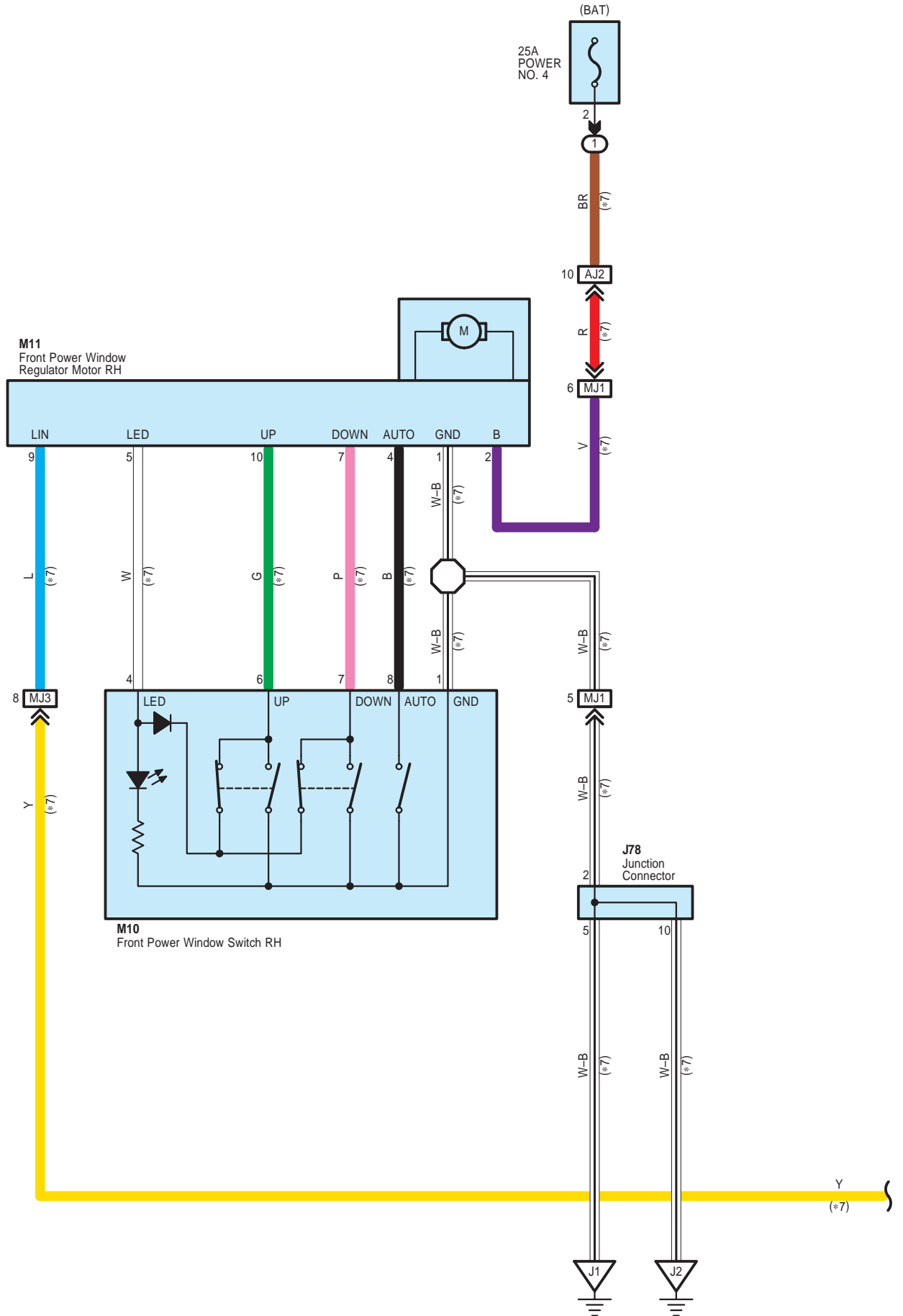

Power Window

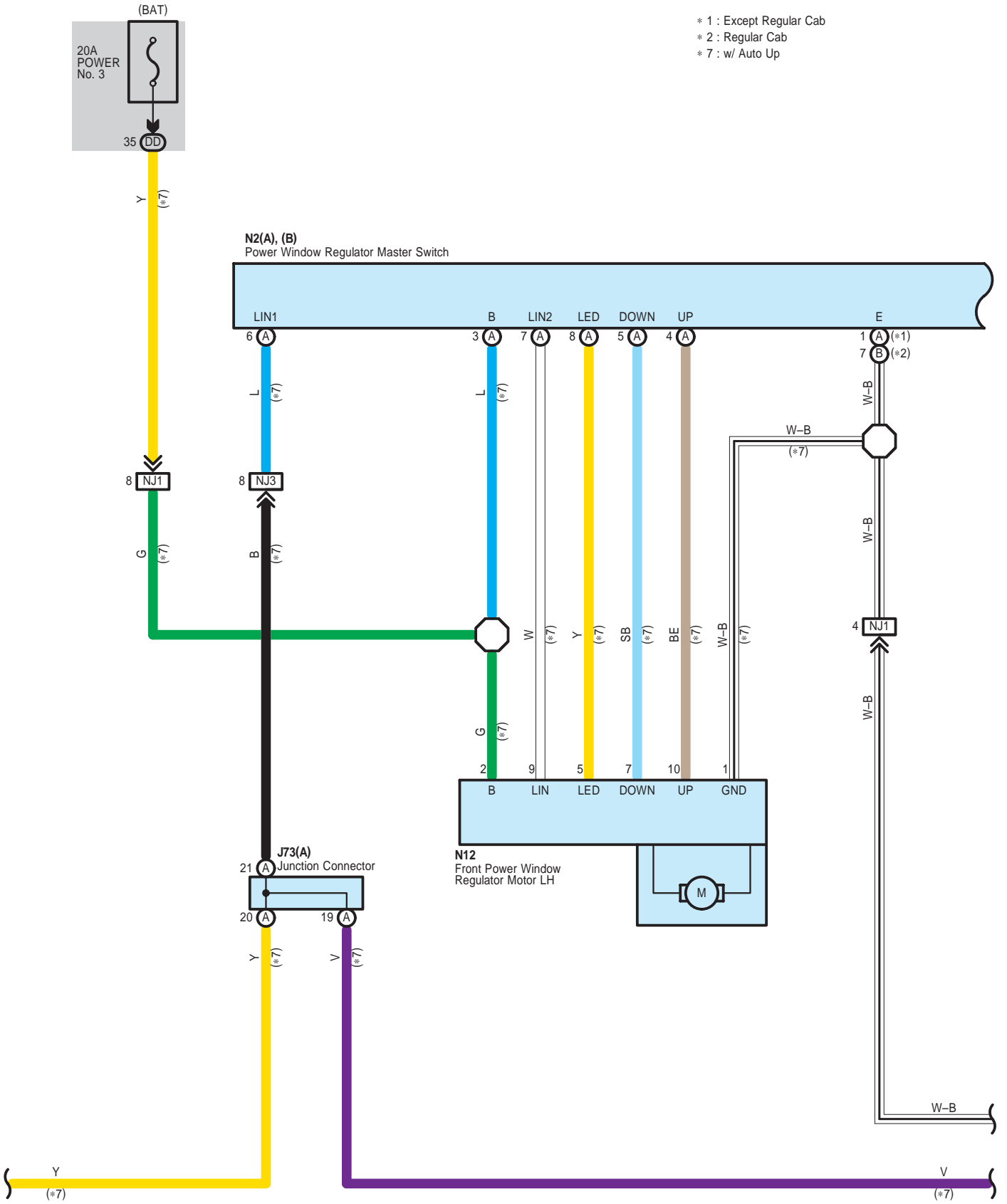

Power Window

- * 1 : Except Regular Cab
- * 2 : Regular Cab
- * 3 : Double Cab
- * 4 : CrewMax
- * 7 : w/ Auto Up
- * 8 : w/o Auto Up
- * 9 : w/ Back Power Window
- * 12 : Before Nov. 2009 Production
- * 13 : From Nov. 2009 Production

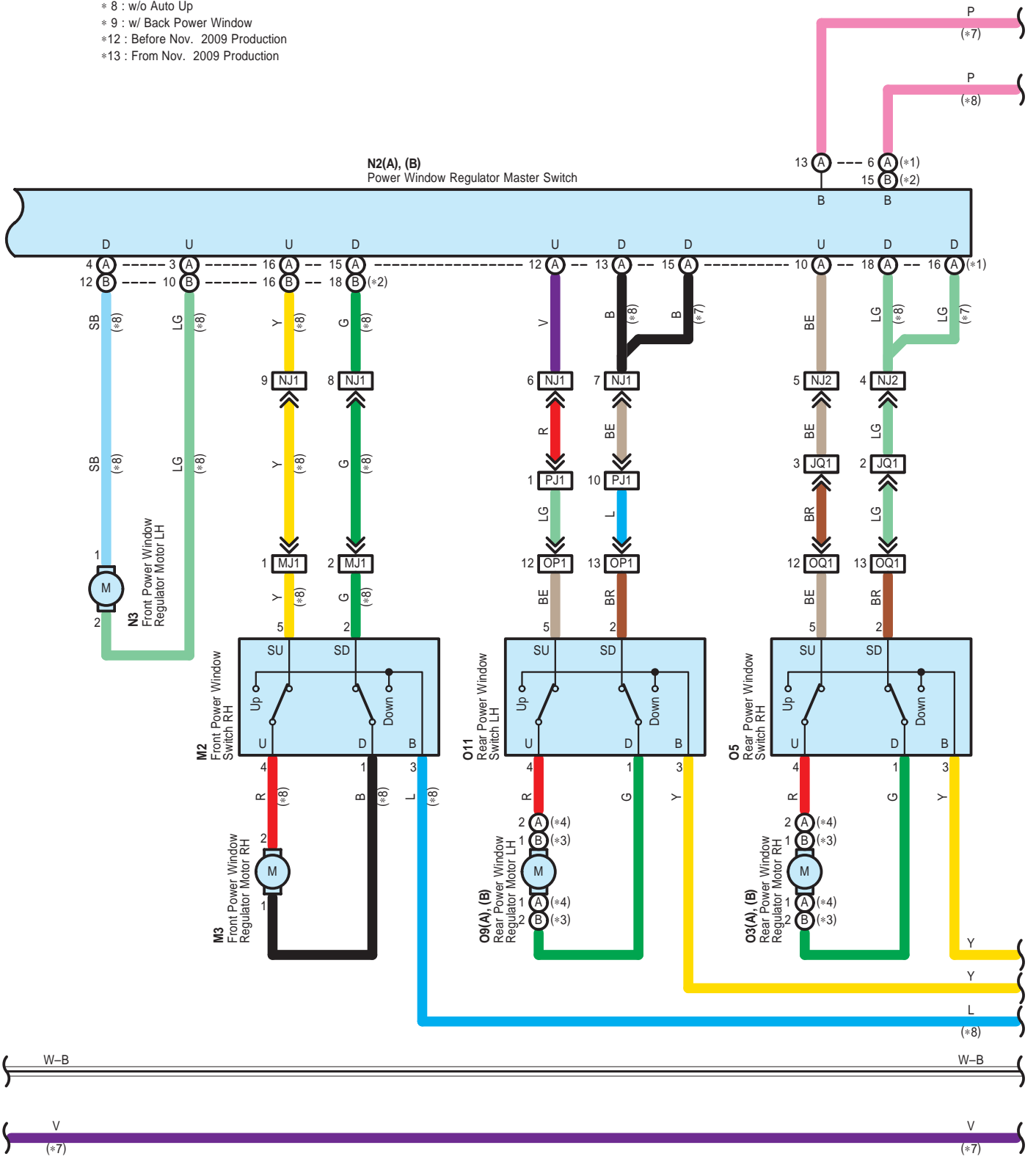

Power Window

- * 3 : Double Cab
- * 4 : CrewMax
- * 5 : w/ Power Seat
- * 6 : w/o Power Seat
- * 9 : w/ Back Power Window
- * 10 : Except 3UR-FBE
- * 11 : 3UR-FBE

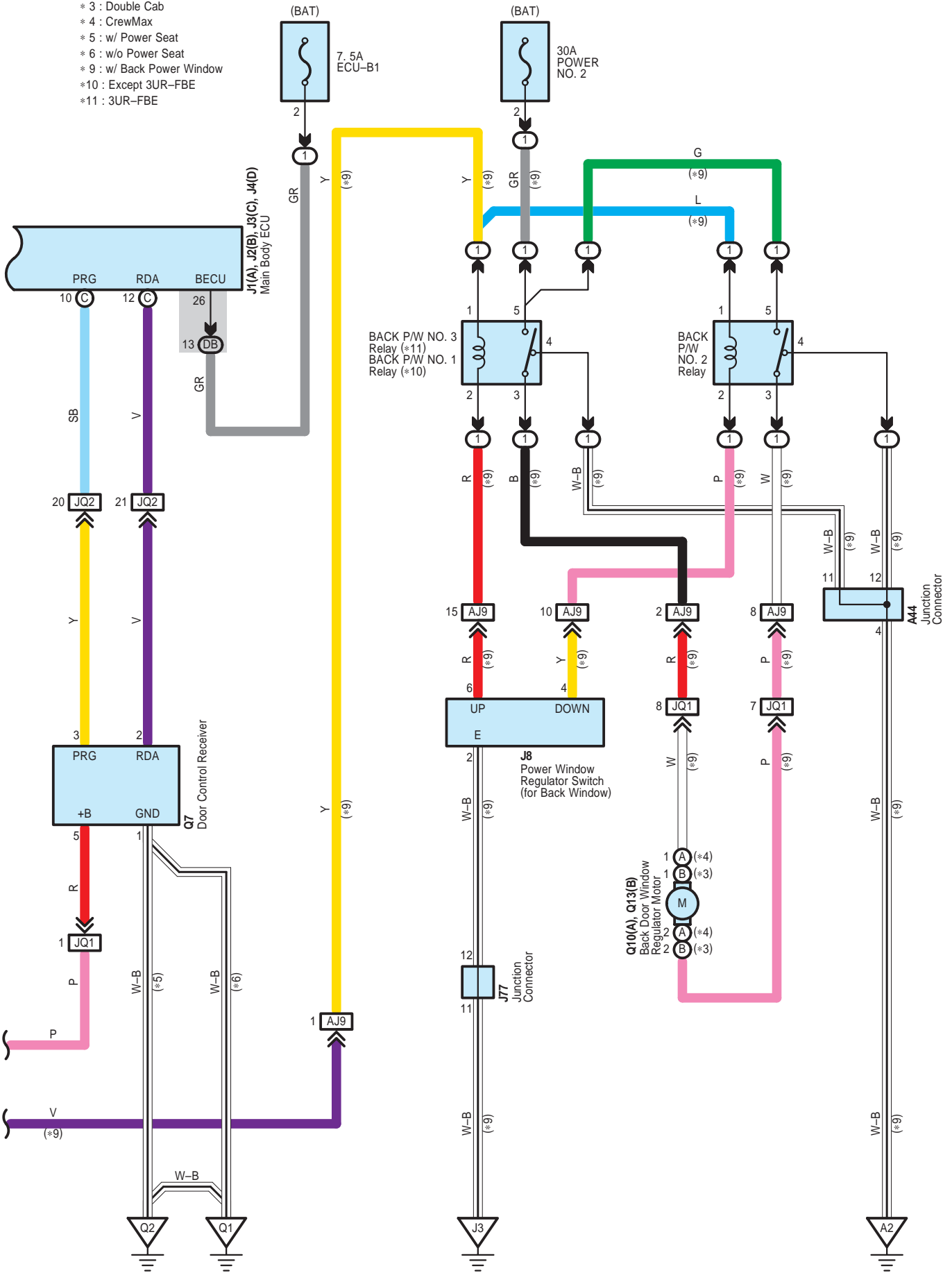

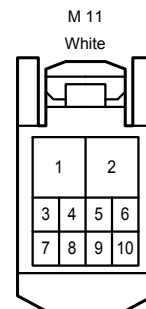
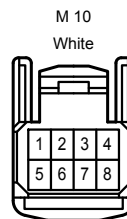
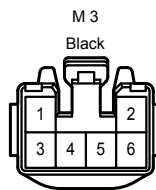
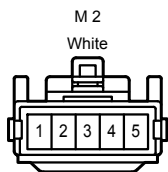
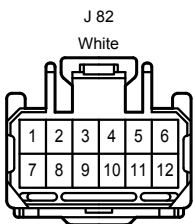
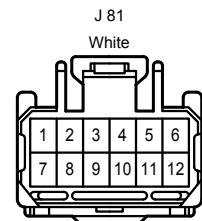
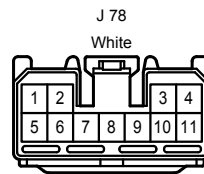
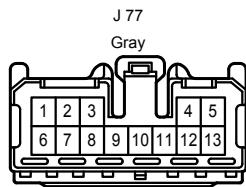
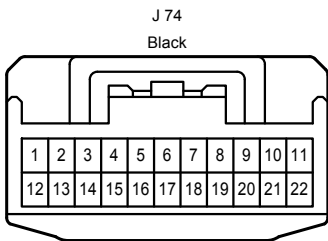
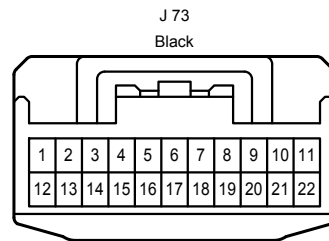
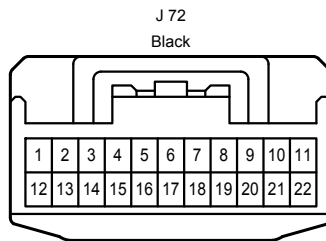
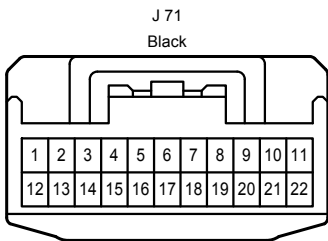
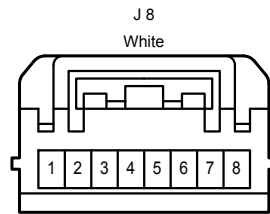
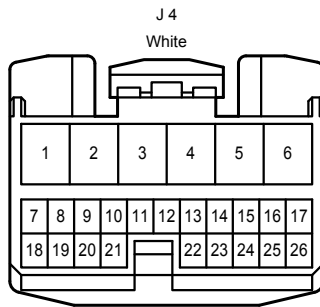
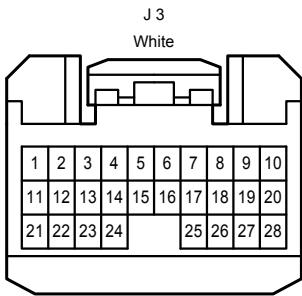
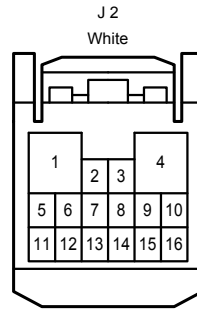
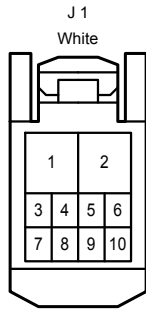
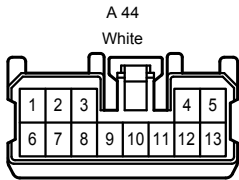
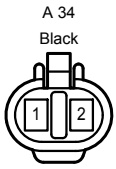

Power Window

N 2
White

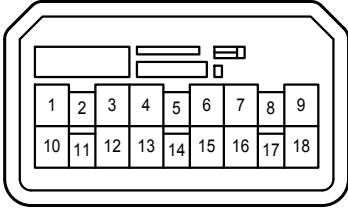

N 3
Black

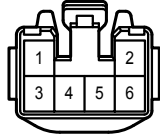

N 12
White

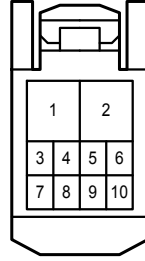

O 3
Black

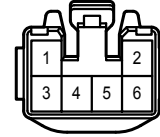

O 5
White

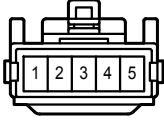

O 9
Black

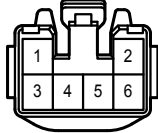

O 11
White

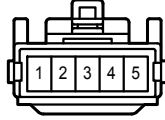

P 5
White



Q 7
White

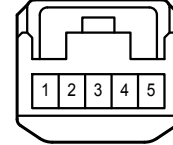

Q 10
Black



Q 13
Black



DB
White

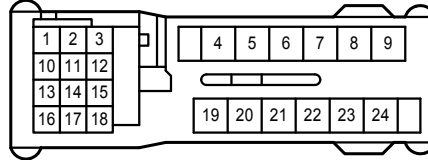

DC
White

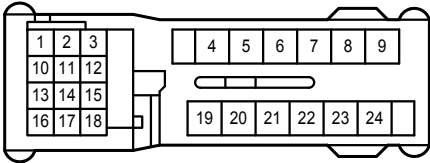

DD
White

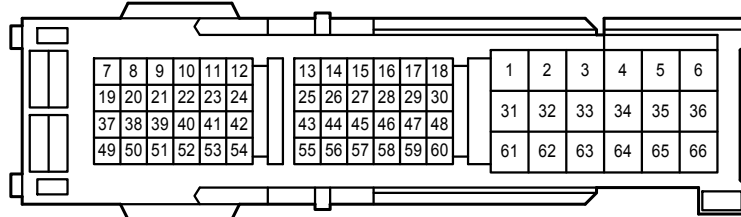

AJ2
White

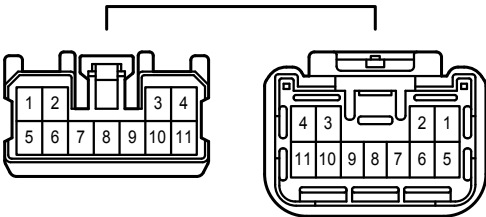

AJ9
Gray

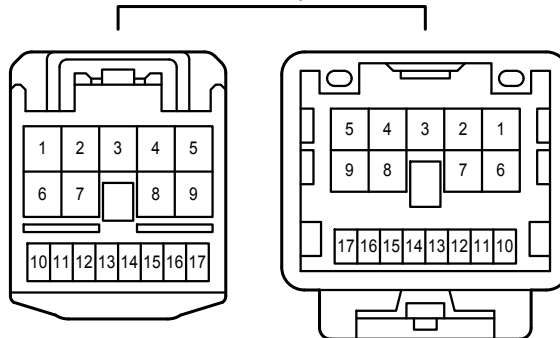

AJ11
Gray

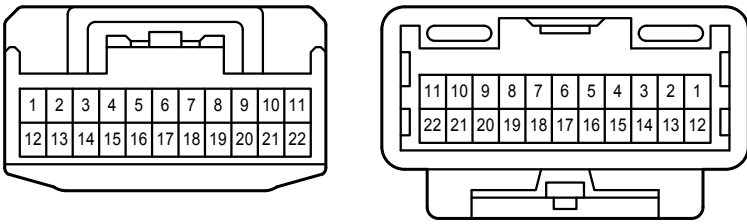

JQ1
Gray

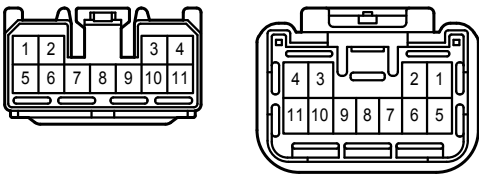

JQ2
Gray

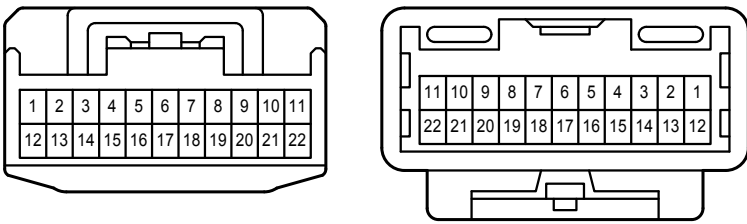

MJ1
Blue

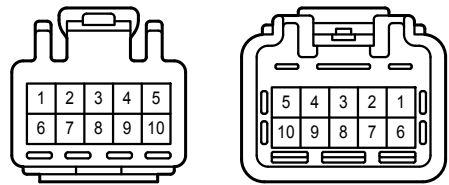

MJ3
Blue

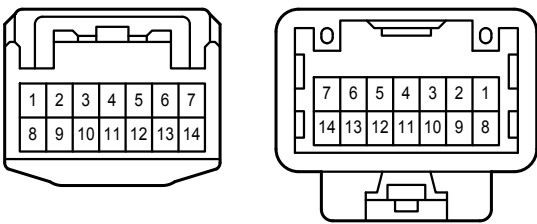

NJ1
Blue

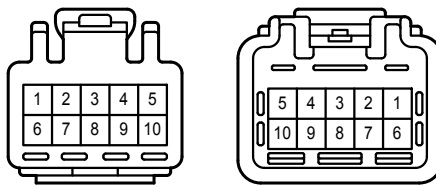

NJ2
Blue

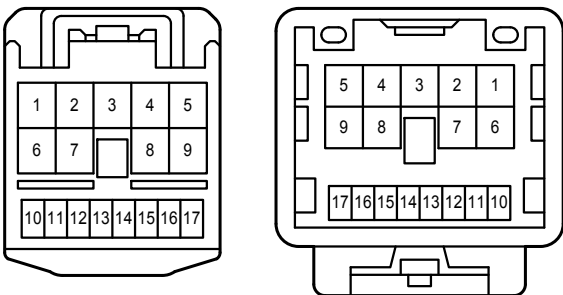

NJ3
Blue

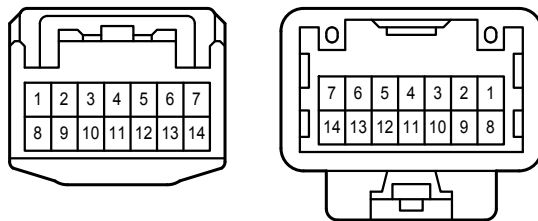

Power Window

OP1
White

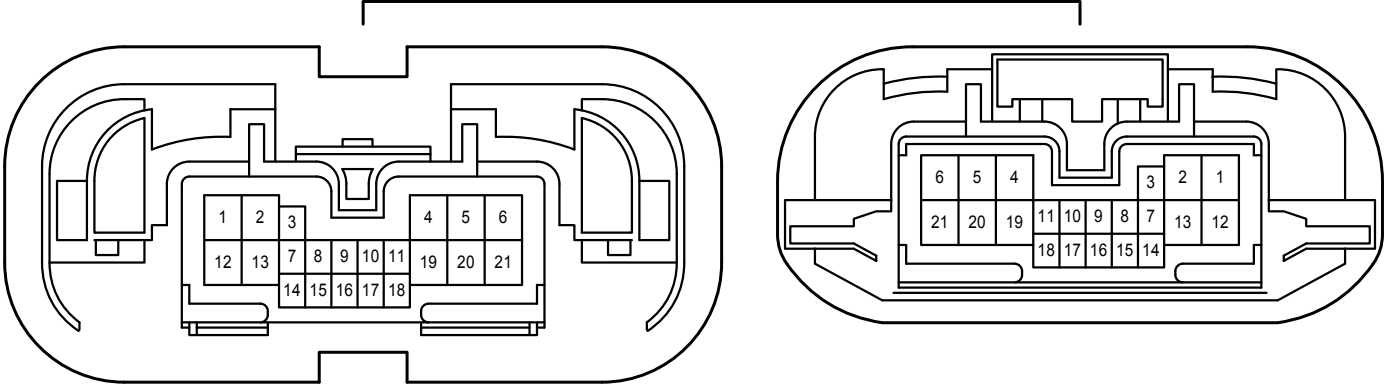

OQ1
White

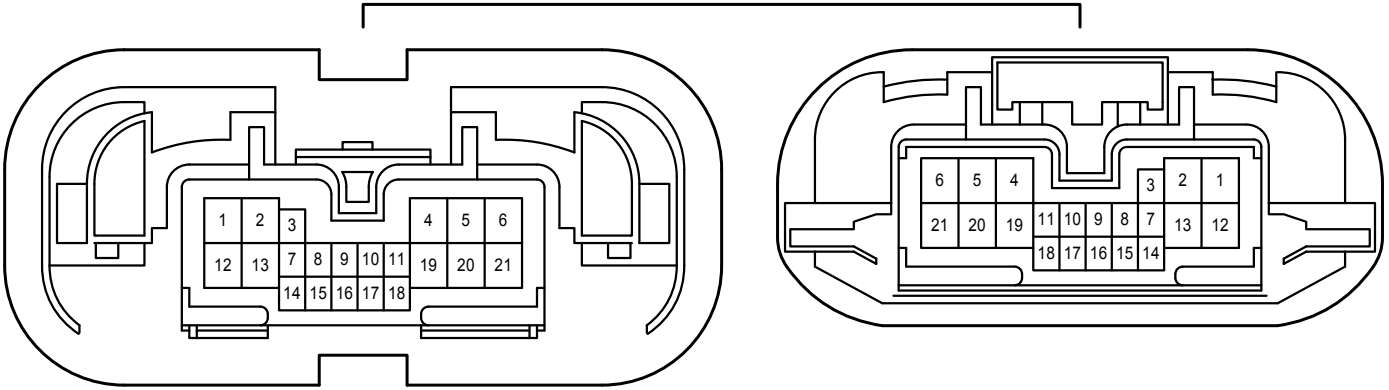

PJ1
Black

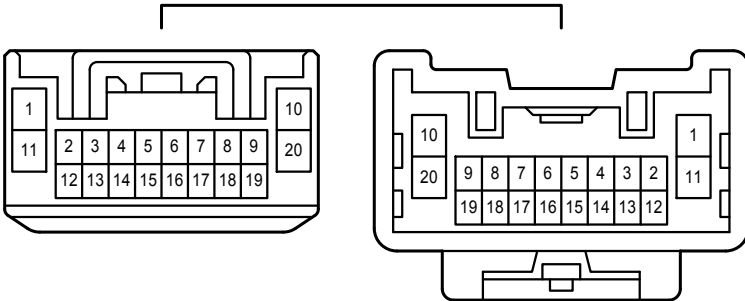

Rear Window Defogger

* 1 : Before Nov. 2009 Production
 * 2 : From Nov. 2009 Production

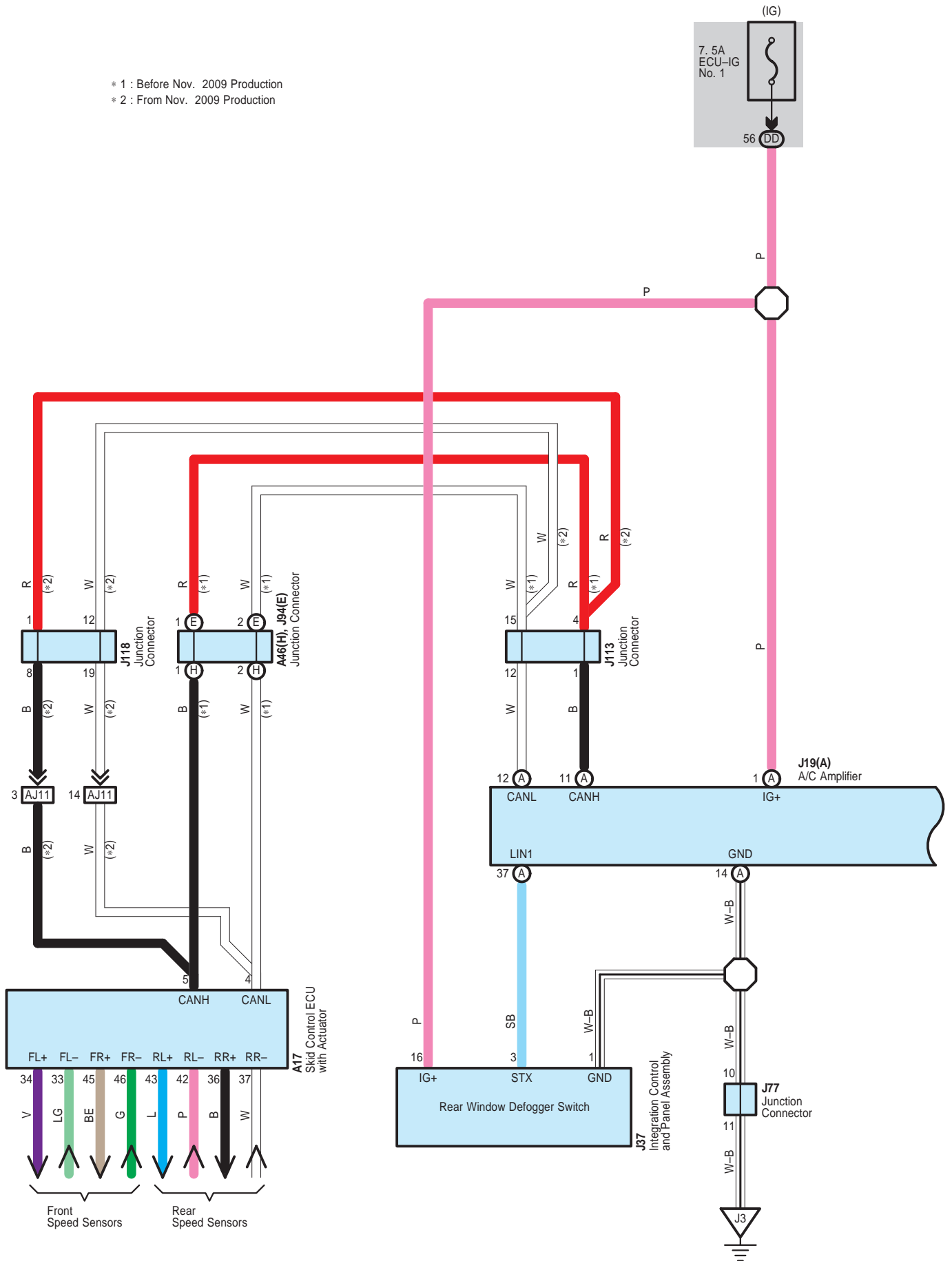

Rear Window Defogger

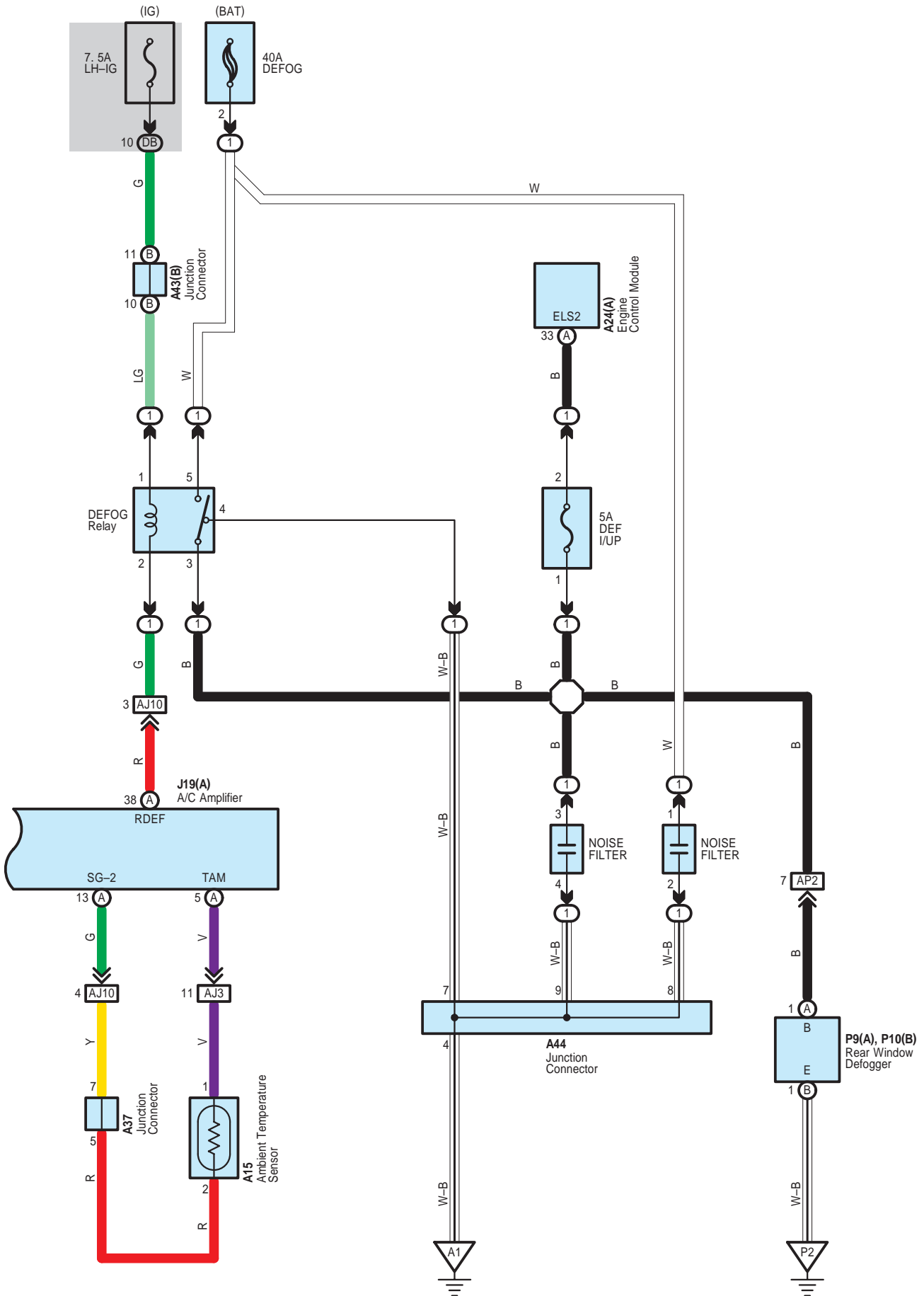

Rear Window Defogger

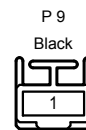
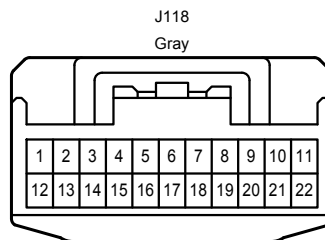
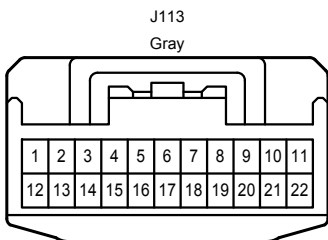
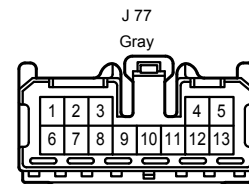
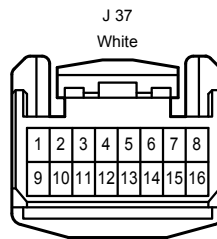
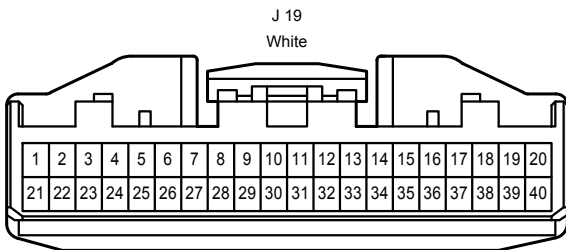
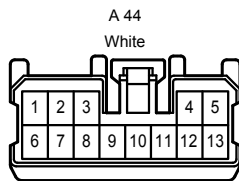
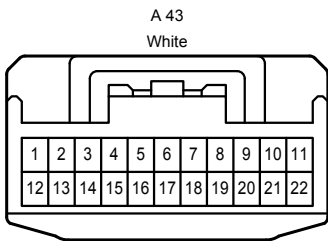
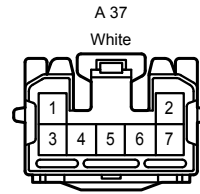
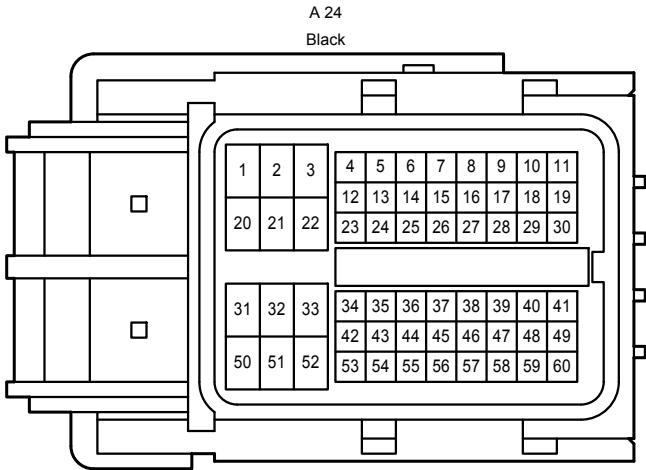
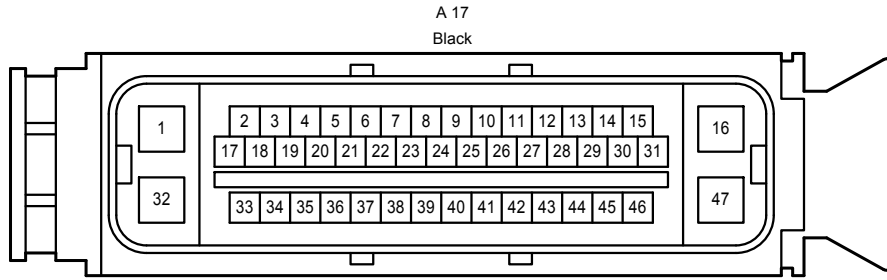

Rear Window Defogger

P 10

Black



DB

White

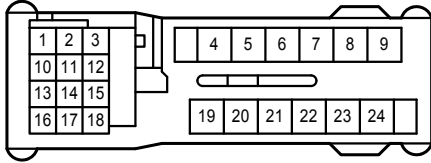

DD

White

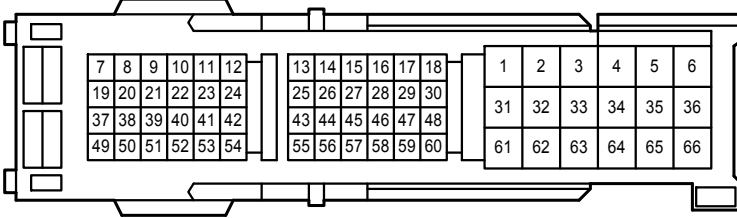

AJ3

White

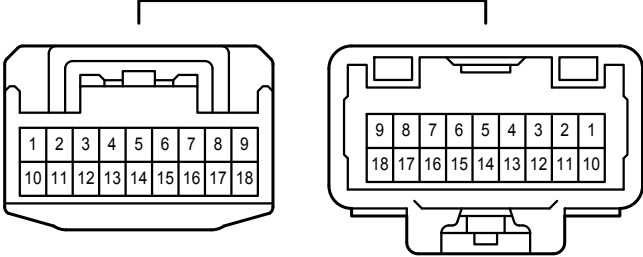

AJ10

Gray

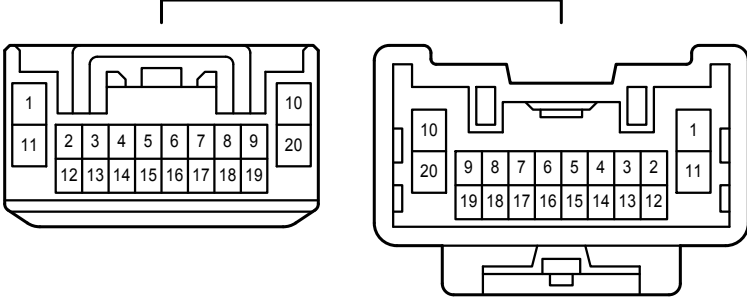

AJ11

Gray

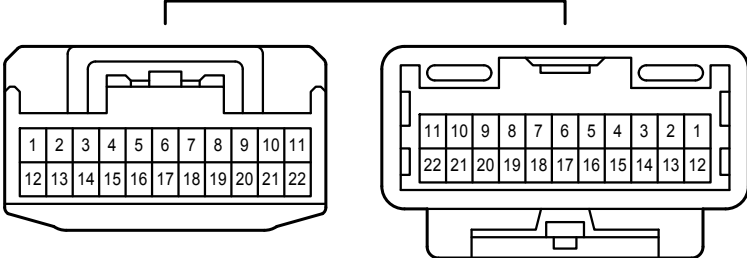

AP2
White

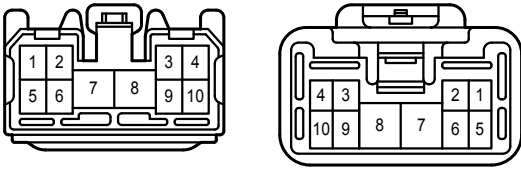

Remote Control Mirror <w/ Seat Position Memory>

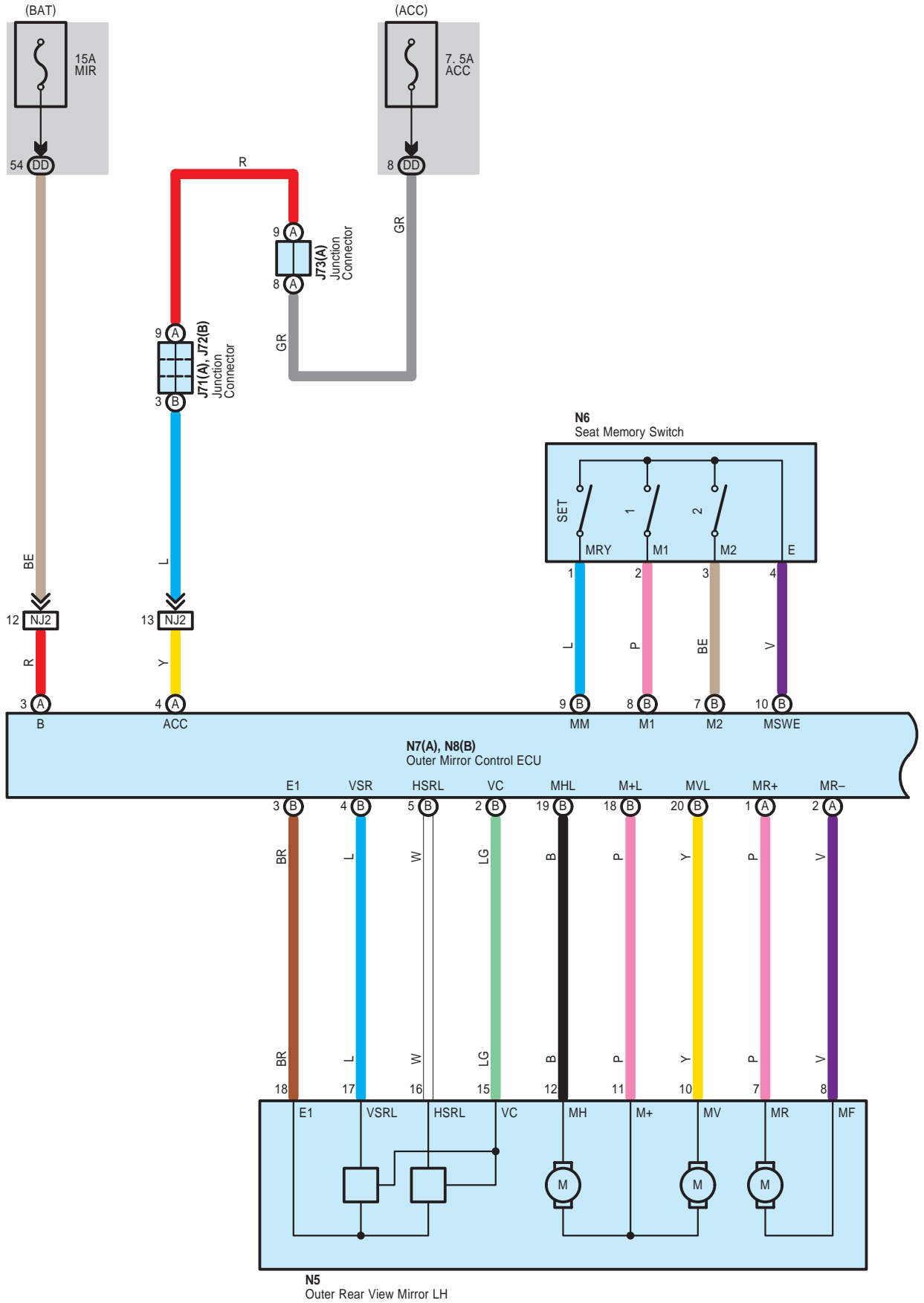

Remote Control Mirror <w/ Seat Position Memory>

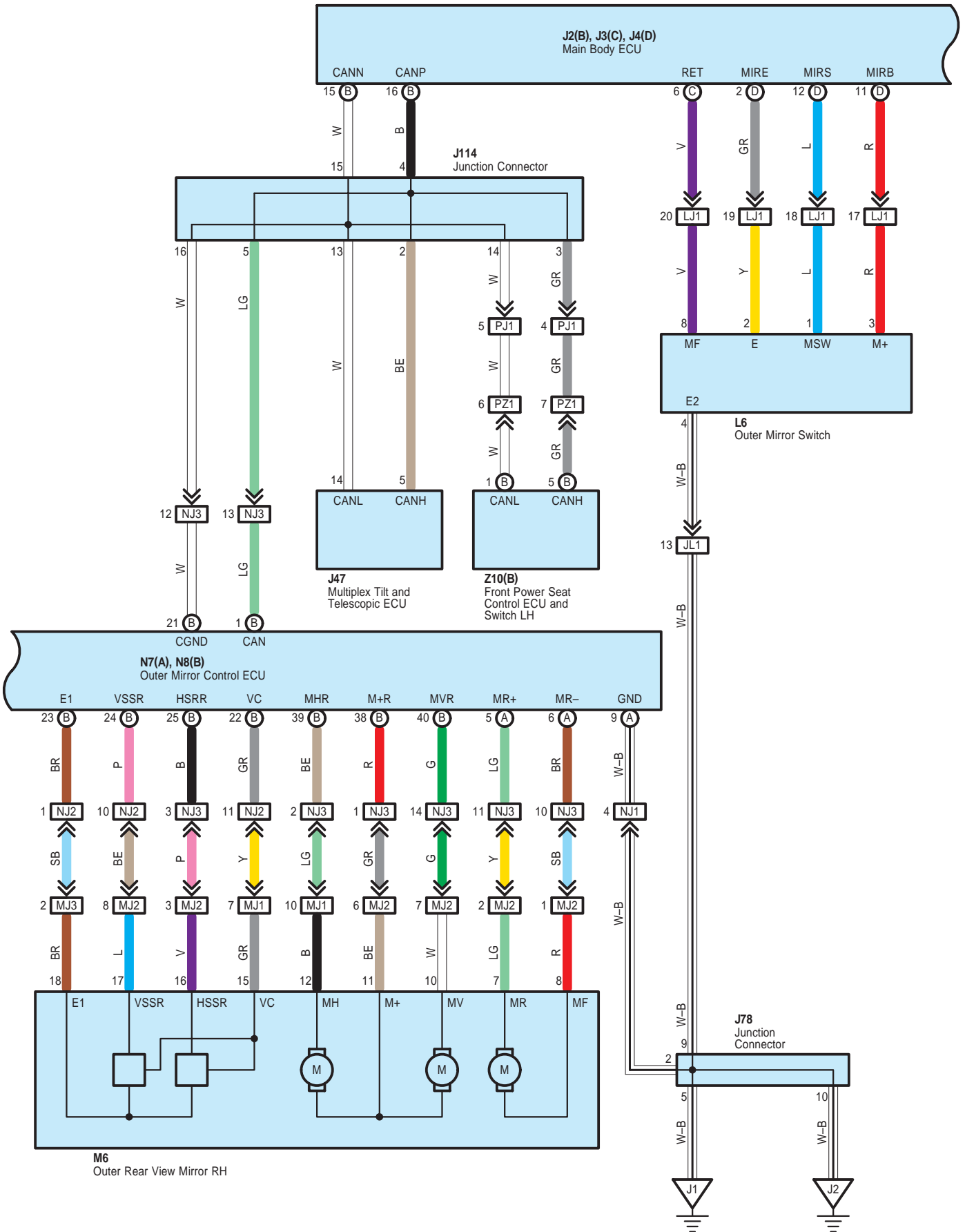

Remote Control Mirror <w/ Seat Position Memory>

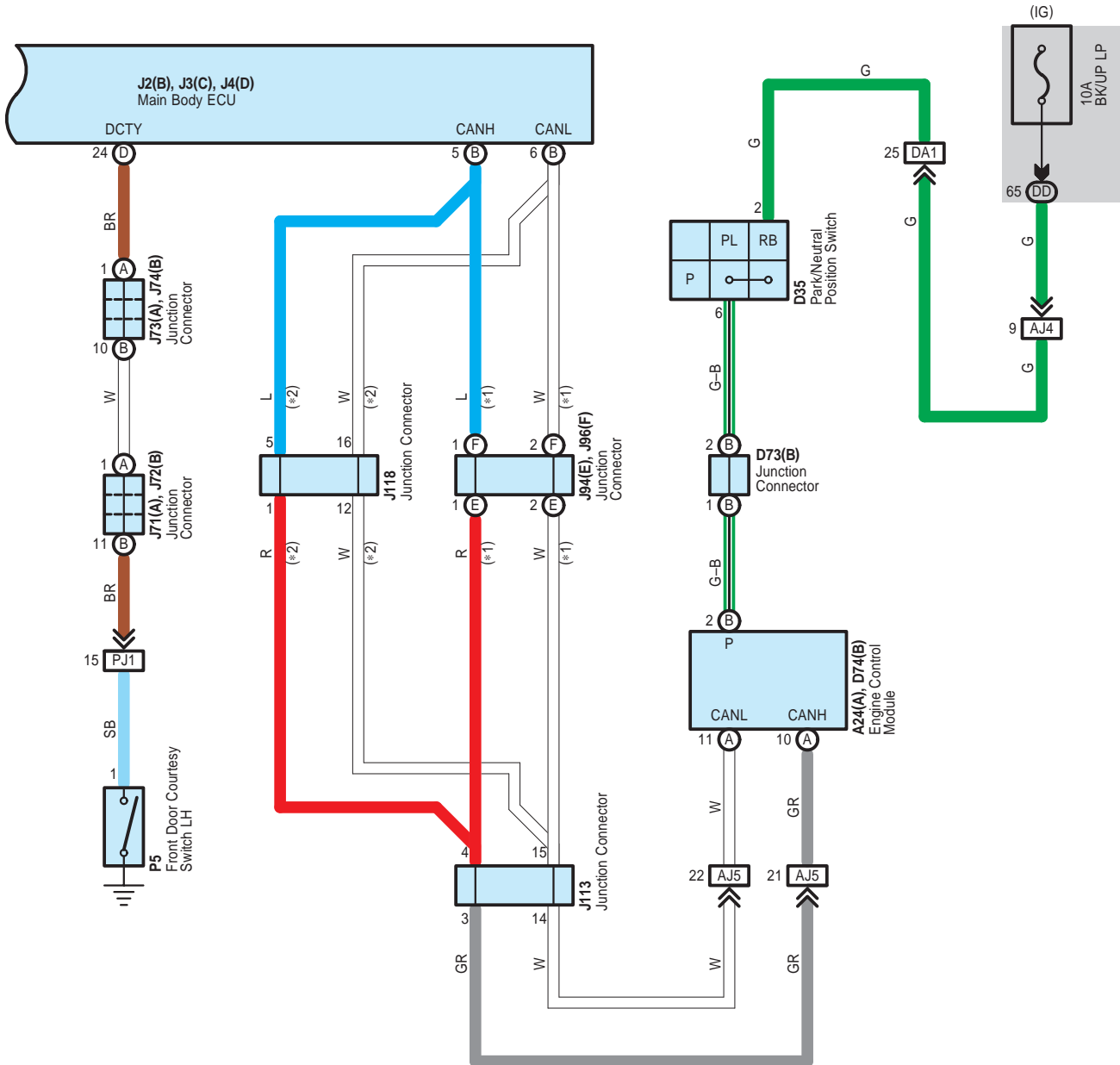

* 1 : Before Nov. 2009 Production
 * 2 : From Nov. 2009 Production

Remote Control Mirror <w/ Seat Position Memory>

A 24
Black

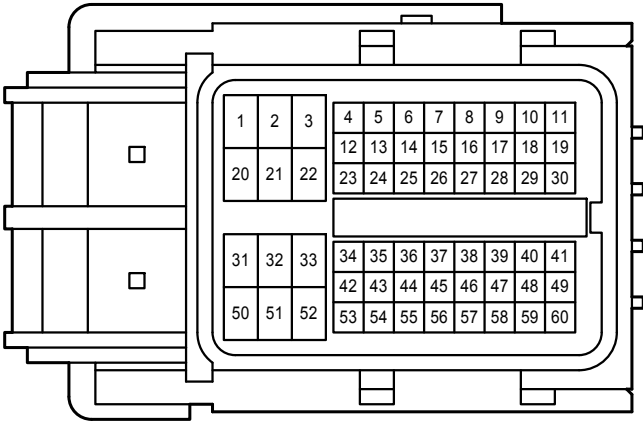

D 35
Gray

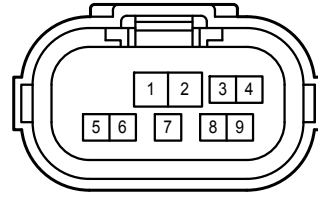

D 73
Blue

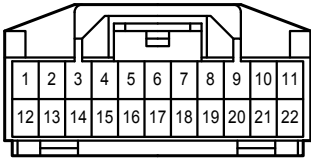

D 74
Black

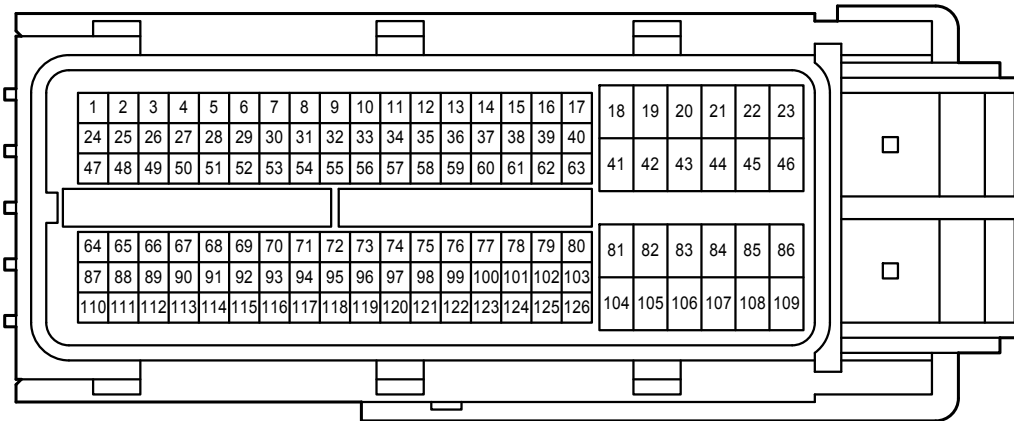

J 2
White

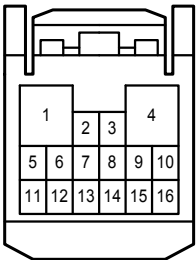

J 3
White

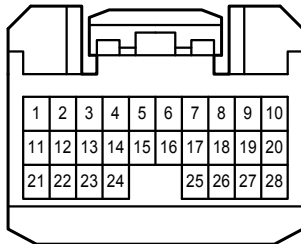

J 4
White

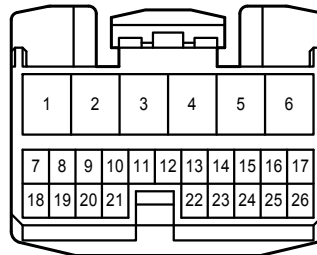

Remote Control Mirror <w/ Seat Position Memory>

J 47
White

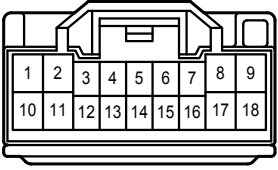

J 71
Black

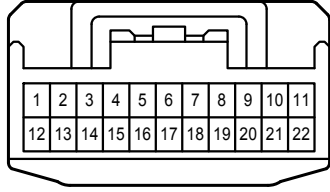

J 72
Black

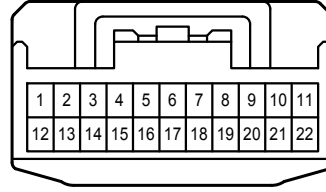

J 73
Black

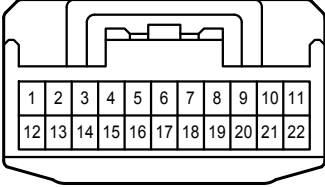

J 74
Black

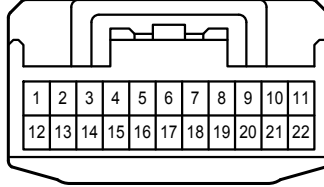

J 78
White

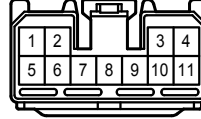

J 94
White

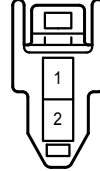

J 96
White

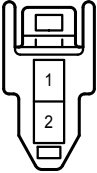

J113
Gray

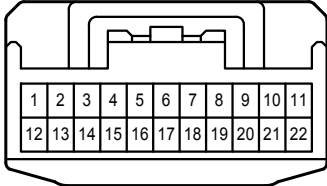

J114
Gray

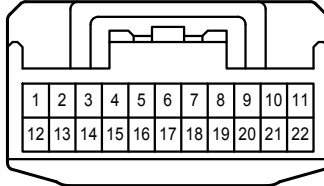

J118
Gray

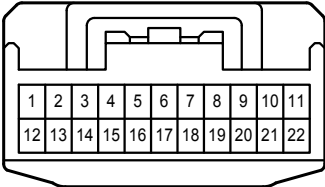

L 6
Black

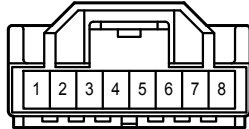

M 6
White

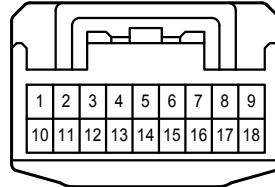

N 5
White

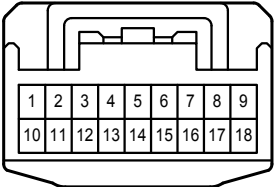

N 6
White

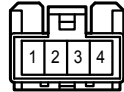

N 7
White

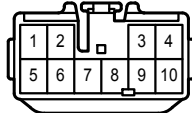

N 8
White

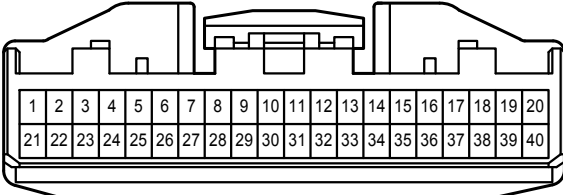

P 5
White



Z 10
White

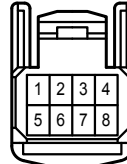

Remote Control Mirror <w/ Seat Position Memory>

DD

White

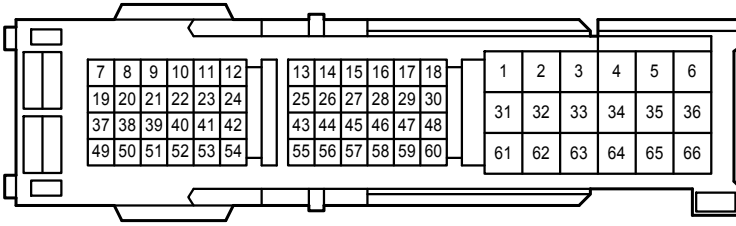

AJ4

White

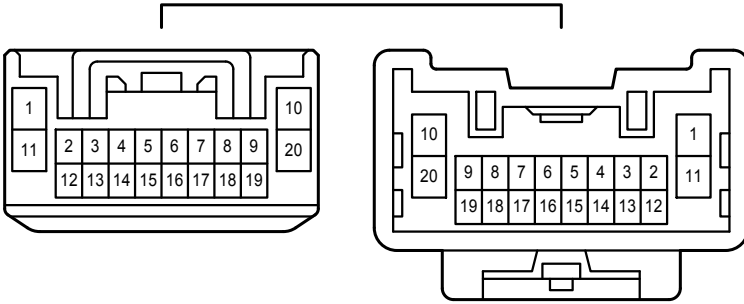

AJ5

White

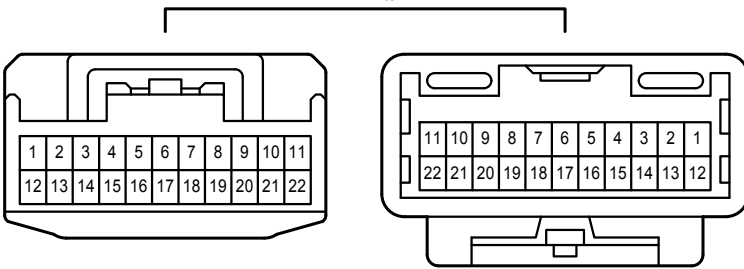

DA1

White

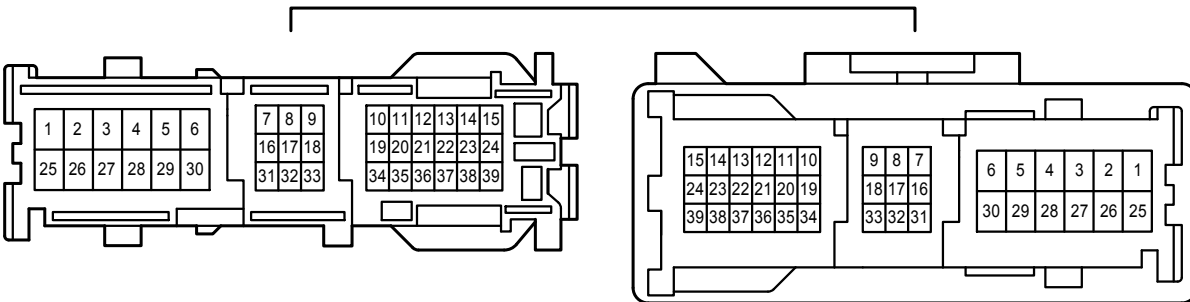

JL1

White

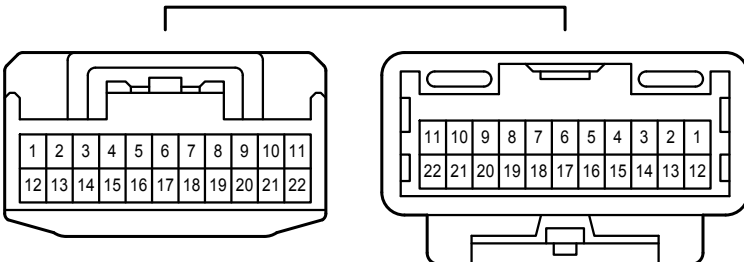

Remote Control Mirror <w/ Seat Position Memory>

LJ1
White

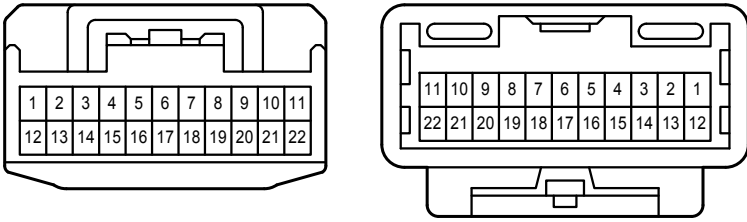

MJ1
Blue

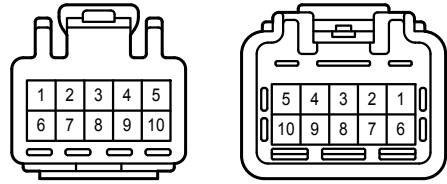

MJ2
Blue

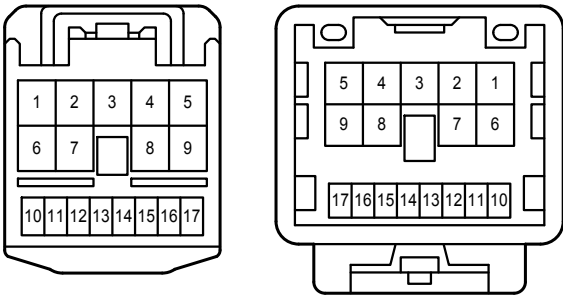

MJ3
Blue

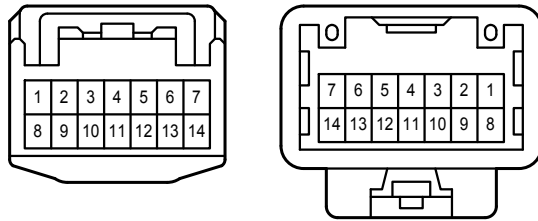

NJ1
Blue

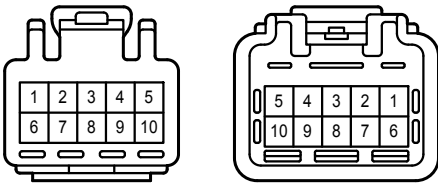

NJ2
Blue

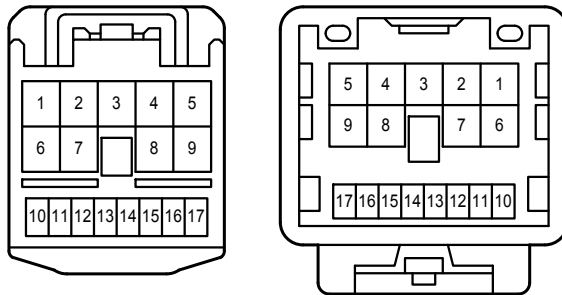

NJ3
Blue

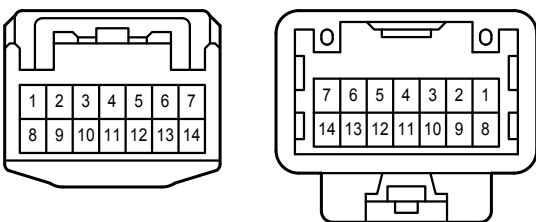

Remote Control Mirror <w/ Seat Position Memory>

PJ1
Black

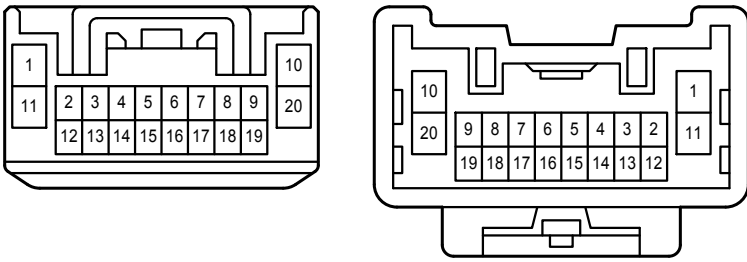

PZ1
White

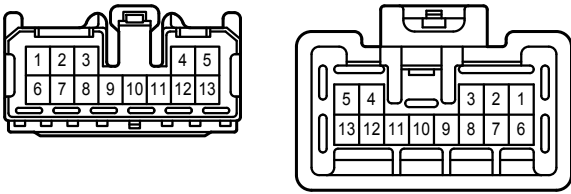

Remote Control Mirror <w/o Seat Position Memory>

* 1 : w/ Retractor

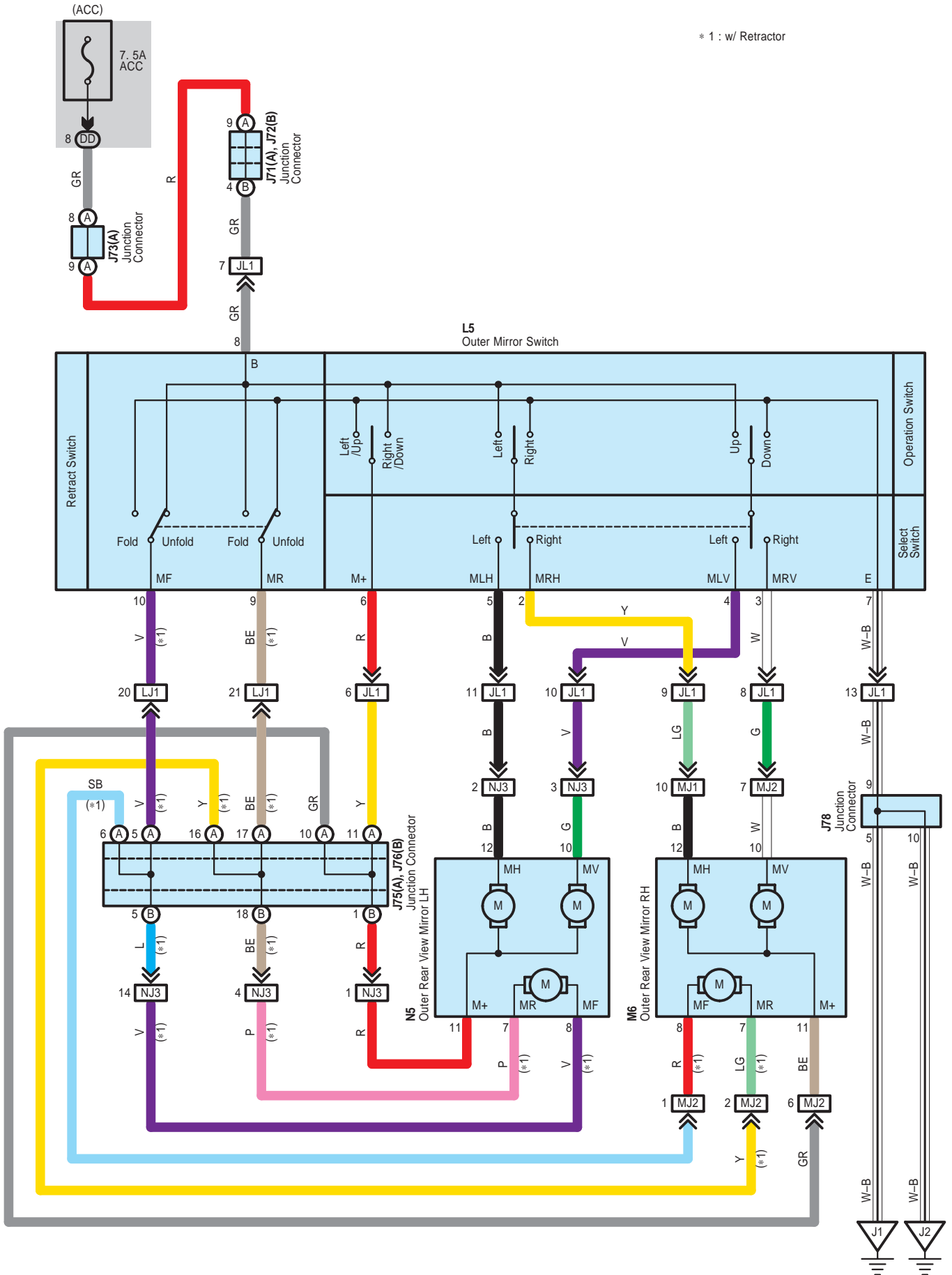

Remote Control Mirror <w/o Seat Position Memory>

J 71
Black

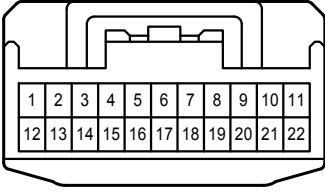

J 72
Black

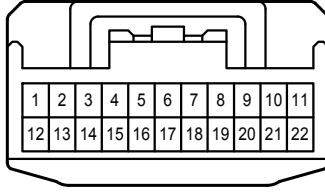

J 73
Black

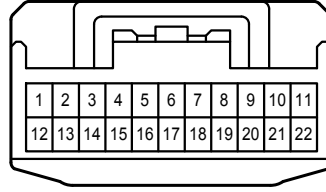

J 75
White

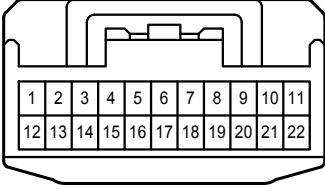

J 76
White

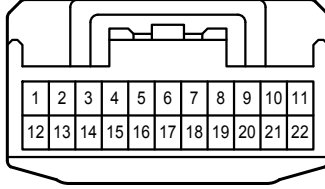

J 78
White

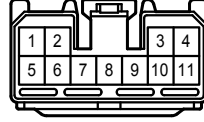

L 5
White

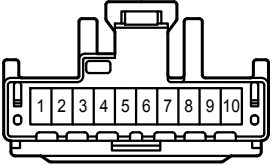

M 6
White

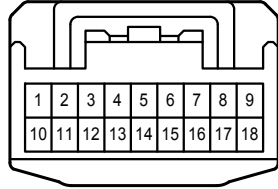

N 5
White

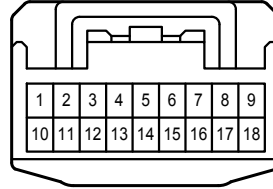

DD
White

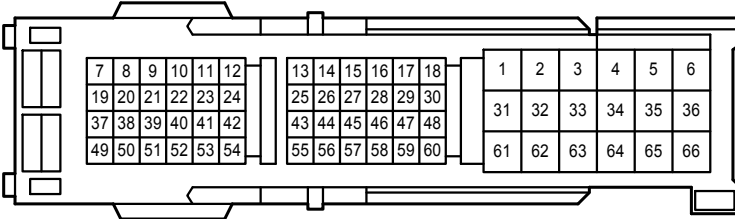

JL1
White

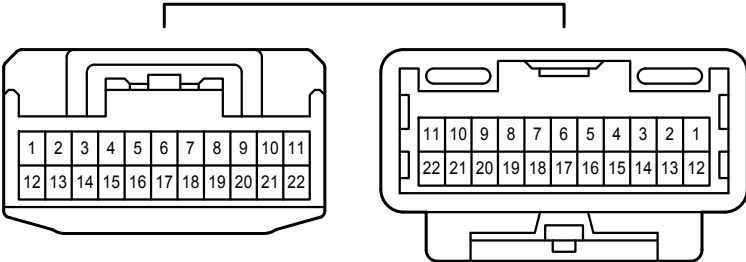

LJ1
White

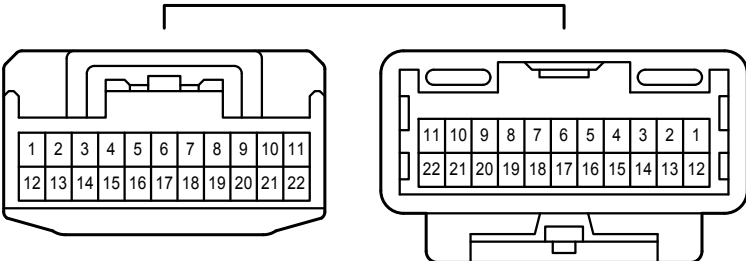

MJ1
Blue

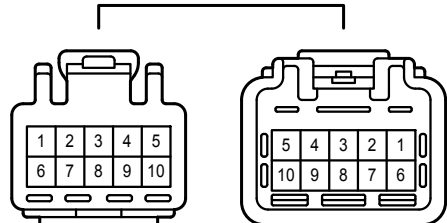

Remote Control Mirror <w/o Seat Position Memory>

MJ2
Blue

NJ3
Blue

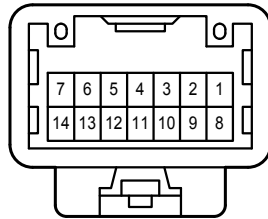
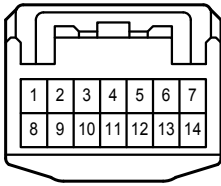
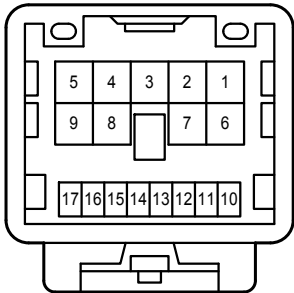
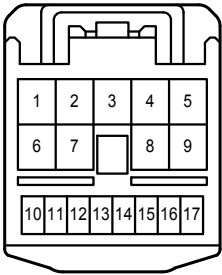

Seat Heater <w/o Climate Control Seat>

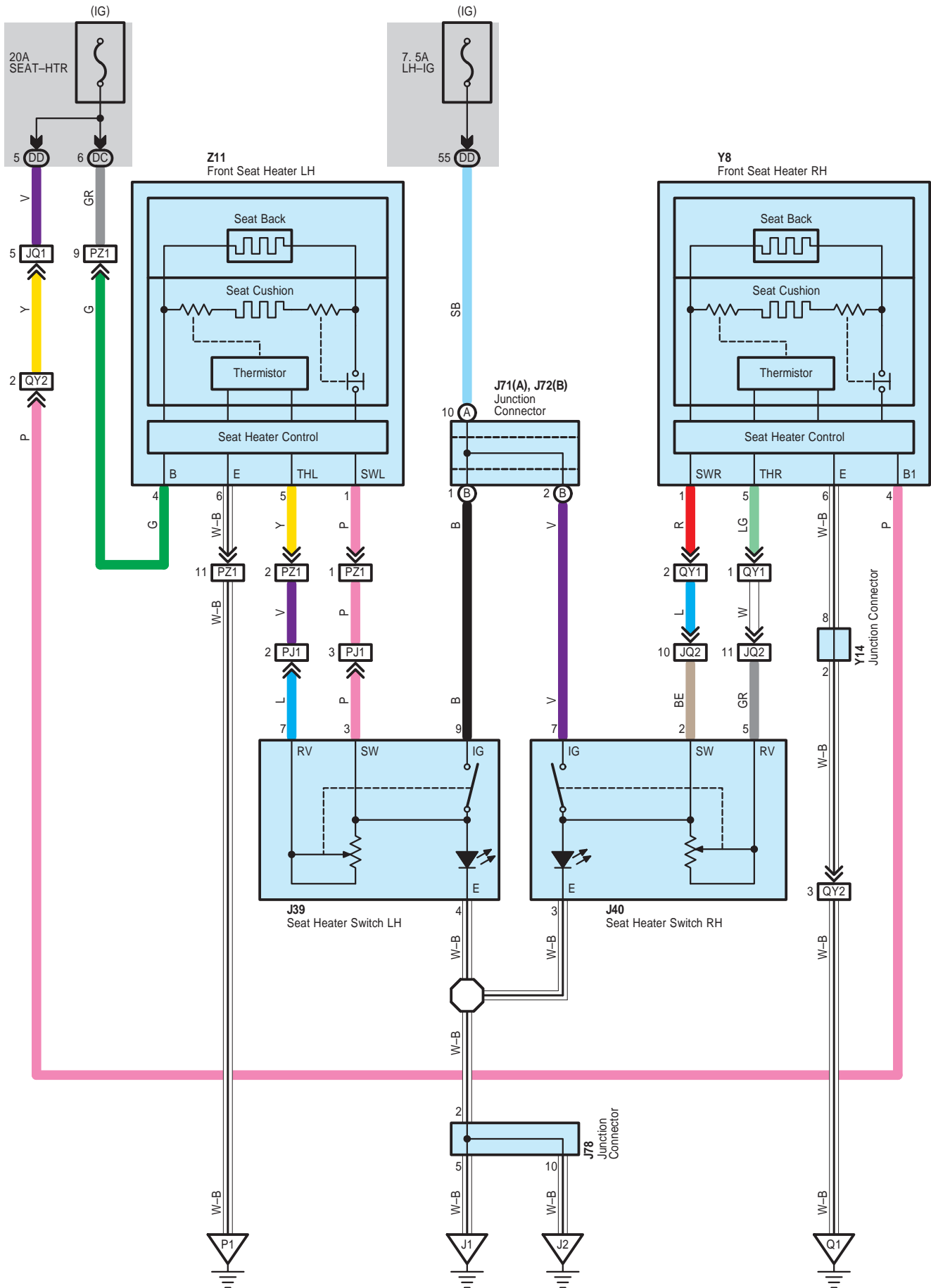

Seat Heater <w/o Climate Control Seat>

J 39
Black

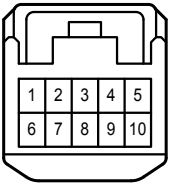

J 40
Black

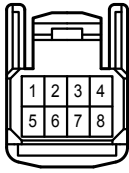

J 71
Black

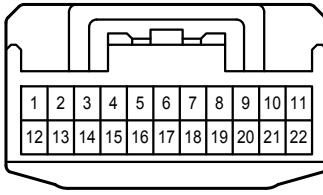

J 72
Black

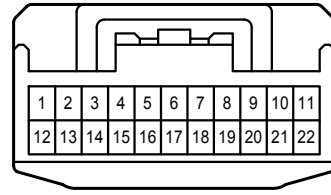

J 78
White

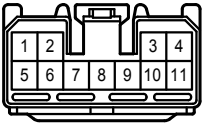

Y 8
White



Y 14
White

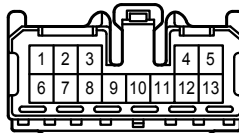

Z 11
White



DC
White

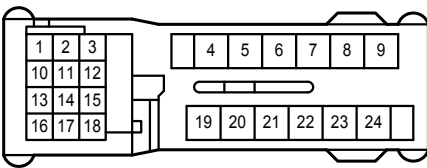

DD
White

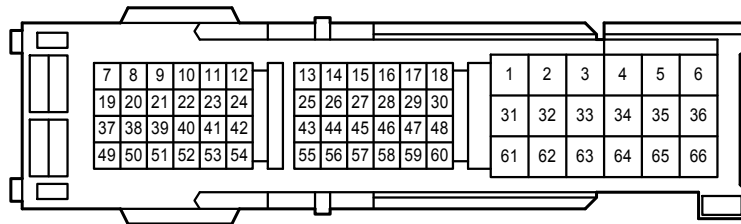

JQ1
Gray

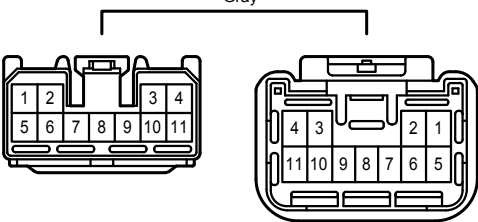

JQ2
Gray

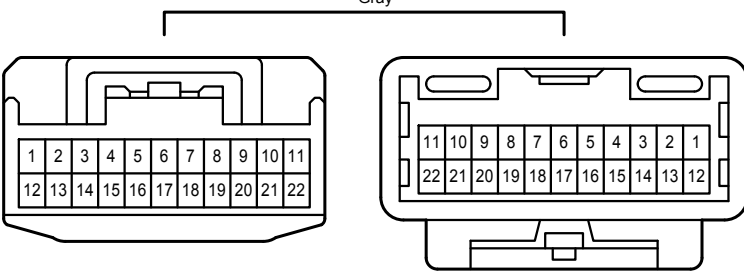

PJ1
Black

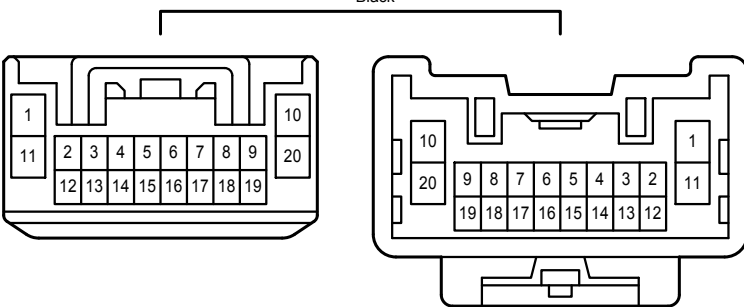

Seat Heater <w/o Climate Control Seat>

PZ1
White

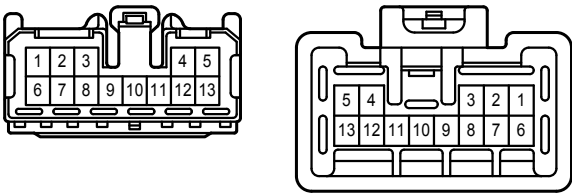

QY1
White

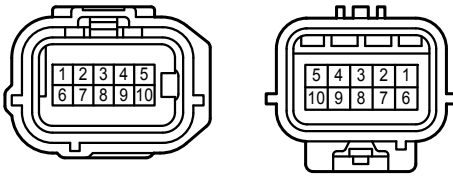

QY2
White

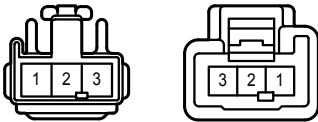

Shift Lock <Column Shift>

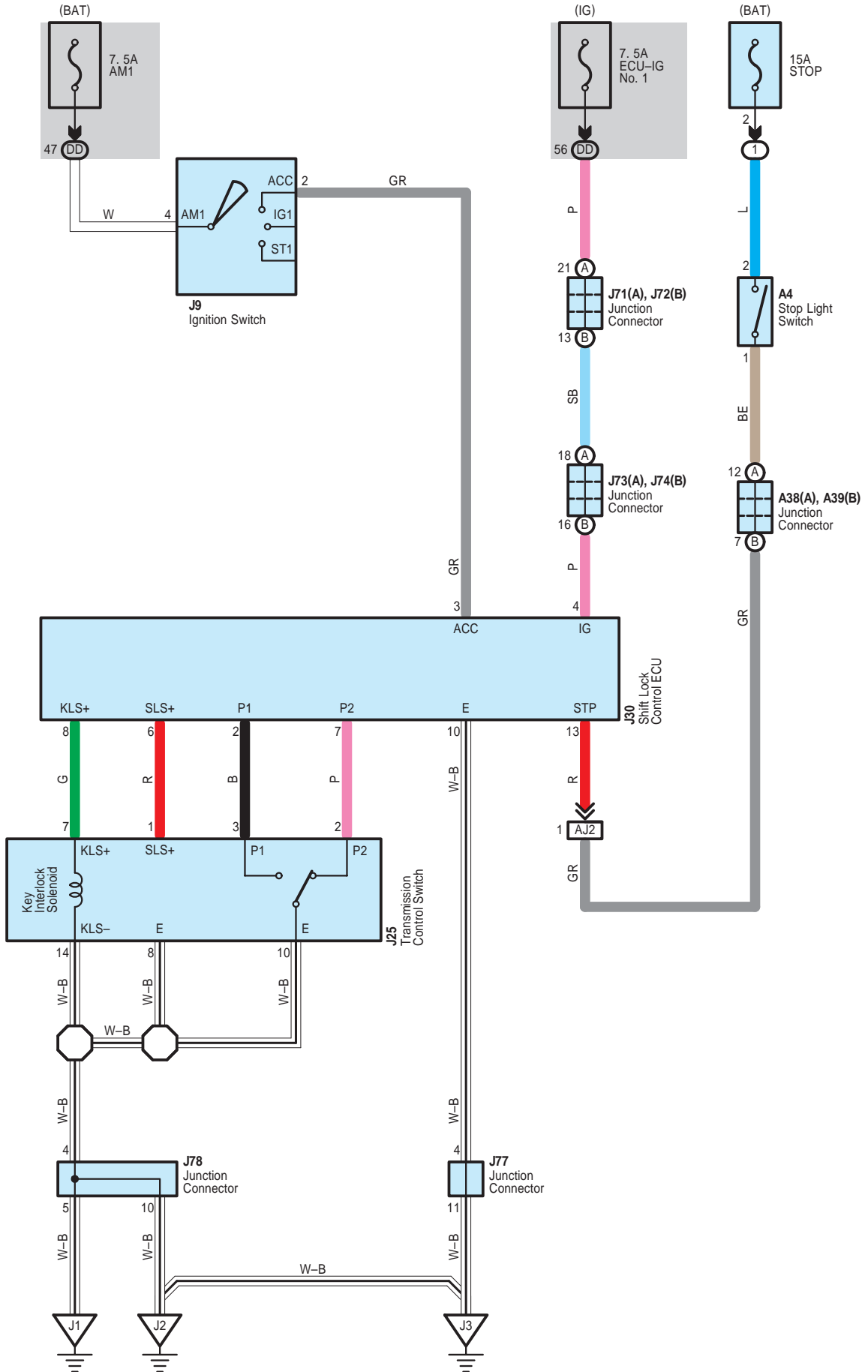

Shift Lock <Column Shift>

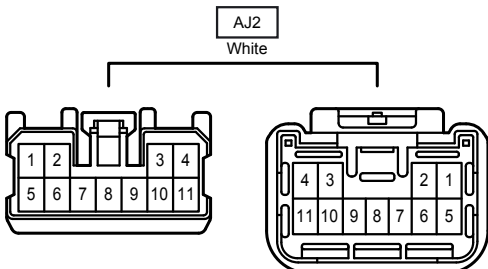
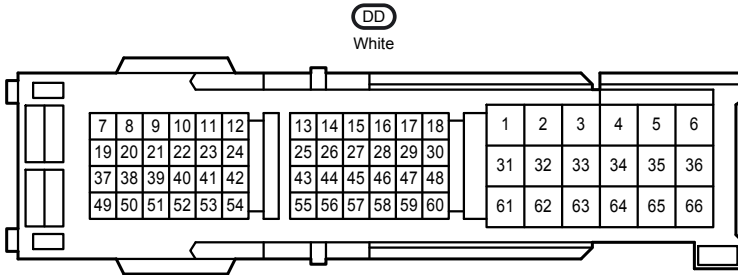
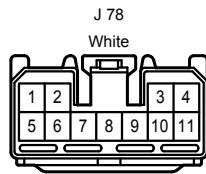
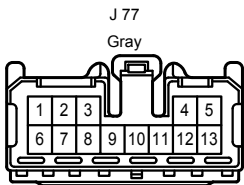
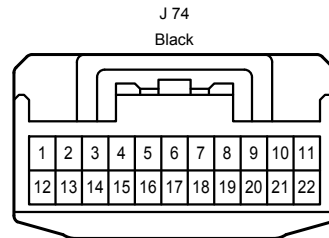
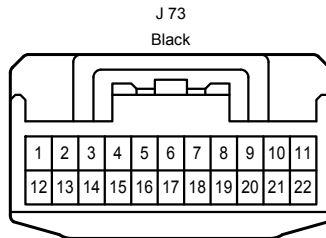
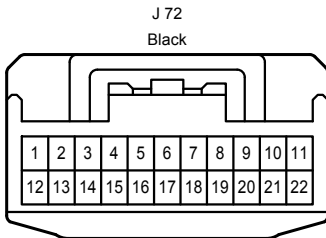
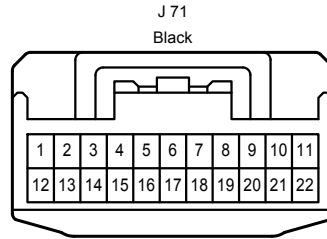
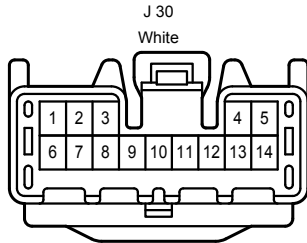
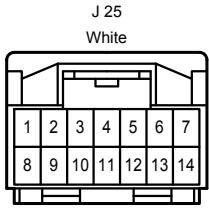
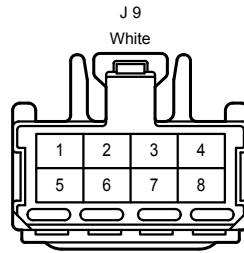
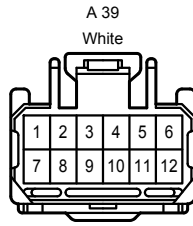
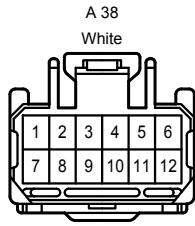
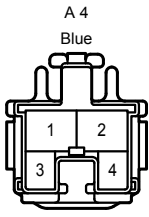

Shift Lock <Floor Shift>

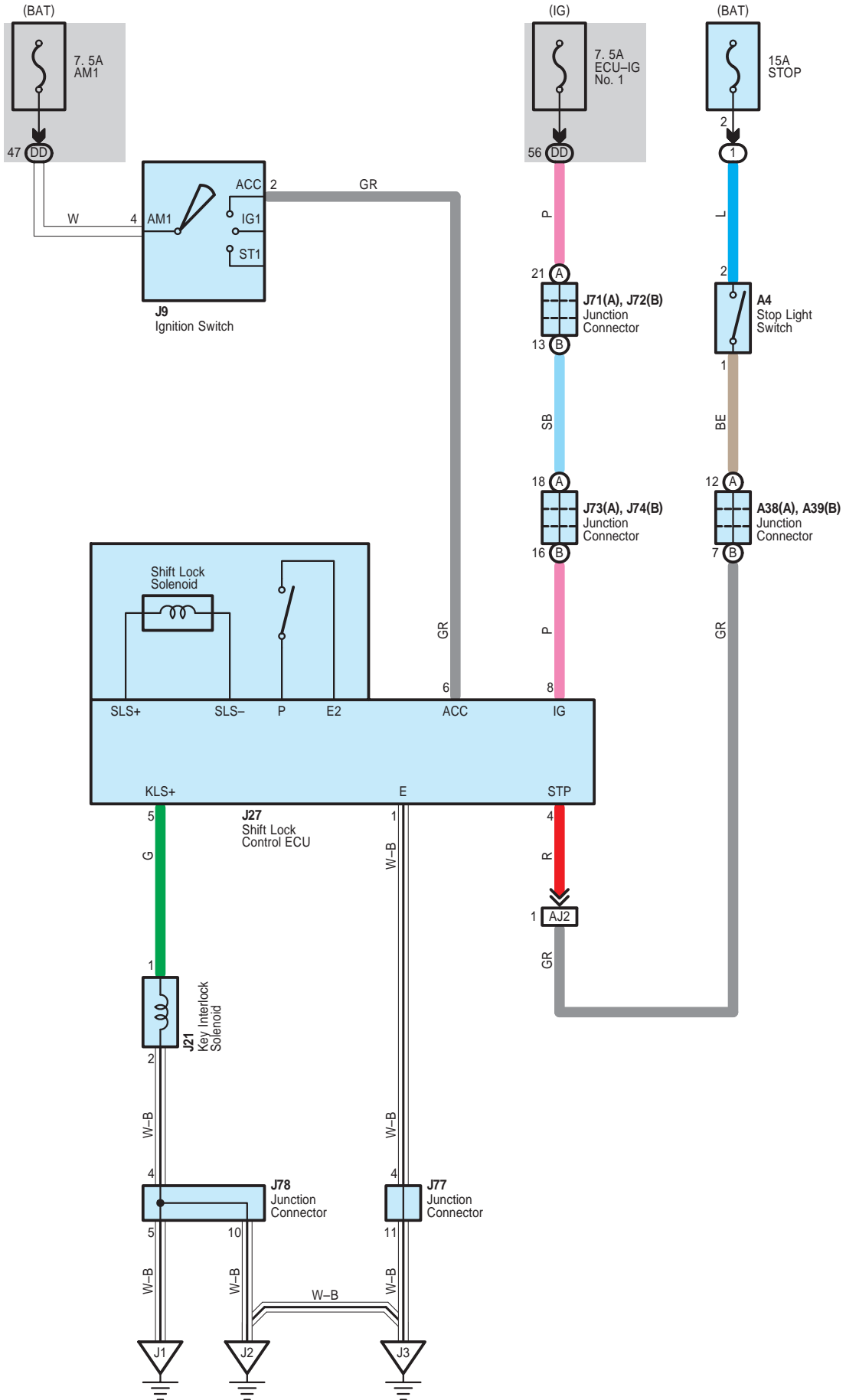

Shift Lock <Floor Shift>

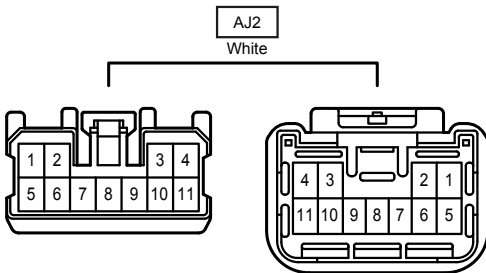
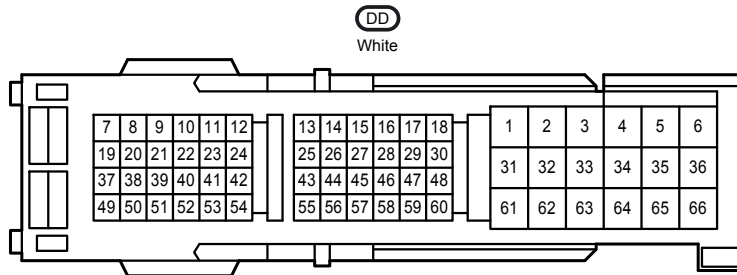
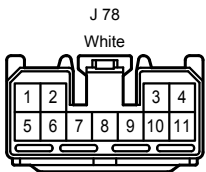
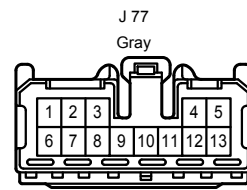
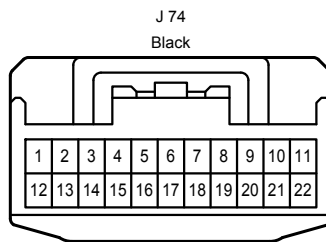
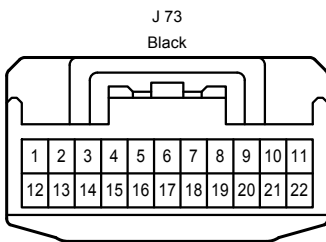
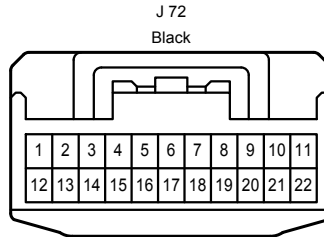
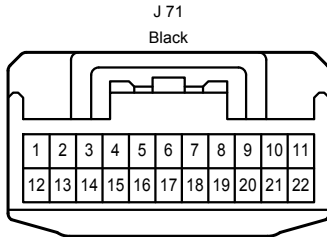
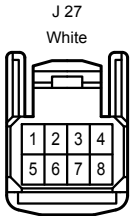
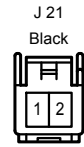
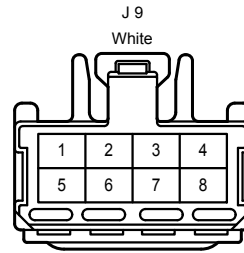
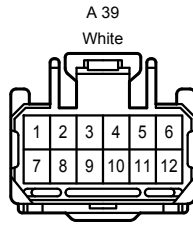
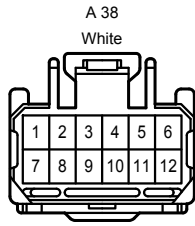
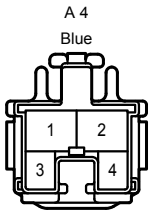

Sliding Roof

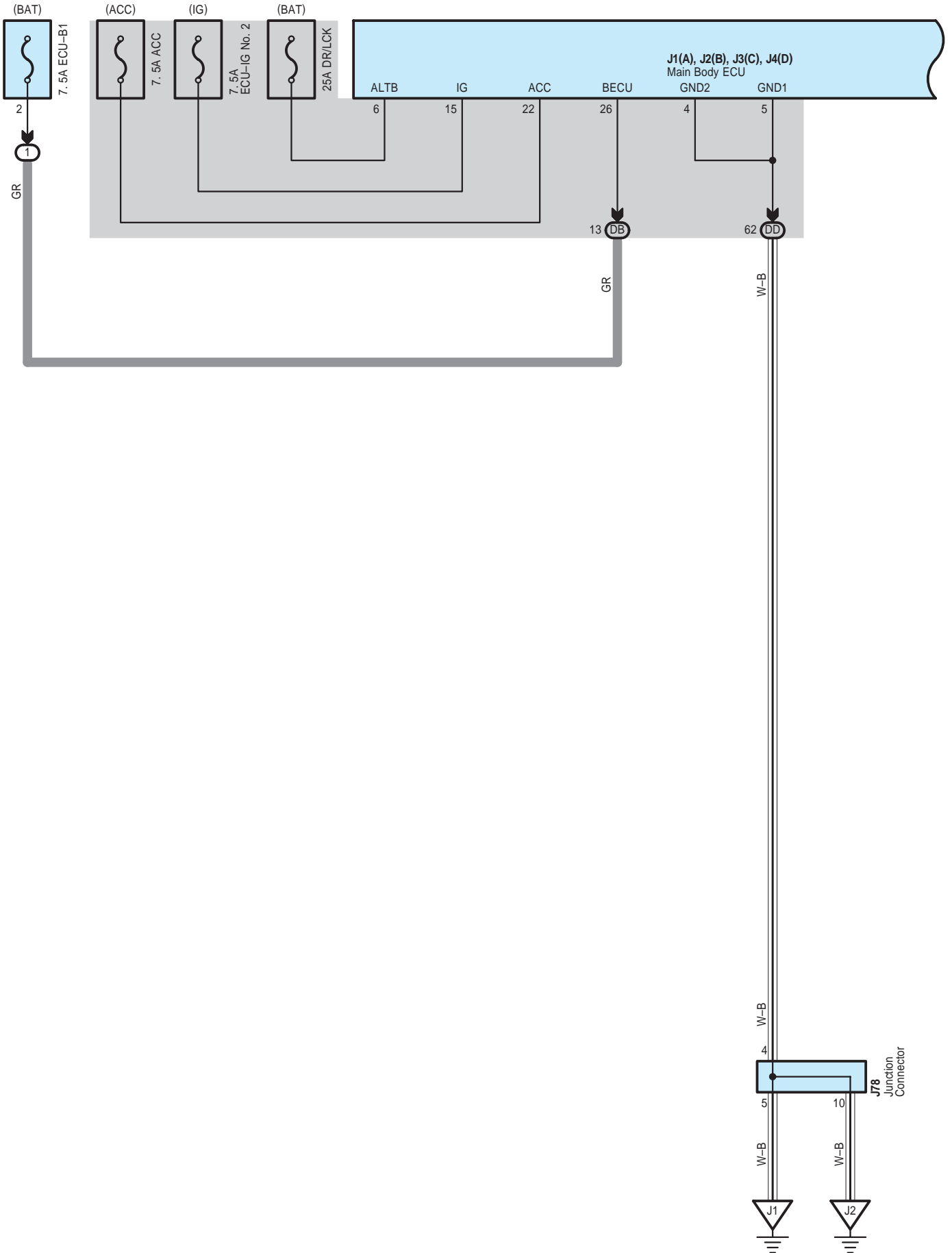

Sliding Roof

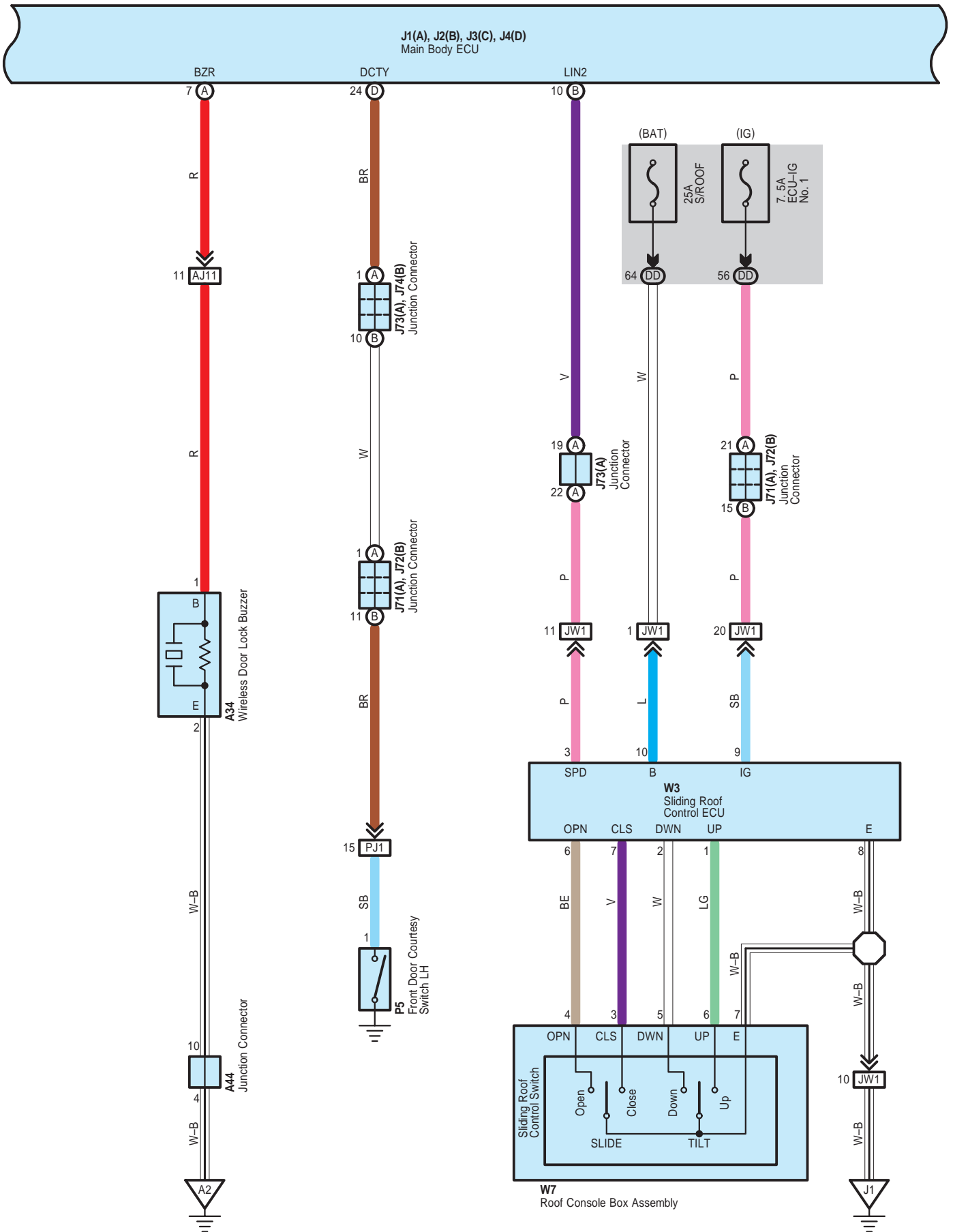

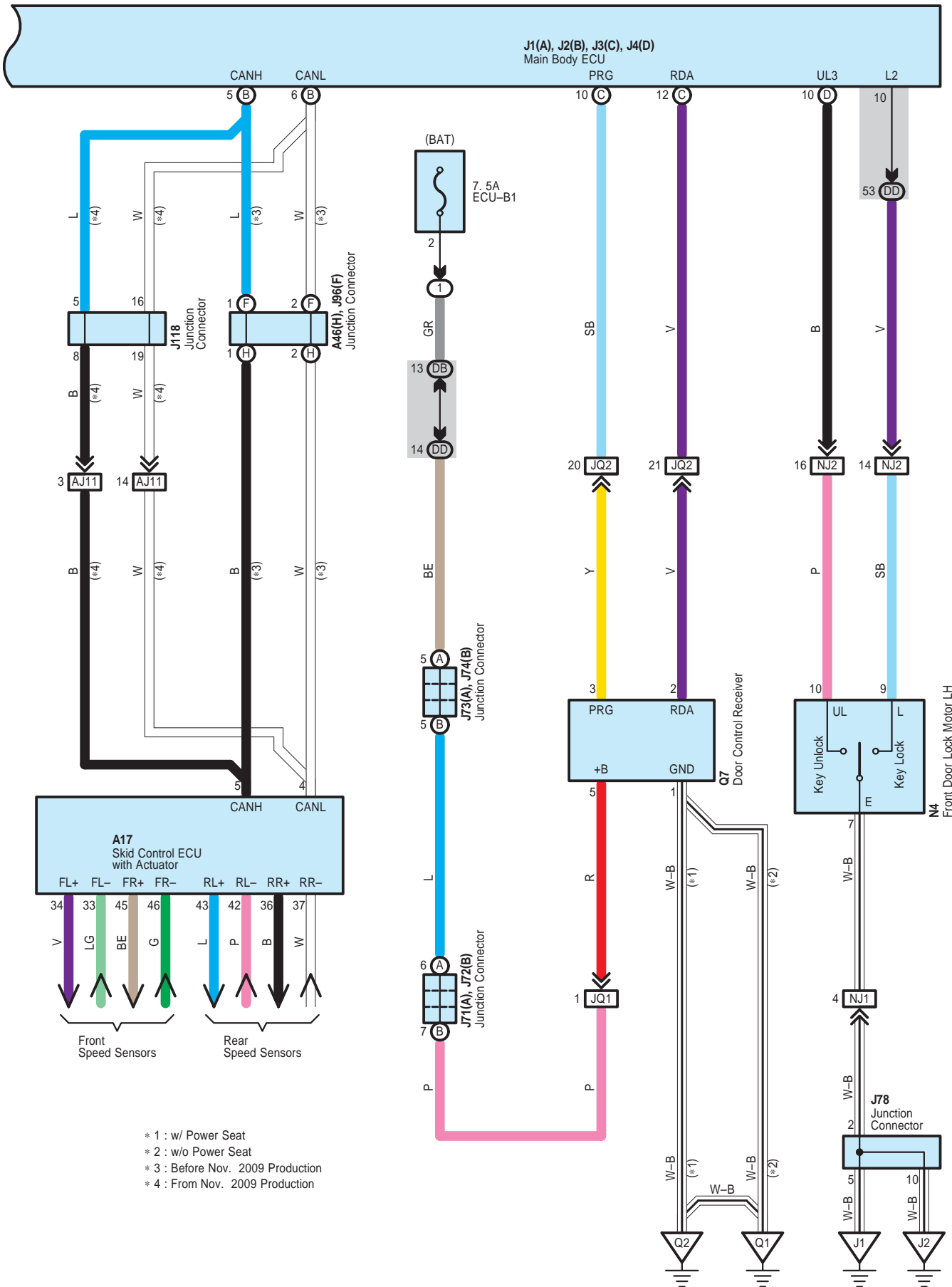

Sliding Roof

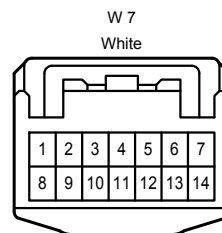
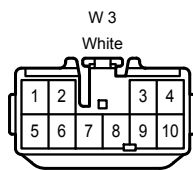
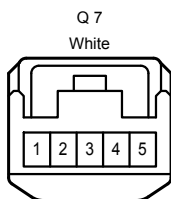
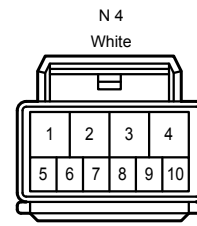
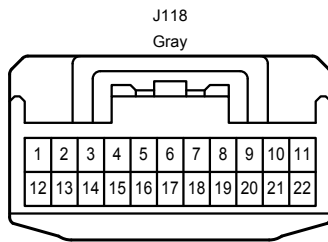
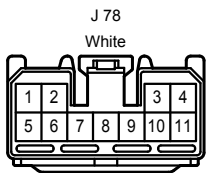
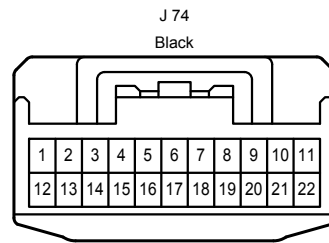
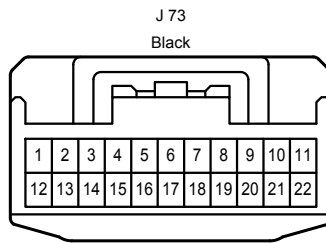
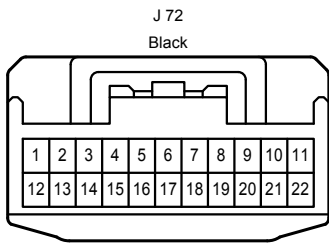
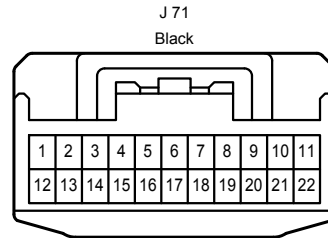
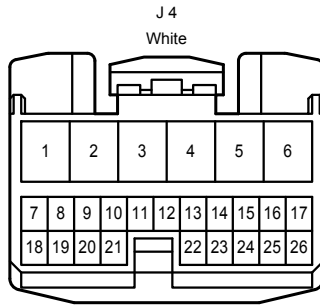
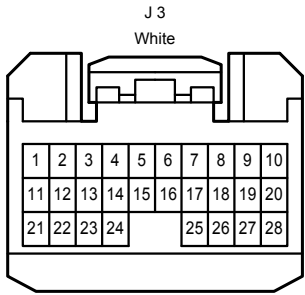
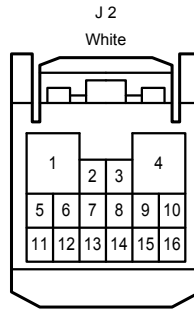
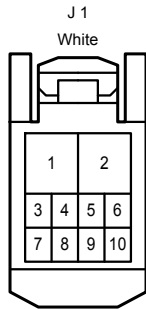
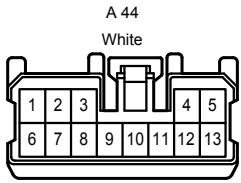
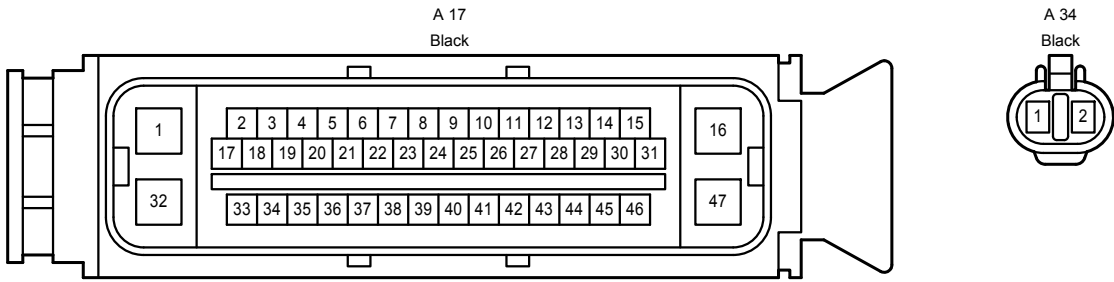

Sliding Roof

DB
White

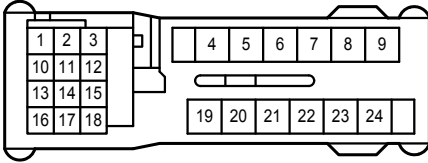

DD
White

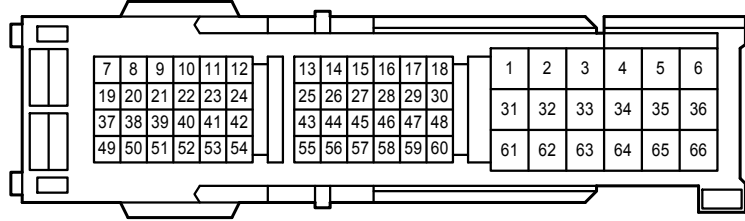

AJ11
Gray

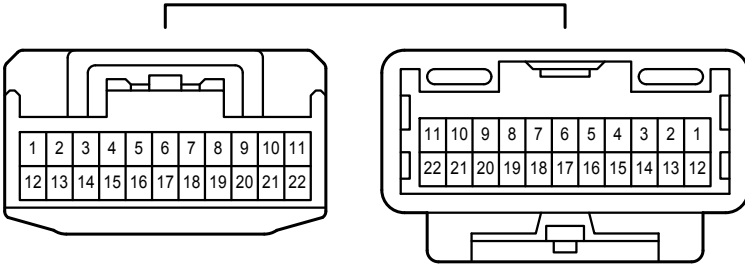

JQ1
Gray

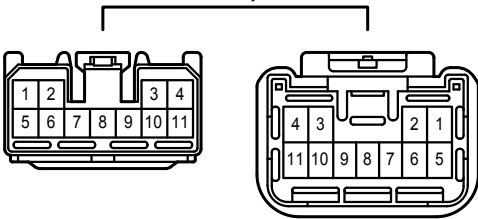

JQ2
Gray

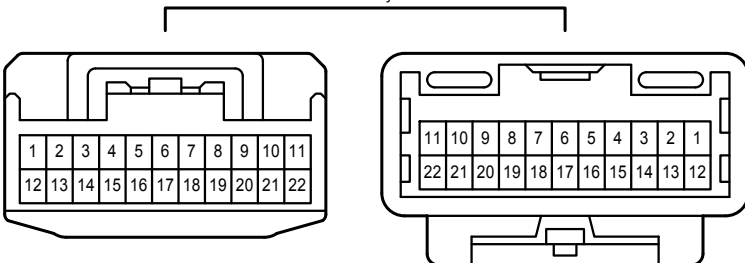

JW1
White

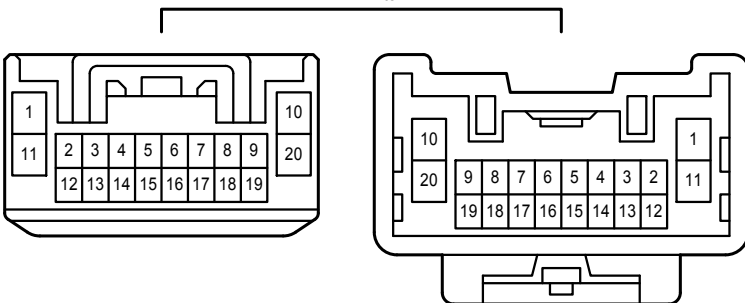

NJ1
Blue

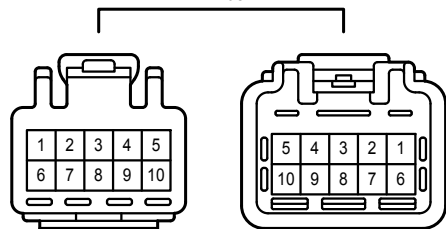

NJ2
Blue

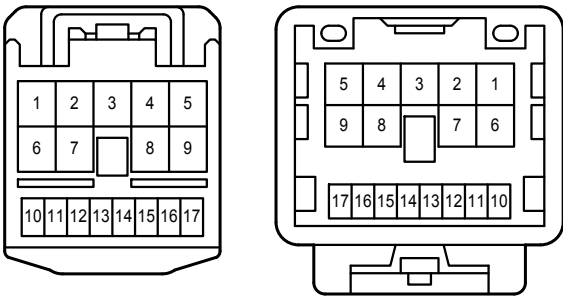

PJ1
Black

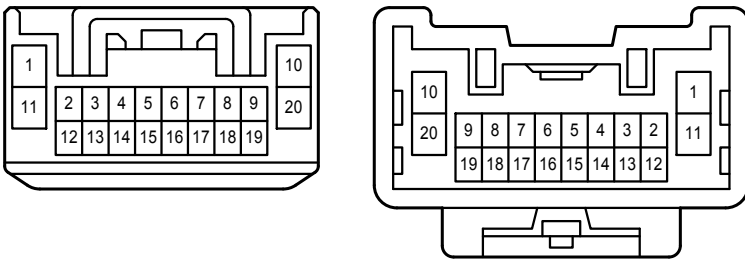

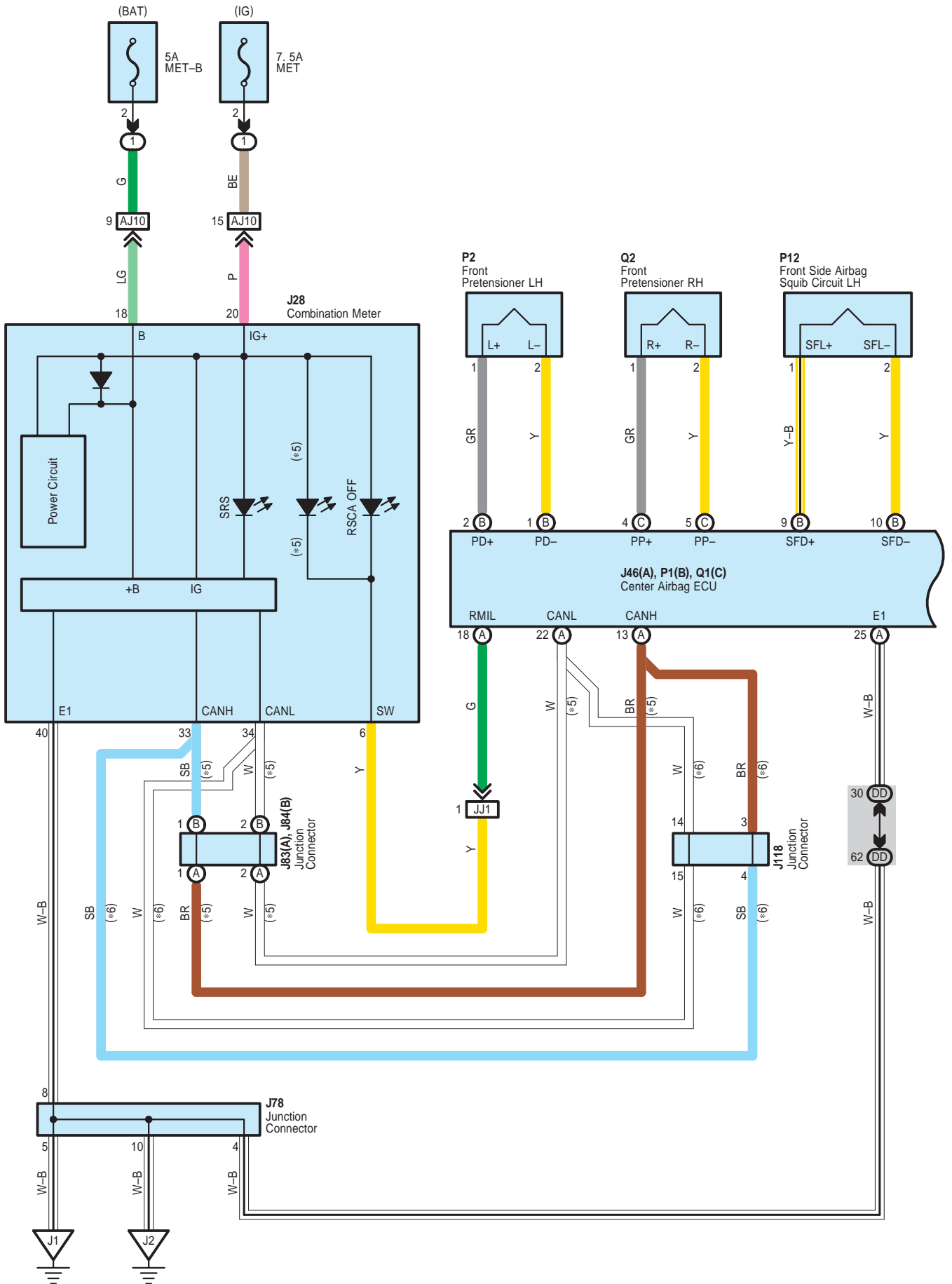

- * 1 : w/ Airbag Cutoff Switch
- * 5 : Before Nov. 2009 Production
- * 6 : From Nov. 2009 Production

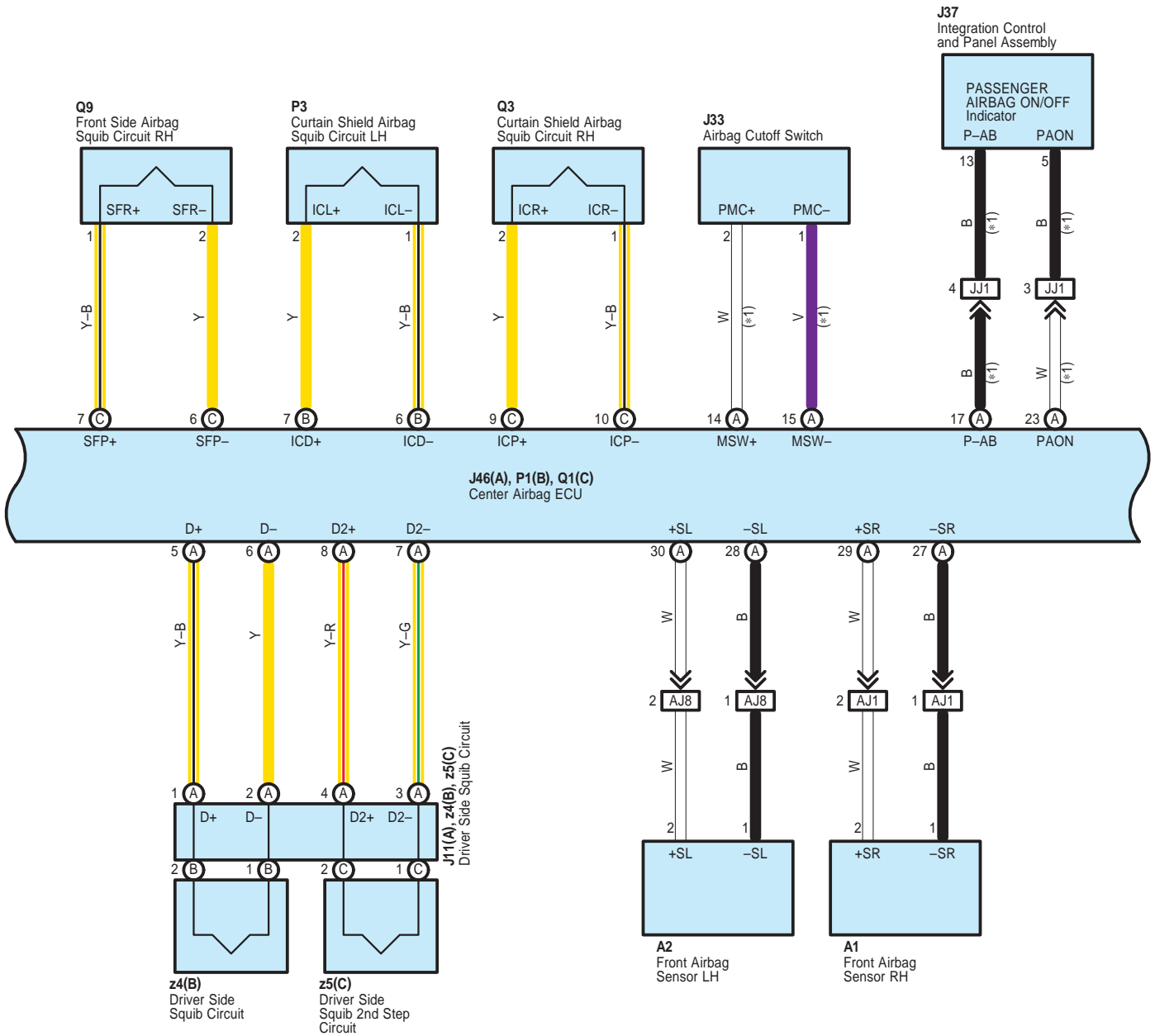

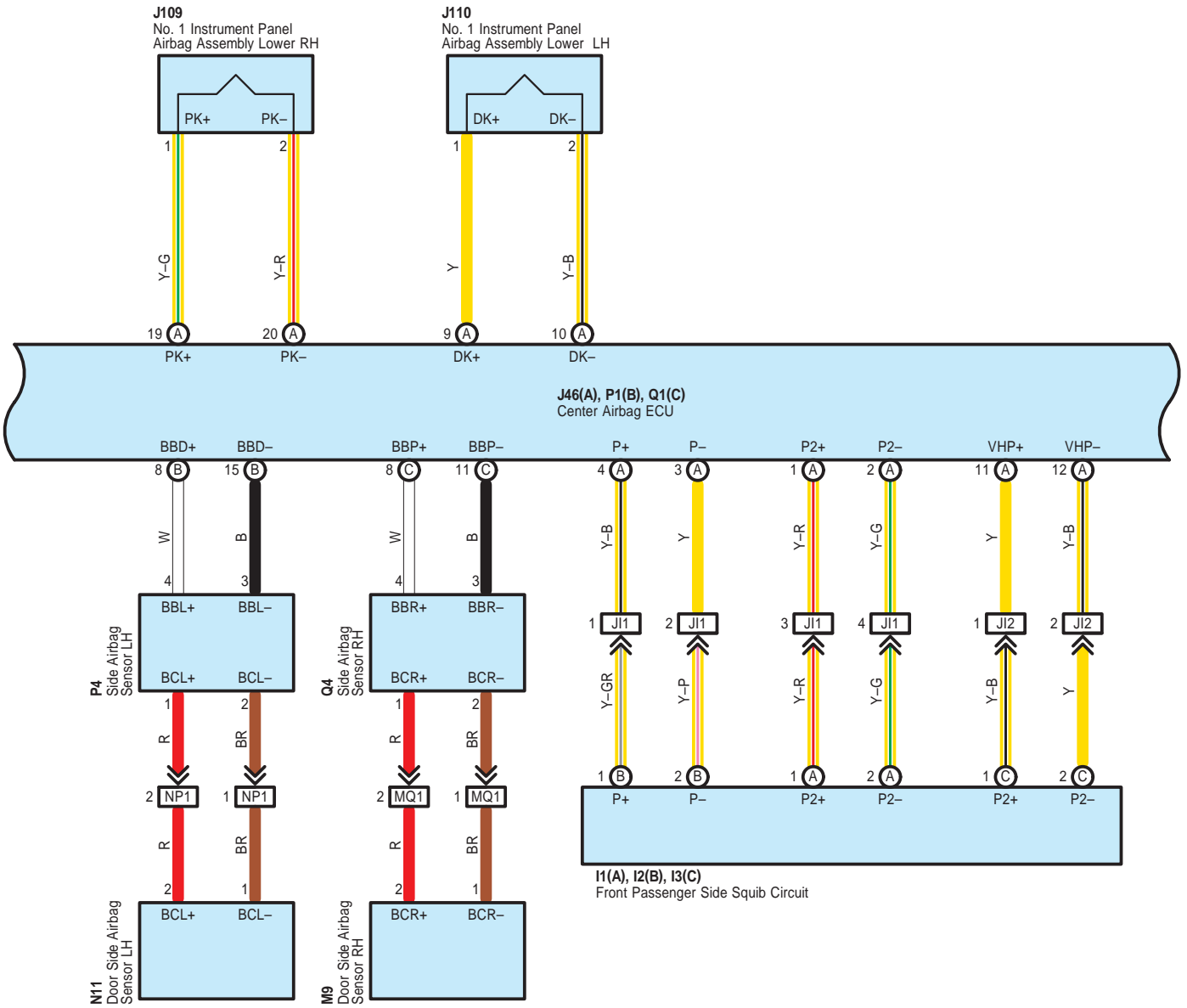

- * 3 : w/ Power Seat
- * 4 : w/o Power Seat
- * 5 : Before Nov. 2009 Production
- * 6 : From Nov. 2009 Production
- * 7 : w/ Curtain Airbag Cutoff Switch

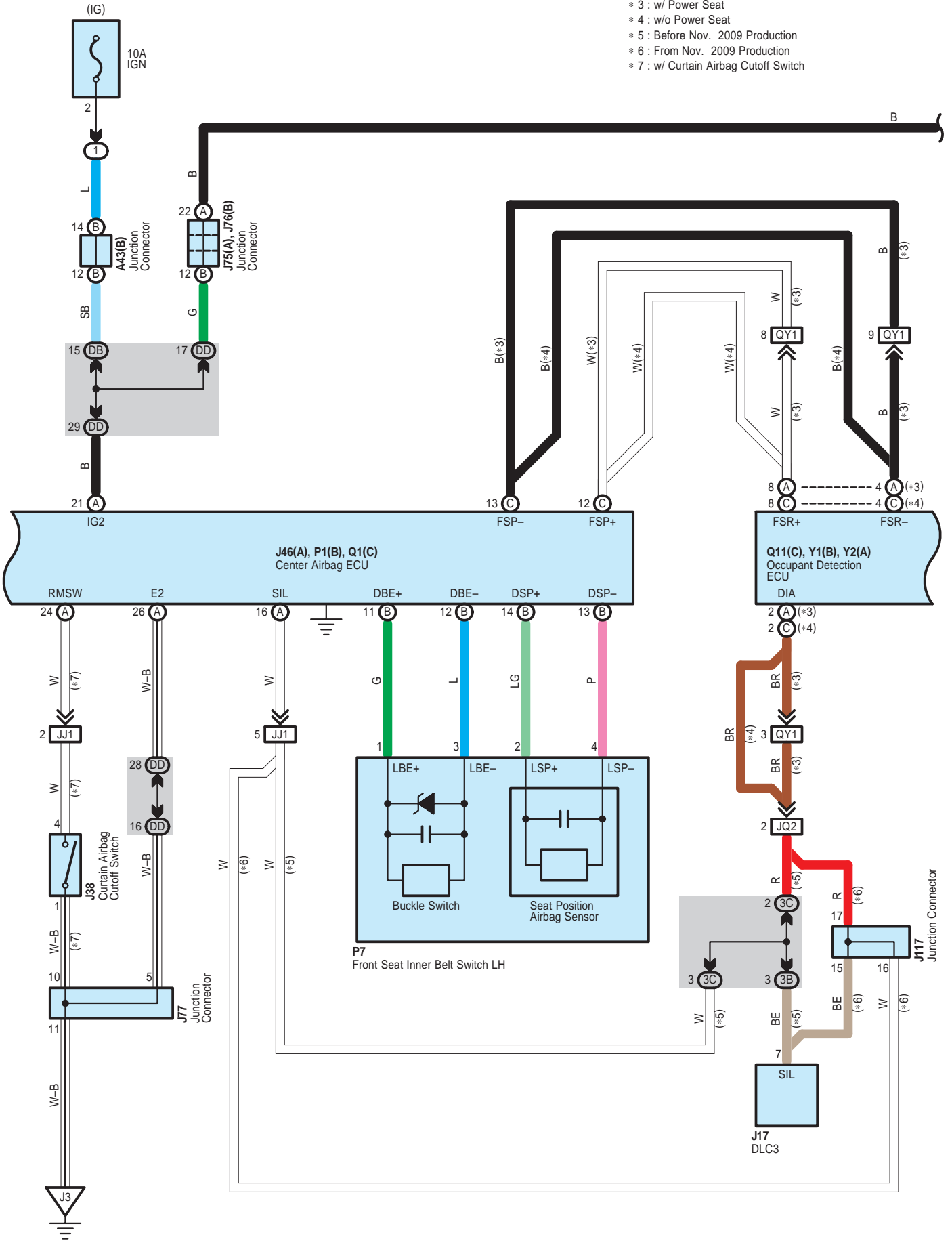

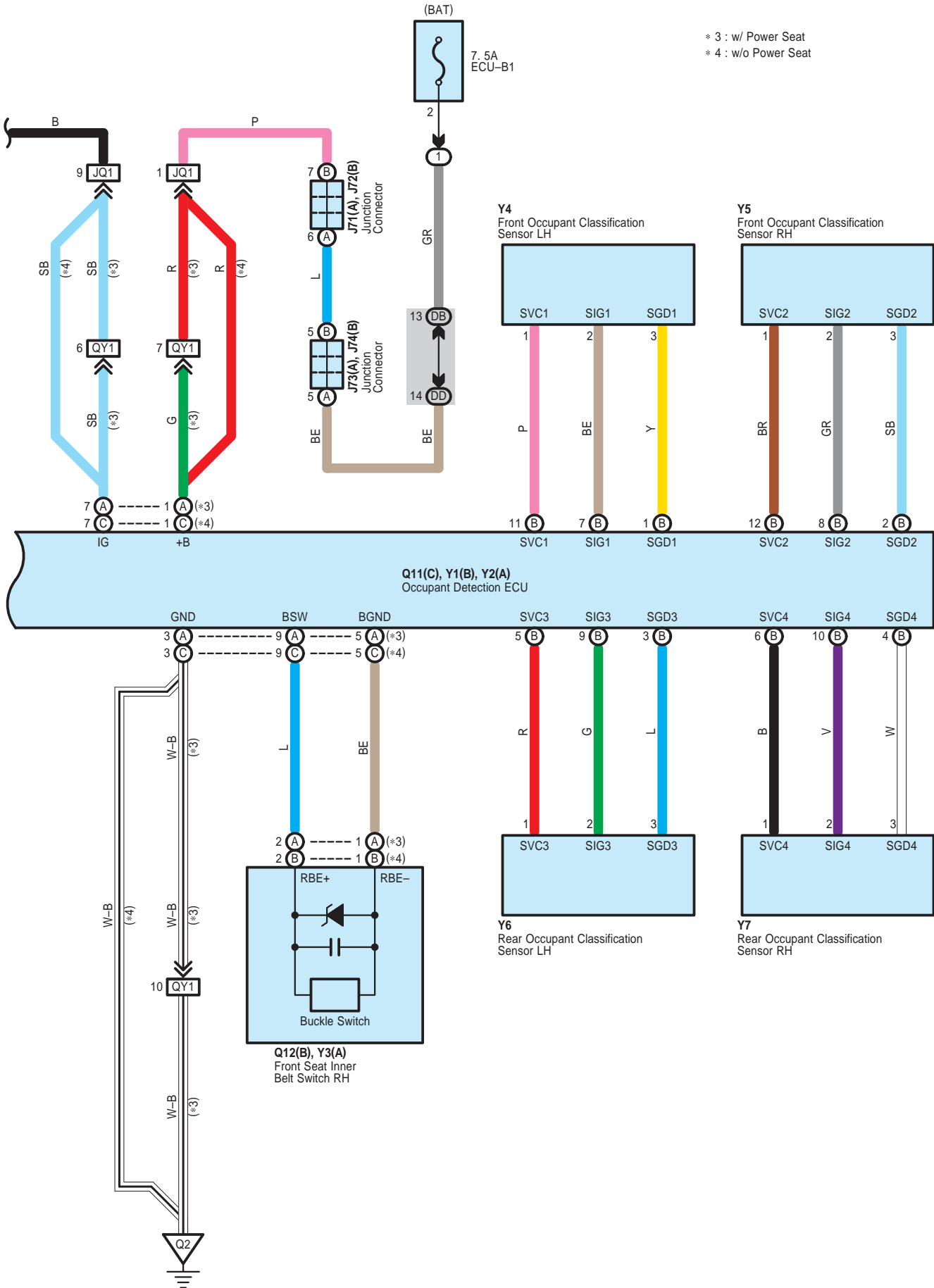

SRS

A 1

Yellow



A 2

Yellow



A 43

White

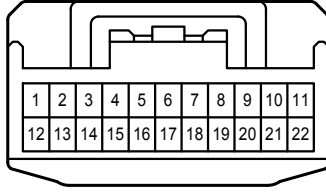

I 1

Black

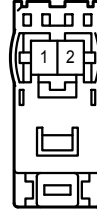

I 2

Orange

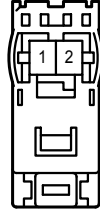

I 3

Orange

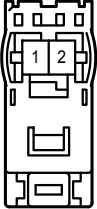

J 11

Yellow

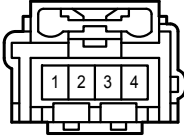

J 17

White

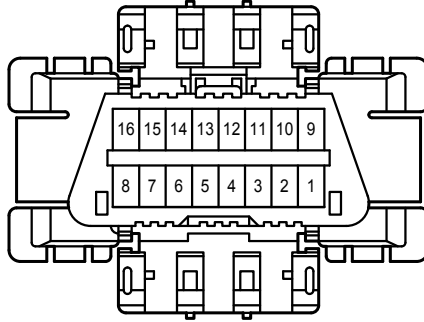

J 28

White

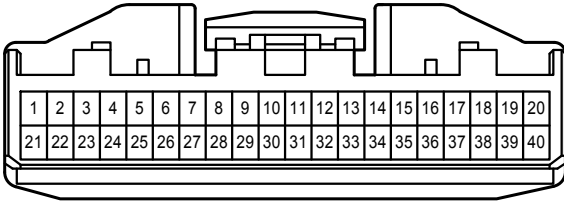

J 33

Black



J 37

White

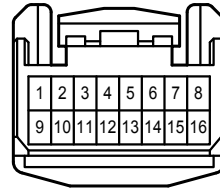

J 38

Black

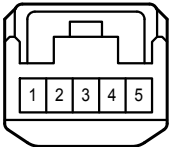

J 46

Yellow

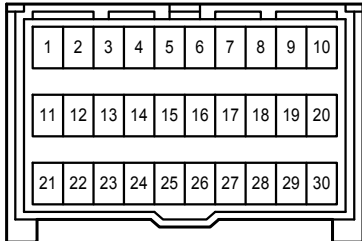

J 71

Black

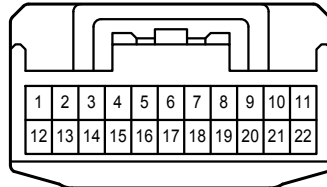

J 72

Black

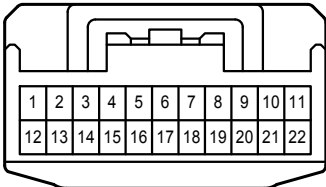

J 73

Black

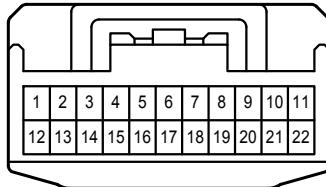

J 74

Black

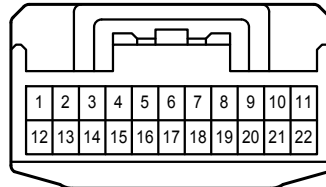

J 75
White

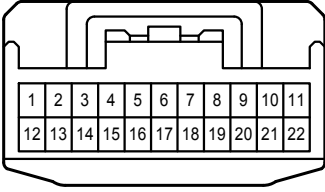

J 76
White

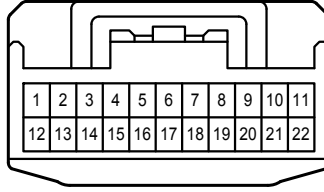

J 77
Gray

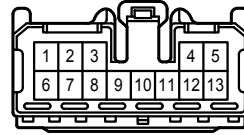

J 78
White

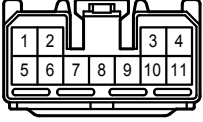

J 83
White

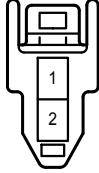

J 84
White

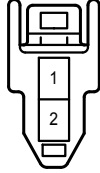

J109
Yellow

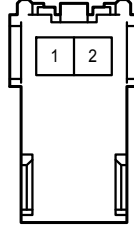

J110
Yellow

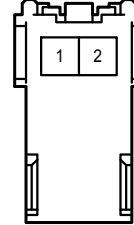

J117
Black

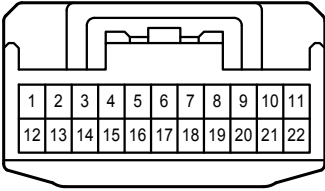

J118
Gray

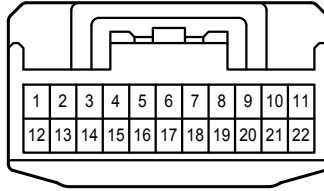

M 9
Yellow

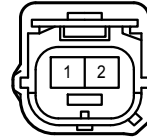

N 11
Yellow



P 1
Yellow

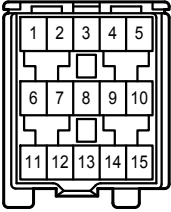

P 2
Yellow

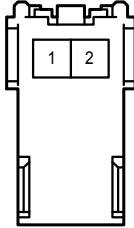

P 3
Black

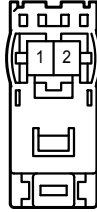

P 4
Yellow

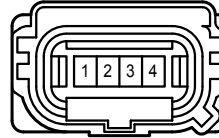

P 7
White



P 12
Yellow



Q 1
Yellow

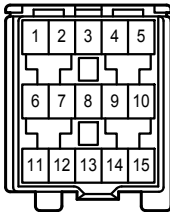

Q 2
Yellow

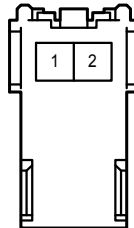

Q 3
Black

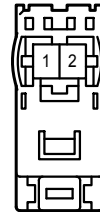

Q 4
Yellow

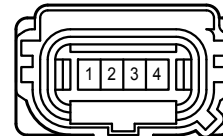

Q 9
Yellow



Q 11
Black

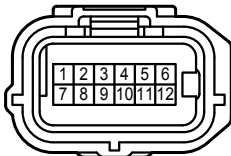

Q 12
Gray

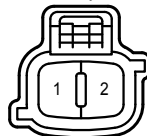

Y 1
Gray

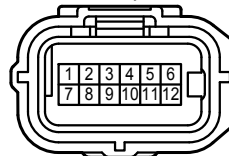

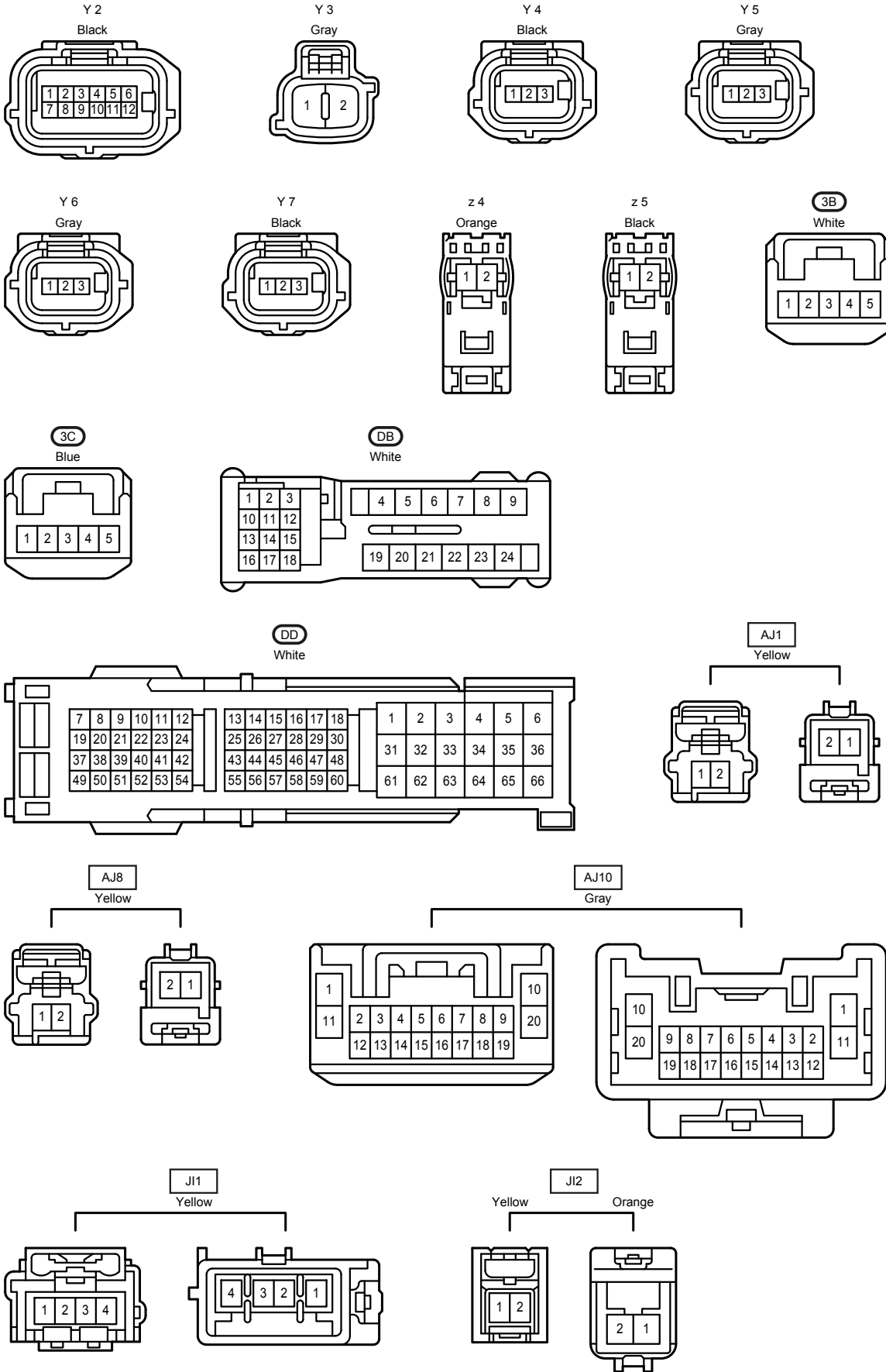

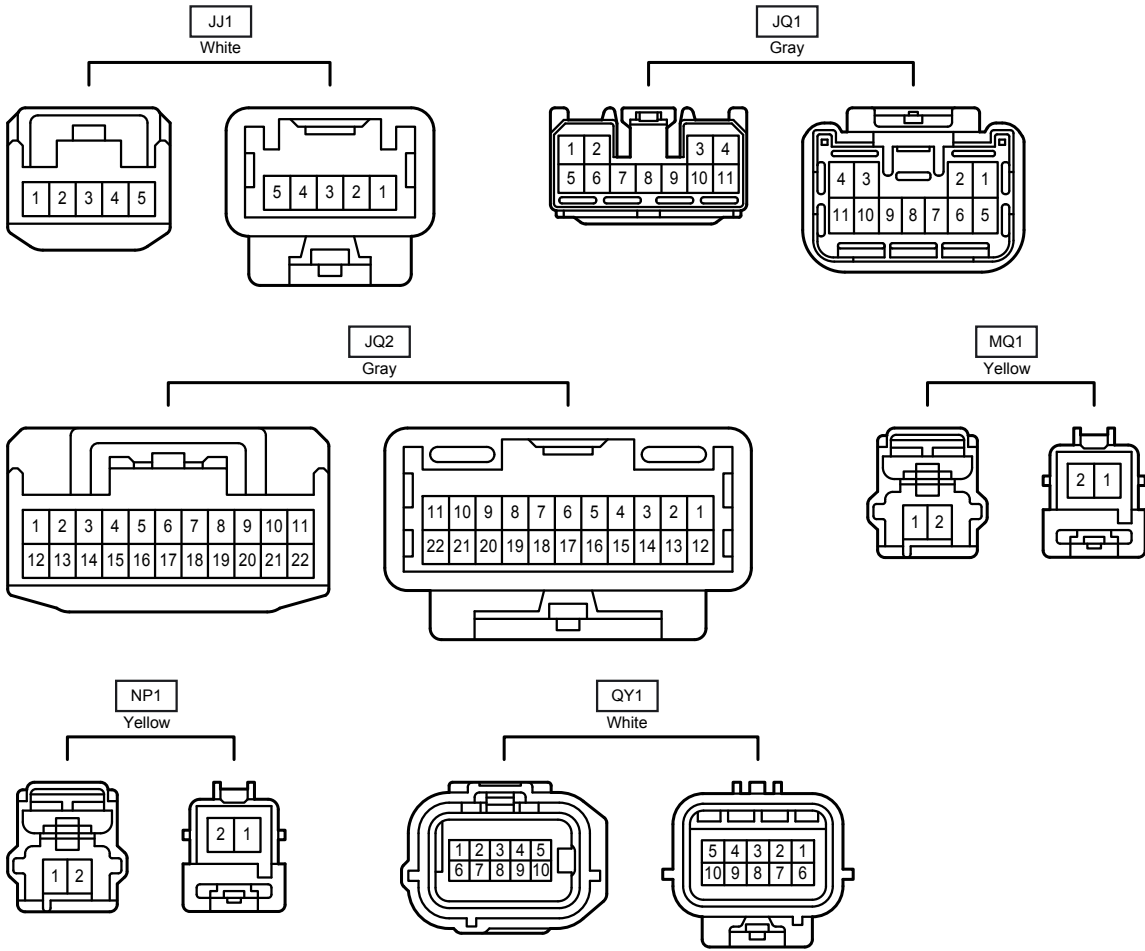

Starting

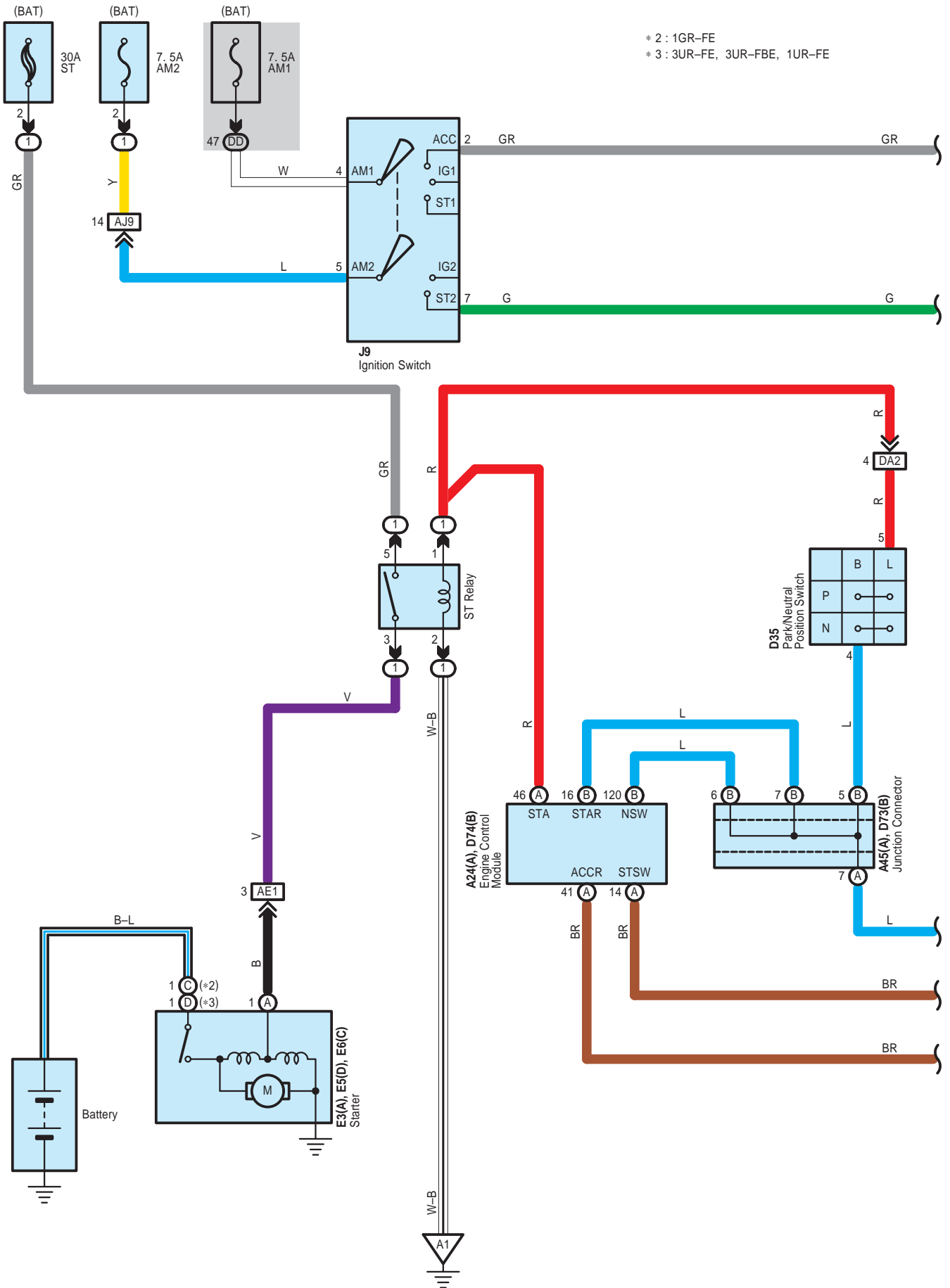

* 2 : 1GR-FE
 * 3 : 3UR-FE, 3UR-FBE, 1UR-FE

Starting

A 24
Black

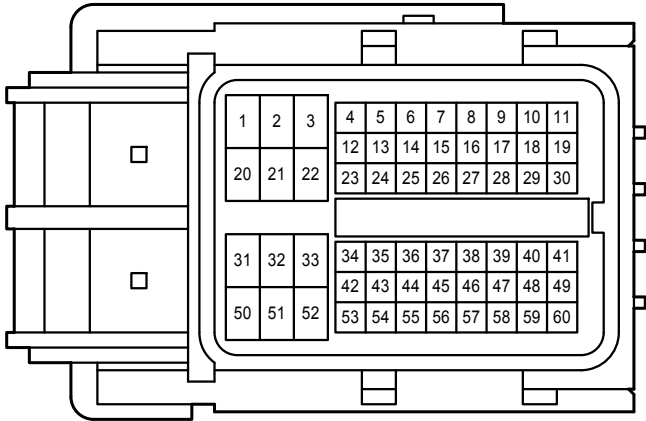

A 35
Black



A 40
White

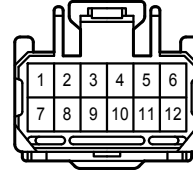

A 41
White

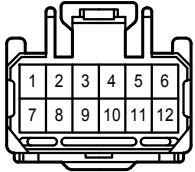

A 45
Blue

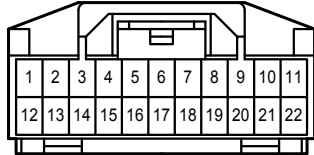

D 35
Gray

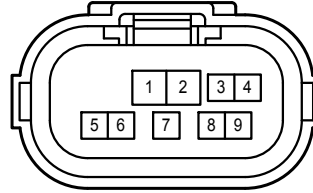

D 73
Blue

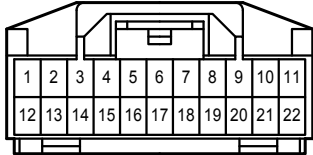

D 74
Black

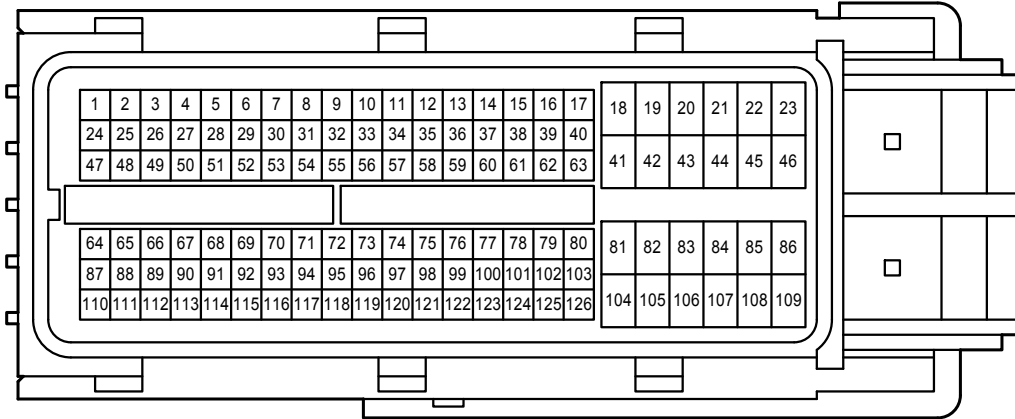

E 3
Black



E 5

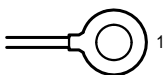

E 6

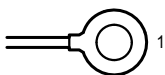

J 9
White

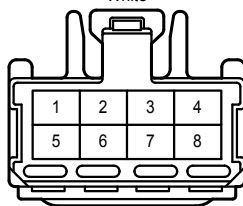

J 53
Gray

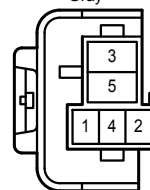

Starting

J 73
Black

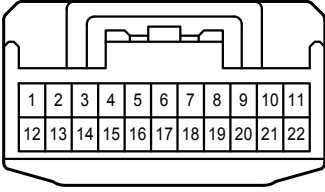

J 74
Black

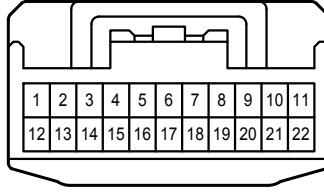

J 78
White

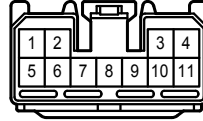

DB
White

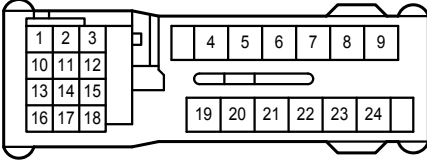

DD
White

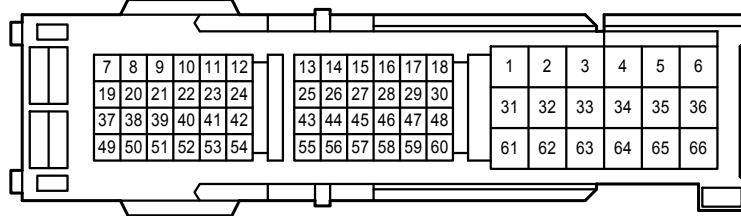

AE1
Gray

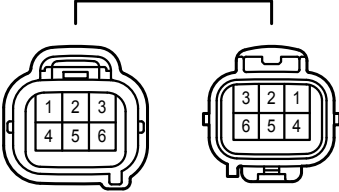

AJ9
Gray

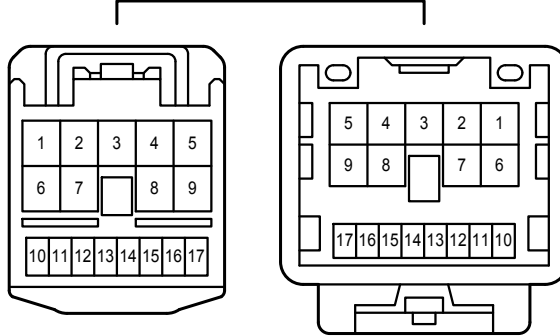

DA2
White

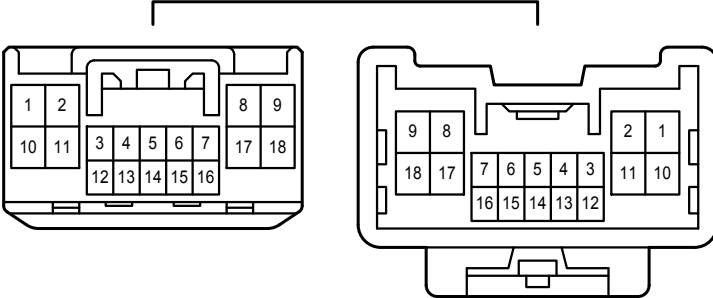

Stop Light

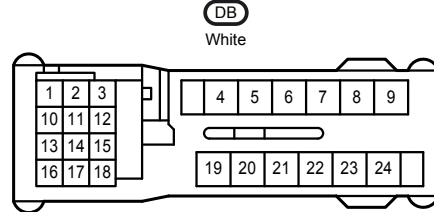
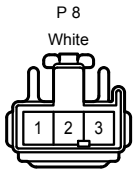
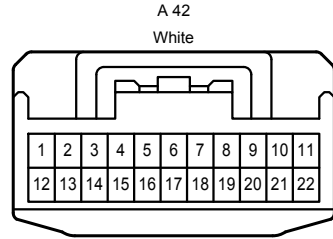
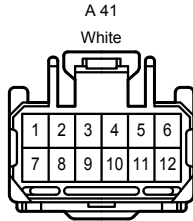
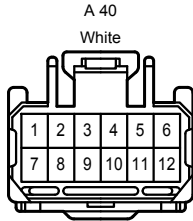
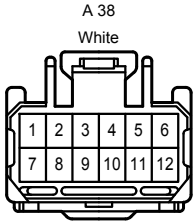
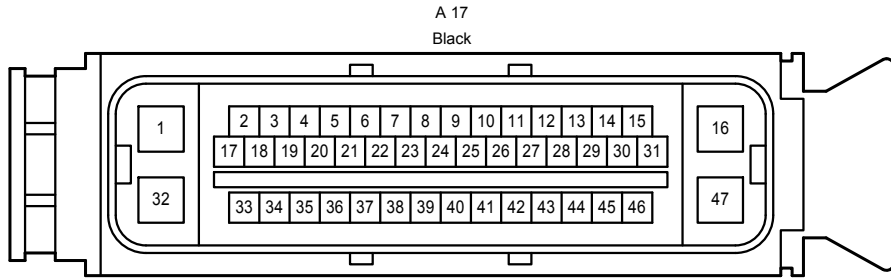
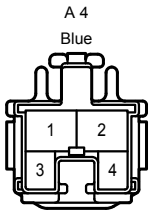

AP2
White

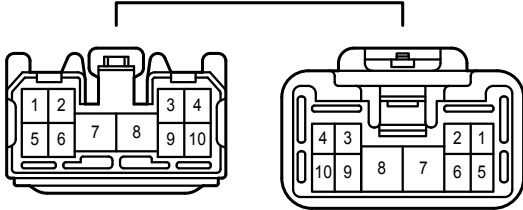

RA1
White

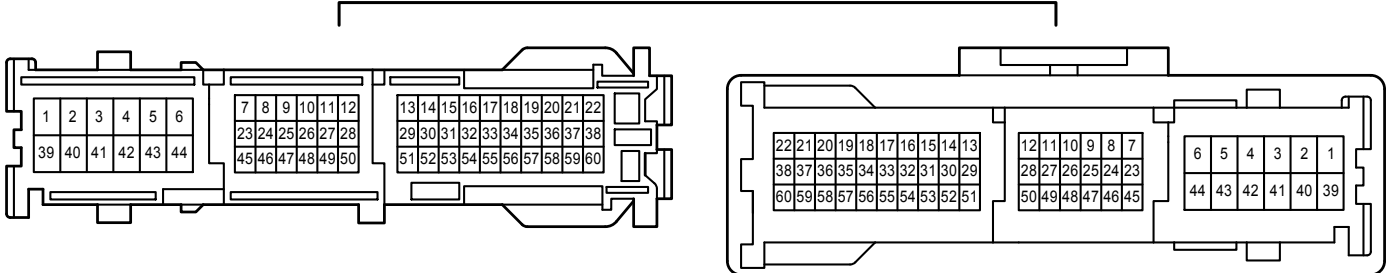

Taillight

J2(B), J4(D)
Main Body ECU

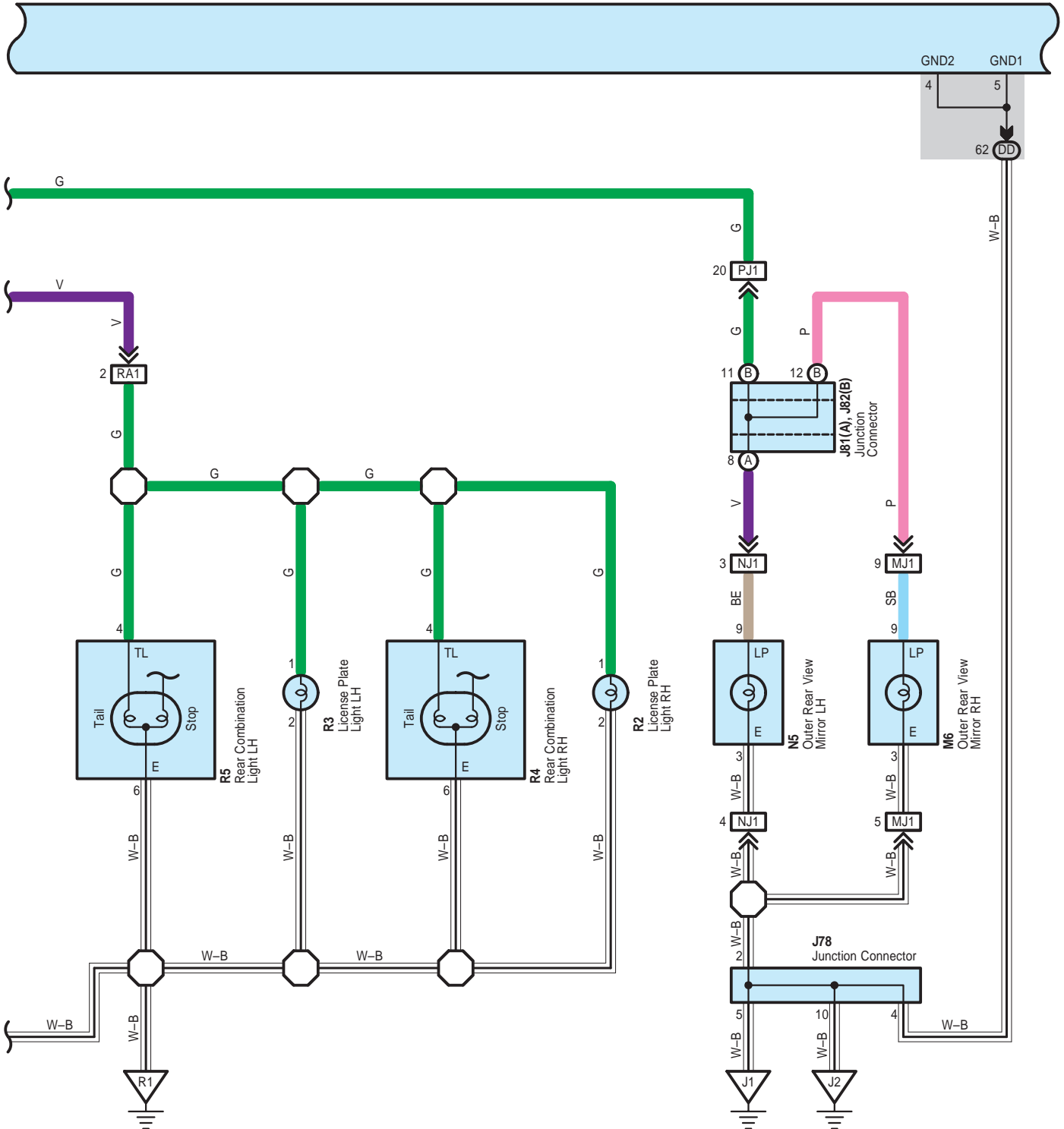

Taillight

- * 1 : w/ Seat Position Memory
- * 4 : Before Nov. 2009 Production
- * 5 : From Nov. 2009 Production

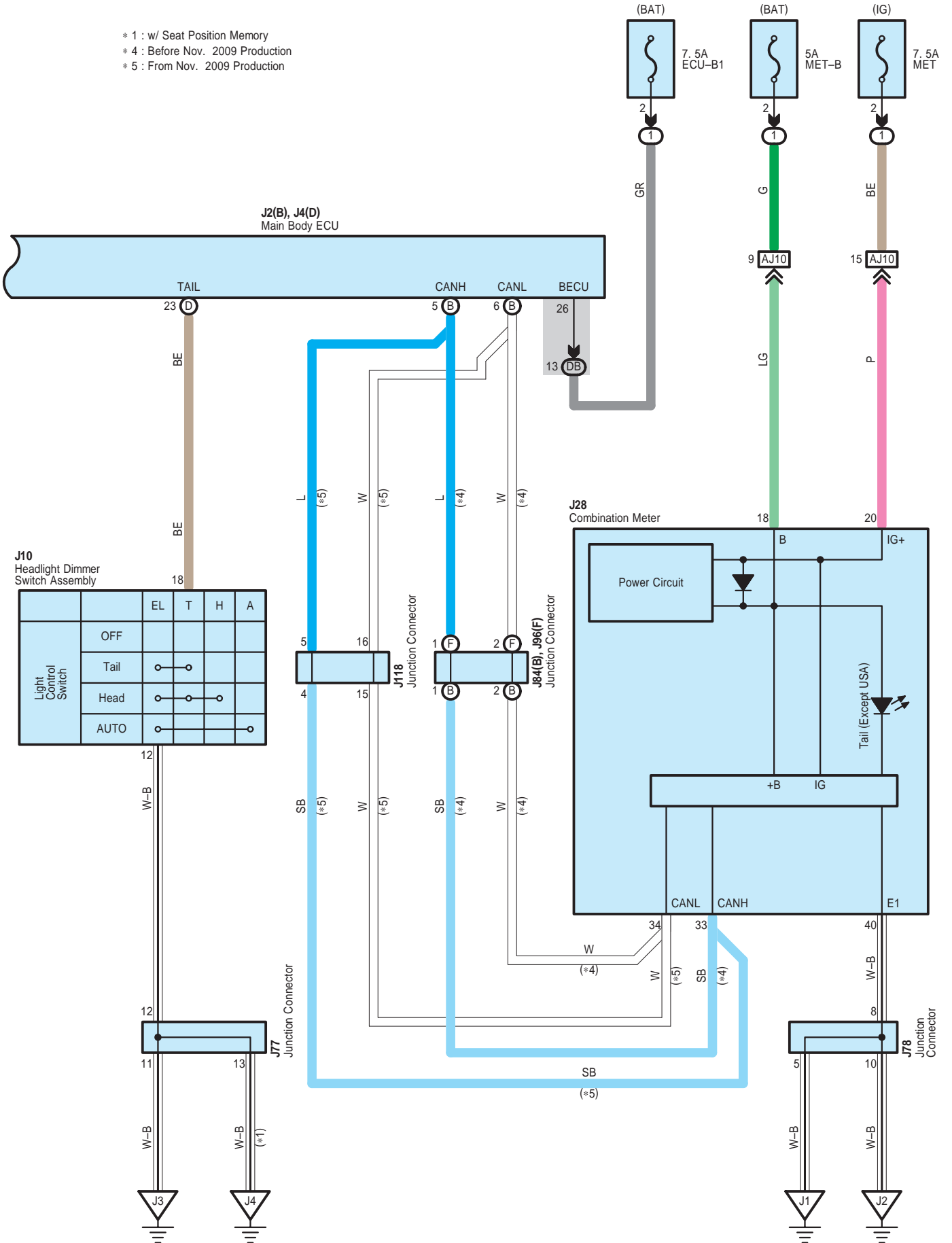

Taillight

A 12

Gray



A 13

Gray



A 32

Gray

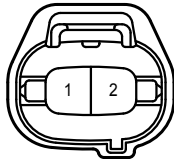

A 33

Gray

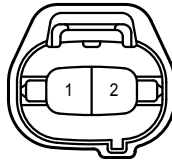

A 39

White

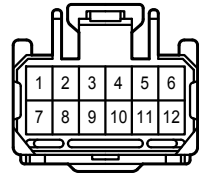

J 2

White

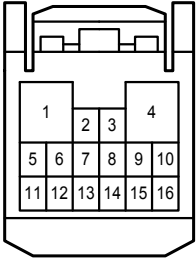

J 4

White

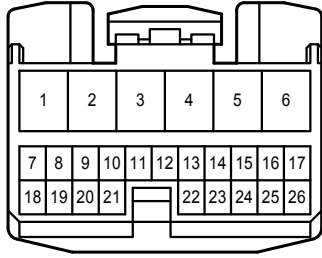

J 10

White

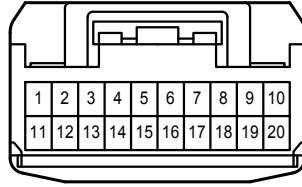

J 28

White

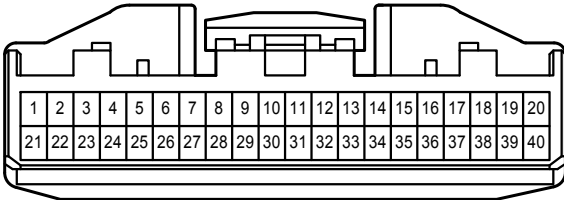

J 77

Gray

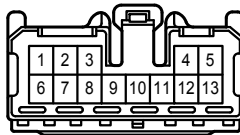

J 78

White

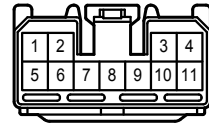

J 81

White

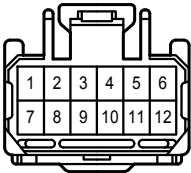

J 82

White

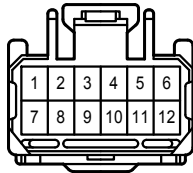

J 84

White

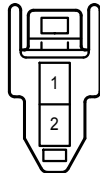

J 96

White

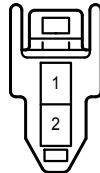

J118

Gray

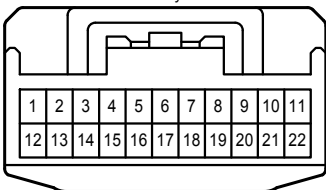

M 6

White

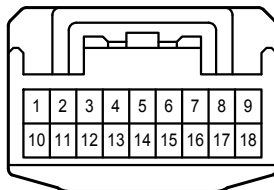

N 5

White

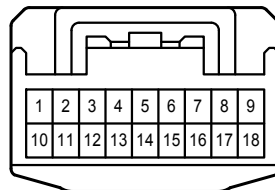

R 2

White



R 3

White



R 4

Gray



R 5

Gray



1F

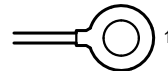

Taillight

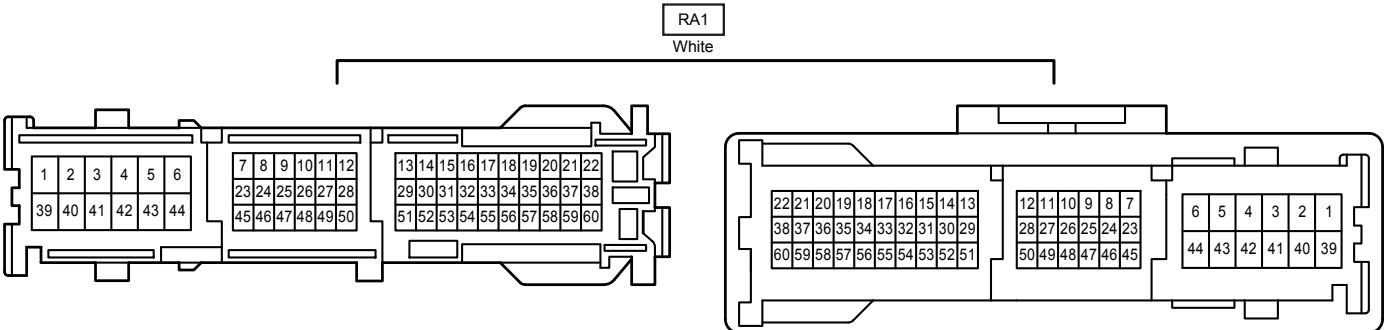
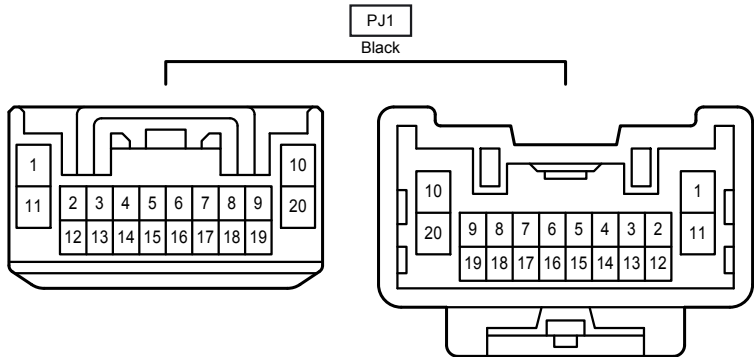
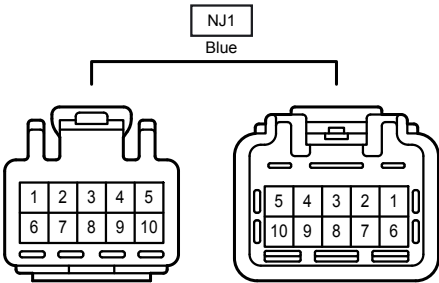
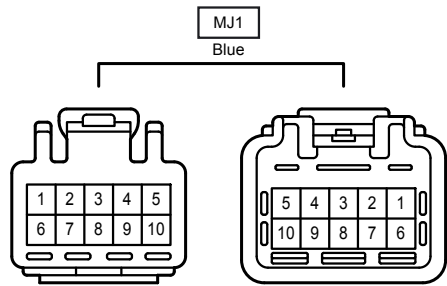
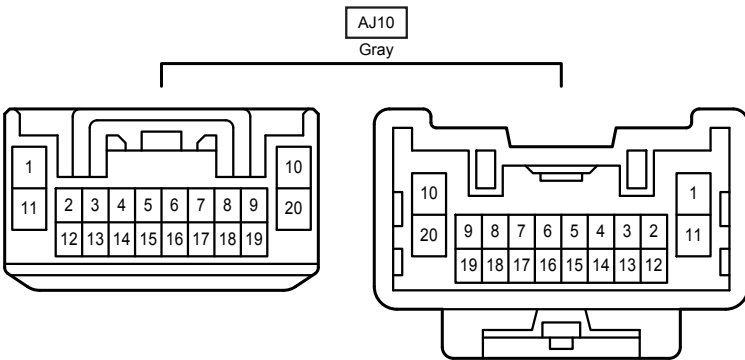
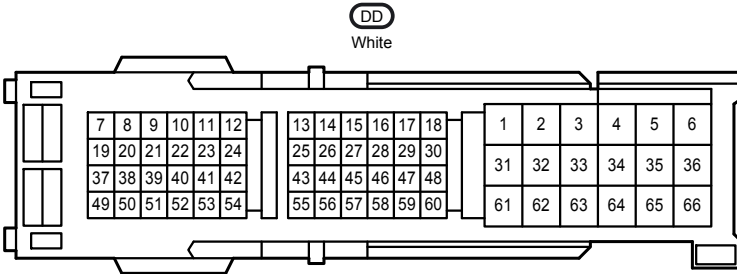
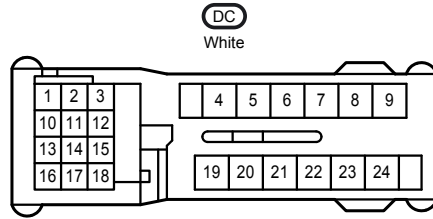
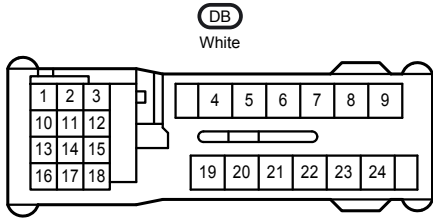
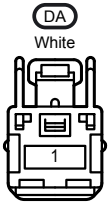

RA2
White

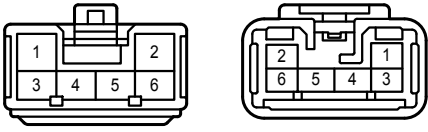

Theft Deterrent

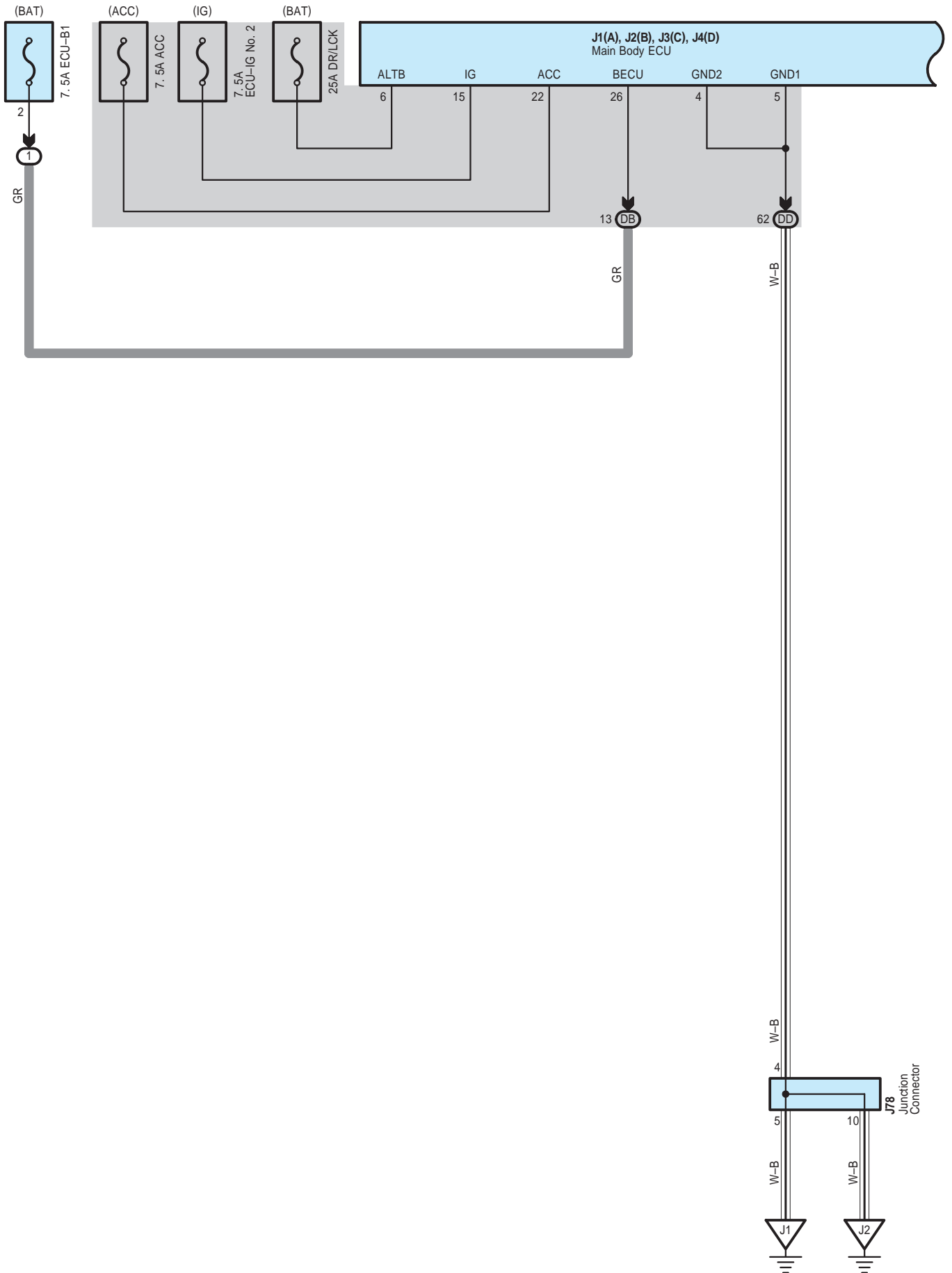

Theft Deterrent

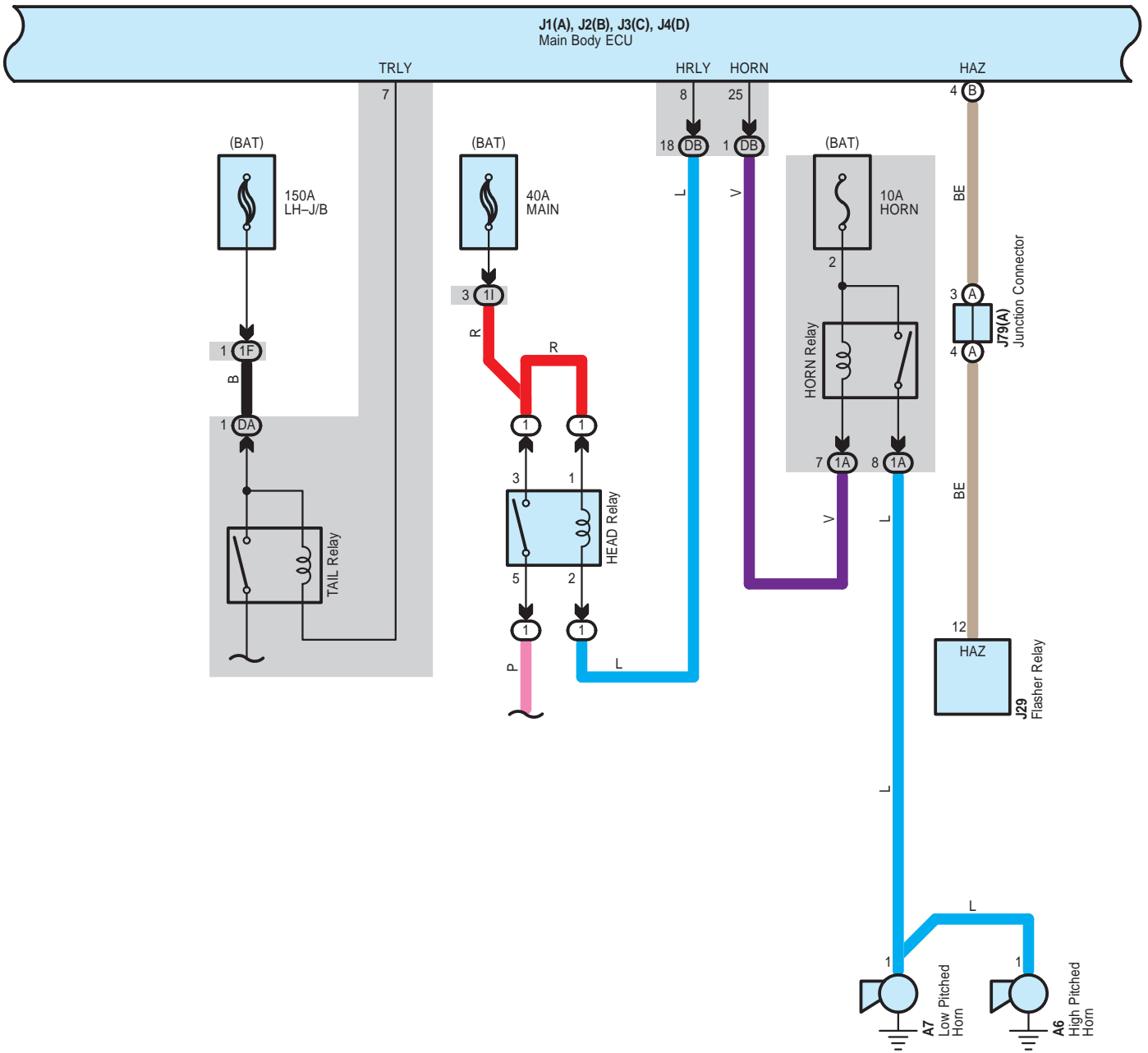

Theft Deterrent

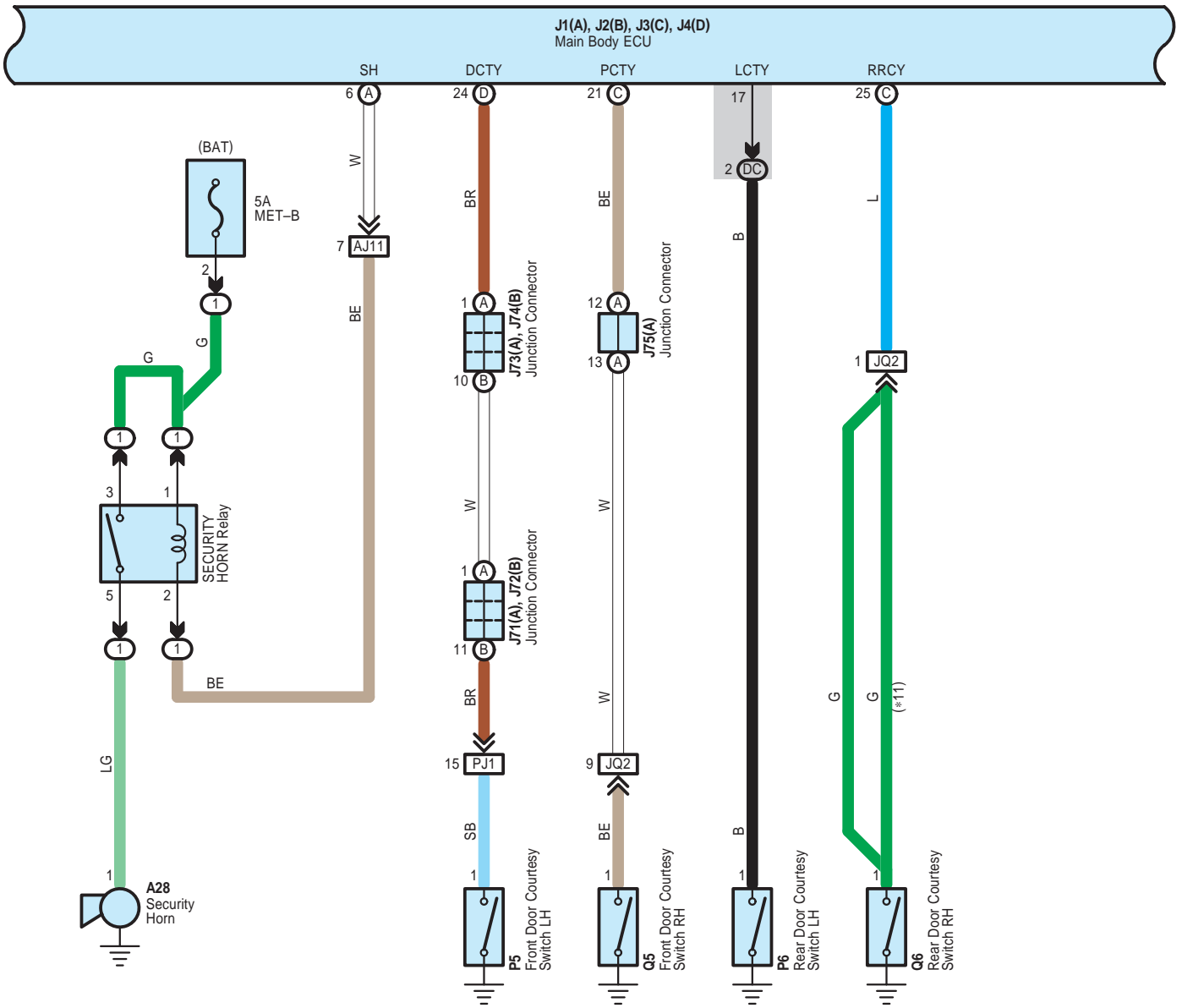

Theft Deterrent

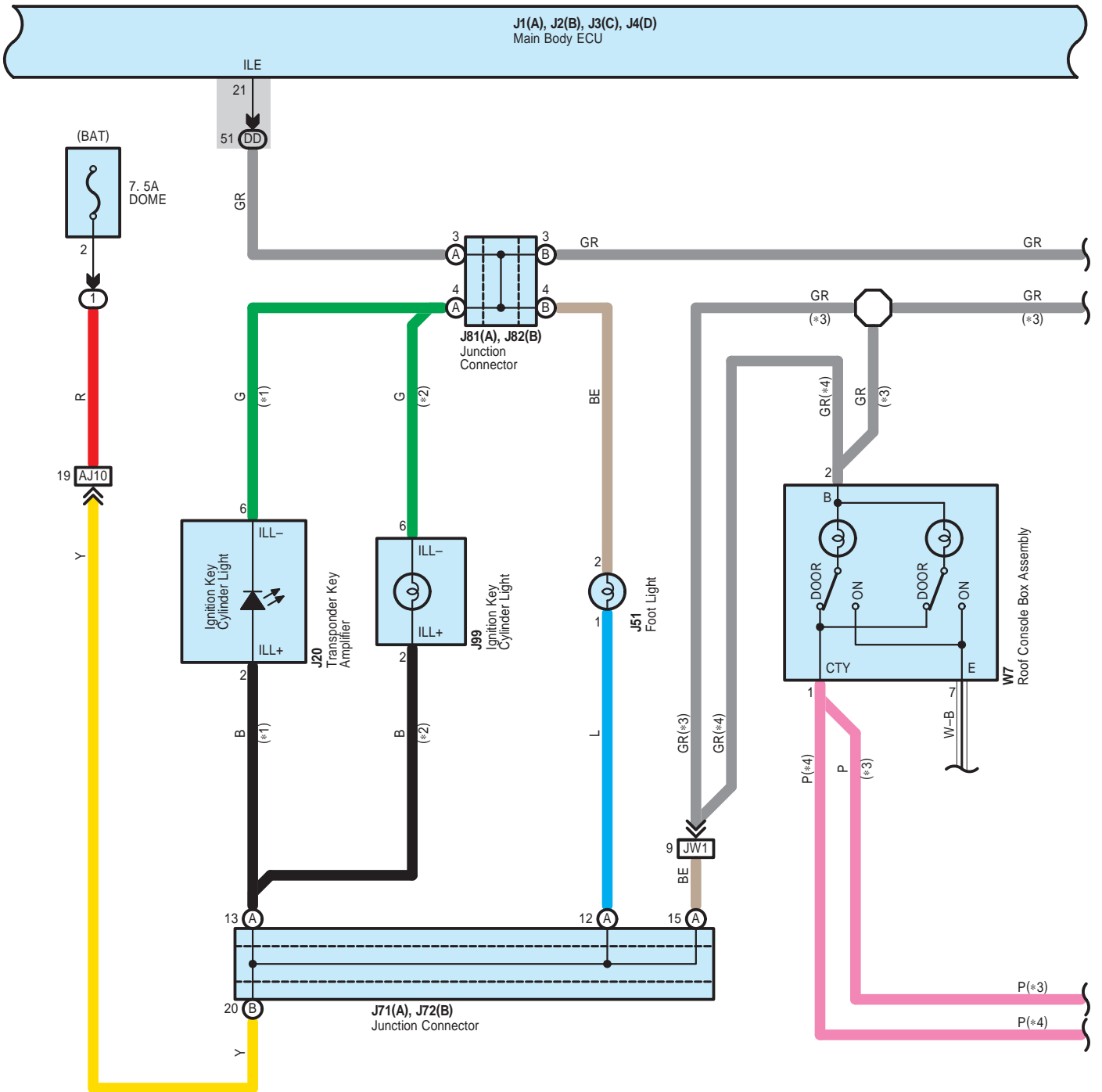

- * 1 : w/ Engine Immobiliser System
- * 2 : w/o Engine Immobiliser System
- * 3 : Except Regular Cab
- * 4 : Regular Cab
- * 11 : w/ Rear Door Courtesy Light

Theft Deterrent

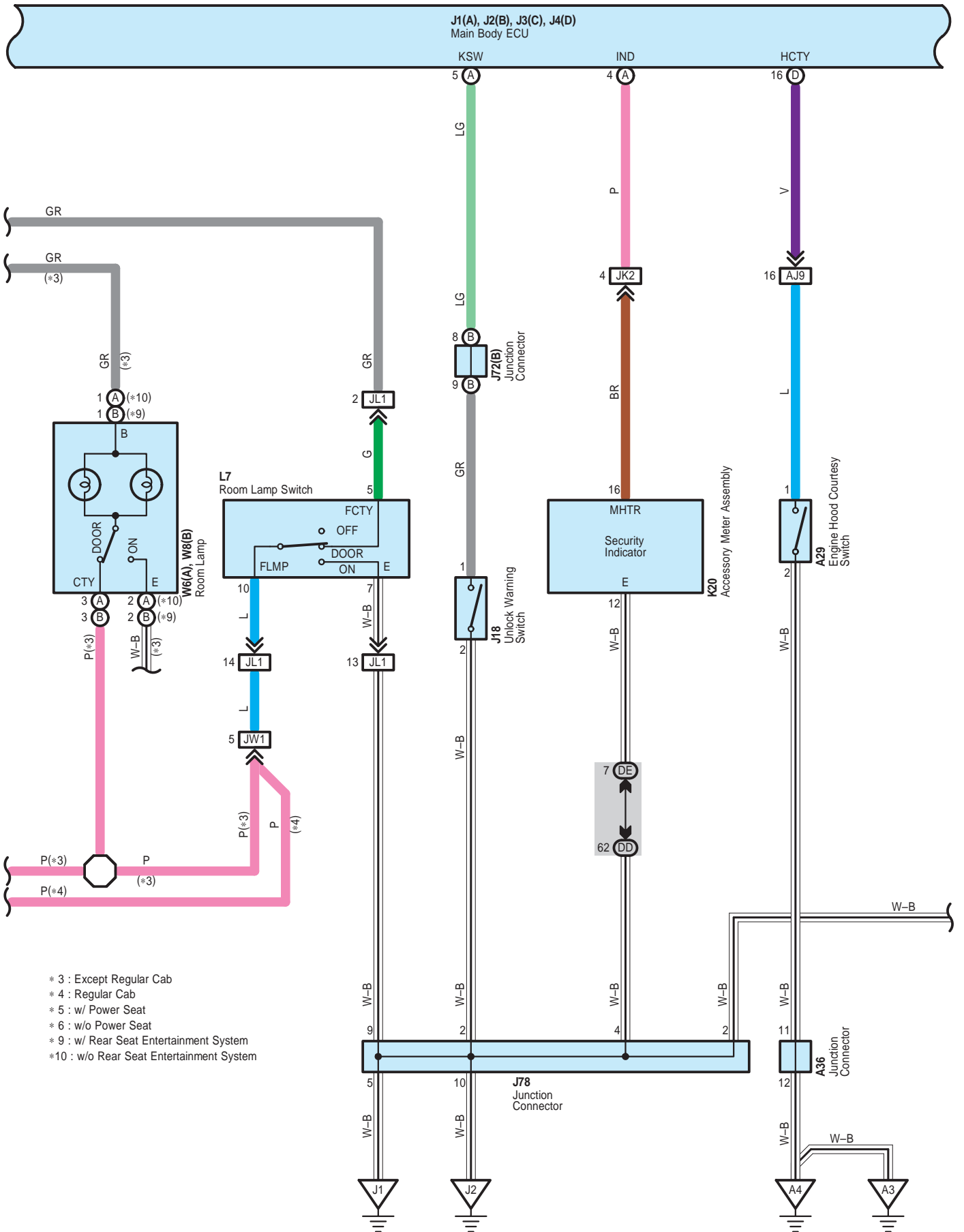

- * 3 : Except Regular Cab
- * 4 : Regular Cab
- * 5 : w/ Power Seat
- * 6 : w/o Power Seat
- * 9 : w/ Rear Seat Entertainment System
- * 10 : w/o Rear Seat Entertainment System

Theft Deterrent

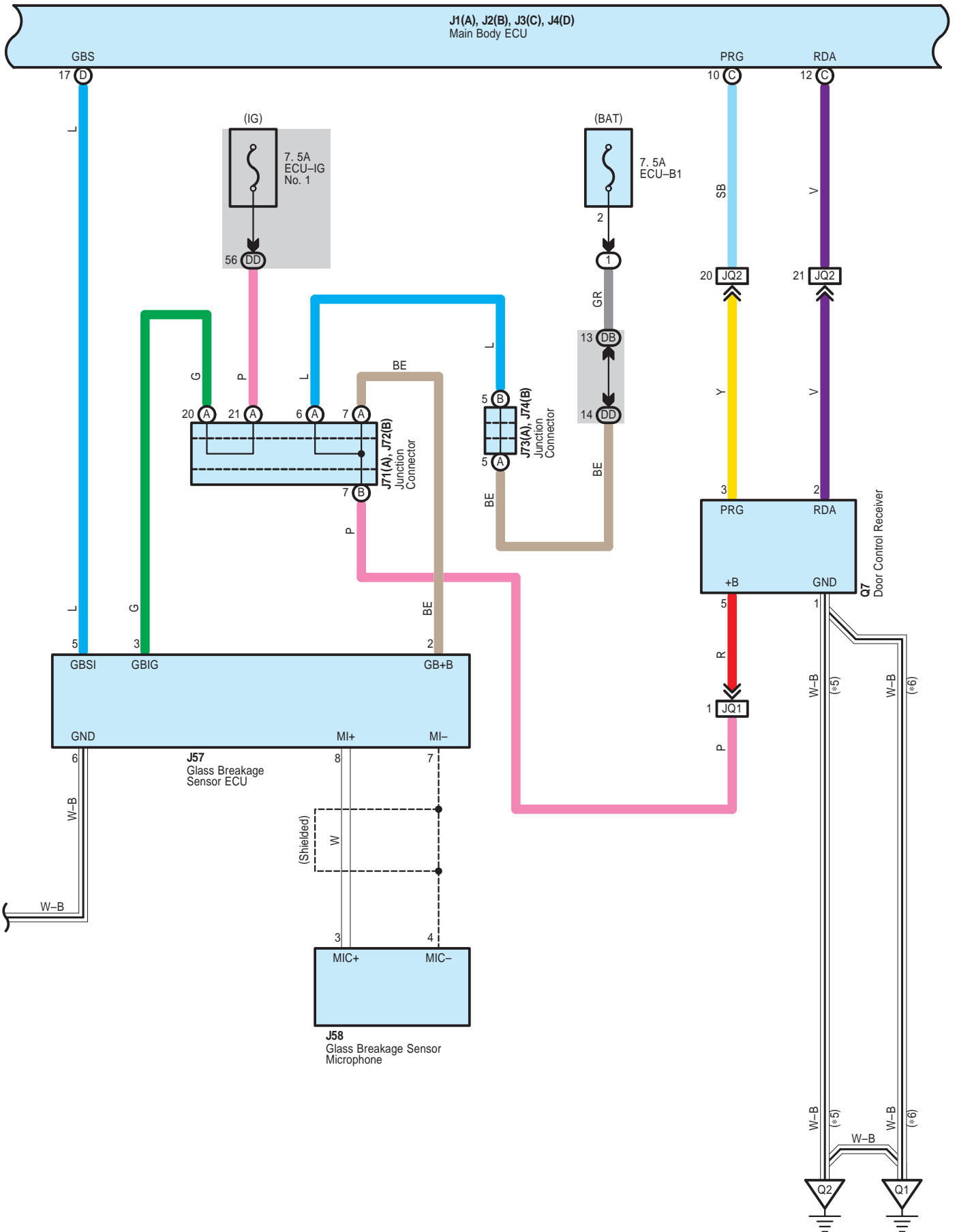

Theft Deterrent

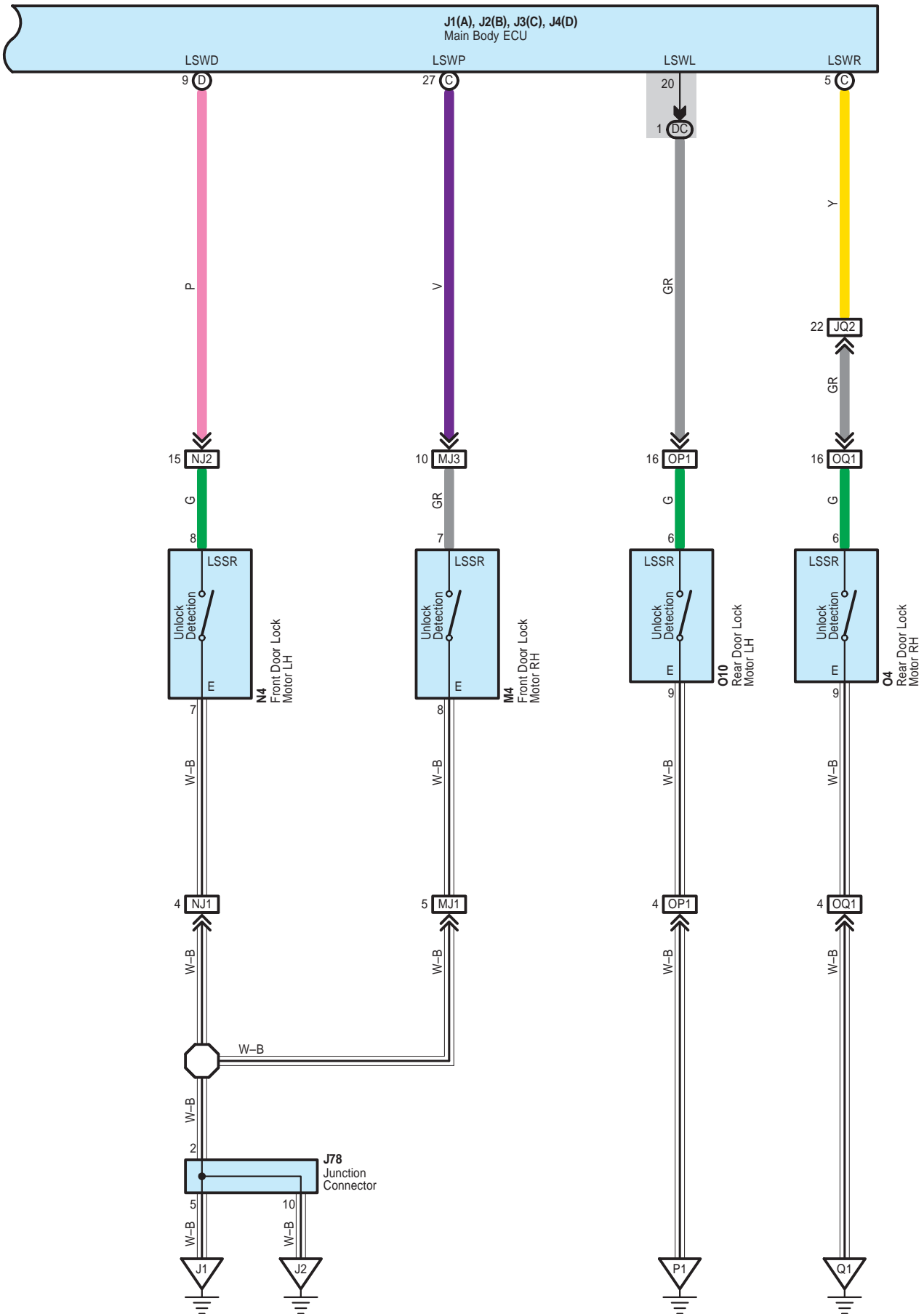

Theft Deterrent

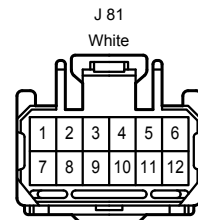
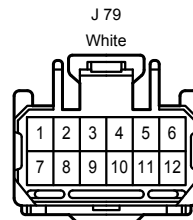
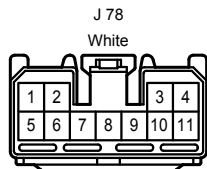
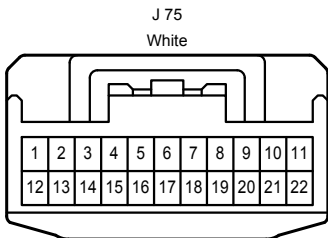
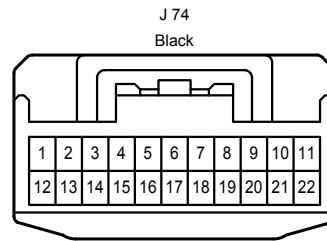
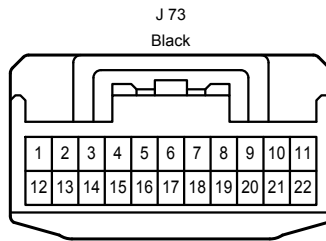
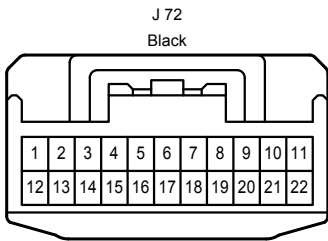
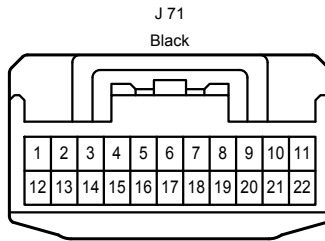
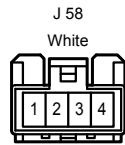
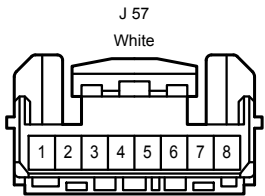
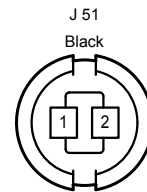
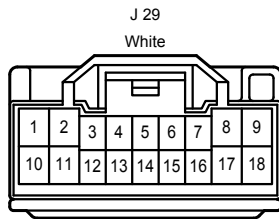
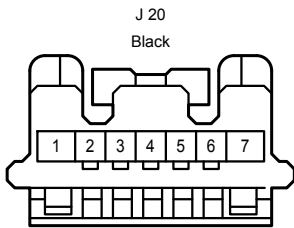
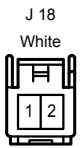
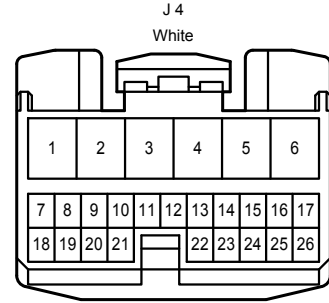
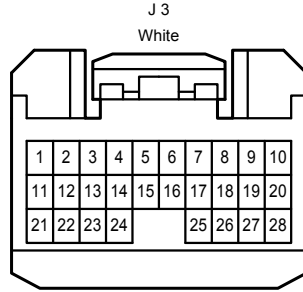
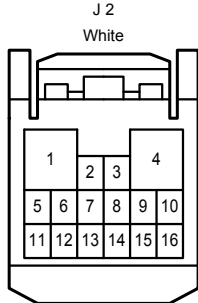
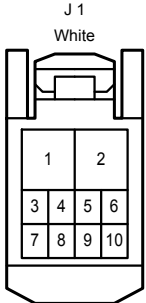
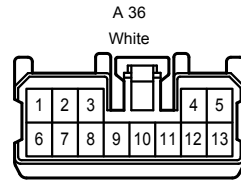
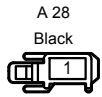
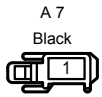
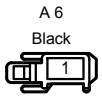

Theft Deterrent

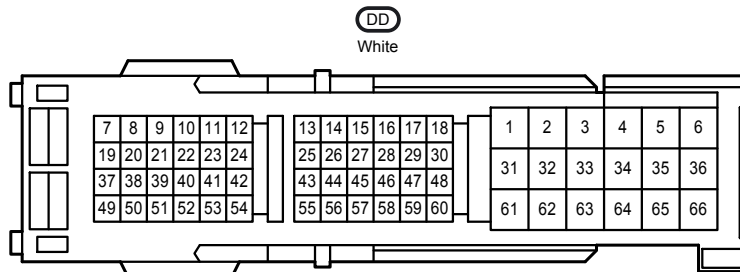
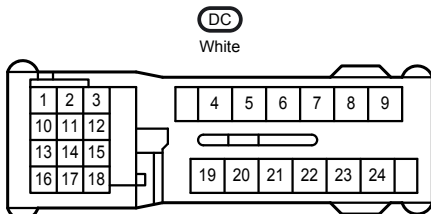
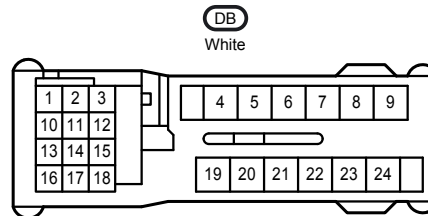
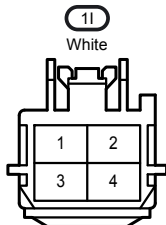
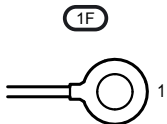
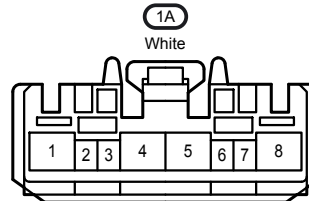
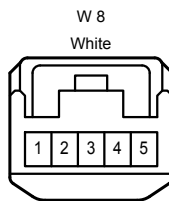
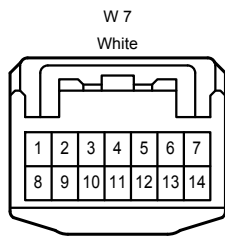
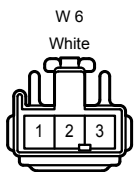
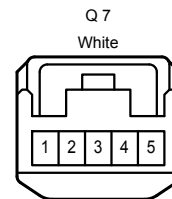
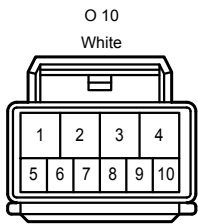
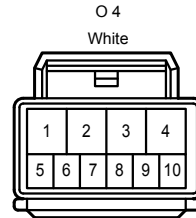
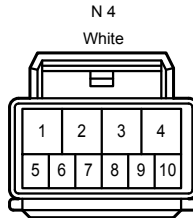
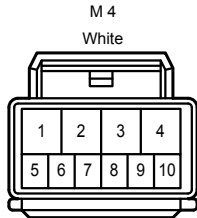
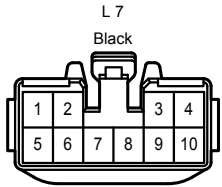
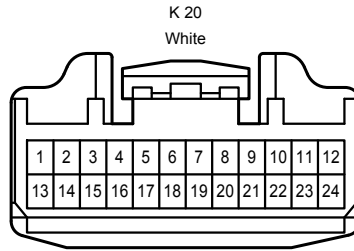
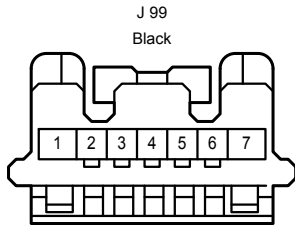
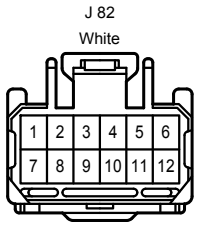

Theft Deterrent

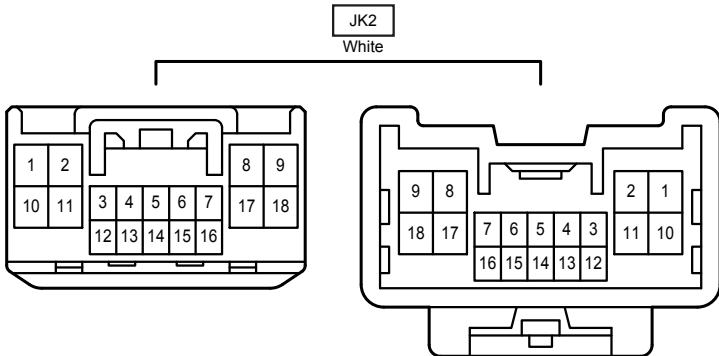
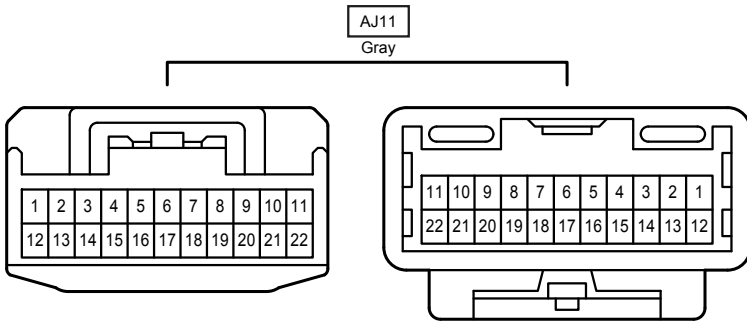
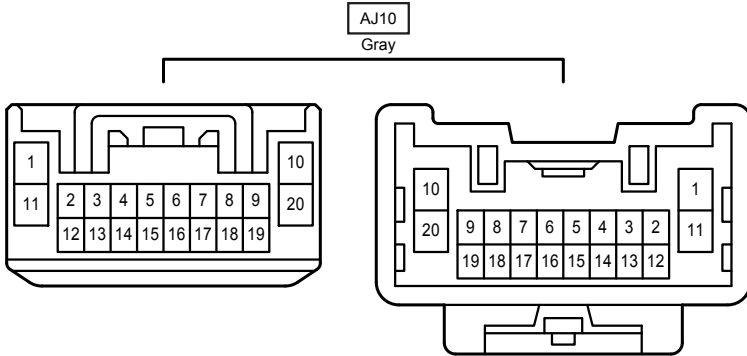
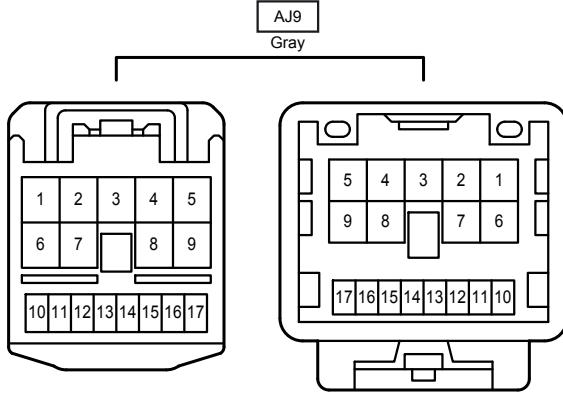
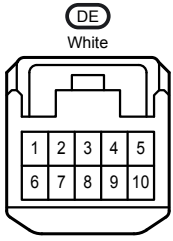

JL1
White

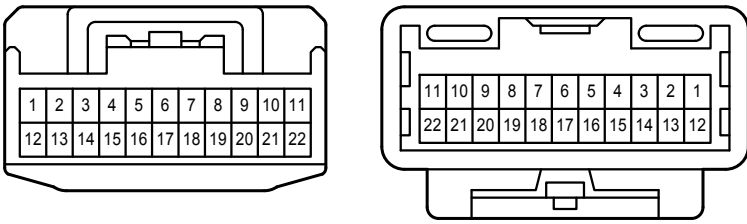

JQ1
Gray

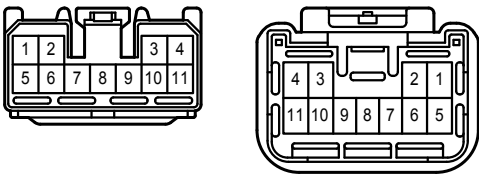

JQ2
Gray

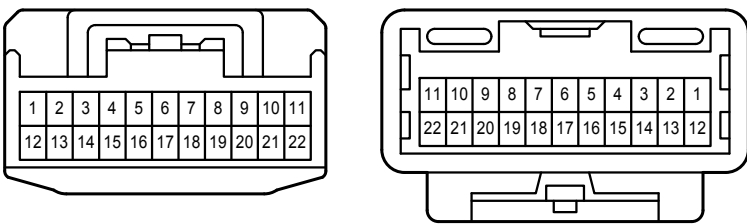

JW1
White

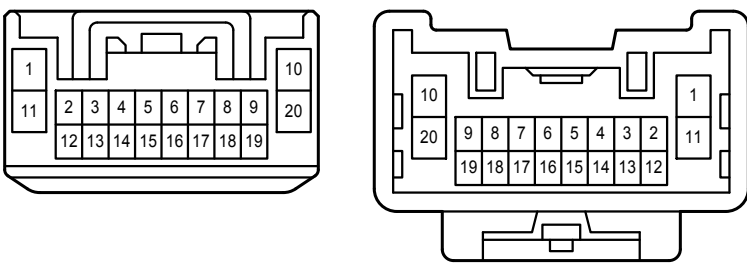

MJ1
Blue

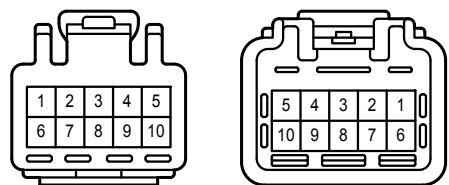

MJ3
Blue

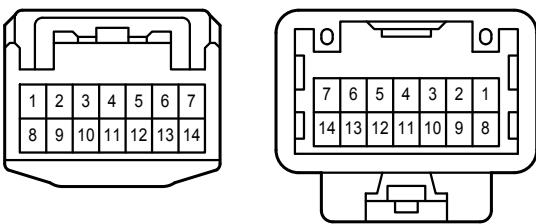

NJ1
Blue

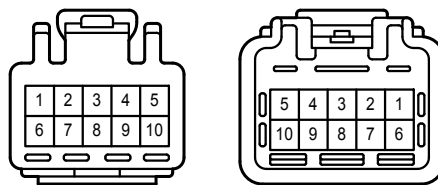

NJ2
Blue

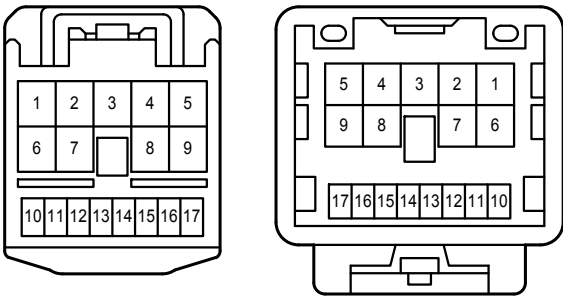

OP1
White

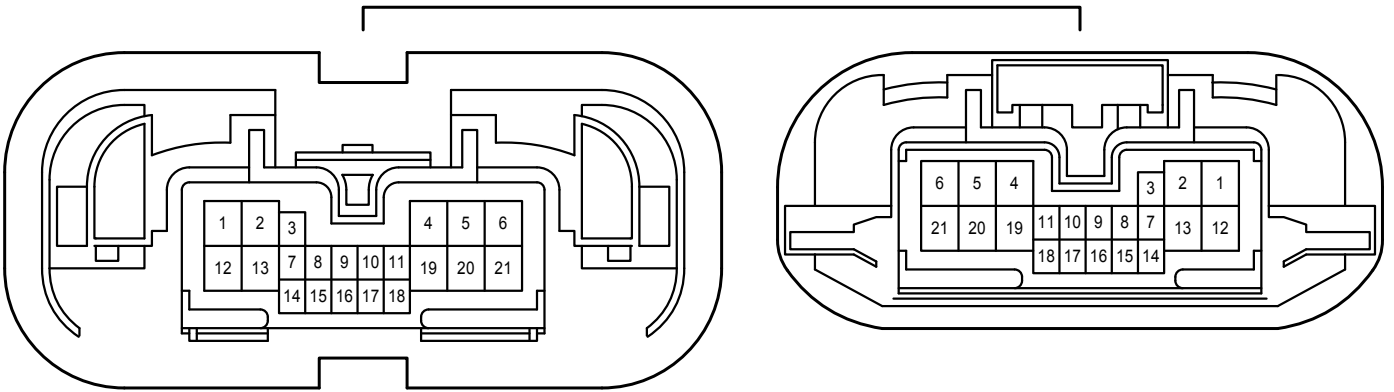

OQ1
White

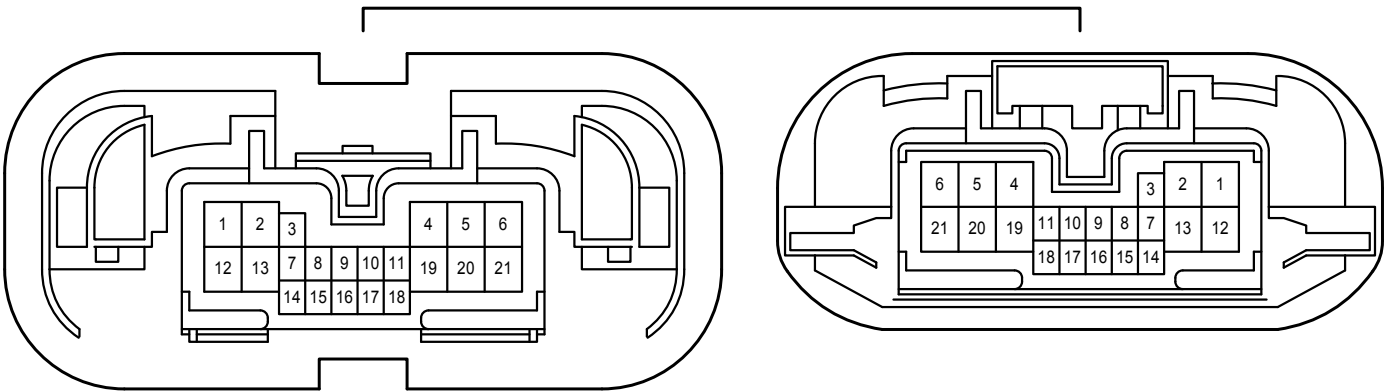

PJ1
Black

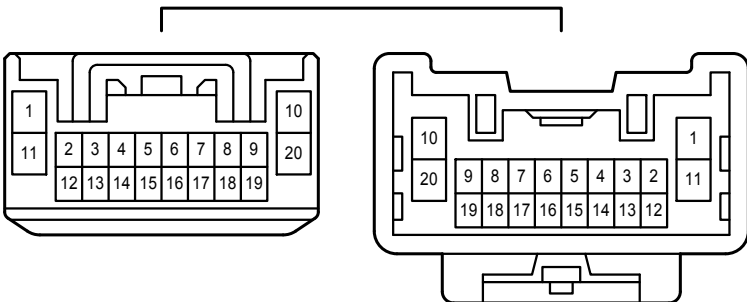

Tire Pressure Warning System

* 1 : Before Nov. 2009 Production
 * 2 : From Nov. 2009 Production

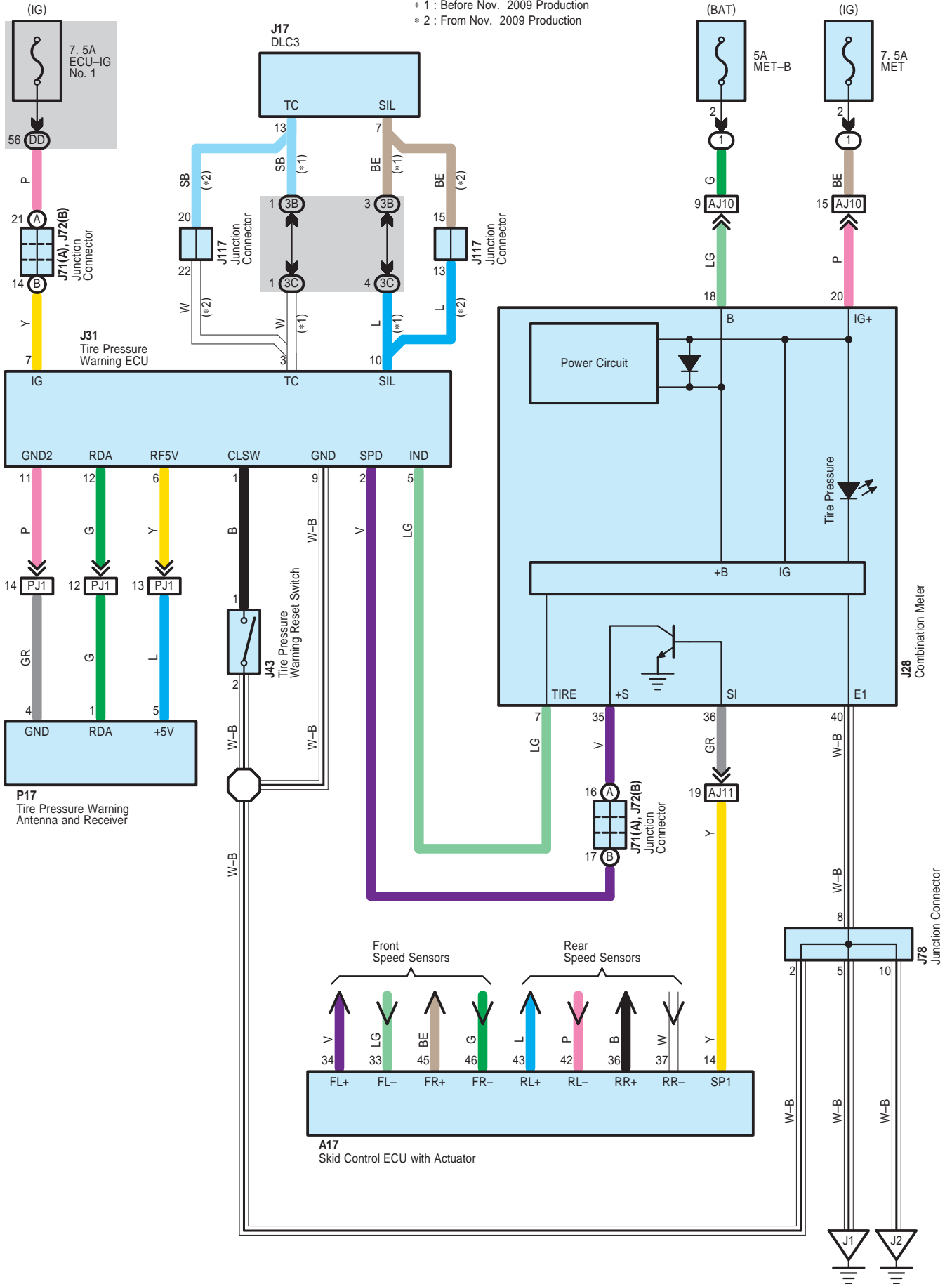

Tire Pressure Warning System

A 17
Black

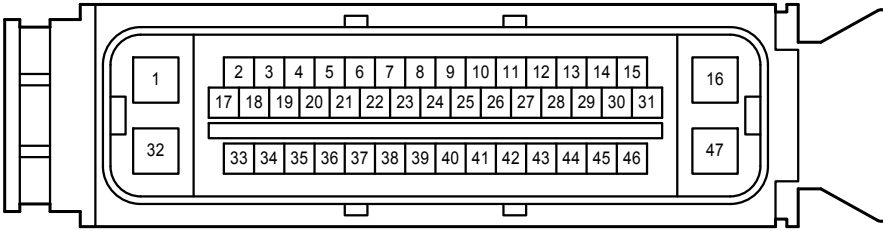

J 17
White

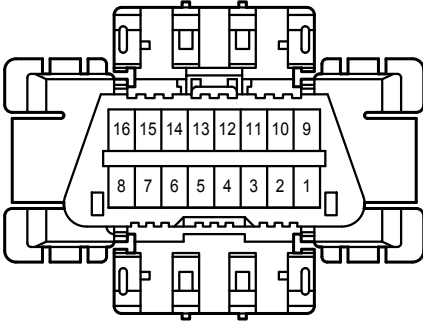

J 28
White

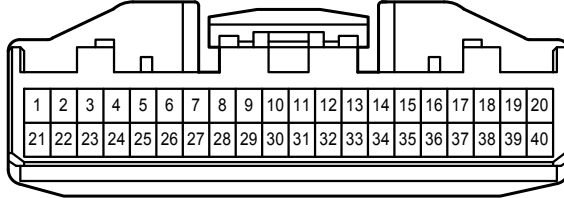

J 31
White



J 43
Black

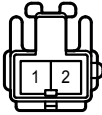

J 71
Black

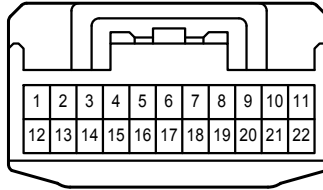

J 72
Black

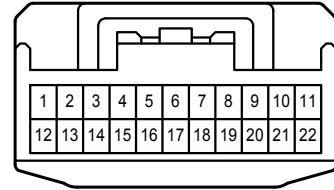

J 78
White

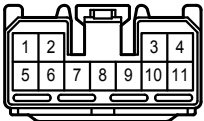

J117
Black

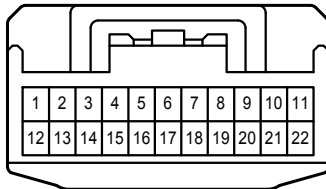

P 17
White

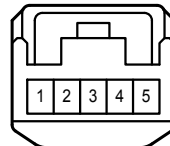

3B
White

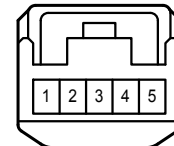

3C
Blue

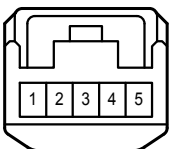

DD
White

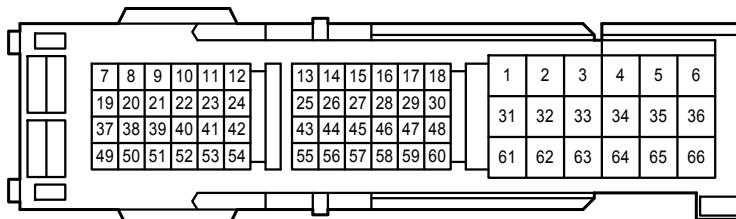

Tire Pressure Warning System

AJ10
Gray

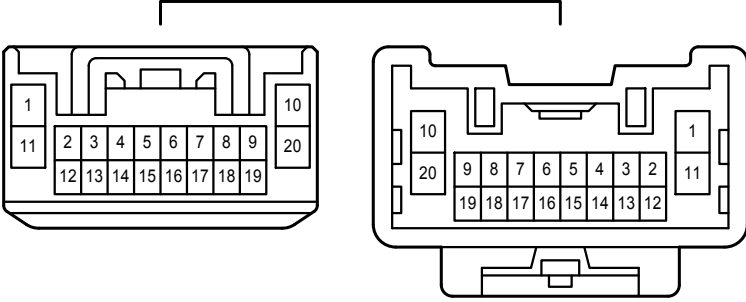

AJ11
Gray

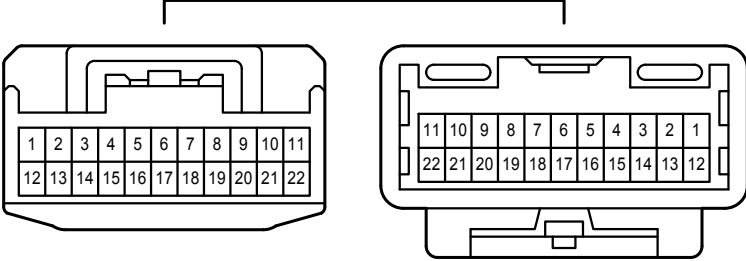

PJ1
Black

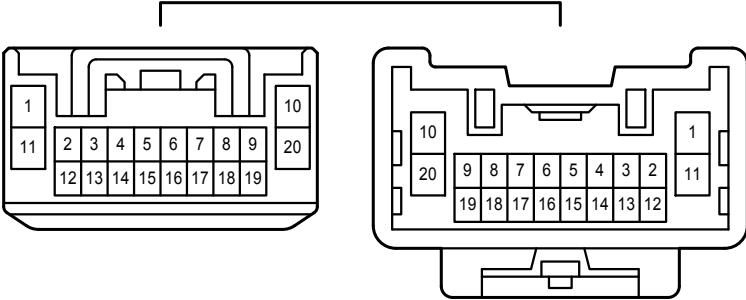

Trailer Towing

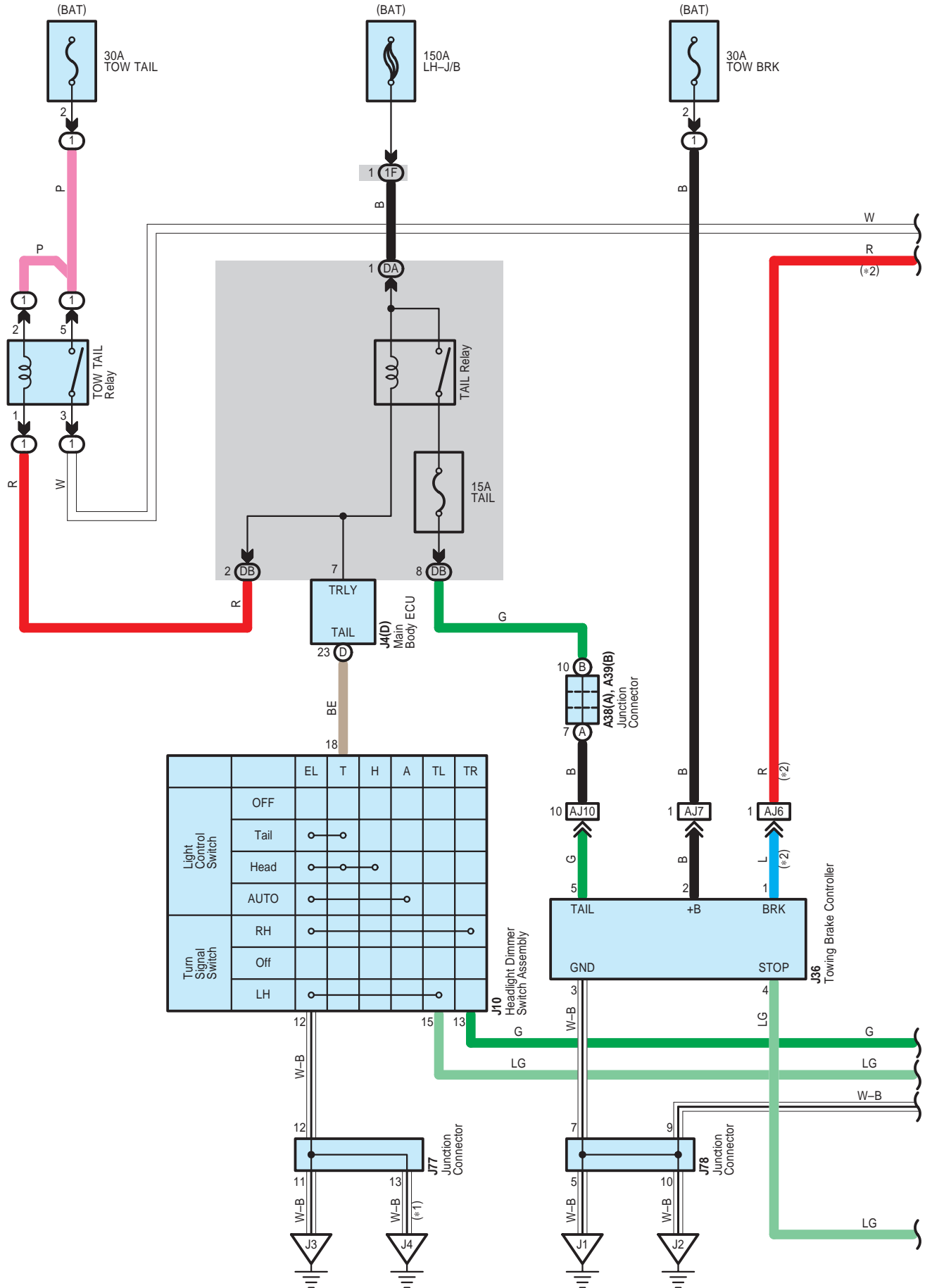

Trailer Towing

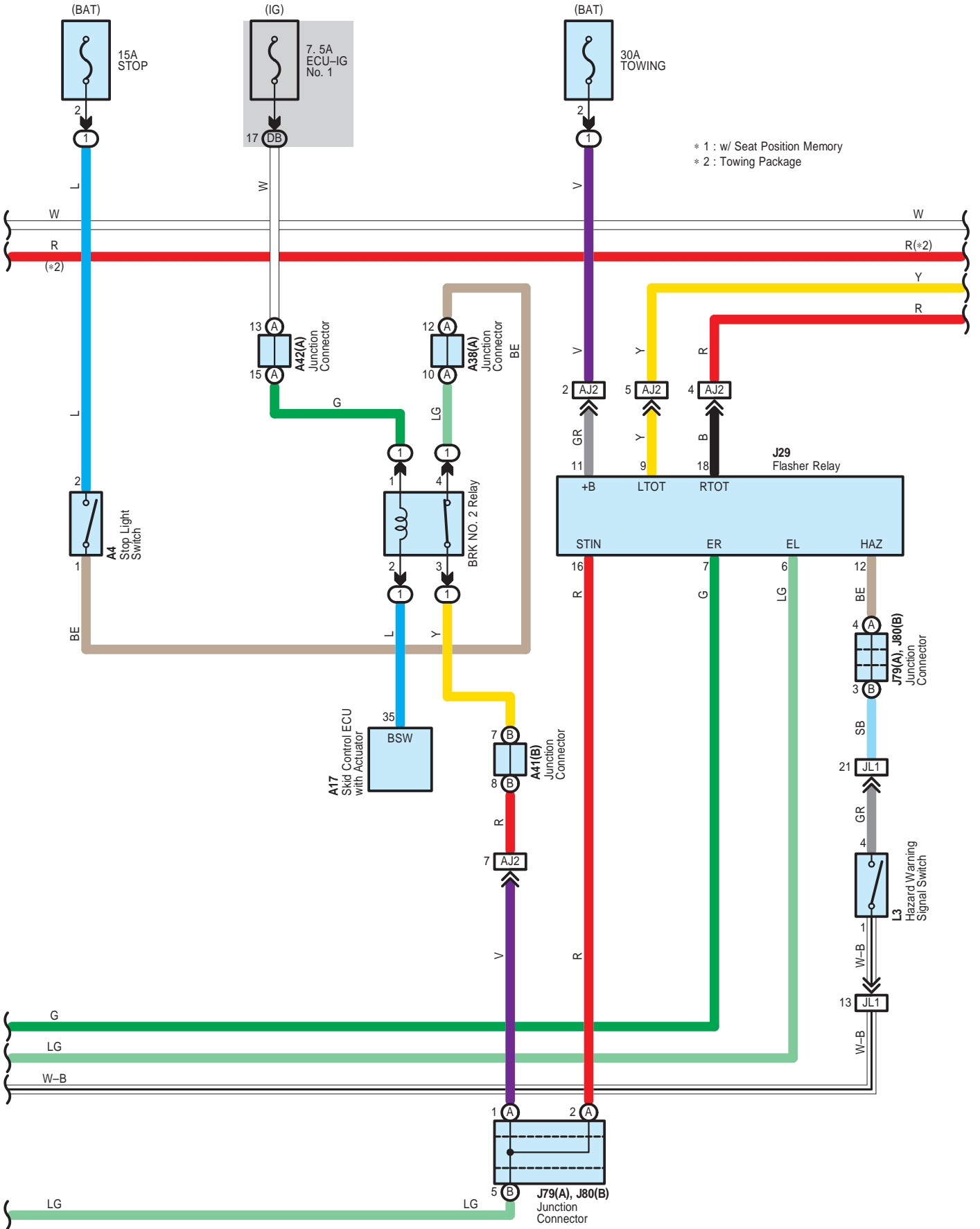

* 1 : w/ Seat Position Memory
* 2 : Towing Package

Trailer Towing

- * 2 : Towing Package
- * 3 : Except Towing Package
- * 4 : Column Shift
- * 5 : Floor Shift

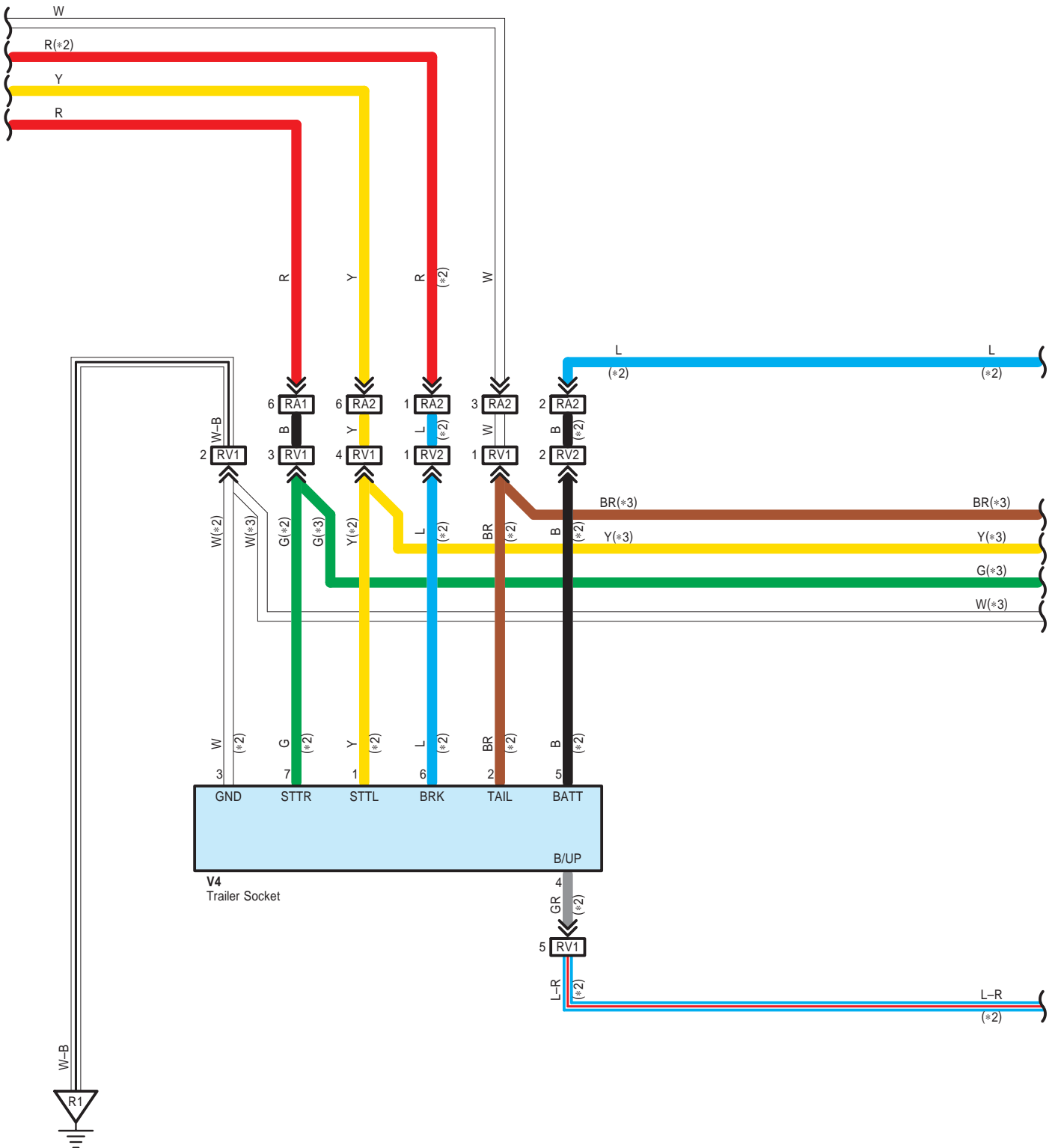

Trailer Towing

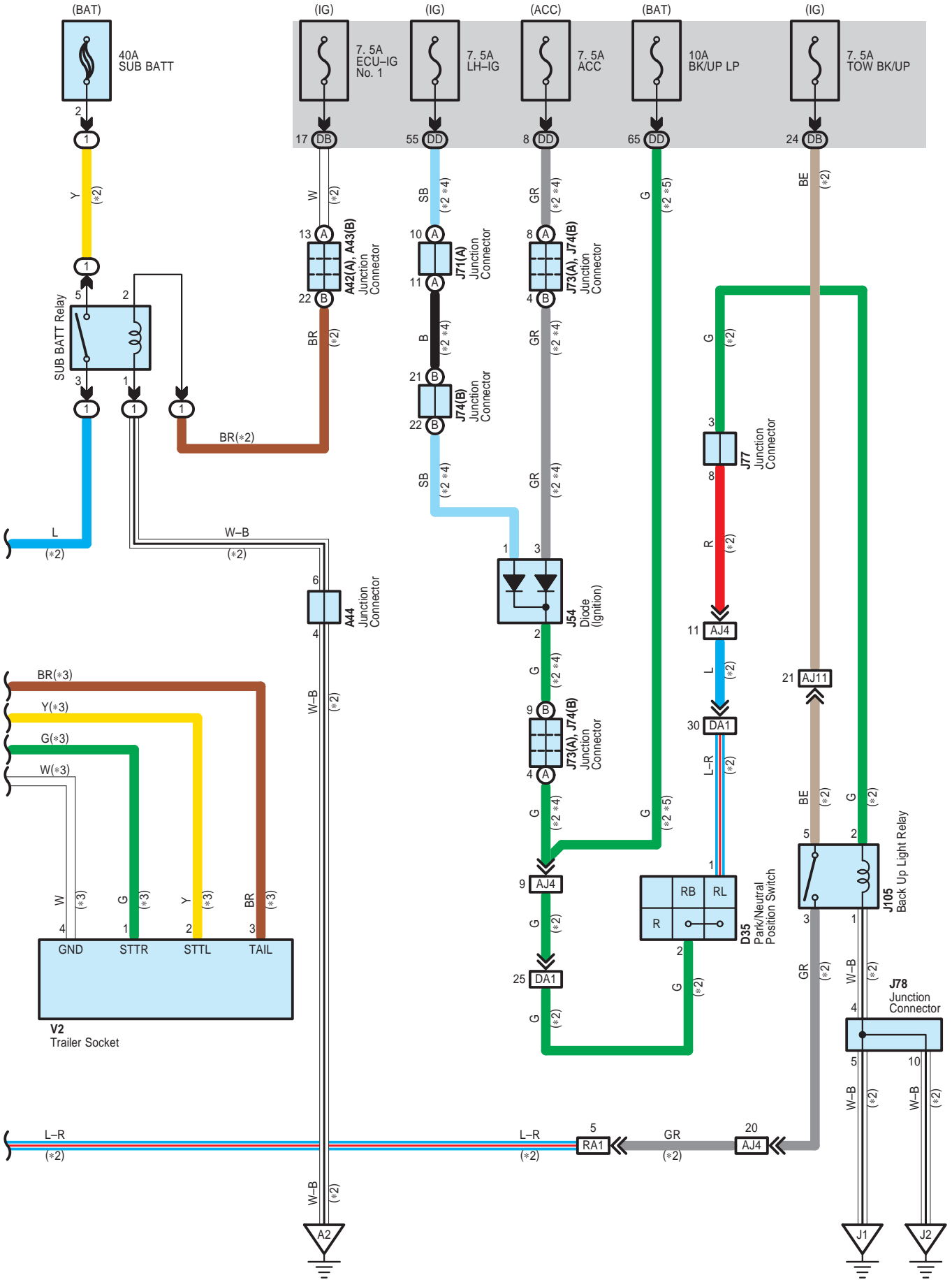

Trailer Towing

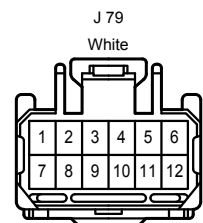
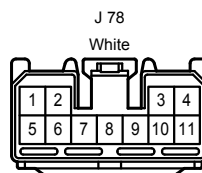
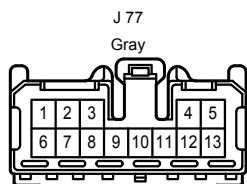
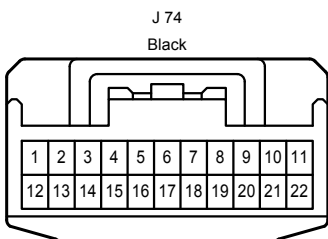
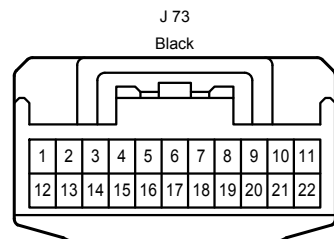
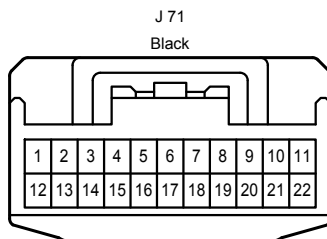
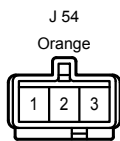
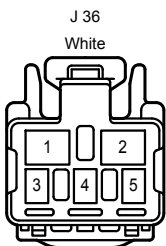
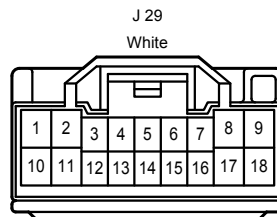
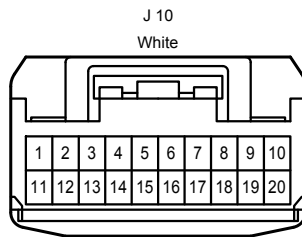
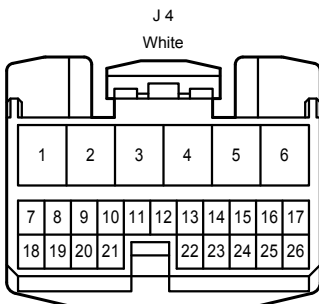
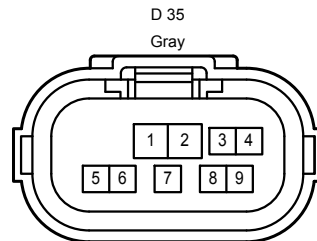
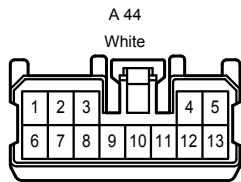
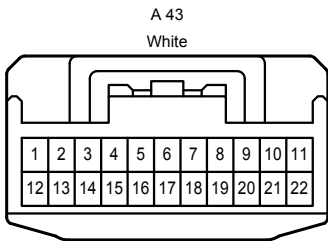
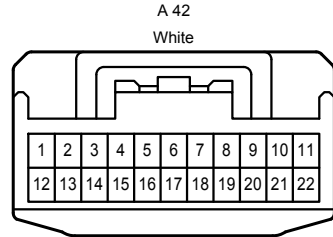
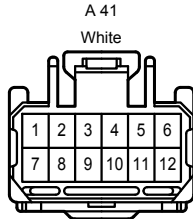
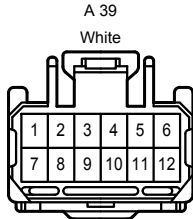
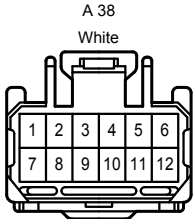
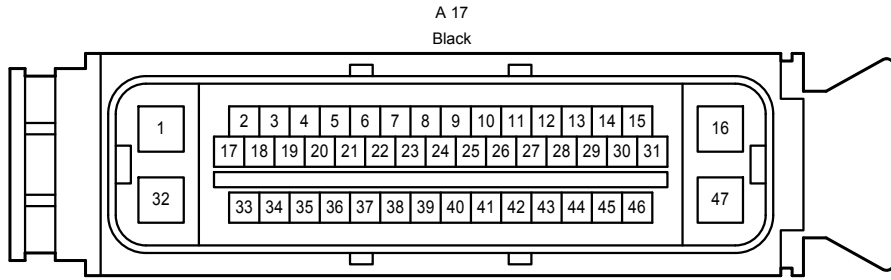
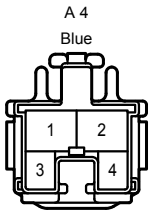

Trailer Towing

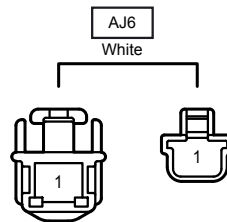
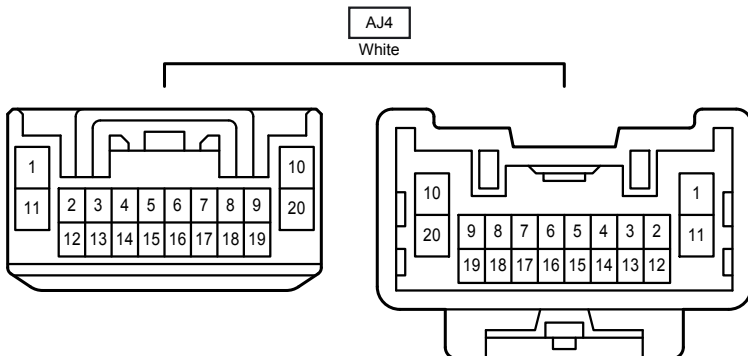
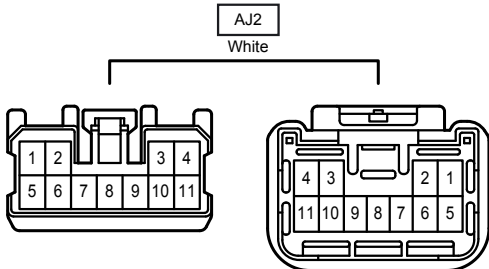
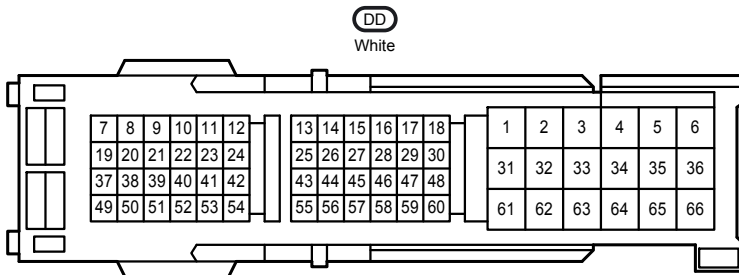
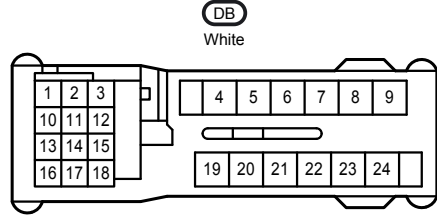
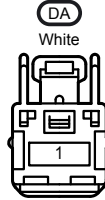
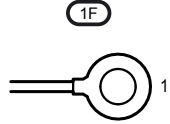
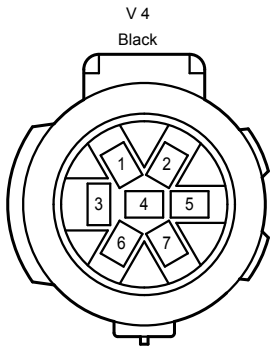
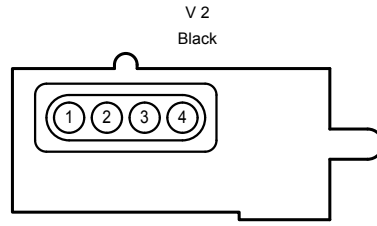
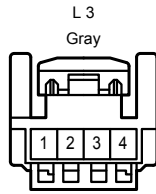
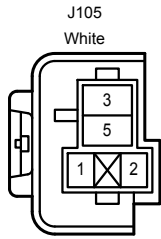
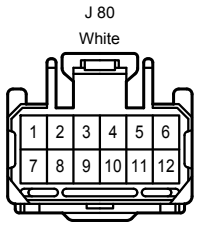

Trailer Towing

AJ7
Gray

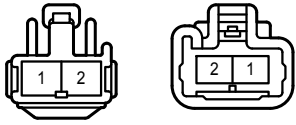

AJ10
Gray

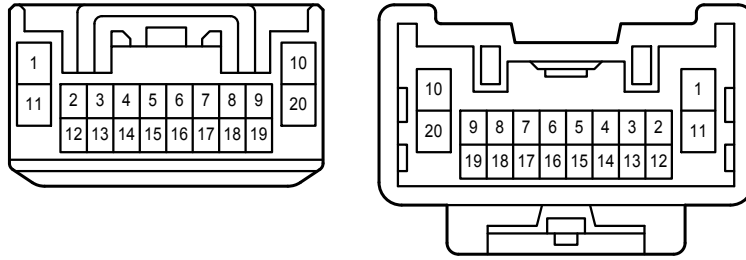

AJ11
Gray

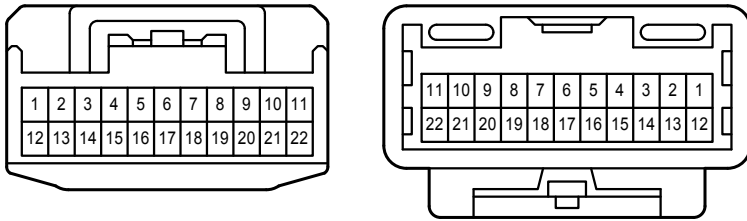

DA1
White

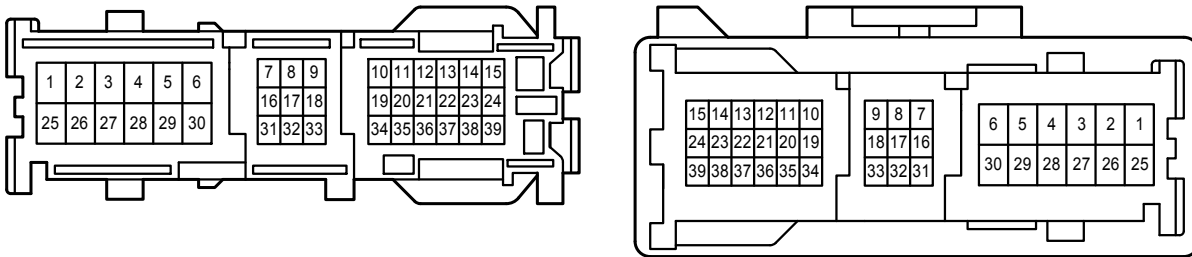

JL1
White

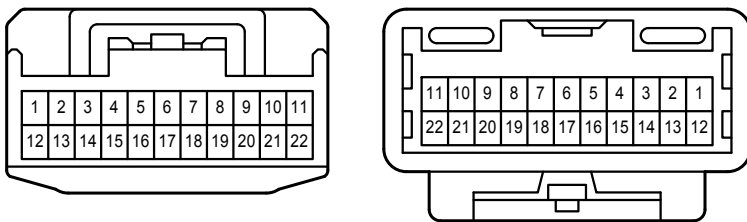

RA1
White

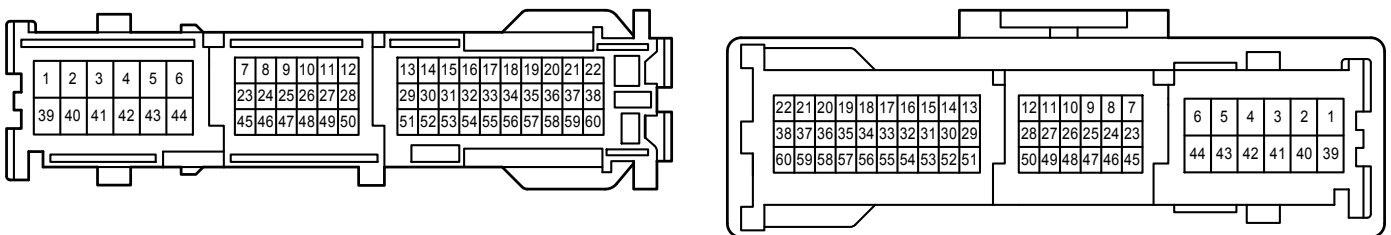

Trailer Towing

RA2
White

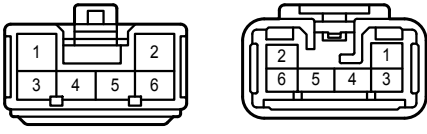

RV1
Gray

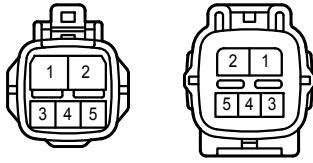

RV2
Gray



Turn Signal and Hazard Warning Light

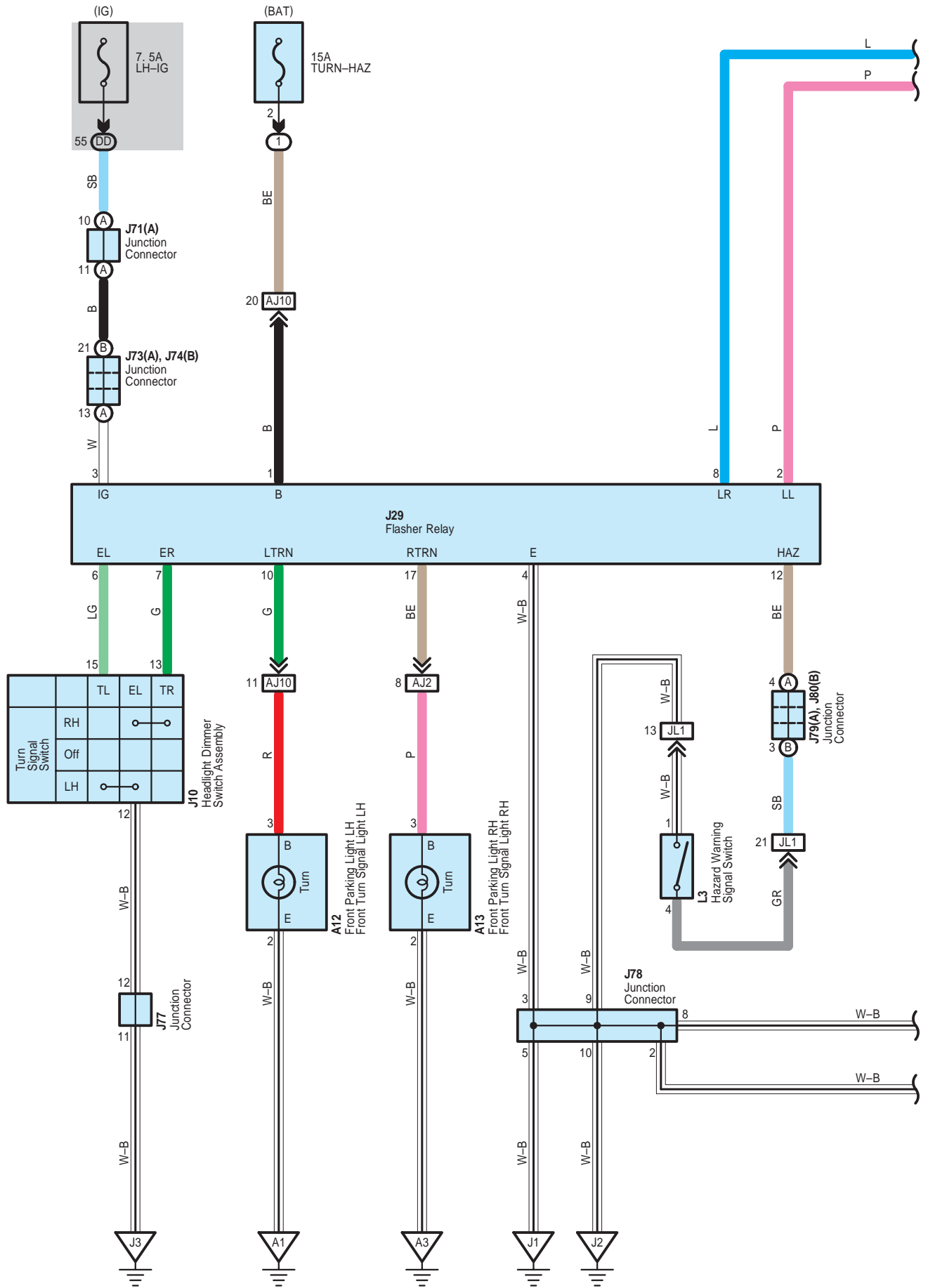

Turn Signal and Hazard Warning Light

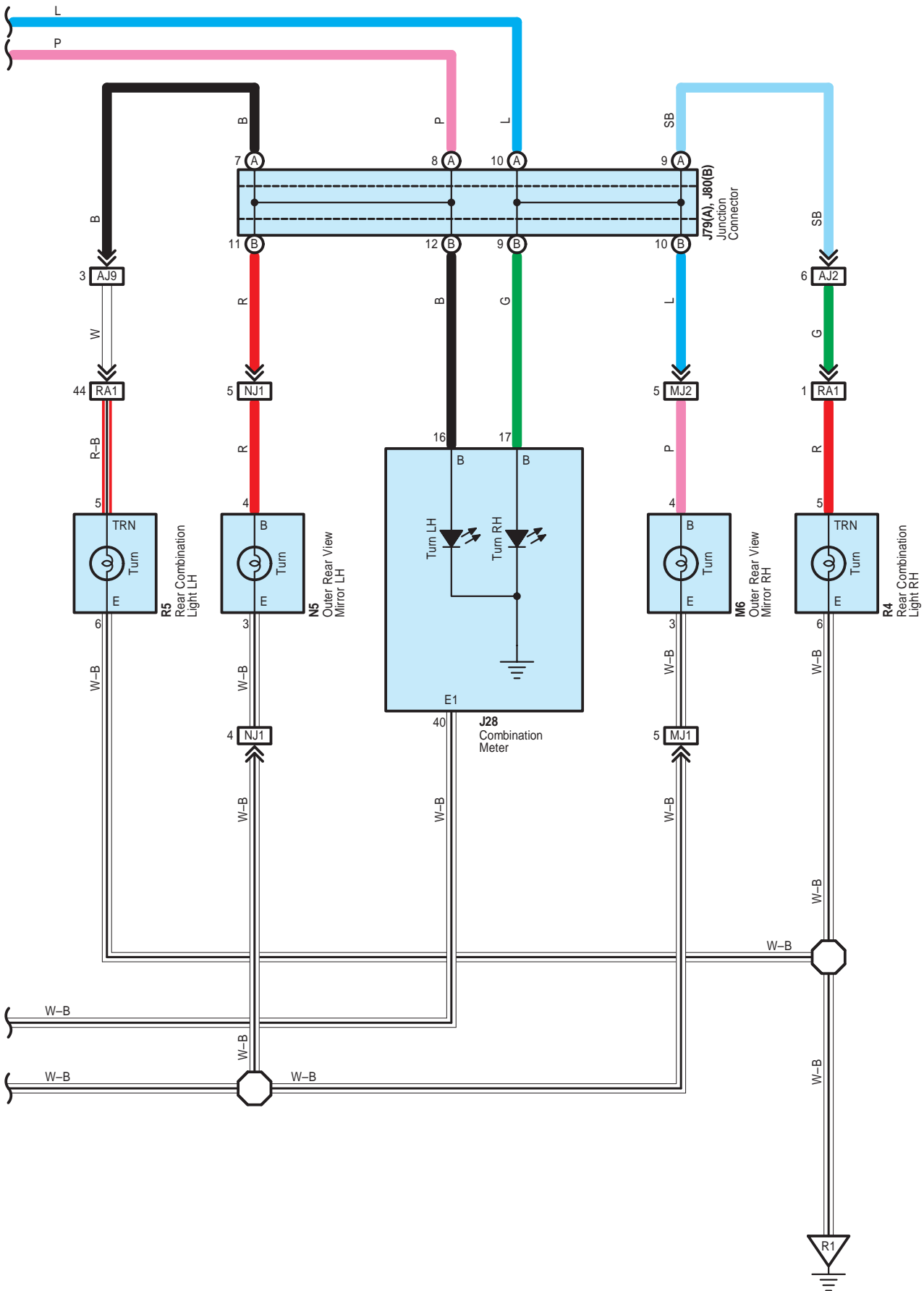

Turn Signal and Hazard Warning Light

A 12
Gray



A 13
Gray



J 10
White

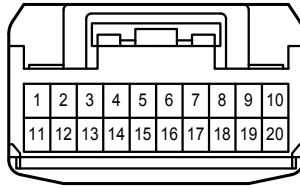

J 28
White

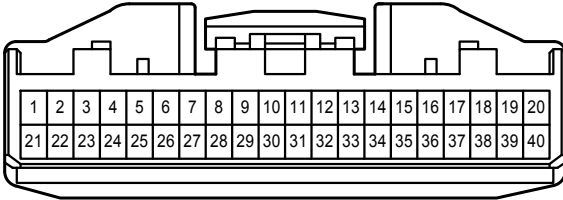

J 29
White

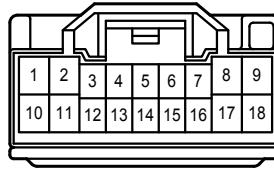

J 71
Black

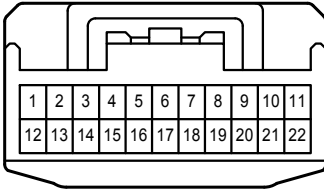

J 73
Black

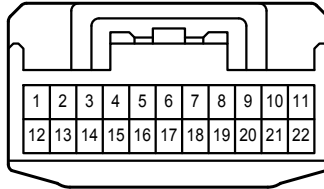

J 74
Black

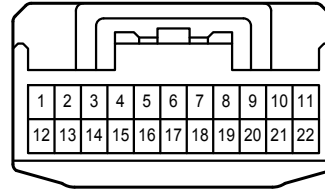

J 77
Gray

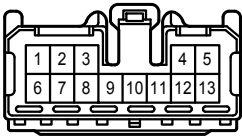

J 78
White

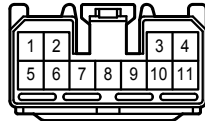

J 79
White

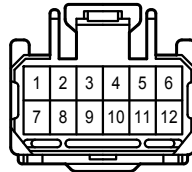

J 80
White

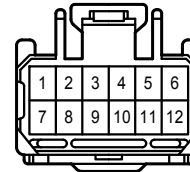

L 3
Gray

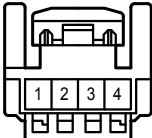

M 6
White

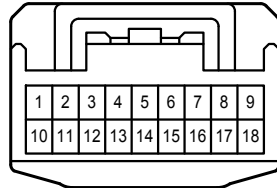

N 5
White

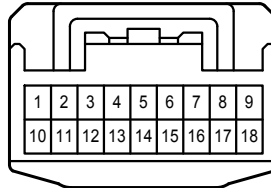

R 4
Gray



R 5
Gray



DD
White

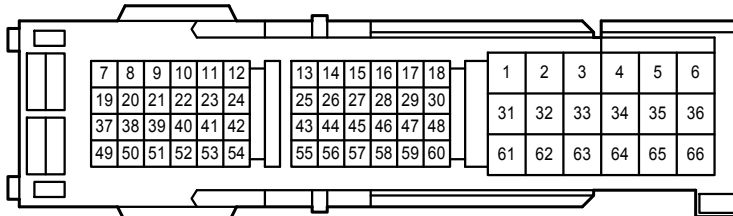

Turn Signal and Hazard Warning Light

AJ2
White

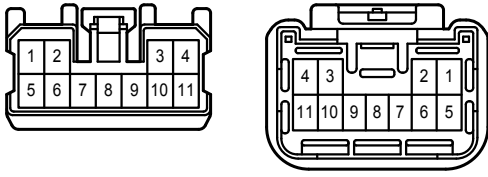

AJ9
Gray

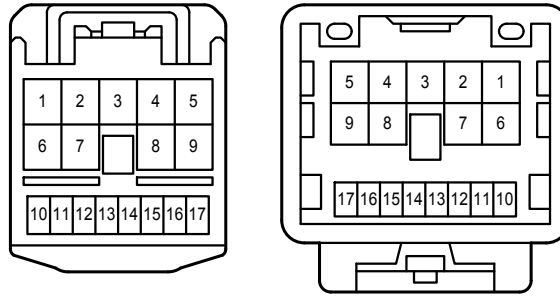

AJ10
Gray

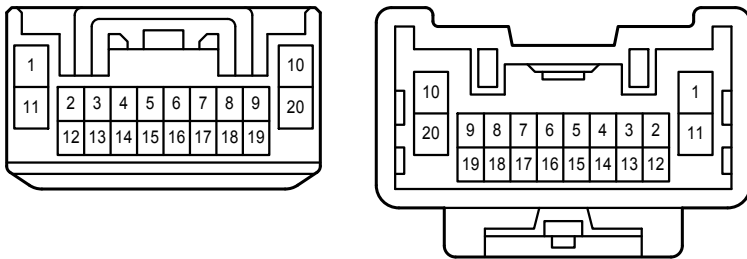

JL1
White

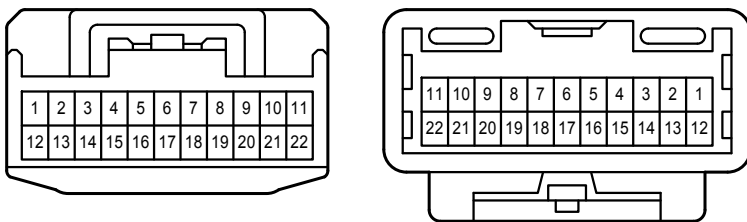

MJ1
Blue

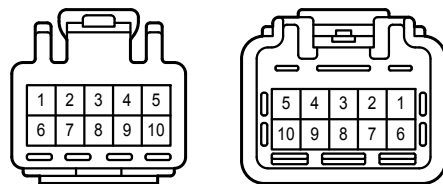

MJ2
Blue

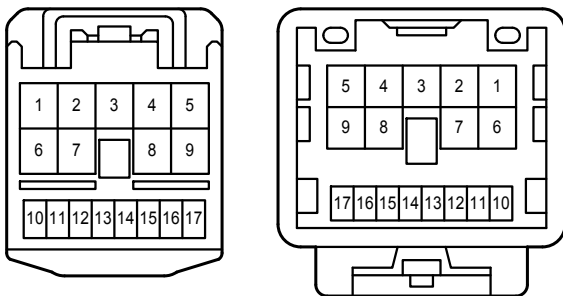

NJ1
Blue

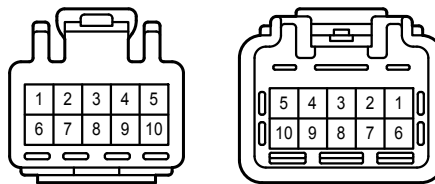

Turn Signal and Hazard Warning Light

RA1
White

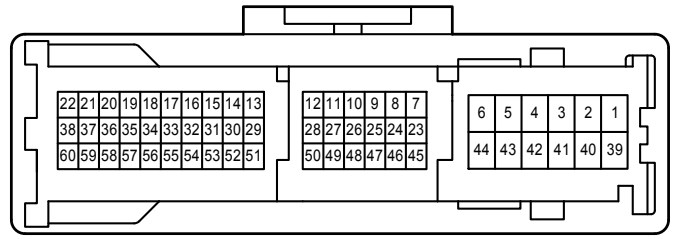
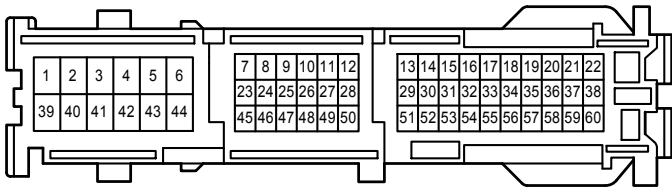

Wireless Door Lock Control

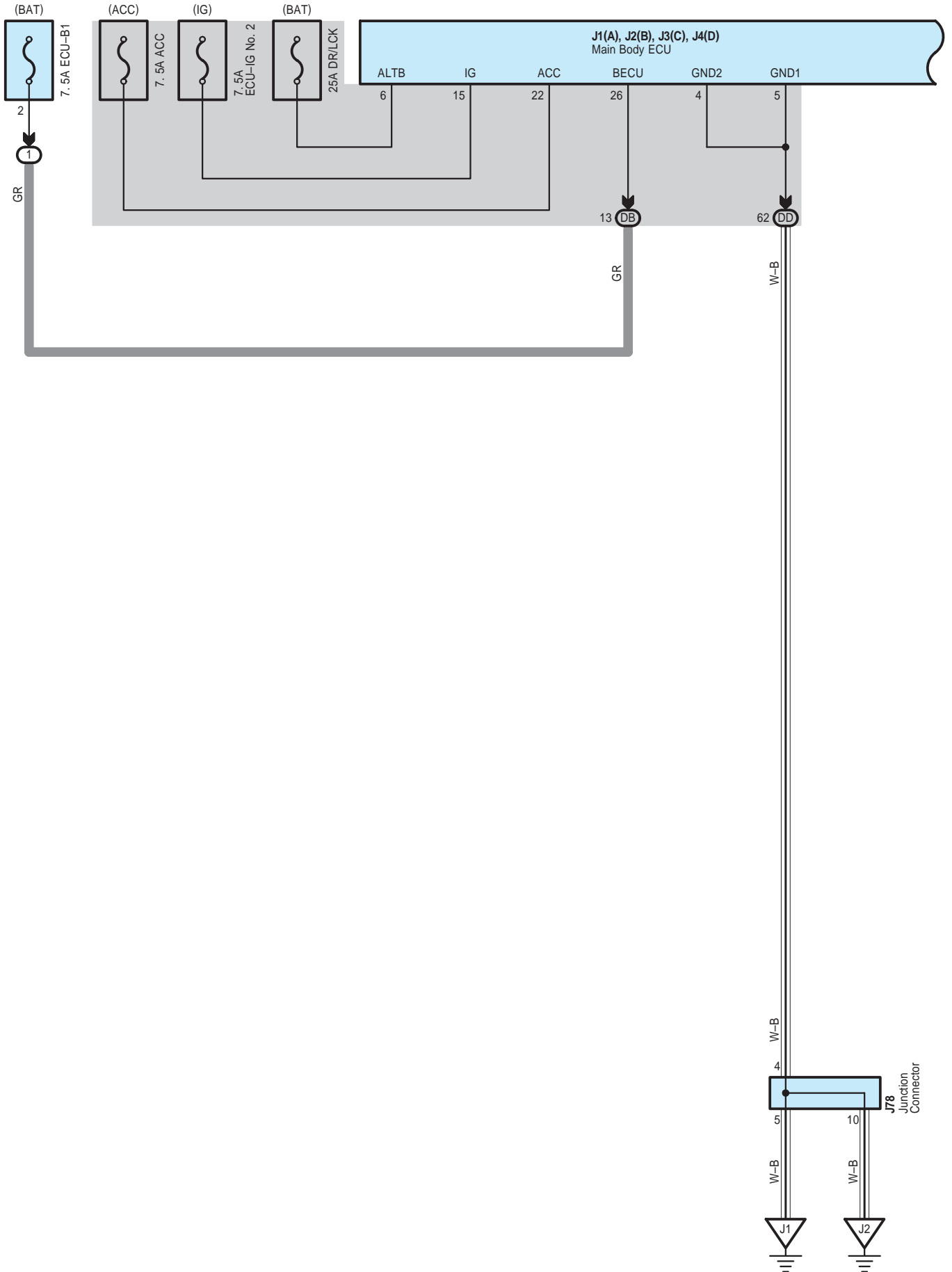

Wireless Door Lock Control

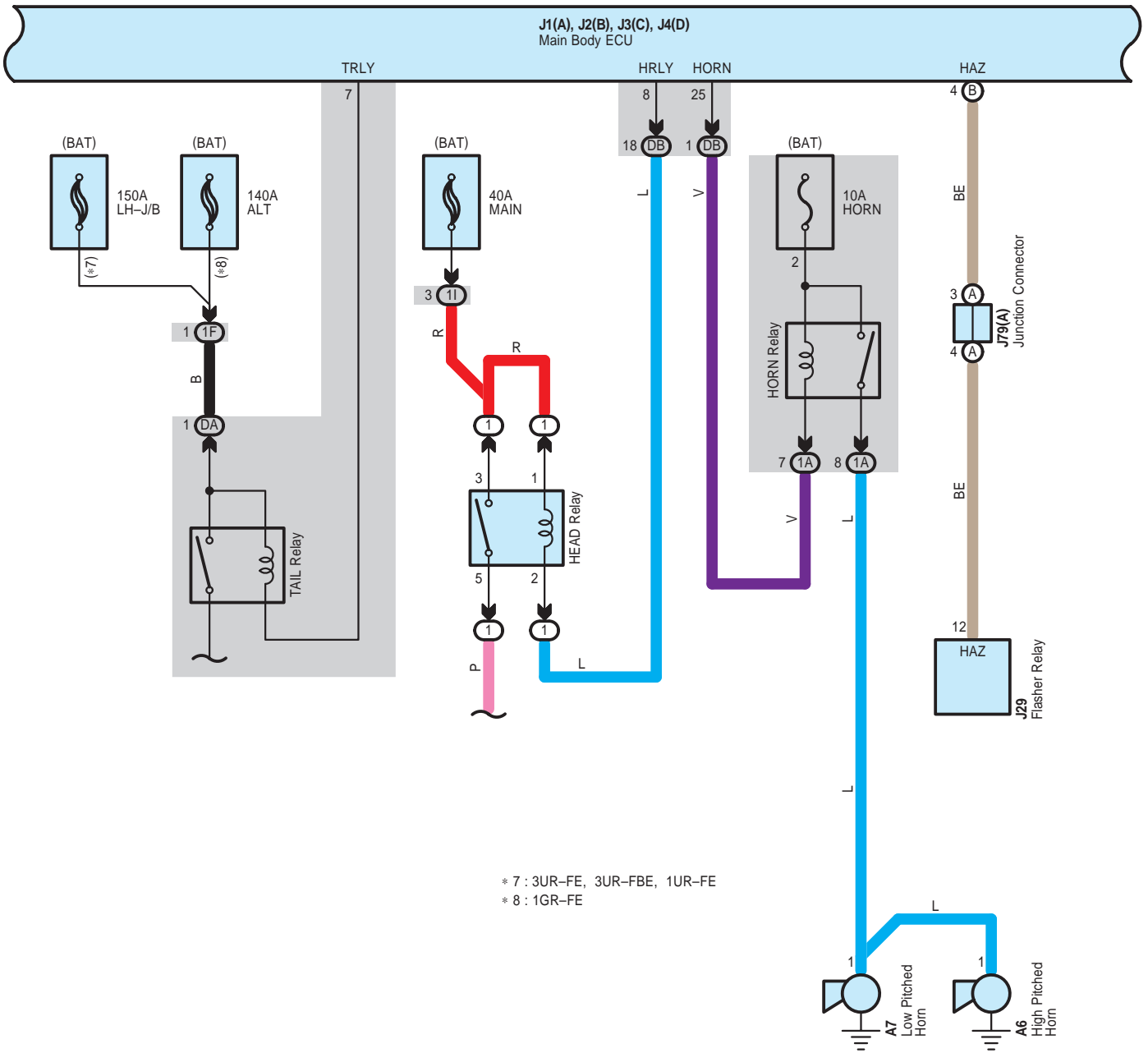

Wireless Door Lock Control

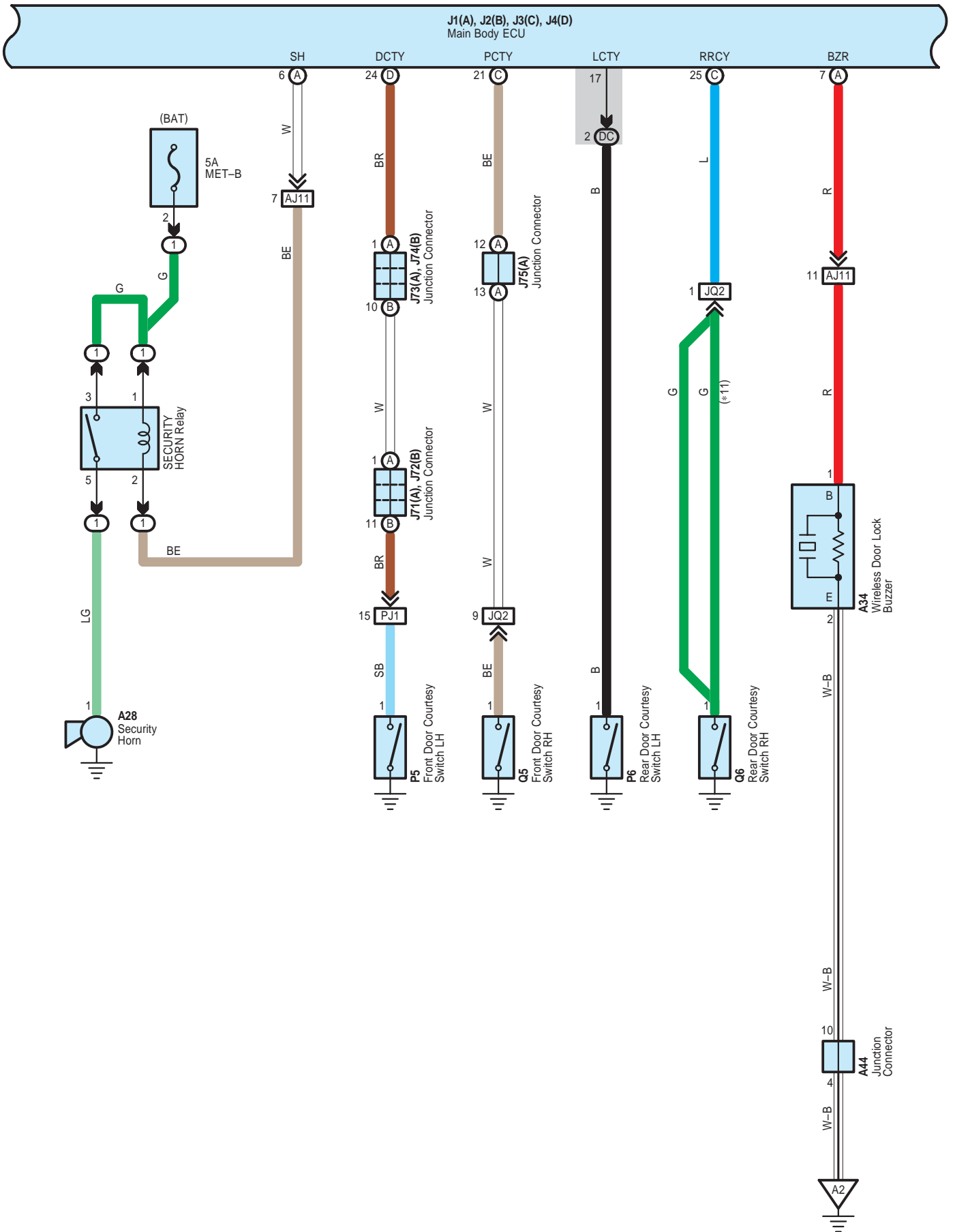

Wireless Door Lock Control

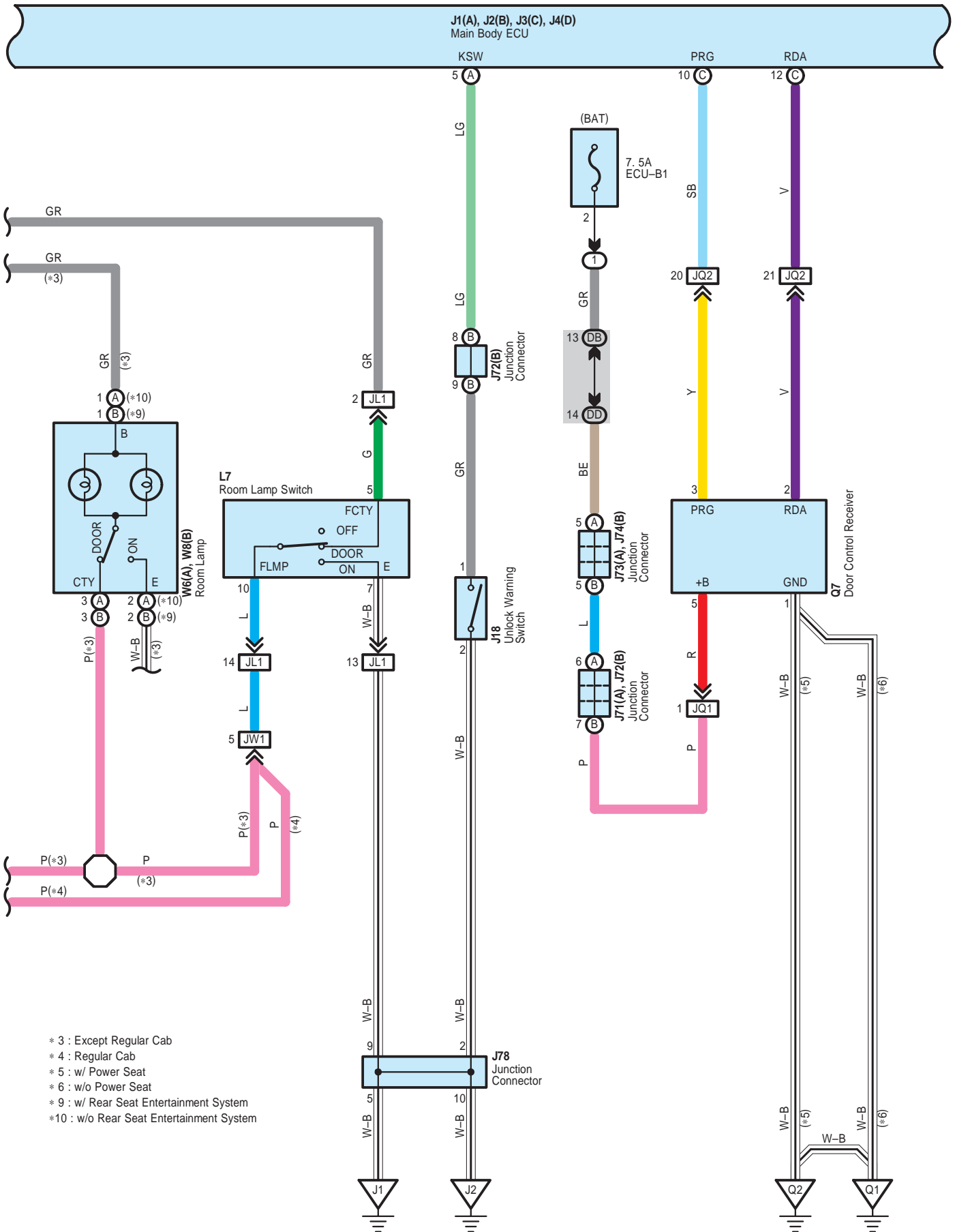

- * 3 : Except Regular Cab
- * 4 : Regular Cab
- * 5 : w/ Power Seat
- * 6 : w/o Power Seat
- * 9 : w/ Rear Seat Entertainment System
- * 10 : w/o Rear Seat Entertainment System

Wireless Door Lock Control

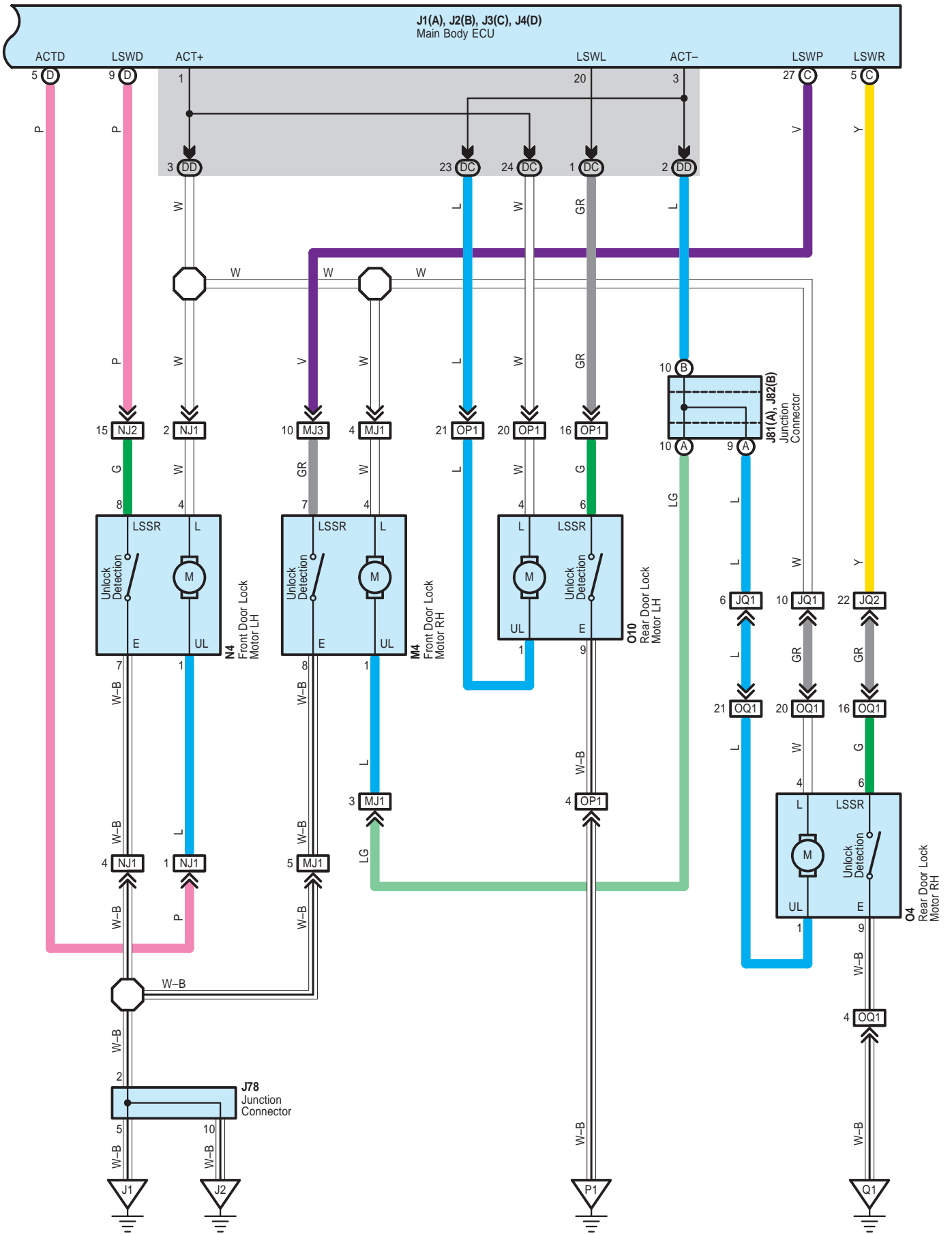

Wireless Door Lock Control

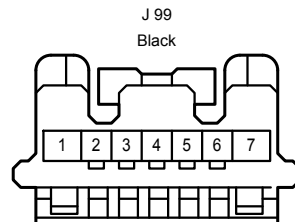
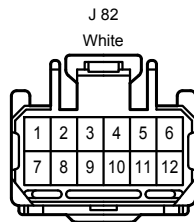
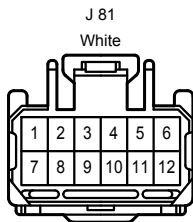
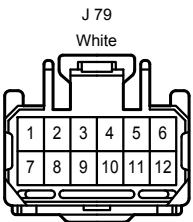
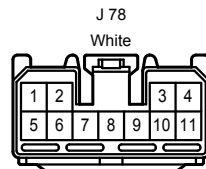
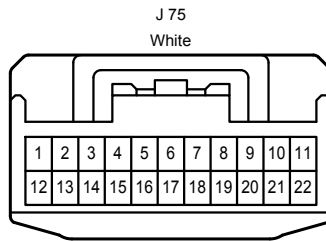
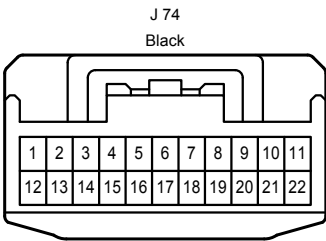
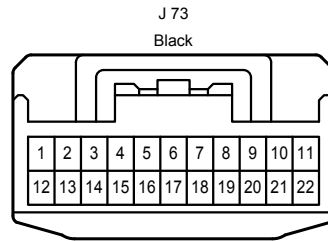
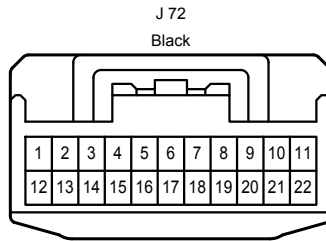
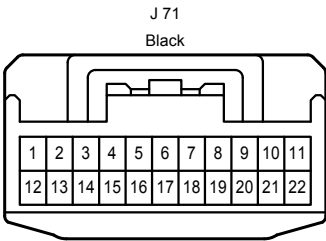
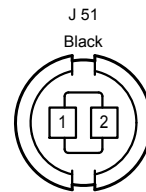
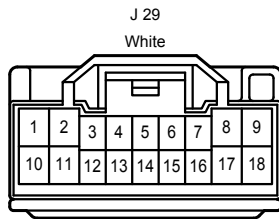
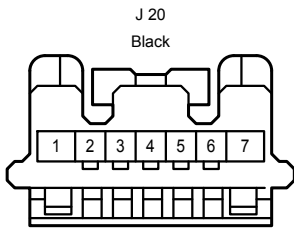
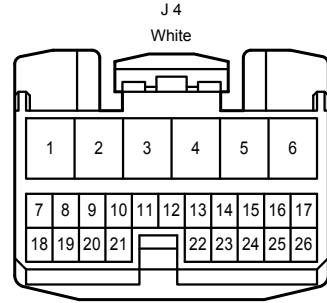
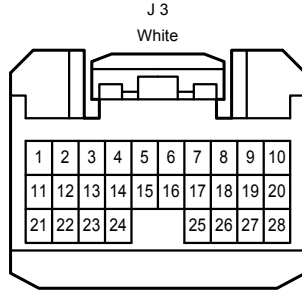
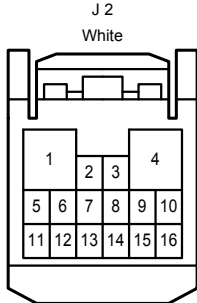
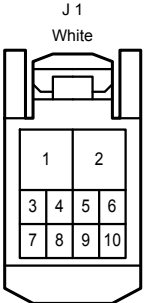
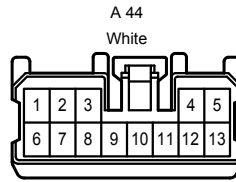
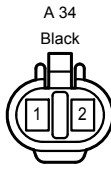
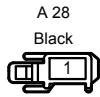
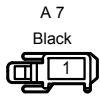

Wireless Door Lock Control

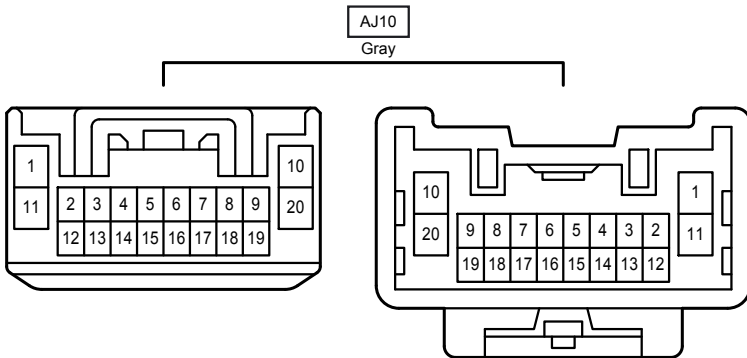
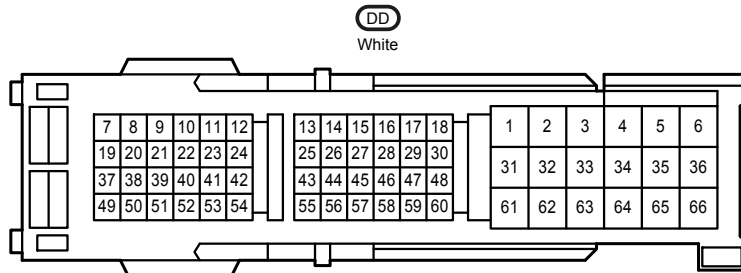
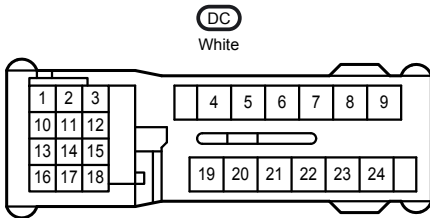
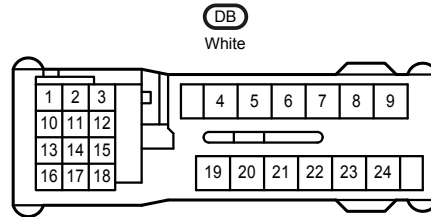
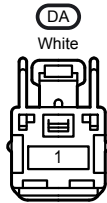
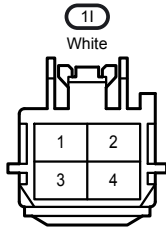
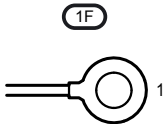
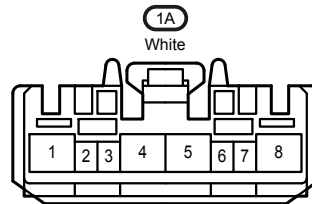
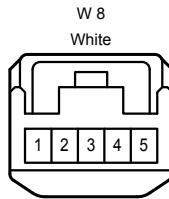
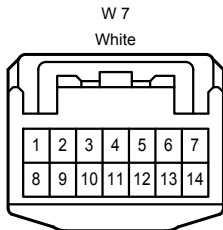
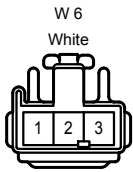
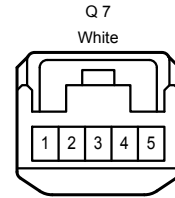
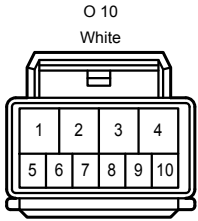
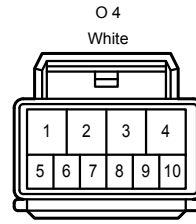
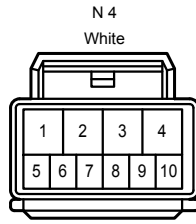
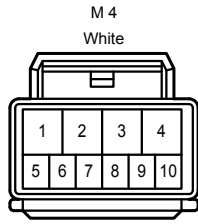
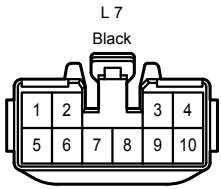

AJ11
Gray

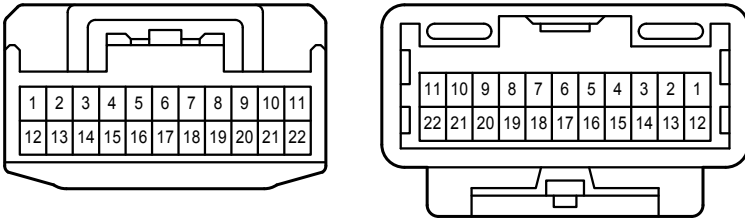

JL1
White

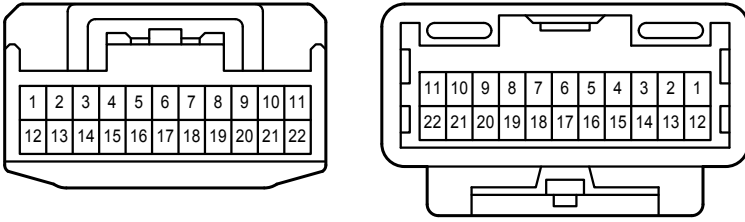

JQ1
Gray

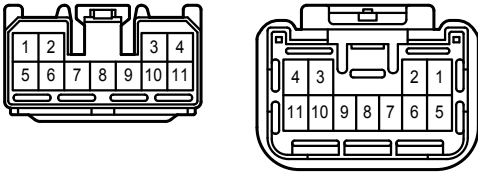

JQ2
Gray

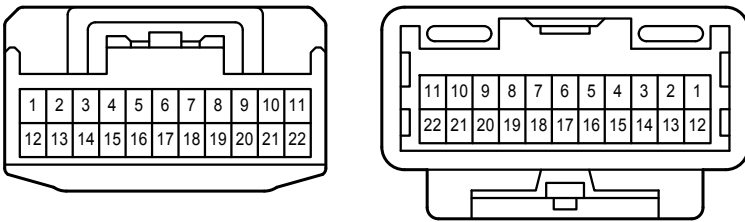

JW1
White

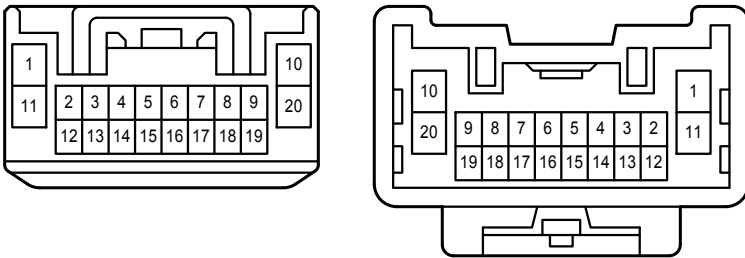

MJ1
Blue

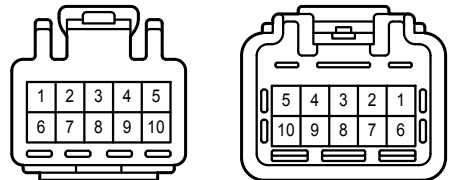

Wireless Door Lock Control

MJ3
Blue

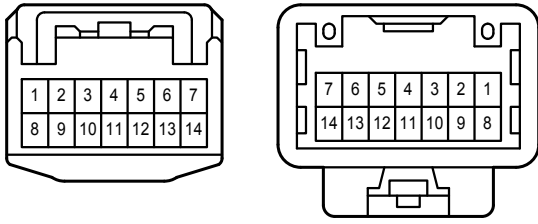

NJ1
Blue

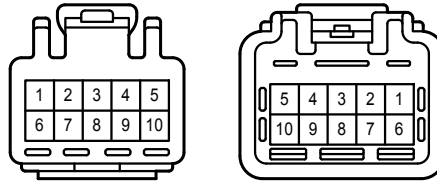

NJ2
Blue

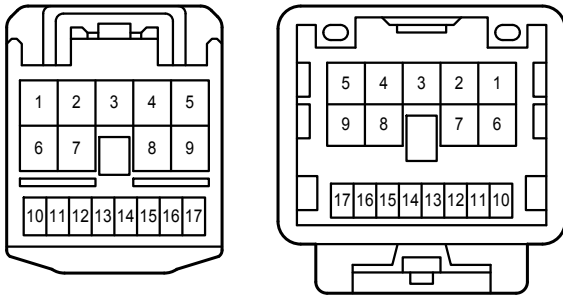

OP1
White

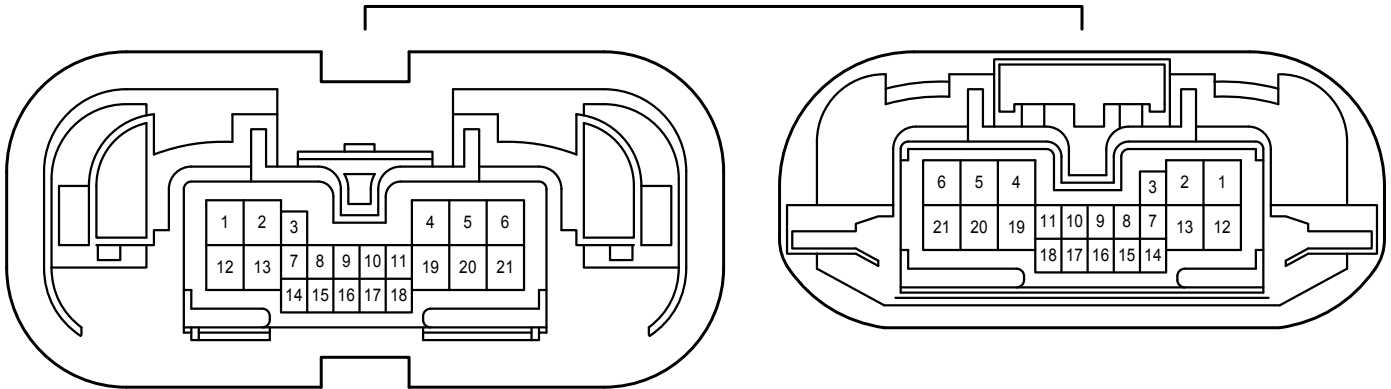

OQ1
White

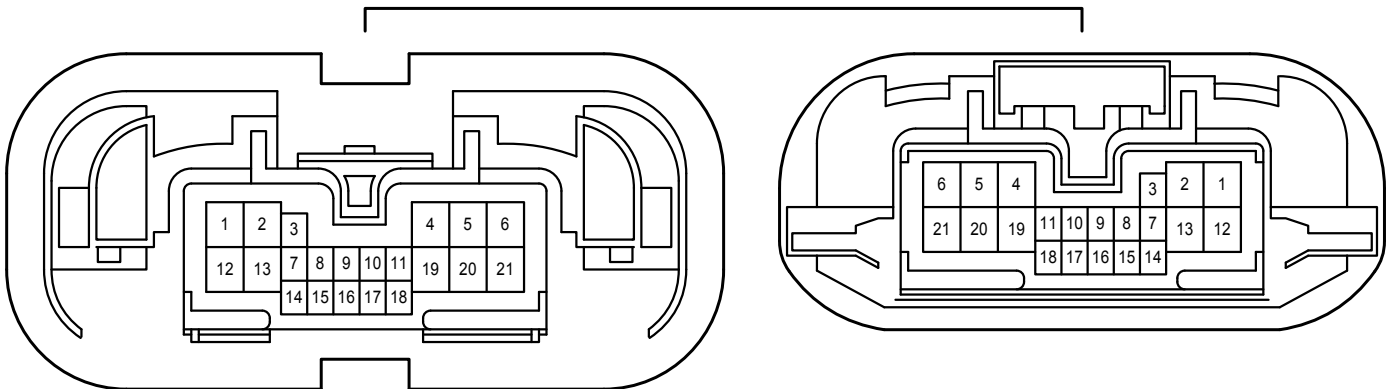

PJ1
Black

