

EG1-328

5S-FE ENGINE - LOCATION OF CONNECTORS

LOCATION OF CONNECTORS

Location of Connectors in Engine Compartment

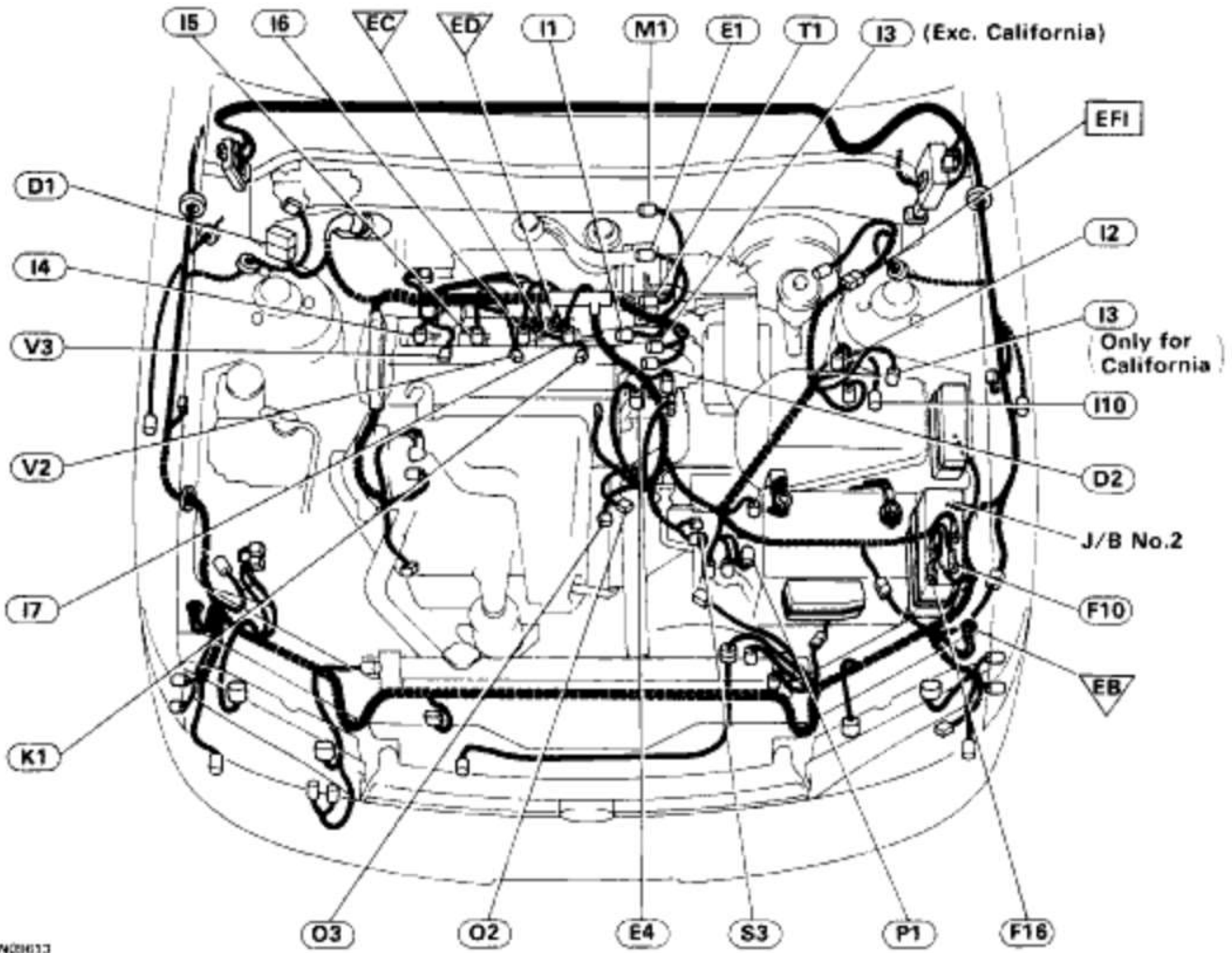

NO8613

D1
Data Link Connector 1

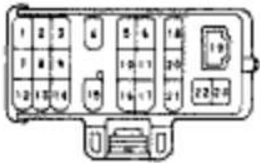

1e-23-1-A

D2
Distributor



1e-4-1-E

E1
EGR Gas Temp. Sensor



1e-2-1-C

E4
Engine Coolant Temp. Sensor



V-2-1-C

F10 F16
Fuse Box



4-A

I1
IAC Valve



1e-3-1-H

I2
Igniter



1e-5-1

I3
Ignition Coil (Exc. California)



1e-2-1-X

I3
Ignition Coil (Only for California)



1e-2-1-n

I4 I5 I6 I7
Injector No.1 ~ No.4



1e-2-1-a

I10
Intake Air Temp. Sensor



1e-2-1-Z

5S-FE ENGINE - LOCATION OF CONNECTORS

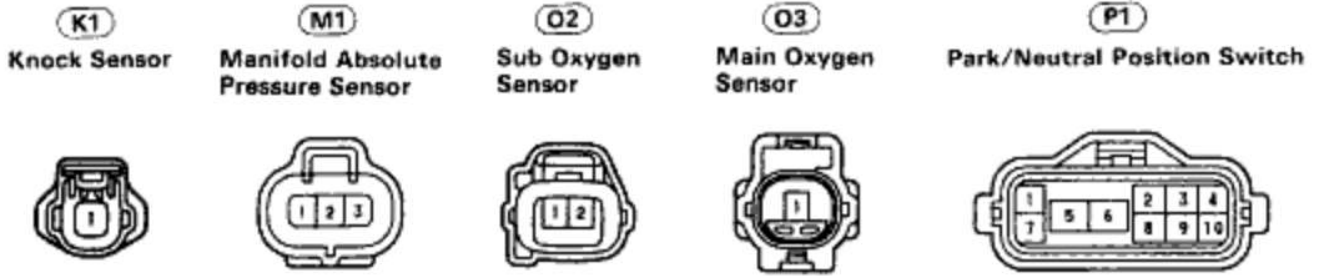

le-1-1-B le-3-1-B le-2-1-C le-1-1 le-10-1-B

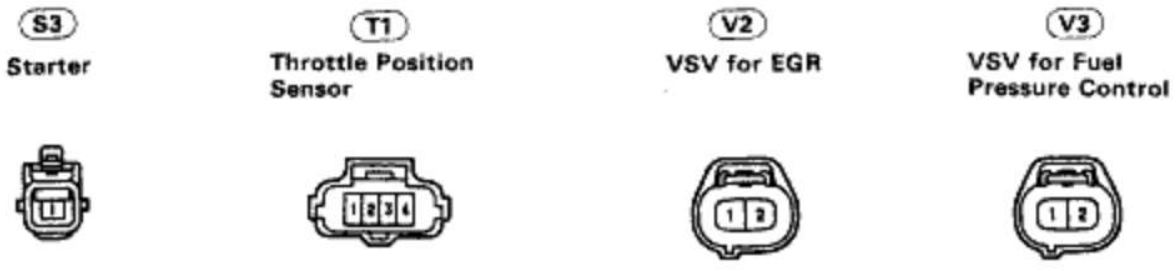

lg-1-1-A IS-4-1-C le-2-1-X le-2-1-X

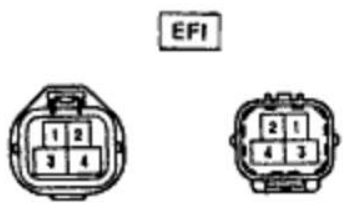

J/B No.2

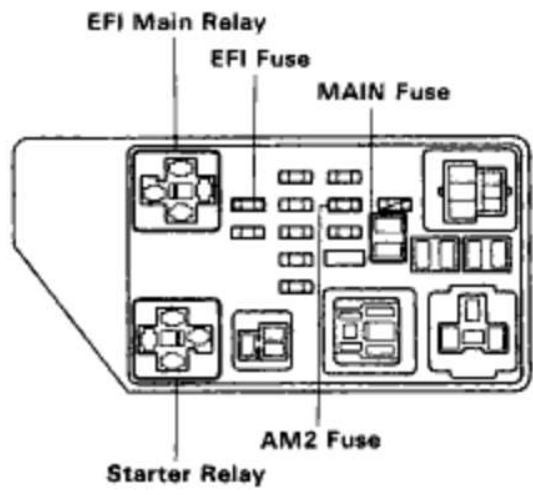

F707B

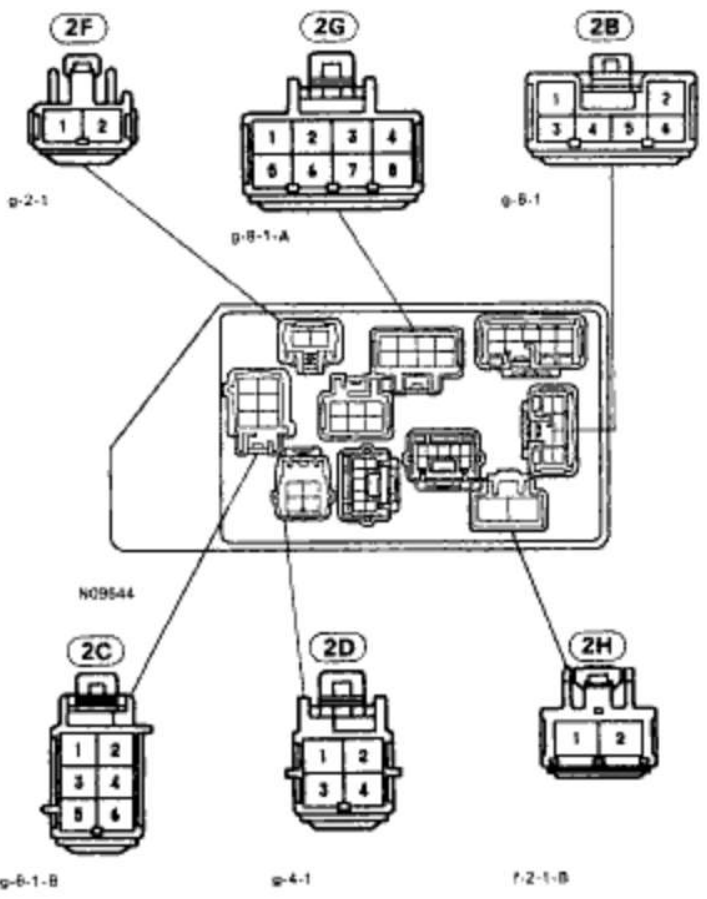

EG1-330

5S-FE ENGINE - LOCATION OF CONNECTORS

Location of Connectors in Instrument Panel

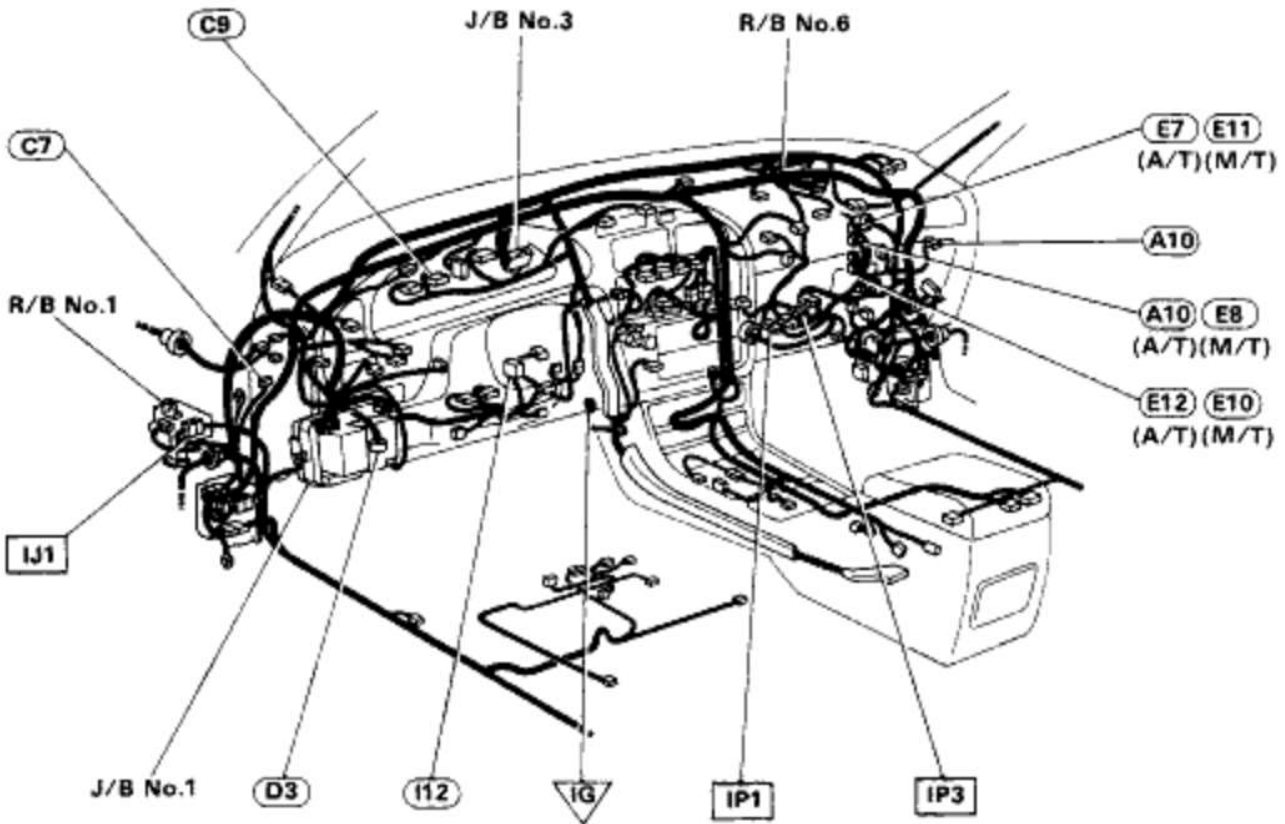

N09614

A10
A/C Amplifier



8-14-1-A

C7
Clutch Start Switch (M/T)



e-2-1

C9
Combination Meter

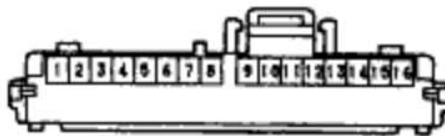

j-15-1

D3
Data Link Connector 2



S-17-1

E7 (A/T)
E11 (M/T)
Engine Control Module

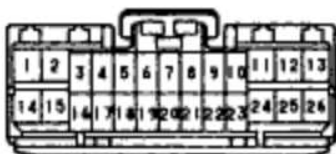

mn-26-1

E8 (A/T)
E12 (M/T)
Engine Control Module



n-16-1-A

E10 (A/T)
E14 (California spec. with M/T)
Engine Control Module



ms-22-1

E14 (Exc. California spec. with M/T)
Engine Control Module



m-12-1

5S-FE ENGINE - LOCATION OF CONNECTORS

I12

Ignition Switch

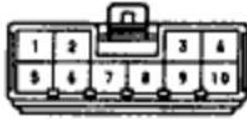

g-10-1-B

IJ1



eg-19-1

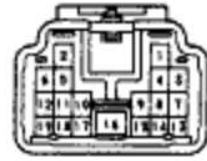

eg-19-2

IP1



e-20-1-B



e-20-2-B

IP3



ef-19-1



ef-19-2

I/B No.1

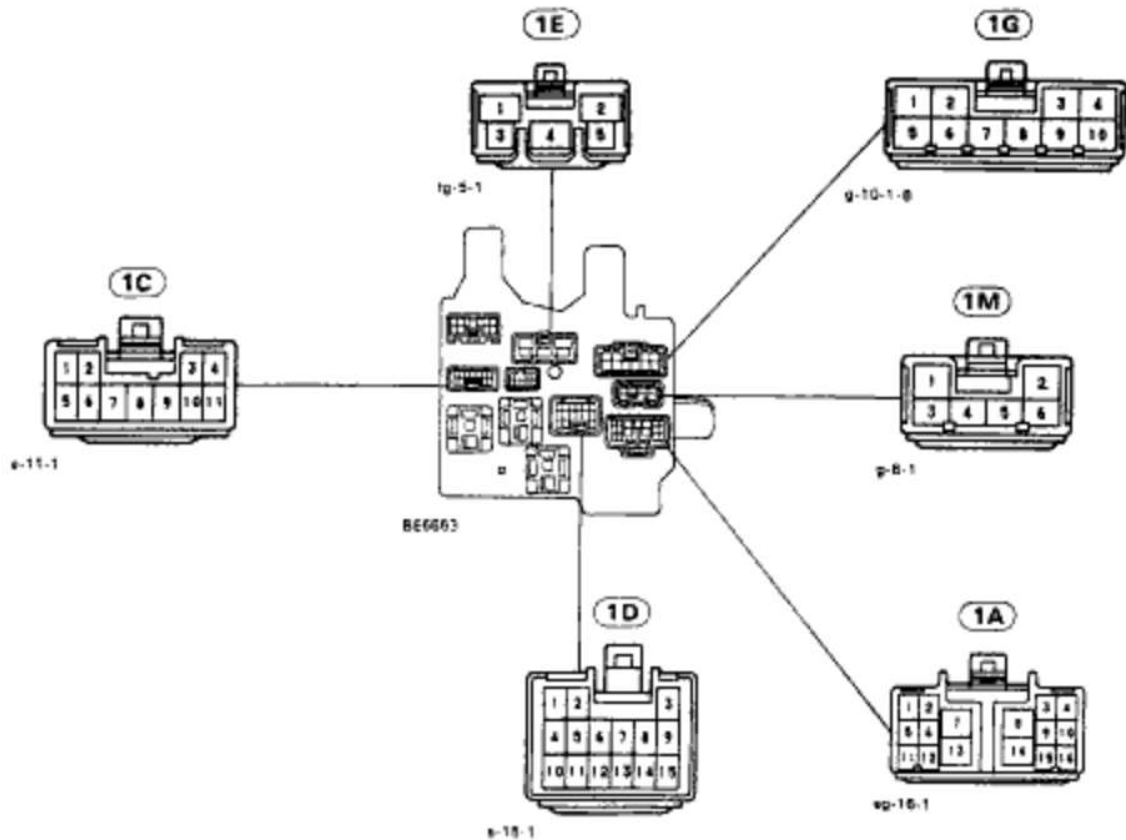

EG1-332

5S-FE ENGINE - LOCATION OF CONNECTORS

Location of Connectors in Instrument Panel (Cont'd)

J/B No.1

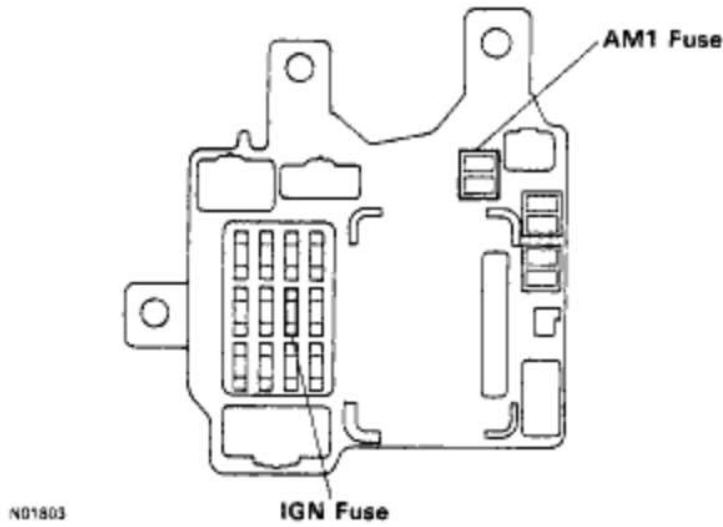

J/B No.3

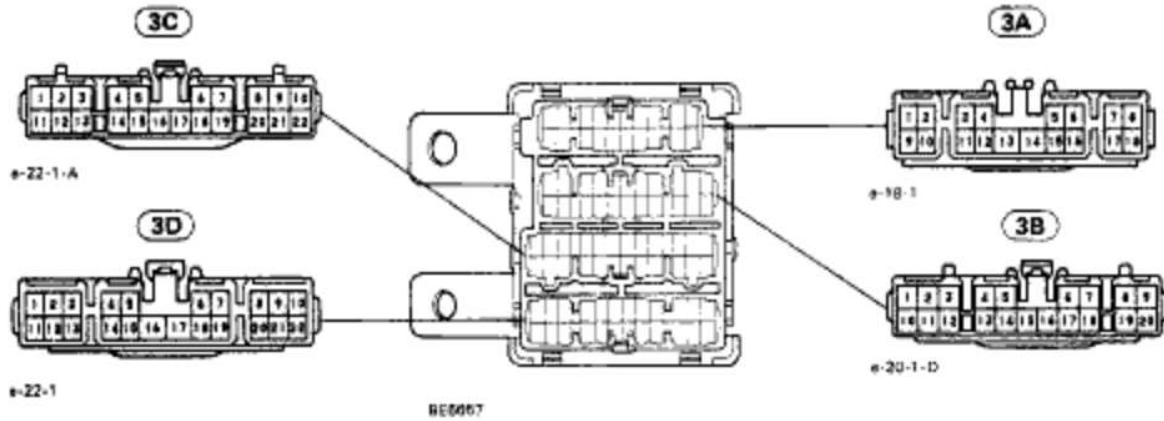

R/B No.1

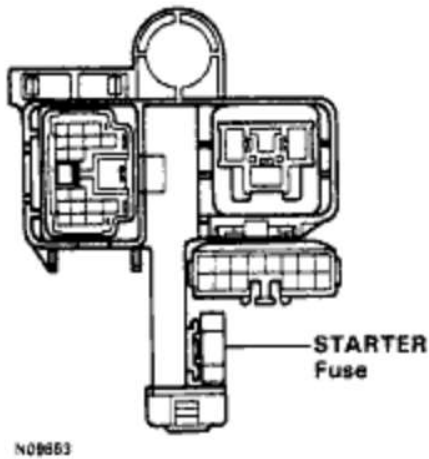

R/B No.6

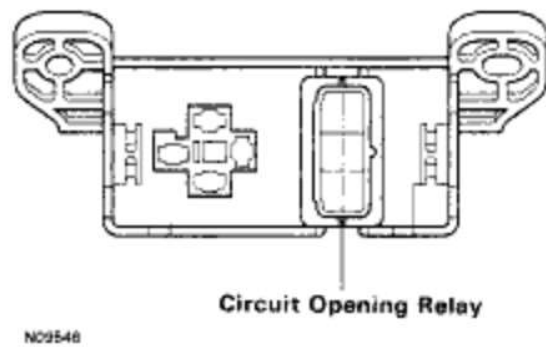

Location of Connectors in Body

Sedan

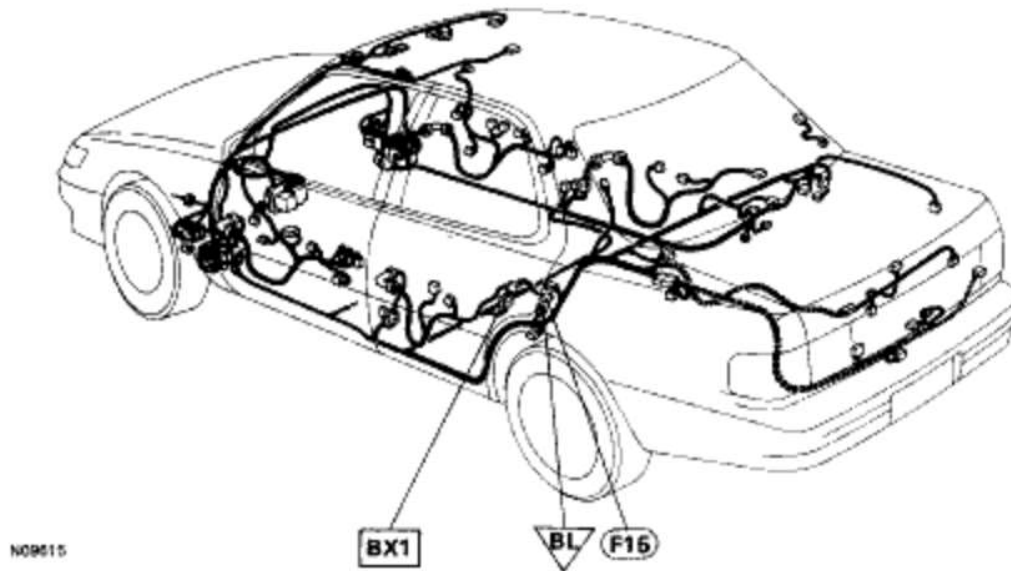

Coupe

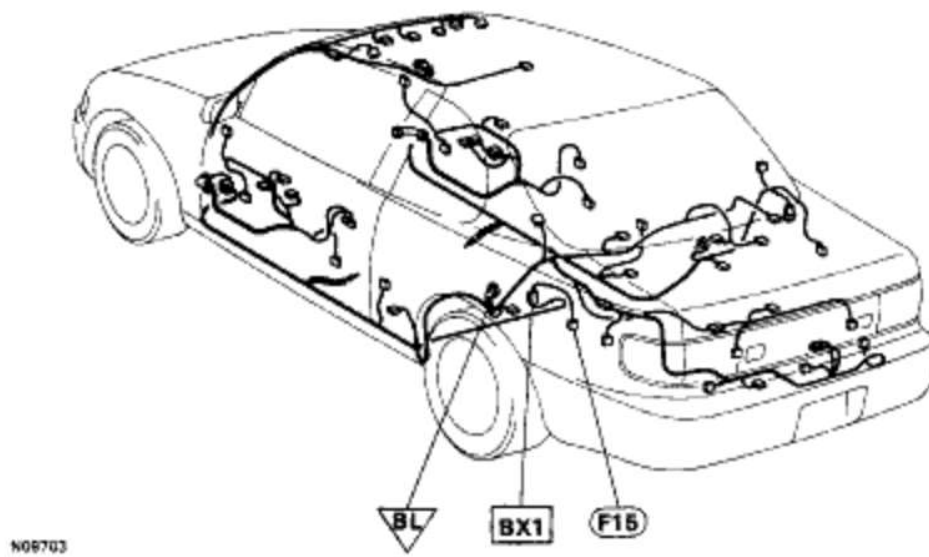

EG1-334

5S-FE ENGINE - LOCATION OF CONNECTORS

Location of Connectors in Body (Cont'd)

Wagon

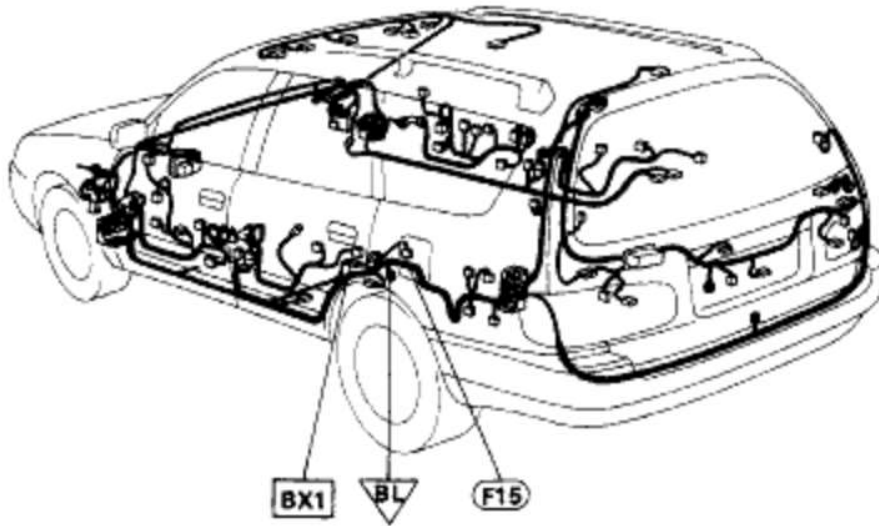

N09704

F15
Fuel Pump

BX1



ie-5-1-A



e-5-1



e-5-2

5S-FE ENGINE –

-Memo