

VHF/UHF GENERATOR 0.3/650 MHz with AM, FM and PM modulation facilities

This manual relates only to the 7100 B version, series 1 to 12. The principal difference between the 7100 B and the 'A' version is the modified power supply. The new, forced air cooled power supply was developed in order to provide for the large number of options. The back panel has been mechanically redesigned to accommodate the internal substitution.

Other less important modifications affect certain specifications such as spectral purity, output level and AM modulation.

7100 B



ADRET ELECTRONIQUE FRANCE

12, avenue Vladimir Komarov • BP 33 78192 Trappes Cedex • France • Tél. 051.29.72
Télex ADREL 697821 F • Siret 679805077 - 00014 • CCP Paris 21 797 04 •

WARRANTY AND ASSISTANCE

This ADRET ELECTRONIQUE product is guaranteed for a period of one year from the date of delivery.

The warranty applies to equipment with mechanical damage sustained during shipping from ADRET ELECTRONIQUE, or failing to conform to the technical specification due to faulty components of sub-assemblies. The warranty does not cover damage caused by incorrect use of the instrument.

The client for his part undertakes not to interfere with the equipment during the warranty period, failing which the

warranty is rendered void. One half of the cost of returning and re-shipping the equipment for maintenance under warranty will be met by ADRET ELECTRONIQUE.

After expiry of the warranty period, the Company will of course remain at the service of its customers and will offer its help to them for any maintenance work that may be necessary.

For any further information, please contact your nearest ADRET representative. The addresses of our main agents are given in the table on below.

ADRET COMMERCIAL NETWORK

FRANCE

Société BASCOUL-ÉLECTRONIQUE
31200 TOULOUSE - 35, rue de Luchet - Tél. (61) 48.99.29
33600 BORDEAUX PESSAC - 76, av. Pasteur - Tél. (56) 45.01.90

Société DIMEL Immeuble «Le MARINO»
83000 TOULON - Avenue Claude Farrère
Tél. (94) 41.49.63 - Télex 430093 F

Société SOREDIA - Chatillon sur Seiche
BP 1413 - 35015 RENNES CÉDEX
Tél. (99) 50.50.29 - Télex 95359 SOREDIA

EUROPE C.E.E. - COMMON MARKET

Allemagne - Germany

ROHDE UND SCHWARZ
5 KOELN-PORZ 90 - Graf Zeppelin str. 19 - Tél. : (02203) 49-1

Belgique et Luxembourg - Belgium and Luxembourg

SAIT ELECTRONICS 66, Chaussée-de Ruisbroek
B-1190 BRUXELLES
Tel. 02.376.20.30 - Telex 61130 ELEC B
Teleg. : wireless - Brussels

Grande Bretagne - Great Britain

RACAL DANA INSTRUMENT Ltd
WINDSOR Berkshire SL4 1SB Duke Street
Tel. (075.35) 69811 - Telex : 847013 Racal Windsor

Hollande - The Netherlands

C.N. ROOD BV.
2280 AA RIJSWIJK - 11, 13 cort V.D. Lindenstraat
P.P. Box 42 - Tel. 070.996360 - Telex : 31238

Italie - Italy

METROELETTRONICA
Viale Cerèrè, 18 - 20135 MILANO (ITALY)
Tél. 54.62.641 - Télex 312168-315802

EUROPE OTHER WESTERN EUROPEAN COUNTRIES

Norvège - Norway
MORGENSTIERNE and Co A/S
Konghellegate 3
P.O. Box 6688, Rodelokka OSLO 5

Espagne - Spain

TELCO
Gravina, 27 - MADRID
Telex : 27348 - Tél. : 221.01.87

Suède - Sweden

TELEINSTRUMENT AB Maltesholmsvägen 138 - Box 490
S 16204 VALLINGBY

Danemark - Denmark

TAGE OSLEN A/S leglvaerksgade 37
Dk 2100 - COPENHAGEN

Finlande - Finland

ORBIS OY Kalannintie 52 - P.O. Box 15
SF 00421 HELSINKI 42

Autriche - Austria

ROHDE AND SCHWARZ-TEKTRONIX AG
Sonnleithnergasse 20 - A 1100 WIEN

Suisse - Switzerland

ROSCHI TELECOMMUNICATION AG
Giacomettistrasse 15 - Ch 3000 BERN 31

Grèce - Greece

SCIENTIFIC ENTERPRISES Co
P.O. Box 761 ATHENS K Tél. 3618.783 - Telex 22.12.41

Iran

FARATEL P.O. Box 11/1682 TEHERAN Tel. : 667.030 - Telex : 213071

Turquie - Turkey

JAK BARKEY
Halaskargazi Cad 177 Bakay - Apt No 6 Panalti - ISTANBUL
Tel. : 489147 - Telex : 23401 HEN-TR Teleg. : KARBARHEN

AFRIQUE DU SUD - SOUTH AFRICA

K BAKER - ASSOCIATES LTD
3 Rd Floor - Hyde Park Corner Jansmuts avenue - SANDTON

AMERIQUE LATINE - SOUTH AMERICA

Argentine - Argentina

RAYO ELECTRONICA Belgrano 990 1092 BUENOS AIRES
Tel. : 381779 - Telex : 0122153 AR RAYUX Teleg. : RAYOTRONICA BSAS

Brésil-Brasil

IGB-INS GRADIENTE BRASILEIRAS S/A
Staub agency division PO Box 30318 - 0100 - SAO PAULO
Tel. 457.4000 - Telex : 011.4318 IGBC AR Teleg. : SAPESTAB SAO PAOLO

ASIE - ASIA

Inde - India

TOSHNIWAL BROTHERS PRIVATE LTD
9, Blackers Road - Mount Road MADRAS 600.002

INDEX

	Pages
CHAPTER I : INTRODUCTION	I-1
CHAPTER II : TECHNICAL SPECIFICATIONS	II-1
CHAPTER III : OPERATION	III-1
● Preparing for use	III-1
● Goods inwards reception	III-1
● Generator identification	III-1
● Connection to mains	III-1
● Environment	III-1
● Storage	III-2
● Mounting in 19 inch-rack	III-2
● Functional description	III-2
● 7100 basic version	III-2
● Description of front panel	III-2
● Description of rear panel	III-4
● Preliminary checks	III-4
● Putting into operation	III-4
● Frequency	III-4
● Output level	III-4
● Amplitude modulation	III-5
● Frequency or phase modulation	III-5
● Description of the use	III-5
● Frequency and level display	III-5
● Display of AM-Fm and OM	III-6
● Control of internal master oscillator	III-7
● Self-test	III-7
● The 7100 supplemented by its options	III-11
Output circuit protection (option 01)	III-11
Electronic circuit breaker (option 02)	III-11
Extension of frequency range (options 03 and 10)	III-11
Pulse modulation (option 06)	III-12
Automation of controls (options 04 and 05)	III-12
CHAPTER IV : PRINCIPLE OF OPERATION	
General principle	IV-1
Signal production	IV-2
● Generation of small steps (10^0 to 10^6 Hz)	IV-2
● Generation of 10 MHz steps	IV-2
● Frequency interpolation	IV-3
● Output circuit	IV-3
Microprocessor and associated logic	IV-5
● General description	IV-5
● Software operation	IV-6
● Detail of hardware	IV-7
● External inputs - outputs	IV-7
● Tables	IV-7
Principle of options	IV-11
● Electronic circuit breaker (option 02)	IV-11
● Frequency doubler (option 03)	IV-11
● Pulse modulator (option 06)	IV-11

CHAPTER I

INTRODUCTION

The ADRET 7100 is an RF frequency generator which combines the essential characteristics of cavity oscillators and those of frequency synthesizers.

This performance has been achieved thanks to a new synthesis technique which combines the functional principles of both these instruments.

The design technique, together with the use of a micro-processor for all data management, have endowed the generator with excellent spectral purity, with the stability

of accuracy available from a crystal controlled oscillator, with high resolution, with programmability of all functions, and with facilities for AM, FM and PM.

The ADRET 7100 may thus be used for calibrating FR receivers, with measurements being effected in manual or automatic mode when the generator is incorporated in an automatic test set—up.

The addition of various options to the basic equipment allows the 7100 generator to be adapted for many applications, by choosing the most appropriate configuration.

FREQUENCY BAND

This instrument covers the 300 kHz to 650 MHz frequency band in a single range, which may be extended to 1300 MHz by the addition of the internal DOUBLER option. Frequency is selected by a knob driving an optical encoder wheel and is displayed with a resolution of 1 kHz, 10 kHz, 100 kHz or 1 MHz, extension to 1 Hz being obtained by means of a vernier. The actual output frequency is shown on a 9-digit LED display (10-digit with the DOUBLER option). Stability and accuracy are determined by the

internal crystal-controlled master oscillator (5×10^9 /24 hours).

To facilitate measurements on receivers, it is possible, using an internal stepping system after setting to an RF frequency, to advance in steps of 12.5 kHz, 20 kHz, 25 kHz, 50 kHz or 100 kHz which correspond to standard channel spacings. The device also enables frequencies to be scanned in steps of 1 kHz, 10 kHz, 100 kHz or 1 MHz.

SPECTRAL PURITY

The signal to phase noise ratio obtained by the 7100 generator is characterised by a curve similar to that of synthesizers, for frequencies close to that of the carrier, while from 20 kHz it corresponds to the noise level achieved by the best cavity oscillators.

Generation of large frequency steps by an oscillator controlled by an 80 MHz crystal controlled reference, whose phase noise is -165 /Hz at 10 kHz from the carrier.

This high level of performance is the result of the following two basic features :

The signals given by the two frequency sources are then reproduced with slight degradation by the output oscillator. Non-harmonic and subharmonic components are 100 dB below the carrier.

Generation of small frequency steps by an oscillator tunable by varicap diodes covering a small frequency range, the spectrum of which is comparable to a cavity or to a high-Q free-running oscillator.

The 7100 is particularly well suited to selectivity measurements on narrow-band VHF-UHF receivers.

OUTPUT LEVEL

The output level is variable in 1 dB steps from +20 dBm to -139 dBm in LOCAL mode. The single knob control also enables the output level to be varied in 10 dB steps. Constancy of level is within ± 0.5 dB over the entire frequency range.

above 650 MHz. Resolution of 0.1 dB is provided if the 7100 is fitted with the PROGRAMMING option.

When the instrument is fitted with the DOUBLER option, maximum output level is limited to +10 dBm for frequencies

Display is in μ V, mV, or V and dBm/50 ohms on a galvanometer with automatic scale switching. The leakage level of under 3 microvolt, and output circuit protection, enable the instrument to be used for tests on receivers or transceivers.

AMPLITUDE MODULATION

The percentage AM modulation is variable from 0 to 100% with a pass band of -3 dB up to 150 kHz. The percentage modulation remains constant within ± 5 % up to 100 kHz.

modulation is approx 200 mVrms/600 ohms. When the 7100 is fitted with option 004 and 005, the percentage AM modulation can be programmed in 1 % steps, in which case the input signal must be calibrated at 1 Vrms/600 ohms. Depth of modulation is indicated on the front panel galvanometer which has automatic scale switching at approx 30 %, thus increasing the readout accuracy.

The modulation source can be either of two, fixed internal frequency sources or an external source which can be either ac or dc coupled. Input sensitivity for 100 %

VOR-ILS MODULATION

The 7100 has a «VOR» position, which makes the instrument compatible with the requirements applicable to test on short and medium range radio navigation aids (VOR-ILS). This non-optional feature is obtained by lengthening

the time constant of the internal control loops to correspond to the phase shift characteristic required for VOR-ILS, i.e. 0.2° at 30 Hz.

FREQUENCY MODULATION

FM modulation is effected with a maximum peak deviation of ± 3 kHz, ± 30 kHz or ± 300 kHz over the entire frequency range. The modulation source can be either of two internal fixed frequencies or an external source which can be either ac or dc coupled for a pass band of -3 dB up to 150 kHz and input sensitivity of approx 1 Vrms/600 ohms, corresponding to a peak deviation of ± 1 kHz, ± 10 kHz or ± 100 kHz according to the range selected.

options 004 and 005, the FM deviation can be adjusted in steps of 100 Hz, 1 kHz or 10 kHz for the ± 3 kHz ± 30 kHz or ± 300 kHz ranges respectively, the input signal being calibrated at 3 Vrms/600 ohms.

In programmed mode, when the generator is fitted with

Deviation is read on the galvanometer with automatic scale switching at one third of the selected range. FM distortion for modulating frequencies of 400 Hz and 1 kHz is less than 3 % and spurious AM modulation is less than 1 % within the band 1 MHz to 650 MHz.

PHASE MODULATION

The output signal can be phase modulated with a peak deviation variable from 0° to 300°. The choice of modulation source is the same as for FM modulation. The pass band in external mode is limited to 50 kHz and the input sensitivity for 100° deviation is approx 1 Vrms/600

ohms. In programmed mode, when the generator is fitted with options 004 and 005, resolution of Phase modulation deviation is 1° for an input signal calibrated at 3 Vrms/600 ohms.

SELF-CHECKING

This function facilitates generator maintenance, when amfunctions occur, by very quickly locating the faulty sub-assembly. Thereafter, the modular design of the instrument enables the instrument to be brought back into service immediately simply by replacing the faulty module.

This system, which is managed by the microprocessor, checks the main internal levels of the instruments and also the servo loops for the synthesizing circuits. The functional state of the point under test may be read on the FRONT panel display or may be sent out to an external test set if the generator is fitted with the programming options.

OPTIONS

OPTION 001 HF PROTECTION BY FUSE

The internal cartridge fuse protects the instrument's output circuits from reverse HF power up to 50 W.

OPTION 002 HF PROTECTION BY ELECTRONIC CIRCUIT BREAKER

The electronic circuit-breaker is designed to protect the instrument against reverse HF power up to 50 W. The device is tripped at $+ 25$ dBm/50 ohms and remains tripped as long as the reverse signal is higher than the threshold. Thereafter, automatic resetting of the circuit-breaker puts the generator back into its normal operative configuration.

OPTION 003 : FREQUENCY DOUBLER

The internal frequency doubler module expands the output frequency band of the instrument to 1300 MHz, with minimal degradation of the spectral purity characteristics and output level, all other specifications being met and the modulation and direct display calibrations being

undisturbed. Thus the AM accuracy and linearity characteristics are affected by the incorporation of the frequency doubler option, whilst the maximum output level is limited to ± 13 dBm/50 ohms.

OPTION 004 and 005 : IEEE PROGRAMMING

The design of the generator and the use of a microprocessor allow all functions to be programmed to IEEE standard 488 of 1975. Programming is made easy by the use of free format and a «clear language», and is effected by means of two additional options the connection for which is provided at the rear of the instrument. Local display remains operative and enables programs to be checked. An additional outlet supplies, from the ASCII signal, an 8-bit byte which can if required control a peripheral.

Option 004 allows programming of frequency, output level, operating mode and AM, FM and PM modulation source, with an acquisition time of under 100 ms. Option 005 complements 004 by giving frequency resolution down to 1 Hz and moreover allows programming of AM depths and FM and PM deviations. It can only be fitted if option 004 is already fitted.

OPTION 006 : PULSE MODULATION

Addition of this option to the 7100 generator enables the HF output signal to be obtained as a train of pulses, with a width and rise and fall times which are functions of the characteristics of the external modulation signal.

The main features of option 006 are a recurrence frequency which is variable from 10 Hz to 200 kHz, a very short switching time lower than or equal to 20 ns, and an ON/OFF ratio exceeding 100 dB over the range 650 to 1300 MHz.

These performance levels make the device appropriate for application in civil and military radio-navigation, such as position fixing and control and guidance of aircraft.

Furthermore, the possibility of simultaneously modulating the RF signal output is perfectly adapted to special applications such as the TACAN system.

OPTION 010 : EXTENSION OF FREQUENCY TO 100 kHz

In this case, the generator covers the 100 kHz to 650 MHz band, or 100 kHz to 1300 MHz if the instrument is also fitted with the DOUBLER option.

OPTION 011 : SUPPLY FROM 50 to 400 Hz MAINS

This option is intended for export models, and adapts the generator to suit the characteristics of the mains supply.

CHAPTER II TECHNICAL SPECIFICATIONS

7100 B BASIC VERSION

FREQUENCY

Range :

0.3 MHz to 650 MHz in only one band.

Tuning control :

Main Tuning by spin-wheel providing 100 steps variation per turn, with step value selectable between 1 kHz, 10 kHz, 100 kHz and 1 MHz.

Resolution	ΔF per turn
1 kHz	100 kHz
10 kHz	1 MHz
100 kHz	10 MHz
1 MHz	100 MHz

In this case, the 7100 B is a true frequency synthesizer with 1 kHz resolution.

Fine tuning by vernier providing continuous frequency variation between 1 kHz steps.

Fine tuning by external voltage :
 ± 3 kHz frequency variation for ± 3 V.

Step-by-step variation by two push-buttons providing frequency variation in 1 kHz - 10 kHz - 100 kHz - 1 MHz steps and in 12.5 kHz - 20 kHz - 25 kHz - 50 kHz steps corresponding to standard channel spacing.

A constant pressure during 3 seconds on either of these pushbuttons provides an uninterrupted frequency change.

Frequency display :

The output frequency is permanently displayed with 1 kHz resolution on a 6 digits LED display unit (7 digits with Doubler option). When the fine-tuning vernier is used, 3 additional digits provide output frequency display with 1 Hz resolution.

Display accuracy :

Master Oscillator accuracy ± 1 Hz (with vernier).

Frequency stability : Measured at $25^\circ \text{C} \pm 1^\circ$.

Factor	With vernier or DC coupled FM	Without vernier
Time	± 1 Hz per 10 mn after 30 mn of operation with vernier. $\pm 7 \cdot 10^{-9}$ at 500 MHz (vernier stability)	$\pm 2 \cdot 10^{-8}$ per day after 72 hours' continuous operation. $\pm 5 \cdot 10^{-9}$ per day after 3 months' continuous operation.
Mains ($\pm 10\%$)	negligible	negligible
Temperature	± 0.2 Hz/ $^\circ \text{C}$	$\pm 2 \cdot 10^{-10}/^\circ \text{C}$
Output level	negligible	negligible
Output load	negligible	negligible

Master Oscillator phase-locking :

The crystal oscillator can be locked to an external standard through a built-in phase comparator.

Phase-locking display by two LEDs, Master Oscillator frequency adjustment by ten-turn potentiometer.

- Frequency : Any subharmonic of 10 MHz down to 1 MHz.
- Level : 0.2 Vrms to 1 Vrms/50 Ω .
- Master Oscillator output : 10 MHz, approximately 0.5 Vrms/50 Ω .

SPECTRAL PURITY

Measured in CW mode at + 13 dBm/50 Ω output level.

Harmonic signals :

< -30 dBc (-35 dBc typical).

Subharmonic signals : < -100 dBc

Spurious signals :

- Line related spurious :
 - < -50 dBc at 50 Hz or 60 Hz
 - < -60 dBc at 100 Hz or 120 Hz
 - < -70 dBc at 1 kHz.
- Other spurious for 300 kHz to 80 MHz frequency range :
 - < -100 dBc between 15 kHz and 300 MHz from carrier.
 - < -80 dBc beyond 300 MHz from carrier.
- Other spurious for 80 MHz to 650 MHz frequency range :
 - < -100 dBc beyond 15 kHz from carrier.

Phase noise :

- In a 1 Hz bandwidth for a 160 MHz and 560 MHz carrier

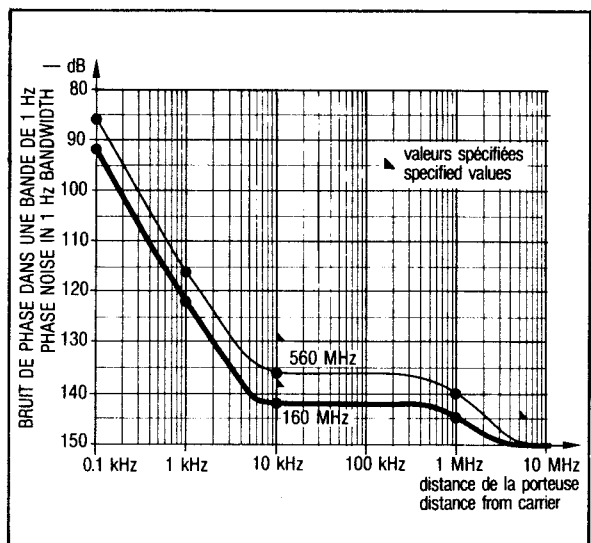

Residual AM :

< 85 dBc in a 300 Hz to 3 kHz bandwidth (CCITT standard) over the entire frequency range.
 < - 80 dBc in a 20 Hz to 15 kHz bandwidth (CCIR standard) over the entire frequency range.

Residual FM :

< 1 Hz in a 300 Hz to 3 kHz bandwidth (CCITT standard) over the entire frequency range.
 < 10 Hz in a 20 Hz to 15 kHz bandwidth (CCIR standard) over the entire frequency range).

Leakage :

(with all the outputs terminated properly) :
 Leakage limits are below those specified in MIL-I-6181 D. Furthermore, less than 3 μ V is induced in a 2-turn, 1-inch diameter loop 1-inch away from any surface and measured into a 50 Ω receiver.

RF OUTPUT

Output level :

+ 20 dBm to - 140 dBm/50 Ω .
 160 dB dynamic range : 10 dB and 1 dB steps by attenuator, - 1.2 dB to + 0.2 dB by vernier.
 Output level display in volts and dBm/50 Ω by LED indicators and calibrated meter.
 Overload indicator.

Output level accuracy

(typical) :

Including attenuator error and flatness.

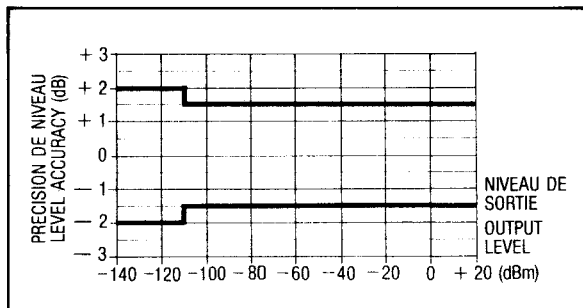

- Output level accuracy at 0 dBm meter display : ± 0.2 dB for à 50 MHz frequency.

Attenuator Accuracy :

- 10 dB steps :

Output level	Accuracy
+ 20 to - 110 dBm	± 1 dB
- 120 to - 130 dBm	± 1.5 dB

- 1 dB steps :
 ± 0.5 dB maximum error for ten 1 dB steps.

Meter accuracy :

3 % of full scale.

Output level flatness :

± 0.5 dB from 1 MHz to 650 MHz (measured at 0 dBm, with respect to 50 MHz).

VSWR :

Measured with 50 Ω load impedance :

Output level	VSWR
+ 20 to + 3 dBm	≤ 2
+ 2 to - 140 dBm	≤ 1.2

AMPLITUDE MODULATION

Modulation depth :

- Adjustable from 0 % to 100 % for up to + 14 dBm/50 Ω output level. Above + 14 dBm average output level, overload indicator lights up if peak level exceeds + 20 dBm.

- AM depth adjustment by vernier, calibrated meter display with automatic scale switching.

Accuracy : up to 90 % modulation signals :

- ± 2 % of full scale.
- ± 5 % of reading.

Internal modulating signals :

- Frequency : 400 Hz or 1000 Hz (Master Oscillator stability).

- The internal modulating signals are available on a rear-panel connector with 2.5 Vrms/600 Ω output level.

External modulating signals :

- AC or DC coupling
- Frequency :

Bandwidth	DC coupling	AC coupling
± 1 dB	0 Hz to 60 kHz	100 Hz to 60 kHz
- 3 dB	0 to 100 kHz	30 Hz to 100 kHz

- Input sensitivity :
 Approximately 2 mVrms/600 Ω for 1 % modulation depth.

- Maximum input level : ± 10 V peak.

AM distortion :

With 1 kHz internal modulating signal, from 1 MHz to 650 MHz.

- 1.2 % from 0 % to 30 %
- 2 % from 30 % to 50 %
- 3 % from 50 % to 80 %

Incidental phase modulation :

0.1 rd for 50 % modulation depth.

VOR-ILS MODULATION

- General characteristics identical to those of AM.

Envelope phase-shift :

0.2° for a 30 Hz modulating signal.

FREQUENCY MODULATION

Frequency deviation :

- Up to 300 kHz deviation in 3 ranges. Automatic scale switching of calibrated meter provides 3 subranges.

Range	Subrange
0 to \pm 3 kHz	0 to \pm 1 kHz
0 to \pm 30 kHz	0 to \pm 10 kHz
0 to \pm 300 kHz	0 to \pm 300 kHz
0 to \pm 300 kHz	0 to \pm 100 kHz

Internal modulating signals :

- Frequency : 400 Hz or 1000 Hz (Master Oscillator Stability).

- The internal modulating signals are available on a rear-panel connector with 2.5 Vrms/600 Ω output level.

External modulating signals :

- AC or DC coupling.

- 3 dB bandwidth

DC coupling : DC to 150 kHz

From 80 MHz to 160 MHz, the maximum FM deviation is reduced according to the figure below for modulating frequencies above 100 kHz.

AC coupling : 30 Hz to 150 kHz

From 80 MHz to 320 MHz, the maximum FM deviation is reduced according to the figure below for modulating frequencies below 100 Hz or above 100 kHz.

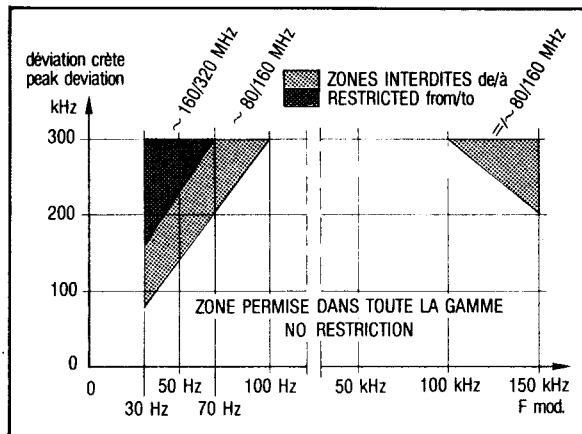

- Input sensitivity :

Approximately 1 Vrms/600 Ω for 1 kHz, 10 kHz or 100 kHz frequency deviation depending on the selected range.

- Maximum input level : \pm peak.

Frequency deviation control :

Adjustment by vernier : calibrated meter display with automatic range switching. In DC coupled external modulation, the center frequency shift can be read on the front-panel frequencymeter.

Display accuracy :

\pm 7 % of full scale.

FM distortion :

For modulating signals up to 20 kHz :
0.5 % up to 30 kHz frequency deviation 1 % up to 100 kHz frequency deviation.

Residual AM :

< 1 % from 10 to 650 MHz for modulating signals up to 20 kHz and 75 kHz deviation.

PHASE MODULATION

Phase deviation :

- Adjustable from 0° to 300° in two subranges.

- Adjustment by vernier calibrated meter display with automatic scale switching.

Display accuracy :

\pm 10 % of full scale.

Internal modulating signals :

- Frequency : 400 Hz or 1000 Hz (Master Oscillator stability).

- The internal modulating signals are available on a rear-panel connector with 2.5 Vrms/600 Ω output level.

External modulation signals :

- AC or DC coupling

- 3 dB bandwidth :

DC coupling : 0 to 50 kHz

AC coupling : 30 Hz to 50 kHz

- Input sensitivity : approximately 1 Vrms/600 Ω for 100° phase deviation.

- Maximum input level : \pm 10 V peak.

SIMULTANEOUS MODULATIONS

Simultaneous AM/FM or AM/ Φ M capability with internal and external modulating signals.

POWER SUPPLY

Voltage : 115 V - 230 V \pm 15 %

Frequency : 50 Hz to 60 Hz.

Power : 100 W.

Mechanical characteristics :

Adaptable to 19" rack.

Height : 132 mm (3 U)

Width : 440 mm

Depth : 452 mm

Temperature range :

Operation : 0° C to + 50° C

Storage : - 20° C to + 70°.

Weight : 23 kg.

OPTIONS 7100 B

REVERSE POWER PROTECTION

001 : FUSE PROTECTION

002 : ELECTRONIC PROTECTION

Output level flatness : measured at 0 dBm, with respect to 50 MHz.

- ± 0.7 dB from 1 to 650 MHz
- ± 1 dB from 1 to 650 MHz with pulse modulation option
- ± 1.5 dB from 650 to 1300 MHz (doubler option).

VSWR (measured with 50 Ω load impedance) :

	output level	VSWR
1 to 650 MHz	+ 20 to + 3 dBm	≤ 2.2
	+ 2 to - 140 dBm	≤ 1.5
650 to 1300 MHz	+ 10 to - 7 dBm	≤ 2.2
	- 8 to - 130 dBm	≤ 1.8

Breaker threshold : ± 25 dBm.

Max reverse power : 50 W.

003 : FREQUENCY DOUBLER

FREQUENCY

Frequency range : 650 to 1300 MHz

Resolution : 1 kHz without vernier
1 Hz with vernier.

Standard channel spacing :
20 kHz, 25 kHz, 50 kHz, 100 kHz.

FUNCTIONAL DESCRIPTION

Harmonic signals : ≤ -25 dBc
(- 30 dBc typical).

Subharmonic signals : ≤ -25 dBc.

Spurious signals : ≤ -94 dBc beyond 15 kHz from carrier.

Phase noise : measured at 1200 MHz in a 1 Hz bandwidth (typical).

Distance from carrier	Phase noise
100 Hz	≤ -80 dBc
1 kHz	≤ -110 dBc
10 kHz	≤ -130 dBc
1 MHz	≤ -134 dBc

- SSB broadband noise floor : < -136 dBc.

Residual AM.

- < -85 dBc in a 300 Hz to 3 kHz bandwidth (CCITT standard) from 650 to 1300 MHz.
- < -80 dBc in a 20 Hz to 15 kHz (CCIR standard) from 650 to 1300 MHz.

Residual FM.

- < 2 Hz in a 300 Hz to 3 kHz bandwidth from 650 to 1300 MHz
- < 20 Hz in a 20 Hz to 15 kHz bandwidth from 650 to 1300 MHz

Leakage : < 10 μ V.

RF OUTPUT

Output level :
+ 10 dBm to - 130 dBm/50 Ω

Attenuation :

140 dB dynamic range : 10 dB and 1 dB steps by attenuator, 1.5 dB by vernier.

Attenuator accuracy (10 dB steps) :

Output level	Accuracy
+ 10 to - 50 dBm	+ 1 dB
- 60 to - 100 dBm	± 1.5 dB
- 110 to - 120 dBm	± 2 dB

Output level flatness :

- measured at 0 dBm with respect to 50 MHz.
- ± 1 dB from 650 to 1300 MHz.
 - ± 1.5 dB with option 001 or 002 (reverse power protection).

VSWR (measured with 50 Ω load impedance) :

output level	VSWR
+ 10 to - 7 dBm	≤ 2
- 8 to - 130 dBm	≤ 1.5

AMPLITUDE MODULATION

Accuracy :

- \pm of full scale
- \pm of reading

AM distortion (measured at + 3 dBm) : < 7 % from 0 to 80 %.

004 : IEEE BUS PROGRAMMING

Frequency :

- Resolution : 500 Hz from 0.3 MHz to 650 MHz : 1 kHz from 650 MHz to 1300 MHz.
- Settling time : 100 ms.

Level :

- Resolution : 0.1 dB
- Settling time : 100 ms

Functional mode :

- CW, AM, FM, OM and inhibition.
- FM deviation range.
- Internal or external modulation.
- AC or DC coupling in external modulation.
- Full range modulation or manual adjustment by potentiometer.

External modulation sensitivity :

- AM : 1 Vrms/600 Ω for 100 % modulation depth.
- FM : 1 Vrms/600 Ω for 1 kHz, 10 kHz or 100 kHz frequency deviation, depending on selected range.
- Φ M : 1 Vrms/600 Ω for 100° phase deviation :

005 : COMPLEMENTARY PROGRAMMING

This option is available only with option 004.

Frequency :

- Resolution : 1 Hz
- Settling time : 100 ms

Modulation :

- AM depth resolution : 1 %
- FM - Φ M resolution : 1/300 of full deviation range.

	Deviation range	Resolution
FM	3 kHz	10 Hz
	30 kHz	100 Hz
	300 kHz	1 kHz
Φ M	300°	1°

- Precision : ± 5 %.

006 : PULSE MODULATION

FREQUENCY

Frequency range :

10 to 650 MHz standard version
10 to 1300 MHz with doubler

MODULATION SIGNALS

Recurrent frequency :

- 10 Hz to 200 kHz flatness unaltered.
- 200 kHz to 2.5 MHz flatness drop by 1 dB

Mode : external with rear input

Impedance : 600 Ω (dc coupling).

Pulse length : 0.2 μ min.

Pulse level : 0 to 4 V min. (transmission threshold at 0.4 and 3.15 V).

MODULATED SIGNAL

Rise/fall time : as a fonction of the modulating pulse, with a minimum rise time of 20 ns (typical) and fall time of 30 ns (typical).

ON/OFF RATIO :

Frequency	Specified	Typical
10 to 200 MHz	70 dB	75 dB
200 to 500 MHz	60 dB	65 dB
500 to 650 MHz	55 dB	60 dB
650 to 1300 MHz	90 dB	100 dB

Response time of the levelling loop : < 2 s

Flatness :

- ± 0.7 dB from 10 to 650 MHz
- ± 1 dB from 650 to 1300 MHz

MODULATION COMPATIBILITY :

AM/FM/PULSE
AM/OM/PULSE
PULSE/AM or FM or OM.

010 : EXTENSION TO 100 kHz

011 : 50 Hz to 400 Hz POWER SUPPLY

The incorporation of these options has led to the design of a ventilator cooled power supply enhancing the overall reliability of the instrument.

CHAPTER III OPERATION

PREPARING FOR USE

This section provides information on the electrical installation of the instrument, in ambient conditions, and on fitting the 7100 generator to a 19-inch rack.

GOODS INWARDS RECEPTION

The instrument is delivered in a cardboard packing, protection being ensured by a process of injecting expanded polyurethane foam. The package contains the instrument as described on the delivery note, together with its mains cable.

As the warranty covers accidents caused on shipment from ADRET ELECTRONIQUE, check that the equipment has no mechanical fault caused during its shipment.

GENERATOR IDENTIFICATION

A label riveted to the rear panel gives the manufacturing references for the 7100, and also the code number of any fitted options. Figure 3-1 gives the meaning of each of the stamped numbers.

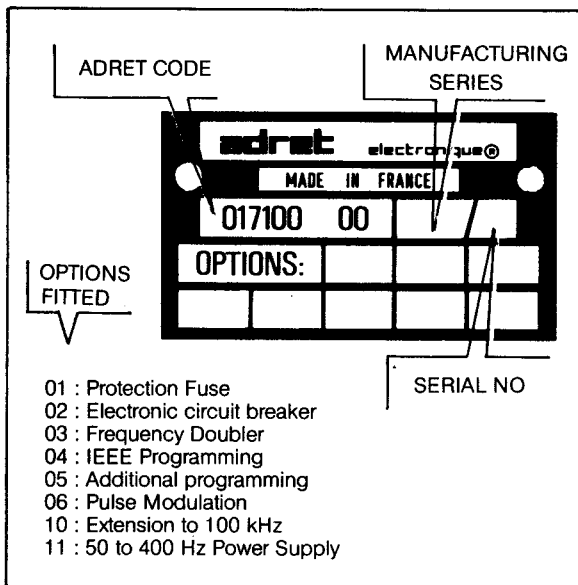

Fig. III-1 Generator Identification

CONNECTION TO MAINS

Generator 7100 is designed for running from the mains at a voltage of 115 or 230 Vrms $\pm 15\%$, with frequency between 50 and 60 Hz. The power consumption is 140 VA maximum (100 W).

The instrument as supplied is set for working from 230 Vrms, input circuit protection being ensured by a «slow blow» 1 ampere fuse. Connection is effected via the 3 pin outlet on the «Mains filter and selector» box, which also contains the supply voltage selection circuit and the fuse. This set-up ensures perfect security, since access

to these elements is possible only if mains cable is disconnected from the generator.

If the supply input to the instrument is incorrect for mains voltage, follow the instructions in figure 3-2, which gives the sequence of operations required to bring the two into agreement.

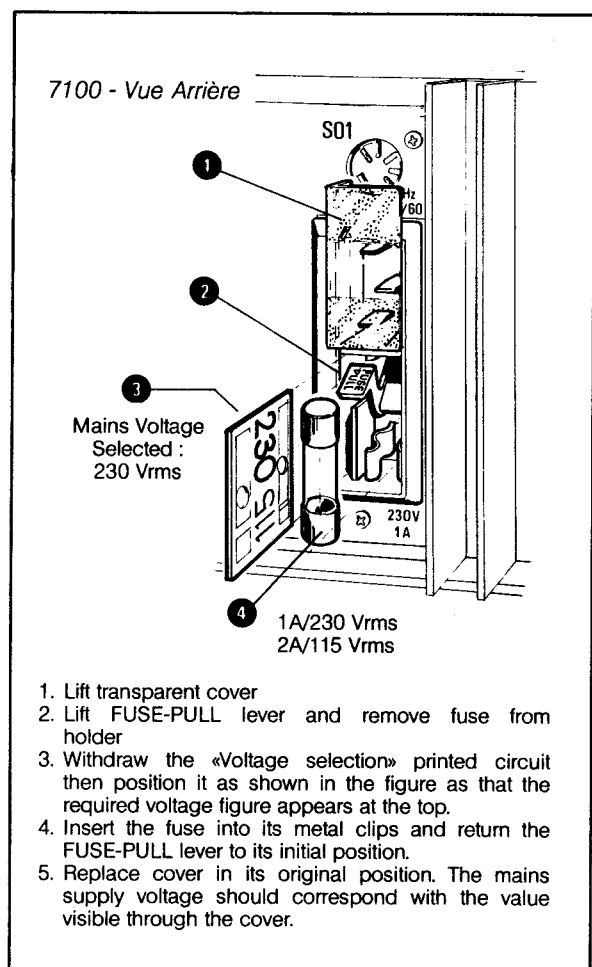

Fig. III-2 Adapting the Generator to the mains voltage

ENVIRONMENT

The technical specification for the generator is applicable when the instrument is used under ambient temperature conditions between 0° and 50° C. Temperature rise during working is minimised by forced ventilation, with air circulation through holes in the side panels.

Furthermore, the light-alloy mechanical construction ensures good dissipation of the heat generated by internal circuits thus limiting the temperature rise of components.

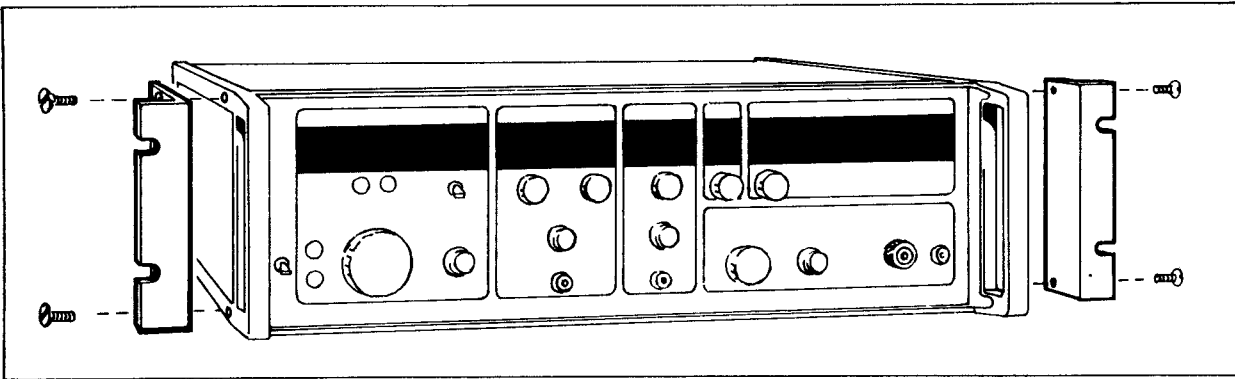

Fig. 3-3 : Mounting of the 7100 in 19-inch rack

STORAGE

The equipment must be stored within temperature limits of -20° to $+70^{\circ}$ C, in non-humid locations.

MOUNTING IN 19-inch RACK

Two 3U adaptors, supplied on request, enable the generator to be mounted in a 19-inch rack. Two metal

brackets, ADRET reference 03800064, are fitted as shown in figure 3-3 at the sides of the instrument, and are secured by four countersunk-head screws.

FUNCTIONAL DESCRIPTION

This section describes the function of all the generator controls, and also the procedure for setting the frequency, the output level, and the different types of modulation.

The first part deals essentially with the basic version, and gives all the information relating to the description of front and rear panels, to preliminary checks, and to setting of parameters in the range 300 kHz to 650 MHz.

The second part relates more particularly to the description and operation of the options which may be fitted to the instrument.

The section Equipment in Use consists of the following items :

7100 Basic version

- Description of front and rear panels.
- Preliminary checks : page III - 4
 These checks are limited to observing the proper

functioning of local setting and selection controls.

- Selection of frequency and output level, page III-5
- Setting of AM, FM, and PM modulations page III-6
- Control of internal master oscillator by an external reference source page III-7

7100 Together with options

- Description of controls, page III-10
- Choice of options and corresponding adjustments, page III-
- Output circuit protection by fuse or electronic circuit breaker (option 001 or 002).
- Extension of frequency range to 100 kHz to 1300 MHz (Options 003 and 010).
- Pulse modulation for applications to civil military radio-navigation (option 006).
- Automation of control through IEEE programming facility (options 004 and 005)

7100 BASIC VERSION

DESCRIPTION OF FRONT PANEL

Open out page III-8 to locate the controls described or used in the following paragraphs.

① DISPLAY OF STEPS FROM 10^0 to 10^8 Hz

Frequency up to 650 MHz is shown on a 9 digit LED display.
 Resolution is 1 kHz, 10 kHz, 100 kHz or 1 MHz without the VERNIER and 1 Hz with the VERNIER (accuracy μ 1 digit)

In frequency modulation with dc coupling, the carrier frequency shift introduced by injection of dc is shown on the display. The display is also used for verification of

the main levels within the instrument during SELF-CHECK: the digits corresponding to steps 10^0 to 10^2 Hz are used for this purpose.

- The two right-hand digits (10^0 and 10^1 Hz) display the number of the test point being checked (0 to 10)
- The third digit (10^2 Hz) indicates "test OK"

② FREQUENCY OR PHASE MODULATION

Modulating source selector switch
 0 : Modulation disabled
 INT : Modulation by internal source
 0.4 k : 400 Hz

1 k : 1 kHz

EXT : Modulation by external source

⌚ : with ac coupling

≡ : with dc coupling

The selected modulating source is shown by a red LED indicator.

3 FREQUENCY OR PHASE MODULATION

Phase or Frequency deviation selector switch

PM (300°) : peak phase deviation variable up to 300°

FM (3 k, 30 k or 300 k) : peak frequency deviation up to μ 3 kHz, μ 30 kHz or μ 300 kHz.

The selected phase or frequency deviation is shown by a red LED indicator.

4 AMPLITUDE MODULATION

Modulating source selector switch

0 : Modulation disabled

INT : Modulation by internal source

0.4 k : 400 Hz

1 k : 1 kHz

EXT : Modulation by external source

⌚ : with ac coupling (FAM > 30 Hz)

≡ : with dc coupling

VOR: VOR modulation is a special case of AM modulation which specifies LF/envelope phase shift of less than 0.2° at 30 Hz modulating signal.

The selected modulating source is shown by a red LED indicator.

5 OPERATING MODE : Switch for selecting operating mode.

0 : Output signal disabled (level < - 140 dBm)

CW : Output signal as pure continuous wave

MOD : Output signal modulated

The selected operating mode is shown by a red LED indicator.

6 SWITCH FOR SELECTION OF PARAMETER

to be read on galvanometer :

FM : Frequency or Phase deviation

AM : Amplitude modulation depth.

RF : Output level

The selected readout mode is shown by a red LED indicator.

7 GALVANOMETER READ-OUT SCALE

INDICATORS as a function of automatic switching between upper and central scales.

1 : Read-out on upper scale (0 to 1.0)

0.3 : Read-out on central scale (0 to 3).

The read-out scale applicable is shown by a red LED indicator.

8 READ-OUT GALVANOMETER with automatic switching between upper and central scales.

LEVEL : 2 scales, viz. 0 to 1.0 and 0 to 3, allow the level to be read out in μ V, mV or V/50 ohms according to the level range in use. The lower scale — 10 to + 3 shows corresponding values in dBm/50 ohms (0 dBm/50 ohms is equal to 224 mVrms/50 ohms).

AM : The modulation percentage is shown on the two upper scales, which are switched automatically at about 30 %.

Scale 0 to 3 : AM percentage 0 to 30 % ;

Scale 0 to 1.0 : AM percentage 30 to 100 %.

FM-PM : Frequency or phase deviation is displayed on the two upper scales, which are automatically switched at 1/3 of the selected maximum peak deviation.

Scale 0 to 1.0 :

deviation 0 to 1 kHz, 0 to 10 kHz, 0 to 100 kHz or 0 to 100°

Scale 0 to 3 :

deviation 1 to 3 kHz, 10 to 30 kHz, 100 to 300 kHz or 100 to 300°.

9 OVERLOAD INDICATOR

This indicates that the maximum permitted peak power is being exceeded

- 20 dBm in CW mode

- 14 dBm in AM for 100 % modulation

10 LEVEL RANGE INDICATORS

These show the level range set by the control knob

The various ranges are expressed in μ V, mV and V in a 1-3-10 sequence and in dBm in steps of 10 dB (0.1 μ V to 3 V and — 130 to + 20 dBm)

11 EARTH SOCKET for connecting the instrument frame to an external earth.

12 RF OUTPUT on type N female connector, with 50 ohms source impedance.

13 VERNIER for fine adjustment of output level (1.5 db)

14 OUTPUT LEVEL CONTROL in steps of 1 dB or 10 dB over the full dynamic range. Steps of 10 dB are brought about by pushing the knob in and turning it.

15 EXTERNAL AM modulating signal input

- Pass band at — 3 dB (typical value) :

- 0 to 100 kHz with DC coupling

- 30 Hz to 100 kHz with AC coupling

- Specified pass band at μ 1 dB

- 0 to 60 kHz with DC coupling

- 100 Hz to 60 kHz with AC Coupling

- Input impedance 600 ohms.

- Sensitivity about 2 mVrms for 1 % depth of modulation (200 mVrms for 100 %).

- Maximum permissible input level μ 10 V peak : if exceeded, the downline circuit may be damaged.

16 SETTING OF AM DEPTH OF MODULATION

17 EXTERNAL FM OR PM modulating signal input :

- Pass band at — 3 dB

- FM : 0 to 150 kHz with DC coupling

- PM : 0 to 50 kHz with DC coupling

- FM : 30 Hz to 150 kHz with AC coupling

- PM : 30 Hz to 50 kHz with AC coupling

- Input impedance 600 ohms

Sensitivity :

- 1 Vrms for 1 kHz, 10 kHz or 100 kHz FM deviation, according to range selected.

- 1 Vrms for 100° in PM

- Maximum permissible input level μ 10 V peak : if exceeded, the downline circuit may be damaged.

18 SETTING OF FM OR PM DEVIATION

19 VERNIER for fine frequency adjustment provides variation of approx. — 500 Hz to + 1500 Hz : the value is multiplied by a factor of 10 or 100 in FM with dc coupling in the 30 kHz and 300 kHz ranges

20 VERNIER VALIDATION SWITCH

0 : Disable vernier

VERNIER : validation

21 FREQUENCY CONTROL KNOB

Optical encoding wheel enables incrementation or decrementation by 100 steps per revolution

22 «STEP-BY-STEP» CONTROL of frequency in steps equal either to one of the four possible resolutions or to one of the frequency jumps corresponding to standard channel spacing

+ : the selected step is added to the output frequency :
 — : the selected step is subtracted from the output frequency.

Holding down one of these push buttons for a few seconds produces a frequency sweep by repetition of the step (about 7 steps per second).

23 SWITCHING ON THE INSTRUMENT

«ON»: instrument ready for operation.
 «STANDBY»: instrument functions on standby. The master oscillator alone is supplied.

24 SELECTOR KNOBS FOR RESOLUTION STEP OR STANDARD CHANNEL SPACING STEP

- Resolution : 1 kHz, 10 kHz, 100 kHz, 1 MHz
- Channel Step : 12.5 kHz, 20 kHz, 25 kHz, 50 kHz

The central «0» position inhibits the action of the frequency control knob

25 PROGRAMMED MODE DISPLAY

DESCRIPTION OF REAR PANEL

26 INPUT 1-2-5 or 10 MHz

Control of internal master oscillator by an external reference, the level of which lies between 0.2 and 1 Vrms into 50 ohms.

27 CONTROL OF MASTER OSCILLATOR

10 turn potentiometer adjustment and indicators for displaying external control.

28 SUPPLY FOR PERIPHERALS : 5-pin connector supplying + 12 V and — 12 V DC (Current 50 mA).

29 CONNECTIONS TO MAINS with incorporated fuse and mains voltage selector.

- Input level : 115 Vrms or 230 Vrms \pm 15 %
- Frequency : 50 Hz to 60 Hz.

30 400 Hz OUTPUT internal modulating signal derived from the QUARTZ-CONTROLLED MASTER OSCILLATOR

- Output level : 2.5 Vrms/600 ohms

31 \pm 3 V/ \pm 3 kHz INPUT

External analogue control of output frequency — acts on the vernier

32 10 MHz REFERENCE OUTPUT : derived from the QUARTZ-CONTROLLED MASTER OSCILLATOR and supplied at a fixed level of 0.5 Vrms/50 ohms

33 1 kHz OUTPUT : internal modulating signal derived from the QUARTZ-CONTROLLED MASTER OSCILLATOR

- Output level : 2.5 Vrms/600 ohms

PRELIMINARY CHECKS

a) Set switch **23** to STANDBY and connect the instrument to the mains. All controls are disabled and only the STANDBY indicator is lit.

PUTTING INTO OPERATION

b) Light the ON indicator with switch **23**. Display **1** shows 300 MHz, indicator **10** is lit to show range — 140 dBm and frequency resolution is 1 MHz

c) Vary frequency with knob **21**, level range by pushing in and rotating knob **14** and resolution by push buttons **24**

FREQUENCY

d) Press buttons **24** and check that the indicators corresponding to resolution steps and standard channel spacings light up in sequence.

e) Light the 1 K indicator then press the right-hand push button **24**. The central «0» indicator lights. Repeat the same operation with the 50 k indicator and the left-hand push button.

f) Check on display **1**, using push buttons **24** and knob **21** that the displayed frequency cannot go below 250 kHz or above 649.999 MHz in the direct range, or

1299.999 MHz if the instrument is fitted with the doubler option.

g) Select the 1 MHz resolution step by means of push buttons **24** and press push buttons. The displayed frequency varies in 1 MHz steps : continuous variation can be obtained by keeping the buttons pressed (7 steps/second)

h) Set switch **20** to VERNIER, then check that potentiometer **19** can vary the frequency by approximately — 500 Hz to + 1500 Hz

OUTPUT LEVEL

i) Light the RF indicator by operating switch **6**

j) Press and turn switch **14** and check that :
 indicators light up in succession
 • galvanometer **8** scales switch over automatically **7**
 • indicators **10** light up in succession

k) Operate VERNIER **13**. Level variation is \pm 1.5 dB. Set vernier to its right-hand stop.

l) Operate switch **14** to light the + 20 dBm indicator **10** and set the galvanometer pointer to «0» on the lower.

m) Increase the level using vernier **13** and check that indicator **9** lights up.

AMPLITUDE MODULATION

- n) Operate switch 4 and check that the indicators above it light up in sequence. Switch on the 1 K indicator.
- o) Light the «MOD» and «AM» indicators by operating switches 5 and 6
- p) Set potentiometer 16 to its left-hand stop, then turn it clockwise while checking that galvanometer 8 scales 7 switch over (apart from hysteresis effects) on graduation 3 on the central scale.
When this occurs, the pointer should be at graduation 0.3 on the upper scale.
- q) Light the «RF» and «CW» indicators by operating switches 6 and 5
- r) Light the + 20 dBm indicator 10 by pushing and turning switch 15. Release the switch and turn it to set the pointer of the galvanometer to graduation «-6» on the lower scale (use the VERNIER 13 to make the final adjustment.

s) Operate switches 6 and 5 to light the «AM» and «MOD» indicators. Using potentiometer 16 position the galvanometer pointer on graduation «1.0» of the upper scale.

t) Turn potentiometer 16 in the clockwise direction. Indicator 9 must light up.

FREQUENCY OR PHASE MODULATION

u) Operate switches 2 and 3 and check that the indicators above them light up. Switch on the «1 k» and «30 k» indicators.

v) Light up the «MOD» and «FM» indicators by operating switches 5 and 6

w) Operate potentiometer 18 and check that the automatic switching of galvanometer scales 7 takes place (apart from hysteresis effects) at the «1.0» graduation on the upper scale. The pointer must be at 1 on the central scale.

DESCRIPTION OF THE USE FREQUENCY AND LEVEL DISPLAY

FREQUENCY

- a) Select the resolution step of 1 kHz, 10 kHz, 100 kHz or 1 MHz using pushbuttons 24 in both direct range and doubled range.
- b) Operate knob 21 until the required frequency is shown on the display 1. This same knob can be used to increment or decrement frequency by 100 steps per revolution. The following table shows, for each of the possible resolution steps, the number of turns required to cover the entire frequency range of the instrument (with and without the DOUBLER option).

Resolution	Without doubler	With doubler
1 kHz	6500 turns	13000 turns
10 kHz	650 turns	1300 turns
100 kHz	65 turns	130 turns
1 MHz	6.5 turns	13 turns

c) Set switch 20 to «VERNIER» and operate potentiometer 19 to set up the required hundreds, tens and units of hertz on the display 1

The vernier provides frequency variation of approximately + 1500 Hz to - 500 Hz in direct range or doubled range.

d) To change the output frequency, follow the procedure described above using the push buttons 22 in frequency steps determined by pushbutton 24. The frequency step can be equal to one of the 4 RESOLUTION steps (1 kHz, 10 kHz, 100 kHz or 1 MHz) or to one of the 4 standard CHANNEL spacing steps (12.5 kHz, 20 kHz, 25 kHz or 50 kHz).

Selecting one of the four steps 12.5 kHz, 20 kHz, 25 kHz or 50 kHz automatically invalidates the action of the knob 21. On the other hand, if the 12.5 kHz step is selected, the hundreds of hertz so introduced (500 Hz) are permanently shown on the display.

e) Continuous variation in steps of frequency (7 steps per second) can be obtained by keeping one of the push buttons 22 pressed.

f) After obtaining the working frequency, the effect of push buttons 21 and 22 can be inhibited by lighting the central «O» indicator using push buttons 24

LEVEL

a) Operate switch 5 to light the CW indicator.

b) Operate switch 6 to light the RF indicator.

c) Press and turn switch 14 to light indicator 10 corresponding to the level range required (the ranges in a 1-3-10 progression are indicated on the front panel in μV , mV, V and dBm).

Pushing then turning switch 14 provides an output level variation in steps of 10 dB.

d) Release switch 14 then turn it until the required level is shown on the galvanometer 8: this time the variation is in steps of 1 dB.

The output level may be set in 1 dB steps over a dynamic range of 160 dB. In this case, and especially so that threshold measurements can be made, range switching 10 is different according to direction. After centering the VERNIER 13 progression in 1 dB steps from - 140 to + 20 dBm is indicated on the lower scale by the pointer moving from - 6 to + 3 between range changes. In the case of reduction of level from + 20 to - 140 dBm, the 1 dB steps are shown by the pointer moving from + 2 to - 7 on the lower scale between range changes (hysteresis).

For measurements where the best wide band signal to noise ratio is necessary (measurement of selectivity and interference), it should be noted that the quoted specification varies by 2 to 3 dB according to the position of the 1 dB step attenuator. In general, the best performance is obtained when the output level is defined using graduations to the right of the «0 dBm» on the galvanometer (positions + 1, + 2 and + 3 on the lower scale). It is therefore appropriate, particularly for this type of measu-

rement, to avoid using the graduations — 7 to + 2 or — 7 to + 3 passing through the hysteresis effect (a 10 dB step).

e) Read the level on the galvanometer **8** in μV , mV or V, according to the range selected, on the scale shown by indicator **7**, or in dBm on the lower scale.

f) Use the VERNIER **13** to make fine adjustment (1.5 dB). The output signal is available at the «N-type» connector **12** at an impedance of 50 ohms. The «OVERLOAD» indicator **9** shows when the maximum permissible peak output power is exceeded (+ 20 dBm in direct range)

g) Light the «0» indicator by operating switch **5** in order to inhibit the output signal level (— 140 dBm).

CENTERING THE LEVEL VERNIER

a) Set the VERNIER **13** to its right-hand stop.

b) Select the + 20 dBm range using knob **14**, then progress in 1 dB steps until the maximum level is displayed.

c) Use the VERNIER **13** to position the galvanometer pointer on graduation 3 on the lower scale. The output level is now + 23 dBm and corresponds to the maximum level obtained by operating knob **14** (steps of 10 dB and 1 dB)

d) Bring the level back to + 20 dBm and check that the VERNIER provides sufficient variation to bring the level down to + 19 dBm.

SELECTION OF AM-FM AND PHASE MODULATION

AMPLITUDE MODULATION

a) Operate switch **5** to light up the red MOD indicator.

b) Operate switch **6** to light up the AM indicator.

c) Select the modulating source with switch **4**

INTERNAL MODE

d) In INTERNAL mode, the modulating source can be either of two fixed frequencies, 400 Hz and 1 kHz, derived from the quartz controlled master oscillator.

*The 400 Hz and 1 kHz frequencies used as internal modulating sources are brought out on connectors **33** and **30** on the REAR panel. The source impedance is 600 ohms and the fixed output level is 2.5 Vrms.*

EXTERNAL MODE

e) In EXTERNAL mode, the modulating signal can be ac or dc coupled into the instrument where specific adaptation to the test requirements of radio-navigation systems (VOR-ILS) is necessary.

f) Connect the modulating signal to connector **15** which has an input impedance of 600 ohms. A minimum input level of 200 mVrms is necessary to obtain 100 % modulation. The maximum input sensitivity is approx 2 mVrms per %.

the "m 10 V max" label near the input connector shows the maximum input voltage that can be used without damaging the input circuit.

g) Adjust the percentage modulation using the potentiometer **16** and the galvanometer **8**

h) Take the corresponding reading on the scale indicated by indicator **7**, automatic switching should occur at about 30 % (apart from hysteresis)

i) Reduce the percentage modulation or lower the output level as soon as the OVERLOAD indicator **9** lights. Output level cannot be greater than + 14 dBm at 100 % modulation.

j) To suppress amplitude modulation, light the «0» or «CW» indicator by operating switch **4** or **5**.

k) To inhibit the output signal, light the «0» indicator using switch **5**

FREQUENCY OR PHASE MODULATION

a) Light the red MOD indicator using switch **6**

b) Light the FM indicator by operating switch **6**

c) Use switch **2** to select the modulating source

d) In INTERNAL MODE, the modulating source can be either of two fixed frequencies, 400 Hz and 1 kHz derived from the quartz-controlled master oscillator

*The 400 Hz and 1 kHz frequencies used as internal modulating sources are available at connectors **30** and **33** on the REAR panel. The source impedance is 600 ohms and the fixed output level is 2.5 Vrms.*

e) In EXTERNAL MODE, the phase or frequency modulating signal is dc or ac coupled into the instrument *In the case of frequency modulation with dc coupling, the frequency shift in the carrier caused by the input dc component is taken into account in the frequency meter readout. Resolution is :*

- 1 Hz for the m 3 kHz range
- 10 Hz for the \pm 30 kHz range
- 100 Hz for the \pm 300 kHz range

If the modulation rate is higher than 30 Hz, the display corresponds to the average value or fluctuates by averaging the instantaneous frequency over a period of 0.25 second.

f) Use switch **3** to select peak FM deviation or Phase Modulation deviation (\pm 3 kHz, \pm 30 kHz, \pm 300 kHz or 300°).

g) Connect the modulating signal to connector **17** which has input impedance of 600 ohms. Maximum FM peak deviation or total phase deviation requires a minimum input level of 3 Vrms (4.29 V peak). The input sensitivity is 1 Vrms for a deviation of 1 kHz, 10 kHz, 100 kHz or 100° according to range.

The "± 10 Vmax" label near the input connector shows the maximum input value that can be used without damaging the input circuit.

h) Adjust frequency or phase deviation using the potentiometer **18** and the galvanometer.

i) Take the corresponding reading on the scale validated by indicator 7. Automatic switching occurs at 1 kHz, 10 kHz, 100 kHz or 100°

j) To suppress frequency or phase modulation, light the «O» or «CW» indicator by operating switch 2 or 5

SIMULTANEOUS MODULATION

The instrument allows simultaneous AM-FM or AM-phase Modulation without mode restriction using the procedures described above.

The internal 400 Hz and 1 kHz modulating frequencies may be used for either or both modulations.

CONTROL OF INTERNAL MASTER OSCILLATOR

a) Apply the 1-2-5 or 10 MHz reference signal to connector 26. The level of the reference signal must be between 0.2 and 1 Vrms/50 ohms.

b) Release the potentiometer 27 and turn it until the two indicators on the left just turn off. This phase locks the internal MASTER OSCILLATOR to the external reference which thus confers its own stability on the instrument.

c) Lock the potentiometer 27

The frequency output of the internal MASTER OSCILLA-

TOR is available at connector 32 at a level of 0.5 Vrms/50 ohms.

The accuracy of the external control source must be better than $\pm 1 \times 10^{-6}$. If this is not so, the internal master oscillator can lock onto the external source at a frequency which is too far from the nominal value. However, the high spectral purity oscillator cannot follow this frequency and therefore frequency instability occurs which is shown by a flashing minus (—) sign on the display 1

SELF-TEST

Enabling the self-test facility verifies the internal operation of the generator by checking the level at 11 test points, and localizes a fault when the instrument is in trouble.

Refer to the chapter V, page V-7. for the using of this function.

DESCRIPTION OF CONTROLS APPLICABLE TO OPTIONS

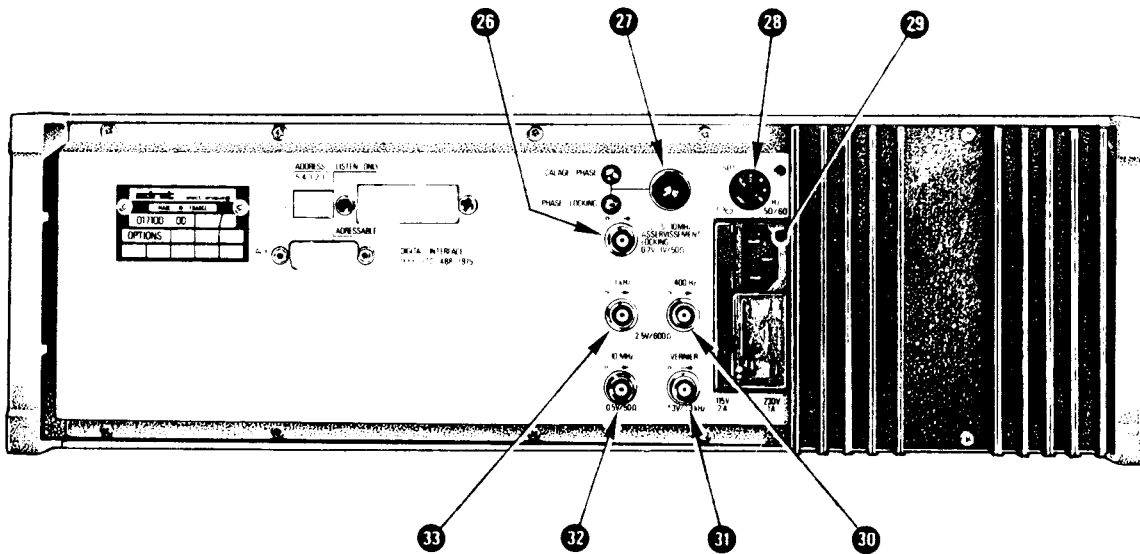
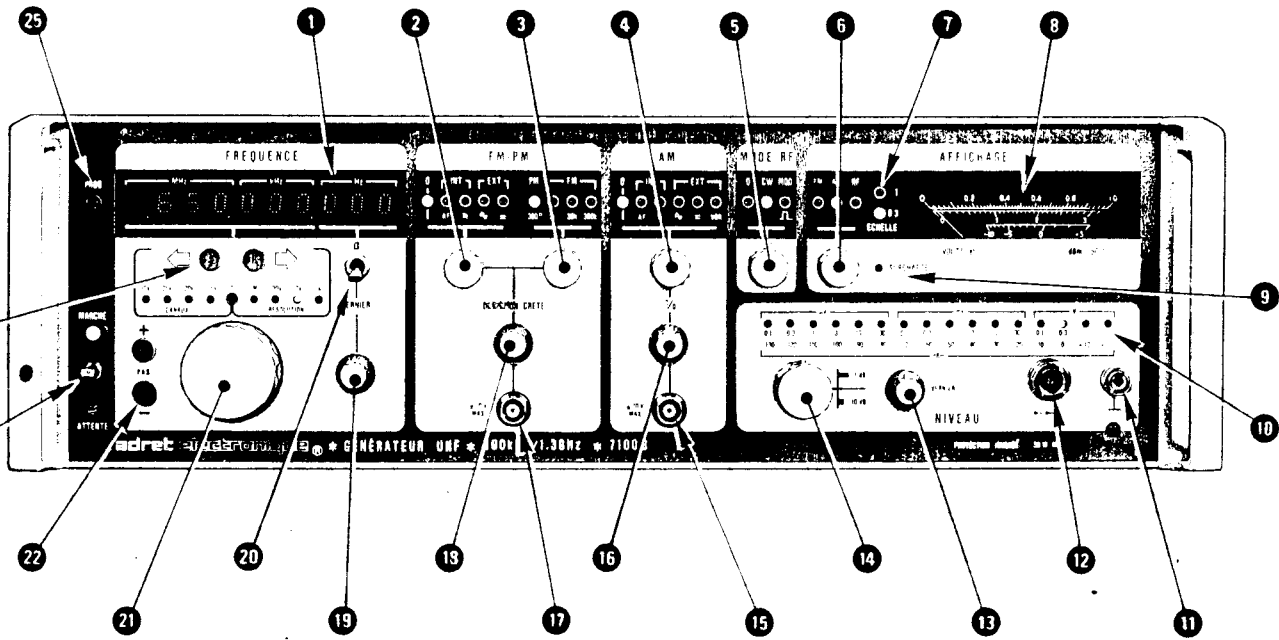

DESCRIPTION OF CONTROLS APPLICABLE TO OPTIONS

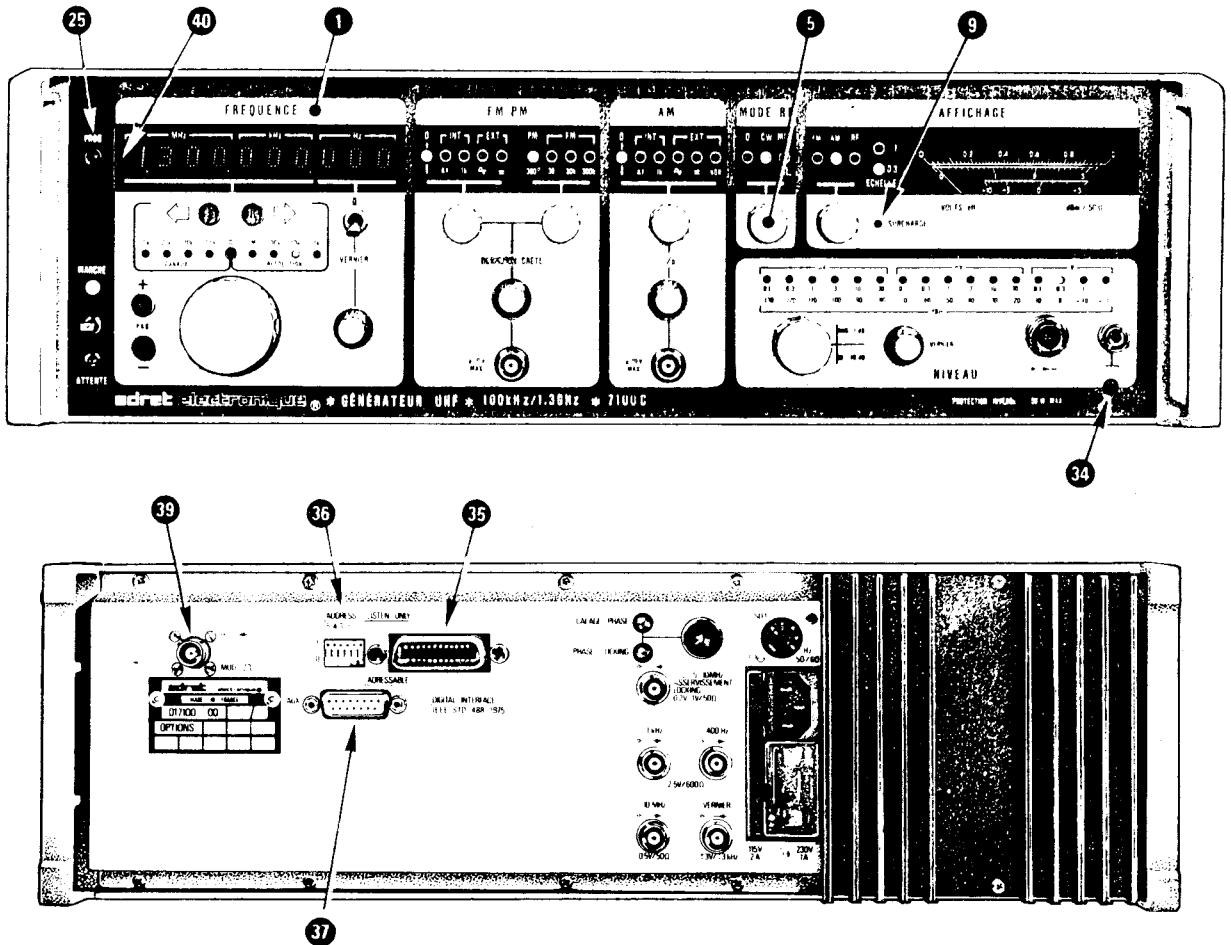

OPTION 002 - ELECTRONIC CIRCUIT BREAKER

34 **CIRCUIT BREAK ALARME** which indicates that the reverse HF power protection circuit has been activated.

OPTION 003 - FREQUENCY DOUBLER

1 **DIRECT DISPLAY** of output frequency. 1 Hz resolution is possible using the vernier.

9 **OVERLOAD INDICATOR** showing that the maximum allowable peak power has been exceeded (+ 10 dBm from 650 to 1300 MHz).

OPTION 004 AND 005 IEEE PROGRAMMING

35 **24-PIN CONNECTOR** for connection to IEEE bus (IEEE standard 488, 1975)

36 **ADDRESSING THE 7100** by a number between 0 and 30 selected in binary code by 5 switches (1-2-3-4-5). This identification number is taken into account when the 6th switch LISTEN ONLY/ADRESSABLE is in the «0» (bottom) position. In the LISTEN ONLY position (1 or top), the 7100 indiscriminately accepts all data supplied by the controller.

37 **15-PIN CONNECTOR** intended for programming peripheral circuits. Output of one 8-bit byte corresponding to a programmed decimal number between 00 and 99.

Output level :

«0» : 0.45 V maximum

maximum current absorbed + 8 mA

«1» : 2.4 V minimum

maximum current supplied — 2.6 mA

25 **PROGRAMMED MODE INDICATOR**

OPTION 006 - PULSE MODULATION

5 **ENABLEMENT OF OPERATING MODE**, by setting the switch to the extreme right position. The «MOD» indicator turns green to indicate that this mode has been selected.

39 **CONTROL PULSE INPUT** to an impedance of 600 ohms. The pulse repetition frequency varies from 10 Hz to 200 kHz for an unvarying constant pulse height of 4 V minimum.

OPTION 010 - EXTENSION OF FREQUENCY TO 100 kHz

40 **PERMANENT LIGHTING OF MINUS SIGN (-)** when the output frequency is below 300 kHz. This indication warns the user of the degradation of some specifications.

NOTE : The fitting of the PROTECTION FUSE option (001) and FREQUENCY DOUBLER option (003) does not affect the generator controls in any way.

THE 7100 SUPPLEMENTED BY ITS OPTIONS

Eight options may supplement the generator to produce the configuration that is most appropriate to the application envisaged. All options are perfectly compatible among themselves, and their addition requires (for some of them) the addition

of further controls to the front and rear faces of the instrument. Pages III-27 and III-28 give the description and location of these controls, and enable them to be identified in conjunction with the following pages.

OUTPUT CIRCUIT PROTECTION

OPTION 001 ULTRA-RAPID FUSE (Calibrated at 200 mA)

This option does not require any modification of internal circuits : controls and adjustments remain unchanged. However the constancy of level and the standing wave ratio are slightly affected.

OPTION 002 - ELECTRONIC CIRCUIT BREAKER

As in the case of the FUSE option, the controls and adjustments remain unchanged. The electronic device protects against any reverse HF power up to 50 Watts, and is set to trip at + 25 dBm. If the spurious reverse signal level exceeds the trigger threshold, the circuit breaker isolates the attenuator and the

output amplifier. A red indicator **34** on the front panel, acting as visual alarm, lights up to warn the user of a temporary stoppage of the generator functions.

The malfunction is also detected by the microprocessor, which causes flashing of the (—) sign on display **1** to show that the fault has been noted. In the remote mode, when the instrument is fitted with the programming options, an interrupt signal SRQ is sent to the computer to halt the running program. As soon as the cause of the circuit break disappears, the protection device resets automatically, enabling the generator to revert to normal operating conditions. The alarm indicator **34** switches off and the flashing display disappears.

N.B. Triggering of the circuit breaker may occur if the generator output is not loaded (VSWR).

EXTENSION OF FREQUENCY RANGE

OPTION 003 - EXTENSION TO 1300 MHz

Settings for frequency, output level and modulation types remain the same as for the basic version. However, use of the double range which is automatically switched does limit the maximum output level to + 13 dBm/50 ohms, and prohibits the use of the 12.5 kHz step which corresponds to the spacing of one of the standard channel steps.

OPTION 010 - EXTENSION TO 100 kHz

The lower limit of the instrument's frequency band is brought down to 100 kHz, but a minus sign (—) appears permanently on the display as a reminder that some characteristics are changed when the output frequency is less than 300 kHz.

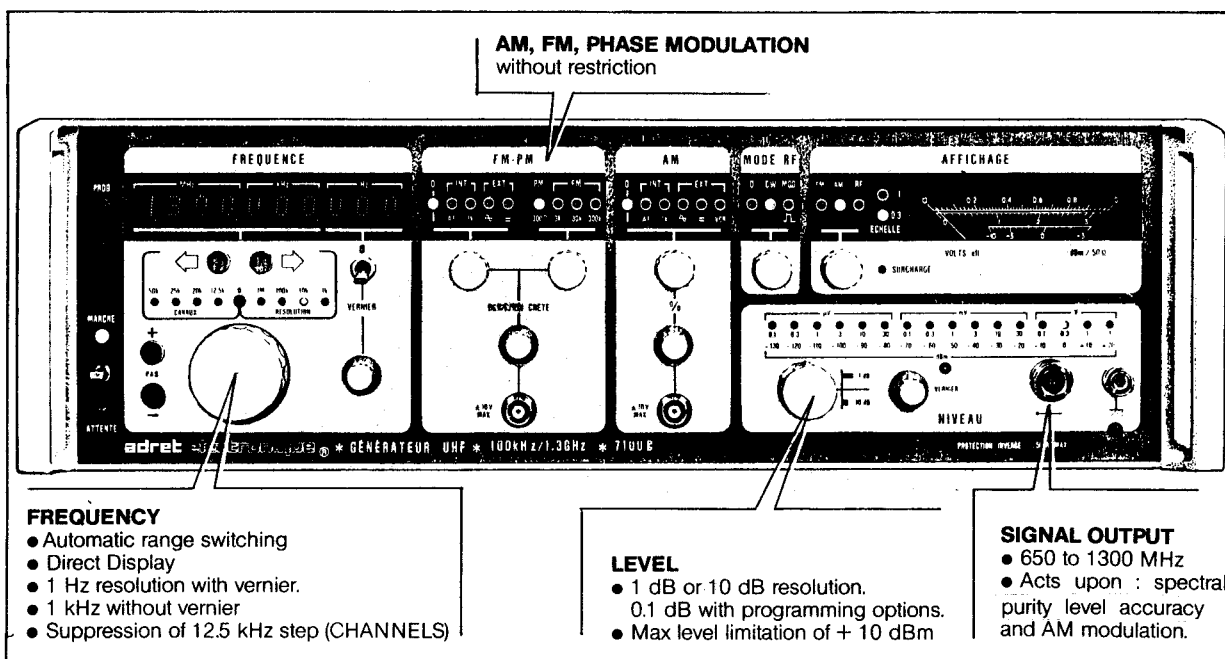

APPLICATIONS TO CIVIL AND MILITARY RADIO-NAVIGATION

OPTION 006 - PULSE MODULATION

The pulse modulator allows the generation of HF pulses of adjustable width and rise and fall times under control of a suitable signal.

The principle adopted leaves the instrument with its full potential in respect of level setting and quality of control. On the other hand, the frequency range only starts at 10 MHz, with a slight degradation of level constancy.

a) Open out figure on page III-27 of handbook to see the location of controls pertaining to this option.

b) Display the frequency and set the output level according to the procedure given from page III-19 onwards. Since option 006 has to be associated with the frequency doubler, it is necessary to observe the operational and other limitations which are inherent in the extension to 1300 MHz (see above). Generally speaking, the minimum usable frequency is 10 MHz and the maximum output level is + 13 dBm/50 ohms.

c) Switch on the pulse modulator by moving switch 5 to the extreme right position. The «MOD» indicator lights up in green.

Connect the pulse generator to the 7100 to make the control loop functional, since in the absence of the modulating signal the loop does not operate and the minus (—) indicator flashes after a few seconds.

Switching on this mode always entails switching on amplitude frequency or phase modulation modes. If the application envisaged does not require the use of simultaneous modulations, the other functions must be disabled by using knobs 2 and 4 (see page III-26).

d) Inject the rectangular modulating signal at connection the input circuit impedance being 600 ohms.

● **Recurrence frequency :**
 10 Hz to 200 kHz for an unchanged constancy.
 200 kHz to 2.5 MHz with level degraded by + 1 dB.

● **Pulse level :**
 0 to 4 V minimum, transmission thresholds being at +0.4 V and 3.5 V.

● **Minimum width :**
 200 ns.

Setting of rise and fall times for the HF pulses may be carried out by adjusting the slope of the modulating signal, since the HF signal level is proportional to that of the control sign between 10 % and 90 % of the amplitude of the upper threshold (+ 3.5 V).

Modulation of the RF signal thus takes place with a substantial signal drop for the «0» level (+ 0.4 V) and with transmission in full for level «1» (+ 3.5 V) : the switching time may reach 30 ns and 20 ns respectively.

e) The output level shown by the galvanometer for RF remains valid when level «1» is applied, and corresponds to peak power during modulation.

On the other hand, in the absence of a control signal, the RF signal is off and the control loop no longer operates.

f) The RF signal may be re-established by going back one step on the «RF MODE» switch. The colour of the «MOD» indicator changes from green to red.

g) Compatibility of modulations.

It is possible to produce simultaneously pulse and amplitude modulations, which amounts to modulating the peak amplitude of the HF pulses. Frequency or phase modulation is also usable together with pulse modulation.

AUTOMATION OF CONTROLS OPTIONS 004 AND 005 : IEEE PROGRAMMING

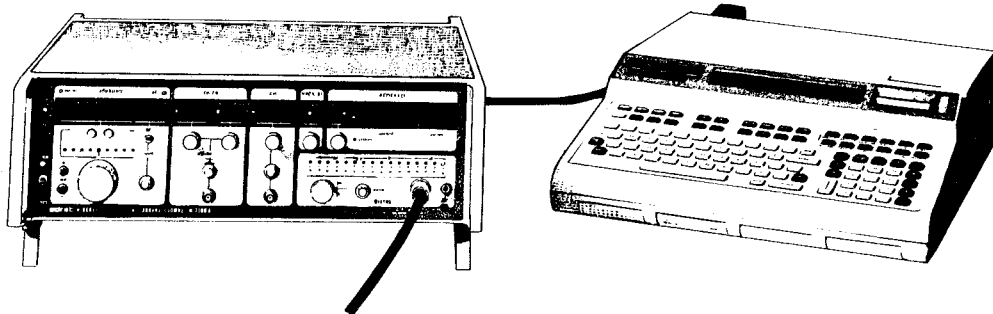

The programming obtained through the IEEE bus conforms to IEEE standard 488 of 1975, and is carried out very simply :

- by using a CLEAR LANGUAGE and a FREE FORMAT :
- by using the MNEMONIC PREFIX corresponding to each function on the FRONT Panel :
- by following this prefix with figures which determine either a value of frequency, the output level and the setting of the modulations, or a choice among the controls for AM, FM and PM modulations (modulating source, coupling, deviation range).

Programming of the instrument is done from the REAR panel, with the help of options 004 and 005, the detail of which is shown in figure 3-7.

Moreover, all the instrument functions are programmable, except GALVANOMETER SWITCHING 8 which is always done by the local switch 6. FRONT panel display remains operative to allow checking of CONTROL data.

Option 005 may only be fitted to instruments having option 004.

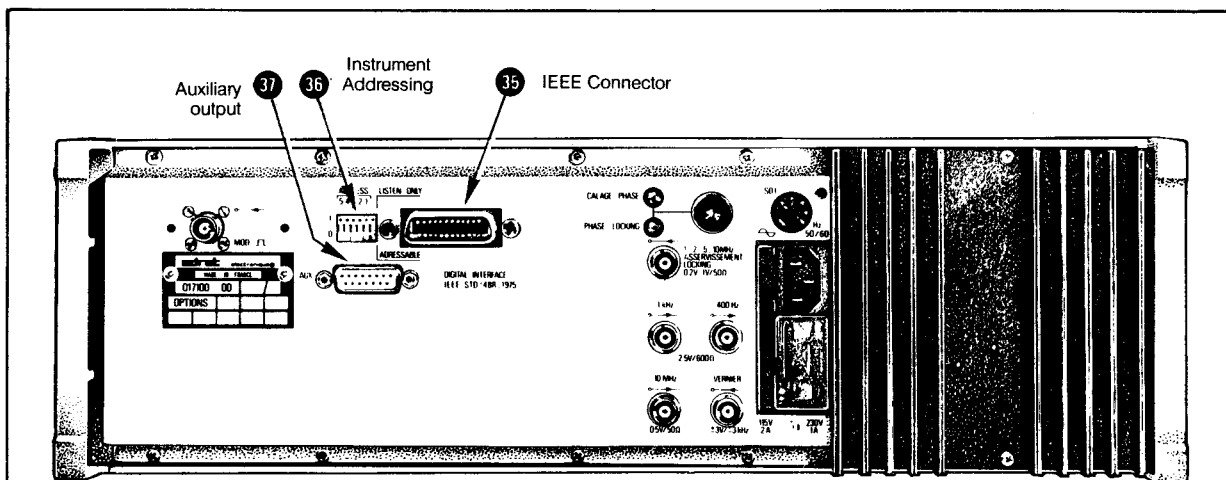

OPTION 004

- Frequency: resolution of 125 kHz, 250 Hz or 500 Hz according to frequency range. 1 kHz above 650 MHz.
- Level: resolution of 0.1 dB
- Operating Mode : CW/MOD/INHIB
- Modulating source AM-FM-PHASE MODULATION
- FM deviation range.

OPTION 005

- Frequency : 1 Hz resolution
- AM modulation rate : by percentage (%)
- FM deviation : resolution 1/300 of the selected range.
- OM deviation : by degree
- Validation of the AM, FM-PHASE MODULATION and level potentiometers.

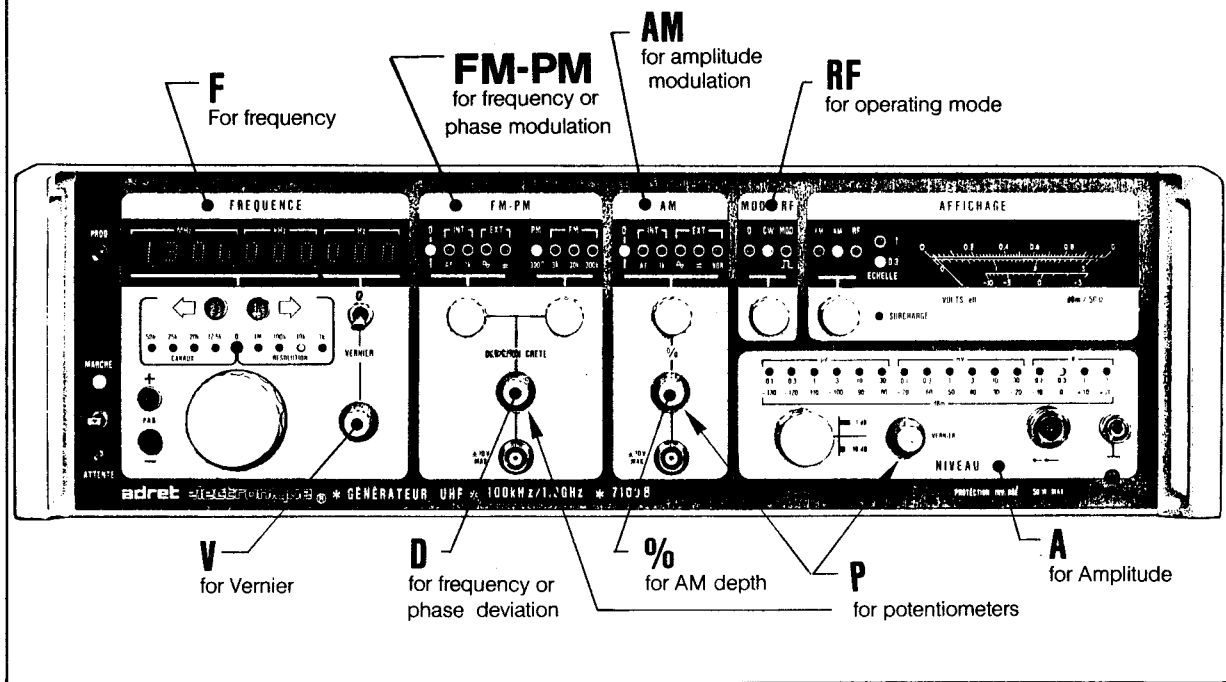

ADDRESSING THE 7100

a) Set LISTEN ONLY/ADDRESSABLE change-over switch on switch **36** to «O» (ADDRESSABLE)

In the LISTEN ONLY position («1») the 7100 indiscriminately receives all the data sent by the controller.

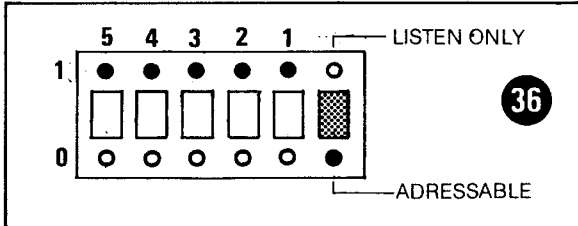

b) Set change-overs 1 to 5 on switch 36 to «1» or «0» in agreement with the binary figure corresponding to the selected decimal address (between 0 and 30).

c) Connect the controller to the instrument via the 24-pin connector 35

PROGRAMMING OF LOCAL AND REMOTE MODES

The 7100 complies with conditions RL2 of IEEE Standard 488, which stipulates that programmed mode may be LOCAL or REMOTE with the possibility of locking out operation of the instrument. Function RL2 is shown diagrammatically in the simplified diagram hereunder together with its mnemonic table.

As soon as the controller is connected to outlet 35 on the REAR panel and when the IEEE bus is active (line REN to 0 Volt), switch 35 can no longer set the instrument to STANDBY, whether the mode be local or remote.

a) Switching over to REMOTE.

The REMOTE mode is obtained from the first time the instrument is addressed in LISTENER as long as line REN is active (REN = 0 V).

b) Return to LOCAL with or without LOCKOUT

When the instrument is in remote (addressed in LISTENER), return to local mode is obtained either by command from the computer (GTL - go to local), or by manual command from switch 23 (away position) on the 7100. This manual command may be invalidated by the controller by sending out the command «LLO» (local lockout). Thereafter only the computer can command return to local. Lockout is interrupted when the bus returns to «rest» (line REN passive at 1).

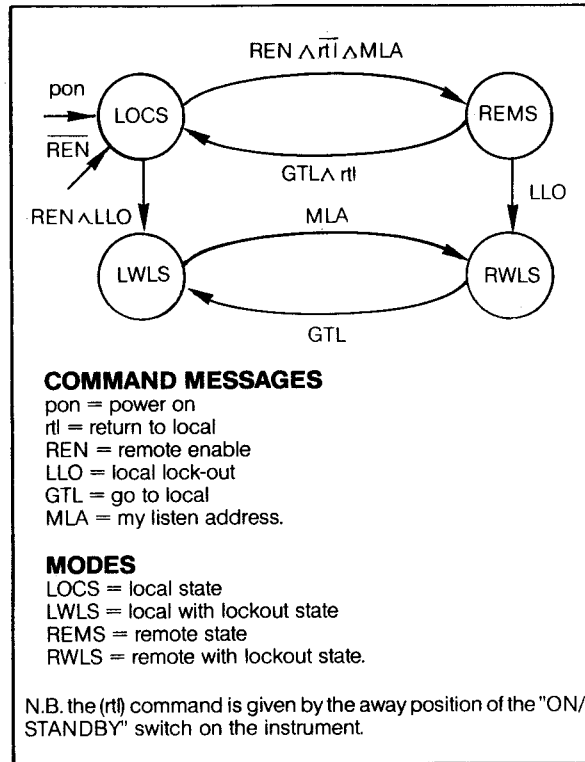

Example of programming

The example hereunder corresponds to the use of an HP 9825 controller.

PROGRAM OPERATING MODE \ INITIAL OPERATING MODE	LOCAL WITHOUT LOCKOUT	REMOTE WITHOUT LOCKOUT	LOCAL WITH LOCKOUT	REMOTE WITH LOCKOUT
LOCAL without LOCKOUT		rem 7xx	1107	*
REMOTE without LOCKOUT	1107 or 1c17x7 or manual		*	rem7xx or wrt7xx
LOCAL with LOCKOUT	1c17	*		
REMOTE with LOCKOUT	1c17	*	1c17xx (but not manual)	

* Not obtainable xx 7100 Address

STATE OF CONTROLS WHEN GOING TO REMOTE

After switching on power and at the first change to Remote mode, the instrument's main functions go to the following states :

- Displays of frequency (F), amplitude (A), operating mode (RF), FM and AM modulations are the same as in LOCAL mode

- Frequency VERNIER is disabled (V0) or enabled (V2).
- POTENTIOMETER control is enabled (P1) (AM percentage, FM-PM deviation and level vernier).

On return to local mode, frequency and amplitude still correspond to the programmed value. AM and FM modulations, operating mode (RF) and frequency vernier (V) correspond to local values reached before going to Remote mode.

PROGRAMMING OF PARAMETERS

Programming of the various parameters is usually done in ASCII code, and they are taken into account by the generator on receipt of either a question mark, or of the command GROUP EXECUTE TRIGGER, or of a Carriage Return, usually transmitted automatically by the computer.

FREQUENCY OF 100 kHz to 1300 MHz

a) With the option 004, program the MNEMONIC PREFIX «F» or «f», followed by the frequency in hertz expressed in free format. The resolution corresponding to the range is shown in the table below :

Frequency Range	OPTION 004 Resolution
0 to 81.25 MHz	500 Hz
80 to 162.5 MHz	125 Hz
160 to 325 MHz	250 Hz
320 to 650 MHz	500 Hz
640 to 1300 MHz	1 kHz

For example, the frequency 599.480 MHz can be programmed in various ways :

- «F 599480000»
- «F599.48e6»
- «F5.9948e8»

Programming of a frequency that is not a multiple of one of the resolution steps is **ROUNDED** by default.

b) With the options 004 and 005, resolution may be brought down to 1 Hz if the VERNIER frequency control is programmed (V1). Refer to the corresponding section below.

c) Display ① shows the output frequency corresponding to the programmed value or to the value rounded by default.

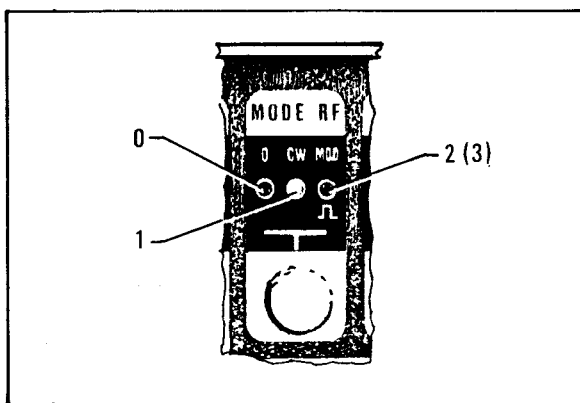

MODE OF OPERATION

Program the MNEMONIC PREFIX «RF», followed by a digit between 0 and 3 corresponding to the required mode.

- «RFO» : Disablement
 - «RF1» : CW
 - «RF2» : MOD (AM and FM or PHASE MODULATION)
 - «RF3» : PULSE MODULATION.
- (see page III-18)

VERNIER

Program the MNEMONIC PREFIX «V» or «v» followed by the digit 0, 1 or 2 which shows that the vernier is disabled, remotely controlled or manually controlled respectively.

«VO» :

VERNIER disabled, frequency resolution is 125 Hz, 250 Hz, 500 Hz or 1 kHz according to the frequency range used.

«V1» (exclusive to option 005) :

VERNIER programmed to give 1 Hz resolution in obtaining output frequency. This command is incompatible with the dc FM command (F41-F42 or F-43).

«V2» :

manual VERNIER and REAR panel analogue control enabled.

In the case of "V2", the output frequency can also be fine-tuned by an analogue signal applied to connector ③ on the REAR panel. The sum of the frequency variations coming from the manual vernier, the rear analogue control and if applicable the frequency modulation with dc coupling, must not exceed ± 13 kHz.

In the case of "VO", only the frequency shift, introduced in FM through the insertion of a dc component at the modulating input, may need adding to or subtracting from the displayed frequency.

Order of programming of Parameters	Equivalent to :
FM41V1	FM31V1
FM42V1	FM32V1
FM43V1	FM33V1
V1FM41	VOFM41
V1FM42	VOFM42
V1FM43	VOFM43

In the case of "V1", inadvertant programming of the parameters "V1", together with "FM41", "FM42" or "FM43" causes a change in the output data as shown in the table above. The equivalent output is in fact a function of the order in which these two parameters are programmed.

AMPLITUDE

a) Program the MNEMONIC PREFIX «A» or «a» followed, in free format, by the level expressed in dBm. For levels below 0 dBm (224 mVrms), the level must be preceded by the minus sign (—).

«A18» : + 18 dBm

«a-135.8» : — 135.8 dBm

«A-4.63e1» : — 46.3 dBm

The 0.1 dB resolution is obtained if the POTENTIOMETER control is disabled (see corresponding paragraph, page III-17).

b) Level control may be effected on galvanometer ⑧ after lighting the RF indicator with switch ⑥

c) The OVERLOAD indicator ⑨ shows that the maximum permitted peak power is being exceeded.
+ 20 dBm for direct range
+ 10 dBm for doubled range.

AMPLITUDE MODULATION

a) Program the MNEMONIC PREFIX "AM" or "am" followed by a digit between 0 and 5 corresponding to the desired modulation mode.

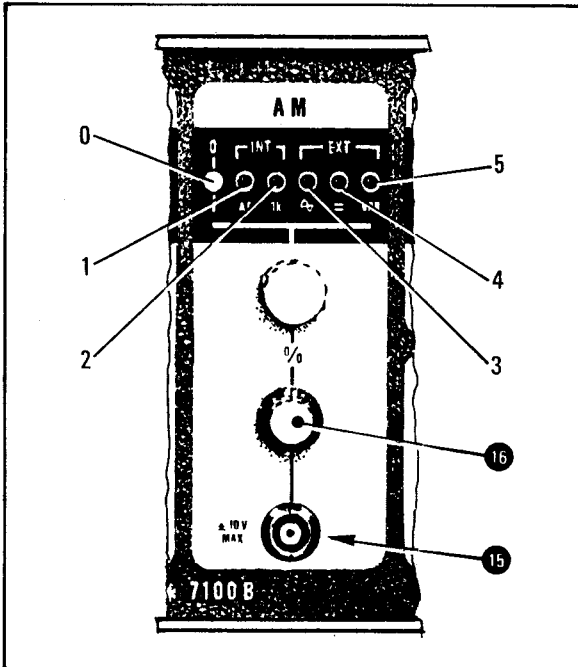

«AM0»: Function disabled
 «AM1»: AM by internal low frequency of 400 Hz
 «AM2»: AM by internal low frequency of 1 kHz
 «AM3»: AM by ac external coupling
 «AM4»: AM by dc external coupling
 «AM5»: VOR externally.

In the case of AM with dc coupling, the dc component acts upon, and therefore modifies the programming of, the level. The value displayed on the galvanometer corresponds in this case to the actual average level.

AM FROM OPTION 004

b) For modulation by an internal source, the AM modulation depth is 100 % when the potentiometer control is disabled (PO). See corresponding paragraph, page III-17.

c) The AM modulation depth can be set by potentiometer 16 and galvanometer 8 when the potentiometer control is enabled (P1).

d) For modulation by an external source, apply the modulating signal to connector 15. The AM depth of modulation can be set by potentiometer 16 and galvanometer 8 when the POTENTIOMETER control is enabled (P1). Otherwise, AM depth can only be set on an external programmable generator, with an input level of 200 mVrms for 100 % modulation.

e) The OVERLOAD indicator 9 shows that maximum permitted output peak power is being exceeded. Reduce the AM modulation percentage or the output level when the indicator lights up.

AM WITH OPTIONS 004 AND 005

f) Set the AM percentage by programming the MNE-

MONIC PREFIX «%», followed by a number between 0 and 100 (resolution 1 %). The voltage of the modulating signal applied to input 15 must be calibrated at 1 Vrms/600 ohms.

Programming of AM percentage can only be achieved when the POTENTIOMETER control is disabled (see corresponding paragraph, page III-17). Otherwise, AM percentage is set with potentiometer 16, the input sensitivity being 200 mVrms for 100 % modulation.

g) AM percentage may be read on galvanometer 8. Indicator 9 shows if the maximum permitted peak power is being exceeded.

FREQUENCY OR PHASE MODULATION

a) Frequency : Programm the MNEMONIC PREFIX «FM» or «fm» followed by 2 digits corresponding to the selected modulation mode and deviation.

«FM1x»: FM from internal low frequency of 400 Hz
 «FM2x»: FM from internal low frequency of 1 kHz
 «FM3x»: FM from external ac coupling
 «FM4x»: FM from external dc coupling

(x) = 1 : for ± 3 kHz deviation
 2 : for ± 30 kHz deviation
 3 : for ± 300 kHz deviation

Note that in FM modulation with dc coupling, the frequency VERNIER cannot be programmed (V1) and vice-versa. See VERNIER paragraph, page III-15.

b) Phase : Program the MNEMONIC PREFIX «PM» or «pm», followed by a digit corresponding to the modulation mode.

«PM1»: Phase modulation by internal low frequency of 400 Hz
 «PM2»: Phase modulation by internal low frequency of 1 kHz
 «PM3»: Phase modulation by external ac coupling
 «PM4»: Phase modulation by external dc coupling

Note that Phase modulation may also be obtained by programming the mnemonic prefix "FM" or "fm" followed by 2 digits, the second of which must always be 0.

FM or PHASE MODULATION FROM OPTION 004

For modulation by internal source, the FREQUENCY or PHASE deviation is maximum when the POTENTIOMETER control is disabled (PO). See corresponding paragraph, page III-17.

c) FREQUENCY or PHASE deviation is adjustable by potentiometer 18 and galvanometer 8 when the POTENTIOMETER control is enabled (P1)

d) For modulation by an external source, apply the modulating signal to connector 17. The FREQUENCY or PHASE deviation is adjustable by potentiometer 18 and galvanometer 8 when POTENTIOMETER control is enabled (P1). Otherwise, adjustment is done by an external programmable generator with an input level of ± 3 Vrms for full FREQUENCY or PHASE MODULATION.

Note that in frequency modulation with dc coupling the carrier frequency shift resulting from the introduction of a dc component at input 17 is taken into account in the frequency meter display. If the modulation rate is higher than 30 Hz, the display corresponds to the average value, or fluctuates by averaging the instantaneous frequency over a period of 0.25 second.

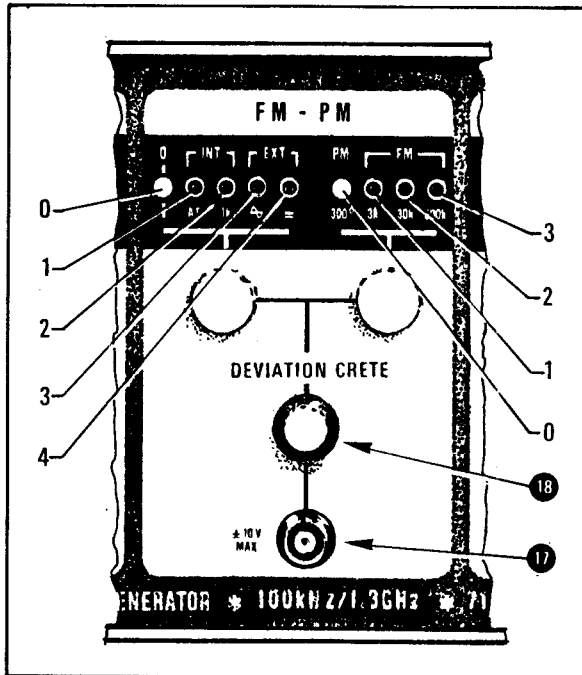

FREQUENCY OR PHASE MODULATION FROM OPTIONS 004 and 005

f) Set the FM deviation by programming the MNEMONIC PREFIX «D» followed by a number equal to or a multiple of the step corresponding to 1/300 of the programmed range (± 3 k, ± 30 k or ± 300 k).

g) Set the PHASE deviation by programming the MNEMONIC PREFIX "D" followed by a number between 0 and 300 (1° resolution)

h) In both cases, the voltage of the modulating signal applied at input 17 must be calibrated at 3 Vrms/600 ohms.

Note : Programming the FREQUENCY or PHASE deviation can only be achieved if the POTENTIOMETER control is disabled (see corresponding paragraph).

i) Displays 7 and 8 show the programmed FREQUENCY and PHASE deviation

j) Examples of FREQUENCY and PHASE MODULATION PROGRAMMING

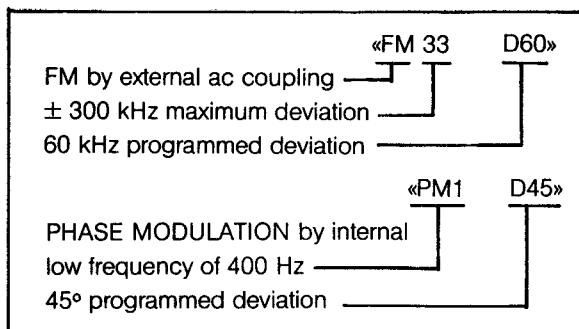

CONTROL OF POTENTIOMETERS 18, 15 and 13

Program the MNEMONIC PREFIX «P» followed by the number «0» or «1» to disable or enable the action of the 3

potentiometers «PO» : Disabling of the 3 potentiometers. In this case, for instruments fitted with Options 004 and 005, the functions FM, PHASE MODULATION, AM and OUTPUT LEVEL are adjusted as follows : - FM : sensitivity equal to or a multiple of the frequency step corresponding to 1/300 of the range ± 3 k, ± 30 k, or ± 300 k.

PHASE MODULATION : 1° resolution

AM : 1 % resolution

Output Level : in steps of 0.1 dB

Where instruments are fitted with only option 004, programming of AM depth and FREQUENCY or PHASE deviation can only be done with a programmable external generator. Modulation inputs are then calibrated as follows :

AM : 200 mVrms for 100 %

FM and Phase Modulation :

3 Vrms for ± 3 kHz,

± 30 kHz, ± 300 kHz or 300°

The output level is obtained with a resolution of 0.1 dB.

Note : The auxiliary output connection 37 which delivers BCD signals (2 significant digits) from data carried on the BUS may be utilized for programming the LF modulating generator.

«P1» with Option 005 : Enabling the 3 potentiometers Output level resolution is 1 dB and programmed commands of FREQUENCY/PHASE (D) and AM modulation depth (%) are inhibited.

AUXILIARY OUTLET

Program the MNEMONIC PREFIX «X» or «∞» followed by 2 figures between 00 and 99. The corresponding BCD number is delivered at connector 37 on the REAR panel. The figure below gives the digit order of the BCD output as a function of the connector pins.

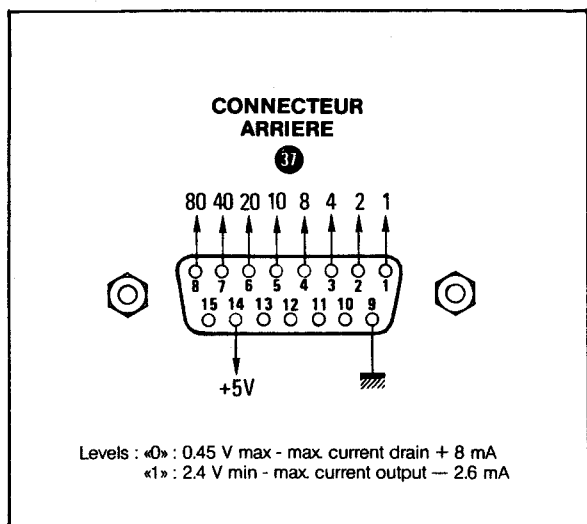

«TALKER» FUNCTION

When programmed for LOCAL or REMOTE, and addressed in «TALKER», the instrument answers with the value of the displayed frequency, which takes account of variations coming from the vernier, the rear analogue control, FM modulation with DC coupling, and if applicable the rounding off of the programmed frequency.

The answer to the controller appears in the form of a message of 13 ASCII characters according to the following format :

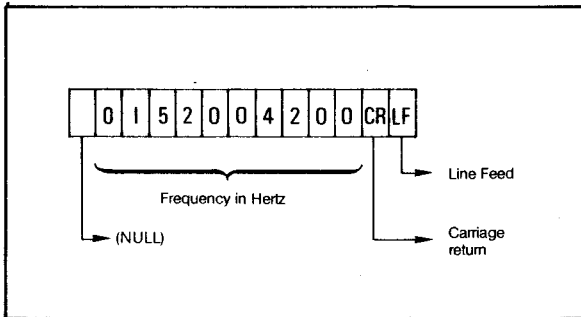

Suppose for instance that the «TALKER» function is to be programmed with the HP 9825 controller. Addressing is as follows :

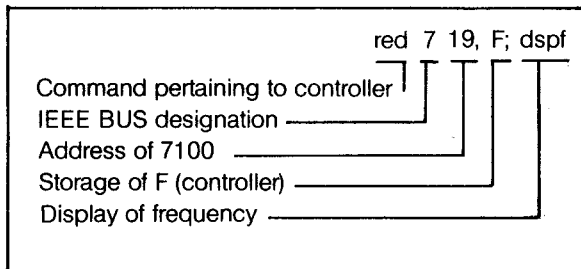

ENABLEMENT OF OPTIONS

FREQUENCY DOUBLER (OPTION 003)

Incorporation of this option does not modify the procedure for programming the various parameters, but the maximum output level is limited to + 13 dB.

PULSE MODULATION (OPTION 006)

- Enable the function by programming the MNEMONIC PREFIX «RF3».
- Program the frequency and the output level according to the instructions given in pages III-37 to III-40, remembering that the frequency may not go below 10 MHz.
- Enablement of this mode automatically brings about enablement of amplitude modulation and of frequency or phase modulation. If the application envisaged does not require the use of simultaneous modulations, it is essential to disable these functions by programming the mnemonic prefixes «AMO» and «FMO».

PROGRAMMING EXAMPLES

The examples given show how commands are to be programmed, without however being exhaustive as regards the order of programming or the choice of free format. They should be used guides during early use of the instrument.

For ease of comprehension, all the examples use the HP 9825 as programm source. There is however no restriction to that machine, and the generator may be programmed from other types.

OUTPUT OF PURE CONTINUOUS WAVE

Parameters to be set are :

- «F» for frequency
- «V» for frequency vernier
- «RF» for operating mode
- «A» for output level
- «p» for potentiometers

For instance, suppose a signal must be delivered at a frequency and level of 458,736273 MHz and — 28.3 dBm respectively.

OPTION 004

a) Program :

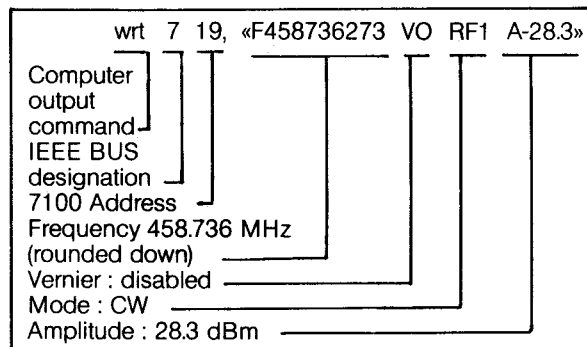

N.B.

- The 7100 takes no account of figures coming after a comma or a space.
- As the frequency is not a multiple of the resolution (see page III-37), it is rounded down.
- POTENTIOMETER control not being programmed corresponds to P1.

b) To modify parameters V and A, Program :

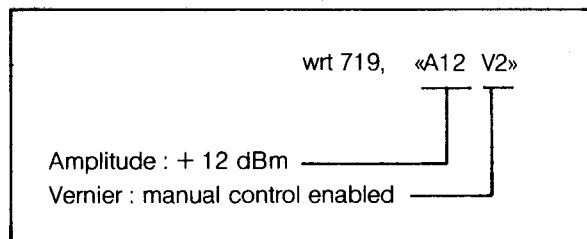

N.B. In programming "V2", the output frequency may also be fined down by an analogue command delivered to the REAR panel connector. **31**

OPTIONS 004 AND 005

a) Program :

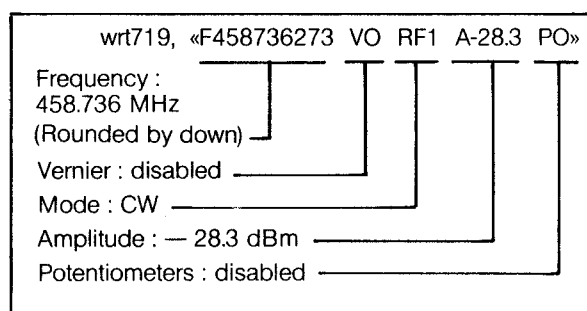

b) to modify parameters V, P, A and F, program :

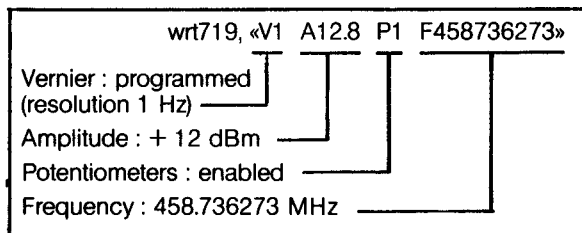

N.B. The output frequency corresponds to the programmed value since the vernier is used in programmed mode, thus giving 1 Hz resolution.

- The instrument gives an output level of + 12 dBm plus or minus the value corresponding to the position of vernier. ¹³
- Enabling potentiometer ¹³ overrides the programming of 0.1 dB steps.

OUTPUT OF A MODULATED WAVE

The parameters to be set are :

- «F» for frequency
- «V» for Vernier
- «FM» or «PM» for frequency or phase modulation
- «AM» for amplitude modulation
- «RF» for operating mode
- «P» for potentiometers
- «A» for output level
- «%» for modulation percentage
- «D» for FM or PM deviation (Specific to option 005)

For instance, suppose a signal with a frequency of 350.245750 MHz and level of 10.7 dBm is to be modulated.

OPTION 004 - MODULATION AM

Program :

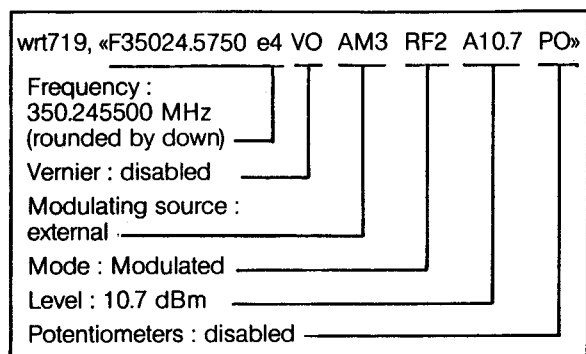

N.B. ● Since the frequency is not a multiple of the resolution, it is rounded down.

- The 7100 takes no account of figures coming after a comma or a space.
- Setting of the modulation percentage is done by an external generator.

OPTION 004 - FM MODULATION

Program :

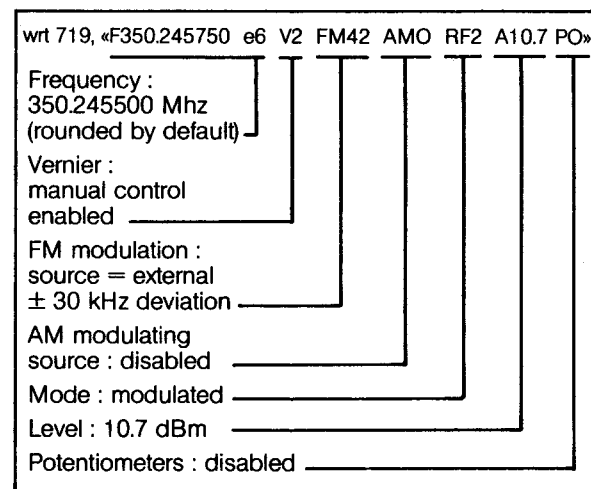

N.B. ● Since the programmed frequency is not a multiple of the resolution, it is rounded down.

- By programming "V2", programmed, the output frequency could also be fine-turned by an analogue command delivered to connector ³⁵ on the REAR panel.
- Simultaneous AM-FM modulation is obtainable by programming both parameters.
- Setting of the FM deviation is done by an external generator.

OPTION 004 - φM MODULATION

Program :

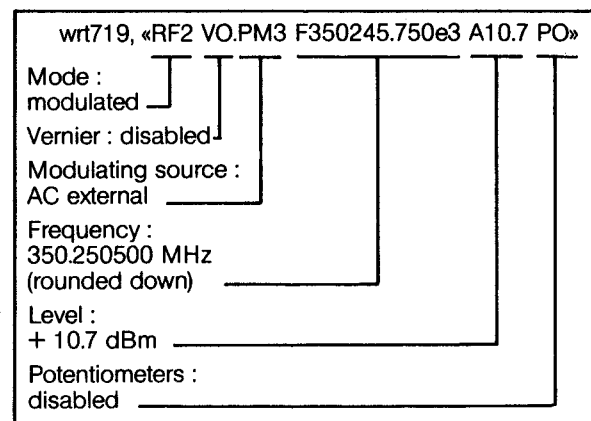

N.B. ● Setting of deviation is done by an external generator.

- Simultaneous AM-PM modulation is obtainable by programming both parameters.
- Since the programmed frequency is not a multiple of the resolution it is rounded down.

OPTIONS 004 AND 005 - AM MODULATION

Program :

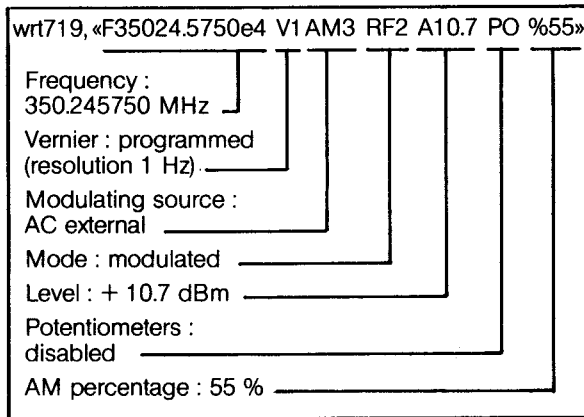

N.B. ● Output frequency corresponds to the programmed value, since the vernier is used in programmed mode, thus giving a 1 Hz resolution.

● The AM modulation percentage and the 0.1 dB resolution of the level may be programmed as the potentiometers are disabled.

OPTIONS 004 AND 005 - FM MODULATION

Program :

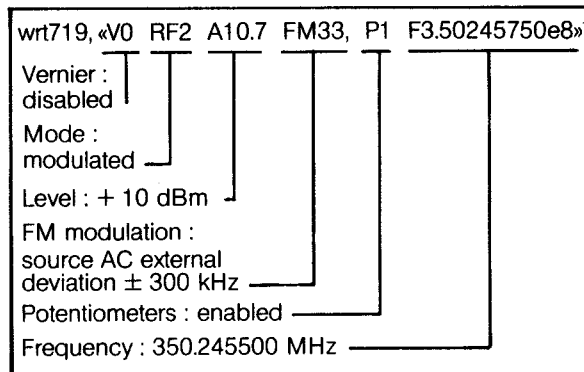

N.B. ● Because of the enablement of the potentiometers, the level may have 1 dB resolution.

● Output frequency is rounded down.

● Simultaneous AM-FM modulations is obtainable by programming both parameters.

OPTIONS 004 AND 005 - Φ M MODULATION

Program :

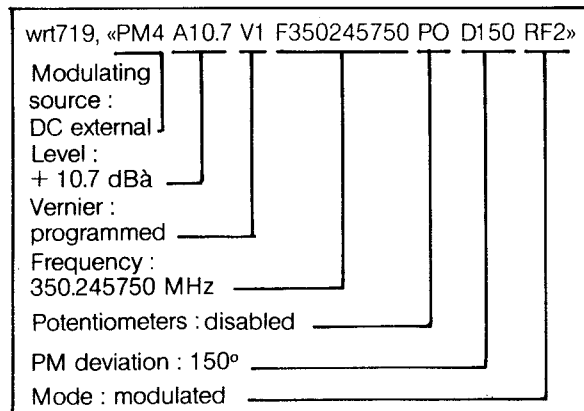

N.B. - Simultaneous AM-PM modulations is obtainable by programming both parameters.

OUTPUT OF A PULSE MODULATED WAVE IN THE 650 to 1300 MHz RANGE

Parameters to be set are :

«F» for frequency

«V» for frequency vernier

«RF» for operating mode

«A» for output level

«P» for potentiometers

«AM» for amplitude modulation

«FM» or «PM» for frequency or phase modulation

«%» for AM modulation percentage

«D» for FM or PM deviation

Suppose for instance that a signal is to be delivered with a frequency and level of 1030.687 MHz and + 3.5 dBm respectively.

OPTION 004

Program :

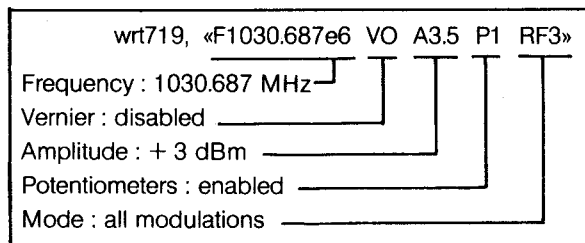

N.B. ● The 7100 takes no account of digits coming after a comma or a space.

● As the output frequency is a multiple of the resolution (1 kHz), it tallies with the programmed value.

● The output level is + 3 dBm plus or minus the value corresponding to the position of vernier **13**

OPTIONS 004 AND 005

Program :

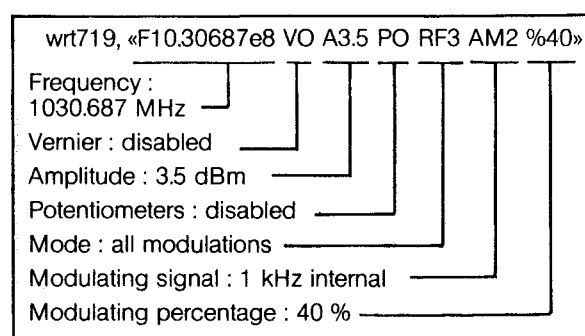

N.B. - Disabling the manual potentiometer control makes it possible to get an output level adjustable in 0.1 dB steps.

SELF-TEST

The test points are interrogated by means of controller connected to the rear of any generator fitted with option 04 or options 04 and 05.

Refer to the chapter V page V-7, for the using of this function.

CHAPTER IV PRINCIPLE OF OPERATION

This chapter gives a simplified description of the main frequency generating circuits used for generating the frequency and shows the areas affected by AM, FM and DM modulations and output level settings.

To complete the explanations, the end of the chapter deals with the microprocessor and with some options with which the instrument may be fitted.

GENERAL PRINCIPLE

The 7100 is an instrument with the special feature that it is based on the principle of high spectral purity generators, using high-Q LC or cavity resonant circuit, as well as the principle of indirect frequency synthesis.

The simplified principle of operation is shown in figure 4-1;

1. A high-Q oscillator, which is a condition for good spectral purity of the signal, is used for the generation of small frequency steps, while an associated digital servo loop enables them to be programmed while ensuring that the oscillator's frequency output has the accuracy and stability conferred by a crystal-controlled reference.

2. The largest frequency steps are generated by the frequency synthesis technique, but with a new technology based on the use of very low noise circuits, to achieve the steps which are still to be provided. By this means, starting from a very pure reference source, it is possible to use low multiplication factors.

3. The output frequency coming from a wide-band oscillator covering 320 MHz to 650 MHz is obtained from 4 sub-bands automatically switched by the microprocessor. Division of the 320 to 650 MHz frequency by 2 or by 4 provides the intermediate sub-bands of 160 to 320 MHz and 80 to 160 MHz. The 0.3 to 80 MHz sub-band is obtained by mixing the oscillator frequency (which in this case varies between 400 and 480 MHz) with a fixed 400 MHz frequency.

To sum up, the 7100 generator consists of a short-term free running generator working at 20 to 25 MHz, control of a crystal under the oscillator reference, followed by a high spectral purity synthesizer which makes it possible to achieve the largest steps and to extend the frequency range to 650 MHz without degrading the spectral quality of the 20 to 25 MHz oscillator.

Fig. IV-1 : Principle of operation of 7100

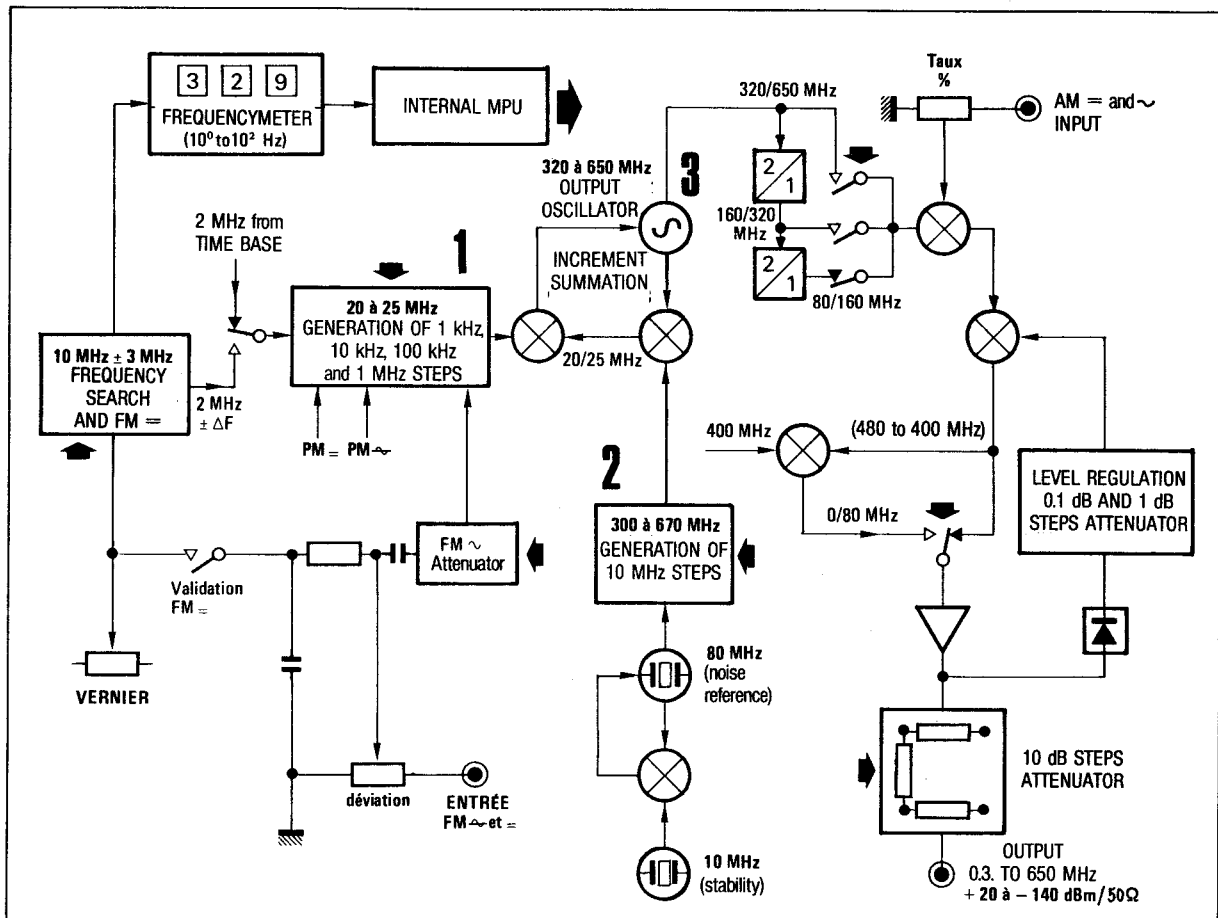

SIGNAL PRODUCTION

GENERATION OF SMALL STEPS

Open out page IV-6 to get the generator block diagram.

The 20 to 25 MHz oscillator, whose frequency is actually obtained by combining an 80/100 MHz oscillator with a divide-by-4 circuit, generates small steps of 1 kHz, 10 kHz, and 1 MHz.

The maximum resolution of the loop is actually 500 Hz, to make it possible, still through the intermediary of the microprocessor, on the one hand to have available the 12.5 kHz step among the steps corresponding to standard channel spacing, and on the other hand to keep the same resolution in the generator output for the direct range and for the doubled range when the instrument is fitted with the doubler option.

The «20 to 25 MHz» assembly consists of two interleaved loops, frequency steps being obtained by programming a counter with a high division factor. Thanks to this counter, the feedback loop of the 80/100 MHz (20 to 25 MHz) oscillator has a narrow pass band (5 Hz), which enables FM AC modulation to be applied directly to the oscillator. The deviation ranges of ± 3 kHz, ± 30 kHz and ± 300 kHz, obtained by analogue division, are kept constant over the whole frequency band (0.3 to 650 MHz) by means of correcting circuits which are enabled by the microprocessor.

FM modulation is also obtained from this «20 to 25 MHz» assembly by acting on the 80 to 100 MHz oscillator with AC coupling at the input.

In modulation with DC coupling, the DC component is transmitted through a phase control loop comparator in order to get constant phase deviation through the frequency band.

It should be noted that the same comparator can, through a switch, receive the $2 \text{ MHz} \pm \Delta F$ frequency supplied by the interpolator, and thus introduce the frequency resulting from the action of the FRONT panel vernier into the loop which generates the small steps.

The maximum (5 MHz) excursion of the 20 to 25 MHz oscillator being insufficient to provide generation of all steps less than or equal to 10 MHz (i.e. a maximum excursion of 9.9999999 MHz), this oscillator operates over the forward 20 to 25 MHz spectrum and then over the reverse 25 to 20 MHz spectrum. This mode of utilisation, together with automatic switching of 10 MHz steps (coming from the 300 to 670 MHz oscillator) and blocking of the 320 to 650 MHz oscillator, avoid transients appearing at the generator output when frequency is being changed.

This reverse spectrum operation does however make it necessary to invert or switch some circuits in order to make the various parameters change in the same sense as the 20/25 MHz frequency. All these operations, shown in figure 4-1 by black arrows, are carried out automatically by the microprocessor at each change of operating mode (32/58 MHz oscillator, comparator, FM correctors, etc.).

GENERATION OF 10 MHz STEPS

The wide band 300 to 670 MHz oscillator generates

10 MHz steps over the whole frequency band by means of a sampling comparator. Actually this loop only takes care of the fine control of the oscillator, approach to the operating frequency being made through a first loop enabled by the microprocessor.

Sampling is done over the frequency resulting from the beat between the oscillator's 300 to 670 MHz and the frequency output from the tuned filter whose value is switched by the microprocessor. The 10 MHz for sampling is obtained from the 80 MHz of the crystal oscillator used as noise reference, the 10 MHz oscillator conferring on the instrument its medium and long term stability.

The microprocessor controls the loop producing the 10 MHz steps to compel it to take account of the operating mode (forward or reverse progression) of the 20 to 25 MHz oscillator, so as to maintain continuous variation of the frequency delivered by the output oscillator (320 to 650 MHz). The latter is within the loop which sums the increments, and is controlled through two mixers by a signal resulting from the addition or subtraction of the frequencies coming from the 20 to 25 MHz and 300 to 670 MHz oscillators.

The following lines give an example of the frequency progression of the 3 oscillators, to show the sequence of operations required to arrive at a final frequency.

- Let F1, F2 and F3 be the signals corresponding respectively to the frequencies of the 20 to 25 MHz, 300 to 670 MHz and 320 to 650 MHz oscillators, the curve giving their variation being that of figure 4.2.

If the initial value of frequency F2 is for instance 320 MHz and F1 varies from 20 to 25 MHz, the output oscillator goes from 340 to 345 MHz. In this case control is effected by the beat produced by addition of F1 and F2.

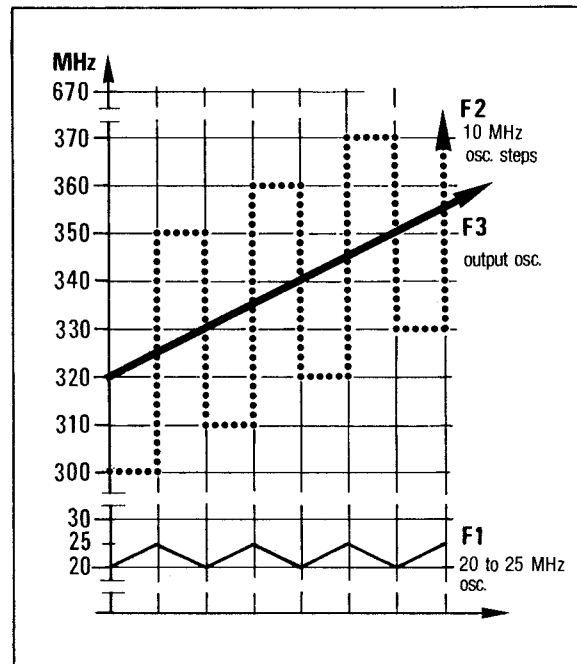

Figure 4-2 : Variation of the 3 oscillators

As soon as F1 reaches 25 MHz, F3 is blocked at 345 MHz by the microprocessor, which at the same time switches F2 to 370 MHz. Control is then effected by the

beat produced by subtraction of F1 from F3; and thus F3 varies continuously from 345 to 350 MHz without any transients appearing.

Then F1 operates again forward over the spectrum from 20 to 25 MHz, F2 being blocked at 350 MHz and F3 switched to 330 MHz. Control of the output oscillator is effected by the beat produced by addition of F1 and F2, F3 varying from 350 to 355 MHz, and so on over the whole frequency band of the generator.

As this explanation shows, the frequency of the 300/670 MHz oscillator switches to a value 50 MHz higher as soon as the small step oscillator reaches 25 MHz, and then assumes a value 40 MHz below the new frequency as soon as this same oscillator reaches 20 MHz. The difference of 10 MHz between the two switchings does therefore tally with the small step increment (9999 999 MHz).

FREQUENCY INTERPOLATION (VERNIER)

Continuous variation of frequency between the 1 kHz steps is obtained from a free running oscillator of 10 ± 3 MHz frequency which is divided by 500; the division minimising the effect of any oscillator instability. Display of the interpolation frequency is done with the help of information transmitted by a frequency meter to the microprocessor, which adds it to or subtracts it from the value of the programmed small steps (20/25 MHz oscillator), knowing that the steps introduced by the interpolator lie between 0 and 1 kHz for the 320/320 MHz output range, 0 and 2 kHz for the 160/320 MHz range, and 0 and 4 kHz for the 80/160 MHz range. Thus the maximum frequency variation in the generator output is about 2 kHz after all the various divisions. Note that when the instrument is fitted with the doubler option, the frequency variation introduced by the interpolator lies between 0 and 500 Hz in order to have 0 to 1 kHz variation in the output.

This circuit also makes it possible to obtain FM modulation with transmission of the DC component, the division ratio varying as a function of the deviation ranges of ± 3 kHz, ± 30 kHz and ± 300 kHz. The vernier remains operative, to allow frequency compensation for any shift of the carrier caused by the DC component, the frequency meter showing the exact average output frequency. FM modulation with DC coupling is thus carried out by transmitting the modulating signal both to the interpolator (signal integration) and to the 20/25 MHz oscillator (differentiation), with perfect concordance at 5 Hz.

OUTPUT CIRCUIT

The frequency selected by the microprocessor among the ranges 320/650 MHz, 160/320 MHz or 80/160 MHz acts directly on the AM modulator, then on a first regulator through which programmed steps of 0.1 dB and 1 dB are introduced. An internal switch then allows a choice between either the 80/650 MHz range or the heterodyned 0.3/80 MHz range, the frequency being supplied at the generator output through the final amplifier and the 10 dB steps attenuator.

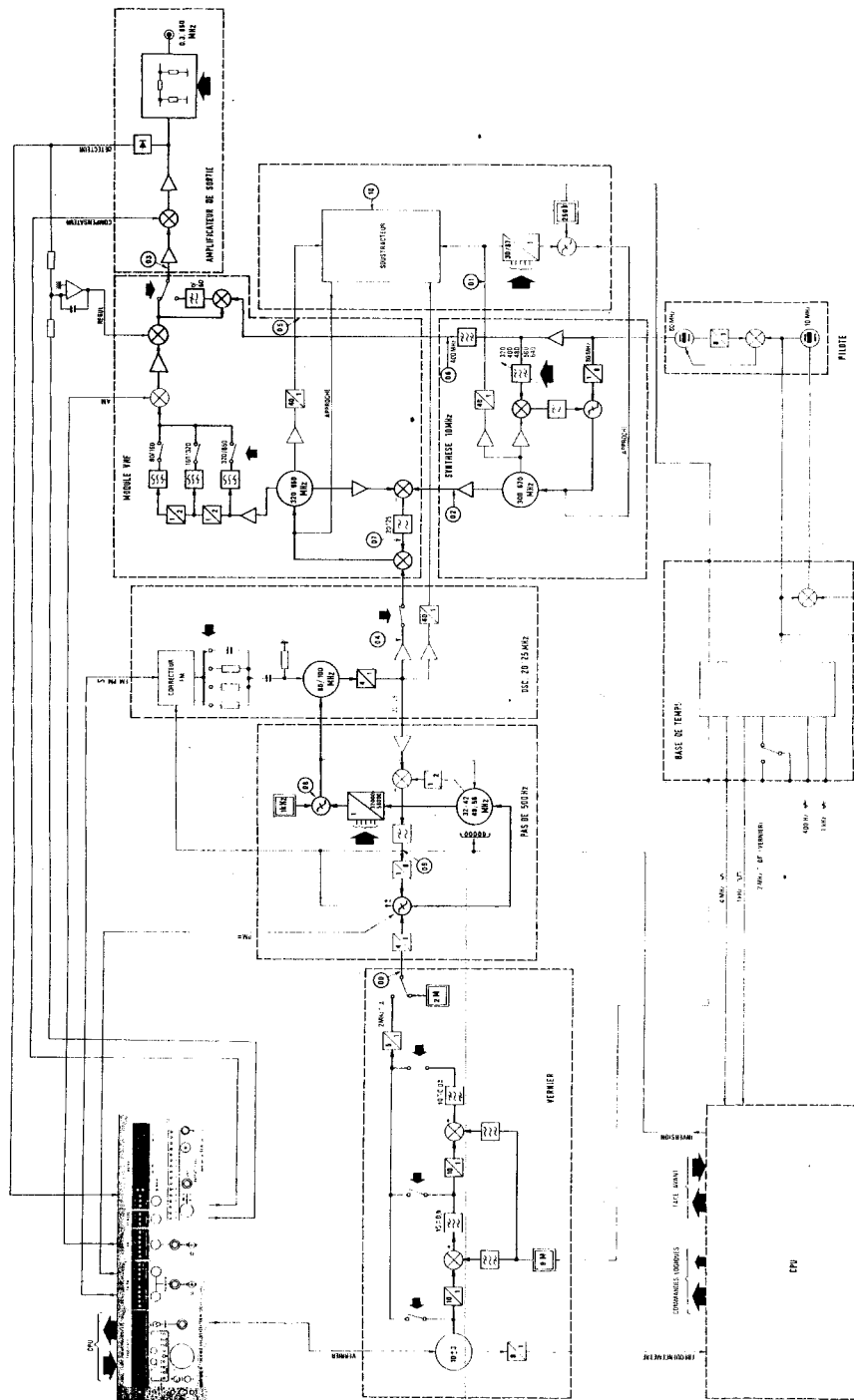

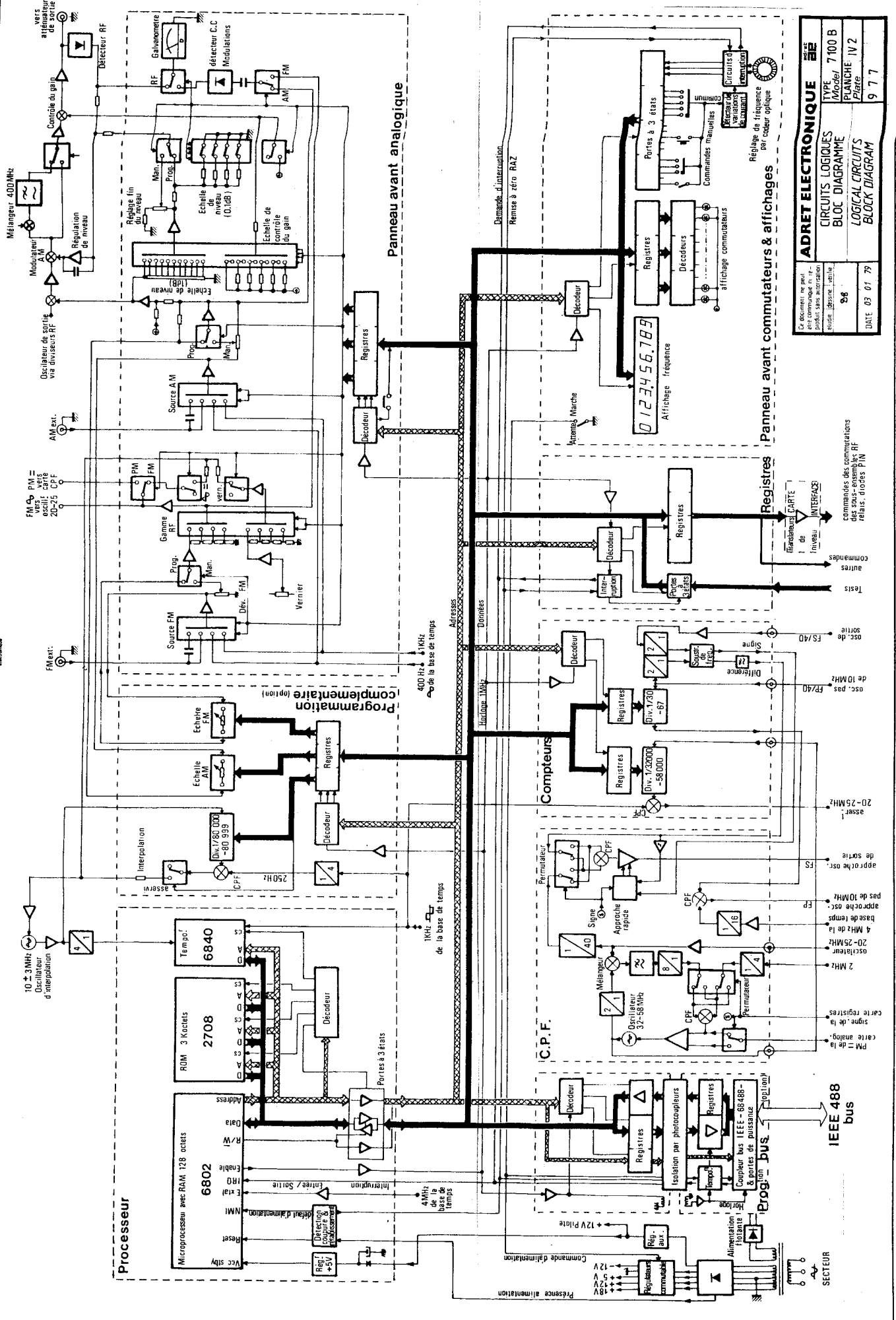

ADRET ELECTRONIQUE	
CIRCUITS LOGIQUES	TYPE 7100 B
BLOC DIAGRAMME	Model 7100 B
LOGICAL CIRCUITS	PLANCHE IV 2
BLOCK DIAGRAM	Plate 9 7 7
DATE 03 01 79	

Calculateur de base 10
à 16 bits commutée en 16
produit sans autorisation
étude, dessin, usine

commutateur des commutations
relais, diodes PIN
autres
Tests
Commandes

Interface CARTE
1 de niveau
INTERFACE

osc. de sortie FS/40
osc. pas de 10MHz

osc. de 20-25MHz

osc. de 2MHz

osc. de 4MHz de la base de temps

osc. de 20-25MHz

osc. de 10MHz

osc. de 2MHz

osc. de 4MHz de la base de temps

osc. de 20-25MHz

osc. de 10MHz

osc. de 2MHz

osc. de 4MHz de la base de temps

osc. de 20-25MHz

osc. de 10MHz

osc. de 2MHz

osc. de 4MHz de la base de temps

osc. de 20-25MHz

osc. de 10MHz

osc. de 2MHz

osc. de 4MHz de la base de temps

osc. de 20-25MHz

osc. de 10MHz

osc. de 2MHz

osc. de 4MHz de la base de temps

osc. de 20-25MHz

osc. de 10MHz

osc. de 2MHz

osc. de 4MHz de la base de temps

osc. de 20-25MHz

MICROPROCESSOR AND ASSOCIATED LOGIC

GENERAL DESCRIPTION

The controls on the instrument are controlled by a microprocessor, figure 4-3 showing the management system schematically.

This management system is made up of 7 separate plug-in cards, viz :

a) The MICROPROCESSOR card proper, which carries a 6802 microprocessor, fitted with a 128 byte RAM, which serves as temporary storage for data relating to the various states of the instrument (frequency, level, switch positions, etc.)

The microprocessor program resides in two to four 2708 EPROMS according to the options fitted to the instrument.

This card also holds a 6840 programmable counter which operates as frequency meter for the interpolation oscillator (10 ± 3 MHz), as well as other ancillary circuits to carry out various logical functions. Other external circuits are connected to the microprocessor through a bottom of subrack bus.

b) The «FRONT PANEL - SWITCHES AND DISPLAYS» card including the set of manual controls and their identification.

Any operation whatsoever of these controls triggers an interrupt which is dealt with by the microprocessor.

c) The «REGISTERS» card consisting of circuits which store the command bits relating to HF and VHF subsystems, and which also includes 3 state gates through which signals being checked by the microprocessor are routed, in order to check proper functioning.

d) The «COUNTERS» card consists of the two programmable frequency synthesis counters (counters for 32000 to 58000 and 30 to 67). This card, together with the CPF card, controls the various oscillators.

e) The ANALOGUE «FRONT PANEL» card which holds the circuits for processing signals for AM and FM modulation, level control, and Vernier control.

f) The «IEEE BUS PROGRAMMING» card which allows the instrument to be programmed by a computer with IEEE 488 or IEC TC66 interface, and which also ensures galvanic isolation of computer and generator earths.

g) The «COMPLEMENTARY PROGRAMMING» card which, together with the preceding card, allows programming of AM modulation percentage and FM frequency deviation, with the help of two digital-analogue converters, while programming of the Vernier in 1 Hz steps is done through a programmable counter which controls the interpolation.

— INTEGRAL MICROPROCESSOR FOR IMPROVED INTERNAL CONTROL MANAGEMENT

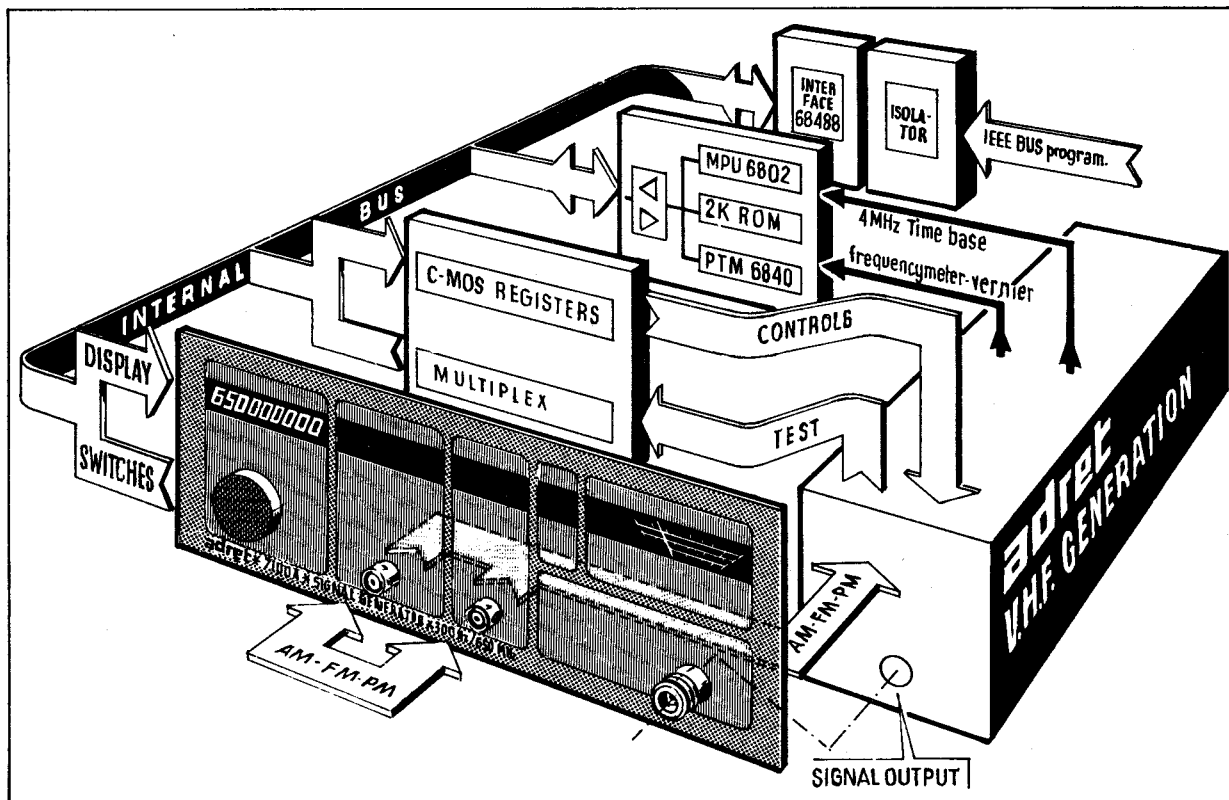

Figure IV-3 : microprocessor based management systems

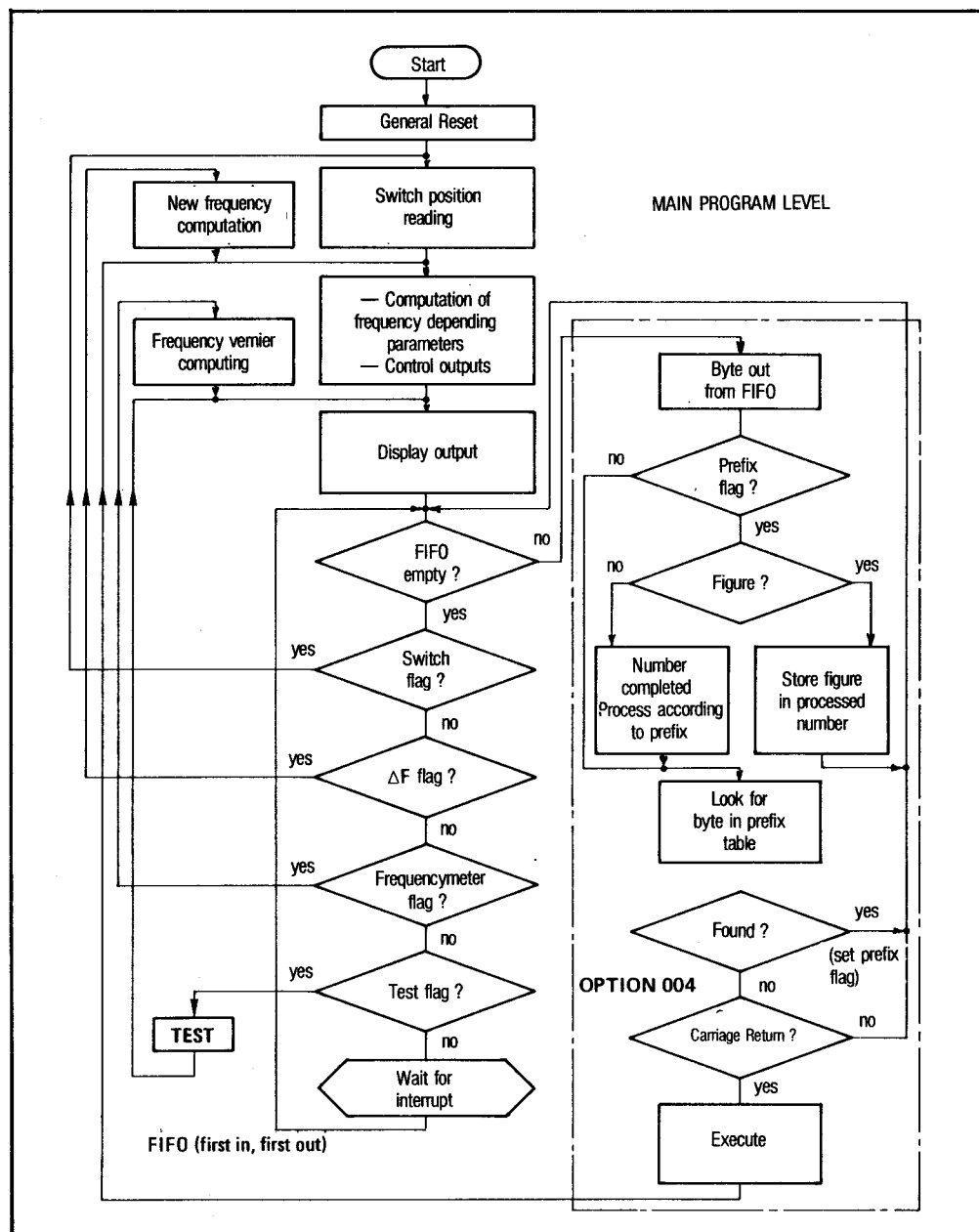

Figure 4-4 : microprocessor flow chart (main program level)

SOFTWARE OPERATION

Operation of the microprocessor and its associated circuits may be followed on the two flow charts of figure 4-4 and 4-5.

When the instrument is switched on the RESET is executed, the microprocessor initialises all its registers (initialisation), then computes all parameters corresponding to the position of the FRONT PANEL controls (input of manual commands), apart from frequency and level controls which the program initialises at 300 MHz and - 140 dBm respectively.

Finally, the microprocessor processes the computed parameters to give the necessary commands to the various circuits in the instrument.

If meanwhile no control has been operated, the microprocessor goes to standby interrupt, with no «task indicator flag» in position.

If at any time a control is operated, a NON PRIORITY INTERRUPT (IRQ) is generated. The microprocessor then scans in sequence all possible cases of interruption according to the flow chart of figure 4-5.

Once the source of the interrupt has been located, the microprocessor sets an appropriate «task indicator flag». Then it resumes execution of the current task (if there is one), and then examines the set of task flags to ascertain what there is left for it to do.

A FIFO (first in — first out) stack stores the data received through the IEEE BUS, these being processed thereafter in order of arrival.

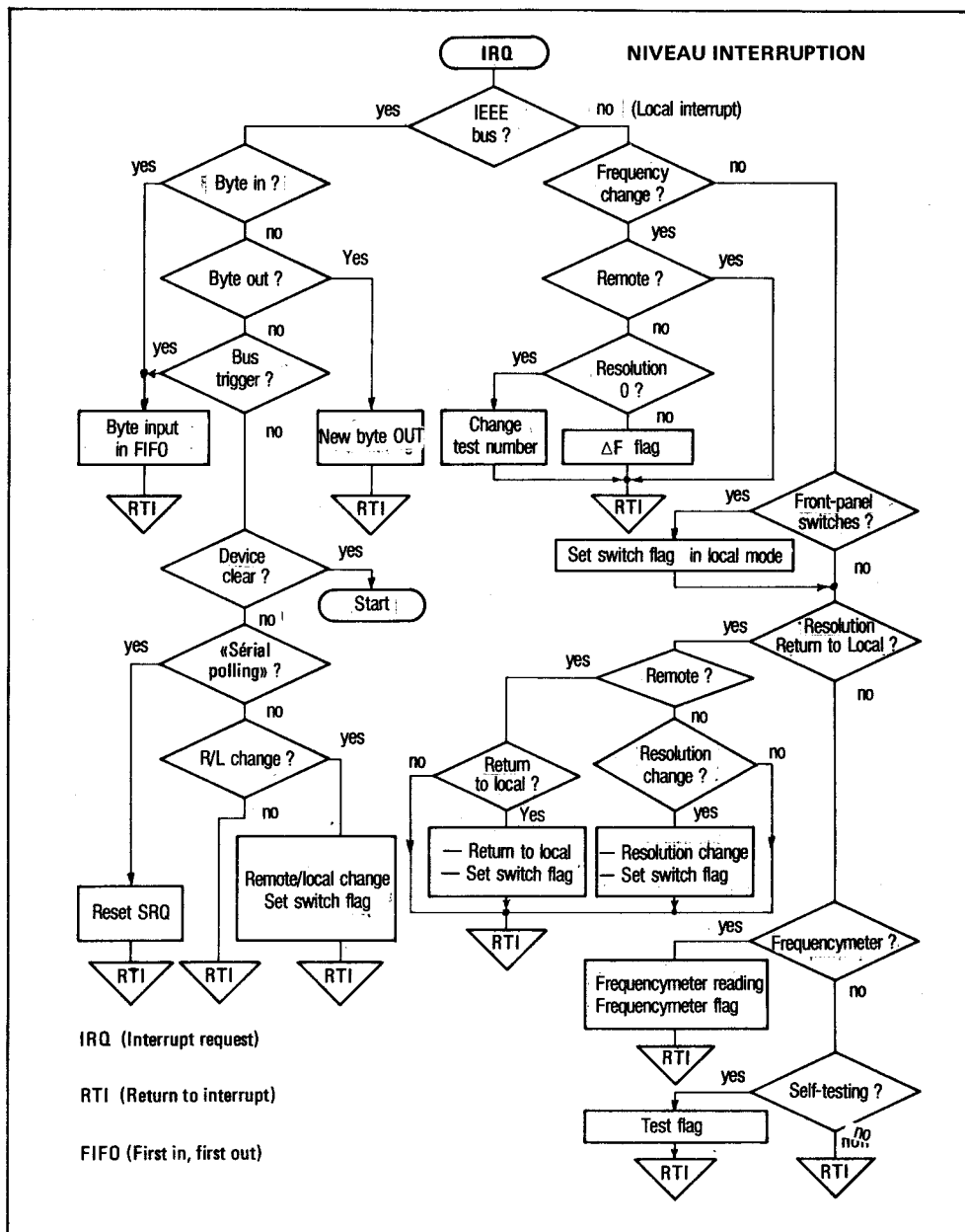

Figure 4-5 : microprocessor flow chart (interrupt level)

DETAILS OF HARDWARE

Addresses for Inputs and Outputs are given in the following tables.

Note however that partial decoding has been used whenever possible in order to limit the number of decoding packs.

EXTERNAL INPUTS - OUTPUTS

According as to whether there is input or output, signal R/W is respectively at 1 or 0 (input e.g. manual command or IEEE signal, output e.g. display or frequency command). Other address bits are positioned accordingly, within the range 0080 to 00FE (only the 7 least significant bits are output on the signal carrier).

TABLE OF ADDRESSES

ELEMENT	FUNCTION	EFFECTIVE ADDRESS
ROM 1	Main Program	B800 to B8FF
ROM 2	Main Program	B400 to B7FF
ROM 3	7100 B : Programming option 7100 D : Main Program	A800 to A8FF
ROM 4	7100 D : Programming option	A400 to A7FF
Timer 6840	Frequency-meter	9800 to 9807
FLIP FLOP	Reset	8800
Page zero	External Inputs-Outputs	0080 to 00FE
	RAM integrated with 6802	0000 to 007F

The allocation of the various bits of the input-output bytes, as it appears on the various circuit diagrams, is summarised in the following tables.

INPUTS TO SWITCH CARD (R/W = 1)

Address (x = «don't care»)								Data Line	Function
D6	D5	D4	D3	D2	D1	D0		D0	Zero (Earth) Free + push button — push button Handwheel knob sense +/- interrupt Handwheel knob interrupt (General) interrupt Free
x	0	0	x	0	0	0	D1		
							D2		
							D3		
							D4		
							D5		
							D6		
							D7		
x	0	0	x	0	0	1	D1	Free Resolution push button Resolution push button Local return Resolution and local return interrupt Switch interrupt General interrupt	
							D2		
							D3		
							D4		
							D5		
x	0	0	x	0	1	0	D0 - D1	FM switch : 0 = PM 1 = ±3 kHz, 2 = ±300 kHz 3 = ±30 kHz RF Mode switch : 0 = 0 1 = CW, 2 = Mod. FM Source : 0 = AF 1 = 1 kHz, 2 = ext DC, 3 = ext AC, 4 = 0 Vernier	
							D2 - D3		
							D4-D5-D6		
							D7		
x	0	0	x	0	1	1	D0 - D1	Level switch Galvanometer : 0 = FM, 1 = AM, 2 = RF AM source : 1 = 1 kHz, 2 = ext DC, 3 = ext AC, 4 = 0, 5 = VOR	
							D2 - D3		
							D4-D5-D6		

OUTPUTS TO COUNTER CARD (R/W) = 0

Hexadecimal address (x = «don't care»)	Data Line	Function
x x 0 0 0 0 0	D0/D5	10 MHz steps
x x 0 0 0 0 1	D6	1 step of 500 Hz
x x 0 0 0 1 0	D0/D8	100 kHz steps
x x 0 0 0 1 0	D0/D8	1 kHz steps

OUTPUTS TO SWITCH CARD (R/W = 0)

Address (x = «don't care»)	Data Line	Function
x 0 x 0 0 0 0	D0/D3 D4/D7	Display of frequency 10 MHz steps (100 steps coded in BCD)
x 0 x 0 0 0 1	D0/D3 D4/D7	100 kHz steps (100 steps coded in BCD)
x 0 x 0 0 1 0	D0/D3 D4/D7	1 kHz steps (100 steps coded in BCD)
x 0 x 0 0 1 1	D0/D3 D4/D7	10 Hz steps (100 steps coded in BCD)
x 0 x 0 1 0 0	D0/D3 D4/D7	1 Hz steps (10 steps in BCD) 1 GHz step (1 step coded in BCD)
x 0 x 0 1 0 1	D0/D3	Resolution : 0 = distance 1 to 9 ; indicators from R to L
x 0 x 0 1 1 0	D0/D1 D2/D3 D4/D6	FM/PM Range : 0 = PM, 1 = ±3 kHz 2 = ±300 kHz, 3 = ±30 kHz RF Mode : 0 = 0, 1 = CW, 3 = MOD. FM Source : 0 = AF 1 = 1 kHz, 2 = Ext «DC», 3 = Ext «AC», 4 = 0,
x 0 x 0 1 1 1	D0/D3 D4/D6	Level : 16 steps of 10 dB AM Source : 0 = AF 1 = 1 kHz, 2 = Ext «DC», 3 = Ext «AC», 4 = 0, 6 = VOR

INPUTS COMING FROM REGISTERS CARD (R/W = 1)

Hexadecimal Address (x = «don't care»)	Data Line	Function
x x 0 0 1 1 1	D0	Test 4 MHz time base Interrupt flip-flop, self-test
	D1	
	D2	
	D3	
	D4	Test 1 kHz lockout or test 2 MHz reference FS approach enablement (unlock FS or FP)
	D5	
	D6	TEST switch Doubling option 100 kHz option
	D7	

OUTPUTS TO REGISTERS CARD (R/W = 0)

Address (x = «don't care»)	Data Line	Function
x x 0 0 0 1 1	D0/D1	RF Range : Division ratio : 0 = 1/4, 1 = 1/2, 2 = 1 3 = x 2
	D2/D5	FM rate correction (0 to 14) or disablement (15)
	D6	Slaving switch : 0 = FM 300 kHz + F 320 MHz F 80 MHz
	D7	VOR modulation
x x 0 0 1 0 1	D0/D1	Interpolator Range : 0 = 0, 1 = 3 kHz, 2 = ± 300 kHz 3 = ± 30 kHz VHF test address (1 to 7) VHF test address — 1 bit on registers card Indicator test Interpolator enablement
	D2/D4 D5	
	D6 D7	
x x 0 0 1 1 0	D2/D7	Attenuation step 2 = 30 dB, 3 = 30 dB, 4 = 20 dB, 5 = 10 dB, 6 = 10 dB, 7 = + 2

OUTPUT TO PROGRAMMING OPTION CARD (R/W = 0).

Address	Data Line	Function
1 1 1 0 1 0 0	D0/D7	Frequency = 100 steps of 10 Hz FM deviation (most significant digits) Enablement of Vernier programming
	D0	
	D1	
1 1 1 0 0 0 1	D2/D3 D4/D7	Free Frequency = 10 steps of 1 Hz (BCD)
1 1 1 0 0 1 0	D0/D7	FM deviation (least signi- ficant digits) (hexadecimal)
1 1 1 0 0 1 1	D0/D6 D7	AM percentage (hexadecimal) AM gain (change to external AM)

OUTPUTS TO ANALOGUE FRONT PANEL CARD (R/W = 0)

Address (x = «don't care»)	Data Line	Function	
0 x x 0 0 0 0	D0 D1 D2 D3 D4/D6 D7	PM Controller 2 saturation RF zero Free FM source Vernier enablement	
	0 x x 0 0 0 1	D0/D1	FM range division ratio : 0 = 1, 1 = 1/2, 2 = 1/4 3 = 1/8. Galvanometer : 0 = FM, 1 = AM, 3 = RF AM : 0 = AF, 1 = 1 kHz 2 = ext. «DC», 3 = ext. «AC», 4 = 0, 6 = VOR Free
		D2/D3	
		D4/D6	
D7			
0 x x 0 0 1 0	D0/D3 D4/D7	Level : 9 steps of 0.1 dB Level : 9 steps of 1 dB	

JUMPER TEST ON ANALOGUE FRONT PANEL CARD

Hexadecimal address (x = «don't care»)	Data Line	Function
0 x x 0 0 1 1	D7	Jumper test (modulation calibration)

EXTERNAL INPUTS - OUTPUTS

ORIGIN/ DESTINATION	ADDRESS	FORMAT	DEFINITION	
IEEE BUS I/O	WRITE DATA AND ADDRESS	RW6543 210	7 6 5 4 3 2 1 0	
		0 0011 000	INT BO GET — APT CMD END BI	R0W INTERRUPT MASK
		0 0011 001	lsbe dal dat 16 8 4 2 1	R4W ADDRESS
		0 0011 010	dssel to lo — hlda hda — apte	R2W ADDRESSING MODE
		0 0011 011	7 6 5 4 3 2 1 0	R6W PARALLEL IDENTIFICATION
		0 0011 100	— — — — — — — —	R1W not used
		0 0011 101	7 rsv 5 4 3 2 1 0	R5W SERIAL IDENTIFICATION
		0 0011 110	Reset rldr rfdi dacr msa rti dacd Fget	R3W AUXILIARY COMMAND
		0 0011 111	7 6 5 4 3 2 1 0	R7W DATA OUTPUT
		ADDRESS WRITE	1 0011 000	INT BO GET — APT CMD END BI
1 0011 001	— — lo 16 8 4 2 1		R4R ADDRESS SWITCHES	
1 0011 010	ma to lo ATN TACS LACS LPAS TPAS		R2R ADDRESSING STATUS	
1 0011 011	7 6 5 4 3 2 1 0		R6R DIRECT READING OF COMMANDS	
1 0011 100	UACG REM LOK — RLC SPAS DCAS UUCG		R1R STATUS OF COMMANDS	
1 0011 101	7 rsv 5 4 3 2 1 0		R5R SERIAL IDENTIFICATION	
1 0011 110	reset DAC DAV RFD msa rti ulpa Fget		R3R AUXILIARY COMMANDS	
1 0011 111	7 6 5 4 3 2 1 0		R7R DATA INPUT	
READ DATA	1 0101 XXX		7 6 5 4 3 2 1 0	READ REGISTER
OUTPUT TO AUX. PLUG	1 0111 XXX		80 40 20 10 8 4 2 1	AUXILIARY REGISTER

WRITE
Done in two stages :
1) address and data written in «write» registers, transfer to coupler bus by the photocouplers,
2) reading of «read» register

READ
Also done in two stages :
1) writing of address and transfer. Microprocessor reads a data item having no significance,
2) reading of «read» registers containing the expected data item.

INTERNAL INPUTS/OUTPUTS

Address					Format								
15	14	13	12	R/W	7	6	5	4	3	2	1	0	
XX01	XXXX	XXXX	X000	0	0	i	Mode	N/D	S	P/R	Control Register No. 3 or 1		
XX01	XXXX	XXXX	X001	0	0	i	Mode	N/D	S	1/3	Control Register No. 2		
XX01	XXXX	XXXX	X010	0	15	14	13	12	11	10	9	8	Pre-positioning of the 3 counters (definition of counting rates)
XX01	XXXX	XXXX	X011	0	7	6	5	4	3	2	1	0	
XX01	XXXX	XXXX	X100	0	15	14	13	12	11	10	9	8	
XX01	XXXX	XXXX	X101	0	7	6	5	4	3	2	1	0	Register No. 2
XX01	XXXX	XXXX	X110	0	15	14	13	12	11	10	9	8	Register No. 3
XX01	XXXX	XXXX	X111	0	7	6	5	4	3	2	1	0	
XX01	XXXX	XXXX	X000	1	—	—	—	—	—	—	—	—	not used
XX01	XXXX	XXXX	X001	1	IRQ	0	0	0	0	IRQ	IRQ	IRQ	Status Register
XX01	XXXX	XXXX	X010	1	15	14	13	12	11	10	9	8	Counter No. 1
XX01	XXXX	XXXX	X011	1	7	6	5	4	3	2	1	0	
XX01	XXXX	XXXX	X100	1	15, 14	13	12	11	10	9	8	8	Counter No. 2
XX01	XXXX	XXXX	X101	1	7	6	5	4	3	2	1	0	
XX01	XXXX	XXXX	X110	1	15	14	13	12	11	10	9	8	Counter No. 3
XX01	XXXX	XXXX	X111	1	7	6	5	4	3	2	1	0	
XX00	1XXX	XXXX	XXXX	X	X	X	X	X	X	X	X	X	Reset Flip-Flop*

MCM
6840
TIMER

* Appearance of this address causes "RAM ENABLE" signal to be reset to zero, which prevents subsequent operation of the microprocessor and writing into RAM memory, which is preserved if supply fails. The +5 V potential must vanish and be re-established in order to exit from this blocked state.

