

Re-edited by PD2MRX for adobe acrobat, 2004-2005.
PA2MRX, from 2006.

THE “AVO”
VALVE TESTER Type 160
NSN: 6625-99-943-2419

WORKING INSTRUCTIONS

SECOND EDITION



PUBLISHED BY
AVO LIMITED.

AVOCET HOUSE, 92-96 VAUXHALL BRIDGE ROAD, LONDON, S.W.1

Telephone: VICtoria 3404-9

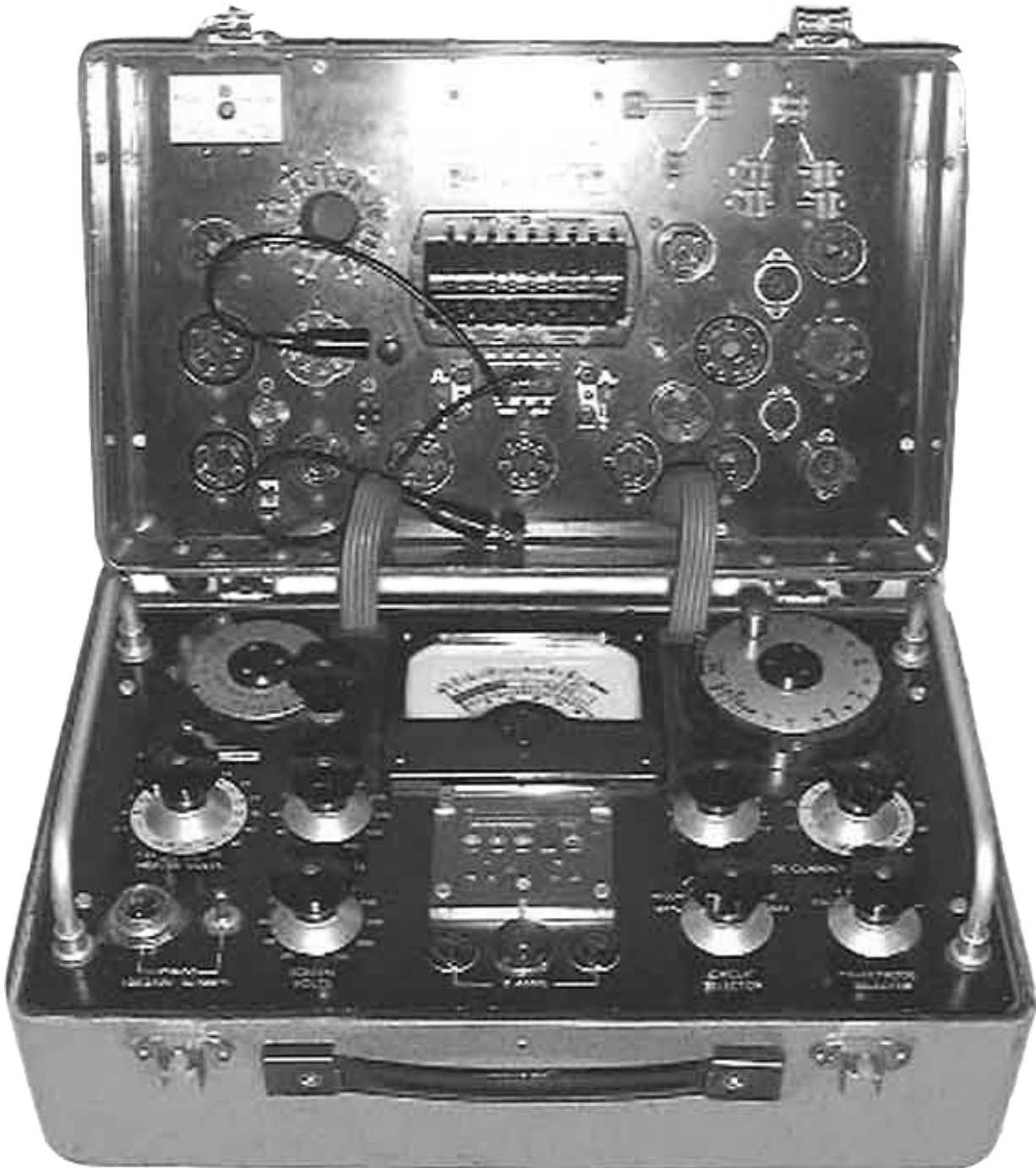

THE "AVO" VALVE TESTER TYPE 160.

FOREWORD

For more than a quarter of a century we have been engaged in the design and manufacture of “AVO” Electric Measuring Instruments. Throughout that time we have consistently pioneered the design of modern multi-range instruments and have kept abreast of and catered for the requirements of the epoch-making developments in the field of radio and electronics.

The success of our steadfast policy of maintaining high standards of performance in instruments of unexcelled accuracy, and making such instruments available at reasonable cost, is reflected in the great respect and genuine goodwill which “AVO” products enjoy in every part of the world.

It has been gratifying to note the large numbers of instances where the satisfaction obtained from the performance of one of our instruments has led to the automatic choice of other instruments from the “AVO” range. This process, having continued over a long period of years, has resulted in virtual standardization on our products by numerous Public Bodies, The Services, Railway Systems, and Post Office and Telegraph Undertakings throughout the world.

Our designers have thereby been encouraged to ensure that new instruments or accessories for inclusion in the “AVO” range fit in with existing “AVO” apparatus and serve to extend the usefulness of instruments already in use. Thus, the user who standardizes on “AVO” products will seldom find himself short of essential measuring equipment, for, by means of suitable accessories, his existing equipment can often be adapted to meet unusual demands.

It is with pleasure that we acknowledge that the unique position by “AVO” is due in no small measure to the co-operation of so many users who stimulate our research and Development staffs from time to time with suggestions, criticism, and even requests for the production of entirely new instruments or accessories. It is our desire to encourage and preserve this relationship between those who use “AVO” instruments and those who are responsible for their design and manufacture, and correspondence is therefore welcomed, whilst suggestions will receive prompt and sympathetic consideration

THE "AVO" VALVE TESTER TYPE 160

CONTENTS

		<i>Page</i>
Summary of Data	5
CHAPTER 1	TECHNICAL DESCRIPTION	
1	Introduction	7
2 – 9	Principles of operation	7
10 – 21	Basic circuits	8
22 – 25	The Valve Holder Panel	13
26	General Construction	17
27	Mains Supply	17
CHAPTER 2	THE VALVE PANEL AND CONTROL UNIT	
28 – 33	The Valve Panel and Selector Switch	20
34 – 36	Procedure for setting up Valve Base Connections	21
37	Provision for new Valve Bases	23
38	The Control Unit and its Function	23
39 – 41	The Mains Voltage Selector	23
42 – 47	The Circuit Selector	24
48	The Electrode Selector	24
49	The Heater Voltage Switches	24
50	The Anode and Screen Voltage Switches	25
51 – 52	The Anode Current Controls	25
53	The Negative Grids Volts Control	26
54	The Set mA/V Control	26
CHAPTER 3	OPERATING INSTRUCTIONS AND GENERAL PROCEDURE FOR TESTING A VALVE	
55	The connection of the instrument to a supply voltage	27
56	Final setting of Main Voltage Selector Panel	27
57 – 59	Insulation checks with the valve cold	27
60 – 61	Insulation checks with the valve hot	28
62	Cathode to Heater insulation check	29
63 – 69	Determination of valve condition from Static Characteristic Data	29
70 – 71	To check relative goodness of valve in conjunction with coloured comparison scale	30
	(a) Using recommended anode current	30
	(b) Using recommended negative grid voltage	30
72 – 73	To check valve by direct reading of mutual conductance (mA/V)	
	(a) Using recommended anode current	31
	(b) Using recommended negative grid voltage	31
74 – 75	To check valves having a mutual conductance less than 1mA/V	31
76 – 77	Measuring the grid current	32
78 – 84	Checking Power Rectifiers	32
85	Checking Signal Diodes	33
86	Instructions for testing specific valve types	33
87 – 88	Multiple Diodes and Rectifiers (D, DD, DDD, R, RR)	33
89 – 91	Diodes and Rectifiers combined with other electrode assemblies (DT, DDT DP, DDP, DTP)	34
92	Double Triodes and Double Pentodes (TT, TP)	34
93 – 97	Frequency Changers (H, TH, O, TP)	34
98 – 99	The use of the links on the Valve Panel of the Instrument	35
100	Checking Tuning Indicators (TI)	35
101	Checking Gasfilled Rectifiers (GR)	36
102	Checking Cold Cathode Rectifiers (CCR)	36

THE "AVO" VALVE TESTER TYPE 160

SUMMARY OF DATA

Purpose

A simple-to-use, double purpose Valve Tester with two functions: ---

- (a) The rapid diagnose of the condition of a valve under test, the instrument operating as a simple "go" or "no go" device.
- (b) The production of sufficient data to enable an operator to plot static characteristics, or similar information, using selected anode loads.

The instrument will check the majority of receiving valves, and some small transmitting valves.

Description

The instrument, which has been constructed to conform with appropriate clauses of the U.K. Government Climatic Tests K114, is housed within a metal carrying case.

The case comprises two parts, the base containing the panel which carries the majority of the control, and the lid, within which is housed the test panel for the valve under test.

The instrument is supplied with a cable for connection to the mains.

The majority of the 22 valve bases provided, accommodate valves on standard bases in common use, but in addition, disc-seal, co-axial and wire-ended valves can also be tested. A Nine Way Roller Selector Switch is provided to enable any valve pin to be connected to any electrode circuit. This Selector Switch is marked with figures and letters, the figures enabling code numbers to be set up from the "AVO" Valve Data Manual, whilst the letters signify the particular electrode connected to the selected pin.

The instrument control panel carries the following: ---

- The Heater Volts Selector Switch.
- The Anode Volts Selector switch.
- The Screen Volts Selector switch.
- The Negative Grid Volts Control.
- The Mains Voltage Selector.
- The Fuse Carriers.
- The Visual Faults indicator.
- The Indicator Meter.
- The Anode Current Controls.
- The Set mA/V (slope) Control.
- The Circuit Selector Switch.
- The Electrode Selector Switch
- The Mains ON/OFF Switch.

Performance

In addition to the detailed description of the instrument, contained in this Manual, abbreviated working instructions are given as a preference to the "AVO" Valve Data Manual.

The instrument will: --

- (1) Check heater continuity.
- (2) Measure insulation between electrodes with valve cold.
- (3) Measure insulation between electrodes with valve hot.
- (4) Measure cathode/heater insulation (for directly heated valves)
- (5) Rapidly indicate whether a valve is good or bad, use being made of a coloured replace/good scale with mutual conductance as a operative parameter.
- (6) Measure the mutual conductance (slope) of a valve, the applied incremental grid voltage being inversely proportional to the “slope” of the valve.
- (7) Measure anode current in single and multi-anode valves.
- (8) Produce sufficient data to enable static characteristic curves to be plotted on graph paper.
- (9) Check rectifiers and diodes under load conditions.
- (10) Measure gas current, limited to 100 μ A.
- (11) Measure screen current.

The instrument is fitted with an automatic aural and visual warning device which operates if certain circuits within the instrument are inadvertently overloaded by the operator, or if a short occurs upon a valve under test.

The use of specially designed circuits virtually eliminates the possibility of the valve under test bursting into spurious oscillation.

Power requirements

The instrument will operate from the following 50 – 500c/s AC supplies: --
105 – 120V, 175 – 250V (Adjustment can be made at every 5V.)

Power consumption

50 Watts, maximum

Physical data

Weight: 24 LBS. (11Kg.) (approx.)
Height: 10” (25,5cms.)
Depth: 11½” (29,5cms.)
Width: 15½” (37,0cms.)

Joint Services Designation

“AVO” Valve Tester CT160.



CHAPTER 1

TECHNICAL DESCRIPTION

Introduction

1. Whilst good/bad testing on a semi-production basis will undoubtedly be the major use of this tester, it is certain that the instrument will find considerable use in laboratories and service departments where engineers and skilled personnel will be available, and where more precise details of valve performance can be used to advantage. To this end, additional facilities on the tester, enable $1a/V_a$, $1a/V_s$, $1a/V_g$ characteristics to be plotted over a wide range of voltages, these being readily available from the calibrated panel controls.

Principles of operation

2. The tester is basically designed to check the valve according to its static characteristics which would normally require the provision of the requisite range of variable DC supplies. The difficulty lies in the regulation problems involved in the supply of the wide range of DC anode and screen voltages, on which the loading might vary from a fraction of a mA to over 100mA, dependent on the type of valve being tested, and the provision of a number of regulated power supplies, which would render the instrument cumbersome and expensive, whilst a large amount of metering, and would not only mean additional expense, but also make the instrument difficult to use, and would not entirely overcome the problem.

3. It can be shown, however, that if alternating electrode voltages are supplied in their correct proportions, an amplifying valve van (by virtue of its property of self rectification) be caused to give DC anode and screen currents which for all practical purposes bear a constant relationship to those obtained from its DC static characteristics.

4. This immediately simplifies the problem of power supply to the valve under test. The design of transformers to give negligible regulation errors over the range of secondary currents involved is comparatively simple, whilst the range of electrode voltages may be simple provided by predetermined secondary tapings selected by calibrated switches, thus minimizing to a very large extent problems of size, weight and cost, and eliminating the necessity for separate metering.

5. A slight difficulty occurs in the power supply of the variable negative grid bias valve. Which would normally consist of an alternating voltage of suitable magnitude applied in anti-phase to the anode voltage. Since rectification occurs at the anode (and screen) and the grid should pass no current it will be readily seen that during the half cycle where the anode and screen are passing no current, a positive half cycle of considerable magnitude is applied to the grid with the result that the latter can pass damaging current and in certain circuit conditions phase changes can occur that disturb the 180° relationship between the anode and grid voltages during the operative half cycle.

6. Since no current is taken from the grid voltage supply however, and the voltages involved are not very high, the inclusion of a simple half wave rectifier without smoothing between the transformer winding and the variable grid volts supply will suppress the positive half cycle whilst still remaining the sinusoidal form of the operative negative half cycle.

7. Using the simple expression for anode current of a triode $I_a = \frac{K}{R_a} (E_a + \mu E_g)$ and transforming this for AC operations on the positive half cycle of applied anode volts we have:---

$$I_a \text{ (mean)} = \frac{K}{R_a} \frac{\omega}{\pi} \left\{ \int_{\omega t=0}^{\omega t=\pi} E_a \sin \omega t + \mu \int_{\omega t=0}^{\omega t=\pi} E_g \sin \omega t \right\}$$

8. Deriving this in terms of RMS applied voltages and remembering that anode current flows only on the positive half cycle and will be read on a mean reading DC meter, we have:--

$$I_a \text{ (mean)} = \frac{K}{2R_a} \left\{ E_a^{(RMS)} \times \frac{1}{1.1} + \mu E_g^{(DC)} \times 2 \right\}$$

E.g. (DC) is the applied half sine wave DC as read on a mean reading DC voltmeter, K being a constant. The above relation holds equally well for screen grid of pentode valves, which would allow the general form

9. Thus with an applied RMS anode (and or screen) voltage equal to $1.1 \times V_a(\text{DC})$ and mean value of half wave rectified bias voltage equal to $0.5 \times V_G(\text{DC})$ then the valve will read a mean DC anode current equal to one half of the DC anode current taken from the static characteristics if $V_a(\text{DC})$ and $V_G(\text{DC})$ were applied DC test volts. This relationship holds for all practical purposes over the full characteristics and is the basis of operation of the VT160 enabling accurate testing of valves, at any point on their characteristic, with simple and small apparatus. This accuracy is just as necessary on the simple “go”/”no go” type of instrument as a complete characteristic meter, as it may be necessary to set the test point anywhere on the characteristic to correspond to required working condition. Further in the absence of any printed or predetermined test figure, it must be possible to determine test conditions directly from manufacturers published curves of data.

Basic circuitry

10. The principles of operation of the main function of the tester – the comparative testing of mutual conductance – lie in the application of anode, screen and heater voltages corresponding

to the working point of the valve and backing off to zero the standing anode current thus obtained. A small incremental bias is applied to the valve and the change in anode current thus obtained is a measure of the mutual conductance of the valve. The figure is then compared with the correct mutual conductance to give comparative goodness on a coloured scale.

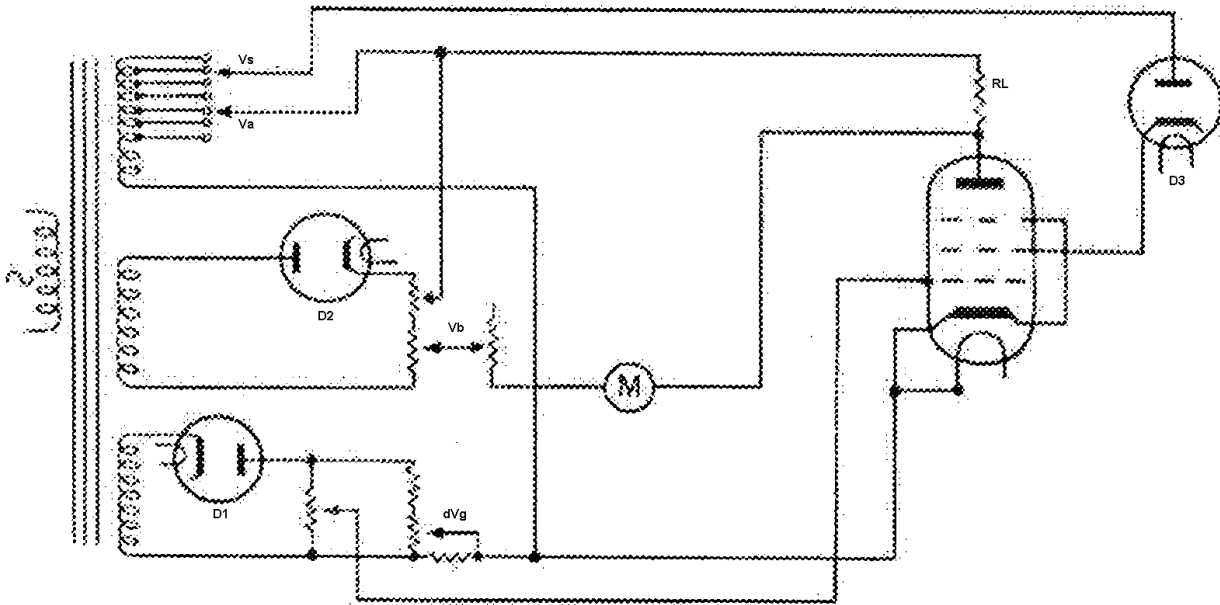

FIG. 1.

BASIC CIRCUIT FOR CHECKING OF MUTUAL CHARACTERISTICS

11. figure 1 shows the fundamental circuit used in this measurement. With a requisite electrode voltage applied to the valve, the half wave anode current causes a voltage drop in resistor RL , which is sufficiently low resistance not to influence the characteristics. This voltage is backed off by a voltage of similar form from the Control V_b . The voltage difference across the two arms of the bridge thus formed is shown on the DC millivoltmeter M . When this difference is zero, the voltage V_b is a measure of the anode current in RL ($I_a = V/RL$) and the control V_b is thus calibrated in mA anode current.

A small change in bias is then applied to the valve from control dV_g which causes an increased voltage drop in RL which unbalances the bridge. This unbalance is shown on M and is a measure of the mutual conductance of the valve. For a deflection on M of RL millivolts then the mutual conductance of the valve in mA/V is $1(\text{volts})/dV_g$. In practice the f.s.d. of M is 130% RL millivolts and the scale is zoned in three colours – green from 130% to 70% indicating a good value, white from 70% to 50% representing a failing valve, and red below 50% indicative of a reject. Thus the operating procedure after backing off the initial anode current is to set control dV_g (calibrated in mA/V to a maximum of 20) to the rated mutual conductance and note the deflection on the coloured scale of M , to determine valve goodness.

12. This arrangement, which gives an incremental grid voltage inversely proportional to slope, avoids errors otherwise likely to occur on high slope valves which often exhibit marked curvature of characteristics.

13. The stopper diode D3 shown in the screen supply circuit in figure 1 is to prevent erroneous results, and possible valve overheating and damage, that can occur when testing certain beam tetrode valves with alternating anode and screen voltages.

14. As the applied electrode voltages approach zero during a portion of the operative cycle, the focusing of the electrode beam is to some extent upset with the result that the screen current decreases, and rapidly becomes negative. The rectifier, whilst presenting negligibly low forward impedance to normal screen current, by virtue of its high reverse impedance successfully prevents the flow of reverse screen current.

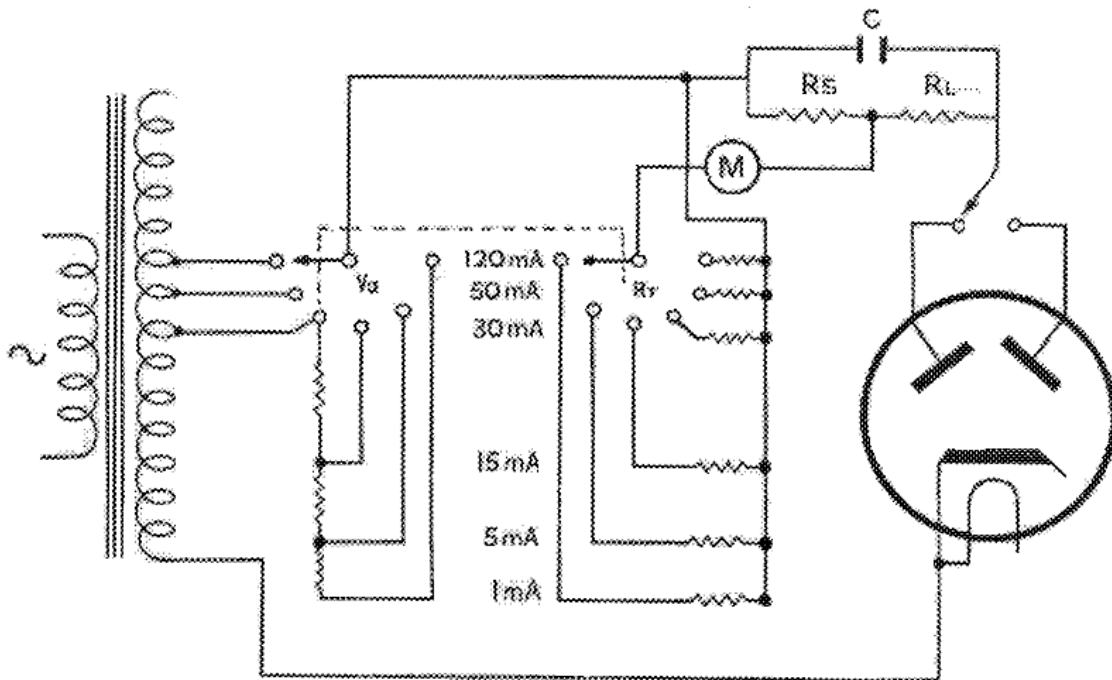

FIG. 2

BASIC CIRCUIT FOR THE TESTING OF RECTIFIERS AND SIGNAL DIODES.

15. Figure 2 shows the basic circuit of the rectifier test. The rectifier is loaded with a resistor $R_S + R_L$, and a reservoir capacitor C in parallel. Sinusoidal voltage V_a is applied of sufficient magnitude to operate the rectifier on the linear portion of its characteristics, so that the combination should pass a rectified current equal to the maximum load current of the valve.

The millivoltmeter M measures the voltage developed across a proportion of the load R_L and is scaled by the appropriate range resistor R_T so that the rated current through the load will deflect M to the middle of the “good” zone of the scale. The proportionate deflection of the coloured scale donates the state of the valve as before. Switching of anode voltage meter range and load is ganged so that rectified currents of 1mA, 5mA, 15mA, 30mA, 60mA and 120mA per anode are available, each anode of a full wave rectifier being tested separately. The 1mA and 5mA ranges are suitable for signal diode testing.

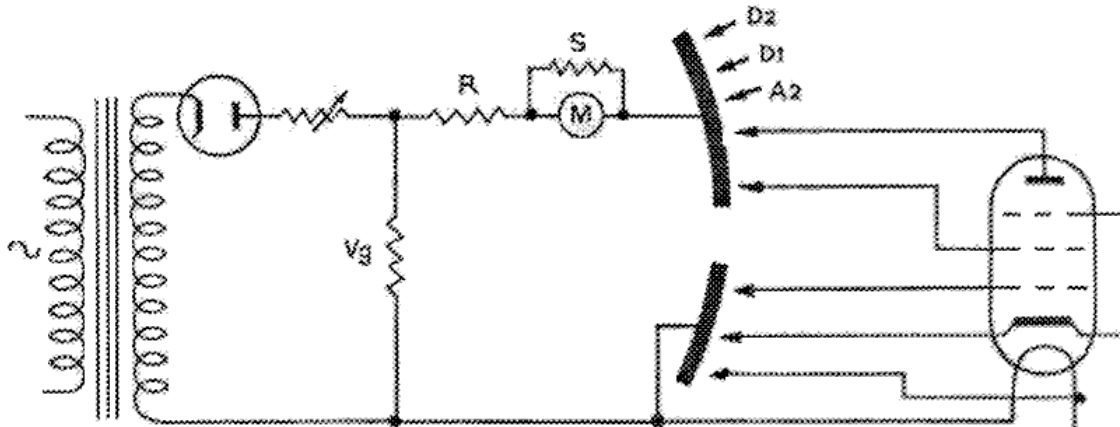

FIG. 4

16. For the checking of inter-electrode insulation (figure 4) the unidirectional grid voltage V_g is applied through the meter M suitably loaded by a shunt(s) and high series resistor (R) across the electrode groups, between which the insulation is to be measured. V_g , S and R are such that the first meter indication is at 25MO, full scale of course representing a dead short. The meter is suitable scaled for direct reading between these limits. This test serves for heated continuity and insulation measurements between anode and all other electrodes strapped, and screen and all others with the valve cold. With heater volts applied, the normal cathode/heater test is made, whilst a further test of cathode and heater strapped/rest takes care of sagging grids or filaments of directly heated valves. Since a short circuit deflection is, in fact, a measure of the grid voltage, this is used in checking of the setting of the main voltage if the instrument is in position “Set ~”, in this condition a short is put on the insulation test circuit, and the mains selector is adjusted until the meter reads full scale deflection, at which point the grid voltage and therefore all other voltages working the instrument are correctly proportioned.

17. The full circuit (figure 3) shows how all the above combinations are incorporated in a single circuit, and selected by appropriate switch settings. Despite the full range of test voltages available and the comparative complexity of the circuit, the discreet use of ganged controls has reduced the operation to a simple and logical sequence.

18. Figure 5 shows in diagrammatic form the panel marking and it will be seen there from that in addition to the controls supplying the appropriate electrode voltages, only three controls are really involved in a measurement. The CIRCUIT SELECTOR rotates through the various insulation checks to position TEST, at which point the circuit is operative for mutual conductance testing by backing off with the ANODE CURRENT controls and by setting control SET mA/V, at which point the meter shows the valve goodness. Separate electrode systems of dual or multiple valves are measured by setting the ELECTRODE SELECTOR to A1 or A2. With this switch to D1 or D2 the circuit is ready for rectifier or signal diode testing, with the CIRCUIT SELECTOR at TEST. The selection of load current is made by rotating the anode current control (also separately scaled in rectifier load current) to the appropriate position, valve goodness being immediately shown on the same coloured meter scale.

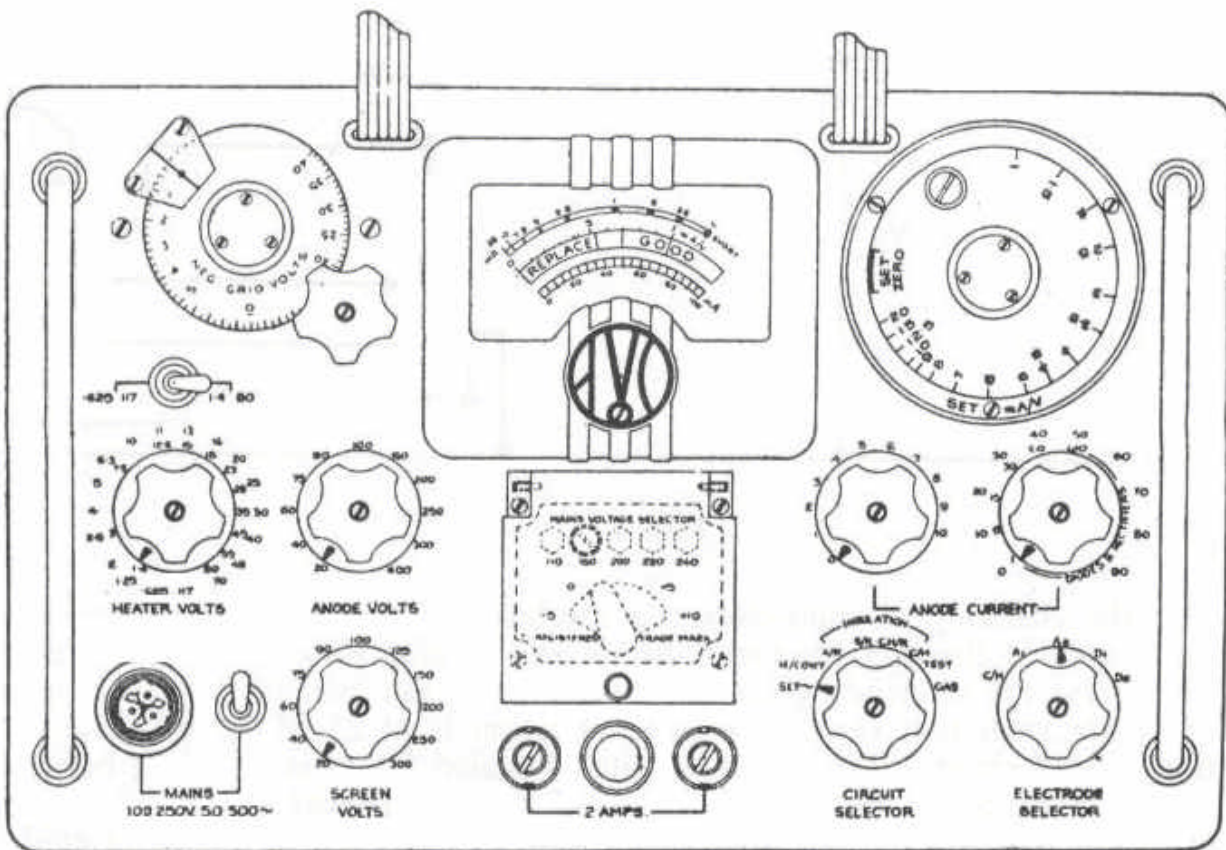

FIG. 5

19. The rotary control SET mA/V is of the spring return type, and once a test has been made, automatically returns to its start position at which point the measurement circuit is shunted to a safety condition. This if a subsequent is carelessly attempted with circuit wrongly set or if for instance a "gassy" valve is tested, this will be shown up before the circuit is put in a sensitive condition for mutual conductance testing and no damage will result to the instrument.

20. The final position of the CIRCUIT SELECTOR (market GAS) places the meter M, shunted as a micro-ammeter, in series with a resistor in the grid circuit of the valve being tested and allows the direct measurement of grid voltage in μA .

21. Further examination of figure 3 will show the inclusion of a safety relay with windings RL2 and RL3 in the screen and anode circuits respectively. Overloads (due to conditions of valve failure or misuse) associated with either or both of these circuits will trip the relay. This connects a high resistance lamp in series with the transformer primary windings, assisted by a hold off winding RL1 at the same time making a red warning light visible through the meter scale. This places the whole instrument in a safety condition. Normal working cannot be restored until the instrument has been switched off, the fault removed, and the instrument switched on again.

The Valve Holder Panel.

22. The valve holder panel by means of which the valve is connected to the test circuit comprises 22 valve bases covering all valves likely to be encountered in normal use, including disc seal and wire ended valves. The holders are wired with their corresponding sockets according to standard numbering, in parallel.

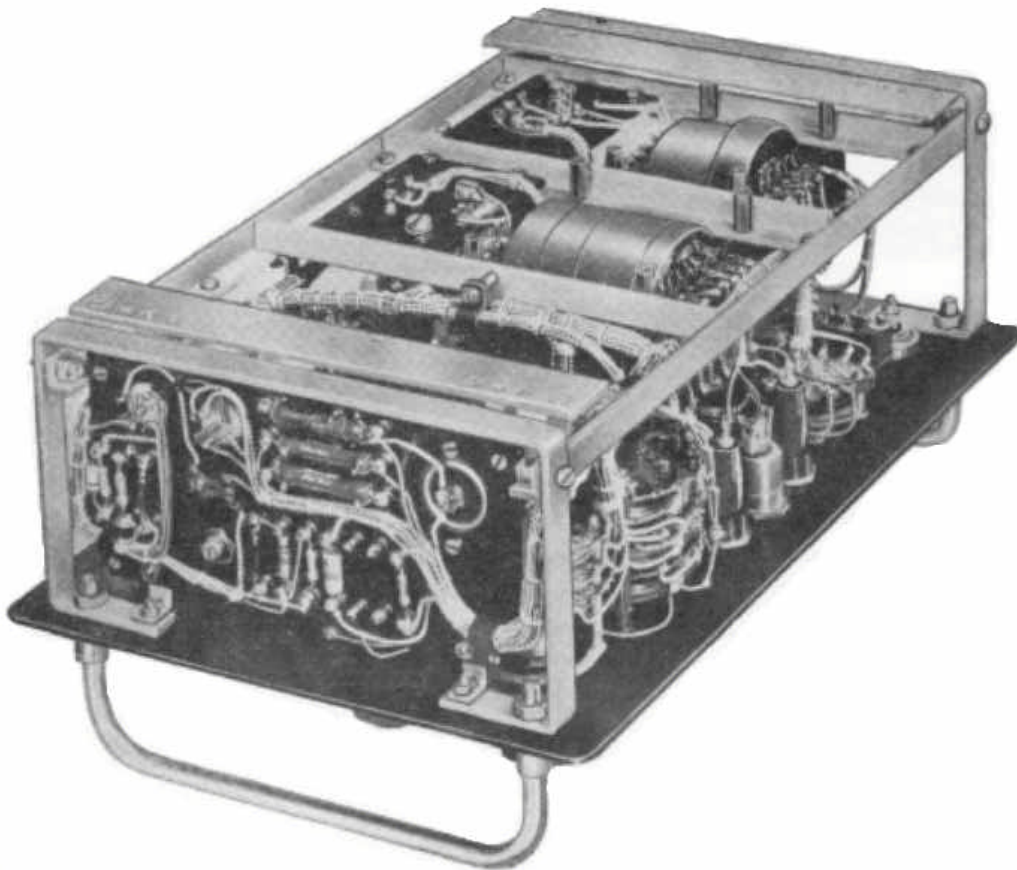

FIG. 6.
INSTRUMENT CHASSIS

23. The wire connection loops thus formed are connected to the wiper rotors of the multi-way selector switch. Associated with these rotors are ten stators: nine of which are each connected

to an electrode test circuit, the tenth one being open circuited. The rotors are in the form of edge operated rollers each having nine electrode denominations marked in symbols round their periphery, the operative selection appearing in a window. Thus any valve holder with pins up to nine, can be set up to any electrode combination, the open circuit connection serving for valves with internally connected pins.

24. The problem of self-oscillation that can occur with high slope valves at random high frequency, due to the inter-valve holder wiring, has been virtually eliminated by wiring the panel in connection loops of approximately similar length and configuration, so that a valve would tend to oscillate at a frequency dependent on the line thus formed. These wiring loops are then closed on themselves via a connector loaded to give high loss, and thus lower the Q of the line, so that oscillation is virtually impossible.

25. A manual is provided with a line of data for each valve likely to be encountered giving the mutual conductance and operating voltages. The data given comprises the pin combinations in the order of their standard numbering and in the form in which they appear on the roller selector switch window: top cap or side contact connection of any heater volts; anode volts; screen volts; negative grid volts; operating anode current and mutual conductance (or load current in the case of a rectifier). Where multiple electrode assemblies are concerned test figure for each assembly is given. In the case a valve is encountered that does not appear in the manual, the base connections and manufacturer's or other recommended test data can be directly set up on the controls without any calculations or complexity.

KEY TO FIGURE 7

1. Roller Selector Switch.
2. Disc Seal Valve Holders.
3. Top Cap Connector Panel.
4. Set mA/V Control.
5. Anode Current Controls.
6. Electrode Selector.
7. Circuit Selector.
8. Mains Voltage Selector Coarse Adjustment.
9. Mains Voltage Selector Fine Adjustment.
10. Indicator Lamp
11. Fuses.
12. Screen Voltage Switch.
13. Mains on/off Switch.
14. AC Mains Input Socket.
15. Anode Voltage Switch.
16. Heater Voltage Switches.
17. Negative Grid Volts Control.
18. Panel Indicator Meter.
19. Anode Links.
20. Special Flying Head Valve Holder.

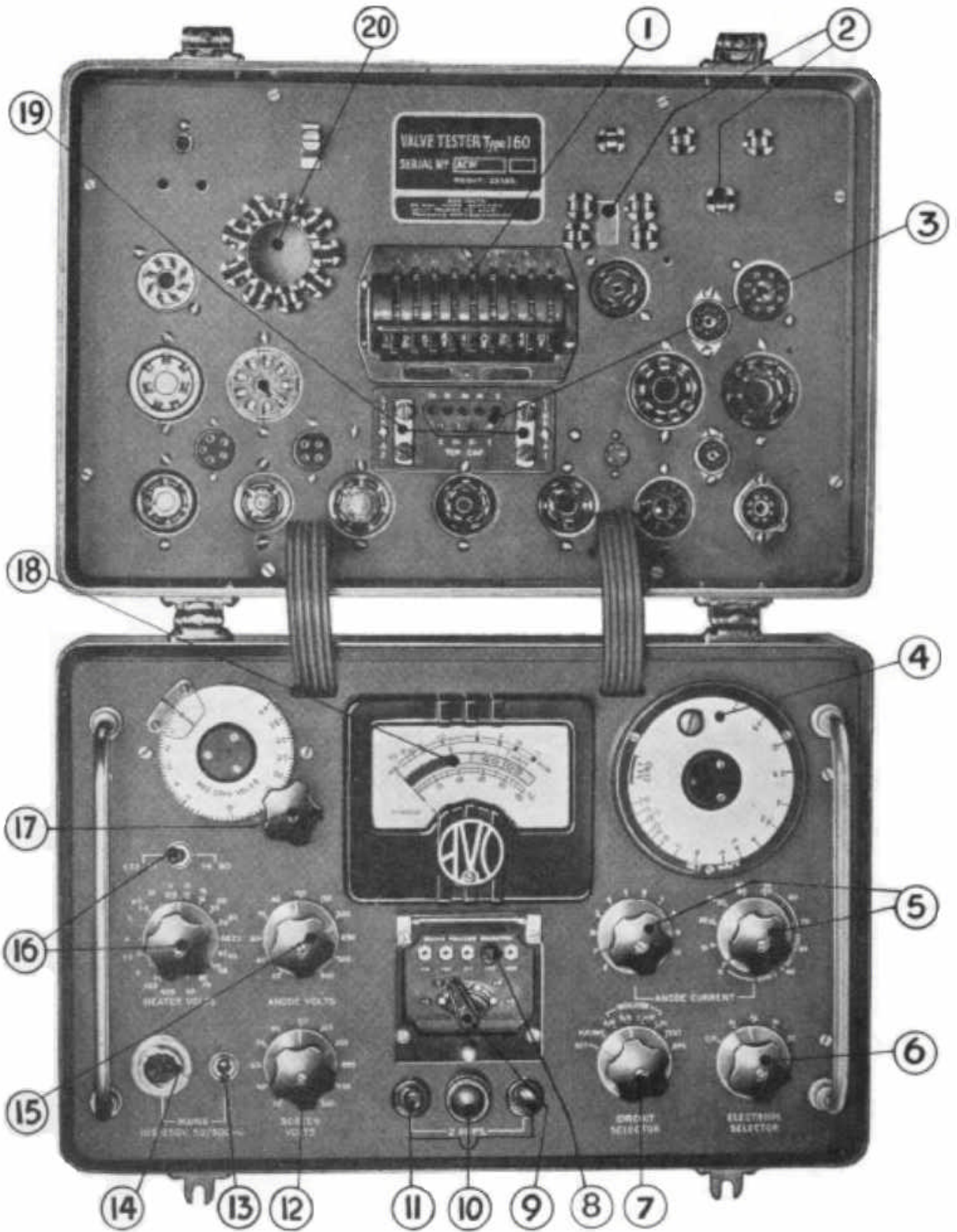
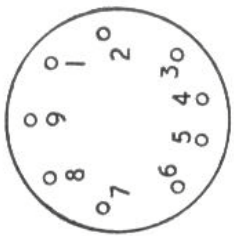
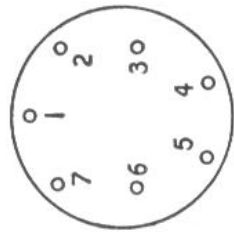

FIG. 7. THE LAYOUT OF THE INSTRUMENT.



BRITISH NINE PIN (B9)



BRITISH SEVEN PIN (B7)

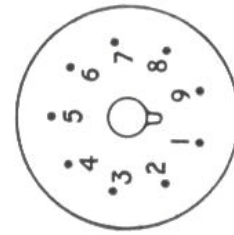

B9G

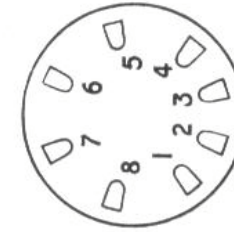

'P' TYPE BASE (8SC)

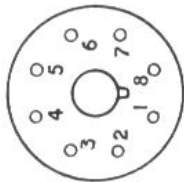

INTERNATIONAL OCTAL (A08)

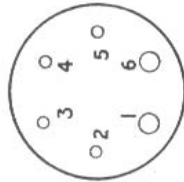

AMERICAN SIX PIN (UX6)

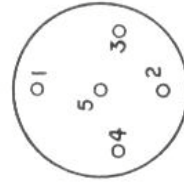

BRITISH 4/5 PIN (B5&B4)

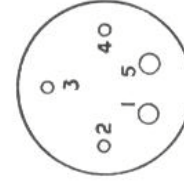

AMERICAN FIVE PIN (UX5)

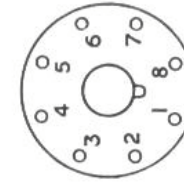

MAZDA OCTAL (M08)

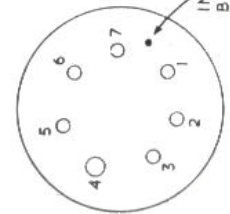

B7A

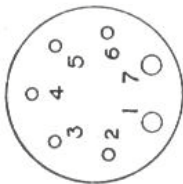

AMERICAN SMALL SEVEN PIN (SM7)

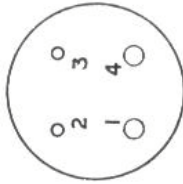

AMERICAN FOUR PIN (UX4)

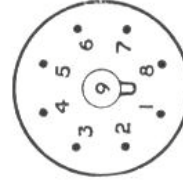

AMERICAN OCTAL (B8B OR B8G)

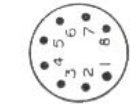

SUB MINIATURE 8 PIN (B8D)

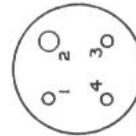

HIVAC FOUR PIN (SM4)

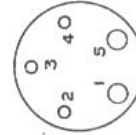

HIVAC FIVE PIN (SM5)

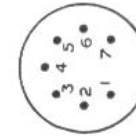

B7G

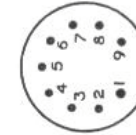

B9A

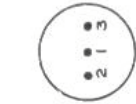

B3G

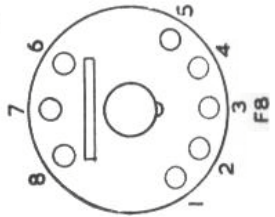

AMERICAN SEVEN PIN (UX7)

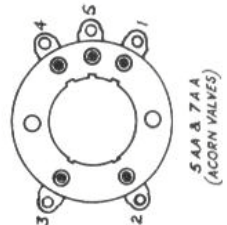

**5AA & 7AA
(ACORN VALVES)**

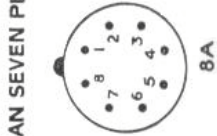

8A



B5A



B5B

General Construction

26. The instrument is designed in suitcase form for portability and ease of stowage. It is of small size and constructed to comply with the requirements of the U.K. Government Climatic Test Specification K.114. When closed it is completely shower-proof. All components likely to require replacement or adjustment in service are conveniently located on sub-assembly boards on the outer framework of the assembly, and are immediately to hand on removing the case, whilst the open framework construction used reduces weight to a minimum and ensures a maximum of accessibility.

Mains supply

27. Special attention to design detail has rendered an instrument suitable for operation on AC mains from 50 – 500 c/s $\pm 10\%$ over the following ranges: --105 --120V, 175 --250V.

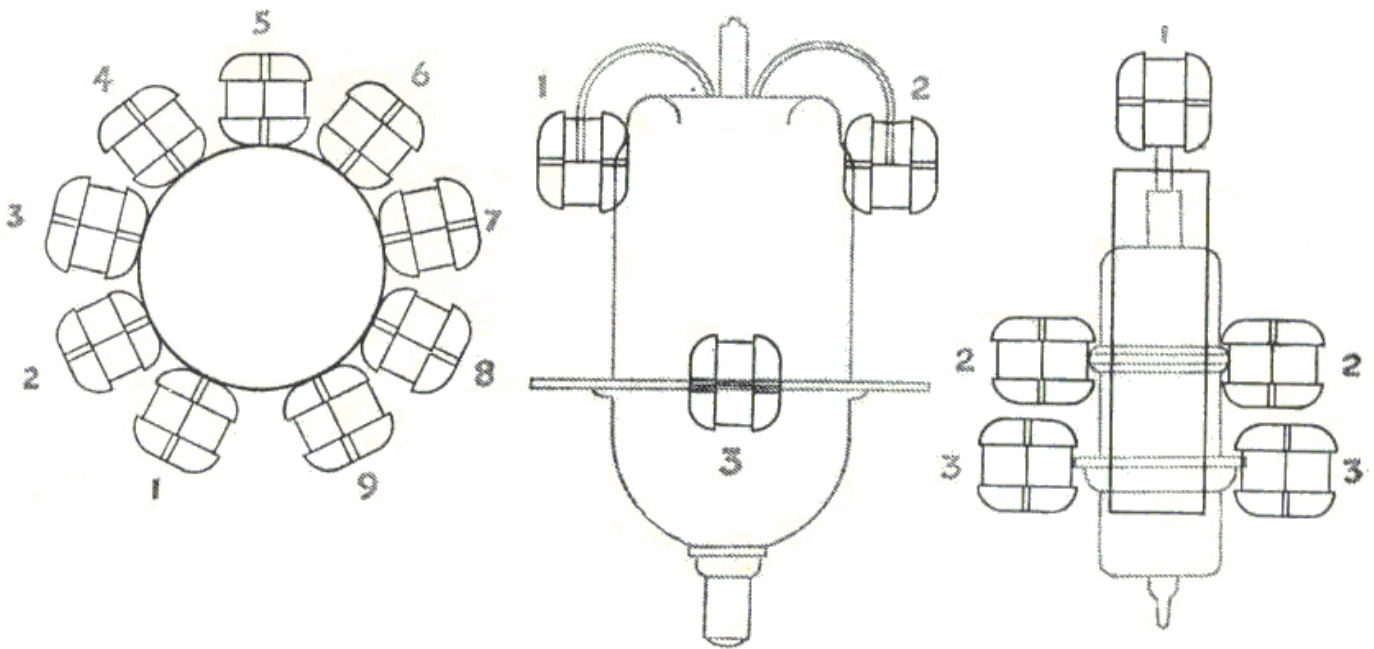

FIG. 9.

DIAGRAM OF CONNECTION FOR SPECIAL VALVE HOLDERS.

(Showing pin connections viewed from above)

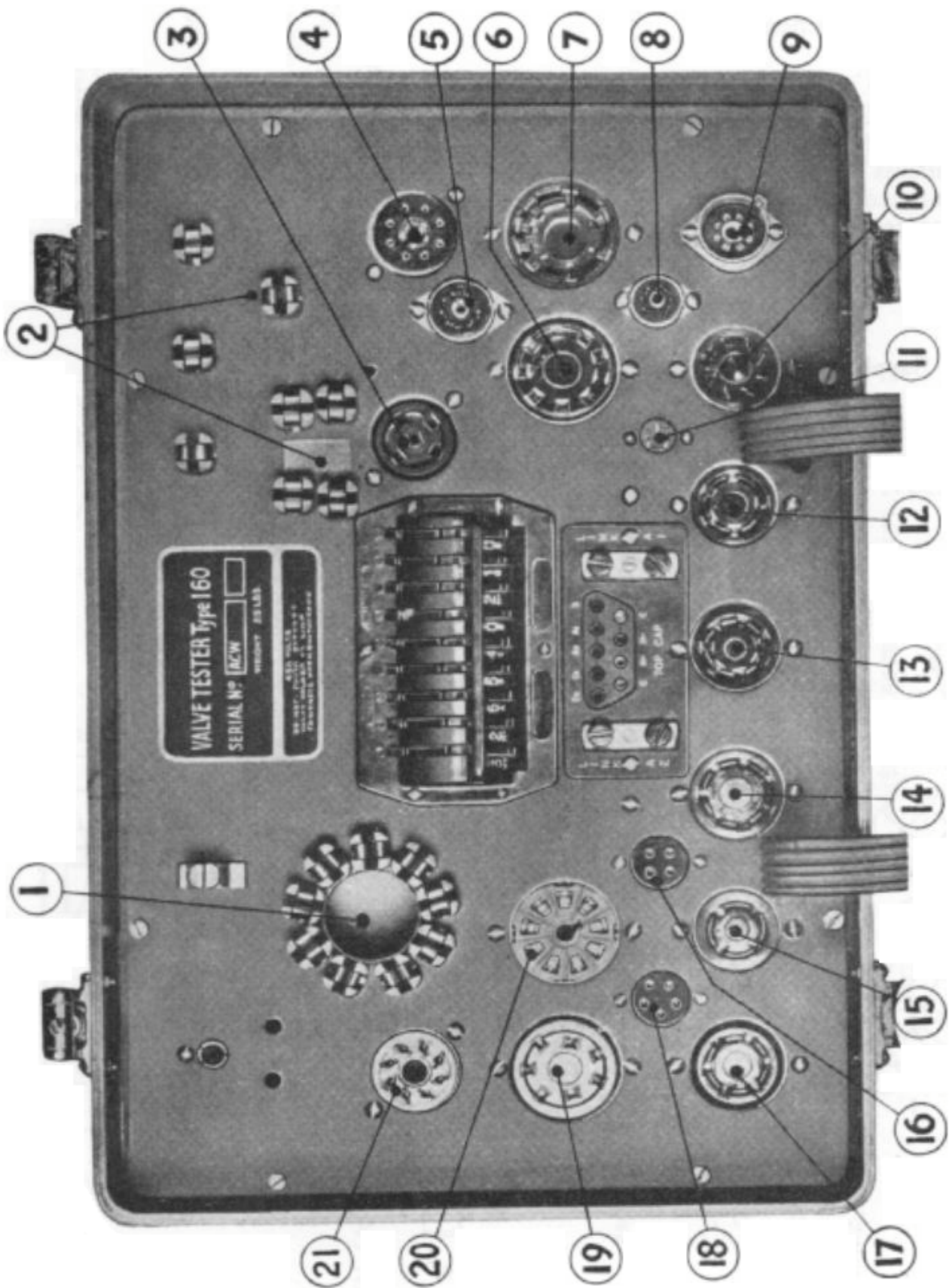

FIG. 10.

VALVE HOLDER PANEL

KEY TO FIGURE 10

Valve holders

1. Flying lead.
2. Disc seal.
3. British four and five pin (B4 or B5).
4. American loctal (B8B or B8G).
5. Miniature nine pin (noval or B9A).
6. British nine pin (B9).
7. Philips "P" type (8SC).
8. Miniature seven pin (B7G).
9. Philips eight pin locking (B8A).
10. Mazda octal (MO8).
11. Miniature three pin (B3G).
12. American five pin (UX5).
13. American small seven pin (Sm7).
14. American medium seven pin (UX7).
15. American four pin (UX4).
16. Hivac Deaf Aid four pin (Sm4).
17. American six pin (UX6).
18. Hivac Deaf Aid five pin (Sm5).
19. British seven pin (B7).
20. All glass nine pin (B9G)>
21. International octal (AO8).

The following valve base adaptors can also be supplied: --

Adaptor No,	Base	Adaptor No,	Base,
5/160	----	10/160	5AA & 7AA (acorn type)
8/160	Continental 8 pin (F8)	11/160	B5A (flying lead type)
9/160	B7A	----	Grid lead and clip for lighthouse triodes

CHAPTER 2

THE VALVE PANEL AND CONTROL UNIT

The Valve Panel and Selector Switch.

28. The Valve Panel comprises 22 valve holders of the following types: -- English 4/5 pin, English 7 pin, English 9 pin, Philips 8 pin side contact, B7G, B8A, B8G (American octal), B9G, B9A, Mazda Octal, International Octal, B3G, Hivac 4 pin miniature, Hivac 5 pin miniature, American 4 pin UX, American 6 pin UX, American small 6 pin UX, American medium 7 pin UX, two disc seal and a special flying lead Valve Holders. (See Figs. 8 and 9 for diagram of standard pin connections.)

29. In the case of the flying lead and disk seal valves (see Fig. 9), the pin numbering sequence corresponding to the set-up Data is printed on the panel adjacent to the appropriate socket. It is assumed that all flying lead valves will be inserted into the appropriate Valve Holder with the envelope pointing downwards, and the wire connections uppermost (corresponding to the normal method of designating valve pin numbers looking into the valve pins)

30. All Valve Holders are wired with their corresponding pins in parallel i.e., all pins numbered 1 are wired together, all pins numbered 2 and so on. This wiring combination is associated with the well known "AVO" MULTI-WAY ROLLER SELECTOR SWITCH which enables any one of the nine standard pin numbers to be connected to any one of the electrode test circuits in the instrument, thus enabling any electrode combination to be set up for all Valve Holders.

31. It will be seen (Fig.10) that the Selector Switch comprises nine thumb rollers, numbered from left to right 1 ~ 9. This numbering appears on the moulded escutcheon immediately behind the rollers, and corresponds to the valve pins in the order of their standard pin numbering. Thus valves with any number of pin connections up to nine, can be accommodated. To cater for Top Cap and other external valve connections, a socket panel has been provided with nine sockets marked D1, D2, A2, A1, S, G, H+, H-, & C. A short lead is provided which is fitted with a plug for insertion into the panel, whilst the remote end of the lead is fitted with a universal connection clip to cater for all types of external valve connections. The socket panel is fitted with two links marked A2 and A1, to which reference is made in section 98.

32. Rotation of the rollers of the Selector Switch will reveal that each roller can be set in any one of ten positions, the appropriate setting being indicated in the window opening at the front of the escutcheon. The ten positions of each roller are marked as under: --

1	2	3	4	5	6	7	8	9	0
C	H--	H+	G	S	A	A1	D1	D2	---

33. The numbers are provided in order that the switch can be rapidly set up from the code numbers give in the Valve Data Manual, the corresponding electrode denominations being shown by the letter which appears in the escutcheon window immediately below the number thus: --

- ¹_C Corresponds to Cathode, or any other earthy electrode normally connected to cathode e.g. G3.
- ²_{H-} Corresponds to Heater, normally earthy, or connected to negative L.T. in the case of a battery valve.
- ³_{H+} Corresponds to the other heater connection or center tap.
- ⁴_G Corresponds to Control Grid.
- ⁵_S Corresponds to Screen Grid, or G2.
- ⁶_A Corresponds to the normal Anode of single or multiple valves. In the case of an oscillator mixer valve, "A" represents the oscillator Anode.
- ⁷_{A2} Corresponds to the second Anode of double valves, and in the case of oscillator Mixer valves, the mixer Anode.
- ⁸_{D1} Corresponds to the first Diode Anode of half and full wave signal Diode and Rectifier valves, Diode and Rectifier/Amplifier combinations.
- ⁹_{D2} Corresponds to the second Diode Anode of Signal Diode and Rectifier valves, Diode and Rectifier/Amplifier combinations.
- ^{*0}_— Corresponds to a dis-connected valve pin or to a pin on which an external Electrode is anchored. Such pins are marked "I.C." in Manufacturer's Literature. This switch position leaves the particular valve pin dis-connected from any circuit.
* Some instruments will be found to be fitted with rollers marked "⁰_E" which can be regarded as being synonymous with "⁰_—".

Procedure for Setting up Valve Base Connections

34. The procedure for setting up a valve ready for test is as follows: -- From some suitable source, i.e. the "AVO" Valve Data manual, Valve manufacturer's Data Leaflet, or any other Manual of Valve Data, determine the pin basing connections for the valves. Rotate the roller of the SELECTOR SWITCH until the code number or electrode letter combination appears in the window, reading from left to right in accordance with the standard pin numbering sequence (see FIG. 8). When a valve has less than 9 pins, the free rollers on the right of the set up combination corresponds to non-existing valve electrodes, and should be set at ⁰... Insert the valve into its appropriate holder (following the sequence laid down in the general procedure for testing a valve, section 55), and by means of the lead provided, connect any top cap or side connection on the valve to its appropriate socket panel. Note that the Loctal Valve Holder which has only 8 normal electrodes, has its center spigot connected to the ninth roller (corresponding to Pin No.9) to accommodate valves which have a connection made to this spigot.

35. The accompanying examples show how to correlate the pin basing data and the equivalent code number for various valves in common use.

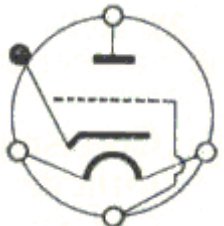
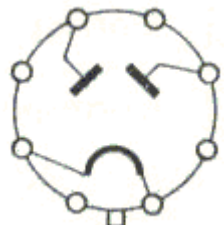
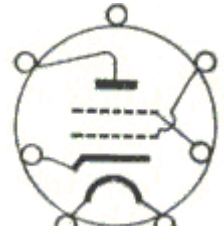
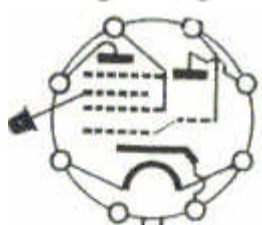
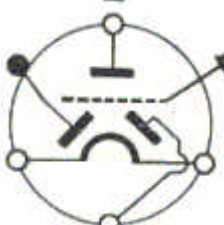
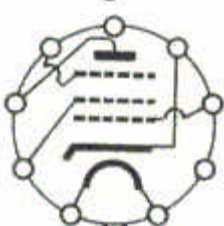
<i>Valve type</i>	<i>Roller Selector Switch Code</i>									<i>Base</i>	<i>Diagram</i>								
Osram MH4 indirectly Heated triode. British 5-pin base.	6	4	2	3	1	0	0	0	0	A	G	H--	H+	C	--	--	--	--	
Osram U50 full wave Rectifier directly heated International Octal base.	0	2	0	8	0	9	0	3	0	--	H--	--	D1	--	D2	--	H+	--	
Mullard pen A4 in-Directly heated output Pentode. British 7-pin base.	0	4	5	2	3	1	6	0	0	--	G	S	H--	H+	C	A	--	--	
Brimar 6K8 indirectly Heated frequency Changer. International Octal base.	0	2	7	5	4	6	3	1	0	--	H--	A2	S	G	A	H+	C	--	
Mullard TDD2A battery Double diode triode. British 5-pin base.	6	8	2	3	9	0	0	0	0	A	D1	H--	H+	D2	--	--	--	--	
Mullard EF50 indirect-Ly heated HF pentode. B9G base.	2	5	6	1	0	1	4	0	3	H--	S	A	C	--	C	G	--	H+	

Note

36. When the SELECTOR SWITCH setting is derived from manufacturer's Data, and a pin connection is shown as "I.C" (internally connected), the roller appertaining to this pin should be set to ⁰... Where a pin connection is an electrode normally connected to cathode e.g. , G3 the roller corresponding to this pin should be set to ¹c.

Provision for New Valve bases

37. Although the Valve panel caters for all valves in common use, the possibility has not been overlooked that new valves and corresponding new bases may appear on the market from time to time. Should such a situation arise, plug-in adaptors will become available commercially which will enable the new valve be plugged into an existing socket on the Valve Panel. Blank adaptors are already available to accommodate non-standard bases not incorporated on the existing Valve Panel. A list of adaptors is given on page 19.

The Control Unit and its Function

38. With the exception of the Roller Selector Switch and other features incorporated on the Valve Panel, all the controls are situated on the Main Panel of the instrument. By the manipulation of these controls, and the use of the Valve Panel, the following tests can be undertaken: --

- (1) Heater continuity.
- (2) The measurement of insulation resistance between electrodes with the valve cold.
- (3) The measurement of insulation resistance between Heater/Cathode to all other electrodes strapped together, with the valve heater at operating temperature.
- (4) The direct indication of cathode to heater insulation with the valve heater hot.
- (5) The direct indication of valve "goodness" on a coloured "good/replace" scale, for complete range of applied H.T. and bias voltages.
- (6) The direct indication of anode current and mutual conductance (mA/V) at pre-Determined combination of H.T. and bias voltages.
- (7) The measurement of control grid current on a scale directly calibrated in μA .
- (8) The testing of half and full wave rectifiers under reservoir capacitor conditions, with a range of DC loads which can be selected by means of a switch.
- (9) The testing of signal diodes with suitable DC loads which can be selected by the operator.
- (10) The testing of the separate sections of multiple valves, the non-operative section of the valve under test being maintained at reasonable working electrode voltages.
- (11) The ability to derive data from which the characteristic curves I_a/V_g , I_a/V_a , V_{g1}/V_{g2} , etc., can be drawn with a range of applied electrode voltages corresponding to DC operating conditions.
- (12) The testing of valves with suitable loads included in the anode circuit, together with the ability to read the required electrode current on a separate external meter. The instrument is, therefore, suitable for making tests on non-standard and Specialized types of valves, not catered for in normal circuit arrangements.

The function of various controls is as follows: --

The Mains Voltage Selector

39. The instrument has been designed to operate from supplies of 50~500c/s over the following ranges: -- 105~120V, 175~290V, 195~210V, 215~230V, 235~250Volts.

40. Access to the Voltage Selector Panel can be gained by turning a thumbscrew and lifting the transparent cover. The Coarse Voltage Selector is marked 110, 180, 200, 230 and 240, whilst a Fine Voltage Selector Arm is marked -5, 0, +5, +10. The settings on this Fine Voltage Selector must be added to the voltage marked under the socket into which the selector pin has been inserted.

For example, if it is desired to operate the instrument on a 230V AC supply, the Coarse Selector Pin should be screwed into the 230V socket and the Fine Selector Arm turned to its +10 position.

41. The Fine Voltage Selector also allows minor adjustments to be made to the input tappings on the main transformer to compensate for voltage variations of the mains. The instrument should be switched off whilst adjustments are made to the *Coarse* MAINS VOLTAGE SELECTOR.

The Circuit Selector.

42. This is an eight-position switch, which determines the type of test to be undertaken on the instrument. All the necessary internal circuit connections are made automatically to satisfy the test condition required, whilst internal test circuits unnecessary to the particular test in hand are removed from the valve.

43. This switch position **SET** ~ enables final mains voltage adjustments to be made. At the H/CONT position, the meter indicates heater continuity. At the position A/R and S/R, and used in conjunction with the ELECTRODE SELECTOR Switch, it is possible to check leakage between electrodes with the valve heater cold.

44. At the position **CH/R** again using the ELECTRODE SELECTOR Switch, the valve is automatically checked for electrode leakage between cathode and heater strapped, and all other electrodes with heater voltage applied.

45. At the position **C/H**, the valve is automatically checked for cathode to heater insulation with heater voltage applied. For this test, the ELECTRODE SELECTOR Switch is set to C/H.

46. With the CIRCUIT SELECTOR switch set to **TEST**, and in conjunction with the ELECTRODE SELECTOR, ANODE CURRENT, and other relevant controls, the valve is tested for its normal characteristics, the majority of the information being obtained from the setting of control, the meter being used as a form of null indicator.

47. At the position of **GAS**, the meter is connected in series with the control grid connection, and directly indicates gas current in μA .

The Electrode Selector.

48. This switch, used in conjunction with the CIRCUIT SELECTOR, enables the meter to be associated with the anode circuit under test, with the exception of test position C/H. This latter setting is used only in conjunction with the CIRCUIT SELECTOR set to C/H for the measurement of cathode/heater insulation. Triodes, Pentodes and multiple grid valves are checked with the ELECTRODE SELECTOR set to A_1 or A_2 , whilst diodes and rectifiers are checked at positions D_1 and D_2 .

The Heater Voltage Switches.

49. Heater voltages are selected by means of two switches, the first being a simple toggle switch marked .625 – 117, and 1.4 – 80, the second being an 18 way switch surrounded by two sets of calibration figures. The outer set of voltages on the latter can be selected when the toggle switch is in its left-hand position (.625 – 117), whilst the inner set of voltages can be selected when the toggle switch is in its right-hand position (1.4 – 80). Table 1 gives details of the 32 available heater voltages. *Note: Where give heater voltages in parenthesis should be employed.*

Table 1

OUTER RING On-load heater volts ap- pearing at valve base with toggle switch set to position .625 -- 117	INNER RING On-load heater volts ap- pearing at valve base with toggle switch set to position 1.4 -- 80
.625	
1.25	1.4
2	
2.5	3
4	4.5
5	5.7
6.3	7.5
10	
11	12.6
13	15
16	18
20	23
25	28
30	35
40	45
48	55
70	80
117	

The Anode and Screen Voltage Switches.

50. These switches enable the requisite electrode voltages applied to screen and anodes of valves for the purpose of carrying out mutual characteristics measurements. They are calibrated in the equivalent DC voltage settings and, therefore, no account need be taken of the actual value of AC voltage which appears at the electrodes of the valve, for as already explained in Chapter 1, the actual voltage will differ from the equivalent DC value marked at the switch position.

51. This is dual control comprising two knobs, the first being continuously variable and calibrated from 0 – 10mA, the second having an inner and outer set of calibration figures. Only the outer set of figures marked in steps of 10mA from 0 – 90mA apply when anode current is being measured. These controls enable the expected anode current from the valve under test to be set upon the instrument and also serve as a means of final adjustment prior to making slope measurement (mA/V) tests. These controls do, in effect, back off the anode current passed by the valve, and to prevent overloading they should be set to the expected figure before the CIRCUIT SELECTOR switch is set to the position TEST.

52. When checking diodes and rectifiers, the inner range of figures around the right hand switch become operative, enabling the operator to select the required load, which is normally 1mA per anode in the case of signal diodes and from 5 – 120mA per anode for high vacuum power rectifiers.

The Negative Grid Volts Control.

53. This is a continuously variable control calibrated 0 – 40 and marked NEG GRID VOLTS, which enables the initial negative bias at which a test is made to be set at any value between 0 and minus 40 volts.

The Set mA/V Control.

54. The mA/V control marked 1 – 20mA/V enables the rapid checking of the operative “goodness” of a valve, on a “replace/good” scale on the moving coil indicator, or alternatively, the direct measurement of mutual conductance in mA/V.

CHAPTER 3

OPERATING INSTRUCTIONS & GENERAL PROCEDURE FOR TESTING A VALVE

The connection of the instrument to a supply voltage

55. Remove the mains supply lead from its storage position in the lid of the instrument, and connect the cable termination to the socket provided on the control panel. Ascertain the voltage of the mains supply (which must, of course, be AC 50 – 500c/s) and set the MAINS VOLTAGE SELECTOR panel as described in Chapter 2. Connect the mains lead of the instrument to the power supply, ensuring that the red wire is connected to “line”, the black or blue wire to “neutral” and the green wire to “earth”. Set the MAINS switch on the panel to its “ON” position, and observe that the panel indicator lamp is illuminated. The valve to be tested should NOT be inserted at this stage.

Final settings of Mains Voltage Selector Panel

56. Having allowed a few moments for the instrument to warm up, set the CIRCUIT SELECTOR switch to the position SET ~. Set the fine voltage adjustment control so that the meter needle lies in the black zone. If this cannot be done, the coarse control will require adjustment, and should be moved to the next higher tapping if the needle is too far to the right of the mains adjustment zone, and in a similar manner, it should be moved to the next lower tapping if the meter needle is to the left of the mains setting zone. Once the mains voltage tapping has been correctly set, provided that extensive mains fluctuations do not occur, test voltages are automatically correct throughout the instrument.

Insulation checks with the valve cold

57. (1) The Valve Data Manual supplied with the instrument, or the Valve Manufacturer’s Data, should now be consulted, and the ROLLER SELECTOR Switch set up as explained in Chapter 2, Section 35.

(2) Set the HEATER VOLTAGE Switches to the correct value for the valve under test, and insert the valve into its appropriate holder, making any necessary connections to top or side caps.

Note: Where given heater voltages in parenthesis should be employed.

(3) Set the CIRCUIT SELECTOR Switch at A/R and S/R in turn, using each of these settings in conjunction with successive settings of the ELECTRODE SELECTOR Switch at A₁, A₂, D₁ and D₂. The meter will now indicate any insulation breakdowns between electrodes.

58. (4) Table 2 sets out the manner in which insulation checks are made.

Table 2

Circuit Selector Switch Position	Electrode Selector Switch Position	Insulation Check
A/R	A ₁	Checks insulation anode 1 to screen, filament, cathode, anode 2 and grid.
A/R	A ₂	Checks insulation anode 2 to screen, filament, cathode, anode 1 and grid.
A/R	D ₁	Checks insulation D ₁ to screen, filament, cathode, anode 1 and grid.
A/R	D ₂	Checks insulation D ₂ to screen, filament, cathode, anode 2 and grid.
A/R	A ₁	Checks insulation screen, to filament, cathode and grid.

59. Study of the table set out above will show that all normally expected insulation breakdowns are covered with the exception of cathode to grid, which case is covered in a later check. Thus, a reading on the meter of 1MO when the SELECTOR Switch is set to A/R, and the ELECTRODE SELECTOR switch is set to A₁ can only indicate a breakdown from anode 1 to grid, provided that breakdowns are not indicated in any other insulation test with heater either hot or cold. It is, therefore, apparent that it is possible to deduce between which electrodes a breakdown is occurring, although this information is normally never required, for in general, any appreciable inter-electrode breakdown will render the valve useless.

Insulation checks with the valve hot

60. All the tests referred to in section 58 were carried out with the valve heater cold. The CIRCUIT SELECTOR Switch should now be set to CH/R, and a short time allowed to elapse to enable the valve to reach operating temperature. With the ELECTRODE SELECTOR Switch set to A₁, D₁ and D₂ in turn, any deflection will denote in MO the amount of insulation breakdown which occurs with cathode and heater strapped together to any other electrode.

61. Table 3 sets out below the manner in which these insulation checks are made.

Table 3

Circuit Selector Switch Position	Electrode Selector Switch Position	Insulation Check
CH/R	A ₁	Checks insulation cathode and heater to A ₁ , A ₂ , G ₁ , S.
CH/R	D ₁	Checks insulation cathode and heater to D ₁ .
CH/R	D ₂	Checks insulation cathode heater and D ₂ .

Cathode to Heater Insulation Check

62. Turn the CIRCUIT SELECTOR Switch to C/H, and the ELECTRODE SELECTOR Switch to C/H. Any insulation breakdown which occurs between heater (hot) and the cathode will be directly indicated on the insulation resistance scale of the meter. It is not possible to state a rejection figure in MO for a valve under test, for such a fault will be of considerable importance in some circuits, whilst in a few cases its presence has virtually no consequences at all. The instrument is capable of giving the insulation between cathode and heater, and the acceptance or rejection of the valve can only be determined when the operator has details of the circuit in which the valve is to be used. In those cases where these details are not known, it is always better to reject a valve having an insulation resistance less than 10MO. It will be appreciated that there are many circuits in which an appreciable potential exists between heater and cathode, DC amplifiers, ect., and the presence of heater to cathode insulation breakdown, even of the order of many MO, can often give rise to quite serious trouble. Heater to cathode insulation breakdown either permanent or intermittent can also give rise to noise in valve amplifier circuits.

Determination of Valve condition from Static Characteristics Data

63 Normally, a valve, unless it is a diode or rectifier, is checked by a comparison of its actual mutual conductance with the rated figure. The broad procedure for obtaining this figure consists of:---

- (i) Applying to the valve the recommended electrode voltages
- (ii) Backing off to zero the standing anode current thus produced.
- (iii) Applying a small increment signal to the grid of the valve.
- (iv) Assessing the mutual conductance and consequently the “goodness” of the valve from the resultant rise in anode current.

64 Provision is made to test for mutual conductance under two conditions:---

- (i) Where the measurement is made at a predetermined fixed value of grid bias, the resulting anode current being balanced out.
- (ii) Where the measurement is made at the predetermined optimum value of anode current, the bias being adjusted to give a balance.

65 In either of the cases, the determination of “goodness” can be made by:---

- (a) A comparison of the mutual conductance of the valve on a percentage basis with its rated figure, the comparative “goodness” factor being indicated on a coloured “good/replace” scale.
- (b) A direct numerical determination of the valve’s mutual conductance in mA/V which can then be compared with the rated figure.

66 In certain circumstances, where for example the valve is used as an oscillator or output valve working at peak emission, more useful information than is given by the usual mutual conductance figure can be gained from anode current obtained for a given set of electrode voltages. Such conditions are catered for by calibrating the “backing off” controls in terms of anode current (milliamperes). Thus, when the standing anode current has been “backed off” to zero as shown by the meter indication (not calibrated in anode current), the reading of the backing off controls give the anode current for the valve under test, at a particular combination of electrode voltages. This figure can be compared with expected anode current for the conditions employed to determine the valve’s suitability for the function it has to perform.

67 It is obvious that this arrangement also enables complete valve characteristics of anode current related to electrode voltages to be plotted, it merely being necessary to record the anode current obtained at a series of electrode voltage settings (either anode, screen or grid), and plotting the mutual characteristics I/aV_g , I_a/V_a ect., from the data thus obtained.

68 The detailed instructions for making the measurements outlined above, having completed the inter-electrode insulation checks, are as follows:---

69 Set ANODE VOLTS, SCREEN VOLTS, NEG GRID VOLTS, and ANODE CURRENT controls to the value indicated in the Valve Data, then set CIRCUIT SELECTOR to TEST and ELECTRODE SELECTOR to A.

Note 1

Should the protective relay operate, switch off and check for incorrect settings of the ROLLER SELECTOR Switch or electrode voltages. If these are correct and the relay continues to “buzz” when the instrument is switched on again, the valve is probably “soft” (gassy), and the test should proceed no further. If upon removing the offending valve, the relay continues to operate, the instrument should be switched off. When switching on again, the instrument should function normally

To check relative goodness of Valve in conjunction with Coloured Comparison Scale.

70 (a) Using recommended anode current.

- (i) Do not alter ANODE CURRENT controls, but adjust NEG GRID VOLTS control until meter is balanced to zero.
- (ii) *Slowly* rotate SET mA/V control to SET ZERO position and make any final adjustments to zero, using fine ANODE CURRENT control. (see note 3)
- (iii) Continue rotating of SET mA/V control to expected value of mA/V (meter needle should rise)
- (iv) The comparative “goodness” of the valve will now be shown by the position of the meter needle on coloured scale. This scale is divided into three zones, and all valves coming within the green portion can be regarded as satisfactory. Readings in the intermediate zone between the red and green sections are not entirely satisfactory, although the valve may be capable of working in some circuits at lowered efficiency, whilst readings in the red zone indicate that the valve should be rejected or replaced.

71 (b) Using recommended negative grid voltage.

- (i) Do not alter NEG GRID VOLTS controls, but adjust ANODE CURRENT controls until meter is balanced to zero.
- (ii) *Slowly* rotate SET mA/V control to SET ZERO position and make any final adjustments to zero, using fine ANODE CURRENT control. (see note 3)
- (iii) Continue rotating of SET mA/V control to expected value of mA/V (meter needle should rise)
- (iv) The comparative “goodness” of the valve will now be shown by the position of the meter needle on coloured scale. This scale is divided into three zones, and all valves coming within the green portion can be regarded as satisfactory. Readings in the intermediate zone between the red and green sections are not entirely

satisfactory, although the valve may be capable of working in some circuits at lowered efficiency, whilst readings in the red zone indicate that the valve should be rejected or replaced.

Note 2

Valves having a slope of less than 1mA/V cannot be checked on the good/replace scale, and must be checked in the manner set out in paragraph 74.

To check Valve by direct reading of Mutual Conductance (mA/V)

72 (a) Using recommended anode current.

- (i) Do not alter ANODE CURRENT controls, but adjust NEG GRID VOLTS control until meter is balanced to zero.
- (ii) *Slowly* rotate SET mA/V control to SET ZERO position and make any final adjustments to zero, using fine ANODE CURRENT control. (see note 3)
- (iii) Continue rotating of SET mA/V control until meter needle reaches the calibration line in center of “good” zone, marked “1mA/V”.
- (iv) Read actual value of mutual conductance from SET mA/V dial. This figure can be compared with that given in data manual.

73. (b) Using recommended negative grid voltage.

- (i) Do not alter NEG GRID VOLTS controls, but adjust ANODE CURRENT controls until meter is balanced to zero.
- (ii) *Slowly* rotate SET mA/V control to SET ZERO position and make any final adjustments to zero, using fine ANODE CURRENT control. (see note 3)
- (iii) Continue rotating of SET mA/V control until meter needle reaches the calibration line in center of “good” zone, marked “1mA/V”.
- (iv) Read actual value of mutual conductance from SET mA/V dial. This figure can be compared with that given in data manual.

To check Valves having a Mutual Conductance less than 1mA/V.

74. Since the SET mA/V dial is not calibrated below 1mA/V, it is not possible to check on the coloured comparison scale, valves having an expected mutual conductance less than 1mA/V. Such valves are checked by direct measurements of mutual conductance using the procedure set out in paragraph 72 and 73, with the exception that the 1mA/V dial is rotated to the 1mA/V position and the actual value for mutual conductance (being less than 1Ma/V) is read on the meter scale calibrated 0,1-1mA/V.

75. For valves with more than one electrode assembly, having set up for any difference in electrode voltages, repeat above test with ELECTRODE SELECTOR at A2. (See also comments under Testing of Specific Valve Types)

Note 3

Certain valves require an exceptionally long period to reach working temperature, the symptoms being a continual rise of anode current when SET mA/V dial is at the SET ZERO (more sensitive) position. Slope measurements should not be taken until a condition of stability has been reached.

Note 4

When checking certain valves of the CV.138 type, back emission sometimes occurs between anode and the suppressor grid which normally connected to cathode. This condition which is caused by local overheating of the anode, would not affect the operation of the valve under normal circuit conditions, although it could give rise to doubt as to the “goodness” of the valve when checked on a valve testing instrument. This phenomenon shows itself as an apparent gradual fall in anode current as the valve heats up, and the only manner in which this effect can be overcome, is to lower the power dissipation of the valve by reducing the anode voltage. Note “E” in the “AVO” Data manual relates to the above conditions, and a note appears against those valve types concerned, together with an alternative set of test data.

Note 5

In literature issued by American Valve manufacturers, the term “transconductance” is used in place of mutual “conductance”. Transconductance given in micromhos, divided by 1,000 gives mA/V

$$mA/V = \text{Transconductance (micromhos)} / 1,000$$

Measurement of grid current.

76. The measurement of grid current at a desired set of electrode voltages may be made after having measured the mutual conductance of a valve. This measurement should not be made where an apparent fault in the valve has previously caused the protective relay to operate (possible due to softness).

77. The CIRCUIT SELECTOR switch should be set to GAS, thus inserting the meter into the grid circuit of the valve, where it records grid current directly in μA . The meter is limited to read a maximum of $100\mu A$, but it is not possible to state the value at which a valve becomes useless due to the presence of gas. The point at which gas current reaches a value great enough to affect the successful employment of the valve depends very much upon the circuitry in conjunction with which it is to be employed, e.g. it is possible for appreciable grid current to flow in the secondary of an R.F. transformer connected between grid and earth, but if resistance/capacity coupling is used in the circuit, the same magnitude of grid current may produce appreciable voltage across the bias resistor, thus completely upsetting the normal functions of the circuit.

Checking Power Rectifiers.

78. The testing of rectifying valves should ideally be associated with the requirements of the circuit in which they are to operate. In most cases throughout the “AVO” Valve Data Manual, the figure quoted denotes the standard emission per anode to be expected from the type of valve under test.

79. The procedure for testing a rectifying valve is exactly the same as that for a valve with one or more grids, to the end of the insulation checks.

80. From this point onwards, before setting the CIRCUIT SELECTOR to the position TEST, the right hand ANODE CURRENT control switch reading on the inner set of figures, should be set to the load current given for the valve in the Valve Data Manual.

Set CIRCUIT SELECTOR to TEST and the ELECTRODE SELECTOR either to D1 in the case of a half wave rectifier, or D1 and D2 for a full wave rectifier.

81. Having correctly set up the controls as explained above, the “goodness factor” of the valve under test will be shown on the coloured “replace/good” scale of the meter.

82. The inner ring of figures on the ANODE CURRENT Control relate to load currents and are marked “diodes and Rectifiers”, the figures marked being the emission in mA expected per anode of the valve under test.

83. The setting of this control can either be determined from the tabulated data given, or can alternatively be related to the total current that a valve is required to deliver. Thus, on a piece of equipment where the total H.T. drain on the rectifier is 50mA, then a Rectifier load of 60mA will be an adequate test of the valve’s emission state, assuming that it is a half wave rectifier. Alternatively, if the valve is a newer one, the maker’s rating for maximum load current can be used as the basis for the setting of the ANODE CURRENT switch.

84. In the case of full wave rectifiers, each anode of the valve is rated independently and the setting of the ANODE CURRENT control should indicate half the total value of the current which the valve would be expected to deliver in full wave rectifier circuit. E.g. a valve rated at a maximum of 120mA would be tested which each anode at the 60mA position on the ANODE CURRENT control. The load rating given in the Valve Data manual is the load per anode.

Checking Signal Diodes

85. Signal Diodes are checked in exactly the same manner as rectifiers, except that the right-hand ANODE CURRENT control is always set to 1 or 5 according to the anode current given in the data. (Where “AVO” Valve Data does not give a current figure for a diode, it is always checked with the right-hand ANODE CURRENT control set to its 1mA position)

INSTRUCTIONS FOR TESTING SPECIFIC VALVE TYPES

86. The functions of a valve, as distinct from the type number given to it by its manufacturer, is indicated by a symbol in the form of letters appearing at the right of the test data given in the “AVO” publications, e.g. a half wave rectifier is marked “R”, whilst a full wave rectifier is designated “RR”. In a similar manner, diode valves are shown by the letter “D”, the number of diode elements being indicated by the number of “Ds”, e.g. “DDD” refers to a triple diode.

Multiple Diodes and Rectifiers (D, DD, DDD, R, RR)

87. The testing of multiple diodes and rectifiers is carried out in a manner already explained, the ELECTRODE SELECTOR being used to select the diode or rectifier element, the emission of which is indicated on the meter “replace/good” scale. When dealing with diodes or rectifiers, the D1 and D2 positions of the ELECTRODE SELECTOR represent diode or rectifier anodes 1 and 2 respectively, and correspond to figures 8 and 9 on the ROLLER SELECTOR SWITCH set-up number.

88. In the case of Triple Diodes, since only two anode systems are normally catered for, a special procedure is adapted in the set-up figure. At the position in the SELECTOR SWITCH number representing the third diode, the symbol † is included. The first and second diodes being indicated by 8 and 9 respectively in the normal manner. The valve should be tested normally, with the ROLLER SELECTOR SWITCH set to “0” where the † appears in the set-up number. This procedure will give emission figures for diodes 1 and 2. Now rotate the ROLLER SELECTOR SWITCH rollers so that the two rollers originally set at 8 and 9 are now set to 0, and set the pin marked † in the valve data to 8 on the ROLLER SELECTOR SWITCH. A further test with the ELECTRODE SELECTOR switch at D1 will then give the emission of the third diode, e.g. EAB1 is indicated in the data as 023 1†0 890, enabling these diodes to be tested in the normal manner. To obtain the emission figure for the third diode the SELECTOR switch should be altered to read 023 180 000, and the ELECTRODE SELECTOR set to D1.

Diodes and Rectifiers combined with other Electrode assemblies (DT, DDT, DP, DDP, DTP).

89. Combined diode and amplifying valves are represented in the type column of the data by “DT” and “DDT” for diode triodes and double diode triodes, whilst “DP” and “DDP” indicate diode pentodes and double diode pentodes.

90. The testing of the separate sections of each valve is carried out in rotation, the amplifying sections being tested first, with the CIRCUIT SELECTOR at TEST, and the ELECTRODE SELECTOR at position A1.

91. The rotation of the ELECTRODE SELECTOR to the D1 or D2 position will automatically set the instrument in readiness for testing one or both diodes with the right hand ANODE CURRENT control set to 1 on the inner scale.

Double Triodes and Double Pentodes (TT, PP)

92. Double triodes or double pentodes are indicated by the letters “TT” or “PP”, each section being tested in the normal manner, the selection of each assembly being made by the rotation of the ELECTRODE SELECTOR switch to A1 and A2 (corresponding to the ROLLER SELECTOR SWITCH number 6 and 7). When double valves are used in Class B or “balanced” circuits, a close match of the characteristics of both valves is essential.

Frequency changers (H, TH, O, TP)

93. Frequency Changers of the heptode and hexode classes employing the normal oscillator section as a phantom cathode for the mixer section, are not very satisfactorily tested in two sections, since the nature of the valve construction is such that each section is dependent upon the other for its correct operation. For test purposes, therefore, this valve is shown connected as a pentode or triode, for which, where possible, anode current and/or mutual conductance figures are given. Such valves are indicated by the letter “H” in the type column.

94. An exception to this type of valve is the Octode, designated by “O” in the type column, which, as will be seen from the data, is normally tested as if it had two separate electrode assemblies, separate data being given for each. In this case, the oscillator section is tested with the ELECTRODE SELECTOR switch at A1, and the mixer section at A2.

95. As a further test to ensure the probability as such a valve oscillating satisfactory, an indication of failing emission will probably give the most useful results. When a valve is perfect, its cathode will develop its full emission at the rated heater voltage, and any change in the cathode temperature will result, at the most, in a corresponding percentage change in emission. If, however, the emission of the cathode is failing, then an increase or decrease in the cathode temperature will result in a higher percentage change in emission.

96. When a valve is oscillating, it tends to run into the positive grid region, thus making full use of the emissive capabilities of the cathode, and failing emission may well prevent oscillation taking place. As a subsequent test, therefore, it is helpful to note the anode current at the rated test figures with the normal heater voltage applied, and then to decrease the heater voltage by about 15% for a short period. (It may be necessary to operate the HEATER VOLTAGE TOGGLE SWITCH to give the necessary decrease in voltage). In the case of a valve with failing emission, the decrease in cathode temperature will result in an excessive decrease in the anode current, considerably greater than the percentage decrease in heater voltage. Such a result would suggest that the valve will not oscillate satisfactorily. Conversely, a negligible or small decrease in anode current (or of the same order as the percentage change in heater volts) will show that the valve is developing its full emission at the rated heater voltage, and, provided that the circuit conditions are correct, it should oscillate normally.

97. Frequency changers employing separate electrode assemblies for oscillator and mixer functions are designated by "TH" (triode hexode) and "TP" (triode pentodes). The separate sections of this type of valve are not interdependent as in the case of the phantom cathode types mentioned in the previous paragraph, and they must, therefore, be tested in two separate sections as a pentode or triode respectively.

THE USE OF THE LINKS ON THE VALVE PANEL OF THE INSTRUMENT.

98. These links, in the A1 and A2 circuits respectively, enable a load to be inserted into the anode circuit of the valve under test. By removing the shorting links, and inserting the appropriate resistor (or other load) across the terminals which it is desired to include in the circuit, it is possible to obtain dynamic figures for the valve or electrode system under test.

99. The links also enable a suitable DC moving coil ammeter with low millivolt drop to be inserted in series with the anode of the valve under test. Variations in the settings of the ANODE CURRENT controls will not materially affect the readings of the external meter reading, which will read 0.5 of the actual current flowing, i.e. the external meter reading must be multiplied by 2 for true anode current.

Note 6

Beware of high voltages on shorted links

Checking Tuning Indicators (TI)

100. Tuning indicators (magic eyes) are tested with the normal controls set to the figures in the data table, the SCREEN SWITCH being used to obtain target volts, the appropriate anode load being inserted in accordance with the value shown in the remarks column.

At the approximate bias given in the table the triode section should be at “cut off” and the eye fully closed. Reducing the grid bias to zero, the eye should be open fully and the value of anode current should be approximately that appearing in the table (where given). In the case of double sensitivity indicators giving multiple images responding to different sensitivities, two sets of data (where possible) are given, the first set referring to the more sensitive indication.

Checking gas filled rectifiers (GR)

101. Gaseous rectifiers are tested in conjunction with a load resistor or suitable wattage connected across the link terminals, the value of resistance being given in KO in the remarks column. This type of rectifier is not tested on the rectifier or diode test circuits, but with the CIRCUIT SELECTOR set to test, the appropriate voltage and representative anode current figures being given in the valve data column. Full wave examples of this class of valve are, of course, tested at the ELECTRODE SELECTOR positions A1 and A2, a suitable resistor being connected across each of the two anode links. The maximum loading on these rectifiers must be limited to 100mA per anode to avoid damage to the instrument.

Checking cold cathode rectifiers (CCR)

102. Cold cathode rectifiers designated by the symbol “CCR” can be tested in a similar manner, the anode voltage, approximate anode current, and load being given in the data columns.

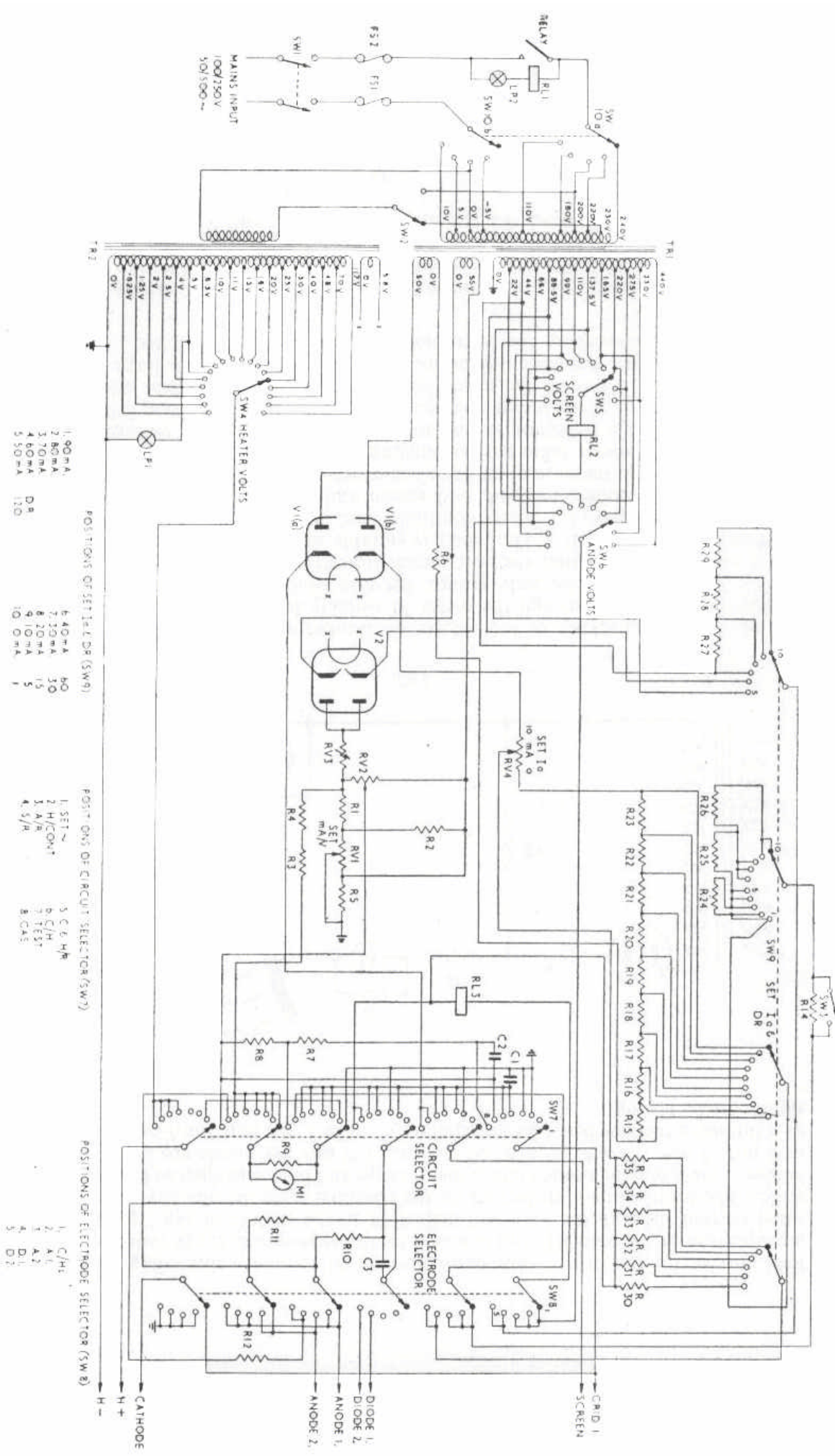

POSITIONS OF SETTING DR (SW9)

1. 0.0 MA	6. 4.0 MA	B0
2. 2.0 MA	7. 1.0 MA	30
3. 3.0 MA	8. 2.0 MA	15
4. 4.0 MA	9. 3.0 MA	5
5. 5.0 MA	10. 0.0 MA	1

POSITIONS OF CIRCUIT SELECTOR (SW7)

1. SET ~	5. C. G. H/H
2. H/C/OMT	6. C/H
3. A/A	7. TEST
4. S/H	8. GAS

POSITIONS OF ELECTRODE SELECTOR (SW8)

1. C/H
2. A1
3. A2
4. D1
5. D2

M1 - 300A, 3250 (1)

Circuit Ref. No.	Value	Tol %	Type	Circuit Ref. No.	Value	Tol %	Type	Circuit Ref. No.	Value	Tol %	Type
R1	2.34K Ω	1	b	R18	80 Ω	2	e	R35	4.35K Ω		
R2	70 Ω	1	a	R19	80 Ω	2	e	RV1	2.5K Ω	2	e
R3	2 resistors Matched	1	a	R20	80 Ω	2	e	RV2	10K Ω		
R4	1.32M Ω	1	a	R21	80 Ω	2	e	RV3	500 Ω		
R5	500 Ω	1	a	R22	80 Ω	2	e	RV4	90 Ω		
R6	730 Ω	2	e	R23	80 Ω	2	e				
R7	0.33M Ω	2	e	R24	240 Ω	2	e	C1	μ Fd		Wk.g. volts
R8	10K Ω	2	e	R25	240 Ω	2	e	C2	.02		400
R9	10K Ω	2	e	R26	240 Ω	2	e	C3	.02		200
R10	200 Ω	1	a	R27	600 Ω	2	e		8		450
R11	8K Ω	5	f	R28	3K Ω	2	e	V1	D77		
R12	500 Ω	2 $\frac{1}{2}$	d	R29	15K Ω	2	e	V2	D77		
R14	22K Ω	2	e	R30	814K Ω	2	e	F1	2 amp		
R15	80 Ω	2	e	R31	406K Ω	2	e	F2	2 amp		
R16	80 Ω	2	e	R32	202K Ω	2	e	LP1	6.5V, 0.3A		
R17	80 Ω	2	e	R33	100K Ω	2	e	LP2	15W, 200V		
				R34	31.5K Ω	2	e		Red.		

FIG. 3.

a	High Stability Carbon Resistor, $\pm 1\%$, Welwyn Type A3611.
b	As above but Welwyn Type A3623 (3/4 W.)
c	Vitreous Wire Wound Resistor, $\pm 5\%$, Welwyn Type AW3111 (1/4 W.)
d	As above but $\pm 2\frac{1}{2}\%$.
e	High Stability Carbon Resistor, $\pm 2\%$, Welwyn Type A3611. (1/4 W.)
f	Vitreous Wire Wound Resistor, $\pm 2\frac{1}{2}\%$, Welwyn Type AW3111 (1/4 W.) Overwound by AVO.

