

**AVOMETER  
MODEL 7**

**MARK II**

**WORKING  
INSTRUCTIONS**



**AVO LTD**

**AVOCET HOUSE, 92-96 VAUXHALL BRIDGE ROAD, LONDON, S.W.1  
ENGLAND**

*Telephone: VICToria 3404 (12 lines) •*

*Telegrams: AVOCET, LONDON SW1*



**THE  
AVOMETER MODEL 7  
Mk. II**

*INSTRUCTION MANUAL FOR THE  
INSTRUMENT AND ITS ACCESSORIES*



**AVO LTD**

**AVOCET HOUSE, 92-96 VAUXHALL BRIDGE ROAD,  
LONDON, S.W.1**

*Telephone: Victoria 3404 (12 lines)*

*Telegrams: Avocet, London, S.W.1*



## CONTENTS

	<i>Page No.</i>
Introduction . . . . .	4
Table of Ranges . . . . .	5
Scope of Instrument . . . . .	6
Limits of Accuracy . . . . .	6
Design and Construction of the AvoMeter . . . . .	7
Controls . . . . .	7
Overload Protection . . . . .	8
The Movement . . . . .	9
Scaling . . . . .	9
The $\div 2$ Button . . . . .	10
Replacement of Internal Batteries and Cell . . . . .	11
Operation of Instrument . . . . .	12
Current Measurement . . . . .	12
Voltage Measurement . . . . .	13
Resistance Measurement . . . . .	14
The 10,000 and 100,000 ohms Ranges . . . . .	15
The 1 megohm Range . . . . .	16
Battery Condition . . . . .	16
The 10 and 40 megohm Ranges . . . . .	16
Capacitance Measurement . . . . .	17
Audio Frequency Power Measurement . . . . .	18
Decibel Measurement . . . . .	19
Accessories . . . . .	20
Multipliers . . . . .	20
Shunts . . . . .	20
Transformers . . . . .	21
The Model 7 Power Factor and Wattage Unit . . . . .	22
Resistance Range Extension Unit . . . . .	28
Circuit Diagram of the Model 7 Mk. II AvoMeter . . . . .	31

**Copyright.**

Information or diagrams in whole or in part must not be copied or reproduced without the prior permission in writing of AVO LTD.



Avometer, Model 7 Mk. II



## OPERATING INSTRUCTIONS

### Scope of Instrument

The meter should arrive complete with two connecting leads, two clips and a pair of Long Reach Safety Clips Mk. 2. The leads are designed to facilitate easy connection to the plug-in terminals of the instrument, whilst into the sockets at the remote ends of the leads either the Long Reach Safety Clips Mk. 2 or the clips can be fitted. The meter is extremely simple to use; it has a 5" hand calibrated scale, together with an anti-parallax mirror to facilitate accurate readings. The instrument incorporates both an "a.c." and a "d.c." switch, whilst the design is such that only two terminals are required. The whole is compact, self-contained over wide ranges, readily portable, robust, and automatically protected against reasonable overload. It should be noted that in certain instances, instruments are supplied less internal batteries.

The instrument has 50 self-contained ranges, as listed on page 5, covering the measurement of "a.c." current and voltage, "d.c." current and voltage, resistance, capacitance, decibels and audio frequency power.

Although the AvoMeter is, in the main, self-contained, it should be noted that the ranges of the meter can be even further extended by means of various accessories. Full details of these will be found towards the end of this book.

The highest percentage of accuracy on moving coil instruments is normally presented towards the higher end of the calibrated scale. By the provision of intermediate ranges between those marked on the switch knobs, it has been possible to offset the disadvantages of reading short pointer deflections. These ranges are shown by asterisks in the table on page 5.

### Limits of Accuracy

The instrument will produce its highest degree of accuracy when used face upwards, whilst the anti-parallax mirror fitted to the scale, enables readings to be made with great precision.

The instrument meets the requirements laid down in Section 6 of the British Standard Specification 89/1954 for 5" (127 mm.) scale-length Industrial Portable Instruments. Limits are given below:—

d.c. voltage and current ranges: 1% of full-scale value over effective range.

a.c. voltage and current ranges (25–2,000 c/s): 2.25% of full-scale value over effective range.

The definition of "effective range" set down in the specification when related to the AvoMeter is as follows:

d.c.—from 0.1 of full-scale to full-scale value.

a.c.—from 0.25 to full-scale of full-scale value.

Although a.c. limits of accuracy are only claimed up to 2,000 c/s, sufficient accuracy for most practical purposes can, however, be obtained over the audio frequency band.

In practice AvoMeters are very well within these limits due to the great care taken in the manufacture of the various components used within them, and the fine initial calibration.

Inasmuch as rectifier moving coil instruments give readings on "a.c." proportional to the mean, and not to the r.m.s. value of the wave-form with which they are presented, they depend for their accuracy not only upon their initial calibration, but also upon the maintenance of a sinusoidal wave-form. Since the form factor (r.m.s. value divided by mean value) of a sine wave is 1.11, this has been taken into account in calibrating the meter, which does therefore indicate r.m.s. values on the assumption that the normal sine wave will be encountered. Generally speaking, considerable wave-form distortion can occur without appreciably affecting the form factor and resulting accuracy of measurement, but the user should recognise the possibility of some error when using distorted wave-forms, squarish wave shapes producing high readings and peaky ones, low readings.

### Design and Construction of the AvoMeter

The instrument consists of a moulded panel, on the inside of which are mounted the whole of the switching apparatus, resistances, shunts, transformer, rectifier, etc., together with the movement. The panel fits into an attractively finished, robust case, the joint having been rendered completely dust proof, whilst a leather carrying strap is provided to facilitate portability. The entire switching of the multipliers, shunts, transformer, etc., is accomplished automatically by means of two switch knobs on the panel, each plainly marked, so that the range in use appears opposite an arrowhead.

These switches are of generous and robust design, contacts being arranged to "make" before "break" on adjacent ranges; a feature which provides a further factor of safety to the user. When the instrument is set for operation on "d.c.", the moving coil employs universal shunts and series multipliers, whilst on "a.c." the moving coil is associated with a rectifier and tapped transformer system in addition to the series multipliers.

### Controls

The left-hand knob governs "d.c." ranges and the right-hand knob the "a.c." ranges, the switching being interlocked in such a manner,

that it is only possible to obtain "d.c." readings by setting the "d.c." switch to a range and rotating the "a.c." switch to the position marked "D.C." A similar procedure is necessary when making an "a.c." measurement, and the instrument is therefore protected from damage in the event of both switches being left on ranges when making a test, for in this condition there is no circuit through the meter. Should "a.c." be passed through the instrument when it is set to a correct "d.c." range, or vice versa, no pointer indication will be produced, and no damage will result provided that the meter is not overloaded on the range selected.

It is possible to determine whether a source is "a.c." or "d.c." since pointer deflection can only be produced with switches set for the same type of measurement as the supply.

The knobs marked "P", "Q" and "R" are of use in conjunction with the resistance ranges, etc., and full details of their functions will be given in a later section of the book.

*If at any time it becomes necessary to re-set the pointer to zero, the slotted zero adjusting screw should be used, and this must be done whilst the instrument is set to a "d.c." range, the meter not being connected to any external circuit.* The reason for this procedure is that in order to compensate for small inevitable errors on a.c., the pointer is slightly displaced from zero. To produce this deflection, a minute current is drawn from the  $1\frac{1}{2}$  V. cell used for resistance measurements, whilst the normal setting for cell deterioration on resistance tests is such as to maintain the correction on a.c.

### Overload Protection

Apart from the facility with which measurements can be made, one of the most attractive features of the instrument is the provision of an automatic cut-out which completely eliminates the inconvenience and expense of replacing fuses. The incorporation of this device will be found to be of particular value when conducting experimental work, for it imparts to the user the feeling of mental ease and confidence. When performing such work with conventional moving coil meters, these can be easily ruined by inadvertently applied overloads, whereas the AvoMeter is so well protected that it can withstand considerable mishandling.

If an overload is applied to the meter, the cut-out knob springs from its normal position in the panel, thus breaking the main circuit, and this knob has only to be depressed to render the instrument again ready for use. It is important to note that the cut-out should never be re-set when the instrument is connected to an external circuit, whilst the fault which caused the overload should be rectified before the meter is reconnected. The mechanism functions on moderate overloads if the moving coil hits the forward or reverse end stops.

Should the acceleration of the moving coil, due to overload, be excessive, a different portion of the mechanism comes into play and the breaker contacts may even be released before the pointer has traversed one-third of the scale length.

The user is, however, warned against gross negligence, for although the overload mechanism gives almost complete protection to the meter, it cannot be guaranteed to fulfil completely its function in the very worst cases of overload, such as the mains being connected across the meter when set to a current range.

It should be noted that mechanical shock to the instrument will sometimes trip the cut-out mechanism. The cut-out should normally be reset with the instrument lying face upwards.

*Whilst the overload mechanism operates on a.c. overloads, the user should be particularly careful to avoid them, for in such instances the rectifier may become punctured.*

### The Movement

The moving coil consists of an aluminium former wound with copper wire (supplemented with Constantan in order to reduce temperature error). It is pivoted on hardened and highly polished steel pivots between conical spring-loaded jewels, and swings in a gap energised by two powerfully magnetised and aged alnico blocks associated with mild steel pole pieces. Two phosphor bronze hair springs are fitted for the purpose of conveying current to the moving coil, and to provide controlling torque. A knife edge type of pointer is fitted enabling very fine readings to be taken, whilst the whole movement is perfectly balanced and reasonably damped so that the pointer quickly comes to rest.

### Scaling

The scale plate has three sets of markings, each approximately 5" in length, the outer one being for resistance measurements and marked 0-10,000. The middle scale is for current and voltage measurements, both a.c. and d.c., and is marked 0-100 with divisions approximately 1.25 mm. apart. The third scale is calibrated 0-400 in major steps of 50, these being subdivided into ten divisions. This scale is only used in conjunction with the 400 V. ranges marked on the switch knobs. Each scale is individually calibrated and handmarked to agree with the readings of standard instruments, and the plate has an untarnishable mirror to prevent parallax errors.

Three subsidiary scales are provided for Capacitance, Power and Decibels. The scale markings are 0.01 to 20  $\mu$ F., 1 mW. to 2 watts, and -15 to +16 db. (about a reference level of 50 mW.).

### The $\div 2$ Button

The switch knobs are engraved with sectors enclosing ranges of voltage, current and resistance. In general, the successive ranges shown on the knobs have a 10:1 ratio but to provide intermediate ranges, a divide-by-two button is incorporated on the panel of the instrument, this being operative upon all current and voltage ranges.

To deal with mains voltage measurements, the 400 V. "a.c." and "d.c." ranges have been introduced, so that they and their associated 200 V. ranges (press button) may be employed for more accurate measurement of mains voltage.

The divide-by-two button is used when measuring current and voltage only, and serves to halve the value of any range shown on the switch knob. It should never be pressed if over half-scale deflection is being shown, since twice the length of pointer deflection as normally occurs, is produced on pressing the button. This divide-by-two button is therefore effective in producing the ranges marked with an asterisk on the table of ranges. For example, if the switch knobs are set to give the 0.01 amp. d.c. range, pressing the button will transform it to one of 0.005 amp. d.c. The greater simplicity in manufacture and wider coverage of ranges results from the use of the divide-by-two button in place of intermediate ranges on the switch knobs, but the circuit becomes more complex although the same tappings on the shunt, multiplier, or transformer provide two ranges in place of the normal one. Since this device also enables external current and voltage accessories to produce a double range effect, an explanation of its operation might be of assistance to the user.

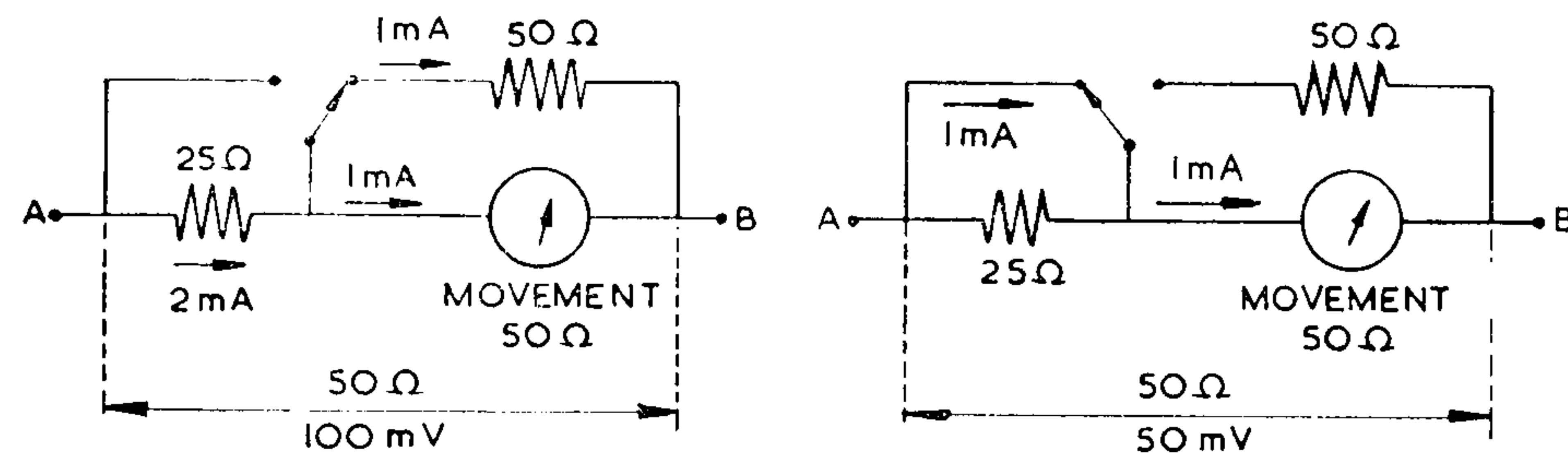

FIG. 1

FIG. 2

The relevant portion of the circuit is shown in Figs. 1 and 2, this being connected on "d.c." in series with multiplier resistances for voltage measurements, or across a universal shunt for current measurement. It will be noticed that the effective resistance between points A and B is 50 ohms in both conditions, but the current consumption is twice as much in the normal (Fig. 1) as in the divide-by-two condition (Fig. 2).

Since the resistance of a voltmeter is constant for any one switch setting, its range value must be proportional to the current flowing at full scale deflection. With the divide-by-two button pressed the application of half the original voltage will bring the pointer to full scale deflection.

The voltage across A B to give full scale deflection is 100 mV. and 50 mV. in the two cases, so that when shunted for current measurement and when on the divide-by-two range, only half the normal current is required in the shunt to produce the necessary voltage for full scale deflection.

In the case of "a.c.", the maintenance of constant resistance is unimportant, but the halving of the current for full scale is reflected from the secondary of the transformer to the primary side and thus affects both voltage and current measurements.

### Replacement of Internal Batteries and Cell

Two 4.5 V. batteries and a 1.5 V. cell will be found beneath the battery cover. These batteries should be examined from time to time to ensure that their electrolyte is not leaking and damaging the instrument. This condition will generally only occur when the cells are nearly exhausted. If it is known that the meter is going to stand unused for several months, it is preferable that these batteries should be removed to prevent possible damage.

When replacing batteries, the connections for the 1½ V. cell are obvious, but the 4½ V. batteries must be inserted with their negative poles (the long brass strips) uppermost. Markings of cell polarities will be found inside the battery box.

## OPERATION OF INSTRUMENT

If necessary the pointer should be set to zero by means of the screw head on the face of the panel. Remember that the instrument must be set to a "d.c." range for this adjustment, the meter being unconnected to any external circuit.

The leads fitted with Long Reach Safety Clips or clips as required should now be connected to the meter terminals.

When measuring d.c. voltage, current, or resistance, the "a.c." switch should be set to the position marked "D.C." Conversely for a.c. voltage, or current, the "d.c." switch should be set to its "A.C." position. The operative range switch should then be set to a suitable value before connecting the meter to the circuit under test. When in reasonable doubt, always switch to the highest range and work downwards, there being no necessity to disconnect the leads as the switch position is changed. *Do not, however, switch off by rotating either of the knobs to a blank position.*

The knob marked "Q" gives variable sensitivity to the meter on any range in use and serves for special applications, details of which are given later. When not in use, this knob must be seated in its normal position in the panel, otherwise false readings may be shown.

Although the instrument is flash tested to 3,000 V. a.c., it should be kept at the low potential end of the circuit (relative to earth) if it is used with accessories on a voltage system over 1,000 V. If this procedure cannot be adopted, other suitable safeguards must be applied.

## CURRENT MEASUREMENT

To measure current, the instrument should be set to a suitable "a.c." or "d.c." range and then connected in series with the apparatus to be tested. Generally speaking, the power absorbed in the instrument is negligible, but in the case of low voltage heavy current circuits the inclusion of a meter may reduce the current appreciably below the value which would otherwise prevail.

The approximate resistance at the meter terminals on the various ranges is given in the table below, the values being unaffected when the divide-by-two button is pressed.

Normal Range amps	ohms	
	D.C.	A.C.
0.002	50	—
0.01	10	60
0.1	1.25	1.7
1.0	0.14	0.05
10.0	0.03	0.02

Standard meter leads have a resistance of 0.02 ohm per pair and this value of resistance should be added to that of the meter.

In certain cases, care should be taken to ensure that a circuit is dead before breaking into it to make current measurements.

## VOLTAGE MEASUREMENT

When measuring voltage, it is necessary to set to the appropriate range of "a.c." or "d.c." and connect the leads across the source of voltage to be measured. If the expected magnitude of the voltage is within the range of the meter, but its actual value is unknown, set the instrument to its highest range, connect up and rotate the appropriate selector switch, decreasing the ranges step by step, until the most suitable one has been selected. Great care must be exercised when making connection to a live circuit, and the procedure should be entirely avoided if possible.

On every normal "a.c." and "d.c." voltage range, except that for 10 volts "a.c.", the instrument consumes 2 mA. for full scale deflection (500 ohms per volt) and proportionately less current for smaller deflections. When using the press button, full scale deflection is produced by half the current (corresponding to 1,000 ohms per volt) required for the normal range, and since the meter resistance is unaffected, the voltage range is halved. In the case of the 10V. "a.c." range the consumption at full scale deflection is 20 mA.

Whilst discussing the problem of measuring voltage, it would be well to draw attention to the fact that in certain circuits where the current is limited because of the presence of a resistance between the source and the point at which measurements are to be made, it is possible for the actual voltage to be higher than when the meter is connected. All current consuming voltmeters however sensitive, draw some current to varying degrees from the circuit under test, thus causing a higher voltage drop in the resistances mentioned and thereby causing the potential to fall at the point of measurement. A practical example of the manner in which errors of this nature can be introduced is given by a typical radio circuit in which a valve anode is fed through a series load resistance from a d.c. source. Under no signal conditions, the valve will have a potential on its anode dependent on the e.m.f. of the source, the actual voltage being a function of the internal impedance of the source, the load resistance and the impedance of the valve. (We have ignored any biasing or other component in the circuit.) If now a current consuming voltmeter is introduced across the valve in order to measure the potential which exists between the cathode and anode of the valve, a double effect takes place. The addition of the voltmeter reduces the total resistance of the circuit and therefore slightly increases the current. This increased current passing through the resistance of the source and anode load increases the voltage drop



across them, and the sum of these voltages must be deducted from the e.m.f. to give the voltage across the valve. In practice a balance is automatically struck whereby this residual voltage equals the product of the slightly increased current and the reduced resistance (caused by the paralleling of the voltmeter across the valve). Thus, to avoid disturbing the circuit conditions more than absolutely necessary it is advisable to use a multi-range voltmeter on a range sufficiently high to give the maximum practicable resistance, together with reasonable pointer indication. This same principle of using a higher range than apparently necessary should be adopted when measuring values of grid bias produced by the passage of current through a cathode load.

In general, however, if the highest range of the Model 7 AvoMeter is used for this purpose (together with the use of the  $\div 2$  button if desired), readings accurate enough for practical purposes can be obtained. When so set, the total resistance of the meter forms a very high resistance path shunted across the valve, thus altering the normal voltage distribution only very slightly, since the valve itself is only a fraction of the total resistance in the circuit.

The distribution of the Model 7 AvoMeter is to-day so wide that many radio manufacturers give in their service sheets the readings which one should obtain at various points of a radio receiver with the instrument set to a given range. The shunting effect of the meter does not therefore now matter, for the manufacturer has taken the actual readings on a Model 7 AvoMeter upon a chassis which is known to be working perfectly.

When it is essential to obtain an accurate indication of the voltage developed across a high resistance, it is sometimes preferable to insert the meter in series with it and to measure, in amperes, the current flowing. The reading given upon the meter, multiplied by the value of the resistance, in ohms, will give the developed voltage.

## RESISTANCE MEASUREMENT

There are three self-contained ranges covering from 0.5 ohm to 1 megohm, whilst two higher ranges are available employing an external voltage source. Generally speaking, the highest accuracy on an ohms range is obtainable about the middle of its scale. Between 20% and 80% of the arc length, the accuracy on the ohms scale will be within  $\pm 5\%$  of the indication. Where the value of the unknown resistance to be measured allows a choice of range, that range which gives the most central reading should be employed. Resistance tests should never be carried out on components which are already carrying current. Upon those resistance ranges utilising an internal source of voltage it should be remembered that positive potential appears at the negative terminal of the instrument. This fact may be important

because the resistance of some components varies according to the direction of the current through them, and readings therefore depend upon the direction in which the test voltage is applied, quite apart from its magnitude. Such cases include electrolytic capacitors and rectifiers.

When measuring the leakage resistance of an electrolytic capacitor, the negative lead from the meter should be connected to the positive terminal of the capacitor, and the 1 megohm range employed.

### The 10,000 ohms and 100,000 ohms Ranges

These two lower ranges employ a  $1\frac{1}{2}$  V. cell (dimensions  $1\frac{1}{4}'' \times 1\frac{1}{4}'' \times 3\frac{5}{8}''$ ), such as Every Ready type "T". Adjustments for the condition of this cell are made by the potentiometer "P" and the resistance "R". The former compensates for variations in cell voltage, whilst the latter provides adjustment for changes in the internal resistance of the cell. This "R" adjustment, exclusive to the AvoMeter, enables measurements to be obtained to a greater degree of accuracy than would have been possible without its inclusion. It is of particular value upon the lowest range, which does, of course, when measuring low values, draw appreciable current from the cell.

Before commencing tests on either of these ranges, it is advisable to check and, if necessary, to adjust as follows:

- (1) Connect the leads together and set the "a.c." switch to "D.C."
- (2) With the "d.c." switch set to 100,000 ohms, adjust control "P" until the pointer indicates approximately zero on the ohms scale.
- (3) Switch to the 10,000 ohms range, and if the pointer differs from the last setting, adjust by means of "R" so that it just overshoots that position. Since, on the low range, the "R" adjustment causes ten times the change of pointer position that it does on the higher range, the need for just overdoing the apparently correct setting will be obvious. This adjustment should now be checked by comparing it once again with the pointer position on the 100,000 ohms range, and if necessary, the operation repeated. The object is to make the pointer take up the same position on the scale, irrespective of which of the two ranges is selected.
- (4) Set to zero ohms precisely, by means of control "P".

After these adjustments, the leads should be connected to the resistance to be tested.

The markings on the resistance scale apply to the 10,000 ohms range, but when using the 100,000 ohms range, the indication on the ohms scale should be multiplied by ten.

### The 1 megohm Range

This range makes use of two  $4\frac{1}{2}$  V. batteries in series (dimensions  $2\frac{7}{16}'' \times \frac{13}{16}''; \times 2\frac{5}{8}''$ ), such as Every Ready Type 1289. Before using this range it is necessary to carry out the following adjustments:

- (1) Connect the leads together, and set the "a.c." switch to "D.C."
- (2) Set the "d.c." switch to the 1 megohm position.
- (3) Raise the adjusting knob "Q" from its position in the panel and rotate it in a clockwise direction until the pointer indicates zero.

To test, connect the leads to the unknown resistance, and note the indication on the ohms scale. This value multiplied by 100 will be its actual resistance. Do not hold the clips when carrying out tests on high values or the leakage through the body might cause erroneous indications.

*Important.—After carrying out resistance tests on this range, the knob "Q" must be returned to its normal position in the panel.*

### Battery Condition

If on joining the leads together it is impossible to obtain zero ohms setting, or if, furthermore, the pointer position will not remain constant, but falls steadily, the internal batteries concerned should be replaced. It is important that a discharged battery should not be left in the instrument, since the electrolyte might seep through and cause damage to the meter.

### The 10 and 40 megohm Ranges

These ranges are made available by using the 100 V. and 400 V. a.c. or d.c. ranges respectively in conjunction with a suitable voltage source. It is safe and correct to use a voltage which may be between two thirds and two and a half times that of the voltage range in use (e.g., 230 V. a.c. with 100 V. a.c. range). To adjust to the ohms zero, the meter must be set to the appropriate range according to the type of voltage source and connected to the supply. The "Q" knob should now be lifted and rotated until the pointer indicates zero on the ohms scale (no harm results if the pointer goes beyond full scale deflection on lifting the "Q" knob). Switch off the supply to the meter and connect the resistance to be tested in series with the instrument. Reconnect the supply to the meter and the reading shown upon the ohms scale multiplied by 1,000 will give the value of the component under test.

Care should be exercised when using the mains. The article under test should not be handled whilst the current is on.

*Important.—After carrying out resistance tests on this range, the knob "Q" must be returned to its normal position in the panel.*

## CAPACITANCE MEASUREMENT

Capacitance tests are made with the aid of a 50 c/s a.c. mains supply of between 65 V. and 250 V. The meter should be set to its capacity range (set the "d.c." switch to "A.C." and the "a.c." switch to "Capacity") the leads connected to the supply and the "Q" knob raised and rotated until the pointer indicates "INF" on the capacitance scale. No harm or damage will result if the pointer goes beyond the limit of marking before the "Q" knob is withdrawn from the panel. The supply should now be removed from the meter, the unknown capacitor connected in series with one of the leads, and the supply reconnected. Direct indication of capacitance will now be shown within the usual commercial limits of accuracy. It is important that neither the capacitor nor the clips should be handled whilst the current is switched on.

Commercial frequencies other than 50 c/s may be used, but in such cases the voltage limits will vary from those given above. It is, however, important that 250 V. a.c. is not exceeded.

At the termination of a test always return the "Q" knob to its position in the panel. It is also desirable that the internal capacitor used on this test should be discharged by shorting the meter terminals, after the source of supply has been disconnected.

Electrolytic capacitors should be polarised before testing. If an electrolytic capacitor is polarised or has been in use immediately prior to a test being made, it can be checked in exactly the same way as a paper capacitor, if the test is carried out expeditiously, the internal capacitor within the instrument reducing the value of a.c. which is developed across the electrolytic during test. We do, however, advise that an electrolytic capacitor should be polarised whilst tests are being made upon it and, in order to do this, a choke of at least 20 henries, or a resistance of 50,000 ohms, should be connected in series with a suitable d.c. polarising voltage across the capacitor, taking care to observe correct polarity. The usual connections for making capacitance measurements are then made as above, the applied a.c. voltage in this case being restricted to 100 V. r.m.s.

Inasmuch as an inverse relationship exists between the magnitude of a capacitor's value and the voltage developed across it, where a voltage is applied from an external circuit to two or more capacitors in series it can be seen that as the value of the capacitors increases, the voltage across it drops. For this reason, therefore, electrolytic capacitors having a capacitance in the order of 20  $\mu$ F. at 12 V. working can be checked upon the instrument in the manner described above, since not more than their working voltage will be developed across them, by far the greater part of the applied voltage being dropped across the internal capacitor.

## AUDIO FREQUENCY POWER AND DECIBEL MEASUREMENTS

The power and decibel scales of the meter enable tests to be carried out upon amplifiers which are being fed with variable audio frequency voltage.

In the output stage of an amplifier, power is passed to the loudspeaker through a special transformer, the load impedance (which must suit the valve) being that of the loudspeaker itself, multiplied by the square of the transformer ratio. If the secondary feed to loudspeaker is open circuited, the primary will act as a choke to a.c. but pass the d.c. component. A resistance equivalent to the valve load impedance if now connected across the primary will absorb the power previously fed to the loudspeaker. This resistance can be the Avometer on one of its three ranges.

### AUDIO FREQUENCY POWER MEASUREMENTS

The following power ranges are obtainable:

- |                              |                     |                                                      |
|------------------------------|---------------------|------------------------------------------------------|
| (1) 0-2 watts in 5,000 ohms  | } using meter alone | } Details on obtaining these ranges are given below. |
| (2) 0-200 mW. in 500 ohms    |                     |                                                      |
| (3) 0-200 mW. in 50,000 ohms |                     |                                                      |

#### Range (1)

Set the "d.c." switch to "A.C." and the "a.c." switch to "Power and Decibel".

#### Range (2)

Set the "d.c." switch to "A.C." and the "a.c." switch to 10 V.

#### Range (3)

Set the "d.c." switch to "A.C." and the "a.c." switch to 100 V.

## DECIBEL MEASUREMENTS

Four decibel ranges are obtainable about a reference level of 50 mW.

- |                                      |                     |
|--------------------------------------|---------------------|
| (1) -15 db. to +16 db. in 5,000 ohms | } using meter alone |
| (2) -25 db. to +6 db. in 500 ohms    |                     |
| (3) -25 db. to +6 db. in 50,000 ohms |                     |

Ranges are set in accordance with instructions given in the previous paragraph relating to power measurements.

If suitable l.f. signals are fed to an amplifier, the meter can now be used to show its frequency response over the audio frequency range. The load must be transferred to the meter as previously described by disconnecting the loudspeaker from the secondary of the output transformer, and connecting the meter across its primary (Fig. 3).

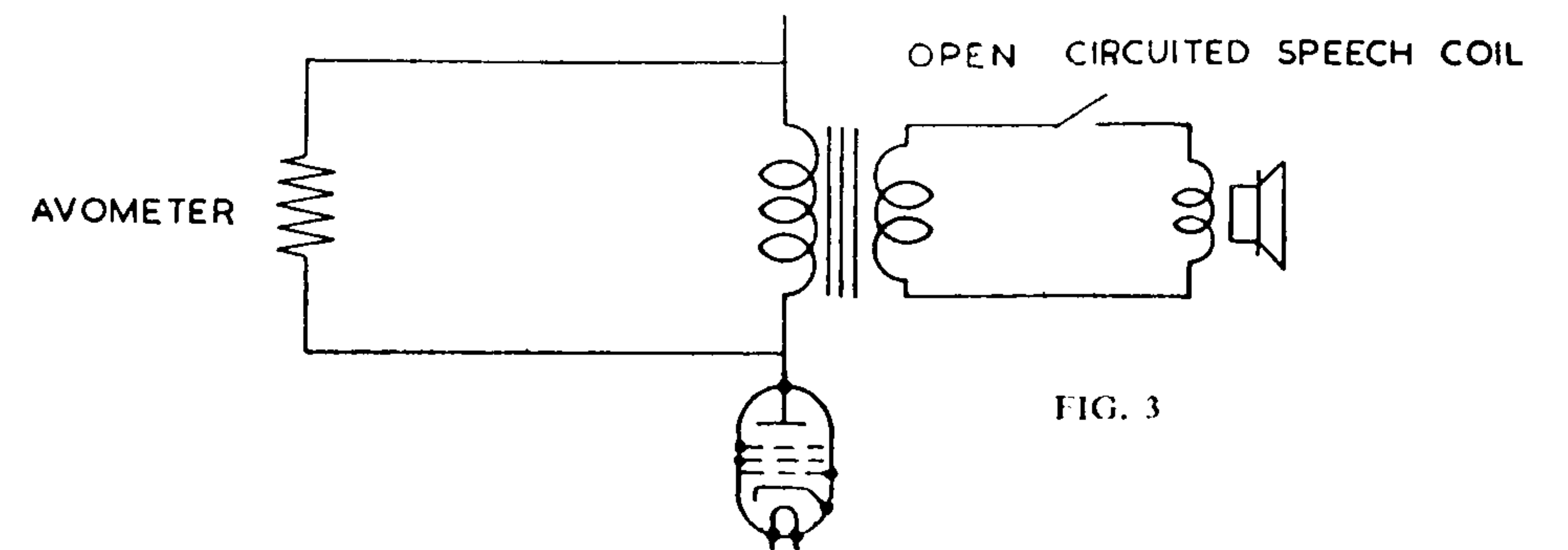

FIG. 3

It is possible to use the decibel scale by simply connecting the meter set to a suitable "a.c." voltage range, across the primary of the output transformer without disconnecting the secondary. It must be understood that in this case the variations in voltage read on the decibel scale give a measurement of relative output under varying conditions.

## ACCESSORIES

To extend the already wide ranges of the meter, numerous accessories are available. It should be noted that the divide-by-two feature on the instrument also halves the range of any of the current or voltage extension devices.

### MULTIPLIERS

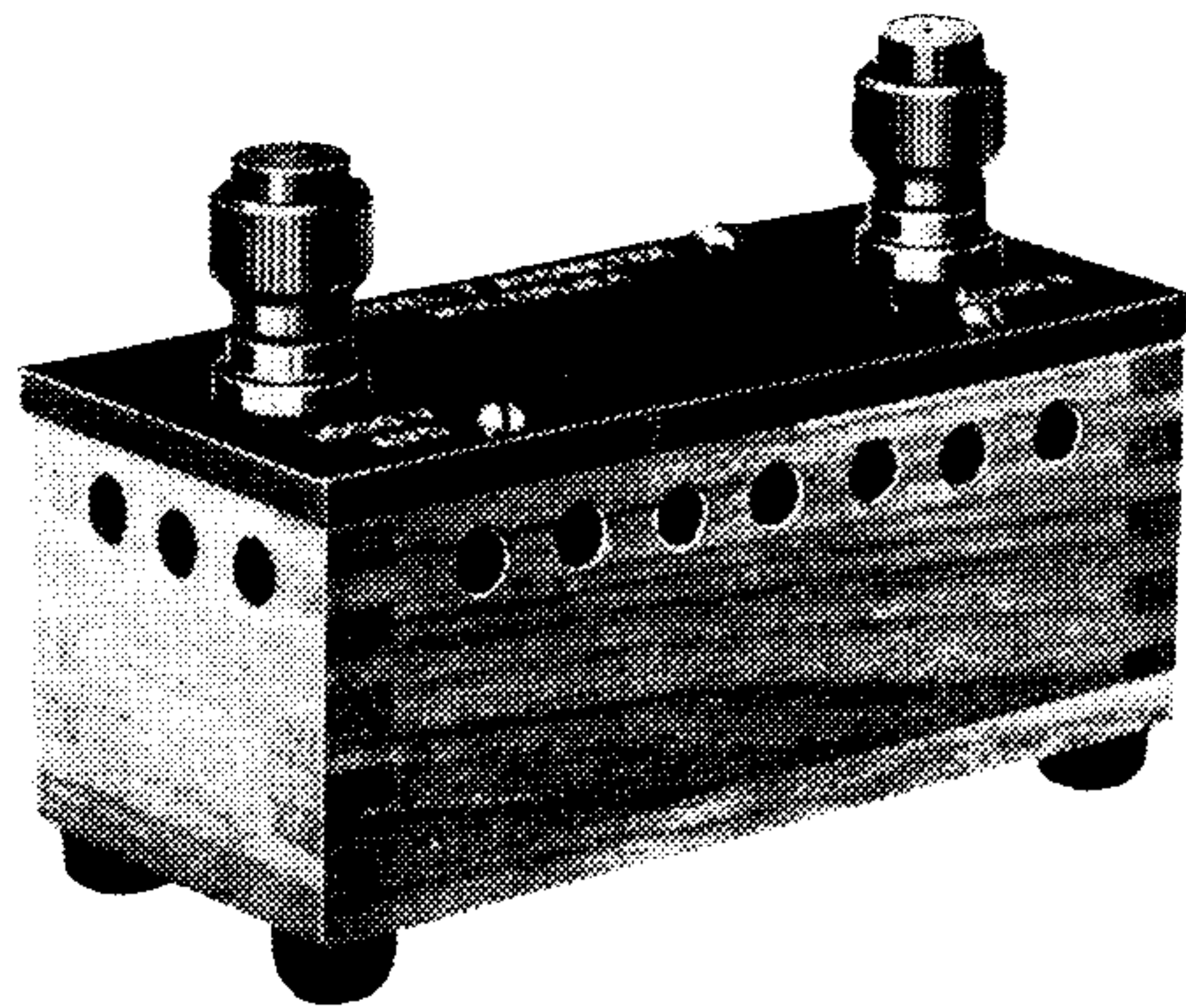

Multipliers are used to extend upwards the voltage range of the instrument and should be connected in series with the meter set to its 1,000 V. range. The same multiplier is used for "a.c." or "d.c." When in use with the multiplier, the meter should be kept at the "Earthy" side of the circuit.

The following multipliers are available.

0-2,000 V. (1,000 V. being dropped across Multiplier.)

0-4,000 V. (3,000 V. being dropped across Multiplier.)

### SHUNTS

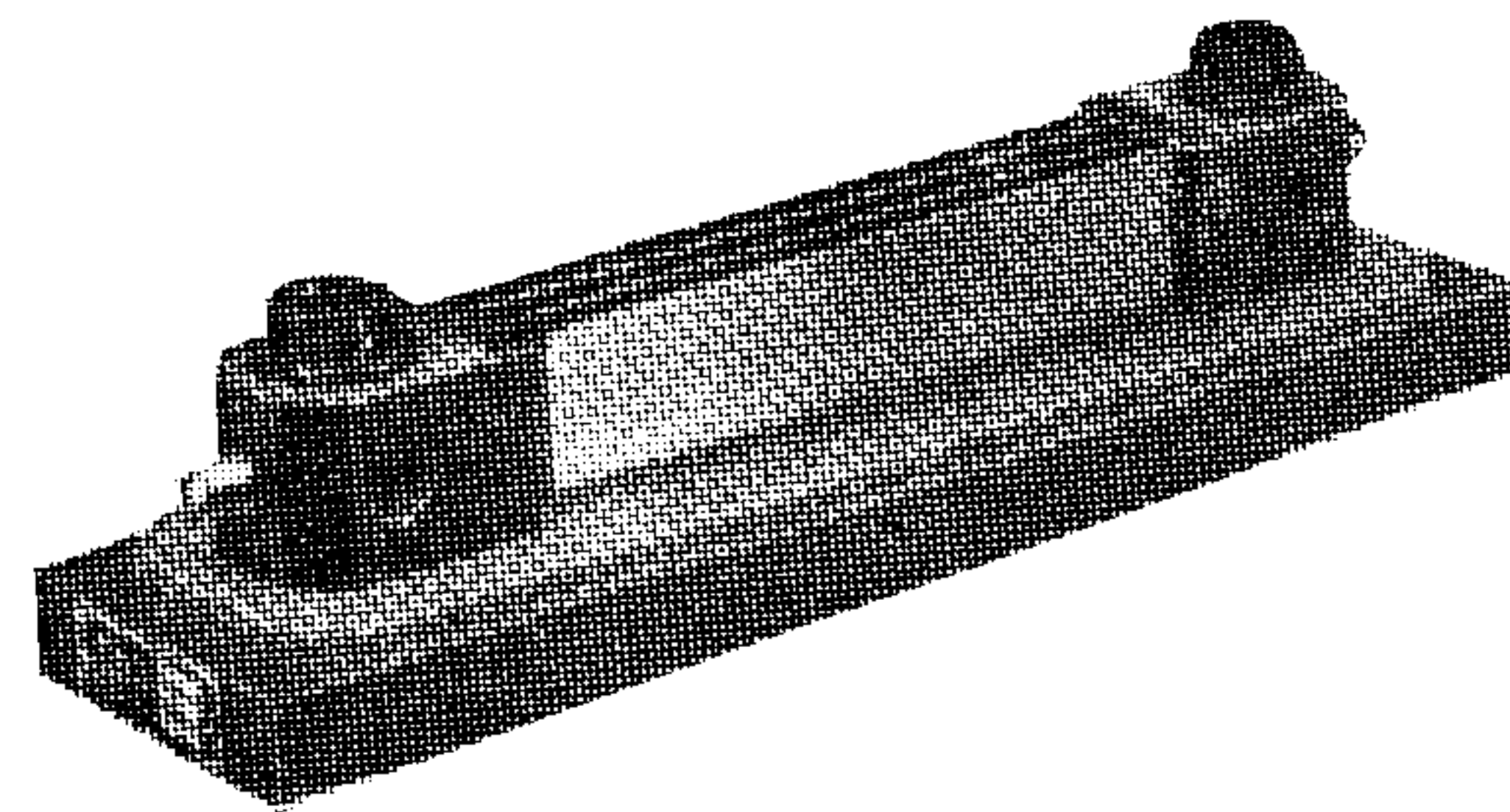

Shunts are available to extend the "d.c." current ranges. The shunt should be connected by means of its two main terminals in series with the circuit upon which measurements are to be taken, and the meter set to its 2 mA. (100 mV.) "d.c." position, should then be connected to the two small studs on the shunt end blocks.

The AvoMeter when so set, consumes only 2 mA. at full scale deflection, a value which is negligible in comparison with the full scale current of the shunt. The millivolt drop across the shunt is directly proportional to any current which may flow through it, and since the deflection on the meter is also directly proportional to the millivolt drop across its terminals, the instrument indicates correctly over its entire scale length.

When the divide-by-two button is pressed, the meter range is reduced to 50 mV. and therefore any shunt carrying half its rated current is again capable of producing full scale deflection upon the meter. Thus, for example, a 400 amp. shunt provides an additional range of 0-200 amps.

The following shunts are available:

400 amp.      200 amp.      100 amp.      50 amp.

### TRANSFORMERS

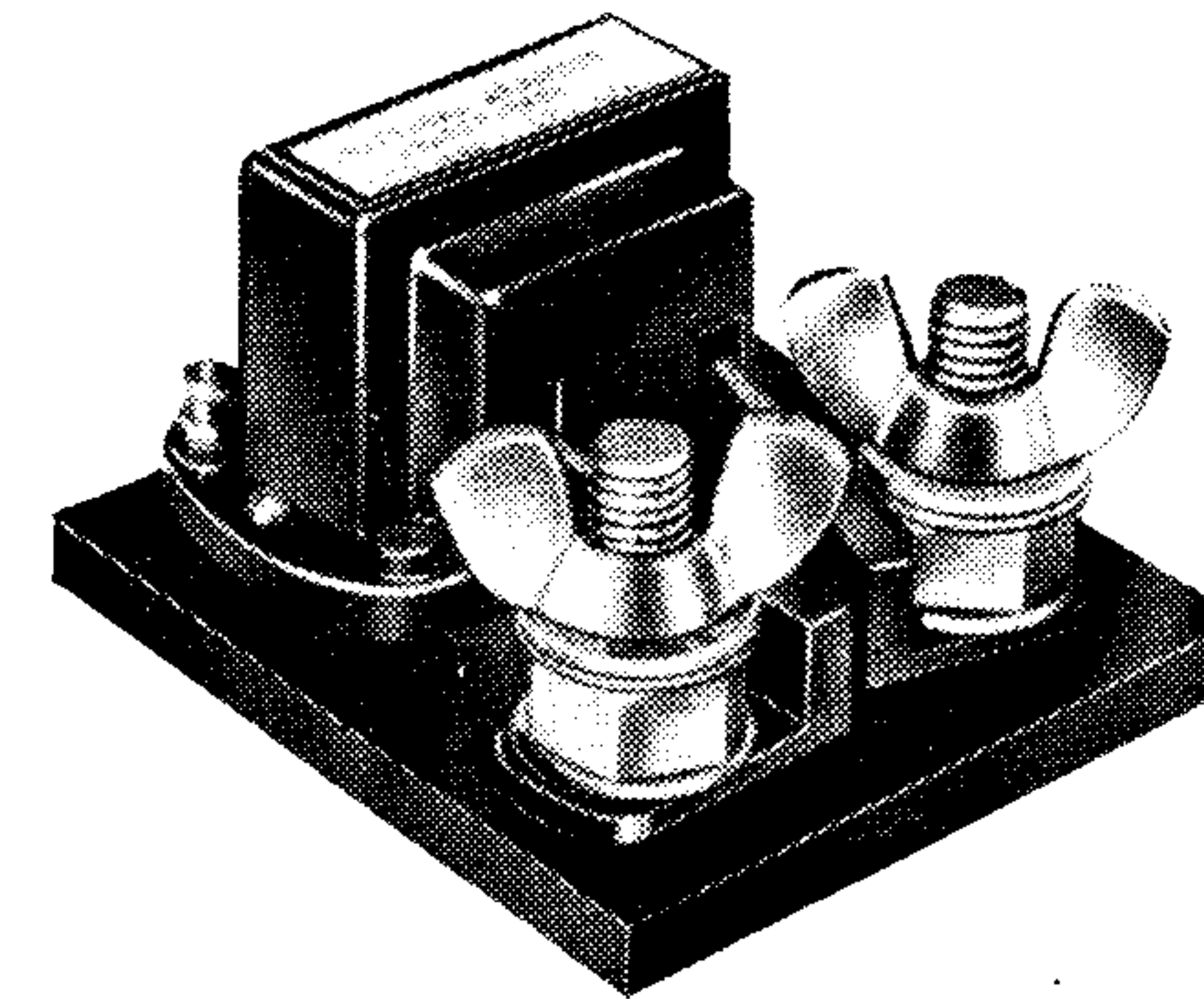

Current transformers are used to extend the "a.c." current ranges on the meter. Owing to the very high potential which may build up in the secondary circuit of a current transformer if left open circuited, it is most important to ensure that current is not passed through the primary, unless the meter, on its correct range, and with the cut-out properly set, is connected to the appropriate terminals of the transformer. The secondary of

the transformer produces 0.1 amps. when the full rated current is flowing in the primary, and is made to match the meter range in use.

The transformer should be connected in series with the circuit under test by means of its two large terminals, but current must not be passed until the secondary circuit is completed. This is done by setting the AvoMeter to its 0.1 amp. a.c. range and connecting its leads to the two small terminals on the transformer.

The operation of the divide-by-two feature halves the ranges presented by the transformers listed below. The following are available:

400 amp.      200 amp.      100 amp.      50 amp.

A double wound 200/50 amp. transformer can also be supplied.

## THE MODEL 7 POWER FACTOR AND WATTAGE UNIT

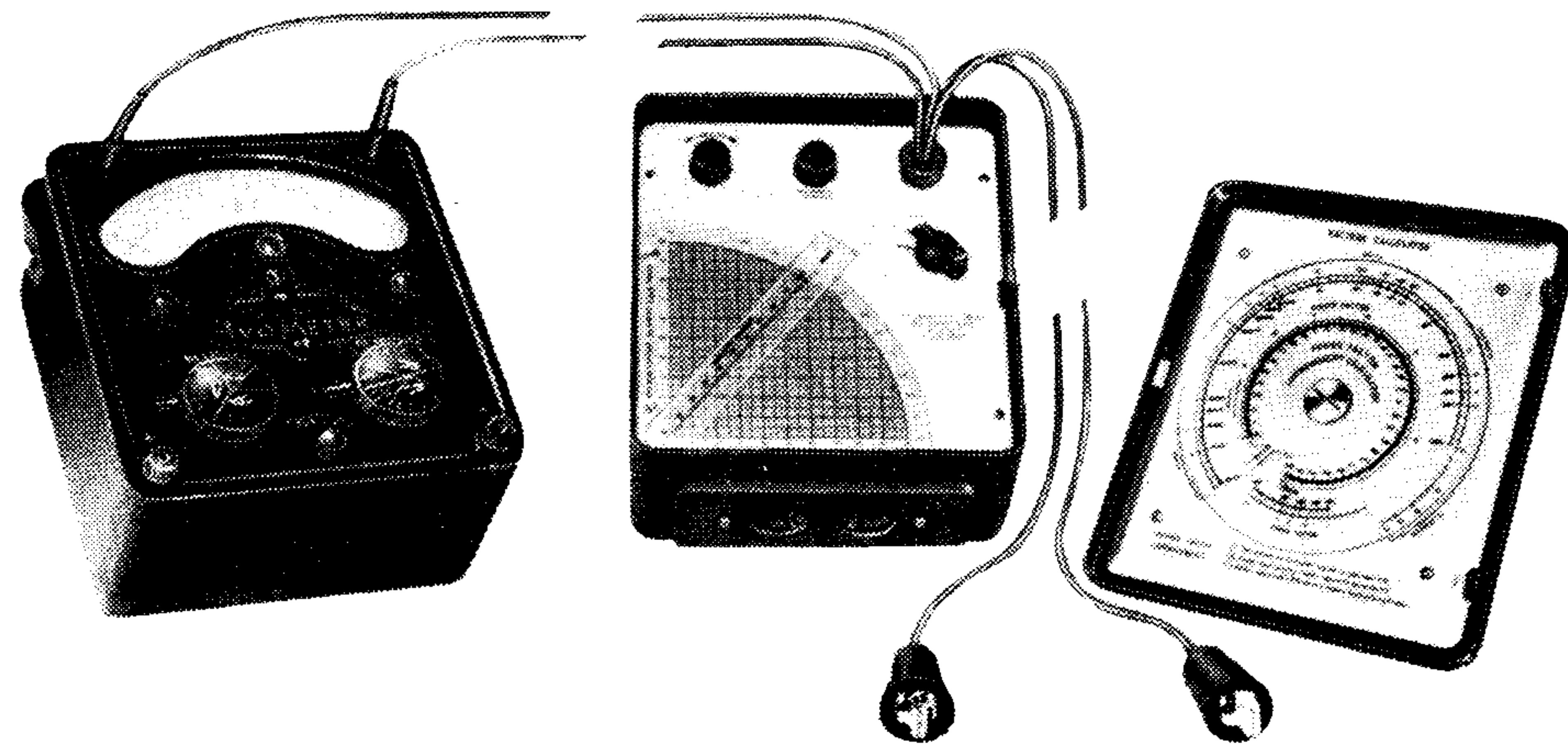

*The illustration shows a Power Factor and Wattage Unit connected up to a Model 7 Mk. II AvoMeter ready for use.*

This device will only operate with a Model 7 AvoMeter fitted with "P.F." sockets at the top of the panel, and is intended for use on 100-450 V., 25-2,000 c/s a.c. supplies. The complete unit is approximately the same size as the AvoMeter.

Readings can be taken on the AvoMeter used in association with the Unit, from which power factor and a.c. power can be determined in single phase, or balanced 2 or 3 phase circuits, provided the current remains constant for two or three seconds, and is of the normal sinusoidal wave form. Unbalanced 2 or 3 phase power can be determined as the sum of the powers in the separate phases. If necessary, external current transformers having small phase angle errors may be included to extend the current range of the AvoMeter. The Company can supply a suitable range of transformers up to 400 amp. Since practically all apparatus which necessitates the use of a power factor indicator works at a lagging power factor, no discriminator is included.

The principle involved is to measure the current in one phase of the circuit under test and then to neutralise its power component in the case of single phase, or its reactive component in the case of balanced 2 or 3 phase circuits. The relationship between the first and second readings in any test provides the information for power factor determination.

The above operation is performed by connecting the Unit to the mains and tapping off a controlled amount of current by means of a variable resistance, the current being fed to the rectifier in the meter.

Since the phase of the neutralising current may be such that it causes a rise instead of a fall in the pointer indication when the control is moved from its "START" position, a reversing switch has been incorporated to save altering the lead connections. To cope with all voltages likely to be encountered a voltage selector switch marked with limits for each setting has been provided. When operating the resistance control, the object is always to obtain a minimum pointer indication, but since over-compensation causes the pointer to rise again, there is no difficulty in obtaining the minimum. If, however, operation of the resistance control causes a rise in pointer indication whichever side the reversing switch may be placed, the pointer must already be at its minimum indication, i.e., it is either a single phase zero power factor load, or a three phase unity power factor load.

It will be apparent that in single phase working the neutralising current must be in phase with the voltage which supplies the load, and can be used to cancel out its power component. It follows that with substantially resistive loads there will be a considerable difference in the pointer indication and with reactive loads there will be little change.

In 2 or 3 phase working, the current is measured in one phase and the neutralising voltage is derived from across the other phase or phases. This neutralising voltage is, therefore, in quadrature with that which would be used in the single phase test and consequently it neutralises the reactive component. Any residual indication shown on the meter is in this case the power component and it will be relatively large with resistive loads and small with reactive loads.

*Should the characteristics of the circuit under test be such that upon switching off, a voltage much in excess of the mains voltage is likely to be generated across the load, it is advisable to disconnect the neutralising voltage leads before switching off.*

### Note

- |                            |                                                                                                         |
|----------------------------|---------------------------------------------------------------------------------------------------------|
| <i>Single phase.</i>       | The voltage should be taken across the mains.                                                           |
| <i>Balanced 2 phase.</i>   | The current is measured in one line, the voltage being taken from across the other line to the neutral. |
| <i>Balanced 3 phase.</i>   | The current is measured in one line and the voltage is taken across the other two lines.                |
| <i>Unbalanced 3 phase.</i> | Regard each phase as a single phase test.                                                               |

A summary of the operating instructions, including the use of the calculators, is given overleaf.

### Preliminary Settings of the Unit

- (1) Remove the leads from the drawer in the Unit and plug into the appropriate socket.
- (2) Set the voltage switch at a value to suit the supply. (For voltages below 100 V. set to "100-160 V." position.)
- (3) Set the movement reversing switch at its mid-position.
- (4) Set the adjusting knob at the position marked "START".
- (5) Connect the short leads to the sockets marked P.F. at the top of the AvoMeter.
- (6) Connect the long leads to points which will attain the required voltage when the load is switched on.

### Test

The AvoMeter should be set to a suitable a.c. current range for the load and connected in series with it. The supply should then be switched on and a note made of the current flowing. The object is then to reduce the pointer indication on the AvoMeter to a minimum by rotating the adjusting knob upon the Unit after having moved the reversing switch to the side which allows the reduction to take place. The minimum reading should be taken, the power factor being dependent on the ratio of the two readings. After tests, the knob and the reversing switch should be returned to their initial positions.

*Never switch to a lower current range on the AvoMeter when adjusting for the minimum pointer indication, but the divide-by-two button can be used throughout the test if desired to increase the pointer deflection. Circuits carrying current in excess of 10 amps can be dealt with by using a suitable external current transformer connected to the AvoMeter in the normal manner.*

*Should the load be highly resistive and single phase, or highly reactive and balanced multi-phase, it may be found that there is insufficient neutralisation to obtain a minimum reading when operating upon supplies less than 100 V. Such a condition could occur if practically full scale deflection were produced on the range in use. If this situation is encountered, switch to the next higher current range (using  $\div 2$  button if desired to increase the deflection), since less neutralisation will then be necessary. The voltage should now be adequate to deal with the altered conditions, provided that the Voltage Selector Switch on the Unit is set to its 100-160 V. position.*

### Power Factor Calculator

In the case of a single phase test, the point on the swinging arm corresponding to the maximum current should be superimposed over the squared scale at a point corresponding to the minimum current single phase on the horizontal scale. The power factor is indicated on the scale at the extremity of the swinging arm.

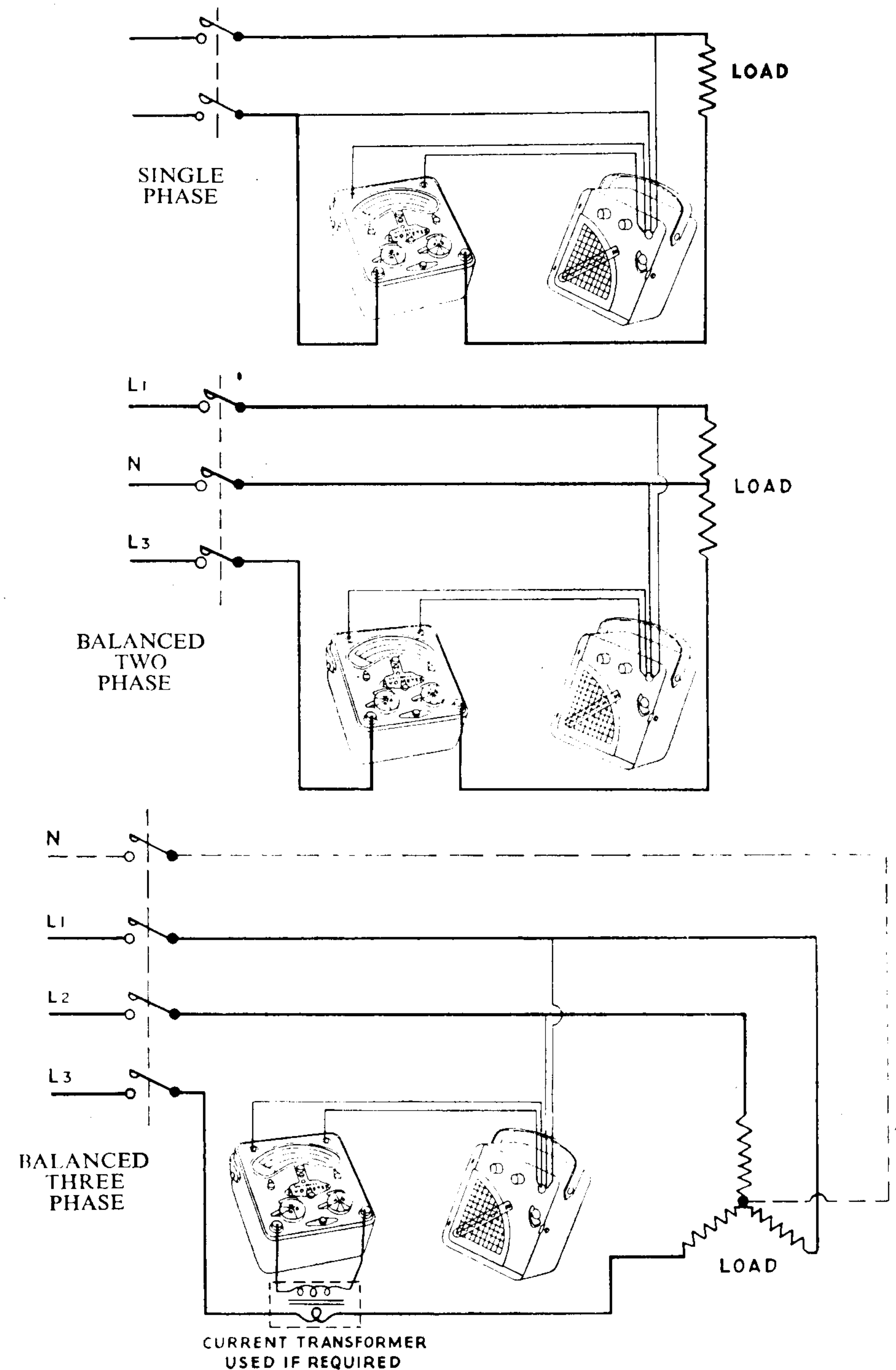

For balanced 2 or 3 phase the maximum current reading on the arm should lie over the point corresponding to the minimum current on the vertical scale.

#### Note

If the main purpose of the test is to determine the power factor, the relative values only of the two readings is required irrespective of their actual magnitude. It will be found helpful in such cases to use the "Q" knob on the meter to bring the initial reading to a convenient whole number (100 if possible). Once the "Q" knob has been set during this initial operation, it should be left without alteration throughout the remainder of the test, since this primary adjustment will alter the second reading in the same ratio as the first, and thus no error will be introduced. An increased pointer deflection would, of course, make for higher accuracy of reading. Return the "Q" knob to its normal position after use. As a matter of interest, in the case of balanced 2 and 3 phase loads, the Power Factor is the minimum current reading divided by the maximum current reading.

#### Wattage Calculator

**Single phase:** The voltage across the load should first be measured and the power factor then determined as described above. This power factor value on the circular calculator should be set to the point corresponding to the measured voltage. The power in watts or kilowatts may then be read opposite the point on the current scale which corresponds to the *maximum* current reading.

The calculator has only been marked from 10 mA. and the Power Factor from 0.1 upwards. If at any time values below these are encountered, the calculation can be based on, say, ten times the current or Power Factor, and the Wattage indication then divided by ten.

**Balanced 2 phase:** The line/neutral voltage should be measured and the unity (1.0) power factor marked on the calculator set against the voltage value. The wattage *per phase* is then read against the *minimum* current, it being unnecessary to measure the power factor. The total wattage is twice the phase wattage.

Alternatively, the line/line voltage should be measured and the mark  $V_{L_2}$  on the calculator set against this value. The total wattage is then read against the *minimum* current, there being no necessity to determine the power factor. *Note:* the voltage derived from line to line must not be applied to the Unit, but merely used to facilitate computation on the wattage calculator.

**Balanced 3 phase:** The line voltage should be measured and the mark  $V_{L_3}$  on the calculator set against this value. The total wattage is then read against the *minimum* current, it being unnecessary to determine the power factor.

**Unbalanced 2 or 3 phase:** The power in each phase must be determined as a single phase test, the total power being the sum of the individual phases.

For "star connection" circuits the power in each phase is the product of the phase volts, the line current and the power factor.

For "delta connection" circuits the power in each phase is the product of the line volts, the phase current and power factor. This latter case can only be determined if phase currents can be measured.

*Other applications for the device such as the determination of phase angle between two voltage sources may present themselves to the discerning engineer.*

#### The Measurement of Reactive kVA with the Power Factor and Wattage Unit

Many supply authorities stipulate that a penalty will be imposed if the power factor of a connected load drops below a certain figure. In practice, therefore, it is not only desirable to know the power factor, but the amount of correction required to improve it to a given figure. This Unit will provide all the necessary information.

Although "bad power factor" can apply to capacitive loads, it is normally the inductive load which causes trouble in industry, due to the use of motors, transformers and other plant which give rise to inductive "Wattless current". Such current only burdens cables and power stations unnecessarily, and involves supply authorities in expense which many are no longer prepared to accept.

The usual method of obtaining the necessary correction, is to connect capacitors in parallel with the inductive load, these capacitors being normally rated by the manufacturer in kVAr.

#### TO OBTAIN kVAr

- (1) Ascertain the power factor and total wattage of the load.
- (2) Set arrow upon the Power Factor Improvement scale to desired power factor.
- (3) Read multiplication figure opposite existing power factor.
- (4) The kVAr required to correct the circuit is then given by multiplying the wattage of the load by the factor obtainable in (3) above.

If when this kVAr figure has been obtained, it is desired to know the value of the required correction capacitance, it can be found from the following formula:-

$$\text{Capacitance in } \mu\text{F} = \frac{\text{kVAr} \times 10^9}{2\pi f (V^2)}$$

Where:  $\pi=3.14$ .  $f$ =frequency of supply.  $V$ =voltage of supply.

For balanced 3 phase working, the capacitance is divided into three equal banks.

### RESISTANCE RANGE EXTENSION UNIT

To obtain even lower readings than those already provided upon the low ohms range of the instrument, a Resistance Range Extension Unit has been developed. This will enable either 10 ohms or 1.0 ohms to be read at full scale deflection upon the uniformly divided scale of the meter.

On the 10 ohm range, the unknown resistance is connected across the 10 ohm and negative terminal of the Unit. The meter, set to its "1 V. d.c." range is connected between the positive and 10 ohms terminal on the unit, the "Q" knob being used to bring the pointer to the 100 mark on the uniformly divided scale. The meter leads should then be transferred across the unknown resistance, and the reading on the 100 division scale noted. This shows the value of the resistance under test as a percentage of 10 ohms, or if the actual readings obtained are divided by 10, direct reading in ohms will be given.

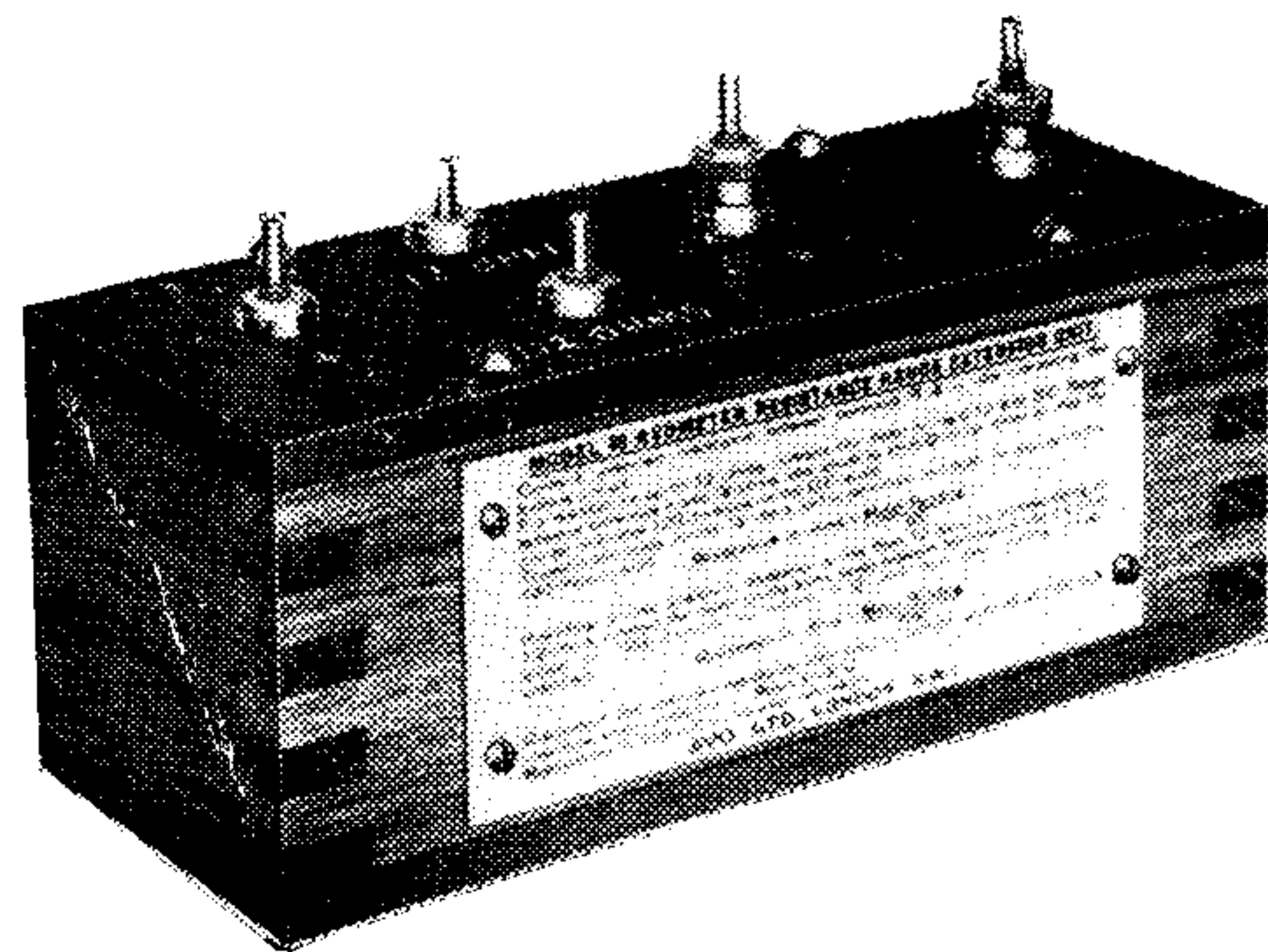

If the reading is less than 1 ohm, a more accurate test can be carried out on the 1 ohm range. The standardising procedure should be repeated with the meter set to its 2 mA. range and its leads connected between the positive and 1 ohm stud. The leads should then be transferred across the unknown resistance, the pointer indication on the 100 division scale giving the value of the resistance as a percentage of 1 ohm. If the actual readings obtained are divided by 100, direct reading up to 1 ohm will be given. The procedure outlined above for setting the instrument to full scale deflection by means of its "Q" knob must be repeated for every test.

Immediately tests are completed, disconnect the meter and the unknown resistance from the unit to avoid discharging the internal cell.

*Important.*—After carrying out resistance tests with the unit, the "Q" knob on the instrument must be returned to its normal position in the panel.

*It should be noted that this accessory contains a 1½ V. cell similar to that housed in the meter. This cell should be examined periodically to ensure that it has not become discharged.*

### LEATHER CARRYING CASES

The illustration shows the specially designed leather case which can be supplied with the Model 7 Mk II. AvoMeter if desired.



An instrument can be used whilst still retained in this ever-ready type carrying case.



