

THE

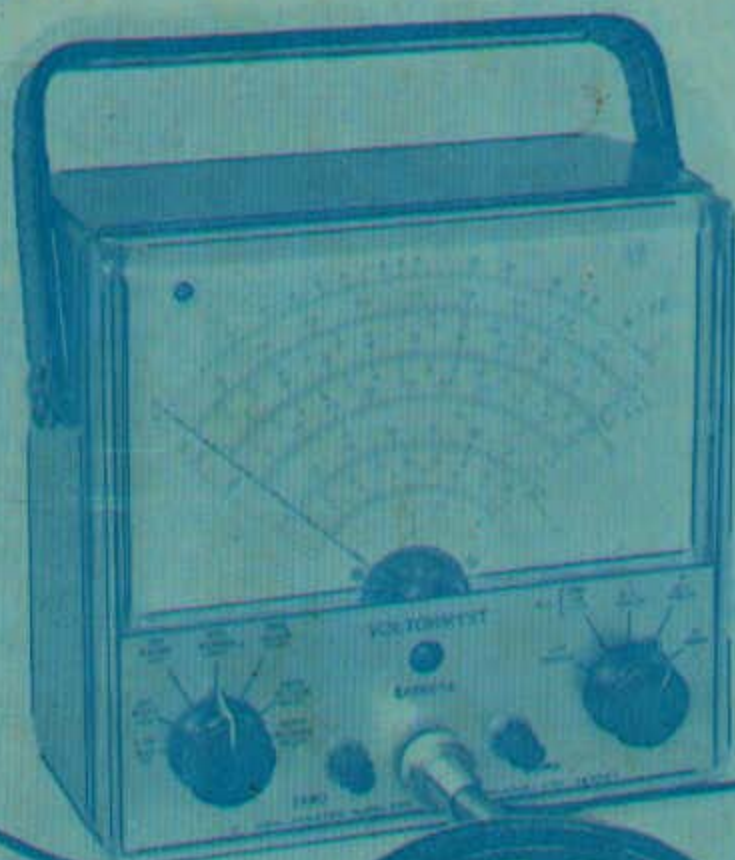

VOLTOHMYST

2A56074



- APPLICATIONS
- SPECIFICATION
- OPERATION
- MAINTENANCE

AMALGAMATED WIRELESS (AUSTRALASIA) LTD., SYDNEY

The Reference Number
of this instruction
book is 1-56074B

The following changes have occurred subsequent to the printing of this handbook.

- R13** changed to Welwyn C24.
- R30** changed to 33k ohms.
- R31** changed to 56k ohms.
- C10** 6uF, 25VW, non-polarised, Ducon ET1-B, is connected from junction R26/R31/R33 to chassis earth.

Type number of Nickel-Cadmium cell should be Eveready N46.

AMALGAMATED WIRELESS (AUSTRALASIA) LTD.
47 York Street.
SYDNEY

Also at:

BRISBANE
MELBOURNE
PERTH
WELLINGTON, N.Z.
LONDON, U.K.

TABLE OF CONTENTS

	Page No.
Brief Description	3
Accessories	5
Specification	6
Preliminary Adjustments	8
Function of Controls	9
A.C. Voltage Measurement	10
Resistance Measurement	12
Resistance Measurement above 1000M Ω	13
dbm. Measurement	14
D.C. Voltage Measurement	18
Centre Zero Measurement	19
Technical Description	20
Maintenance	22
Component Schedule	27

ILLUSTRATIONS

The 2A56074 Voltohmyst	Cover
Fig. 1. Typical Waveforms	11
Fig. 2. Resistance Measurement above $1000M\Omega$	13
Fig. 3. Conversion Chart for dbm. values	15
Fig. 4. Circuit Diagram of Voltohmyst 2A56074	16-17
Fig. 5. Pulse Response Capability Chart	21
Fig. 6. Location of Calibrating Controls	24

BRIEF DESCRIPTION

The A.W.A. Voltohmyst type 2A56074 is a versatile test instrument designed for the accurate measurement of peak-to-peak and R.M.S. values of A.C. waveforms, resistance, and positive and negative D.C. voltages. R.M.S. and D.C. voltages up to 1500V may be measured over seven ranges with an accuracy of 3% of F.S.D. Resistance values up to 1000 Megohms, complex waveforms with peak-to-peak values up to 2100V and sinusoidal waveforms up to 4200V peak-to-peak may also be measured.

For the measurement of voltages, up to and including 500V, having a source impedance of approximately 100 ohms, the instrument is frequency compensated to provide a flat characteristic from 30c/s to 2.5Mc/s. When used in conjunction with a crystal diode probe such as the A.W.A. 2R56075, the input capacitance is reduced to a low value and the A.C. voltage ranges become accurate to within $\pm 10\%$ from 50kc/s to 200Mc/s, and $\pm 15\%$ up to 250Mc/s.

When the associated "D.C." probe is used, the input resistance becomes 11 Megohms for all D.C. ranges. This feature makes the Voltohmyst invaluable for measurements where a lower impedance instrument would load the circuit, resulting in erroneous readings (e.g. Oscillator grid measurements).

When used to measure resistance the instrument will read from 0.2 ohm to 1000 Megohms in seven ranges. Convenient mid-scale values are set at 10, 100, 1000, 10,000 and 100,000 ohms and 1 and 10 Megohms.

A fixed earth lead, connected to the chassis of the instrument and by means of an "alligator" clip to the unit under test, ensures accuracy of measurement.

Provision is made for centre-zeroing the instrument, a useful feature for F.M. Discriminator alignment.

The 4R56075 Plug and Cable and the 1R56075 A.C.-D.C. Probe are supplied with the instrument.

The 1R56075 Probe contains an internal switch and is used for normal D.C., A.C. and resistance measurements. The barrel of this probe is coloured grey.

ACCESSORY PROBES NOT SUPPLIED WITH INSTRUMENT

2R56075 PROBE (shown on cover)

When the 2R56075 Crystal-diode Probe is used with the instrument the usable frequency range is extended to 250Mc/s. This probe consists of a germanium diode rectifier and an R.C. network in a polystyrene housing. The probe plugs onto the 4R56075 Plug and Cable, eliminating the need for an extra cable. Its barrel is coloured brown.

The probe may be used in R.F. circuits to measure sinusoidal waveforms up to 20V R.M.S. in the presence of up to 250V D.C. The overall frequency range is 50kc/s to 250Mc/s and the voltages are read from the D.C. scales in terms of R.M.S. volts (e.g. a reading of 5V D.C. indicates that the sinusoidal waveform has an R.M.S. value of 5V). The overall accuracy of the instrument when using the crystal probe is $\pm 10\%$ up to 200Mc/s and $\pm 15\%$ up to 250Mc/s.

3R56020 PROBE (not illustrated)

When the 3R56020 High-Voltage Probe and Cable is used with the instrument, D.C. voltages as high as 50,000V may be measured in six ranges. The probe employs a multiplying resistor of 1090 Megohms to make the overall input resistance 1100 Megohms, and thus gives a multiplying factor of 100. Do NOT attempt to measure voltages above 50,000V as the maximum voltage rating of the probe may be exceeded. The extremely high impedance is useful for measurements involved in Phototubes, Geiger-counters and Television.

SPECIFICATION

D.C. Voltmeter

Ranges: 0 to 1.5, 5, 15, 50, 150, 500, 1500 Volts.
Input Resistance: 11 Megohms (all ranges).
Input Capacity of Probe: Approx. 4 uuF.
Sensitivity on 1.5V range: 7.3 Megohms per volt.
Overall Accuracy: $\pm 3\%$ of F.S.D.

A.C. Voltmeter

Ranges: 0 to 1.5, 5, 15, 50, 150, 500, 1500 Volts R.M.S.
..... 0 to 4, 14, 42, 140, 420, 1400, 4200 Volts P-P.
Overall Accuracy: $\pm 3\%$ of F.S.D.

Input Resistance and Capacitance:

1.5, 5, 15, 50, 150V ranges: 0.83 Meg. shunted by 70uuF.
500V range: 1.3 Meg. shunted by 50uuF.
1500V range 1.5 Meg. shunted by 50uuF.

Frequency Response:

(for all ranges except 1500V which is flat at mains frequencies)

Source Impedance	Response $\pm 10\%$.
100 ohm approx.:	30c/s to 3Mc/s:
1000 ohm approx.:	30c/s to 0.5Mc/s:
5000 ohm approx.:	30c/s to 250kc/s:
10000 ohm approx.:	30c/s to 80kc/s:

Crystal Probe: Within $\pm 10\%$ from 50kc/s to 200Mc/s. $\pm 15\%$ to 250Mc/s.

Maximum Input Voltages:

D.C. (no A.C. present): 1500V.
A.C. (no D.C. present):
Sine Waves: 1500V R.M.S., 4200V P-P.

Complex Waveforms: 2000V P-P.

Combined A.C. & D.C. Peak Voltage: 2000V.

Ohmmeter

Seven Ranges: 0 to 1000 Megohm.

Meter Movement

D.C. current for F.S.D.: 200uA.

Power Supply

Voltage Rating: 230 to 250V A.C.

Frequency: 50c/s

Power Consumption: 6 Watts Approx.

Battery (1.25V. Nickel-Cadmium Cell Eveready D46.

Valve Complement: 6AL5 and 12AU7.

Mechanical

Height: 6 $\frac{1}{2}$ " excluding handle.

Width: 7".

Depth: 4 $\frac{1}{2}$ " excluding knobs.

Weight: 7 lb. 13 oz. with probe.

Finish: Blue-grey "Hammertone" baked enamel case.
Satin aluminium panel.

PRELIMINARY ADJUSTMENTS

- (1) After switching on a new instrument, or one which has been out of service for some time, allow it to run for 15 to 30 minutes to re-activate the in-built Nickel-Cadmium cell used for ohms measurements.
- (2) Connect the A.W.A. type 4R56075 Plug and Cable to the connector on the front panel.
- (3) Adjust the meter to mechanical zero.
- (4) Connect the power cord to the A.C. mains.
- (5) Set the FUNCTION switch to "— D.C. VOLTS" and allow a short warm-up period.
- (6) With RANGE switch in 1.5V position, adjust the ZERO control to position the meter pointer to zero.
- (7) Turn the FUNCTION switch to "R OHMS," and adjust the OHMS control for F.S.D.

FUNCTIONS OF CONTROLS

FUNCTION Switch:

Applies power to the instrument when this control is turned clockwise from the OFF-TRANSIT position, and selects the measurement function of the instrument. In the OFF-TRANSIT position the meter terminals are shorted out to damp the meter, thereby reducing the possibility of damage.

RANGE Switch:

Selects the A.C., D.C., or Resistance range required.

ZERO Control:

This is used to set the meter pointer to the zero mark on the scale.

OHMS Control:

This is used to set the meter pointer to the F.S.D. mark on the Resistance scale.

A.C. VOLTAGE MEASUREMENT

DO NOT EXCEED THE SPECIFIED MAXIMUM INPUT VOLTAGE.

There are seven R.M.S. voltage ranges calibrated on four scales, viz., 0 to 1.5V on the first, 5V on the second, 15, 150 and 1500V on the third and 50 and 500V on the fourth.

There are also seven peak-to-peak volt ranges calibrated on four scales, viz., 0 to 4V on the first, 14V on the second, 42V, 420V and 4200V on the third and 140V and 1400V on the fourth.

To read A.C. volts, proceed as follows:—

- (a) Attach the A.C.-D.C. Probe 1R56075 to the plug and cable already inserted in the instrument.
- (b) Set the switch on the probe to A.C. — OHMS.
- (c) Set FUNCTION switch to "A.C."
- (d) Set RANGE switch to a position higher than voltage to be measured.
- (e) Adjust ZERO control to position the pointer to zero.
- (f) Connect the clip on the earth cable to earth on the unit under test.
- (g) Connect the probe tip to the other side of the voltage source.
- (h) Reset the RANGE switch to obtain a near full-scale reading.
- (i) Read voltage from appropriate scale.

Figure 1 shows typical waveforms which can be measured with the Voltohmyst.

NOTE: The Voltohmyst case is always earthed through its power cable; only the A.C.-D.C. probe is needed—when measuring A.C. voltage at power outlets,

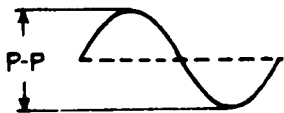

SINE WAVE.



CATHODE OF VERTICAL OUTPUT TUBE.

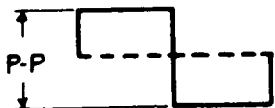

SQUARE WAVE



INPUT TO 2ND VIDEO AMPLIFIER.

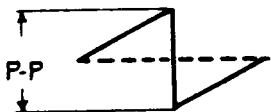

SAW TOOTH WAVE

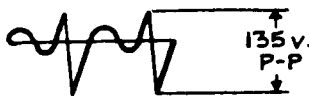

HORIZONTAL OSCILLATOR TRANSFORMER

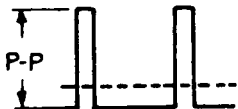

PULSE WAVE.



ONE HORIZONTAL DEFLECTING COIL.

Fig. 1. Typical Waveforms.

RESISTANCE MEASUREMENTS

NOTE.—Low current, low resistance devices, such as meter movements and thermocouples, may be damaged unless a range higher than R X 10 is used because up to 1.3V. may be applied across the resistance when the RANGE switch is set at R X 1 or R X 10.

There are seven scales: R X 1, 10, 100, 1000, 10K, 100K and 1 Meg.

To measure resistance, proceed as follows:—

- (a) Attach the A.C.-D.C. Probe 1R56075 to the plug and cable already inserted in the instrument.
- (b) Set the switch on the probe to A.C. — OHMS.
- (c) Set the FUNCTION switch to "R OHMS."
- (d) Set the RANGE switch to R X 10 position.
- (e) Short the probe tip to the earth cable and adjust the ZERO control to position the pointer to the left-hand zero.
- (f) Remove the short. The pointer should now deflect to full scale; if not, adjust the OHMS control to obtain full-scale deflection.
- (g) Connect the earth cable and the probe tip to the resistance to be measured. If one end of the unknown resistance is earthed, attach the earth cable to this end. The equipment in which the unknown resistance is being measured must be switched off.
- (h) Reset the RANGE switch to give a convenient deflection on the R scale.
- (i) Multiply the reading on the R scale by the factor indicated on the RANGE switch scale.

RESISTANCE MEASUREMENTS ABOVE 1000 Megohm

For measurements above 1000 Megohms, such as the leakage resistance of small mica and paper capacitors, an external D.C. voltage source between 20 and 500 Volts is used. Connections are as in the circuit below.

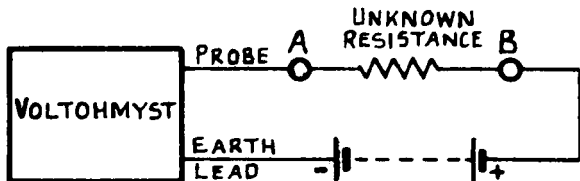

Fig. 2. Resistance Measurement Above 1000M Ω .

To measure high resistance, proceed as follows:—

- Set FUNCTION switch to "+ D.C. VOLTS" and measure the voltage at point B.
- Measure the voltage at point A.
- Compute the unknown resistance R_x from the following formula:—

$$\begin{aligned} R_x \text{ (Megohms)} &= \frac{11 \text{ (Volts at A — Volts at B)}}{\text{(Volts at B)}} \\ &= \frac{11 (V_a - V_b)}{V_b} \end{aligned}$$

dbm. MEASUREMENTS

The conversion chart of Fig. 3 may be used to determine dbm. values corresponding to R.M.S. voltage readings across a resistive load of 600 ohms. A dbm. value is defined as the number of db above or below a reference level of $1mW_0$.

The graph makes rapid conversion possible from R.M.S. voltages into dbm. The associated power levels may be read along the top of the graph. A correction chart and formula are given for R.M.S. voltages measured across resistive loads other than 600 ohms.

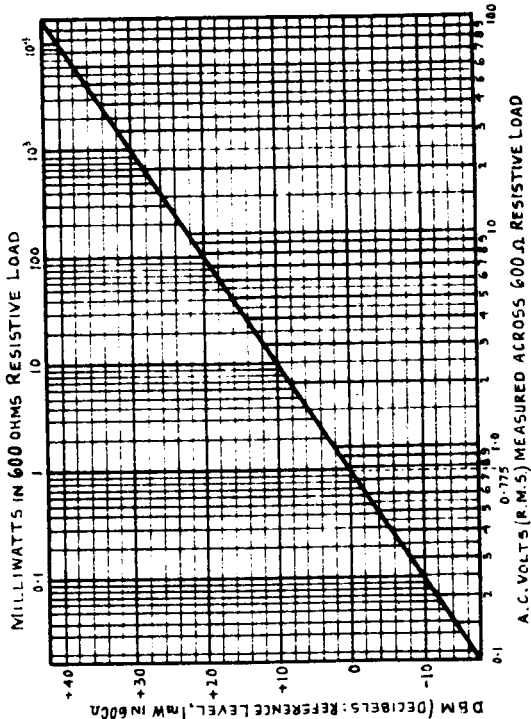

RESISTIVE LOAD	CORRECTION FACTOR
600	0
500	+0.8
300	+3.0
150	+6.0
50	+10.8
15	+16.0
6	+18.8
3.2	+22.7

CORRECTION FACTOR TO BE ADDED ALGEBRAICALLY TO THE dbm VALUE ON GRAPH.

$$\text{CORRECTION FACTOR} = 10 \log \frac{600}{R}$$

Fig. 3. Conversion Graph R.M.S. voltages to dbm. values.

FOR Ω SET INSERT RESISTOR POS. 7 TO 04M/15K
 RPT.

3.5K TO 8.2K

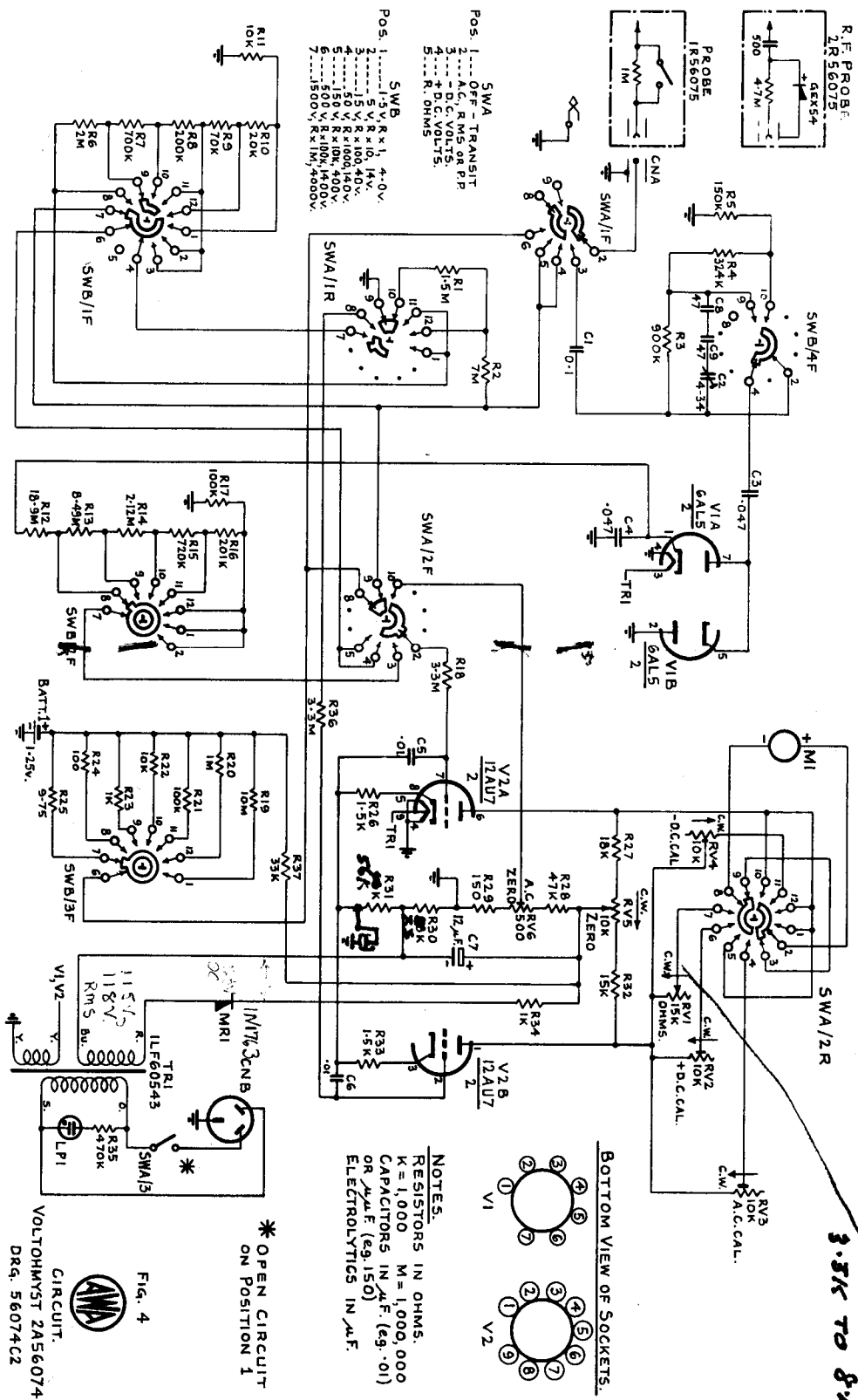

FIG. 4
 CIRCUIT.
 VOLTOHMYST 2A56074
 DRG. 56074C2

P.V.-1537-0

Fig. 4. Circuit Diagram of Volt Ohmyst 2A56074

D.C. VOLTAGE MEASUREMENT

DO NOT EXCEED THE SPECIFIED MAXIMUM INPUT VOLTAGE.

There are seven voltage ranges calibrated on two scales 0-1.5V and 0-5V. The other five ranges (0 to 15V, 50V, 150V, 500V and 1500V) must have their scale readings multiplied appropriately. To measure D.C. voltage, proceed as follows.

- (a) Attach the A.C.-D.C. Probe 1R56075 to the plug and cable already inserted in the instrument.
- (b) Set the switch on the probe to D.C.
- (c) Set FUNCTION switch to "+ D.C. VOLTS" or "- D.C. VOLTS" as required.
- (d) Connect the clip on the earth cable to earth on the unit under test.
- (e) Set the RANGE switch to a position higher than the anticipated value of the voltage to be measured.
- (f) After a check reading, set the RANGE switch to the lowest range which allows the pointer to remain on the scale.
- (g) Read the voltage from the appropriate scale.

CENTRE ZERO MEASUREMENT

NOTE.—The maximum input must never exceed **half** that indicated on the range scale.

There are seven ranges each equal to $+$ or $-$ half the voltage indicated on the RANGE switch scale, e.g., 50V scale: centre zero reading $+$ or $-$ 25V.

- (a) Attach the A.C.-D.C. Probe 1R56075 to the plug and cable already inserted in the instrument.
- (b) Set the switch on the probe to D.C.
- (c) Set the FUNCTION switch to " $+$ D.C. VOLTS."
- (d) Rotate the ZERO control to position the pointer to the centre-zero located near the bottom of the scale.
- (e) Set the RANGE switch to a position at least twice the voltage anticipated.
- (f) After a check reading, set the RANGE switch to the lowest position which allows the pointer to remain on the scale.
- (g) Read the voltage from the appropriate scale.

TECHNICAL DESCRIPTION

The basic operation of the Voltohmyst centres around the vacuum-tube D.C. bridge circuit (12AU7). When the bridge is balanced (adjustable by RV5) the voltages at the two anodes will be equal, and the meter connected between the anodes will register zero.

When a positive D.C. voltage is applied to the grid of the triode section V2A, the anode current is increased and a decrease in anode voltage results. This current flows through the common cathode resistor R30, R31, increasing the voltage drop across it and thus applying negative grid bias to V2B. The anode voltage of V2B then increases and the potential difference between the anodes causes current to flow from V2B to V2A via the meter.

When the instrument is used for A.C. measurement, the input is first rectified by the twin diode V1 (6AL5) which is connected as a peak-to-peak full-wave rectifier. (In the case of the two highest ranges the voltage is attenuated before application to the rectifier.) The associated components are designed to give the circuit a long time constant. When the applied A.C. input swings negative, C3 is charged through V1B to the negative peak value of the applied input. As the input begins to swing positive, V1B becomes non-conductive and C3 cannot discharge. As the input swings positive, the positive peak added in series with the charge in C3 is applied to the anode of V1A. C4 is charged to the additive result of the two peaks. The long time constant maintains the potential across C4 at the full peak-to-peak value. A portion of this voltage is then fed via the RANGE switch to the grid of V2A and the circuit action described in the previous paragraph occurs.

When the A.C. input rectifier is connected, the contact potential within the valve causes a small voltage to appear at the grid of V2A, resulting in a slight unbalance of the bridge circuit. This is counteracted by a small voltage fed back to the grid of V2B from the A.C. ZERO control RV6, restoring the bridge circuit balance.

The pulse response capability of the instrument is dependent on the pulse width and the pulse repetition frequency. If the pulse width is narrow, C3 may not charge to the full value of the peak voltage; also if the pulse repetition frequency is small, despite the long time constant, portion of the charge may be dissipated as leakage in the circuit. These errors, which may occur, are shown on the Pulse Response curve, Fig. 5.

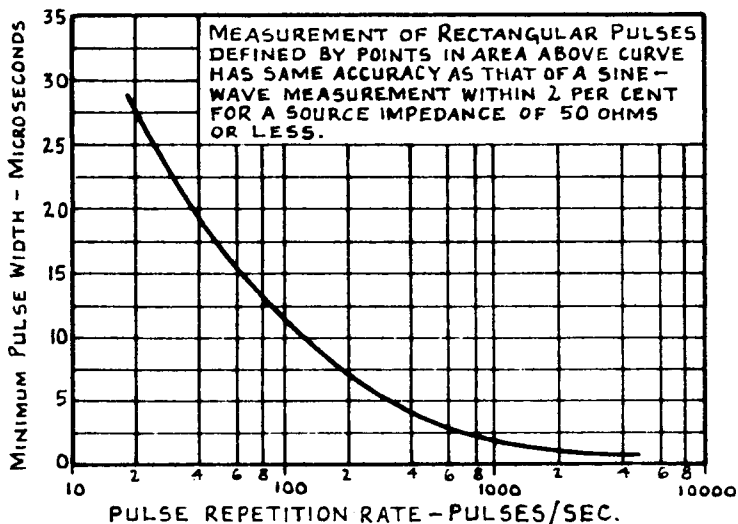

Fig. 5. Pulse Response Capability.

The meter is a 200uA F.S.D. movement employing a core magnet. The core magnet movement allows for a higher torque ratio, better overload protection and lower weight than conventional meters and is self-shielding.

It is impossible for any voltage applied to the test probes to reach the meter directly. The meter is always isolated from the voltage source by the 12AU7 valve; the current limitations of the valve and its associated components greatly reduce the possibility of overloading the meter.

The battery used for ohms measurement is a Nickel-Cadmium rechargeable cell. As long as the instrument is in use, the cell is trickle-charged at about 2mA from MR1 via R34 and R37.

MAINTENANCE

The Voltohmyst should require adjustment only in the case of component failure or mis-use. Front panel controls offer sufficient adjustment for changes in operating conditions, mains variations, etc.

Replacement components **MUST** be as specified in the component schedule and the strict tolerances observed. Only experienced technicians should carry out adjustments.

Removal of Knobs

The knobs are secured by 4BA Allen Head grub screws which can be loosened with a 1/16 in. hexagonal Allen wrench.

Mechanical Zero Adjustment

The meter pointer should rest on the left-hand zero mark when the **FUNCTION** switch is turned to the "OFF" position. Should the pointer not rest at zero its position may be adjusted mechanically by means of the screwdriver adjustment on the meter pointer assembly.

Electrical Balance Check

1. Set the "FUNCTION" switch to "+ D.C. VOLTS" and allow 15 minutes for the instrument to warm up.
2. Rotate the "ZERO" control. It should be possible to set the pointer to zero or 60% of F.S.D. on any range.

3. Set the "FUNCTION" switch to "— D.C. VOLTS."
4. Rotate the "ZERO" control. It should be possible to set the pointer at zero or 10% of F.S.D. on any range.
5. If the instrument will not comply with steps 2 and 4, there is an unbalance between the triode sections of the 12AU7 valve and it should be replaced.

Valve Replacement

All valves supplied with the A.W.A. 2A56074 Voltohmyst have been aged prior to their installation in the instrument. All valve replacements should be with aged valves.

If aged valves are not available, new valves should be aged in the instrument for 36 hours, after which time the instrument may be re-calibrated.

Calibration

The calibration of the instrument must be checked after any component replacement or internal adjustment.

NOTE.—The accuracy of calibration is dependent on, and cannot exceed, the accuracy of the standards employed.

D.C. Voltage Calibration

1. Check the mechanical zero position of the pointer; if necessary, make adjustments as previously described.
2. Switch to "+ D.C. VOLTS" and allow thirty minutes for the instrument to warm up.

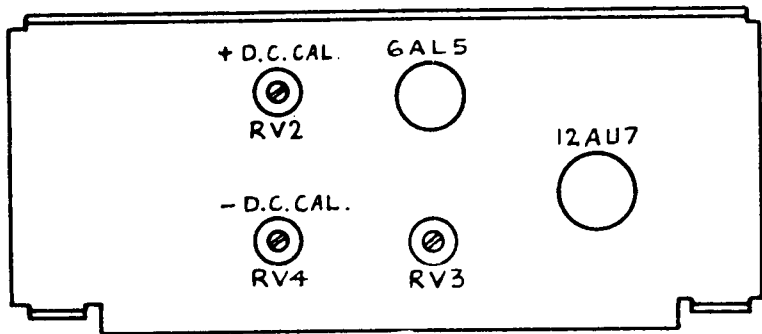

Fig. 6. Location of Calibrating Controls.

3. Check the mains voltage. The 2A56074 should be calibrated at 240V, 50c/s.
4. Rotate the ZERO control to set the pointer exactly at zero. This control should not be readjusted during the rest of the calibrating procedure.
5. Set the RANGE switch to "50V."
6. Set the sliding switch on the A.C.-D.C. probe to "D.C."
7. Connect the earth clip to the negative and the probe tip to the positive terminals of a D.C. source supplying exactly 50V.
8. With a screwdriver adjust the "+ D.C. CAL." control RV2 to bring the pointer exactly to the 50V mark on the scale.

9. Disconnect the test leads and reverse them. Set the **FUNCTION** switch to "— D.C. VOLTS."
10. Connect the test leads so that the probe is to the negative terminal.
11. With a screwdriver adjust the "— D.C. CAL." control RV4 to set the pointer exactly to 50V on the scale.
12. Check the remaining D.C. voltage ranges against D.C. sources of known accuracy which provide F.S.D.

A.C. Voltage Calibration

1. Set the sliding switch on the A.C.-D.C. probe to "A.C. — OHMS."
2. Set the **FUNCTION** switch to "A.C."
3. Set the **RANGE** switch to "1.5 VOLTS."
4. Short the probe tip to the earth clip and adjust the A.C. **ZERO** control RV6 to position the pointer exactly at zero. If the meter will not zero, replace the 6AL5 valve.
5. Set the **RANGE** switch to 50V.
6. Apply 50V A.C. at 50c/s between the probe tip and earth clip. The meter reading should be within 3%. If the reading is beyond tolerance, adjust the "A.C. CAL." control RV3 to correct the reading.

A.C. Compensation Adjustment

1. Set the sliding switch on the A.C.-D.C. probe to "A.C. — OHMS."
2. Set the **FUNCTION** switch to "A.C."
3. Set the **RANGE** switch to 500V.

4. Set meter pointer to ZERO.
5. Set the RANGE switch to 150V and apply a 100kc/s signal adjusted to read exactly 150V. Set the RANGE switch to 500V and adjust trimmer C2 so that the meter reads 150V. C2 is located on the rear section of the RANGE switch.

Ohms Adjustment

1. Set the FUNCTION switch to "+ D.C. VOLTS" and check zero.
2. Set FUNCTION switch to "OHMS."
3. Set RANGE switch to Rx1.
4. Adjust OHMS control for F.S.D.
5. Set RANGE switch to Rx1 M Ω . The pointer should read above 1000 on the R scale. If the pointer indicates a lower value, there is excessive leakage in the ohmmeter circuit.

Maintenance of Probes:

The probes are jig-assembled and, if practicable, should be returned to the factory for servicing.

A.C.-D.C. Probe: The resistor may be replaced after unscrewing the switch button, removing the circlip and sliding the plastic outer case and sealing washer from the metal body. Re-assemble in reverse order ensuring maximum clearance between resistor leads and the metal body.

Crystal Probe: The resistor and/or diode may be replaced after removing the earth clip and circlip and sliding the plastic outer case and sealing washer from the metal body. To replace the capacitor, further dismantle the probe by clamping the needle tip in a vice, holding the metal body stationary and unscrewing the hexagon nut and bakelite cap. Re-assemble in reverse order ensuring maximum clearance between component pigtailed and the metal body.

COMPONENT SCHEDULE

When ordering replacement parts, please quote ALL details given below for a particular component, TOGETHER WITH the unit type No. and the Circuit Ref. No. of component.

The component supplied against the order may not be identical with the original item in the equipment, but will be a satisfactory replacement differing in only minor mechanical or electrical details; such differences will not impair the operation of the equipment.

Circuit Ref. No.	Description	A.W.A. Type No. (unless otherwise stated)
------------------	-------------	--

(a) CAPACITORS

C1	0.1uF, $\pm 20\%$, 1kV.W., paper, tub. metal case.	U.C.C. type PMP
C2	4-34uuF, variable, miniature, air dielectric.	Oxley CVA7
C3	0.047uF, $\pm 10\%$, 400V.W., polyester, tub.	Philips C296AC
C4	0.047uF, $\pm 10\%$, 400V.W., polyester, tub.	Philips C296AC
C5	0.01uF, $\pm 10\%$, 400V.W., polyester, tub.	Philips C296AC
C6	0.01uF, $\pm 10\%$, 400V.W., polyester, tub.	Philips C296AC
C7	12uF, 300V.P.W., electrolytic, tub. metal case.	Ducon ET
C8	47uuF, $\pm 5\%$, 500V.W., ceramic, disc.	Ducon CDS NPO
C9	47uuF, $\pm 5\%$, 500V.W., ceramic, disc.	Ducon CDS NPO

Description

Circuit Ref. No.

(b) RESISTORS

R1	1.5M Ω , \pm 10%, $\frac{1}{4}$ W., comp. grade 2 ins.	Welwyn C25
R2	7M Ω , \pm 1%, 2W., comp. grade 1 non-ins.	Welwyn C25
R3	900k Ω , \pm 1%, 2W., comp. grade 1 non-ins.	Welwyn C23
R4	324k Ω , \pm 1%, $\frac{3}{4}$ W., comp. grade 1 non-ins.	I.R.C. type DCC
R5	150k Ω , \pm 1%, $\frac{1}{2}$ W., comp. grade 1 non-ins.	Welwyn C22
R6	2M Ω , \pm 1%, $\frac{1}{4}$ W., comp. grade 1 non-ins.	
R7	700k Ω , \pm 1%, $\frac{1}{4}$ W., comp. grade 1 non-ins.	
R8	200k Ω , \pm 1%, $\frac{1}{4}$ W., comp. grade 1 non-ins.	
R9	70k Ω , \pm 1%, $\frac{1}{4}$ W., comp. grade 1 non-ins.	
R10	20k Ω , \pm 1%, $\frac{1}{4}$ W., comp. grade 1 non-ins.	
R11	10k Ω , \pm 1%, $\frac{1}{4}$ W., comp. grade 1 non-ins.	Welwyn C25
R12	18.9M Ω , \pm 1%, 2W., comp. grade 1 non-ins.	Ducon High Stability
R13	8.49M Ω , \pm 1%, 1W., comp. grade 1 non-ins.	Welwyn C22
R14	2.12M Ω , \pm 1%, $\frac{1}{2}$ W., comp. grade 1 non-ins.	
R15	720k Ω , \pm 1%, $\frac{1}{4}$ W., comp. grade 1 non-ins.	
R16	201k Ω , \pm 1%, $\frac{1}{4}$ W., comp. grade 1 non-ins.	
R17	100k Ω , \pm 1%, $\frac{1}{4}$ W., comp. grade 1 non-ins.	
R18	3.3M Ω , \pm 10%, $\frac{1}{4}$ W., comp. grade 2 ins.	
R19	10M Ω , \pm 5%, $\frac{1}{2}$ W., comp. grade 1 non-ins.	Welwyn C22
R20	1M Ω , \pm 5%, $\frac{1}{4}$ W., comp. grade 1 non-ins.	
R21	100k Ω , \pm 5%, $\frac{1}{4}$ W., comp. grade 1 non-ins.	

Circuit
Ref. No.

Description

- R22 10k Ω , \pm 5%, $\frac{1}{4}$ W., comp. grade 1 non-ins.
R23 1k Ω , \pm 5%, $\frac{1}{4}$ W., comp. grade 1 non-ins.
R24 100 Ω , \pm 5%, $\frac{1}{4}$ W., comp. grade 1 non-ins.
R25 9.75 Ω , \pm 1%, W-W, precision.
R26 1.5k Ω , \pm 5%, $\frac{1}{4}$ W., comp. grade 2 ins.
R27 18k Ω , \pm 5%, $\frac{1}{4}$ W., comp. grade 2 ins.
R28 47k Ω , \pm 5%, $\frac{1}{4}$ W., comp. grade 2 ins.
R29 150 Ω , \pm 10%, $\frac{1}{4}$ W., comp. grade 2 ins.
R30 33k Ω , \pm 5%, $\frac{1}{4}$ W., comp. grade 2 ins.
R31 56k Ω , \pm 5%, $\frac{1}{4}$ W., comp.
R32 15k Ω , \pm 5%, $\frac{1}{4}$ W., comp. grade 2 ins.
R33 1.5k Ω , \pm 5%, $\frac{1}{4}$ W., comp. grade 2 ins.
R34 1k Ω , \pm 5%, $\frac{1}{4}$ W., comp. grade 2 ins.
R35 470k Ω , \pm 10%, $\frac{1}{4}$ W., comp. grade 2 ins.
R36 3.3M Ω , \pm 10%, $\frac{1}{4}$ W., comp. grade 2 ins.
R37 33k Ω , \pm 5%, $\frac{1}{4}$ W., comp. grade 2 ins.

(c) RESISTORS, VARIABLE

- RV1 15k Ω , $\frac{1}{4}$ W., comp., linear law, curve A,
knurled spindle $\frac{1}{4}$ in. long.
RV2 10k Ω , $\frac{1}{4}$ W., comp., linear law, curve A,
spindle $\frac{3}{8}$ in. long, s/driver slot, tab. mtg.
RV3 10k Ω , $\frac{1}{4}$ W., comp., linear law curve A,
spindle $\frac{3}{8}$ in. long, s/driver slot, tab. mtg.

A.W.A. Type No.
(unless otherwise stated)

I.R.C. type WLA

Philips B8.305.05B

Ducon PSU

Ducon PTU

Ducon PTU

Description

Circuit Ref. No.

(c) RESISTORS, VARIABLE

- RV4 10k Ω , $\frac{1}{2}$ W., comp., linear law, curve A, spindle $\frac{3}{8}$ in. long, s/driver slot, tab. mtg.
 RV5 10k Ω , $\frac{1}{4}$ W., comp., linear law, curve A, knurled spindle $\frac{1}{2}$ in. long.
 RV6 500 Ω , $\frac{1}{2}$ W., comp., linear law, curve A, spindle $\frac{1}{4}$ in. long, s/driver slot, tab. mtg.

Ducon PTU

Ducon PSU

Ducon PTU

(d) MISCELLANEOUS

- CNA Coaxial, single point connector.
 CNB 3-pin plug on standard cable assembly.
 LPI Lamp, neon indicator.
 MR1 Rectifier, half-wave.
 M1 Meter, moving coil, special scale.
 V1 Valve holder, 7-pin, miniature.

ACME PCIM

Pt. 49743

NE2

1N1763

56074Y18

Carr Fastener

CF733-2-21

Carr Fastener

CF733-2-28

56074W88

56074X89

1LF60543

Eveready No. D50

Eveready No. D46

- V2 Valve holder, 9-pin, miniature.

SWA Switch.

SWB Switch.

TR1 Transformer.

BAT1 Nickel-Cadmium Cell, 1.25V.