

911062

VO Matic Model 360

AUTOMATIC
VOLT-OHM-MILLIAMMETER



INSTRUCTION MANUAL

WARRANTY

This B&K product is made of the finest material and then carefully tested at the factory before shipment. It carries the standard RETMA warranty against defects in material and workmanship for a period of 90 days from date of purchase. Should any defect be discovered within this warranty period, return the unit to the distributor from whom it was purchased.

BE SURE TO MAIL YOUR WARRANTY REGISTRATION CARD IMMEDIATELY TO REGISTER YOUR UNIT WITH THE FACTORY.



B & K MANUFACTURING COMPANY
DIVISION OF DYNASCAN CORPORATION
1801 W. BELLE PLAINE AVE. • CHICAGO, 13



B & K MANUFACTURING COMPANY



Figure 1

OPERATING INSTRUCTIONS

FOR

Model 360

V O Matic

AUTOMATIC

VOLT-OHM-MILLIAMMETER

B & K MANUFACTURING COMPANY
 DIVISION OF DYNASCAN CORPORATION
 1801 West Belle Plaine Avenue
 Chicago 13, Illinois

MODEL 360 V-O-MATIC

SPECIFICATIONS:

D.C. Volts 250 millivolts full scale
3 volts full scale
15 volts full scale
60 volts full scale
300 volts full scale
1000 volts full scale
6000 volts full scale

A.C. Volts 3 volts full scale
15 volts full scale
60 volts full scale
300 volts full scale
1000 volts full scale
6000 volts full scale

D.C. Sensitivity 20,000 ohms per volts

A.C. Sensitivity 5,000 ohms per volts

A.C. Frequency Response: 5 cycles to 0.5 mc.

A.C. Output Meter Ranges

0-3 volts
0-15 volts
0-60 volts
0-300 volts

D.C. Blocking Capacitor on output range is .1 mfd, 600 volts

Direct Current:

0-100 microamperes
0-5 milliamperes
0-100 milliamperes
0-500 milliamperes
0-10 amperes

Resistance Ranges:

1,000 ohms full scale. 10 ohms center scale
10,000 ohms full scale. 50 ohms center scale
1M ohms full scale. 4K ohms center scale
100M ohms full scale. 150K ohms center scale

Accuracy: Plus or minus (\pm) 3% of full scale on D.C. Ranges.
Plus or minus (\pm) 5% of full scale on A.C. Ranges.
Resistance Accurate to ± 2 degrees of arc.

Capacity: Direct reading with the overlay scales in three ranges

.1 mfd to 4.1 mfd
.0025 mfd to .12 mfd
100 mmfd to 4500 mmfd

Db Ranges: From -20 Db to + 62 Db
0 Db is equal to 1 milliwatt into a 600 ohm line
Db scales are direct reading with the overlay scale supplied

Power: Direct reading with the overlay scales for A.C. sine wave power across 4, 8 and 16 ohm loads.

Across 4 ohm load 0-56 watts
8 ohm load 0-28 watts
16 ohm load 0-56 watts

Peak to Peak (P-P) Voltages: Direct reading with the overlay scales.

0-170 P-P
0-850 P-P

Battery: 1 each #2 Flashlight Cell 1.5 volt

1 each 2U6 or equivalent 9 volts

Size: 8½" x 6" x 3⅞"

Weight: 4 lbs.

GENERAL DESCRIPTION

Your V-O-Matic represents the most advanced development since the introduction of the Volt Ohm Milliammeter. The most important improvement is the single scale feature. The range switch is coupled to the meter dial in such a way that only one direct reading scale is present. That is the range selected by the range selector switch. This completely eliminates any error due to the reading of the wrong scale. Included with the V-O-Matic 360 meter is an anti parallax mirror to provide the utmost in accuracy. Precision resistors are used for all multipliers and shunts to provide long term stability and accuracy.

Meter protection is built into the instrument. This will protect the meter movement against overloads up to 100 times.

Standard ¾ inch spacing of the test lead jacks enable the user to employ the General Radio type connector if desired.

A polarity reversing switch is provided on the front panel to enable readings to be taken with either positive or negative polarity without disconnecting the test leads from the circuit under test.

A shorting switch is employed in conjunction with the ohms adjust control. The test leads do not have to be removed from the component under test to zero the ohmmeter.

MODEL 360 V-O-MATIC

OPERATING INSTRUCTIONS

NOTE: WHENEVER MAKING VOLTAGE AND CURRENT MEASUREMENTS ALWAYS TURN OFF THE POWER OF THE CIRCUIT UNDER TEST WHEN CONNECTING AND DISCONNECTING THE TEST LEADS ON YOUR V-O-M. WHEN IN DOUBT AS TO THE APPROXIMATE VALUE OF THE VOLTAGE OR CURRENT TO BE MEASURED, ALWAYS PUT YOUR METER ON THE HIGHEST RANGE.

Make sure the Range Selector switch is detented properly when changing scales. Otherwise the scale may not be centered properly in the window opening.

Before making any measurements, check to see that the pointer reads zero before connecting the Model 360 V-O-Matic to the circuit. The zero adjust screw is located at the bottom of the panel directly above the word Chicago, see Fig. 1. Adjustment of this screw will enable the operator to position the pointer directly at zero.

To read the meter to the greatest accuracy, the anti parallax mirror should be used. Parallax comes about when the eye of the observer is not directly over

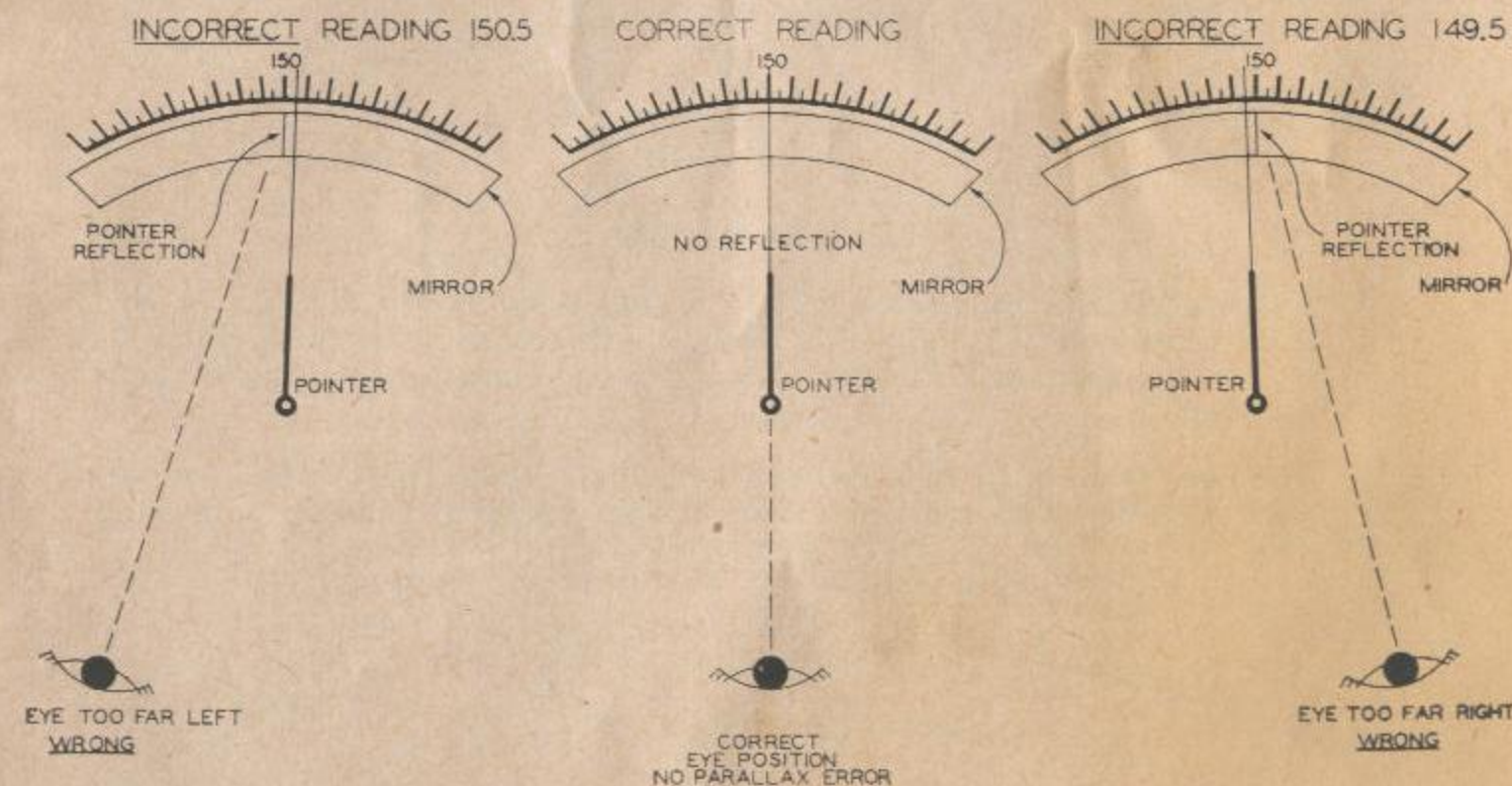

Figure 2—Using the Anti Parallax Mirror

the meter pointer. This causes the needle to be displaced to the right or to the left, depending upon which side of the needle the observer's head is placed. When using the anti parallax mirror, position the eye until the meter pointer and the reflection of the pointer in the mirror coincide. Use only one eye. The meter can now be read to the greatest accuracy, see Fig. 2.

D.C. Voltage Measurement

1. Set the Range Selector switch to the desired range. If in doubt as to the amount of voltage to be measured, always start at the highest range.
2. Put Polarity Reversal switch to the (+) position. When in this position, the (—) and (+) input jacks indicate proper polarity. Connect the V-O-Matic 360 to the circuit under test and read voltage. If the meter reads backwards, rotate the Polarity Reversal switch to the (—) position.
3. If the reading of the meter indicates that the voltage is less than the full scale value of the next lower range, rotate the Range Selector switch to the lower range for more accurate readings.
4. If the voltage to be read is more than 1,000 volts, and less than 6,000 volts, connect red test lead to the 6,000 volts D.C. jack and connect the black test lead to the (—) jack. Rotate the Range Selector switch to the 60 volts D.C. position. 60 volts now corresponds to 6,000 volts, and 50 volts corresponds to 5,000 volts, etc. If the meter reads backwards, turn off the power to the circuit under test and turn the Polarity Reversal switch. When making measurements on the 6,000 volts range, always turn off the power to the circuit under test before connecting and disconnecting the V-O-Matic 360. When power is applied, DO NOT touch the test leads or the V-O-Matic when making measurements on the 6,000 volts range.

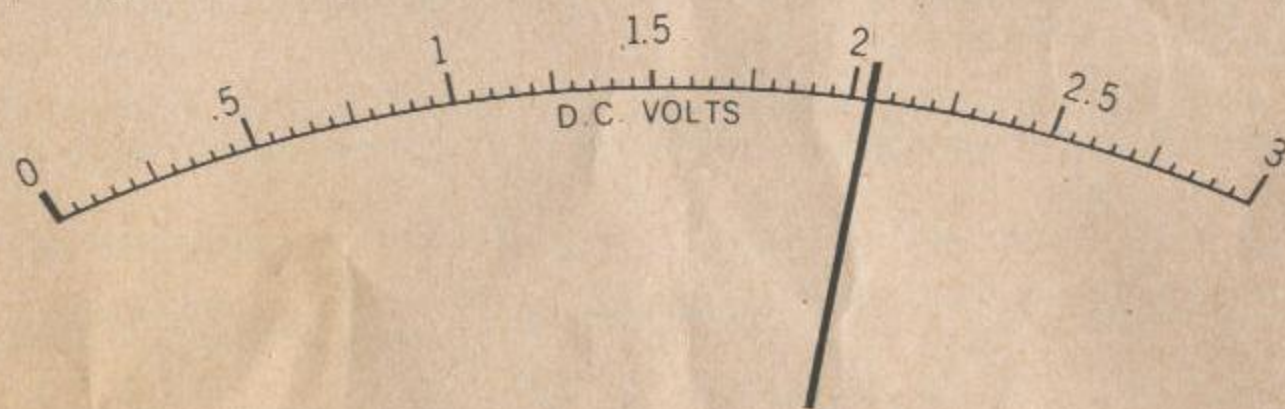

Figure 3—3V D.C. Scale

5. The lowest D.C. range is 3 volts D.C. full scale. Each division on this scale represents .05 volts. Fig. 3 shows this scale with the pointer at rest on the first small division above 2 volts. Therefore, the meter reads 2.05 volts.

The next scale is 15 volts full scale reading. Each small division represents .2 volts. This scale is shown in Fig. 4 with the needle pointer at

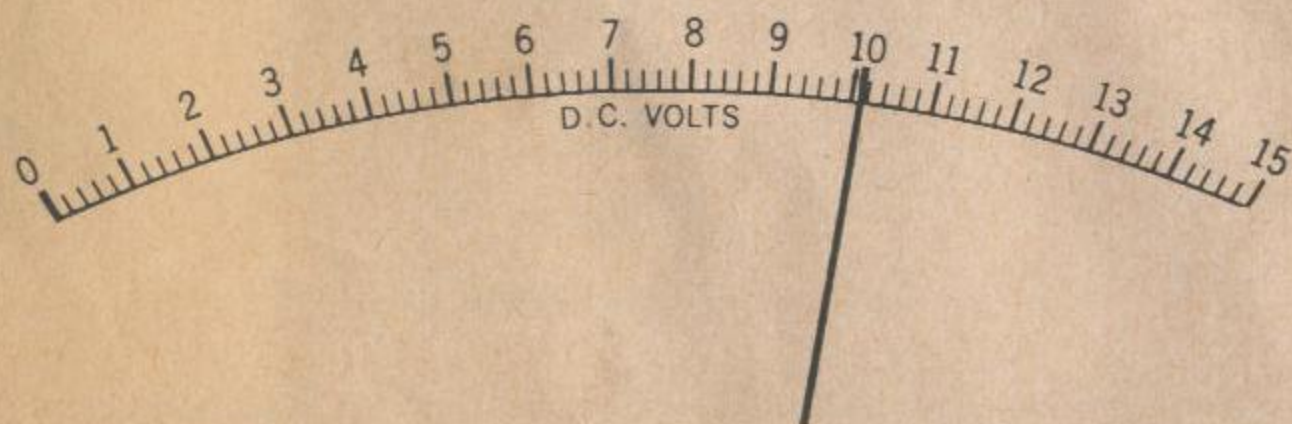

Figure 4—15V D.C. Scale

rest half way between the 10 volts point and the 10.2 volts point. Therefore, the meter is reading 10.1 volts.

The next scale is a 60 volts full scale reading. Each small division represents 1 volt. The meter pointer is at rest at the first small division above the 20 volts point. Therefore, the meter is reading 21 volts. If the test leads were connected to the 6,000 volts jack, then the reading would be 2,100 volts, see Fig. 5.

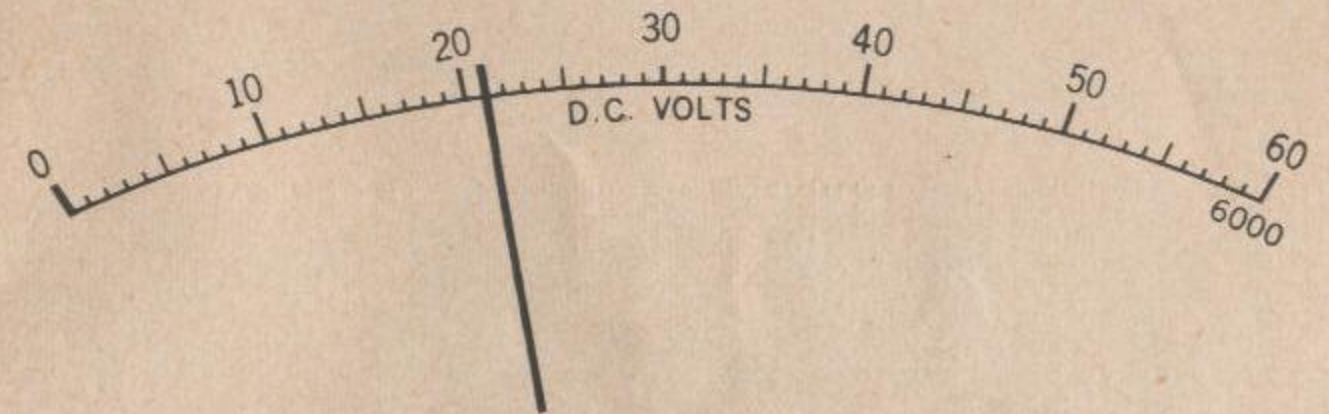

Figure 5—60V D.C. Scale

The next scale is a 300 volts full scale reading and each small division represents 5 volts, see Fig. 6. If the meter pointer came to rest at the first small division below the 50 volts point, the meter would be reading 45 volts. For greatest accuracy you should then switch the range selector switch to the next lowest scale since 45 volts is less than the full scale reading of the 60 volts range. Voltage readings have the greatest accuracy when the reading is made in the upper half of the meter scale.

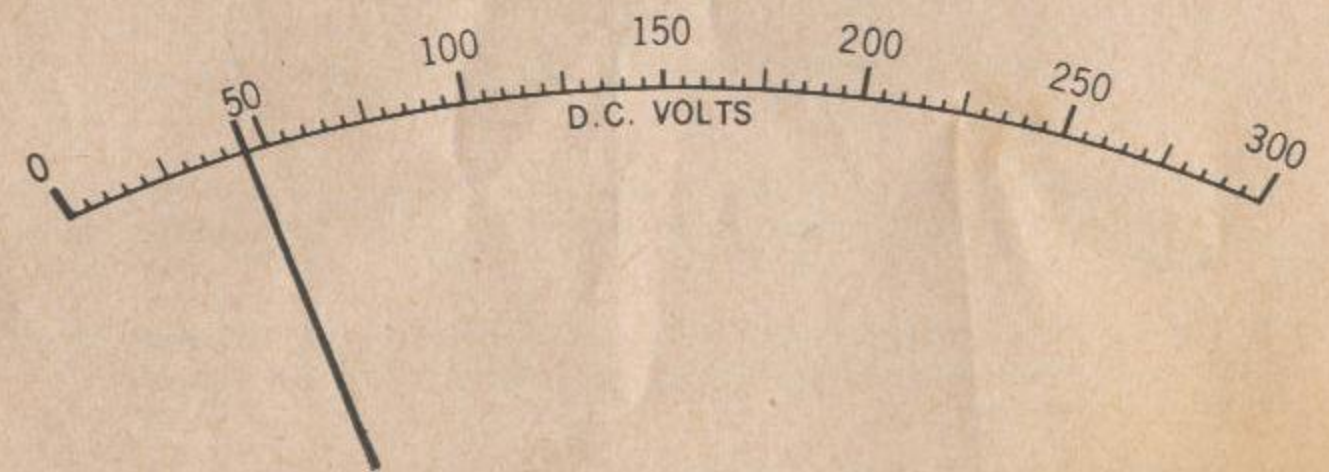

Figure 6—300V D.C. Scale

The next scale is a 1,000 volts full scale reading where our smallest division represents 10 volts. If the meter pointer came to rest on 900 volts point, the meter must be reading 900 volts, See Fig. 7.

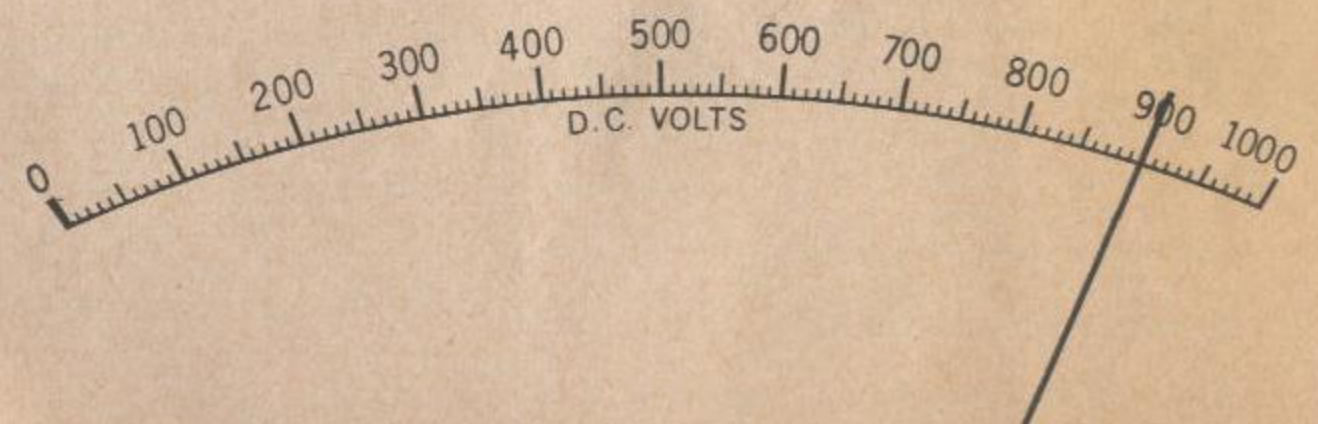

Figure 7—1000V D.C. Scale

A.C. Voltage Measurement

The V-O-Matic 360 measures A.C. voltage in terms of R.M.S. value of a sine wave. (See section on Supplemental Ranges for Peak to Peak readings.) This is accomplished by rectifying the A.C. voltage applied, and applying this rectified voltage to the meter. The meter is calibrated in R.M.S. values. The frequency response of the A.C. circuit is extremely wide, from 10 cycles to approximately 500,000 cycles. Fig. 8 shows the frequency response of each of the ranges of the V-O-Matic 360.

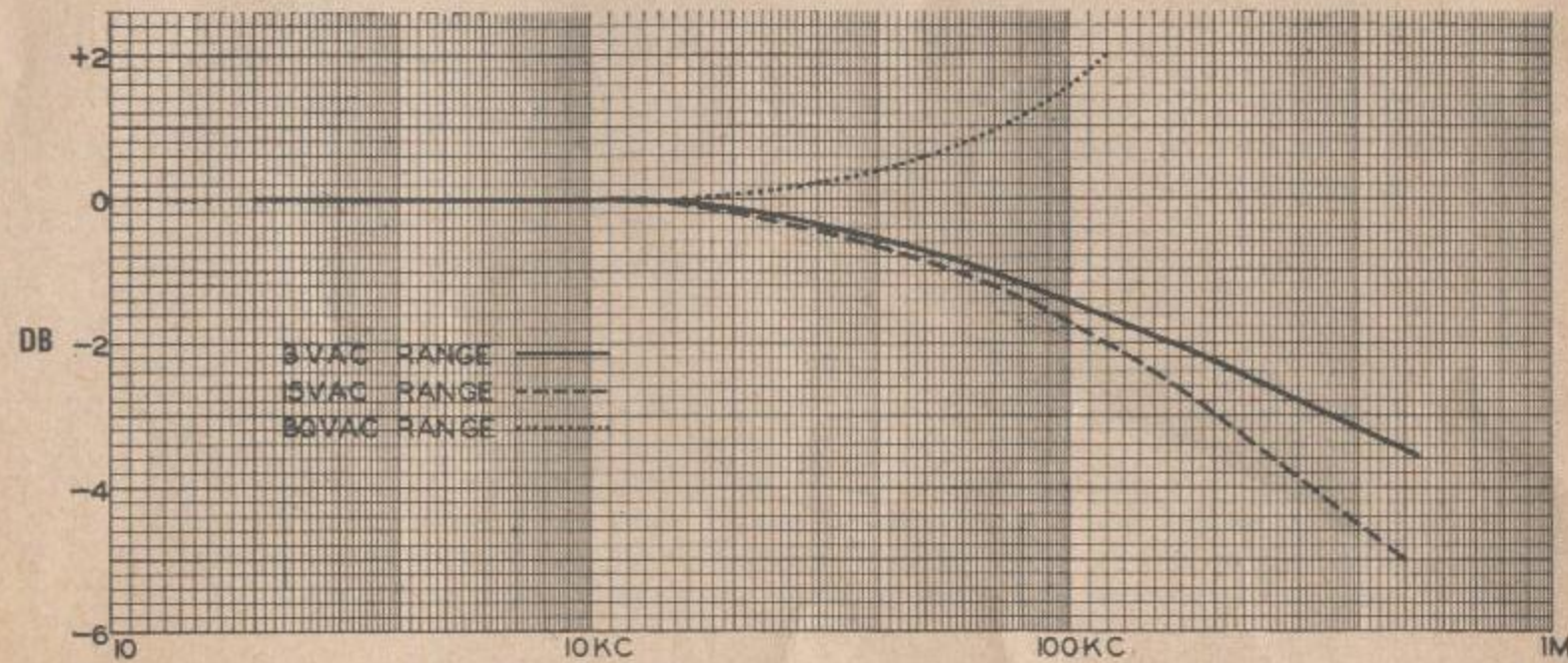

Figure 8—Frequency Response of A.C. Voltage Ranges

1. Set Range Selector switch to the desired A.C. voltage range. If in doubt as to the amount of voltage to be measured, always start at the highest range.
2. The Polarity Reversal switch will have no effect on the A.C. reading and the A.C. voltage can be read with the Polarity switch in either the (—) or (+) position.
3. Insert test leads into the (—) and (+) jacks of the V-O-Matic 360 and connect test leads to the circuit under test.
4. If the reading of the meter indicates that the voltage is less than full scale value of the next lowest range, rotate Range Selector switch to this range for most accurate readings.
5. If the voltage to be read is more than 1,000 volts, and less than 6,000 volts, connect red test lead to the 6,000 volts A.C. jack and connect black test lead to the (—) jack. Rotate Range Selector switch to the 60 volts A.C. range. The 60 volts now corresponds to 6,000 volts, the 50 volts now corresponds to 5,000 volts, etc. When making measurements on the 6,000 volts range, always turn off the power to the circuit under test before connecting and disconnecting the V-O-Matic 360. When power is applied DO NOT touch the test leads, or the V-O-Matic 360 when making measurements on the 6,000 volts range.
6. To read the meter to the greatest accuracy, the anti parallax mirror should be used. Refer to section under D.C. VOLTAGE MEASUREMENTS for an explanation of the use of this mirror.

7. The lowest A.C. range is 3 volts A.C. full scale. Each division on this scale represents .05 volts. Fig. 9 shows this scale with the pointer at rest on the first small division above 2 volts. Therefore, the meter reads 2.05 volts.

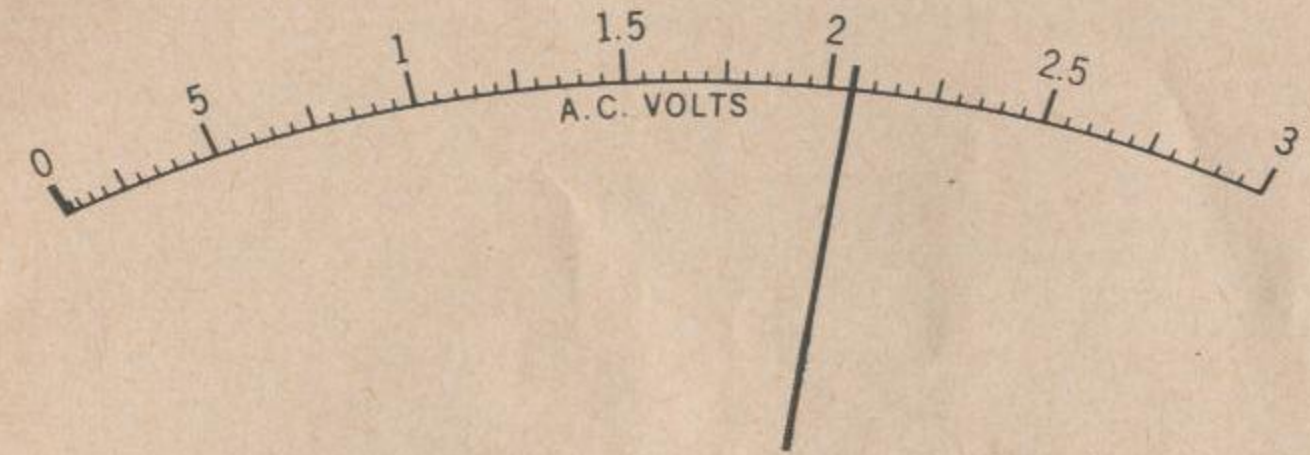

Figure 9—3V A.C. Scale

The next scale is 15 volts full scale reading. Each small division represents .2 volts. This scale is shown in Fig. 10 with the needle pointer at rest half way between the 10 volts point and the 10.2 volts point. Therefore, the meter is reading 10.1 volts.



Figure 10—15V A.C. Scale

The next scale is 60 volts full scale reading. Each small division represents 1 volt. The meter pointer is at rest at the first small division above the 20 volts point. Therefore, the meter is reading 21 volts. If the test leads were connected to the 6,000 volts jack, then the reading would be 2,100 volts, see Fig. 11.

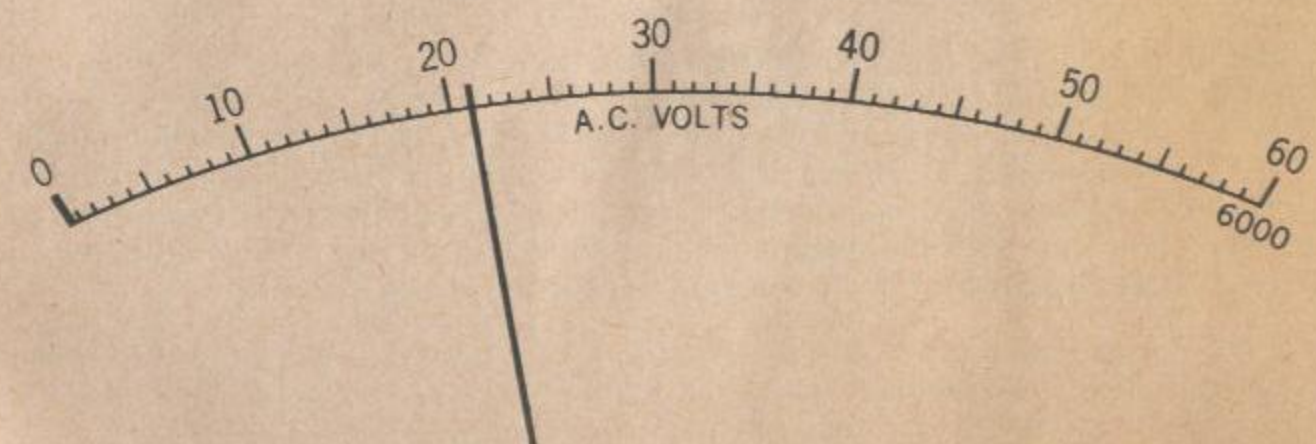

Figure 11—60V A.C. Scale

The next scale is 300 volts full scale reading and each small division represents 5 volts, see Fig. 12. If the meter pointer came to rest at the first small division below the 50 volts point, the meter would be reading 45 volts. For greatest accuracy you should then switch the Range Selector switch to the next lowest scale, since 45 volts is less than the full scale reading of the 60 volts range.

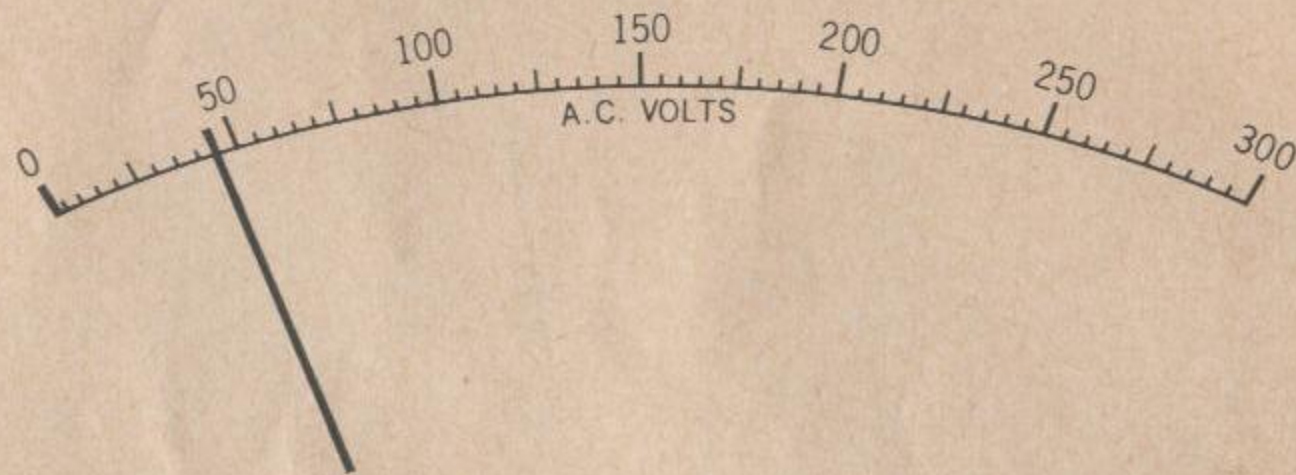

Figure 12—300V A.C. Scale

The next scale is a 1,000 volts full scale reading where our smallest division represents 10 volts. If the meter pointer came to rest 3 small divisions above the 900 volts point, the meter must be reading 930 volts, see Fig. 13.

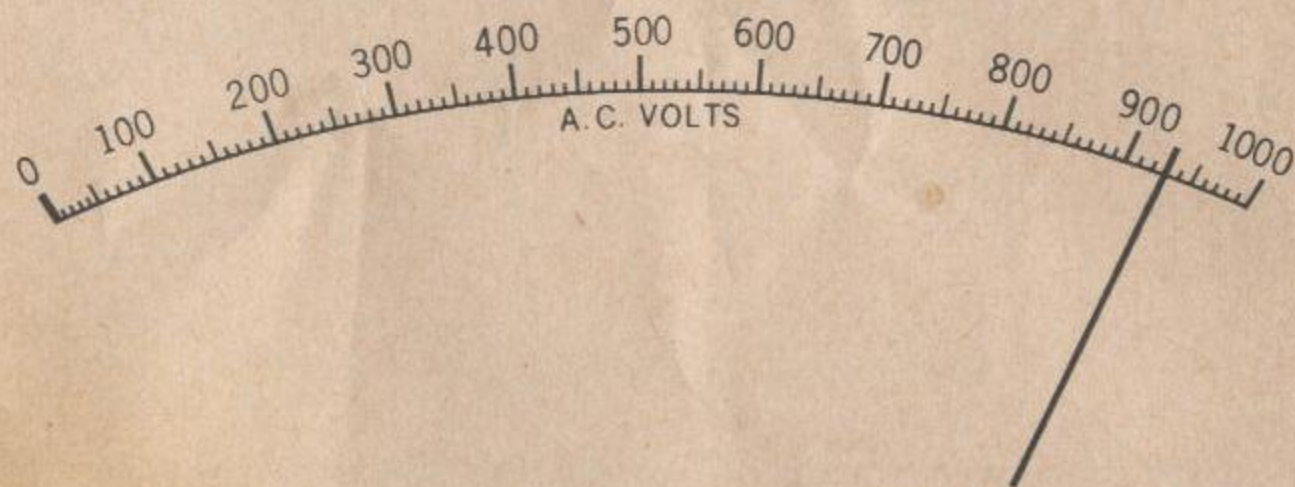

Figure 13—1000V A.C. Scale

Output Voltage Measurement

The output jack of the V-O-Matic 360 is used when the A.C. component is superimposed on a D.C. voltage and only the A.C. is to be measured. The output jack has a .1 mfd blocking capacitor in series with it. This capacitor blocks the D.C. component and allows the A.C. component to be measured by the meter. Any of the A.C. voltage ranges except the 6000 volt A.C. range may be used when working with the output jack. The test leads are connected between the (—) jack and Output jack when making this measurement.

If a General Radio type plug is to be used, this plug can be inserted between the Output jack and the 10A jack instead of between the (—) jack and the Output Jack. Identical readings will result.

Since the blocking capacitor has some reactance, the accuracy of the instru-

ment will be affected at the low frequency end. Fig. 14 shows the frequency response curve of the output meter circuit.

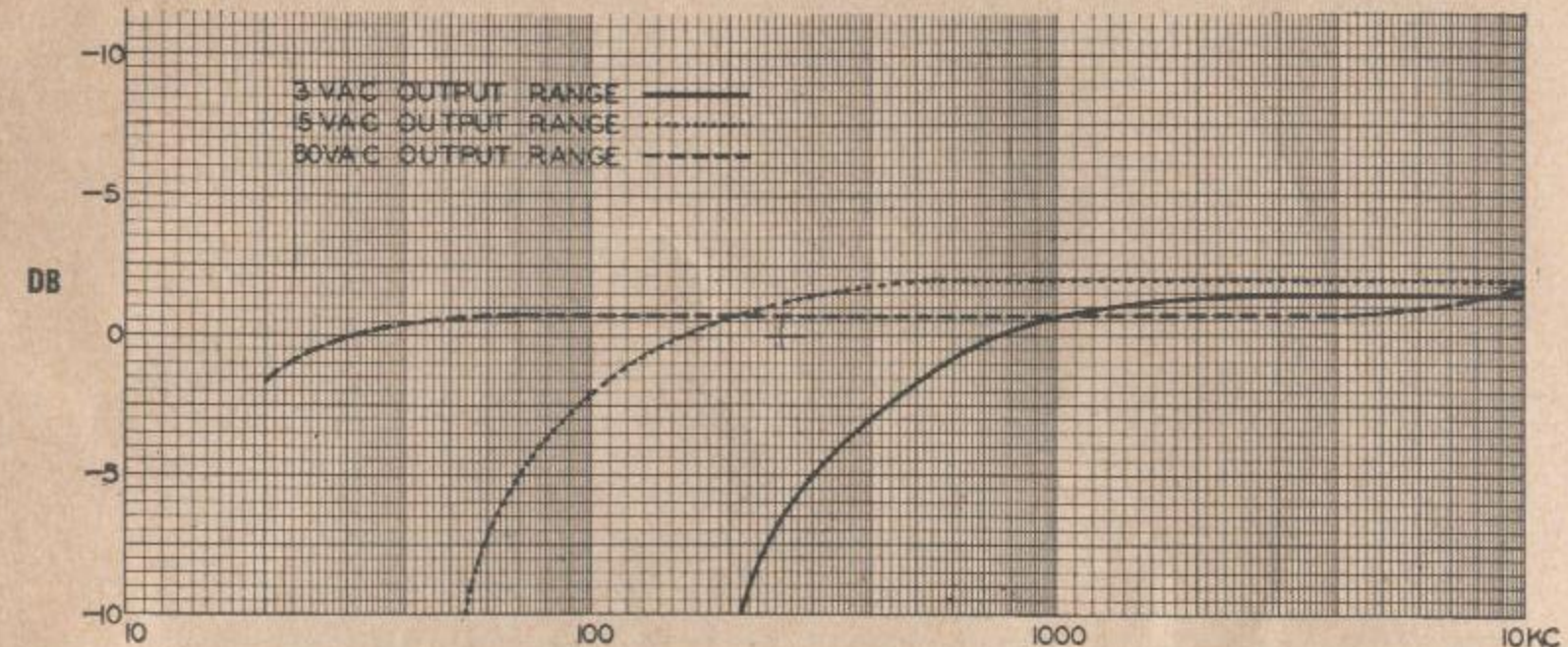

Figure 14—Frequency Response of A.C. Output Ranges

Resistance Measurements

The single scale display of the Model 360 becomes of particular importance in the measurement of resistance. No multiplying factors are required for any of the ohm ranges. The scale is direct reading in ohms. Another extremely useable feature is in the Ohm Zero Adjustment. When the Ohms Adjust (Ω ADJ.) knob is pulled out, a switch shorts together the input leads of the V-O-Matic 360 and enables the operator to zero adjust the ohmmeter without disconnecting the test leads from the resistor under measurement. The Ohms Adjust control is incorporated to enable the operator to read resistance values with the greatest possible accuracy, and to extend the useable life of the batteries, even when the battery voltage begins to decay.

1. To measure resistance, rotate the Range Selector switch to the desired position. The Range Selector switch panel markings indicate the full scale, or maximum resistance that can be read at that range. If you have an approximate resistance value, set the Range Selector switch to the range that will give you a reading that will lie between center scale and zero ohms for most accurate results. The ranges are over-lapping so that most common values of resistors can be read in this area.
2. Connect the test leads across the component to be measured. Pull Ohms Adjust (Ω ADJ.) knob out until switch clicks. Rotate Ohms Adjust knob so that the meter pointer rests on zero, which is full scale, or the right hand side of the ohms scale. Push Ohms Adjust knob down, the meter will now read the resistance of the component directly in ohms. (CAUTION: Do not pull Ohms Adjust knob out when reading voltage.)
3. The Polarity Reversal switch can be in either the (—) or (+) position, it will not affect the resistance readings.
4. If a resistor is to be measured whose approximate value is 8 ohms, proceed as follows. Connect test leads across component and pull Ohms Adjust knob up and zero the meter. Push down the Ohms Adjust knob and the meter pointer comes to rest at 5 divisions above the 5 ohms point

on the 1K ohm range. This is shown in Fig. 15. Each large division between 5 and 10 on this range represents 1 ohm, and each small division on this range represents 0.5 ohms. Therefore, the component under measurement has 7.5 ohms of resistance. If the pointer came to rest on

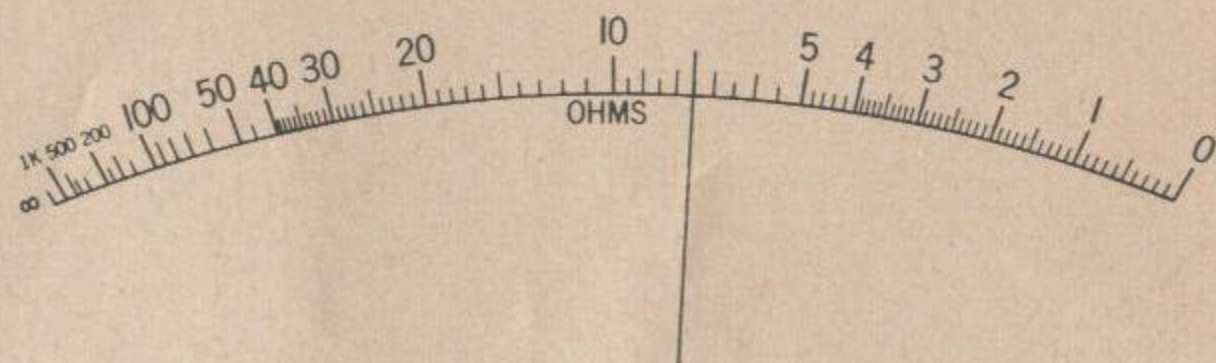

Figure 15—1K Ohms Scale

the first division above the 20 marking on the 1K ohm scale, it would have a resistance value of 21 ohms, since each division between 20 and 30 represents 1 ohm. This is shown in Fig. 16.

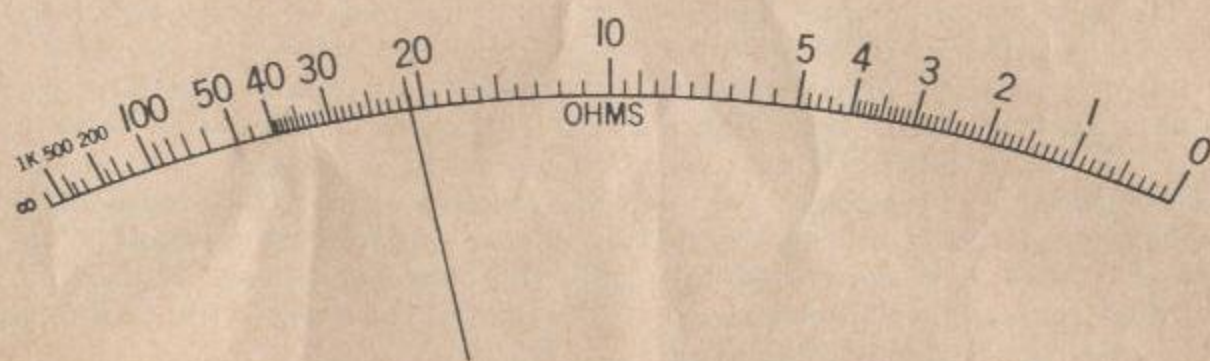

Figure 16—1K Ohms Scale

5. A resistance is to be measured and the 10K ohms scale is being used, the pointer comes to rest one division above the 20 point. This is shown in Fig. 17. Since each division between 20 and 30 represents 1 ohm, the

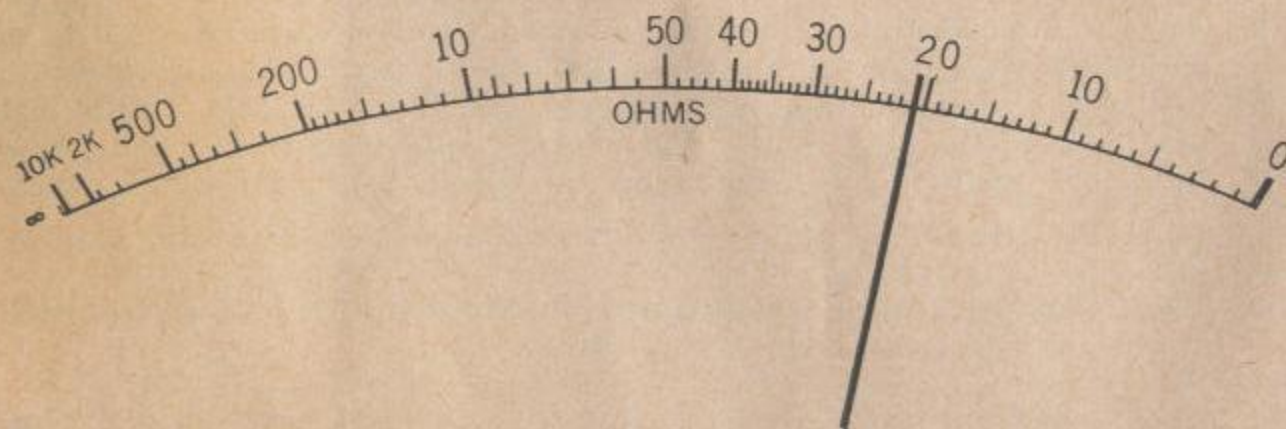

Figure 17—10K Ohms Scale

meter is reading 21 ohms. If the pointer came to rest at the second division above 500, the resistance value being read would be 1.5K ohms. This is shown in Fig. 18.

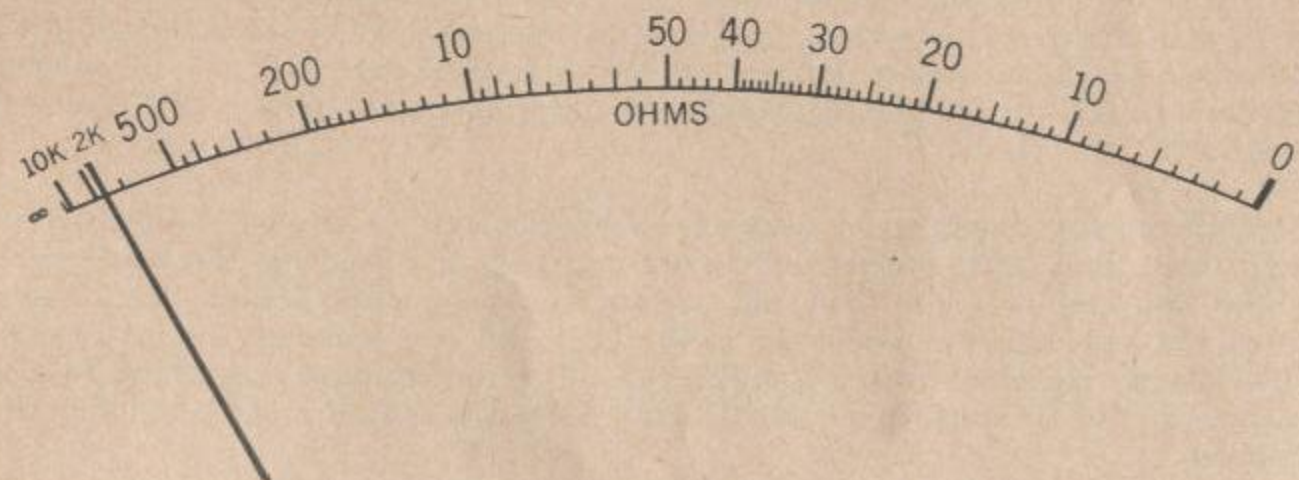

Figure 18—10K Ohms Scale

Since 1.5K appears on the 1 meg scale to the right of center scale reading, we can switch our range Selector to the 1 meg ohms range and get a more accurate reading if desired. This is shown in Fig. 19 where the pointer has come to rest $4\frac{1}{4}$ divisions above the 1K mark.

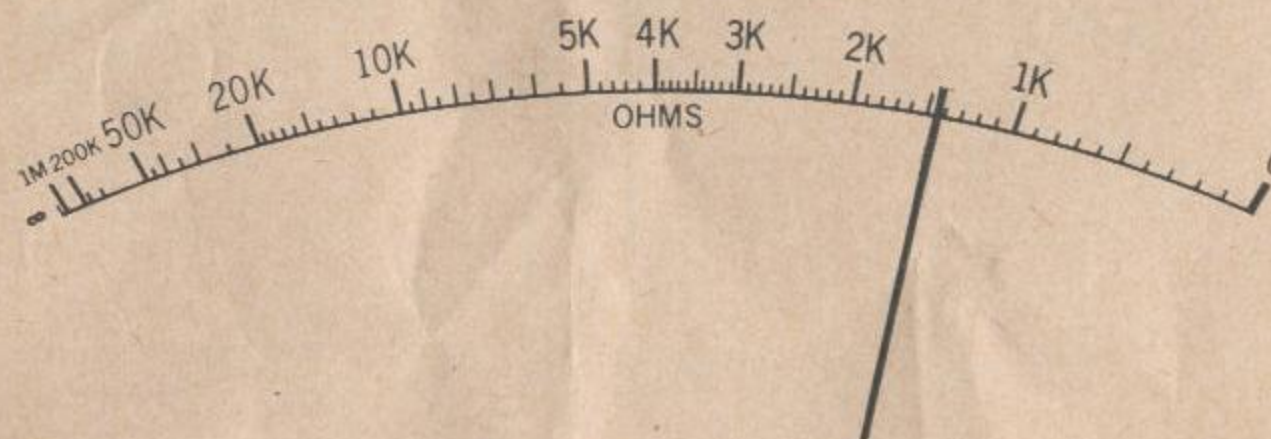

Figure 19—1 Meg Ohm Scale

This would indicate a value of 1,450 ohms. This is an example of how increased accuracy can be obtained by reading on the right hand portion of a scale whenever possible.

6. If we were measuring a component whose resistance causes the meter to read one small division above the 500K mark on the 100M ohm scale, the resistance value would be 550K (550,000) since each division between 500K and 1M represents 50K ohms. This is shown in Fig. 20.

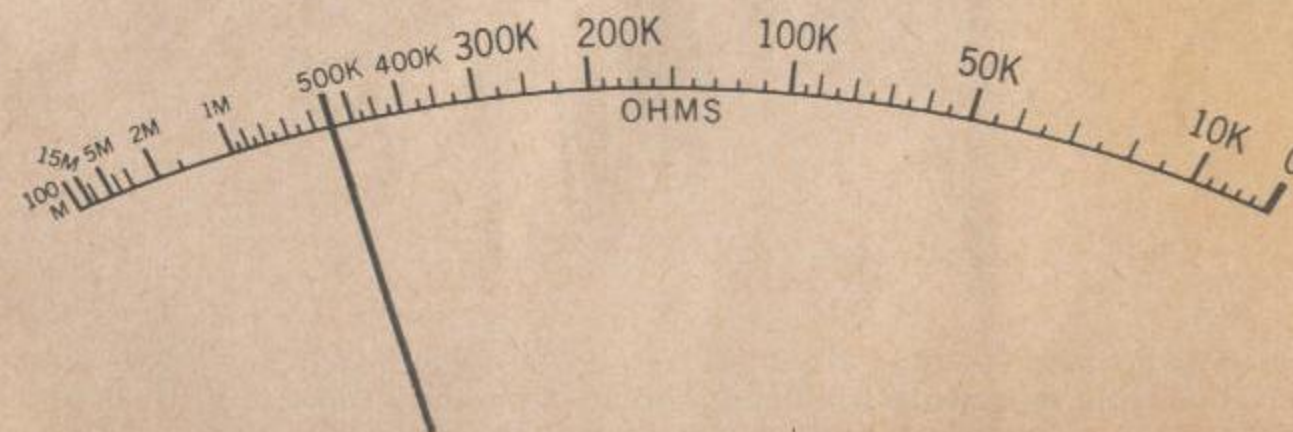

Figure 20—100 Meg Ohm Scale

D.C. Current Measurement

D.C. current measurements must be made by inserting the test leads in series with the circuit whose current is to be measured. When in doubt as to the approximate value of the current to be measured, always put the Range Selector switch to the highest range. All current ranges have a 250 millivolt sensitivity.

If the meter should read backwards when power is applied to the circuit under test, turn off the source of power and turn the Polarity Reversal switch to the opposite position. For all current measurements except the 10 amp range, the test leads are connected to the (—) and (+) jacks on the instrument. The Polarity Reversal switch is active for all current ranges, except the 10 amp range. On the 10 amp range the Polarity Reversal switch must be in the (+) position.

1. The 100 microampere range is calibrated in increments of 1 microampere. If for example the pointer was located as shown in Fig. 21, the meter would indicate that 52 microamperes of current is flowing in the circuit.



Figure 21—100 μ A. D.C. Scale

2. The next range is the 0-5 milliampere range. Each small division on this scale represents .05 MA. If the pointer came to rest as shown in Fig. 22, the meter would indicate that 3.1 MA of current is flowing in the circuit.



Figure 22—5 MA D.C. Scale

3. The next range is the 0-100 milliampere scale and each small division on this scale represents 1 milliampere. If the pointer came to rest as shown

in Fig. 23, the meter would indicate that 86 MA of current was flowing in the circuit.

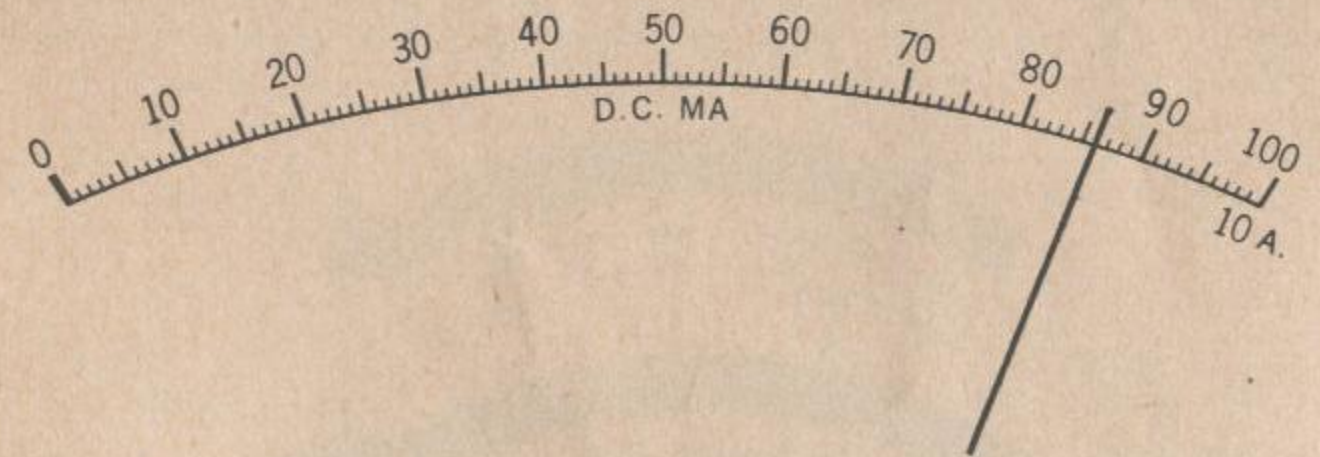

Figure 23—100 MA D.C. Scale

4. The 0-500 MA range is calibrated such that each small division represents 5 MA. If the pointer came to rest as shown in Fig. 24, the current flowing in the circuit would be 180 MA.

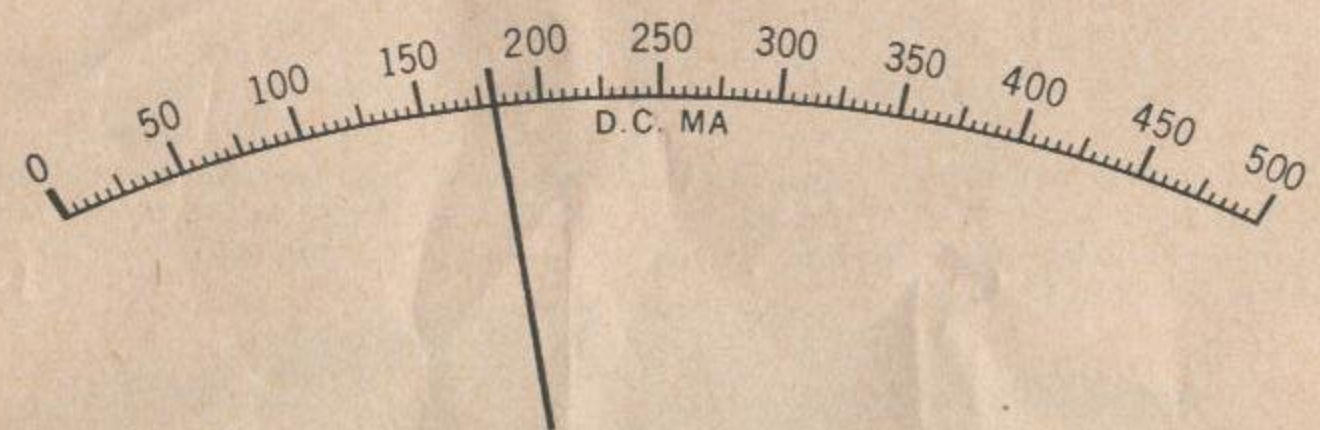

Figure 24—500 MA D.C. Scale

5. The highest current range is 0-10 amp. The test leads must be connected between the (—) and the 10A jacks. The Polarity Reversal switch must be in the (+) position in order for the meter to read. The Range Selector switch must be in the 100 MA position. 10 amperes represents full scale deflection and 9 amperes would occur at the 90 point on the scale, and 6 amperes would appear at 60 on the scale, etc. If the pointer came to rest as shown in Fig. 25, the current flowing in the circuit would be 5.1 amperes.



Figure 25—10A. D.C. Scale

Supplemental Ranges

Packed with the instrument are two plastic sheets with 18 supplemental scales printed on them. These scales must be cut out carefully on the outline as shown in Fig. 26A. When cutting out, crease the tab up on the clear line as

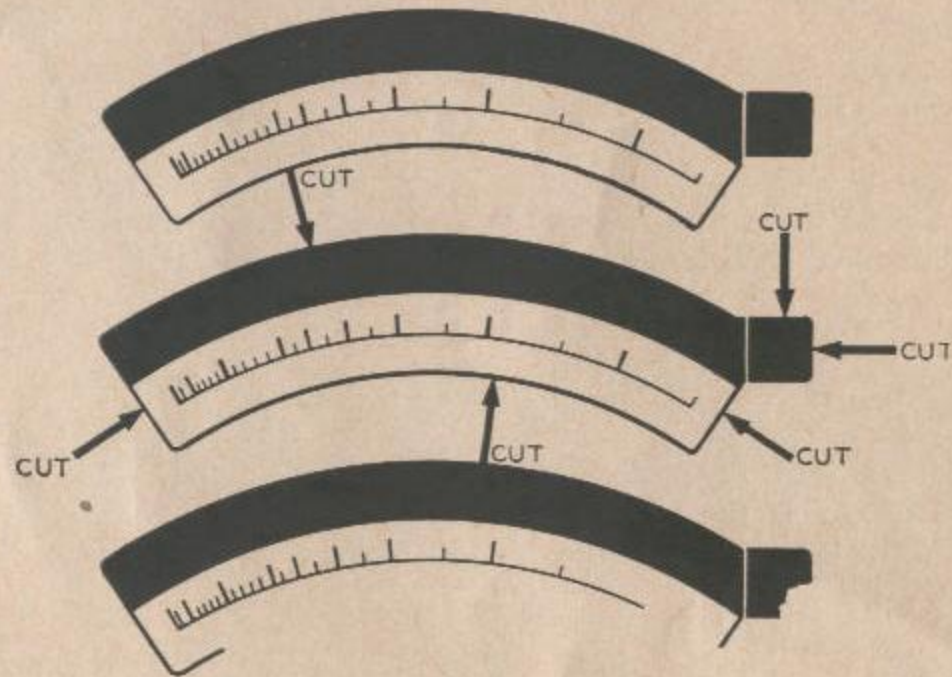

Figure 26A—How to Cut Out Supplemental Scales

shown in Fig. 26B. These scales can then be inserted into the window opening on the front of the V-O-Matic 360, and removed by lifting out with the tab. Many additional direct reading ranges are provided for use with your V-O-Matic 360 with these scales.

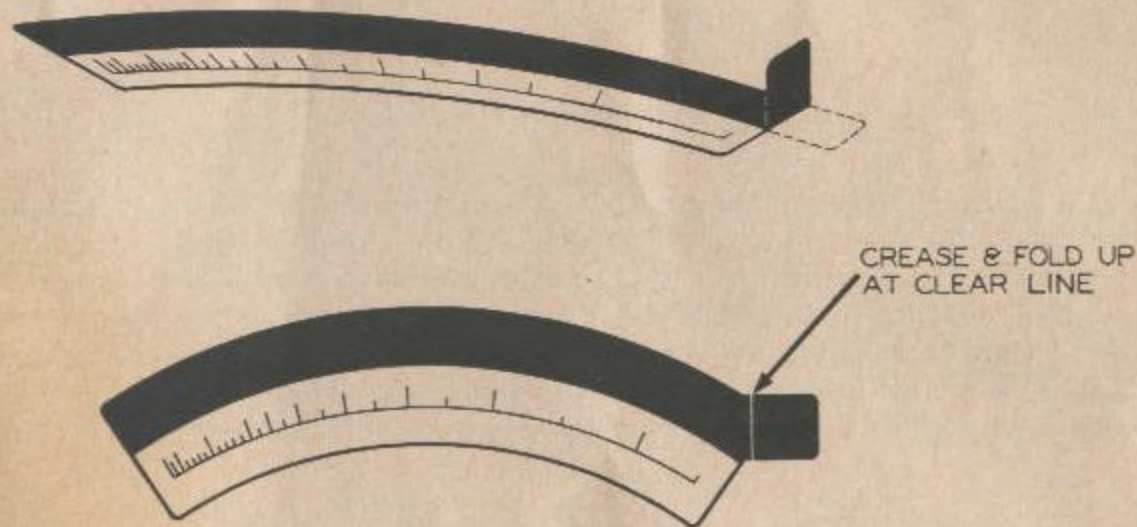

Figure 26B—How to Fold Tab on Supplemental Scales

Capacity Measurement

Three of the supplemental scales provided enable the instrument to measure capacity in the following ranges:

- .1 mfd to 4.1 mfd
- .0025 mfd to .12 mfd
- 100 mmfd to 4500 mmfd

To make a capacity measurement, the meter must be connected as shown in Fig. 27. For the 100 mmfd to 4500 mmfd range no shunting resistor is used. This is shown in Fig. 27A. For the range from .0025 mfd to .12 mfd, the circuit of Fig. 27B is employed. The shunting resistor is 600 ohm, 1/2 watt. For the highest capacity scale that reads from .1 mfd to 4.1 mfd, the circuit of Fig. 27C is used. The shunting resistor in this case is 16 ohms, 1 watt. The 3 volt A.C. range of the V-O-Matic 360 is used in all three cases. Source of power for this measurement is 117 volts, A.C. line. Before a capacitor is measured to determine its exact value, check to be sure that the capacitor is not shorted or leaky with the ohmmeter.

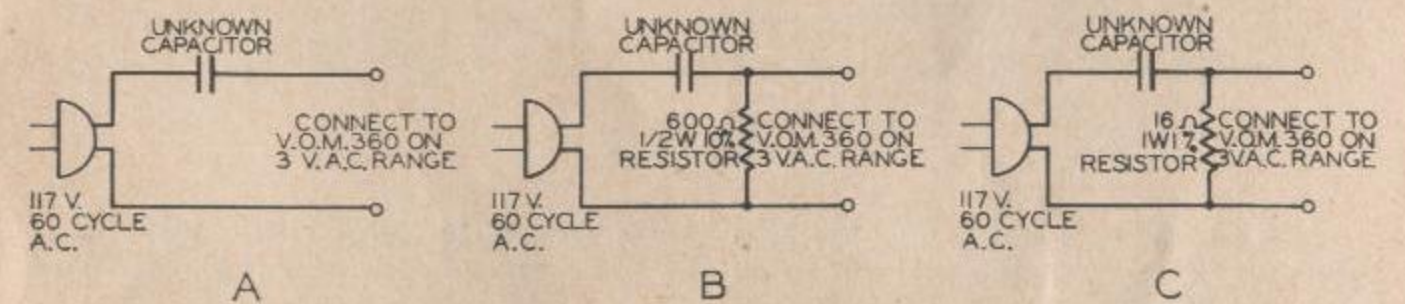

Figure 27—Electrical Circuits for Capacity Measurements

Example: Using the circuit as shown in Fig. 27B and the supplemental capacity scale from .0025 mfd to .12 mfd, the pointer on the meter reads .05. The capacity of the unknown is then .05 mfd as shown in Fig. 28. This measurement can only be made on paper tubular, Mica, Ceramic or Air Dielectric Capacitors. Do not measure Polarized Electrolytic Condensers as they may be damaged by this test.



Figure 28—.0025 to .12 mfd Capacity Scale

0-250 Millivolt Range

A direct reading supplemental scale is provided which is calibrated from 0-250 millivolts. This scale is placed into the window opening of the V-O-Matic 360, and the Range Selector switch is placed on the 100 microampere position. The meter will now read directly on the supplemental 0-250 millivolts scale with a sensitivity of 10,000 ohms per volt.

Measuring Decibels (Dbm)

Many voltage readings are taken where the voltage to be measured must be expressed in Decibels. The V-O-Matic 360 supplies 5 direct reading supple-

mental scales which cover the range from -20 Db to +62 Db. Zero Db represents a power level of .001 watt with a 600 ohm load, or .7746 volts. Fig. 29 shows the range of Db and the V-O-Matic range switch setting.

<u>Db Range</u>	<u>Use V-O-Matic 360 Range Switch Position</u>
-20 Db to +11 Db	3 volts A.C.
-5 Db to +25 Db	15 volts A.C.
+5 Db to +37 Db	60 volts A.C.
+20 Db to +51 Db	300 volts A.C.
+20 Db to +62 Db	1,000 volts A.C.

Fig. 29

If the reference level of zero Db equals .006 watts into a 500 ohm load, subtract +7Db from the reading to obtain the correct value of Db at this new reference level.

Audio Power Measurement

Seven direct reading supplemental scales are provided for audio frequency power measurements, at a 4 ohm load, 8 ohm load and 16 ohm load. Two scales are provided for the measurement of power into a 4 ohm load. Two scales are provided for measurement of power into an 8 ohm load and three scales are provided for measurement of power into a 16 ohm load. Fig. 30 tabulates the load impedance, and the maximum power reading with the supplemental scales. The position of the Range Selector switch of the V-O-Matic 360 for each of these scales is also indicated. The accuracy of the Power Measurement will be determined by the Accuracy of the Load Resistor. Be sure that the Load Resistor is capable of dissipating the required amount of power.

All of these supplemental scales are based on the measurement of sine wave power.

<u>Power Range of Supplemental Scales</u>		<u>Range Selector V-O-Matic 360 Position</u>
0 - 2.2 watts	4 OHM LOAD	3 volts A.C.
0 - 56 watts		15 volts A.C.
0 - 1.15 watts	8 OHM LOAD	3 volts A.C.
0 - 28 watts		15 volts A.C.
0 - .56 watts	16 OHM LOAD	3 volts A.C.
0 - 14 watts		15 volts A.C.
0 - 56 watts		60 volts A.C.

Fig. 30

Peak To Peak (P-P) Voltage Readings

Two direct reading supplemental scales are supplied, calibrated 0-170 volts peak to peak and 0-850 volts peak to peak. This is based on a sinusoidal waveform.

When using the 170 volts P-P supplemental scale, the Range Selector switch must be in the 60 volts A. C. position. When using the 850 volts P-P supplemental scale, the Range Selector switch must be in the 300 volt A.C. position.

These peak to peak voltages can also be measured at the output jack, in the event that it is desired to block a D.C. potential upon which the A.C. voltage is superimposed. Refer to section on OUTPUT MEASUREMENTS.

Use Of Bench Stand

Packed in the carton with the V-O-Matic 360 is a bench stand. This stand will enable the V-O-Matic to sit on a bench in either of two angles. This is shown in Fig. 31.

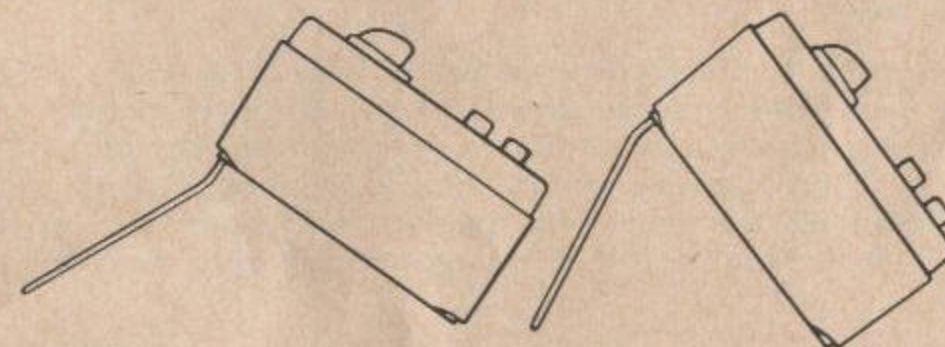

Figure 31—Bench Stand Installed

Carefully insert the two ends of the stand into the top two holes on the rear of the case, DO NOT FORCE. By reversing the stand and inserting into the holes, the instrument will rest at a different angle.

Eveready Case:

An optional accessory for the V.O.M. 360 is a Leather Eveready carrying case (see Fig. 32), with a test lead compartment. This case is available at your local distributors.

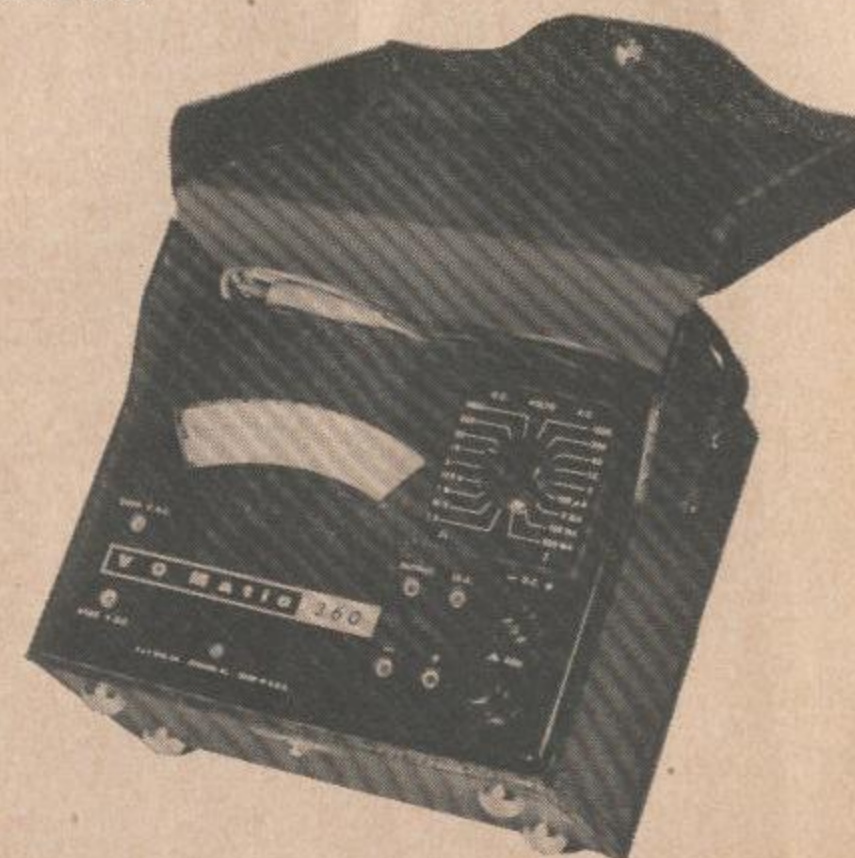

Figure 32—Eveready Carrying Case

MAINTENANCE

Access to the inside of the V-O-Matic 360 is accomplished by removing the 4 screws located in the holes at the rear of the instrument case. When the screws have been removed, the case and panel will separate.

Two batteries are used. One is a #2 1½ volt flashlight cell, and the second is a 9 volt battery type 2U6,006P, or equivalent. The connector for the 9 volt battery is polarized and can be connected only one way. When inserting the 1½ volt battery, be sure to observe polarity. The polarity is marked on the battery housing with an arrow showing the direction of the positive pole. ←+1.5 v.

The 1½ volt battery must be replaced when it is no longer possible to zero the ohmmeter on the 1K, 10K and 1M scales.

The 9 volt battery requires replacement when it is no longer possible to zero the 100M scale.

The A.C. rectifier is a complete assembly, B & K part No. ASM-55. This consists of the two rectifier diodes, and R-10 and R-11. If rectifier replacement is required, a complete assembly must be ordered from the factory for proper A.C. calibration. If any resistor replacement is required, replace with identical resistors as shown on the schematic diagram and parts list, or obtain this resistor from B & K Manufacturing Co., specifying part number as shown in the parts list.

A complete schematic diagram of the instrument and parts list with part numbers is enclosed with the instruction manual.

SCHEMATIC SYMBOL	DESCRIPTION	B & K PART No.	DEALER'S NET
------------------	-------------	----------------	--------------

MISCELLANEOUS

	Meter Movement Assembly.....	ME-10	17.10
	Consists of:		
M-1	METER		
R-23	Calibrating Resistor		
CR-3	Diode		
	Above 3 components not available separately.		
	Plastic Battery Housing Assembly with mirror...	ASM-66	1.92
	Mirror	LE-4A	.24
	Mirror Grommet	H-292	.03
	Calibrated Meter Rect. Assembly.....	ASM-84	3.45
	Consists of:		
CR-1 & CR-2	IN-48 Diode		
R-10 & R-11	Calibrating Pot	P-89	1.02
	Above components not available separately.		
	Pot Mounting Plate.	A-195	.12
	Rear Bakelite Case, with Handle.....	ASM-59	2.61
	Front Panel with Test Jacks.....	ASM-60	4.23
	Includes:		
	Dial Glass	LE-7A	.30
	Dial Glass Clips (4).....	H-231	.03
	Plastic Meter Zero Adjust Screw.....	CA-10	.06
	Clip for Zero Adjust Screw.....	H-230	.03
	Zero Adjust Washer.....	H-329	.02
	Range Selector Knob.....	K-22	.21
	Polarity Reversing Knob.....	K-19	.12
	Ohms Adjust Knob.....	K-6	.15
	Complete Test Lead Set.....	ASM-47	2.19
	1 Red Test Lead		
	1 Black Test Lead		
	Supplementary Scales	ASM-81	.90
	Consists of:		
	Scale Sheet No. 1.....		
	Scale Sheet No. 2.....		
	Stand with 2 Rubber Sleeves.....	ASM-62	.75
	Stand Only	A-170A	.51
	Rubber Sleeve Only.....	RU-2	.03
	Complete Drum Assembly with End Plates and Gear	ASM-63	2.52
	Drum Shaft	SM-10A	
	Drum End Bearings.....	H-272	.30
	Switch Gear	GE-1	
B-1	1.5V Dry Battery.....	BC-1	.20
B-2	9V Dry Battery.....	BC-2	1.35
	9V Battery Connector.....	BT-50	.15
	Carton and Fillers.....	PKG-59	.93

(Prices subject to change without notice)

Minimum charge \$1.00 per invoice. Orders will be shipped C.O.D. unless previous open account arrangements have been made or remittance accompanies order. Advance remittance must cover postage or express charges.

B & K Model 360 Parts and Price List

SCHEMATIC SYMBOL	DESCRIPTION	B & K PART No.	DEALER'S NET
------------------	-------------	----------------	--------------

RESISTORS — CONTROLS

R-1	55K Ohm 1/2W 3/4% Carbon Resistor.....	RC-56K-A-3/4	\$.33
R-2	240K Ohm 1/2W 3/4% Carbon Resistor.....	RC-240K-A-3/4	.33
R-3	900K Ohm 1/2W 3/4% Carbon Resistor.....	RC-900K-A-3/4	.33
R-4	4.8 Meg. Ohm 1/2W 1% Carbon Resistor.....	RC-4A8M-A-1	.33
R-5	14 Meg. Ohm 1 Watt 1% Carbon Resistor.....	RC-14M-B-1	1.11
R-6	3.5 Meg. Ohm 1/2W 1% Carbon Resistor.....	RC-3A5M-A-1	.36
R-7	1.2 Meg. Ohm 1/2W 1% Carbon Resistor.....	RC-1A2M-A-1	.33
R-8	225K Ohm 1/2W 1% Carbon Resistor.....	RC-225K-A-1	.33
R-9	60K Ohm 1/2W 1% Carbon Resistor.....	RC-60K-A-1	.33
R-10	Available only as part of ASM-84.		
R-11	Available only as part of ASM-84.		
R-12	5K Ohm 1/2W 3/4% Carbon Resistor.....	RC-5K-A-3/4	.33
R-13	50.51 Ohm 1/2W 3/4% Carbon Resistor.....	RC-50A51-A-3/4	.33
R-14	2.475 Ohm 1/2W 1% Wire Wound Resistor.....	RW-2A475-A-1	.63
R-15	Special Resistance Wire.....	RW-A071-D-3	
R-16	.5 Ohm 1/2W 1% Wire Wound Resistor.....	RW-A5-A-1	.63
R-17	130K Ohm 1/2W 1% Carbon Resistor.....	RC-130K-A-1	.33
R-18	89.1 Meg. Ohm 2W 1% Carbon Resistor.....	RC-89A1M-C1	2.49
R-19	29.7 Meg. Ohm 2W 1% Carbon Resistor.....	RC-29A7M-C1	.90
R-20	Special Resistance Wire.....	RW-A2A32-D-3	
R-21	16K Ohm 1/2W 1% Carbon Resistor.....	RC-16K-A-1	.33
R-22	5-25K Ohm 1/4W Carbon Potentiometer with P.P. Switch (Ohms Adj.).....	P-70	1.05
R-23	Meter Calibrating Resistor available only as part of ASM-56.		
R-24	7.5 Ohm 1/2W 1% Carbon Resistor.....	RC-7A5A-1	.33

CAPACITORS

C-1	.1 MFD @ 600V Ceramic Tubular Capacitor.....	CP-A1-600-20	.24
C-2	.02 MFD @ 500V Disc. Ceramic Cap.....	CC-A02-500-20	.12

SWITCHES

S-1	Ohms Shorting Switch, part of R-22.		
S-2	Polarity Reversing Switch.....	S-48	.81
S-3	Range Switch	S-47B	4.02
	Range Switch Assembly with all components....	ASM-86	15.84

5 VDC
 15 VDC
 60 VDC (6000 VDC)
 300 VDC
 1000 VDC
 1000 VAC
 300 VAC
 60 VAC (6000 VAC)
 15 VAC
 3 VAC
 100 μ A (250 MV)
 5 MA
 100 MA (10A)
 500 MA
 1 K Ω
 10 K Ω
 1 M Ω
 100 M Ω

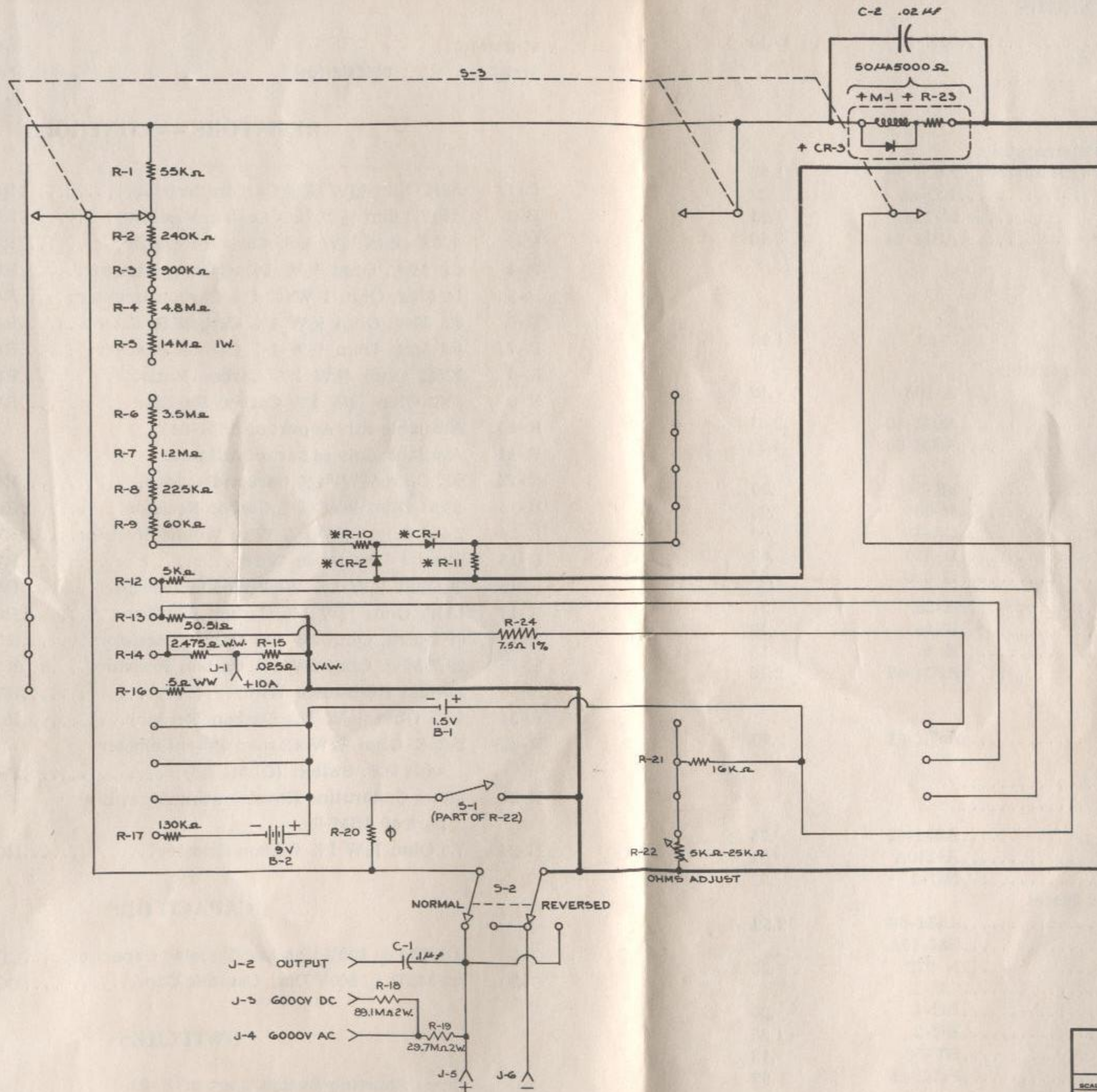

ALL RESISTORS \pm 1% $\frac{1}{2}$ W DEPOSITED
 CARBON UNLESS OTHERWISE
 SPECIFIED

ALL CAPACITORS 400 VDC
 \pm 20% UNLESS OTHERWISE SPECIFIED

ALL RHEOSTATS \pm 20% UNLESS
 OTHERWISE SPECIFIED

* AVAILABLE ONLY AS AN ASSEMBLY
 ASM 55

† AVAILABLE ONLY AS AN ASSEMBLY
 ASM 56

Φ SEE PARTS LIST

PM-209-E

⑤ 7-20-62
 ADD CAPACITOR C-2 FROM

⑥ 7-18-61
 ADD R-24 TO
 SCHEMATIC

⑦ 1-4-61
 CHANGED R-18 &
 R-19 VALUES
 & R-18 CIRCUITRY

⑧ 12-1-60
 CHANGED RESISTOR
 VALUE FROM 450 Ω
 TO 130 K Ω & BATT.
 FROM 30V TO 9V
 R-17

SCALE:	APPROVED BY RJK	DRAWN BY RGL
DATE: 10-31-60	REVISOR	REVISION
MODEL 360 SCHEMATIC DIAGRAM		
JOB	DRAWING NUMBER PM-209-E	