

DYNA-QUIK Model 650

**DYNAMIC MUTUAL CONDUCTANCE
TUBE & TRANSISTOR TESTER**

SERVICE INFORMATION

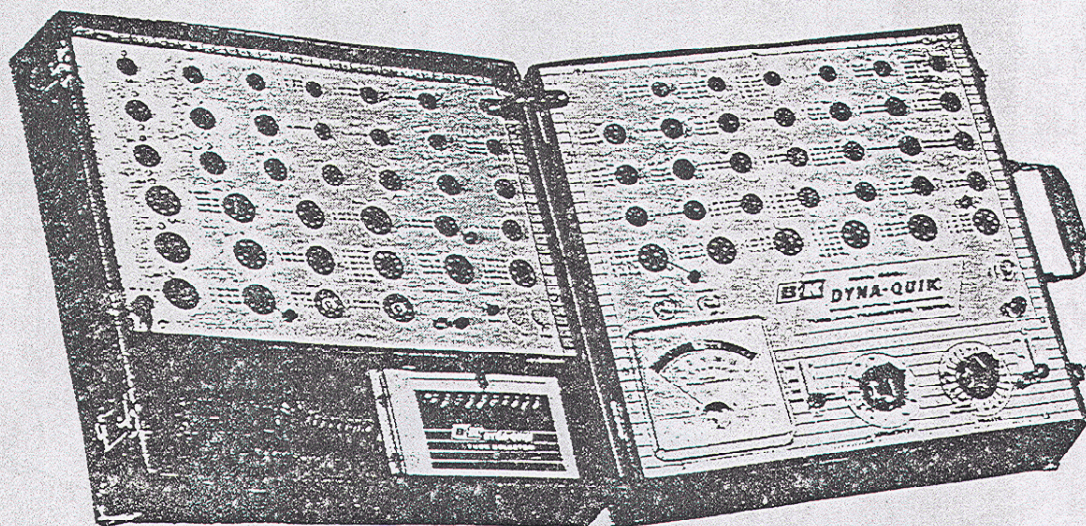

EVERYTHING 4 LESS

ENJOY YOUR BOOKS

PLEASE VISIT OUR STORE FOR EVEN MORE GREAT STUFF!

WWW.EVERYTHING4LESSSTORE.COM

COPYRIGHT NOTICE

ALL MATERIALS INCLUDING CD/DVD AND PDF FILES ARE COPYRIGHTED

WWW.EVERYTHING4LESSSTORE.COM VON WALTHOUR PRODUCTIONS AND MAY NOT BE REPRODUCED, COPIED OR RESOLD UNDER ANY CIRCUMSTANCES. YOU MAY HOWEVER MAKE A COPY FOR YOUR OWN PERSONAL BACKUP. MATERIALS ARE FOR PERSONAL USE ONLY.

IF YOU PURCHASED THIS FROM ANYWHERE BUT FROM US PLEASE NOTIFY US IMMEDIATELY SO THAT WE MAY CHECK IF YOU PURCHASED FROM AN AUTHORIZED RESELLER SO WE CAN LET YOU KNOW IF YOU NEED TO RETURN FOR FULL REFUND FROM AN UNAUTHORIZED SELLER.

THANKS AGAIN AND PLEASE TAKE THE TIME TO VISIT OUR STORE.

ATTENTION! EVERYTHING ON SALE NOW!!



HOT SALE!

B&K MODEL 650 DYNA-QUIK TUBE TESTER OFFICIAL SERVICE INSTRUCTIONS

Section "A" Circuit Description

The B&K Model 650 is a dynamic mutual conductance tube tester, built in two chassis. The first chassis consists of the main panel which contains all of the necessary voltages required to test the tubes and all 33 test sockets.

All voltages required for the auxiliary socket panel appear on the 20 contact connector located on the bridge panel chassis. The terminals of this 20 contact connector are numbered in the following manner.

With the main panel sitting upside down and the meter closest to you, the lower-hand contact would be marked # 1 and would read - # 1 thru 10 readings from bottom to top. The left row of contacts start with # 11 in the

lower left-hand corner and read from bottom to top, # 11 to # 20,

These numbers correspond to the numbers on the schematic diagram enclosed with this service information.

The schematic diagram lists all of the necessary voltages to troubleshoot this instrument. All voltages measured are opened circuit voltages, measured with 115 V AC on the primary, and all measurements have been made with a 20,000 ohm per volt VTVM or equivalent to chassis ground.

With test switch in test # 1 position, unless otherwise noted.

The tube tester is basically a balanced bridge circuit, consisting of the winding of transformer T-1 between brown and red-green, and the winding

between red-yellow and red, and resistors R-5 and R-6, matched 150 ohm resistors, and the two halves of the isolating diode, type 83.

The indicating meter is connected with a shunting potentiometer which is the sensitivity control across the two 150 ohm resistors.

The plate of the tube under test connects to terminal # 10 or # 11 in test 1 and 2 respectively which is the cathode of the 83 in the test position.

If screen voltage is required, that is obtained from pin # 9 which is a selenium rectifier power supply. This voltage is approximately 140 volts.

In the test position, the cathode is common ground and the heater voltages are supplied between terminals 3 and 4, and are selected by the heater selector switch. The DC bias for the tube under test is obtained from terminals 5, 6, 7 or 8, depending upon the bias classification of the tube.

Injected in series with the DC bias is a small signal voltage which is in phase with the upper winding or the brown-red-green winding to provide us with the signal necessary to make the measurement in dynamic mutual conductance.

B&K MODEL 650 **SERVICE INSTRUCTIONS**

CONTINUED FROM PAGE 1

A **little** closer examination of the bias network and signal voltage network is required . The negative voltage is obtained through selenium rectifier **M-2 which is**, in turn, connected to the **blue-white** secondary of the power transformer .

The output of the selenium rectifier goes through a bleeder resistor network, consisting of **R-12 ,R-4 ,R-21, R-22 ,R-23 .**

R-23 in turn returns to the output point of a voltage sensitive bridge **consisting** of two # **55** bulbs and two **16 ohm resistors.**

This bridge in turn goes to R-3, a voltage dropping potentiometer which is in series with a winding of the **6AT6** heater transformer.

The **voltage** obtained through this bridge circuit from the transformer is in series with the **DC** voltage on the bias string.

It is this signal voltage which appears on the bias string to excite the grid and provide **us** with the basis of measurement.

B&K MODEL 650

SERVICE INSTRUCTIONS

The purpose of the voltage sensitive bridge is to provide us with the automatic line voltage compensation feature that our instrument has. It operates in the following manner.

The voltage sensitive bridge has an inverse current characteristic. When the line voltage drops the resistance of the bridge circuit decreases causing an increase in signal voltage. If we did not employ this voltage sensitive bridge and we had an increase in line voltage, this would result in an increase in plate voltage to the tube under test, an increase in heater voltage and an increase in signal voltage. This would cause the test meter on the instrument to read higher than it normally should.

However, because of the voltage sensitive bridge and the manner in which it is operated, for an increase in line voltage, the voltage sensitive bridge bucks this increase by causing a decrease in the signal voltage applied to the tube under test.

This decrease of signal voltage offsets the increase of all other tube voltages and causes the instrument meter to read approximately the same as it did if the tube were tested at 115 volts.

This regulation will be maintained between limits of 105 - 125 volts of line voltage, and will cause the instrument to be no more than about 5% off in its reading for this wide variation of line voltage.

The design of the socket panels is based on the idea that large numbers of tubes having the same basing and similar operating conditions could be lumped and tested in one socket.

For example, socket # 9 which tests tubes of the 7 pin miniature RF-IF variety, all operate normally in approximately the same region of grid bias.

This is about 2.5 volts. This same approach was used in grouping tubes for all other sockets on the panel.

With the auxiliary socket panel turned upside down and the terminal strip located on the furthest away, these terminal strips are numbered from # 1 thru # 20.

These numbers correspond to the inter-chassis connecting plug number which were previously described with reference to the bridge panel.

B&R MODEL 650

CALIBRATION PROCEDURE

The calibration of the Model 650 instrument is quite simple and can be accomplished as explained on the accompanying procedure steps.

1. SIGNAL

The first step is to take an AC vacuum tube voltmeter, and with exactly 115 volts of AC line voltage, adjust the AC signal at terminal # 6 on the bridge panel to read exactly 1.45 volts R.M.S.

This adjustment is accomplished by adjusting the signal control located directly beneath socket # 60.

This control can be reached with a screwdriver through the keyway of this socket.

2. BIAS

With a 20.000 ohm per volt DC voltmeter, connect from pin # 6 to ground

, adjust the bias control which is R-4 to get a reading of 2.5 volts.

With a voltage of 2.5 volts at pin # 6, pin # 7 should read 3.5 volts and pin # 3 should read approximately 20 volts.

These voltages are predetermined by the values of the bias resistors which are 5% .

In the event that the other two voltages do not fall in, you can anticipate one of the resistors in the bias string as having a change in value.

R-4 is a small control located next to the signal pot.

3. BALANCE

The next procedure is to test the instrument for balance, and this is accomplished by connecting a 2000 ohm , 10 watt wire wound resistor from terminal # 10 of the inter-chassis plug to ground, and set the sensitivity control to 100 ,

If the instrument is out of balance, the meter will be deflected either upward or downwards, depending upon the direction of the unbalance.

All instruments in for service must be checked in this manner.

If the instrument is out of balance, you will find located underneath the main panel another small sensitivity control riveted to the bracket directly under the front panel sensitivity control.

Adjustment of this control will enable you to restore the needle to its zero reading.

B&K MODEL 650 **CALIBRATION PROCEDURE**

CONTINUED FROM PAGE 4

4. ADJUSTMENT OF GAS SENSITIVITY & GRID EMISSION.

Since the grid emission test effectively measures extremely high resistances the sensitivity of this test will vary ~~with~~ temperature and humidity.

Loss of sensitivity will occur under low temperature, low humidity conditions while an increase ~~in~~ sensitivity ~~will~~ occur under high ~~humidity~~ ~~and~~ temperature.

Absolute ~~maximun~~ sensitivity can be obtained by periodically adjusting the gas sensitivity control with no tube in the socket, ~~so~~ that the meter reading just falls to zero.

By checking ~~this~~ adjustment periodically, this threshold point can be maintained.

For nominal sensitivity of approximately **20** meg ohm , adjust as follows :

Connect a **20** megohm resistor between pin 1 of socket # **9** and **ground** .
With test switch in shorts and "gas" position, adjust P-43 for a reading of **2000** on the test meter.

P 4 3 control can be **reached** with a screwdriver through the keyway of **socket # 47** .

For more sensitive gas test, adjust for higher reading.

For less sensitive gas test, adjust for lowered reading.

5. THE FINAL STEP IN THE CALIBRATION

Is to **re-adjust** the signal control R-3 , ~~so~~ that calibrated tubes read correctly.

B&K MODEL 650

VOLTAGE CHART

All readings taken with a 1% V.O.M. with chassis as reference point.
With a 115 volt AC input and test switch in test 1 position .

Terminal

- 1 = 0.
- 2 = N.C.
- 3 = Heater.
- 4 = Heater.
- 5 = 0 volts a 1.45 volts AC can be measured **only** with an AC meter.
- 6 = -2.5 volts DC.
- 7 = -8.3 volts V.T.V.M. or V.O.M. with high capacity **blocking** capacitor
---- in series.
- 8 = - 20 volts .
- 9 = 140 volts DC .
- 10 = 205 volts DC.
- 11 = 205 volts DC, Pos. 2 only.
- 12 = 35 volts A C .
- 13 = 35 volts AC, Pos. 2 only.
- 14 = 35 volts AC, Pos. 2 only.
- 15 = 35 volts AC, Pos. 3 only.
- 16 = 200 volts A C .
- 17 = N.C.
- 18 = 0 .
- 19 = AC Line.
- 20 = AC Line.

B&K MODEL 650

SERVICE BULLETIN

Additional information that you should check your **B&K 650** for is as follows :

Number 1

Changing the # **49** pilot lite to a # **44** bulb has been done in production at serial # **5163** .

Units below this serial # should be checked for this change.

The reason for the change is to prevent a possible burn out of the # **49** pilot lite used as a fuse.

If the # **49** bulb is used change it to a # **44** bulb .

If a direct short is encountered, this fuse bulb will glow very brightly.

This fuse will also glow very brightly if a tube is plugged into the wrong socket. In some cases the old fuse (# **49**) burnt out when the plate cap lead accidentally touched the front panel while the tester was in the GM position. This will no longer occur with the # **44** bulb change.

Number 2

Add **R-35** resistor this has been done in production at approximately serial # **4700** and up. Check to see if this change has bin made.

R-35 is a **1200** ohm **1/2** watt **10%** carbon resistor in series with high voltage terminal #**16** on main panel.

This is to prevent off scale deflection of the meter when checking high voltage rectifiers.

If the unit being serviced dose not have this resistor it should be added at this time .

Number 3

Change **R-20** resistor this has been done in production at approximately serial # **4700** and above. Old **R-20** is a **82** ohm **1** watt resistor.

The new **R-20** must be a **120** ohm **1** watt **5%** resistor .

This is to prevent off scale deflection of the meter when testing low voltage rectifiers.

Number 4

Change **R-18** resistor this has been done in production at approximately serial # **5000** and above. Old **R-18** is a **270K** ohm **1** watt resistor.

The new **R-18** must be a **470K** ohm **1** watt **5%** resistor.

This change increases the sensitivity of the shorts check.

Number 5

Change **R-10** and **R-11** resistor this has been done in production at approximately serial # **6000** and above. Old **R-10** is a **100K** **1** watt resistor the new **R-10** must be a **120K** ohm **1** watt **5%** resistor . Old **R-11** is a **22K** ohm **1/2** watt resistor, The new **R-11** must be a **27K** ohm **1/2** watt **5%** resistor. This increases stability of the grid emission check.

FUNCTION SWITCH
M-5

TEST SWITCH CONTACTS MAKE
IN POSITION LISTED BELOW

- 1 SHORT-GAS: 3-3, 5-6, 10-11, 12-14, 15-17, 18-19, 21-22, 24-25, 27-29, 30-31, 33-35
- 2 TEST-1: 1-2, 4-5, 7-8, 11-9, 12-13, 17-16, 22-23, 33-34, 36-37
- 3 TEST-2: 1-2, 4-5, 7-8, 11-9, 12-13, 19-20, 25-26, 28-29, 33-34, 36-37
- 4 TEST-3: 1-2, 4-5, 7-8, 11-9, 31-33, 33-34, 36-37

OFF-ON LIFE TEST

OFF E-F ON A-C
LIFE TEST A-B

TEST SWITCH IN TEST POS. 1
READING WITH 2000A/DC &
5000A/AC
METER

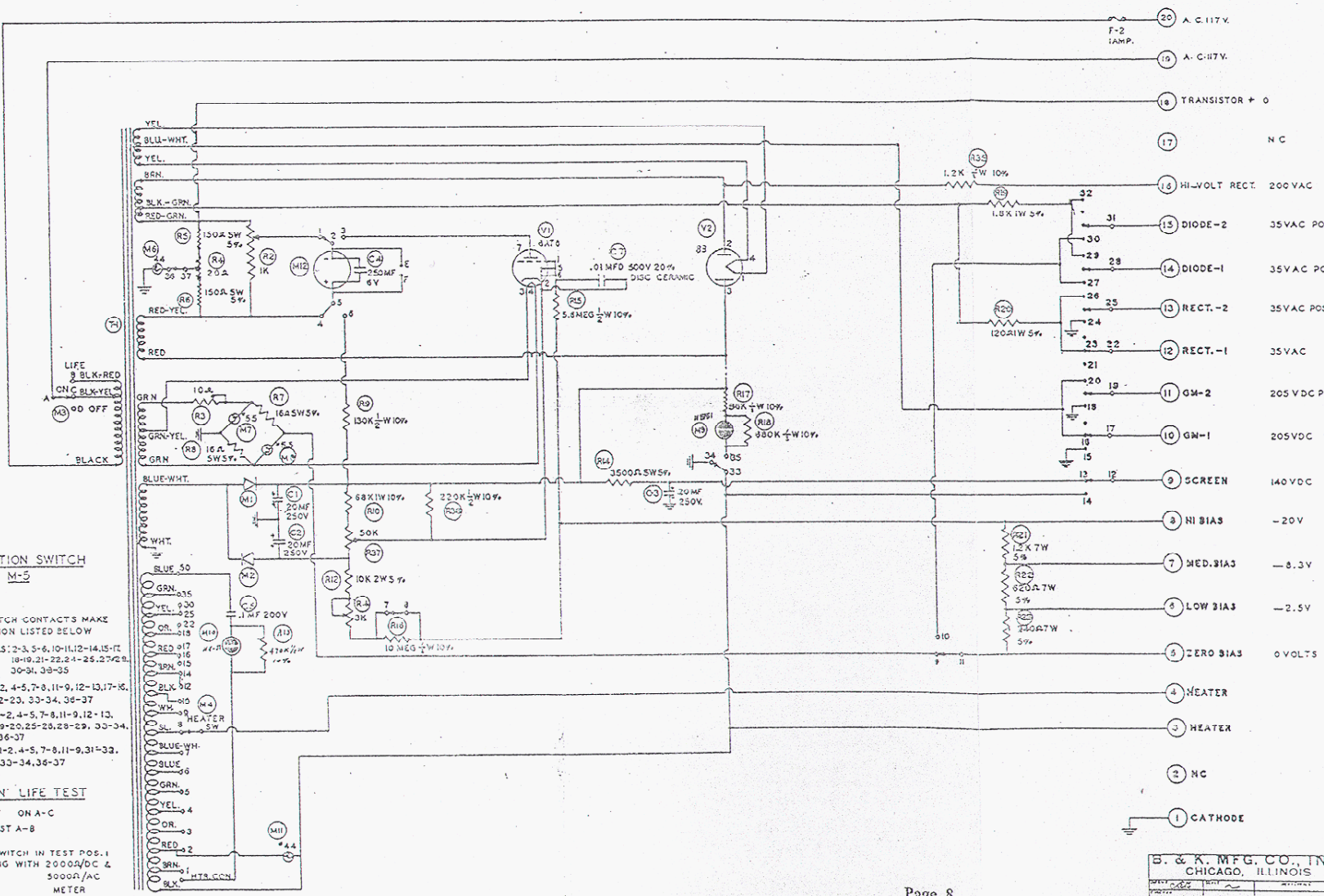

B. & K. MFG. CO., INC.			
CHICAGO, ILLINOIS			
DATE	BY	REVISED	
10-18-58	MENEL LSC		
BRIDGE PANEL			D 250-117

Schematic of Model 650 Test Panel

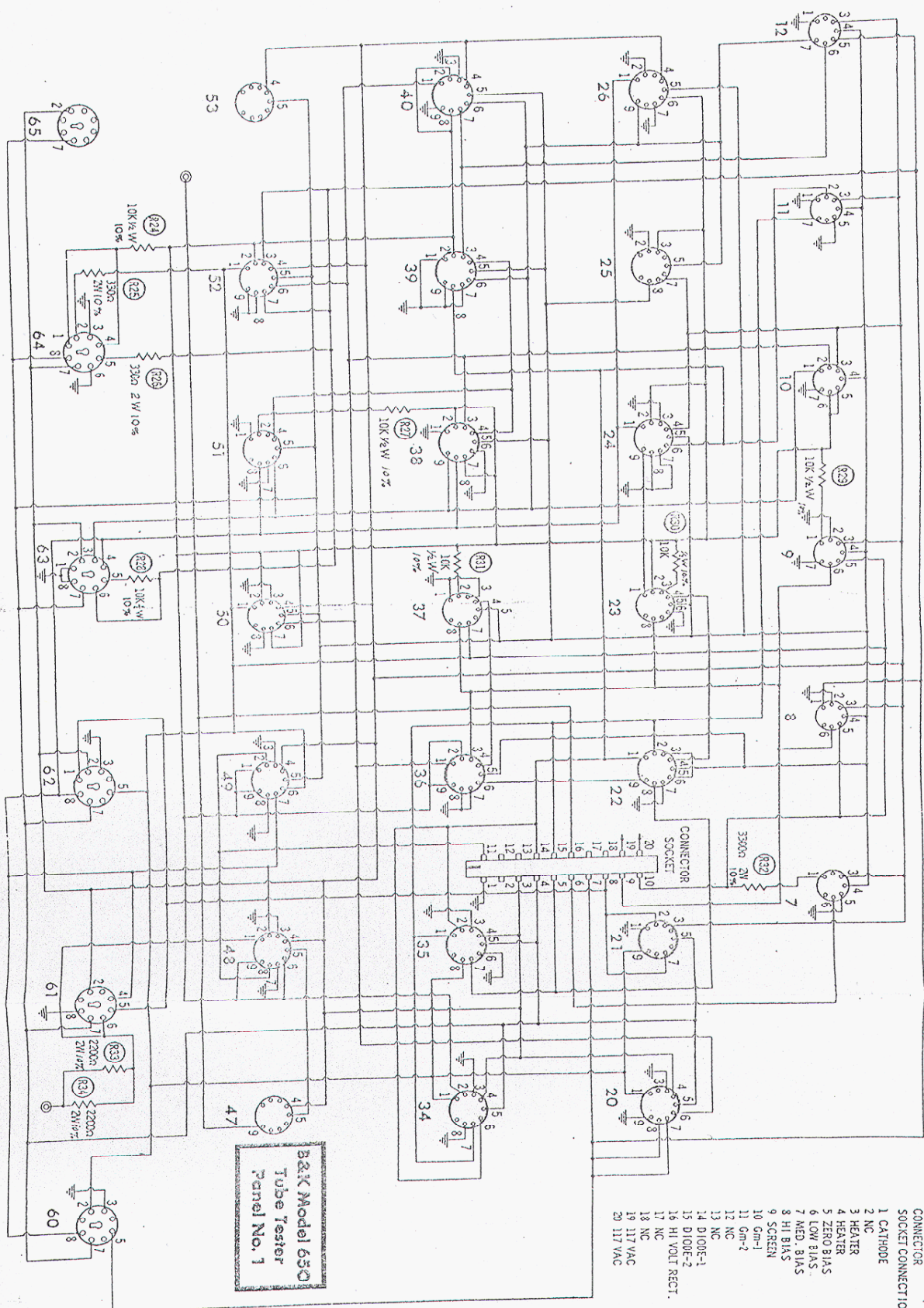

- CONNECTOR SOCKET CONNECTIONS
- 1 CATHODE
 - 2 NC
 - 3 HEATER
 - 4 HEATER
 - 5 ZERO BIAS
 - 6 LOW BIAS
 - 7 MED. BIAS
 - 8 HI BIAS
 - 9 SCREEN
 - 10 Gm-1
 - 11 Gm-2
 - 12 NC
 - 13 NC
 - 14 DIODE-1
 - 15 DIODE-2
 - 16 HI VOLT RECT.
 - 17 NC
 - 18 NC
 - 19 117 VAC
 - 20 117 VAC

B&K Model 650
Tube Tester
Panel No. 1

- CONNECTOR SOCKET CONNECTIONS
- 1 CATHODE
 - 2 NC
 - 3 HEATER
 - 4 HEATER
 - 5 ZERO BIAS
 - 6 LOW BIAS
 - 7 MED. BIAS
 - 8 HI BIAS
 - 9 SCREEN
 - 10 Gm-1
 - 11 Gm-2
 - 12 RECT-1
 - 13 RECT-2
 - 14 DIODE-1
 - 15 DIODE-2
 - 16 NC
 - 17 NC
 - 18 TRANSISTOR+
 - 19 IIT VAC
 - 20 IIT VAC

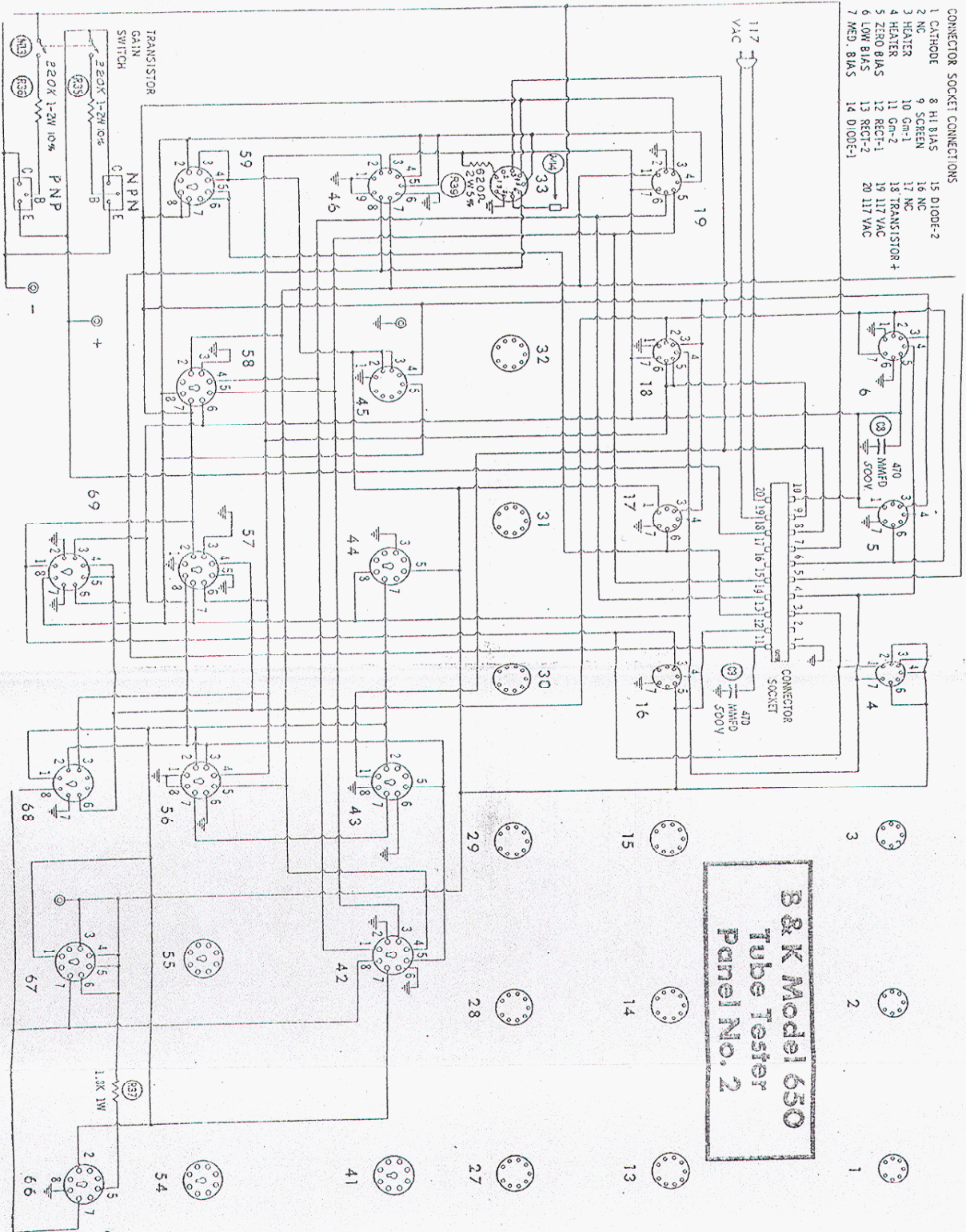

B & K Model 650
Tube Tester
Panel No. 2

B & K Model 650 Tube Tester Circuit Parts List

DESCRIPTION	PART No.
M1 Selenium RectifierE-65B
M2 Selenium RectifierE-65B
M3 Off-On-Life Test Switch.....S-1
M4 Heater Switch5-10
M5 Test Switch5-2
M6 #44 Mazda Lamp (Fuse).....PL-5
M7 #55 Mazda LampPL-4
M8 #55 Mazda LampPL-4
M9 NE51 Neon Lamp (Shorts).....PL1
M10 NE51 Neon Lamp (Heater Continuity)....PL-1
M11 #44 Mazda Lamp (Pilot Light)PL-5
M12 MeterME-1
T1 TransformerTP-1
V1 6AT6 TubeV-6AT6
V2 83 TubeV-83
C1 20MFD 250V Electrolytic Capacitor.....CL-20-250
c2 20MFD 250V Electrolytic Capacitor.....CL-20-250
c3 20MFD 250V Electrolytic Capacitor.....CL-20-250
c4 250MFD 6V Electrolytic Capacitor.....CL-250-6
C5 0.1MFD 200V Tubular Capacitor.....CP-A1-200-20
C6 .005MFD 600V Tubular Capacitor.....CP-A005-600-20
C7 .01MFD 500V Disc Ceramic Capacitor....CC-A01-500-20
R1 20Ω WW ControlP-4
R2 1000Ω WW ControlP2
R3 10Ω WW ControlP-1
R4 3000Ω WW ControlP3
R5 150Ω WW 5W 5% Resistor.....RW-151-D-5
R6 150Ω WW 5W 5% Resistor.....RW-151-D5
R7 16Ω WW 5W 5% Resistor.....RW-160-D-5
R8 16Ω WW 5W 5% Resistor.....RW-160-D-5
R9 180K ½W 10% Resistor.....RC-184-A10
R10 120K 1W 5% Resistor.....RC-124-B-5
R11 27K ½W 5% Resistor.....RC-273-A-5
R12 10K 2W 5% Resistor.....RC-103-C-5
R13 470K ½W 10% Resistor.....RC-474-A-10
R14 3500Ω WW 5W 5% Resistor.....RW-352-D-5
R15 5.6 Meg ½W 10% Resistor.....RC-565-A10
R16 10Meg ½W 10% Resistor.....RC-106-A10
R17 56K ½W 10% Resistor.....RC-563-A-10
R18 470K ½W 10% Resistor.....RC-484-A-10
E19 180052 1W 5% Resistor.....RC-182-B-5
R20 20Ω 1W 5% Resistor.....RC-121-B-5
R21 1200Ω 7W 5% Glass Resistor.,...RG.122.75
R22 620Ω 7W 5% Glass Resistor.....RG-621-7-5
R23 240Ω 7W 5% Glass Resistor.....RG-241-7-5
R24 10K ½W 10% Resistor.....RC-103-A10
R25 330Ω 2W 10% Resistor.....RC-331-C10
R26 330Ω 2W 10% Resistor.....RC-331-C10
R27 10K ½W 10% Resistor.....RC-103-A-10

DESCRIPTION	PART No
R28 10K ½W 10% Resistor..RC-103-A-10
R29 10K ½W 10% Resistor..RC-103-A-10
R30 10K ½W 10% Resistor..RC-103-A-10
R31 10K ½W 10% Resistor..RC-103-A-10
R32 330012 2W 10% Resistor..RC-332-C-10
R33 220012 2W 10% Resistor..RC-222-C-10
R34 220012 2W 10% Resistor..RC-222-C-10
R35 120012 1W 10% Resistor..RC-122-B-10
R36 10 Meg. ½W 10% Resistor..RC-106-A-10
6 7 Pin Miniature Tube Sockets (Test)	G7PF
21 9 Pin Noval Tube Sockets (Test)..	G9PF
6 Octal Tube Sockets (Test)..	G8P
2 Pin Jacks	J-3
1 20 Contact Connector Socket (Female)	J-2
1 7 pin Miniature Tube Pin Straightener.	H-46
9 Pin Noval Tube Pin Straightener..	H-47

B & K MODEL 650 TUBE TESTER TEST PANEL No. 2 PARTS LIST

C8 470MMFD 500V Disc Ceramic Capacitor.	CC-470-500-20
C9 470MMFD 500V Disc Ceramic Capacitor.	CC-470-500-20
R35 220K ½W 5% Resistor..	RC-224-A-10
R36 220K ½W 5% Resistor..	RC-224-A-10
R37 1.8K 1W 10% Resistor..	RC-182-B-10
M13 Transistor Gain Switch..	S-9
10 7 Pin Miniature Tube Sockets (Test)	G-7PF
12 9 Pin Noval Tube Sockets (Test)	G-9PF
2 Octal Tube Sockets (Test)..	G-8L
1a Octal Tube Sockets (Test)..	G-8P
2 Transistor Sockets (Test)	GT-3
1 Line Cord and Plug..	w-5
3 Black Pin Jacks..	J3
1 Red Pin Jack..	J8
1 20 Contact Connector Socket (Female)	J2

MISCELLANEOUS PARTS LIST FOR MODEL No. 650

8 Ft. Line Cord	w-5
Inter-Chassis Connecting Cable	ASM-1
Case	LG-1
Skirted Knob (Heater Switch)	K-1
Skirted Knob (Sensitivity Switch)	K-1
Push-On Knob (Test Switch)	K-2
Push-On Knob (Off-On-Life Switch)	K-2
1 Amp Line Fuse..	F-2
Instruction Book	PM-1
Complete Set of Index Cards..	PM-3
Tube Index	ASM-9
Carton	PKG-1
Tip Jack—Black	J-3
Tip Jack—Red	J-8
Grip Cap Assembly	ASM-2
Diode-Rectifier Test Leads (Set)	ASM-11

SPECIAL SERVICE BULLETIN 1-29-58

To: All Service Agencies &
Representatives

The attached Service Bulletin has been sent to all registered owners of the Model 650.

Additional information that you should know is as follows:

- Number 1 on the attached "Changing the #49 pilot lite to a #44 bulb has been done in production at serial #5163.
- Number 4 on the attached "Add R-35 resistor": has been done in production at approximately serial #4700.
- Number 5 on the attached "Change R-20 resistor" has been done in production at approximately serial #4700.
- Number 6 on the attached "Change R-18 resistor" has been done in production at approximately serial #5000.
- Number 7 on the attached "Change R-10 and R-11 resistors" has been done in production at approximately serial #6000.

An additional production change is as follows:

To pick up heater to grid short, two contacts were added to the function switch and a 10 megohm resistor R-36 is added to circuit per diagram below. This was done at serial #5575.

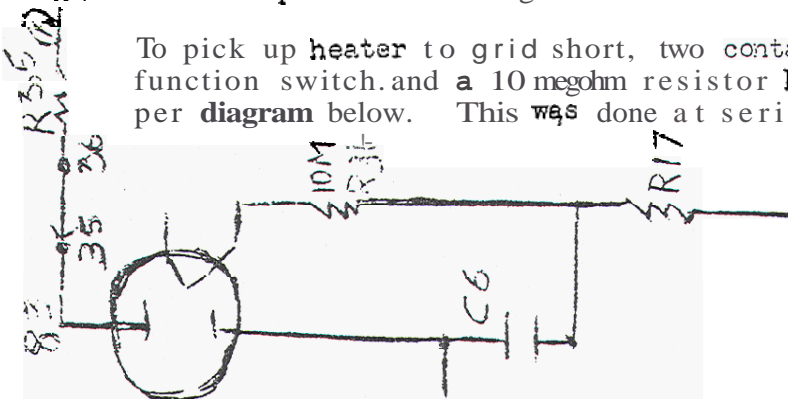

The following are errors in the instruction manual:

1. Page 6, Figure 6. Tube under test has plate returned to ground instead of B+.
2. Page 7, last paragraph. Should be headed PNP and NPN TRANSISTORS.
3. The DE7 erroneous information was removed from the tube index at serial #5145.

SERVICE BULLETIN 1-31-58

B & K MODEL 650 TUBE TESTER

Early field reports on the Model 650 Tube Tester indicate the following changes for reasons indicated.

1. prevention of possible burn out of the #49 pilot lite used as fuse.

Change this bulb to a #44. If a direct short is encountered, this fuse bulb will glow very brightly. This fuse will also glow very brightly if a tube is plugged into the wrong socket. In some cases the old fuse (#49) burnt out when the plate cap lead accidentally touched the front panel while the tester was in Cm position. This will no longer occur.

2. Due to printer's error, the 6CG8 reading on the index card is in error. The 5CG8 reading as listed on the panel is correct. The same sensitivity setting should be used for the 6CG8 as the 5CG8.

Card should read as follows for 6CG8:

HEATER	SOCKET	
6	48	pent. 1 - 82, 53 R - 4600
6	49	Tri. 2 - 73, 52 R - 6800

3. Readings for the following tubes in socket 52, - 6DE7, 8DE7 and 10DE7 were printed erroneously. In order to test these Woes, spare socket #33 may be wired as indicated below; the settings for these tubes in this socket then are:

TUBE		SOCKET		GOOD-BAD	TRUE Cm
6DE7	6	33	Tri 1	88	63 red
			Tri 2	95	71 black
8DE7		33	Tri 1	88	63 red
			Tri 2	95	71 black
10DE7	10	33	Tri 1	88	63 red
			Tri 2	95	71 black

Pin 1 - 620 Ohm, 2 Watt, 5% resistor to Pin 3, socket 46.

Pin 2 - No Connection

Pin 3 - Terminal 3 inter-chassis plug.

Pin 4 - to Pin 3, socket 19.

Pin 5 - to Pin 4, socket 19.

Pin 6 - to Pin 3, socket 46.

Pin 7 - white lead on Transistor gain switch.

Pin 8 & 9 - to chassis ground.

4. Add R-35, 1200 Ohm, 1/2 Watt, 10% resistor in series with high voltage terminal #16 on main panel. This is to prevent off scale deflection of meter when checking high voltage rectifiers.
5. Change R-20, from 82 Ohm to 120 Ohm, 1 Watt, 5%. This is to prevent off scale deflection on meter when testing low voltage rectifiers.
6. Change R-18, from 270K to 470K to increase sensitivity of short check.
7. Change R-3C, 100K, 1 Watt, to 120K, 1 Watt, 5%, and R-11 a 22K, 1/2 Watt to 27K, 1/2 Watt, 5%, to increase stability of grid emission check.

INSTRUCTIONS FOR OFFICIAL SERVICE AGENCIES
FOR B & K MODEL DYNA-QUIK TUBE TESTERS

CALIBRATING STANDARD TUBES

A. Standard tubes may be calibrated in the following manner. Select 12 new tubes of any one give type. Calibrate 1 type from each of the following groups:

B	<u>Group 1</u>	<u>Group 2</u>	<u>Group 3</u>
	6AU6	12AU7	6BQ6
	6AG5	12AV7	6BQ6
	6BC5	12A27	6CD6
	6BA6	12BH7	

C. Check these tubes in a Model B & K checker that has been accurately calibrated per instructions and that is connected to a controlled AC line accurately set to 115 V.

D. Six or seven of these tubes will have the same reading on the meter.

E. Select one of these tubes and label with the reading obtained.

F. These tubes can then be used for calibration of future checkers sermced.

Where high current tubes fall to one side of standard, opposite to reading on tubes of the 6AU6 variety, it may be necessary to slightly re-adjust the bias control. This method may be used for selection of calibrated tubes for all model tube testers. In each case the tubes are initially checked in a checker known to be good and with signal and bias carefully set.

INSTALLATION INSTRUCTIONS ASM-7

MODEL 650 TUBE TESTER GAS MODIFICATION KIT

Kit ASM-7 is designed in order to allow owners of the Model 650 Tube Tester to control sensitivity of the grid emission or "gas" test,

This circuit can then be adjusted for as critical an evaluation of gas content a grid current of vacuum tubes. as desired.

To install ASM-7 Kit proceed as follow:

1. Remove large panel from carrying case and disconnect connecting cable coming from small panel compartment.
2. Remove signal control from mounting bracket without disconnecting wires from control terminals (this control is located directly beneath socket 60).
2. Drill out rivets holding mounting bracket to sub chassis plate.
2. Mount signal control on new bracket in hole closest to bend with control on lip side.
5. Mount P-43 in other mounting hole.
6. Mount new bracket in place of old one using hardware supplied.
7. Remove from pin 2 of 6AT6 located next to meter, lead running to junction of R-10 and R-11. These resistors are located on socket side of sub-chassis plate.
8. Replace R-10, 120K, 1W, 5% resistor with 68K, 1W, 10% resistor.
9. Remove R-11, 27K, 1/2W, 5% resistor.
10. Connect open side of new R-10 to one end terminal of P-43.
11. Connect other end terminal of P-43 to junction of selenium rectifier, 10K resistor and 20 mfd capacitor (point where R-11 formerly connected).
12. Connect center lug of P-43 to pin 2, (cathode) of 6AT6 tube.

ADJUSTMENT OF GAS SENSITIVITY CONTROL

Since the grid emission test effectively measures extremely high resistances, the sensitivity of this test will vary with temperature and humidity. Loss of sensitivity will occur under low temperature, low humidity conditions while an increase in sensitivity will occur under high humidity and temperature. Absolute maximum sensitivity can be obtained by periodically adjusting the gas sensitivity control with no tube in the socket, so that the meter reading just falls to zero. By checking this adjustment periodically, this threshold point can be maintained.

For nominal sensitivity of approximately 20 meg ohm, adjust as follows:

Connect a 20 meg ohm resistor between pin 1 of socket #9 and ground, or between any other known grid pin and ground. With test switch in shorts and "gas" position, adjust P-43 for a reading of 2000 on test meter. Control can be reached with thin shafted screwdriver through keyway of socket #47.

For more sensitive gas test, adjust for higher reading.

For less sensitive gas test, adjust for lower reading.

E & K MANUFACTURING COMPANY
Chicago 13, Illinois

MODEL 610 — 650 INSTRUCTIONS

The Model 610 Test Panel when used in conjunction with your B & K Tube Tester will enable YOU to test in excess of 1600 tube types. Included in this list are voltage regulator tubes, hybrid auto radio tubes, thyratron tubes and a wide assortment of European tubes used in modern Hi Fi equipment.

INSTALLATION INSTRUCTIONS

An octal socket (No. 41) on the Model 650 has to be wired in accordance with the following step by step instructions. Remove left hand socket panel by **taking out** wood screws.

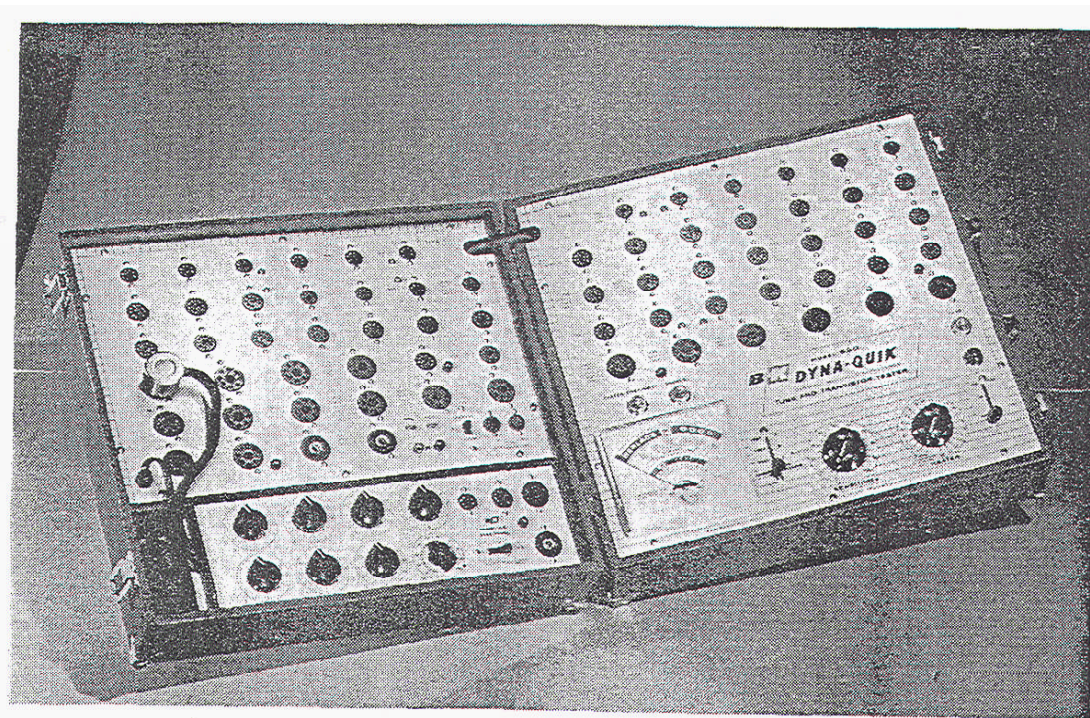

Fig. 1
Tube Tester with 610 Panel in place

1. Connect Pin 1 of Socket 41 to Pin 5 of Socket 43 using insulated wire.
2. " " 2 " " 41 " " 3 of cable socket
3. " " 3 " " 41 " " 5 of Socket 56
4. " " 4 " " 41 " " 16 of cable socket
5. " " 5 " " 41 " " 1 of Socket 43
6. " " 6 " " 41 " " 5 of Socket 66
7. " " 7 " " 41 " " 4 of cable socket
8. " " 8 " " 41 to ground lug of socket 41

Socket 41 should be wired as shown in Fig. 2.

Replace socket panel and put back all wood screws.

Remove tube chart in compartment on left hand side of case. Remove the 2 wooden blocks that support this chart. These can be gently forced out with a screw driver. Insert 610 into compartment and fasten with the 4 wood screws provided. See Fig. 1.

Discard old chart and use new chart supplied with 610. The new chart is a combined listing of all tubes tested on the Model 650 and all of the new types listed on the 610.

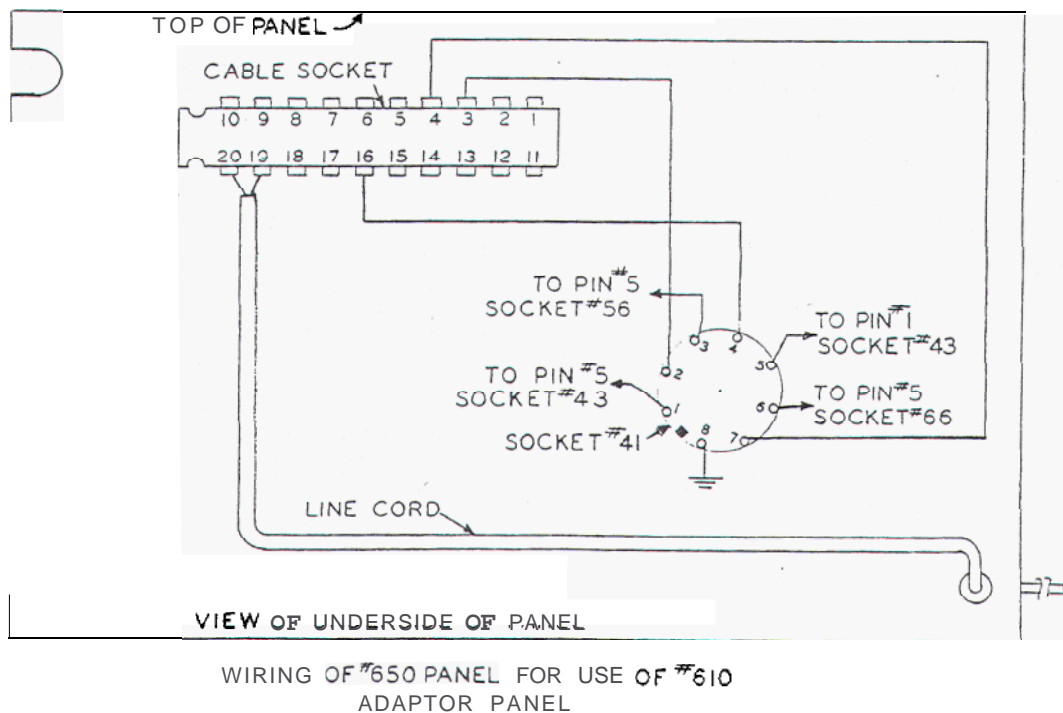

Fig. 2

OPERATION

The operation of the Model 610 is simple and straightforward. All necessary set up information for the 610 is given on the chart.

1. Insert the plug from the 610 into the octal socket #41 previously wired for the 610 adapter.
2. Locate tube type to be tested on the chart. A typical listing is shown in Fig. 3.

Tube Type	Heater	Socket	Sensitivity	A	B	C	D	E	F	G	H	J	Test Pos.	
6BM8	6	610	87	2	0	1	4	9	8	0	4	7	1	1
	6	610	46	3	0	2	6	5	1	8	2	7	3	1
6SN7	6	27	46											1
	6	27	46											

Fig. 3

The first column in the chart after tube type is Heater. Set Heater switch on the tube tester to the proper voltage. The next column is Socket. If the number 610 appears in this column the tube to be tested will be inserted into the proper socket of the 610. If the tube is a type that can be tested in the basic tester then the proper socket number will appear and the tube is tested in the normal manner. If the type in our example is a 6BM8 the socket column will show 610. Proceed to set up the switch as indicated in the proper column. Each switch is lettered A, B, C, D, E, F, G and the control is letter H. Switch J has four positions and must be placed in the proper position as shown in the J column.

After the switches have been set up, insert the tube in the proper socket of the 610 and proceed with the testing for Grid Emission, Shorts and Quality with the test switch of the basic tester, just as for a tube in any of the regular sockets. If the tube under test is a multi-section tube, the switch will have to be set for the second section as indicated on the chart. See Fig. 3.

Note:- While rotating the various switches to their proper positions, the Shorts Light may light or the meter may kick up. This is normal and does not represent a defect of the instrument. When the switches are at their proper position then the Shorts Light and Grid Emission Test will indicate only defects in the tube under test.

SOCKET WIRING INSTRUCTIONS TO TEST O24 TUBE ON THE MODEL 650 TUBE TESTER

In order to test tube type 024, a spare socket can easily be wired to test this tube on the left hand panel. For those who desire to test this tube, this socket can be prepared at the same time that socket 41 is being wired to accommodate the Model 610. Perform the following step by step procedure. Check **off** each step as you proceed.

- 1. Connect a 16½" piece of #22 insulated wire from pin #3 of the 83 rectifier socket to pin #17 of the inter-chassis cable connector. Both are located on the main panel. The socket terminals *for* both the main panel and the left hand panel inter-chassis connectors are numbered in the same manner. This is shown in Fig. 2 of your 610-650 instruction sheet. Solder both connections.
- 2. Connect a 11" piece of #22 insulated wire between pin #8 of the 024 socket to be wired, to pin #17 of the inter-chassis cable connector on the left hand panel. Again refer to Fig. 2 of the 610-650 instructions for numbering sequence. Solder both connections.
- 3. Connect a 4.7K, 7 watt resistor from socket 59, pin #6, to the 024 socket. **PIN 3**
Solder both connections.
- 4. Connect a second 4.7K, 7 watt resistor from socket 43, pin #5, to 024 socket, pin #5. Solder both connections.

The table shown below gives you the sensitivity settings and test positions for testing the 024 tube.

TUBE TYPE	HEATER	SOCKET	SECTION	TEST POS.	SENSITIVITY		STANDARD Gm
					Good	True Gm	
024			D1	1	7		
			D2	2	7		

PARTS AND PRICE LIST MODEL #610

DESCRIPTION	B & K PART NO.	DEALER PRICE
Cable Assembly	ASM-53	1.98
7 Pin Socket	G-7PF	.12
Loctal Socket	G-8L	.18
Octal Socket	G-8PF	.12
9 Pin Socket	G-9PF	.15
Cable Strain Relief	H-94	.03
Ferrite Ring	H-150	.03
½" Grommet	H-262	.03
Plate Jack Black	J-33	.12
Knob, Round	K-7	.15
Knob, Bar	K-17	.15
20 K Pot "H"	P-75	1.77
1800 Ohm ½ Watt 10% Carbon Res.	RC-182-A-10	.06
22 K Ohm 2 Watt —10% Carbon Res.	RC-223-C-10	.18
12 K Ohm 1 Watt —10% Carbon Res.	RC-123-B-10	.09
Switch, Set-Up A, B, C, D, E, F	S-50	2.67
4 Position, Slide Switch "J"	S-51	.42
Switch, Set-Up "G"	S-52	.32

EVERYTHING 4 LESS



ENJOY YOUR BOOKS



PLEASE VISIT OUR STORE FOR EVEN MORE GREAT STUFF!

WWW.EVERYTHING4LESSSTORE.COM

COPYRIGHT NOTICE

ALL MATERIALS INCLUDING CD/DVD AND PDF FILES ARE COPYRIGHTED

WWW.EVERYTHING4LESSSTORE.COM VON WALTHOUR PRODUCTIONS AND MAY NOT BE REPRODUCED, COPIED OR RESOLD UNDER ANY CIRCUMSTANCES. YOU MAY HOWEVER MAKE A COPY FOR YOUR OWN PERSONAL BACKUP. MATERIALS ARE FOR PERSONAL USE ONLY.

IF YOU PURCHASED THIS FROM ANYWHERE BUT FROM US PLEASE NOTIFY US IMMEDIATELY SO THAT WE MAY CHECK IF YOU PURCHASED FROM AN AUTHORIZED RESELLER SO WE CAN LET YOU KNOW IF YOU NEED TO RETURN FOR FULL REFUND FROM AN UNAUTHORIZED SELLER.

THANKS AGAIN AND PLEASE TAKE THE TIME TO VISIT OUR STORE.

ATTENTION! EVERYTHING ON SALE NOW!!



HOT SALE!

**THIS PAGE COPYRIGHT VON WALTHOUR PRODUCTIONS
WWW.EVERYTHING4LESSSTORE.COM**

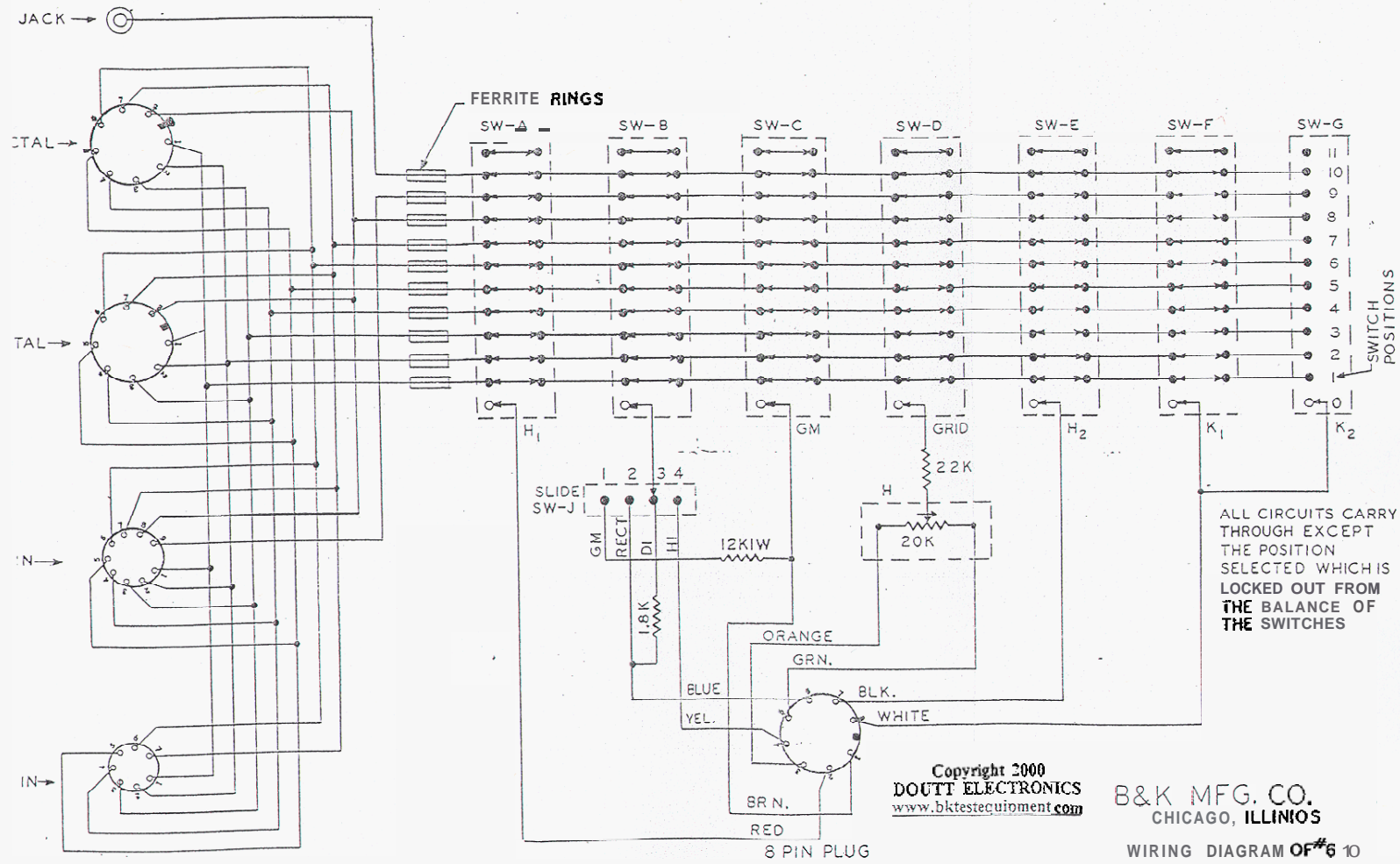

Copyright 2000
 DOUTT ELECTRONICS
 www.bktestequipment.com

B&K MFG. CO.
 CHICAGO, ILLINIOS
 WIRING DIAGRAM OF #6 10