

# OPERATING INSTRUCTIONS

*for*

## MEASUREMENTS MODEL 59

**MEASUREMENTS**

**BOONTON**



**CORPORATION**

**NEW JERSEY**

INDEX TO CONTENTS

	Page
List of Illustrations . . . . .	3
Introduction . . . . .	4
Specifications . . . . .	4
Section I. OPERATING INSTRUCTIONS:	
a. Setting Up . . . . .	5
b. Selection of Coils . . . . .	6
c. Adjustment of Coupling . . . . .	6
d. Modulation . . . . .	8
e. Use of Phones . . . . .	8
Section II. USE IN RECEIVER DESIGN AND ALIGNMENT	
a. Video Output Design . . . . .	8
b. Video Detector Filter Design . . . . .	8
c. Video I.F. Bandpass Amplifier Design and Alignment . . .	10
d. Input Circuit Design and Alignment . . . . .	11
Section III. USE IN TRANSMITTER DESIGN AND ADJUSTMENT	
a. Application to Audio Modulators . . . . .	12
b. Use in Master Oscillator Stages . . . . .	13
c. Use in Tuning Buffer Amplifier Stages . . . . .	13
d. Final Power Amplifier Tuning . . . . .	13
e. Neutralization . . . . .	14
f. Parasitics . . . . .	15
Section IV. USE IN ANTENNA ADJUSTMENT	
Includes Transmission Lines and Matching Stubs . . . . .	16
Section V. MEASUREMENT OF C, L, M, AND Q	
a. Measurement of Capacitance . . . . .	18
b. Measurement of Inductance . . . . .	18
c. Measurement of Mutual Inductance . . . . .	20
d. Measurement of Q . . . . .	21
Section VI. SERVICE AND MAINTENANCE	
a. Replacement of Tubes . . . . .	22
b. Circuit Failure . . . . .	22
Section VII. ACCURACY	
Summary of Dependent Factors . . . . .	24

LIST OF ILLUSTRATIONS

	Page
1. Typical Set Up of Model 59. . . . .	5 - 6
2. Use of Inductive Coupling . . . . .	7
3. Use of Capacitative Coupling. . . . .	7
4. Television Video Output Stage Arranged for Carrier Difference Sound Output Discriminator . . . . .	9
5. Use of Model 59 as Trace Marker . . . . .	9
6. Video Detector Low Pass Filter. . . . .	10
7. High Pass Filter Design . . . . .	11
8. Reaction Method of Neutralization . . . . .	14
9. Transmission Method of Neutralization . . . . .	15
10. Checking for Standing Waves on Transmission Lines . . . . .	16
11. Coupling to Quarter-Wave Stubs. . . . .	16
12. Capacitance Chart . . . . .	17
13. Measurement of Capacitance. . . . .	18
14. Reactance-Frequency Chart . . . . .	19
15. Measurement of Mutual Inductance. . . . .	20
16. Measurement of "Q". . . . .	21
17. Adjustment of Trimmer . . . . .	22
18. Schematic Diagram . . . . .	23

NO PART OF THIS MANUAL MAY BE  
REPRODUCED IN WHOLE OR IN PART  
EXCEPT BY PERMISSION OF  
MEASUREMENTS CORP.

●  
Copyright 1947 by  
MEASUREMENTS CORPORATION

●  
Printed in U.S.A.

## GENERAL DESCRIPTION

### INTRODUCTION

The Megacycle Meter is:

- A grid dip meter
- A variable frequency oscillator
- An absorption wavemeter
- An oscillating detector
- A tuned circuit absorption detector

It consists of a compact oscillator connected to its power supply by a small flexible cord. The tuned circuit coil is mounted externally so that it will be convenient for coupling to other circuits. In series with the grid leak are a d-c microammeter and a jack for insertion of a telephone headset in the circuit. A switch is provided to remove the plate voltage from the oscillator tube, changing the tube from a triode oscillator to a diode detector. The Model 59 is promptly accepted as a most useful tool. It is a simple, accurate, and versatile instrument capable of saving much valuable engineering time.

### SPECIFICATIONS

Frequency Range:

2.2 Mc. to 400 Mc. with seven plug-in coils.

Modulation:

CW or 120 cycles fixed at approximately 30% or external.

Dimensions:

Power Unit 5-1/8" wide; 6-1/8" high; 7-1/2" deep, wt. 6-1/2 lbs.

Oscillator Unit 3-3/4" dia.; 2" deep; wt. 1 lb.

Power Supply:

117 volts, 50-60 cycles, 20 watts.

Tubes:

- One type 955 oscillator
- One type VR-150/30 regulator
- One type 5Y3GT rectifier

SECTION I  
OPERATING INSTRUCTIONS

a. Setting up:

The Megacycle Meter consists of three units: The power supply, coil set, and oscillator unit.

It is convenient to remove the coil set from its storage space in rear of the power supply and clip it in place as shown in Figure 1A. This permits free access to the coils and provides a definite place for unused coils.

Do not allow unused coils to lie scattered about on the work bench. They are easily lost or damaged. These coils are individually calibrated for each oscillator unit and serially numbered; therefore replacement usually involves re-calibration. For storage position of coils see Figure 1B.

Check power supply voltage and frequency. All standard Model 59's are designed for operation on 117 volt, 50-60 cycle power. If the supply is correct, plug in the power cord and switch on by flipping up the power switch at the right side of the power unit.

After 30 seconds warm up period the meter should indicate to the left if switch is on DIODE, or up scale if a coil is plugged into the oscillator unit and switch is set on CW or MOD.

Adjustment of the SENSITIVITY knob will set the oscillating grid current to some convenient value on the 0 to 100 scale.

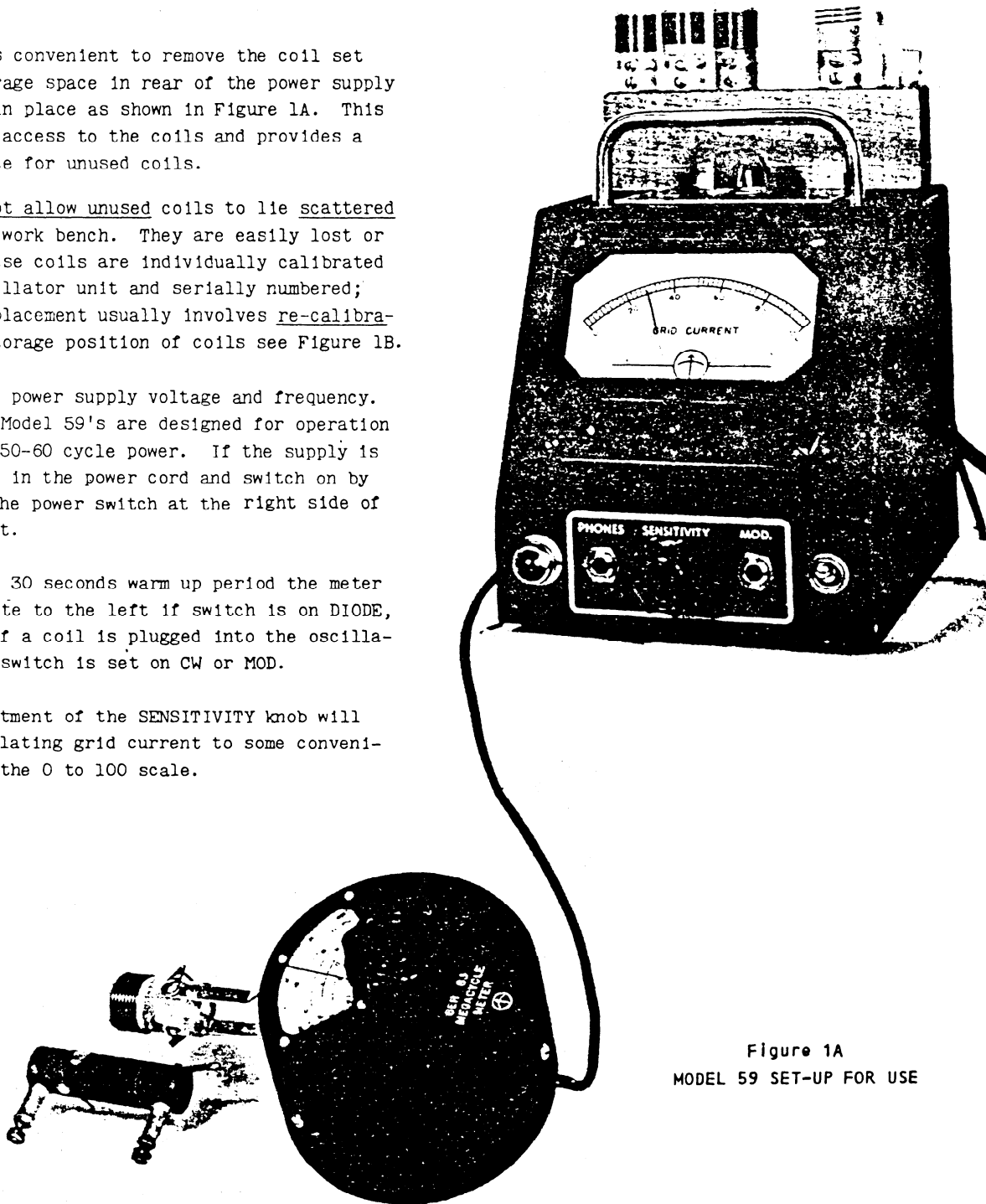

Figure 1A  
MODEL 59 SET-UP FOR USE

b. Selection of Coils:

Frequency ranges are marked on each coil except for the two highest frequency coils. Frequency limits of the corresponding scales are marked on the oscillator unit. After insertion of the desired coil, it is advisable to set the tuning knob to mid-scale, and then adjust the sensitivity knob to approximately 50 on the grid current meter. Normal variation of the grid current with tuning will then usually remain on scale over the entire range of that particular coil. (Note: on some low frequency coils it may be necessary to readjust the sensitivity knob at the extremes of the tuning range.)

c. Adjustment of Coupling

Either inductive or capacitive coupling of the 59 can be made to circuit under test.

For most tuned circuits it may be more convenient to utilize inductive coupling. A simple illustration of a typical circuit is shown in Figure 2. This represents a common by-pass difficulty which gives rise to dead spots in high frequency receivers and transmitters. Maximum coupling (and largest dip in grid current) will result with the axis of the oscillator coil at right angles to the current flow. For accurate checking of the resonant circuit frequency, the coupling should be loosened by increasing the separation between the oscillator coil and the circuit under test until only a moderate dip in grid current (10 to 20%) results when tuning through resonance.

Some types of tuned circuits are well shielded magnetically, so that it is difficult to utilize inductive coupling. Figure 3 illustrates such a circuit. This co-axial line resonant circuit is self shielding and of sufficiently high

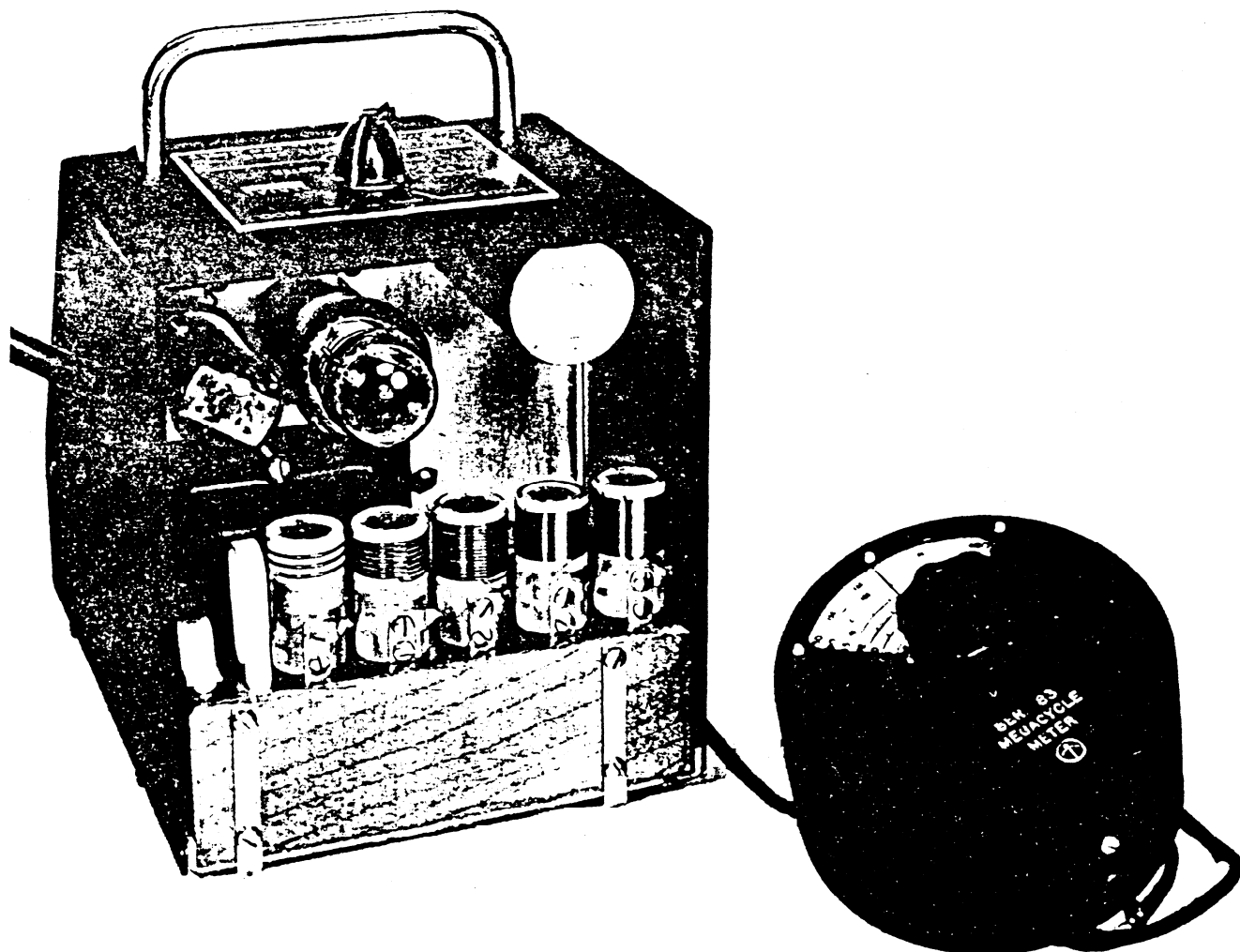

Figure 1B  
STORAGE POSITION OF COILS

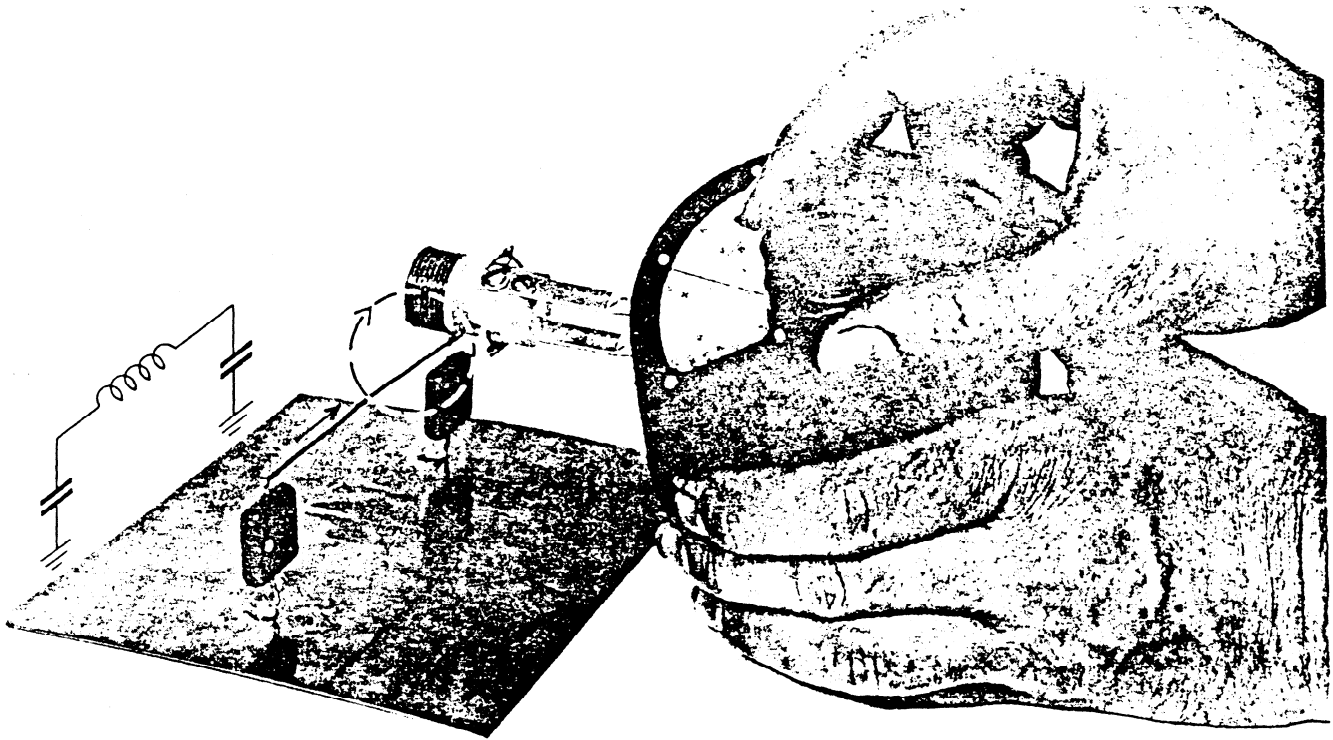

Figure 2 - USE OF INDUCTIVE COUPLING

This illustrates the arrangement of the oscillator coil at right angles to the current flow for maximum coupling to the resonant circuit.

"Q" to permit the use of the capacitive coupling obtained by placing the open or "hot" end of the circuit near one coil terminal of the Model 59. This stray capacitance coupling may not be sufficient for loaded circuits, such as might be used in television pre-selectors, etc. For these applications, it may be necessary to use a one or two micromicrofarad coupling capacitor. This can be obtained by twisting together an inch or two of hook-up wire. This capacitance should be kept as small as possible, since it will affect the frequency calibration accuracy of the Model 59. Fortunately it is not usually required that loaded (low "Q") circuits be located as accurately in frequency as higher "Q" ones.

Completely enclosed resonant cavities usually have some type of coupling loop which can be utilized with the aid of an auxiliary external transmission line and coupling loop as a link coupling arrangement for coupling inductively to the Model 59.\*

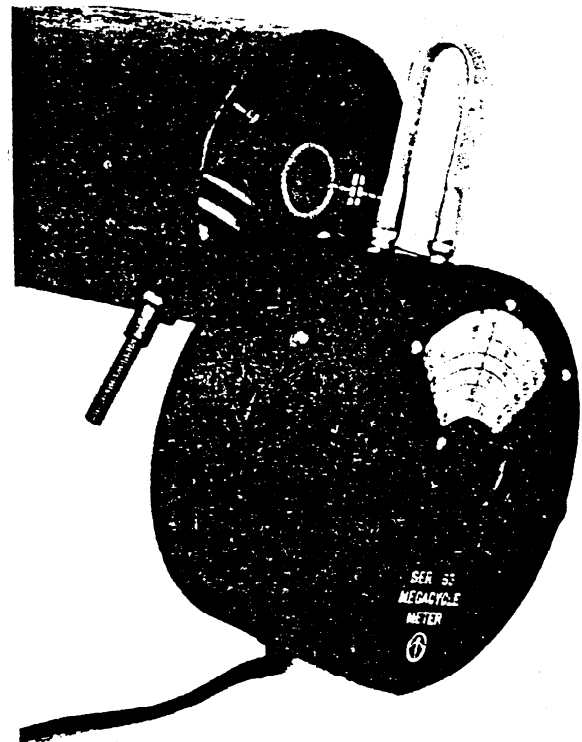

Figure 3 - USE OF CAPACITIVE COUPLING

This illustrates capacitive coupling to a quarter wave co-axial stub.

\*See Amateur's Handbook, 1947 Edition, Page 44.

#### d. Modulation:

Internal 120 cycle modulation can be applied by turning the switch to MOD. This may help identify the signal from the 59 in the presence of other signals when working on receivers, etc. External modulation can be applied by a standard phone plug in the jack marked "EXT. MOD.". About 20 volt (r.m.s.) are required for 30%.

#### e. Use of Phones:

Phones can be plugged into the PHONE jack for indication of the dip. A sharp click accom-

panies the dip in grid current for conventional application.

If indication of frequency of an oscillator is required, the phones will permit use as a high sensitivity oscillating detector with its resultant zero beat method of accurate frequency determination. For some types of "Q" measurement, this may be useful in measuring  $\Delta f$  (see Section V(d)). As a non-oscillating, diode detector (switch on DIODE) the identification of modulated signals, oscillator harmonics, sound of parasites of blocking character, etc. will be found very useful.

## SECTION II

### USE IN RECEIVER DESIGN AND ALIGNMENT

As a typical application of the Model 59, its use in the construction of a television receiver is presented herewith. This application involves the construction of video amplifiers with their peaking coils, low pass filters, high pass filters, bandpass filters, discriminators, traps, oscillators, etc.

#### a. Video Output Design:

In order to select a suitable peaking arrangement for the video amplifier the actual input and output capacitances should first be measured (as described in Section V(a).) with the Model 59.

Next by reference to a suitable handbook,\* a peaking circuit can be selected and the values of peaking coils calculated. These coils can be measured with the Model 59 (as described in Section V(b).) Their lowest self-resonant frequency can also be measured directly. It is desirable in most instances that this self-resonant frequency be considerably higher than the highest frequency to be transmitted through the video amplifier.

If carrier difference type of sound is desired, the circuit shown in Figure 4 may be useful. This utilizes series-shunt type of peaking with an inductively coupled 4.5 megacycle trap for sound take off. The 4.5 megacycle trap circuit should be resonated by means of the Model 59. The fm discriminator should be aligned by means of a sweep generator with the 59 serving as a trace

marker. This can be accomplished by merely coupling in the 59 to secure a beat note superimposed on the oscilloscope trace as shown in Figure 5. If a sweep generator is not available, the 59 can be used by fixing the coupling to  $L_2$  and  $L_3$  at a satisfactory value to permit taking a d.c. discriminator characteristic with the aid of a high resistance d.c. voltmeter (such as our Model 62). The secondary of the discriminator should be tuned for cross over at 4.5 megacycles, while the primary should be tuned for symmetry of the positive and negative peaks. If necessary, the coupling between the primary and secondary should be adjusted to separate the peaks by at least 200 kilocycles or more.

Figure 4 indicates the use of d.c. transmission with negative polarity input video signal as would be obtained from a detector shown in Figure 6. The use of this arrangement has several advantages: such as, economy of tubes since high level video of the correct polarity is available for sync clipping without extra tubes, no extra d.c. restorer and its time constant, absence of grid current in presence of strong signal, so that all interference is essentially black, etc.

#### b. Video Detector Filter Design:

Improved detection efficiency and overall stability can be obtained through the use of a simple "constant K" low pass filter between the

\*Terman's "Radio Engineer's Handbook", Page 420-2,  
Pink's "Principles of Television Engineering", page 227-8.



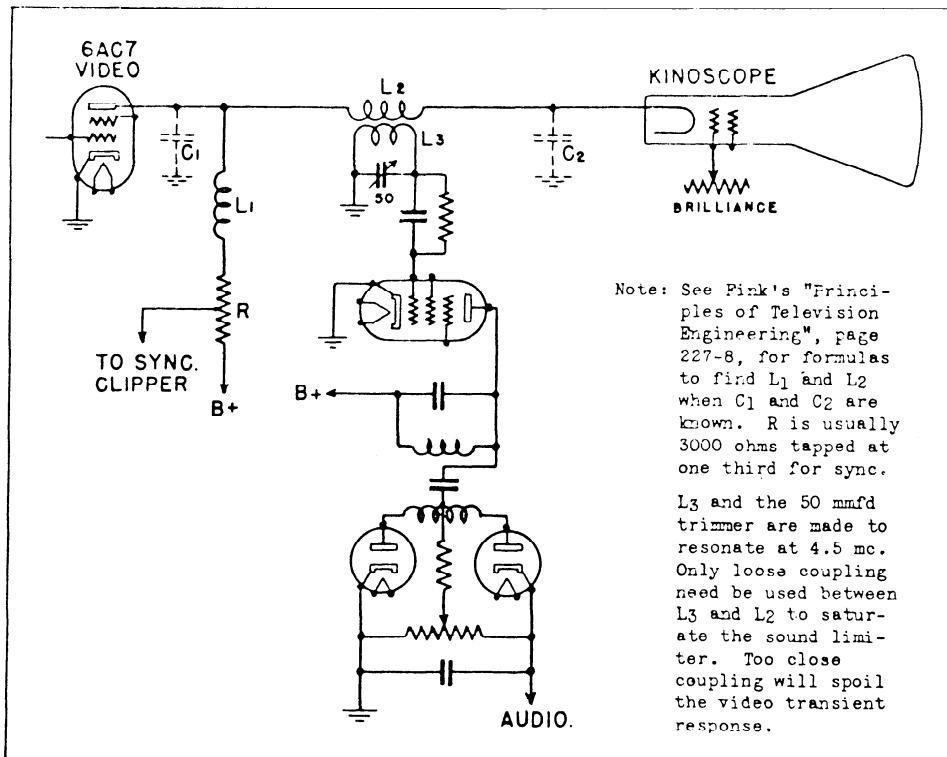

Figure 4 - TELEVISION VIDEO OUTPUT STAGE ARRANGED FOR CARRIER DIFFERENCE SOUND OUTPUT DISCRIMINATOR

video detector and the video amplifier stage as shown in Figure 6.\* The design of this filter involves first a determination of the input and output capacitances with the Model 59 (Section V(a);) then a calculation of the load resistance from the desired bandwidth.

An examination of the equations for this filter shows that the resonant frequency of the series coil in parallel with the sum of the input and output capacitances should be twice the cutoff frequency of the filter. This relation is quite useful in remembering the design formula for low pass filters; for thus, the product of  $L$  and  $C$  (inductance and capacitance) are determined. The other relation with regard to impedance level is given in Figure 6.

It is usually necessary to add about 5 mmfd. input capacity when using 1N34 type video detectors, in order to secure proper operation of the filter. The lowest self-resonant frequency of the series coil should be at least as high as the i.f. pass band in order to obtain good i.f. rejection. If the self-resonance does

\*See Terman's "Radio Engineer's Handbook", Page 228.

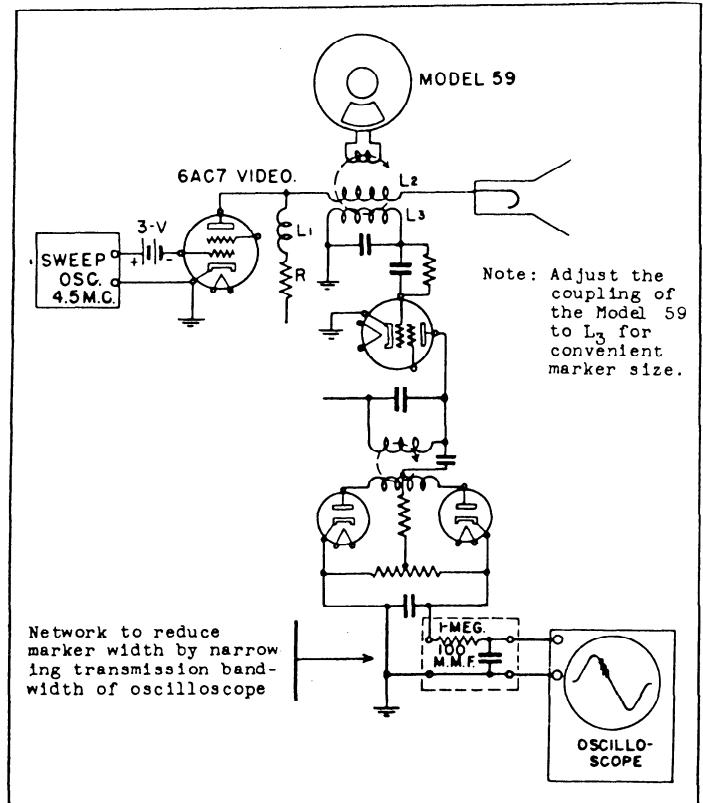

Figure 5 - USE OF MODEL 59 AS TRACE MARKER

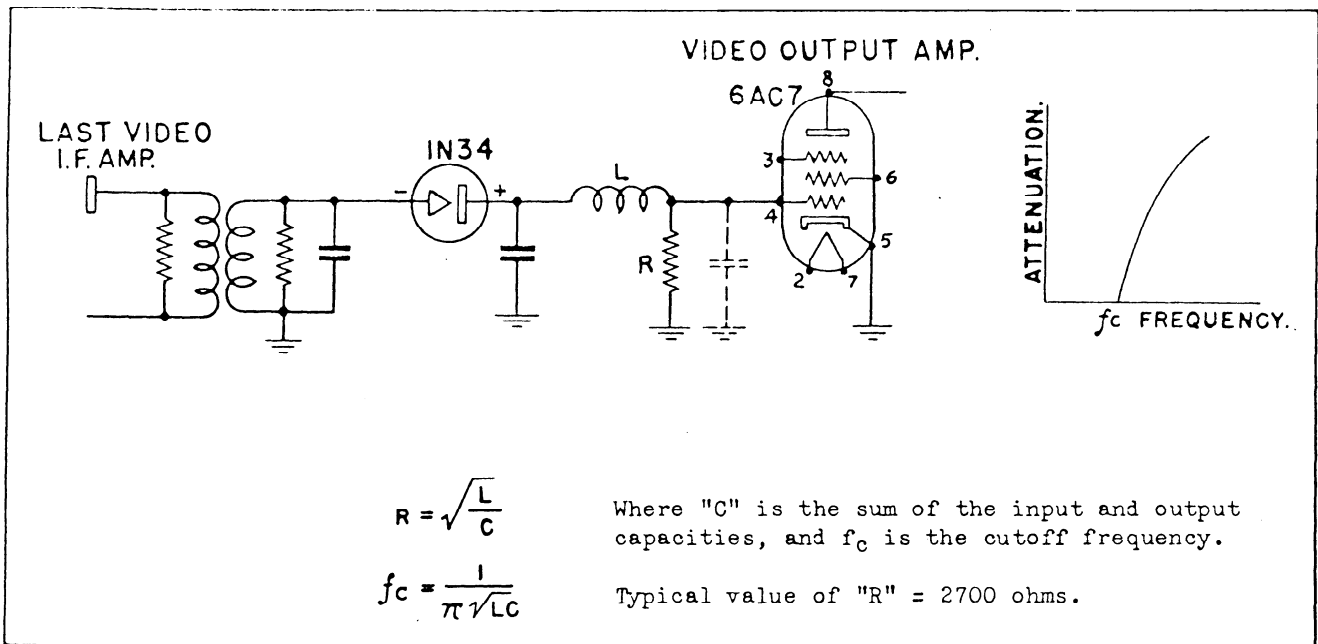

Figure 6 - VIDEO DETECTOR LOW PASS FILTER

occur at the i.f. frequency, a rejection peak will occur at this frequency. This type of filter then resembles the "m-derived" type rather than the simple "constant-k" as shown in Figure 6.

The video detector is polarized for negative output in order to operate properly with the single video stage shown in Figure 4. Obviously the detector polarity does not affect the operation of the filter, however.

c. Video I.F. Bandpass Amplifier Design and Alignment:

(1) Stagger tuned (single tuned circuit) amplifiers can be very successfully used for television i.f.'s; however, it has been pointed out by Wallman\* and others that the distribution of staggered frequencies and correct loading for each circuit can best be calculated by attention to minimum phase non-linearity. After the correct frequencies have been determined, each tuned circuit can be easily adjusted by means of the Model 59; then the correct load resistors can be placed across each circuit and the resultant combination checked for uniformity of amplitude response by

means of a sweep generator and the Model 59 as the sweep marker. Some sacrifice in stage gain results from the use of stagger tuned circuits. A hopeless phase characteristic will result, if choice of staggered frequencies and loading is based only on observation of the resultant amplitude response.

(2) Stagger tuned amplifiers can also be made by alternating single and double tuned circuits with proper choice of load and peak separation.\*\* Again the location of resonant frequencies can be determined by the Model 59, and the separation of the double tuned peaks can be adjusted by a temporary reduction in loading for more accurate indication on the Model 59.

(3) Double tuned circuit amplifiers† can be adjusted by first loading down one of the circuits and setting the unloaded circuit to approximately the correct center frequency; then loading it and removing the load from the other circuit to permit setting it to the correct center frequency also. Then both loads can be applied and the coupling increased, if necessary to secure proper bandwidth. The location and separation between peaks can be also measured with the 59. After loading and

\*Wallman, H., "Stagger Tuned I.F. Amplifiers", Radiation Laboratory Report #524, February, 1944.

Baum, R.F., "Design of Broad Band I.F. Amplifiers", Journal of Applied Physics, Volume 17, Pages 519-721.

Wright, A., "Television Receivers", RCA Review, March, 1947, Page 19.

\*\*Terman's "Radio Engineer's Handbook", Page 172.

†Terman's "Radio Engineer's Handbook", Pages 154-162.

Larsen, M.J. and Merrill, L.L., "Capacitance-Coupled Intermediate Frequency Amplifiers", Proceedings of the I.R.E., Page 71, January, 1947.

coupling adjustment has been completed, a slight retuning will usually be necessary. In checking such heavily loaded circuits, it is necessary to use rather tight coupling to the Model 59; this should be done in such a manner as to avoid seriously shifting the calibrated frequency of the 59.

(4) Triple tuned circuits and other types of i.f. band-pass amplifiers can usually be adjusted in a manner similar to that outlined above for double tuned circuits.

(5) Traps for sound rejection and adjacent channel rejection can be resonated to the correct frequency by the Model 59. Care should be taken not to couple too tightly to trap circuits, since their high "Q" will result in frequency reaction on the calibrated frequency of the Model 59. (This effect is sometimes referred to as "frequency pulling").

(6) Sound i.f. circuits can also be adjusted to the proper frequency, if the frequency difference method of sound detection is not to be used as previously mentioned under Section II c.(3) above. Overall i.f. sweep characteristics are usually checked with a suitable sweep generator. The Model 59 can be loosely coupled to the i.f. input and thus serve as a convenient beat type marker for accurate frequency identification.

d. Input Circuit Design and Alignment:

The Model 59 can be used to adjust the receiver local oscillator to the correct frequencies

(usually i.f. plus carrier). Then the carrier circuits can be adjusted to the correct carrier frequency, and the separation between peaks of the bandpass measured.

When grid mixing circuits are employed with too much coupling to the oscillator, some oscillator pulling will be apparent. The circuits should, of course, be adjusted with loose coupling, and the coupling then increased just sufficiently to produce saturation of the converter. Without the aid of the Model 59, it is possible to obtain rather misleading apparent increases in conversion gain when the carrier circuits are badly mistuned. Much valuable time can be saved by proper setting of the various circuits to the correct frequency first before use of the signal generator for final adjustment of coupling for optimum conversion gain.

Some input systems may utilize harmonic operation or push-pull input, parallel output converters, etc. All of these more complex circuit arrangements can be readily aligned with the aid of the Model 59. In many cases it is not necessary to apply plate voltage to the amplifiers, etc.; thus reducing the shock hazard when making connections and peeling turns. This also saves the usual wait for the tubes to warm up for test again between adjustments.

Some types of co-axial cavity tuned circuits may require a small capacity coupling or the use of link coupling because of their inherent shielded construction. Fortunately most of these

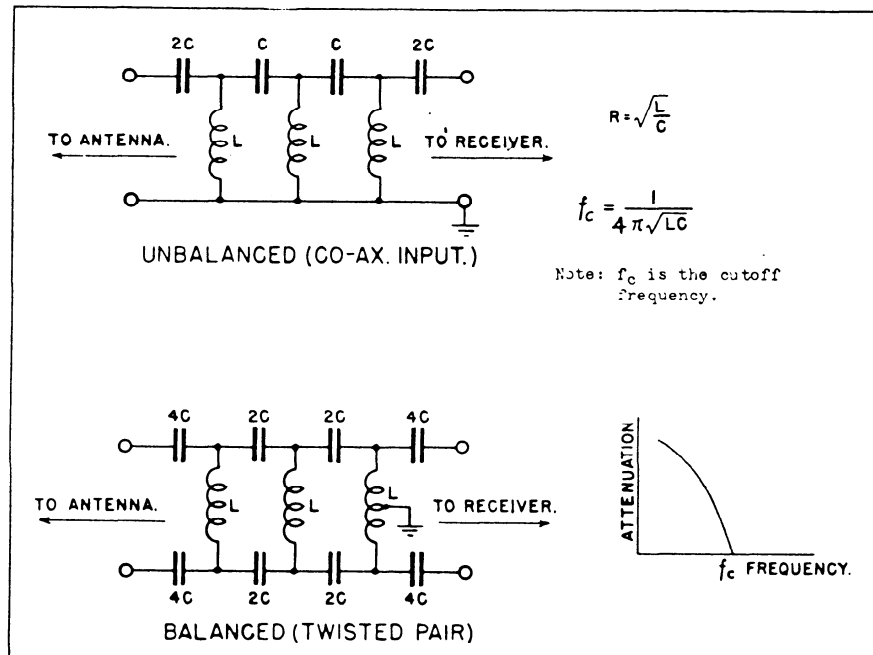

Figure 7 - HIGH PASS FILTER DESIGN

circuits are usually very high "Q" and require only slight coupling for adequate meter dip.

Since there may be many radio services operating in the i.f. pass-band of the average television receiver, it is frequently desirable to make use of auxiliary rejection filters to remove this interference from the picture. One of the simplest such filters consists of three or four "constant K" high pass sections between the transmission line and the input of the receiver.\* This type of filter is the inverse of that mentioned under Section II(b). An examination of the equations for the high pass filter shows that the resonant frequency of the shunt coil and series capacitance should be one half the cutoff frequency of the filter. Thus the product of L and C are determined, while the other relation with regard to impedance level can be obtained from Figure 7. The lowest self-resonant frequency of the shunt coil should be rather high, and the lowest series resonant frequency (as determined by shorting the coil) should be well above the carrier frequency range

to be transmitted. All these self-resonant frequencies can be determined by the Model 59. It will be found that simple spaced solenoids of small diameter or spiral wound coils will give low values of distributed capacitance with resultant high self-resonant frequencies. Some self-resonant frequencies will be found in a pie-wound r.f. coil which are independent of whether its terminals are open circuited or shorted, i.e. neither series or parallel resonances. These are internal resonances to be avoided in the operating frequency range for most applications in filters.

Of course, absorption type traps can be used to remove unwanted interference not in the carrier pass band of the receiver; and these can be adjusted approximately by the Megacycle Meter. A final exact adjustment for minimum interference under actual operating conditions will usually be helpful, since such a trap must be high Q to be effective, and thus necessarily somewhat critical of tuning.

### SECTION III

#### USE IN TRANSMITTER DESIGN AND ADJUSTMENT

The Model 59 offers considerable time saving and reduction of electrical shock hazard, since it is possible to make many transmitter measurements and adjustments with the power turned off. In the final power stages neutralization and pre-tuning by use of the Model 59 before application of plate power will reduce fireworks and damage to tubes.

##### a. Application to Audio Modulators:

Most modern audio amplifiers employ high mutual conductance triodes and pentodes. Long cabled leads, stray mutual coupling, etc. combine to produce undesired spurious oscillations out of the range of audibility. Sometimes these effects can be seen on an oscilloscope connected to the audio output, but often the frequency of spurious oscillation may be too high to be transmitted through the oscilloscope amplifiers. The Model 59 may be coupled to the output of the audio amplifier and used as an oscillating detector with a pair of headphones to locate the spurious oscillation by tuning slowly through the high frequency

spectrum. It may be necessary to apply a steady tone to the amplifier in order to produce the spurious oscillation.

These spurious oscillations can usually be eliminated by inserting a small non-inductive damping resistor of 10 to 100 ohms in the grid and plate leads of the offending tubes. In general, it is good practice to always use such resistors with high  $g_m$  tubes in audio amplifiers. Occasionally it may be necessary to put these damping resistors in the screen leads of beam tetrodes as well.

The oscillation can be localized by use of the Model 59 as an exploring probe to locate the region of most intense oscillation. The sensitivity of the Model 59 can be conveniently reduced, if necessary, by use in the non-oscillating or "DIODE" condition.

D.C. amplifiers sometimes used in voltage regulated power supplies, television transmitters, test equipment, etc. may exhibit erratic performance

\*"The Radio Amateur's Handbook", 1947, Pages 97-99.

which can be traced, through application of the Model 59, to spurious oscillation and remedied by proper application of damping resistors as pointed out above.

b. Use in Master Oscillator Stages:

The transmitter master oscillator circuit can be tuned up before power is applied by coupling the Megacycle Meter ("CW" position) to the oscillator "tank" circuit, then the Model 59 is tuned through the appropriate range until a maximum dip of the meter is found with as little coupling between the Megacycle Meter and oscillator tank circuit as possible. If the oscillator has two tuned circuits, such as the tuned-plate tuned-grid circuit, each circuit is tuned separately. When an electron coupled oscillator is used, and the plate circuit is operated on a harmonic, the plate circuit is readily tuned to the harmonic with the Megacycle Meter in the same way.

Crystal oscillator circuits are tuned in the same manner. After power is applied to the crystal oscillator, it may be necessary to slightly detune the crystal tank circuit for maximum stability\* in accordance with well known crystal requirements. Pierce crystal oscillator circuits will usually require application of power for proper adjustment.

c. Use in Tuning Buffer Amplifier Stages:

Interstage buffer amplifier circuits are tuned with the Model 59 in the "CW" position. All tubes should be connected in place. The tuning can be done with no power on the tubes. If double tuned circuits are used, the circuits should be tuned before coupling together or the circuit coupled to the one being tuned should be heavily loaded so that its tuning is very broad and it does not affect the tuning of the circuit under test very much.

Tuning the amplifier interstage coupling circuits with power off is an approximate method. When the amplifier tube is put in operation the capacitance of the grid circuit may change from that of the "power off" condition. Slight retuning may be necessary, depending on the relation of the change in capacitance to the total capacitance of the circuit and also depending on the Q of the circuit, or broadness of tuning.

Harmonic amplifiers can also be readily adjusted by use of the Model 59 prior to the application of power. After application of power,

the Model 59 can be used as a wavemeter in the non-oscillating condition marked "DIODE" to adjust grid drive and other circuit parameters (such as bias, screen voltage, etc.) for maximum harmonic frequency output.

If the buffer amplifier is to work into an appreciable load, optimum coupling to the load can be determined when the "DIODE" reading drops to one half on connection of the load. Of course, it will be necessary to keep the coupling of the Model 59 to the output tank constant during the determination of this optimum half voltage loading adjustment. NOTE: The meter adjustment knob should be set all of the way to the right (clockwise), and coupling of the Model 59 to the amplifier tank loosened, if necessary to keep the meter on scale; otherwise the meter bucking circuit will spoil accurate determination of the half voltage point. NOTE: Either pure mutual inductance or pure capacitance coupling, must be used. A combination of both will yield erroneous results.

d. Final Power Amplifier Tuning:

The final power amplifier can be tuned without application of power as suggested above under Section III(c). If necessary (as in triodes), neutralization can be effected through the proper use of the Model 59 as outlined below in Section III(e).

Determination of optimum output loading can be made by the use of the Model 59 for half voltage determination as suggested above in Section III(c), except that more care is required in retuning after connection of antenna load, since most antenna circuits will exhibit some reactive component which must be tuned out.

CAUTION:

On high power transmitters, care must be taken not to damage the Model 59 by coupling too closely when full plate power is applied. If any doubt exists as to the possibility of damage, it is well to either remove the instrument from the immediate vicinity or detune the 59 sufficiently when power is applied for the first time.

Caution must be exercised to avoid accidental contact with high voltage parts of the circuit during "hot" measurements. Fortunately the sensitivity of the Model 59 is sufficient to permit ample distance separation in most normal transmitter circuits. If close coupling is necessary, a sheet of polystyrene or other suitable insulation

\* "The Radio Amateur's Handbook", 1947, Pages 97-99.

should be kept as a guard between "hot" circuits and the Model 59 probe assembly.

The Model 59 can be used to indicate the harmonic or sub-harmonic content present in the output of the transmitter by simply tuning to the various possible frequencies and comparing the "DIODE" readings, while keeping the coupling constant. The presence of appreciable harmonics not only represents a waste of power, but a nuisance to other services and a violation of the law. Suitable filters\* should be installed between the transmitter and the antenna to remove these extraneous frequencies. The effectiveness of such filters can be checked, if sufficient power is available, by proper use of the Model 59 when

bandwidth (in the case of broadband circuits). There are several methods of using the Model 59 to indicate neutralization of the various stages in a transmitter. Figure 8 illustrates the reaction method which is useful where it is dangerous or impractical to apply driver power to the stage to be neutralized, as is required in the method of Figure 9.

Feedback can occur in many ways, but the one most frequently encountered (in properly constructed circuits) occurs in the internal plate to grid capacitance of triode type amplifiers.\*\* Most tetrode and pentode type tubes of proper design in suitable circuits should not require neutralization.†

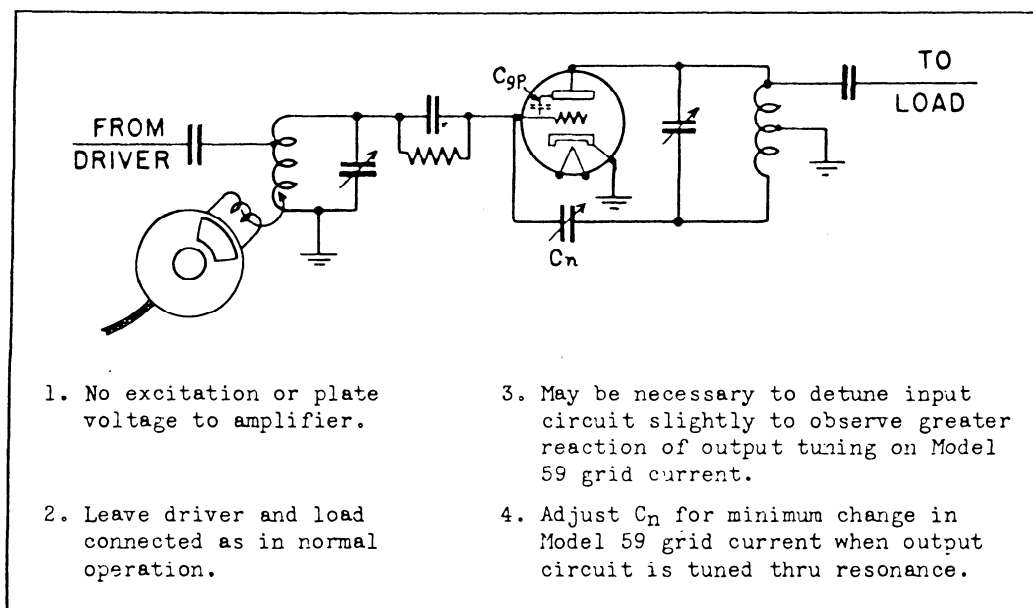

Figure 8 - REACTION METHOD OF NEUTRALIZATION  
(Model 59 in "CW" Position)

coupled to the antenna. Care should be exercised not to couple too closely and damage the instrument. Readings taken at the harmonic frequencies with and without the filters in place will indicate their relative effectiveness. Of course the power input to the final should remain about the same, and the coupling of the Model 59 to the antenna should be constant during the tests.

#### e. Neutralization:

The purpose of neutralization is to prevent feedback in an amplifier which would tend to produce oscillation or instability in gain or

There are various well known methods for neutralizing or balancing out the undesirable coupling between plate and grid circuits.\*\* In general it can be seen that when the tube is not operating, it should not be possible to transfer energy from the input to the output circuit or vice versa. The procedure in the case of the method of Figure 8 is to first tune the input and output circuits to the proper frequency with the neutralizing control set for minimum; then slightly detune the input circuit and couple the megacycle meter to this circuit, until only a slight decrease in grid current ("CW") remains when the Model 59 is set to the frequency of the output

\*Grammer, George, "Keeping Your Harmonics at Home" Q.S.T., Nov. 1946, Pages 13-19.

\*\*"The Radio Amateur's Handbook", 1947, Pages 101-104.

†Mix, Donald, "Operating the 807", Q.S.T., May, 1946, Page 53. "No Neutralization Required", Q.S.T., June, 1946, Page 48.

circuit (the proper operating frequency). Then swing the output tuning through resonance and note the reaction on the grid current. Next slowly increase the neutralizing control while the output tuning is swung back and forth through resonance. It will probably be necessary to couple more closely to the input circuit after a rough adjustment of the neutralization has been made to obtain improved indication sensitivity on the Model 59. It may also be necessary to further detune the input circuit when this is done. After finding the setting which reduces the reaction to a minimum retune the input circuit with the aid of the Model 59 and the amplifier should be well enough neutralized to prevent self-oscillation. For more complete neutralization it may be necessary to use the method of Figure 9.

In Figure 9, driving power to the amplifier stage to be neutralized is applied, and the Model 59 is employed in the "DIODE" position as a tuned detector to indicate the presence of signal in the output circuit. Of course no plate voltage is applied to the amplifier, so that any driving power present in the output is presumably there as a result of grid plate capacity of the amplifier tube. Obviously, poor circuit layout and lack of shielding will also contribute to coupling between these two circuits with resultant difficulty of complete neutralization.

There is some interaction of plate tuning and adjustment of the neutralizing capacitor in Figure 9. It is necessary to retune the plate tank for maximum and then readjust the neutralizing control for another minimum. It may be necessary to couple the Model 59 more closely to the output circuit for greater sensitivity of indication after partial neutralization has been completed.

#### f. Parasitics:

If the circuit conditions in an r.f. oscillator or amplifier are such that self-oscillation

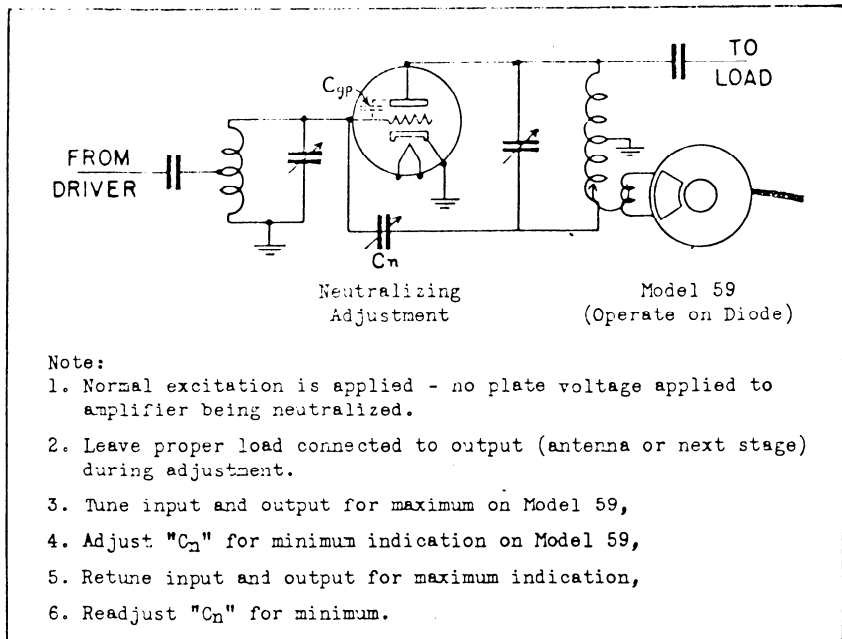

Figure 9 - TRANSMISSION METHOD OF NEUTRALIZATION

exists at some frequency other than that desired, the spurious oscillation is termed a parasitic.<sup>\*</sup> Such spurious effects in audio modulators have been previously mentioned in Section III (a) above.

If parasitics are present, the Model 59 can be used as a tuned detector to detect their approximate frequency by the use of headphones or "diode" current indications. After their approximate frequency has been located (usually non-harmonically related to the desired frequency), the power to the amplifier or oscillator can be turned off, and the Model 59 used as a grid dip meter to locate the exact tuned circuit causing the parasitic. The points of maximum current absorption (inductive coupling) are places where a small resistor can be inserted in series to damp out the parasitic. Or if series damping is not feasible, the points of maximum voltage absorption (capacitive coupling) are places where a high resistance can be shunted across to damp out the parasitic.

\* "The Radio Amateur's Handbook," 1947 Edition, Pages 110-112.

## SECTION IV

### USE IN ANTENNA ADJUSTMENT

Since most antennas are relatively high "Q" circuits with distributed constants, only very loose coupling to the Model 59 need be used. It will be necessary to couple inductively to the current maxima or capacitively to the voltage maxima.

Most antennas have harmonic mode responses which can also be located and measured by the Model 59. Both harmonic and fundamental frequency measurements can be made with the switch in the "CW" position, and no power applied to the antenna under test. This lessens the possibility of interference to others during antenna adjustment.

The shift of antenna resonant frequency with addition of reflectors and directors can be observed with the Model 59. Loading coils and other shortening devices can also be adjusted with the Model 59.

The Model 59 can be used as a field strength indicator in the "DIODE" position, and when placed at a suitable distance from transmitter antenna arrays, it can be used to indicate proper adjustment of the array spacing for maximum output signal. Alternatively it can be used as a signal source (in the "MOD" position) for the adjustment

of antenna arrays with the aid of a receiver as a signal strength indicator connected to the antenna.

The Model 59 can be used to determine whether a transmission line is properly matched at a particular frequency, by operating in the "DIODE" position and coupling to the transmission line as shown in Figure 10. Sufficient coupling should be used for a reliable reading with power applied to the transmission line, then the coupling should be held constant as the Model 59 probe is moved at least 1/4 wavelength along the line. If no appreciable variation in indication can be noticed, the line does not have standing waves and is correctly terminated at that particular frequency.

The above method cannot be applied to coaxial lines; hence it is usually customary to adjust the load and matching network for maximum output; since under conditions of maximum output, the line must be matched. For determining maximum output the Model 59 can be used in the "DIODE" condition as a field strength indicator suitably coupled to the radiating antenna.

Matching stubs can be pre-adjusted to the proper frequency by observation of their resonant frequency with the aid of the Model 59. Quarter-wave stubs should be shorted at one end and coupled inductively to the Model 59. (See Figure 11) It will be possible to locate several odd-harmonic modes also.

Half wave stubs should be left open and inductive coupling to their center utilized for checking natural resonance. For coaxial half wave stubs capacitive coupling to one end can be used. In this case several even harmonic modes may also be located.

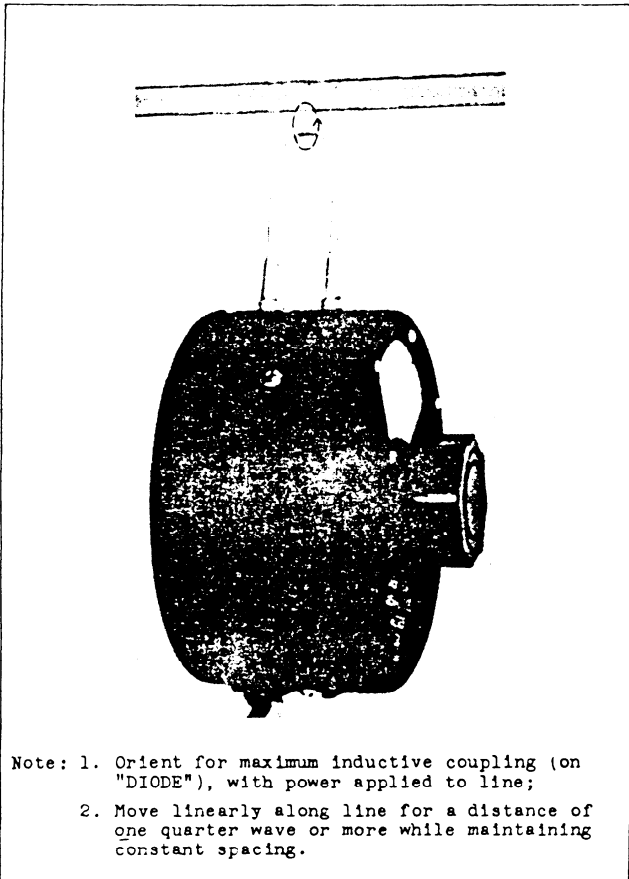

Figure 10 - CHECKING FOR STANDING WAVES ON TRANSMISSION LINES

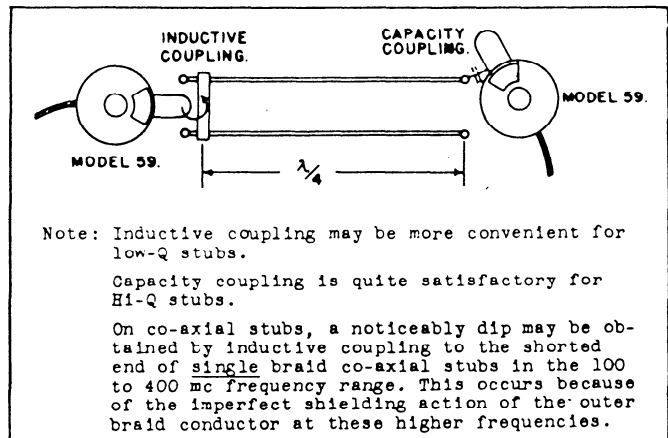

Figure 11 - COUPLING TO QUARTER-WAVE STUBS



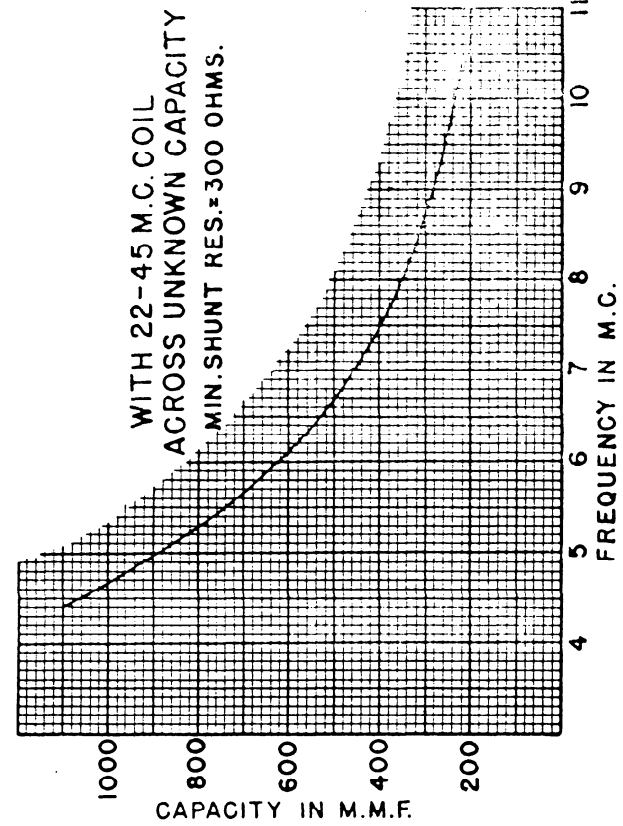
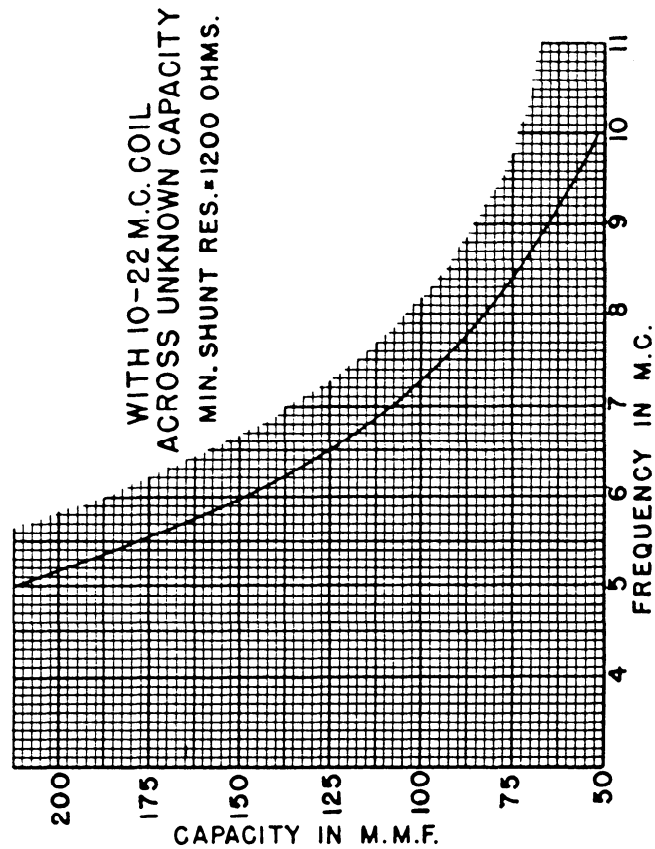
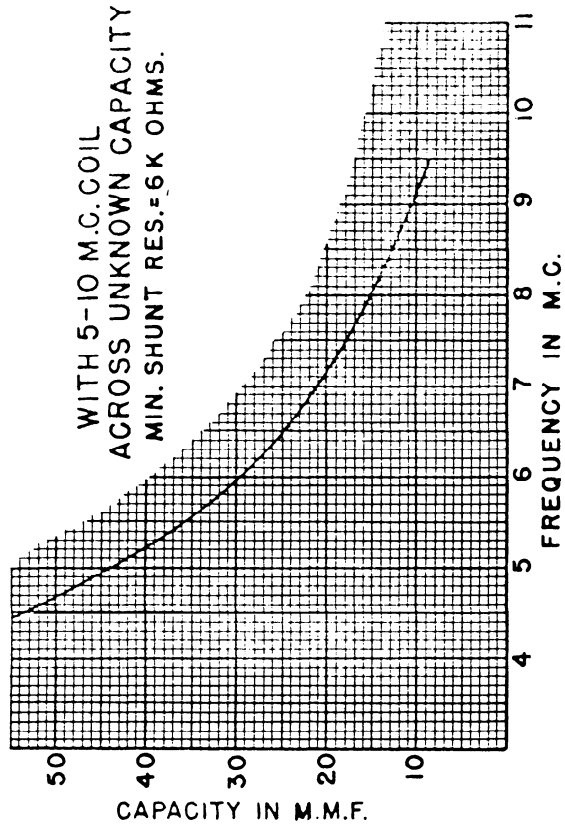
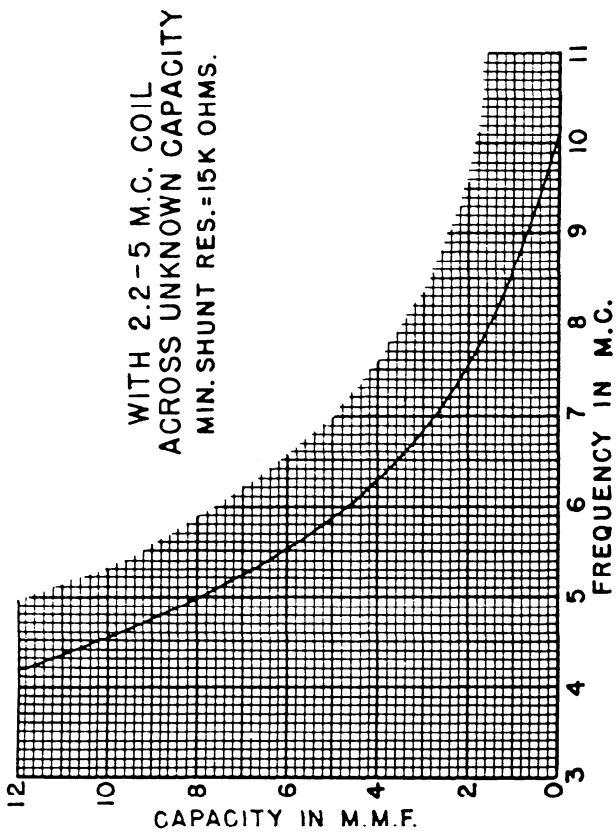

Figure 12 - CAPACITANCE CHART

## SECTION V

### MEASUREMENT OF C, L, M, AND Q

#### a. Measurement of Capacitance:

The Model 59 can be used for measuring capacitance, if a standard inductance is available. The coils of the 59 can be used as standards, and reference to Figure 12 indicates directly the shunt capacity which must be used to resonate each coil to a particular frequency. In order to measure capacitances between 10 mmfd. and 50 mmfd., it will be necessary to purchase a spare 5 to 10 mc. coil. Figure 13 shows the use of standard Mueller #60CS clips and one of the Model 59 coils in the measurement of input capacitance of a vacuum tube and its associated socket.

NOTE: Some circuits may involve capacitance shunted by resistance; therefore the approximate minimum permissible shunt resistance for each coil is indicated on Figure 12. Higher values of shunt resistance will permit more accurate measurements.

In the case of large capacitances in the range of 200 to 1000 mmfd., it may be necessary to take precautions in securing good contact and thus

avoid high series resistance, which would have the same detrimental effect on accuracy of indication as low shunt resistance. It is also well to bear in mind the possibility of internal series inductance of the capacitor under test. This internal inductance may alter the apparent capacitance considerably.

#### b. Measurement of Inductance:

The Model 59 can be used for the measurement of inductance with the aid of a standard capacitor. Close tolerance silver mica and ceramic capacitors are generally available over a wide range of values. Only the small units should be used to reduce the self inductance of the capacitor standard. If necessary, the value of unknown capacitors can be determined as outlined above in Section V(a) so that they can be used as standards for the measurement of inductance. It is well to avoid the use of large air dielectric type capacitors because of their high inherent self inductance.

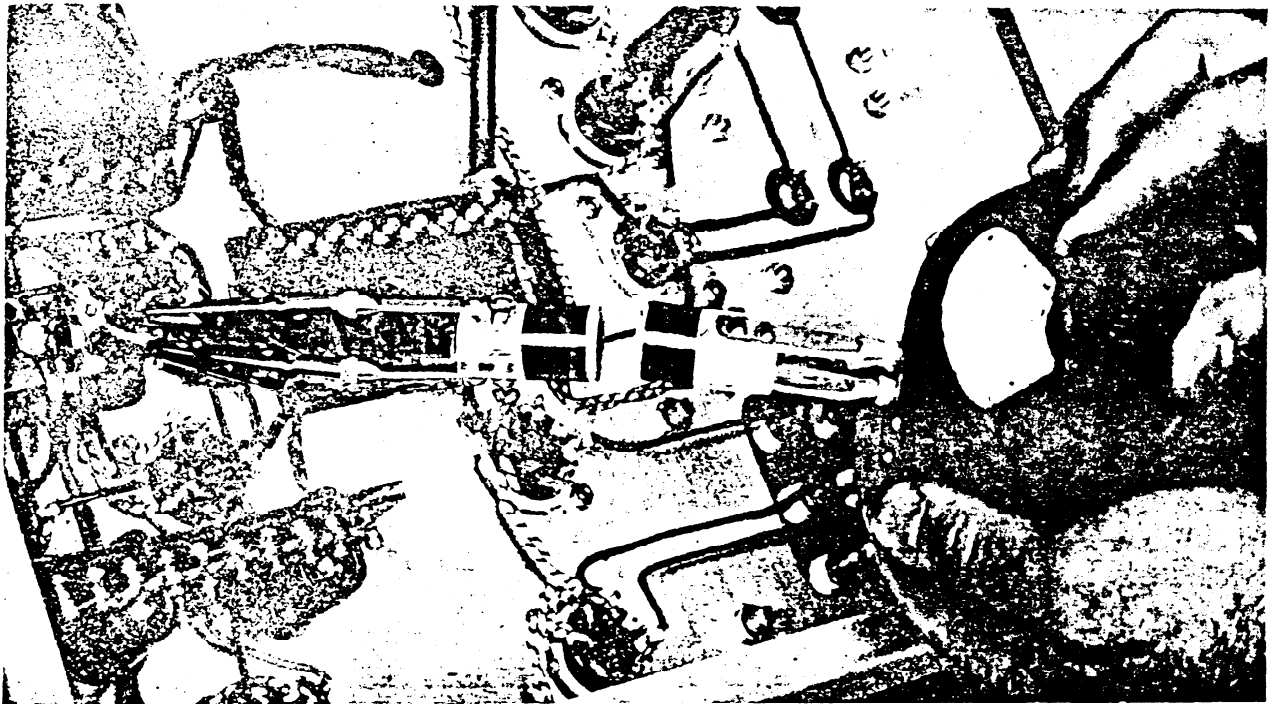

Note: Use of the Mueller #60CS Clips (illustrated) will add about one mmfd to the minimum circuit capacitance of the coil; therefore one mmfd should be subtracted from that value read opposite the resonant frequency of the chart, Figure 12.

Figure 13 - MEASUREMENT OF CAPACITANCE

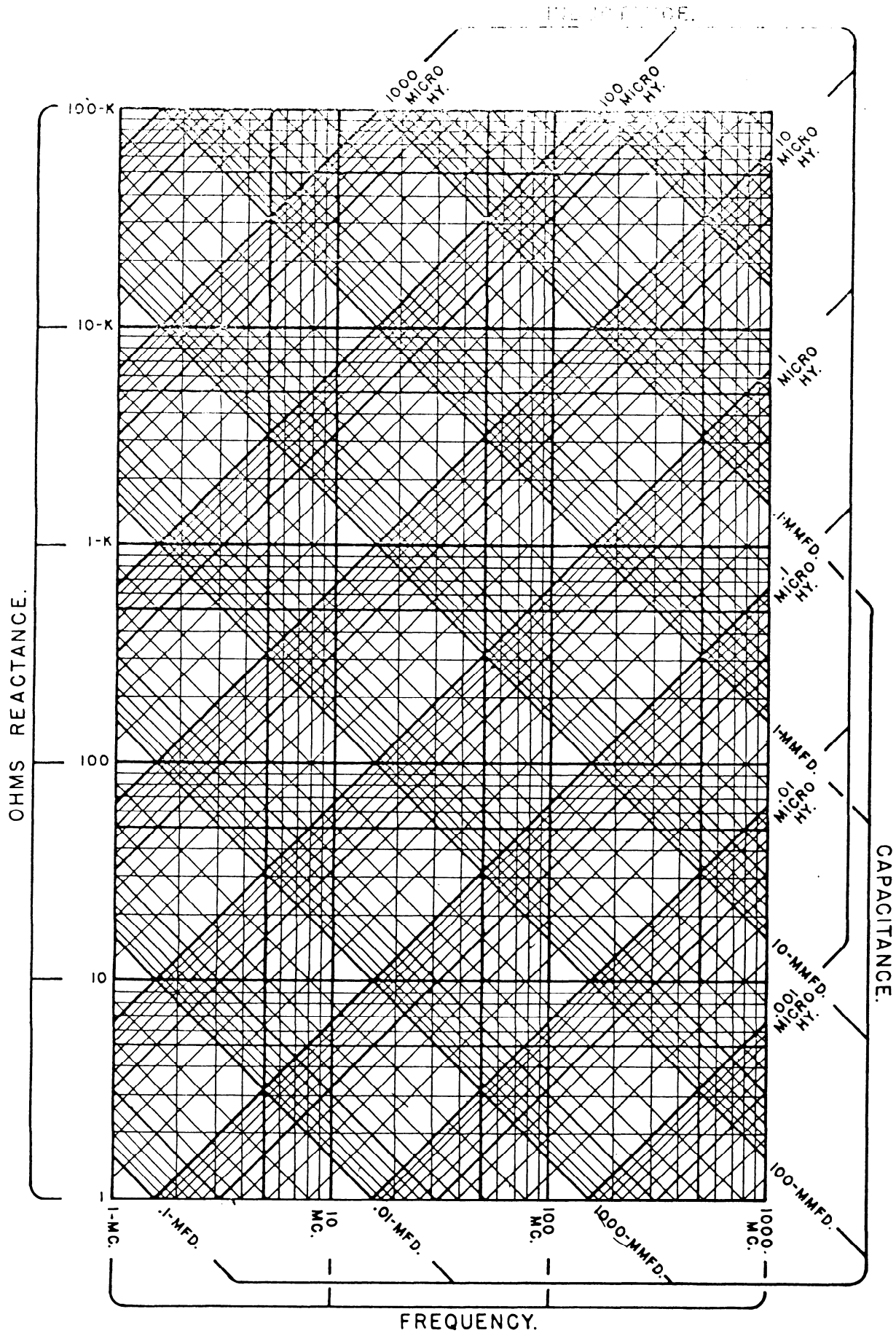

Figure 14 - REACTANCE - FREQUENCY CHART

It is necessary to connect the inductor to be measured to the standard capacitor with the shortest possible leads and measure the resultant resonant frequency with the Model 59 as a grid dip meter. Then the actual total circuit inductance can be read from the chart of Figure 14. For maximum accuracy the inductor should be replaced with a short copper strap (about 1/2 inch wide) and the new resonant frequency of this combination determined with the Model 59. Then find the inductance of this latter combination from the chart of Figure 14 and subtract this value from that previously measured. The difference is the true inductance of the inductor.

Since the presence of shields, tuning slugs, etc. may seriously affect the value of an inductor which is to be measured, it may be necessary to leave the coil in place for measurement. In this case, it will be necessary to disconnect any tuning capacitor, tubes, and other capacitors associated with the coil to be measured, before connecting the standard capacitor across the inductor.

c. Measurement of Mutual Inductance:

Mutual inductance of two coils can be measured by first connecting the coils in series aiding and measuring the resultant inductance as described above in Section V(b), and then connecting the two coils in series bucking and again measuring the resultant inductance. The difference in inductance divided by four is the mutual inductance.\*

Figure 15 outlines the above procedure step by step. The use of the Model 59 permits mutual inductance measurements to be made near the actual operating frequencies. In some circuits this may be of considerable advantage over lower frequency measurements. Lower values of mutual inductance can be measured with the Model 59 than those possible on most low frequency bridges.

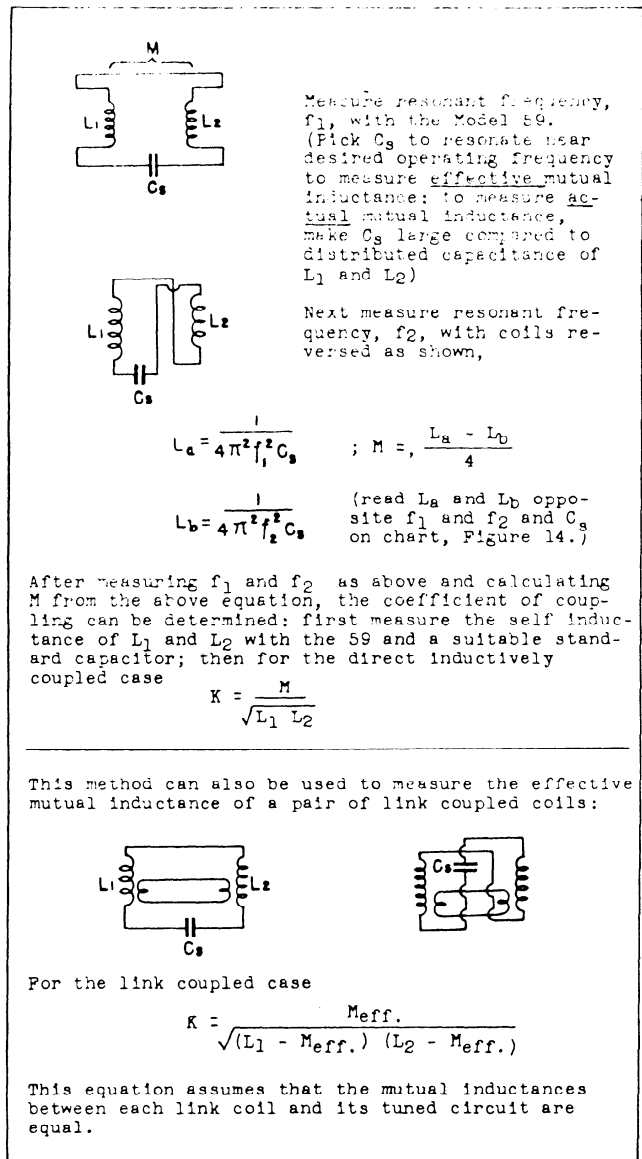

Figure 15  
MEASUREMENT OF MUTUAL INDUCTANCE

\*Henney, "The Radio Engineering Handbook", Page 97.

d. Measurement of Q:

The Q of a tuned circuit is a measure of its figure of merit. It is defined variously as the ratio of energy stored to energy lost per cycle; the ratio of shunt resonant to series resonant induced voltage; the measure of the selectivity of a tuned circuit at 0.707 down from resonance, etc.\*

Frequently one also speaks of the Q of a coil or a capacitor. This is merely the reciprocal of the power factor (for values larger than 10) or dissipation factor.†

A relative measurement of "Q" can be made by observing the sharpness of the dip in grid current when the Model 59 is tuned through resonance. This procedure is very simple and speedy in applications where an approximate determination of "Q" by the comparative method is sufficient.

At the higher frequencies it becomes difficult to separate the inductive and capacitive components of a circuit. Therefore a method of measuring circuit Q is shown in Figure 16A by measuring the selectivity of a tuned circuit. Alternate methods of reducing error due to vacuum tube voltmeter input loading are shown in Figures 16B and 16C. This measurement requires the use of auxiliary equipment which can be simply constructed, since only relative calibration of amplitude is required of the vacuum tube voltmeter. In some cases the circuit will have associated with it a vacuum tube amplifier which can itself be made to function as a voltmeter by suitable biasing of its grid circuit and the insertion of a meter for reading d.c. plate current. Its relative calibration can be made at audio frequency if necessary.

For high Q circuits it may be difficult to read the bandwidth closely enough on the tuning dial of the Model 59. In this case an auxiliary unit such as a frequency meter may be used for accurate measurement of the two ".71" frequencies.

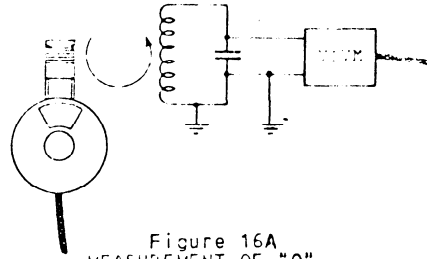
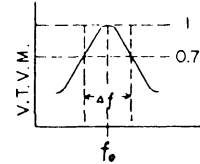

Figure 16A  
MEASUREMENT OF "Q"

- (1) Set coupling loosely for a convenient reading on V.T.V.M. at resonance, and fix it at this value.
- (2) Determine the bandwidth at the .71 response,
- (3) then;



$$\frac{f_0}{\Delta f} = Q$$

Note: The effects of VTVM input loading can be reduced by tapping down on the coil. The reduction in loading will vary as the square of the turns ratio of the tap; whereas the magnitude of the voltage will vary linearly with the ratio.

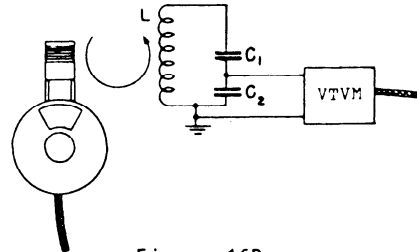

Figure 16B  
REDUCTION OF VTVM LOADING BY  
CAPACITY DIVIDER

$$\frac{C_1 C_2}{C_1 + C_2} \quad \text{To resonate with L at desired frequency.}$$

$$\frac{\text{Tap impedance to ground}}{\text{Anti-resonant impedance of circuit}} = \left( \frac{C_1}{C_1 + C_2} \right)^2$$

Choose  $C_1$  and  $C_2$  such that the voltmeter input resistance is very large compared to the tap impedance. For example,

$$\frac{C_1}{C_2} = 0.1$$

will give a "Q" error of less than 1%.

**WARNING!**  $C_2$  must have very low effective series resistance in order not to alter the "Q" of the measuring circuit.

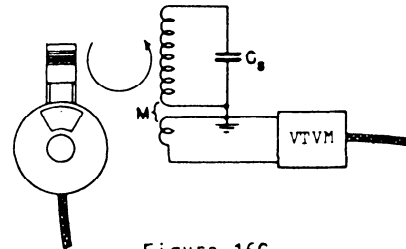

Figure 16C  
REDUCTION OF VTVM LOADING BY  
INDUCTIVE COUPLING

$C$  to resonate with  $L$  at desired frequency. Keep "M" as small as possible and still get adequate meter deflection.

Figure 16 - MEASUREMENT OF "Q"

\*"Radio Amateur's Handbook", 1947, Pages 42-48.

†"Radio Amateur's Handbook", 1947, Page 32.

## SECTION VI

### SERVICE AND MAINTENANCE

#### a. Replacement of Tubes:

The vacuum tubes in the Model 59 are conservatively operated and should provide long service life unless the instrument is abused by rough handling. After several hundred hours of operation; however, the 955 oscillator tube may show signs of reduced output by lower readings of grid current on the highest frequency coil. When this occurs it may be necessary to replace the 955 in the probe.

To replace the 955, remove the tuning knob and the three screws around the edge of the probe assembly. Then lift the dial cover from the probe; thus exposing the calibrated tuning dial, etc. Next remove this calibrated dial, taking care not to touch and smear the calibration numbers. (This dial should be kept face up and covered during the time it remains out of the probe to prevent damage). The cathode clip must be slipped loose radially first. The 955 can then be removed by a slight twisting, counter-clockwise motion, after disengaging the cathode clip. Next insert the new 955 and twist slightly into place. Take care to see that all four pins line up properly. DO NOT FORCE into place. Forcing is not necessary, if the radial tube pins are properly lined up with their respective clips; application of excessive force will probably damage the alignment of the tuning condenser. After twisting the new tube into place properly, slide the cathode (center pin) contact clip into place. Next replace the tuning dial and three mounting screws, again exercising care not to smear the printed numbers. Replace the dial cover and knob and leave the three cover screws slightly loose, so that it will be possible to rotate the dial cover (permitted by the three slots around the fastening screws). Turn the tuning knob as far as it will go clockwise and adjust the position of the fiducial so that it falls over the long end mark on the dial. Tighten the three case screws.

Using an accurate frequency meter, crystal oscillator, transmitter or other suitable frequency source, the Model 59 minimum tuning capacity must be adjusted to correct for any difference in the new tube capacity. This adjustment should be made at the high end of any medium frequency band. Five megacycles on the 2.2 to 5 Mc. band might be set against WWV for example. Allow the Model 59 at least five minutes to warm up before making

any frequency adjustments. Set the Model 59 on the 5 Mc. mark on the lowest band and adjust the trimmer, for zero beat. See Figure 17.

During the above procedure, care should be exercised to prevent placing the probe and oscillator coil too close to any metal object which might seriously affect the frequency of the oscillator. It is not necessary to couple closely to the receiver or frequency meter for zero beat against the standard frequency source.

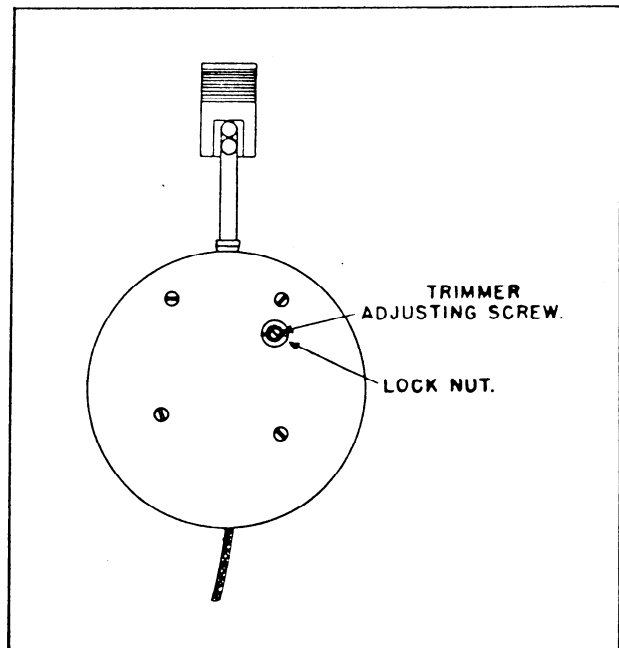

Figure 17 - ADJUSTMENT OF TRIMMER

Replacement of the rectifier and voltage regulator tube will seldom be required. Aged regulator tubes sometimes become erratic and their output voltage will fluctuate, resulting in erratic grid current. Occasionally new regulator tubes may also be erratic. Any tube which exhibits jitter or unstable operation should be replaced.

#### b. Circuit Failure:

Most circuit failures will be evident from indications of the grid current meter and reference to the schematic diagram, Figure 18. Failure to oscillate will usually result, if the probe has been dropped and one of the ceramic variable tuning capacitor supports has been broken. It is advisable

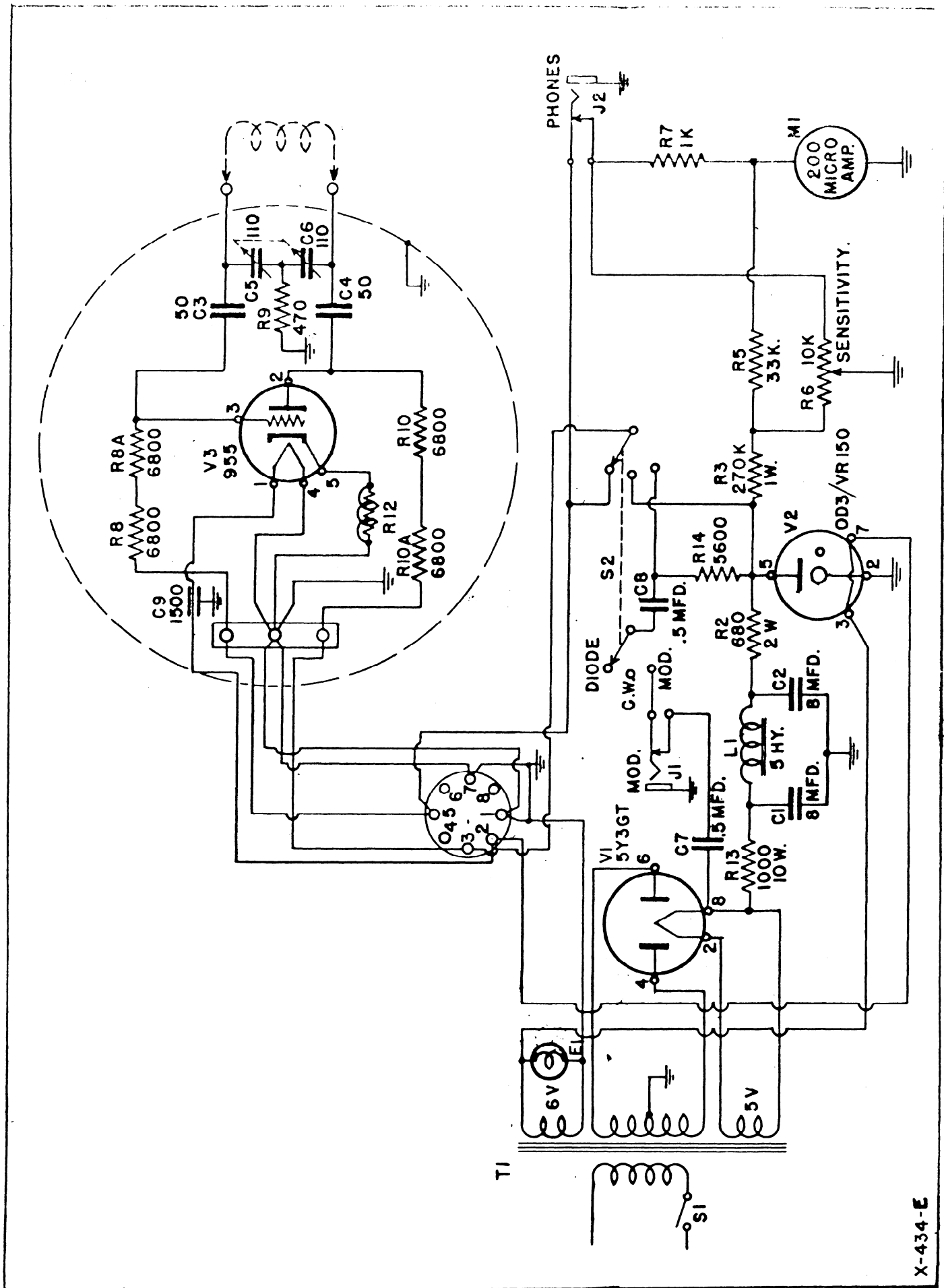

FIG. 18 - SCHEMATIC DIAGRAM.

X-434-E

to return the instrument to the factory for repair in this event. Replacement of the ceramic is a major repair and will require re-calibration of the frequency dial. If return is not possible, after replacement of the ceramic support, it will be necessary to center the stator approximately and then set the frequency calibration as closely as possible by the following process. Put the lowest frequency coil in position (with the serial numbered side up toward the tuning dial side of the probe). Be sure it is fully inserted or bottomed in the jacks. Then allow about 5 minutes for the instrument to warm up. Rotate the tuning dial until it reads approximately 5 mc. and locate exact zero beat note with WWV. Then turn dial down to 2.5 mc. and note displacement of beat note from the calibration mark. Rotate cover and fiducial to registration, if the displacement is about the same as at 5 mc. If the amount is more or less than that at 5 mc., split the difference by rotating the cover and fiducial. Tighten one of the three screws so this adjustment will not slip. Then turn dial up to exactly 5 mc. and adjust screw as shown in Figure 17 for zero beat with WWV in the receiver or frequency meter. Lock this trimmer screw and recheck the 2.5 m.c. point.

A slight readjustment of the dial cover and fiducial may be required. Then recheck the 5 mc. point again and reset with the trimmer if necessary. Then lock the trimmer lock nut and the calibration should now check as well over the entire range as it can be made to check under the circumstances. This is a tedious operation and should only be attempted in an emergency by someone familiar with the alignment of gang condensers and the tracking of dial scales.

A damaged coil can be ascertained by visual inspection and use of an ohmmeter. Close mechanical manufacturing limits are maintained for the coils used with the Model 59, but re-calibration is always recommended when coil replacement is necessary. This re-calibration is best done at the factory where specialized equipment is available for this purpose.

A damaged meter can be temporarily replaced with any suitable ~~500~~<sup>200</sup> microampere movement. It is suggested that a defective meter be returned for replacement. Any other failures should be reported to us promptly, since our study of such defects is helpful in the improvement of our instruments.

## SECTION VII

### ACCURACY

Maximum accuracy of frequency calibration can be secured by placing the coil into position with the serial numbered side up toward the tuning dial side of the probe. On the highest frequency coil a red dot is used to identify the upper side, since it is not feasible to stamp the serial number there. It is always well to see that the coil is fully bottomed in the contact posts. If the probe dial cover has been removed, the frequency calibration should be rechecked as outlined above in Section VI(a). Under favorable conditions (loose coupling, etc.) the frequency accuracy of the Model 59 should be within 2%. Replacement of oscillator tubes or damage of the coils, of course, will alter the above accuracy.

Maximum accuracy of frequency measurement is dependent to some extent upon the Q of the circuit under test. The more tightly the Model 59 has to be coupled to a circuit, the greater the pulling of frequency, etc. When checking frequency of an oscillating circuit, the use of headphones and the Model 59 as an oscillating detector is recommended for greater accuracy. This method can also be used together with an accurate frequency meter for accurate setting of the Model 59 to a particular frequency. Use of the Model 59 as an oscillating detector permits loose coupling to the oscillating circuit under test.

Accuracy of capacitance determination depends on Q and on accuracy of the coil standards. Under most conditions capacitance measurements should be reliable to within 10%. Under favorable conditions, it is possible to measure to 5% with the technique outlined in Figure 13.

Accuracy of inductance measurement depends on the accuracy of the capacitance standard and proper correction for lead inductance as outlined in Section V(b). Mutual inductance measurements depend for accuracy on the difference between two inductance measurements.

The accuracy of Q measurement depends on the relative calibration of the auxiliary vacuum tube voltmeter and the accurate measurement of the frequency increment ( $\Delta f$ ). The use of a frequency meter or audio oscillator and beat note methods will greatly improve the overall accuracy. It is possible to measure actual circuit Q under operating conditions, something which is rather important at high frequencies, because of dynamic input loading, etc.

And last of all the Model 59, like a fine watch, must be handled with some care. The probe and the coils must not be dropped or given rough treatment, if the accuracy of the original factory calibration is to be preserved.



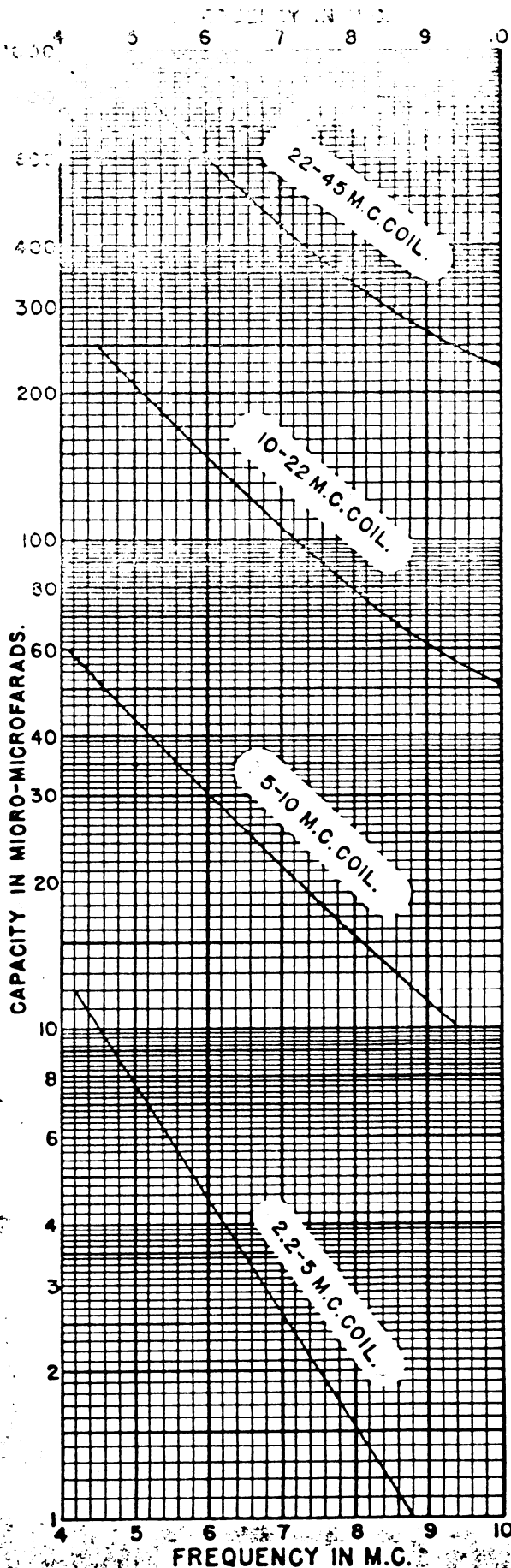

with Model 59 Megacycle Meter

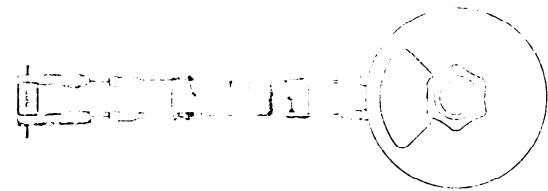

The coils of the Model 59 can be used as standards; reference to chart indicates directly the shunt capacity necessary to resonate each coil to a particular frequency.

To measure capacitance between 10 mmfd and 50 mmfd it is necessary to purchase a spare 5 mc to 10 mc coil.

Use of Mueller No. 60CS clips (illustrated) will add approximately 1 mmfd, therefore 1 mmfd should be subtracted from capacitance shown on chart.

Capacitance chart applies only to compact capacitors. The excessive internal inductance associated with large size capacitors limits accuracy of measurement.

## MEGACYCLE METER Model 59

- For determining the resonant frequency of tuned circuits, antennas, transmission lines, by-pass condensers, chokes, coils.
- For measuring capacitance, inductance, Q, mutual inductance.
- For preliminary tracking and alignment of receivers.
- As an auxiliary signal generator; modulated or unmodulated.
- For antenna tuning and transmitter neutralizing, power off.
- For locating parasitic circuits and spurious resonances.
- As a low sensitivity receiver for signal tracing.

**SPECIFICATIONS:**  
Power Unit: 5 1/4" wide; 6 1/8" high; 7 1/2" deep.  
Oscillator Unit: 3 3/4" diameter; 2" deep.

**FREQUENCY:**  
2.2 mc. to 400 mc.; seven plug-in coils.

**MODULATION:**  
CW or 120 cycles; or external.

**POWER SUPPLY:**  
110-120 volts, 50-60 cycles; 20 watts.

**MANUFACTURERS OF**  
Standard Signal Generators  
Pulse Generators  
FM Signal Generators  
Square Wave Generators  
Vacuum Tube Voltmeters  
UHF Radio Noise & Field Strength Meters  
Capacity Bridges  
Megohm Meters  
Phase Sequence Indicators  
Television and FM Test Equipment

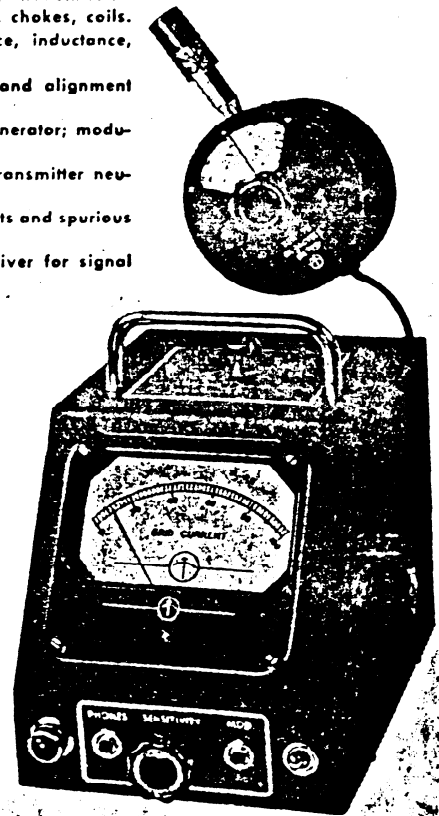

**MEASUREMENTS CORPORATION**  
BOONTON NEW JERSEY

OHMS REACTANCE.

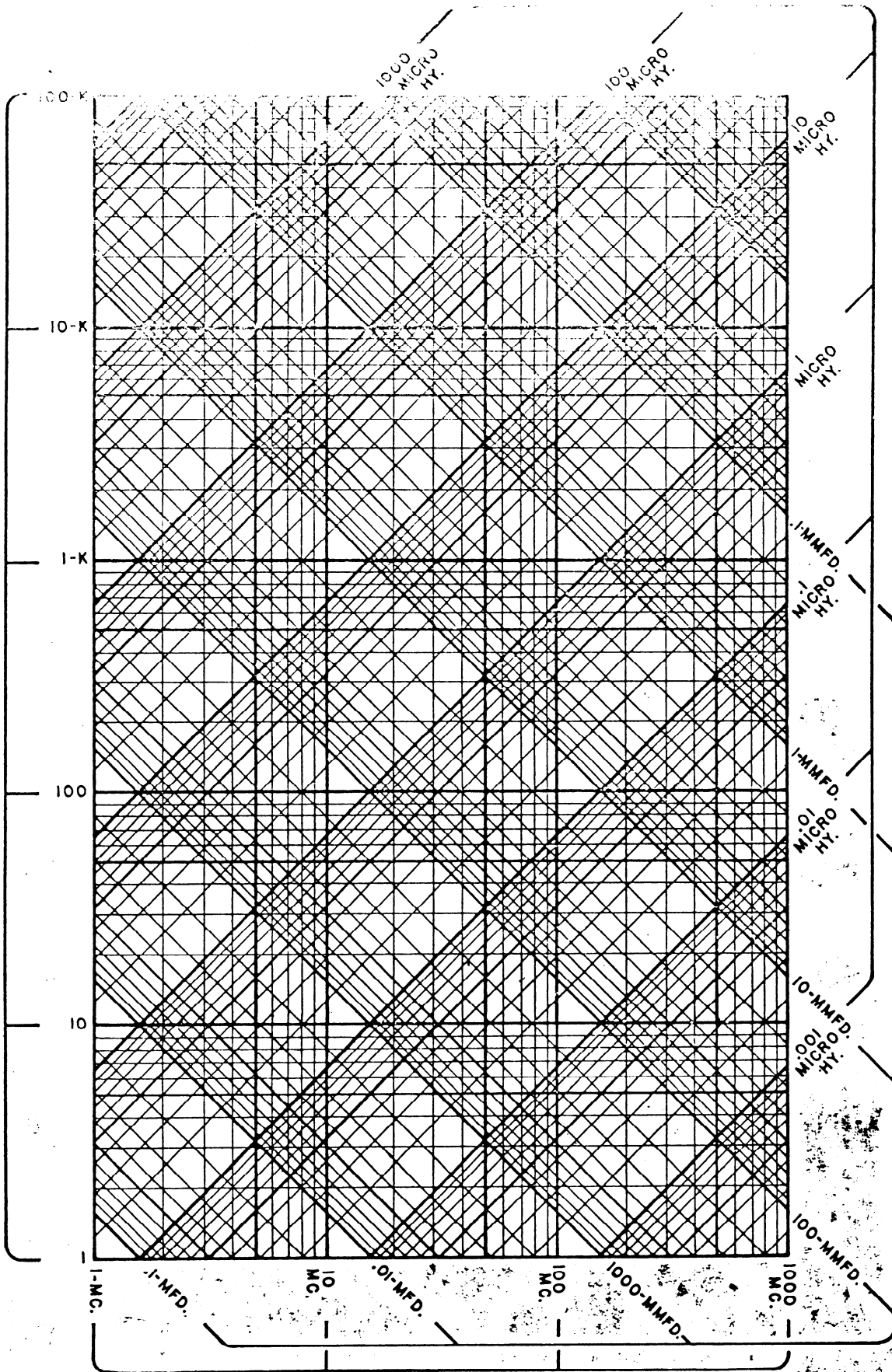

CAPACITANCE.

FREQUENCY.

**MEASUREMENTS CORPORATION**

BOONTON



NEW JERSEY