

EVERYTHING 4 LESS

ENJOY YOUR BOOKS

PLEASE VISIT OUR STORE FOR EVEN MORE GREAT STUFF!

WWW.EVERYTHING4LESSSTORE.COM

COPYRIGHT NOTICE

ALL MATERIALS INCLUDING CD/DVD AND PDF FILES ARE COPYRIGHTED

WWW.EVERYTHING4LESSSTORE.COM VON WALTHOUR PRODUCTIONS AND MAY NOT BE REPRODUCED, COPIED OR RESOLD UNDER ANY CIRCUMSTANCES. YOU MAY HOWEVER MAKE A COPY FOR YOUR OWN PERSONAL BACKUP. MATERIALS ARE FOR PERSONAL USE ONLY.

IF YOU PURCHASED THIS FROM ANYWHERE BUT FROM US PLEASE NOTIFY US IMMEDIATELY SO THAT WE MAY CHECK IF YOU PURCHASED FROM AN AUTHORIZED RESELLER SO WE CAN LET YOU KNOW IF YOU NEED TO RETURN FOR FULL REFUND FROM AN UNAUTHORIZED SELLER.

THANKS AGAIN AND PLEASE TAKE THE TIME TO VISIT OUR STORE.

ATTENTION! EVERYTHING ON SALE NOW!!



HOT SALE!

INSTRUCTION MANUAL

TEICO

430 GENERAL-PURPOSE
3" OSCILLOSCOPE

TEICO

GENERAL PURPOSE 3" OSCILLOSCOPE

TABLE OF CONTENTS

SECTION I. FEATURES & SPECIFICATIONS	PAGE
1-1. Features.	2
1-2. Specifications.	2
1-3. Functions of Controls and Terminals.	3
1-4. Notes on Controls and Terminals.	4
 SECTION II. OPERATIONS	 4
 SECTION III. APPLICATIONS	 6
 SECTION IV. MAINTENANCE	 10
4-1. General.	10
4-2. Removal from Cabinet.	10
4-3. Trimmer Capacitor C1 Adjustment.	10
4-4. Trouble-Shooting The 430 Oscilloscope.	12
4-5. Tube Replacement.	12
4-6. Fuse Replacement.	12
4-7. Trouble-Shooting Chart.	12
 SECTION V. EICO's SERVICE POLICY	 15
 SECTION VI. REPLACEMENT PARTS LIST	 18

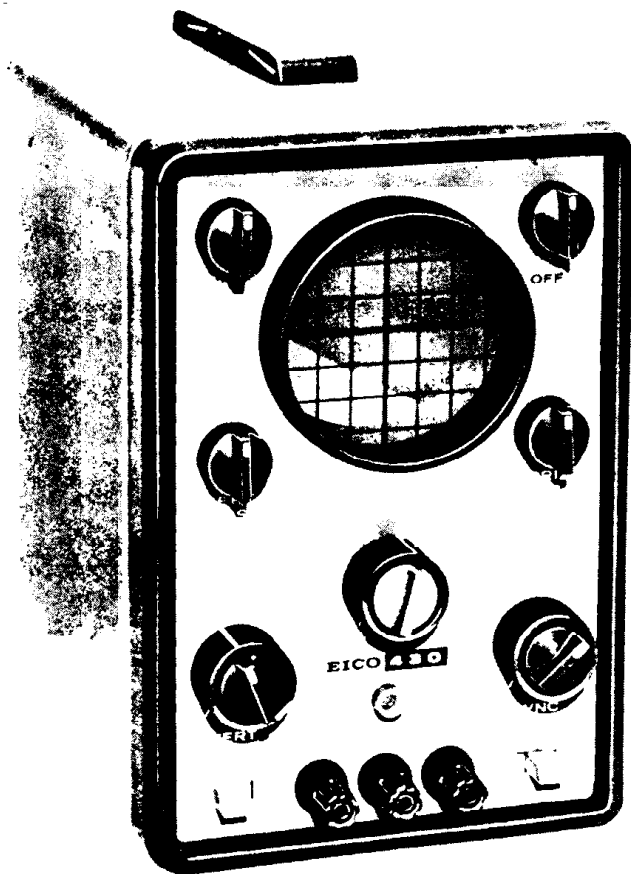

FIGURES

SECTION III. APPLICATIONS

Fig. 1. 1 Cycle of Sine Wave vs. Sawtooth.	
Fig. 2. 2 Cycles of Sine Wave vs. Sawtooth.	7
Fig. 3. 1:1 Ratio of Lissajous Patterns.	7
Fig. 4. Lissajous Patterns.	
Fig. 5. Equipment Test Block Diagram.	
Fig. 6. Sample Output Wave Shapes.	

SECTION IV. MAINTENANCE

Fig. 7. Jumper Points.	10
Fig. 8. Tube Layout & Adjustment Points	11
Fig. 9. Trimmer Adjust Pattern.	
Fig. 10. Trimmer Adjust Pattern (Square Wave).	
Fig. 11. Model 430 Schematic Diagram.	

SECTION I. FEATURES AND SPECIFICATIONS

The Model 430 is a general purpose 3-inch CRT Oscilloscope employing advanced, high-quality circuit techniques refined through many years of continuous oscilloscope development work at EICO. Despite its small size, the Model 430 has the control facilities and performance quality demanded in general laboratory work, production testing, service work, ham shacks, and home work shops. Its compact size makes it easy to place conveniently on any bench; rugged mechanical construction and light weight makes it truly portable.

1-1. FEATURES

1. Compact, lightweight design. Fits on any bench, goes anywhere.
2. Flat-face CRT gives full utilization of face area.
3. Mu-metal CRT neck shield minimizes effects of external fields.
4. Intensity and focus controls plus astigmatism adjustment.
5. 4-range sweep generator covers 10 cycles to 100,000 cycles.
6. VR-tube regulated power supply for stable, drift-free operation.
7. 1500 volts high-voltage supply for sharp, bright trace. No blooming.
8. Direct connections to vertical deflection plates for easy transmitter modulation monitoring.
9. Full retrace blanking and fully automatic sync.
10. Removable green filter easily snaps into the front of the plastic bezel.

1-2. SPECIFICATIONS

VERTICAL AMPLIFIER: Flat from 2 cycles to 500 kc; -6db at 1mc; 25-mv per cm sensitivity; frequency-compensated 100:1 coarse attenuator; input impedance 1 megohm shunted by 30pf; cathode follower input with fine attenuator in output; positioning range permits centering any part of trace expanded to three times CRT diameter.

HORIZONTAL AMPLIFIER: Flat from 2 cycles to 350kc; .25V per cm sensitivity; input impedance 10 megohms shunted by 40pf; cathode follower input with fine attenuator in output; positioning control permits centering any part of trace expanded to two times CRT diameter.

SWEEP CIRCUIT: 10 cycles to 100kc in four overlapping ranges; external or internal sync; fully automatic sync on all ranges; full retrace blanking; SWEEP RANGE switch also selects internal 60-cycle sine-wave sweep and input to HORIZ. INPUT terminals.

CRT CIRCUIT: Flat face 3-inch CRT with mu-metal neck shield; 1500 volts accelerating potential; intensity modulation input impedance 2 megohms shunted by 25pf, 3V RMS for blanking; intensity and focus controls on front panel; astigmatism adjustment without cabinet removal.

TUBES: 3-12AU7, 1-6BL8, 1-6D10, 1-6X4, 1-OA2, 1-1V2, 1-CRT

POWER REQUIREMENTS: 105-125 volts, 60 cycles, 60 watts

SIZE (HWD): 8 1/2 x 5 3/4 x 11 1/4 inches

WEIGHT: 11 lbs.

1-3. FUNCTIONS OF CONTROLS AND TERMINALS

The oscilloscope controls and terminals are easy to use once their functions are understood.

If the controls are divided into specific groups, for purposes of explanation, it will be easier to understand and keep in mind just what these functions are.

The INTENSITY & FOCUS controls together control the appearance of the trace. The INTENSITY knob controls the brightness of the trace and the FOCUS knob controls the sharpness or definition of the trace on the scope screen. The astigmatism control, a potentiometer accessible to screwdriver adjustment through a hole in the right-hand side of the cabinet, affects spot shape and is used to obtain a trace of uniform thickness. Proper adjustment of these controls should give a trace formed from a thin bright line, or an undeflected spot of light that is tiny, round, and bright. The INTENSITY & FOCUS controls interact to an extent; that is, adjustment of the FOCUS knob is usually necessary when the setting of the INTENSITY knob is changed.

The VERTICAL POSITION and HORIZONTAL POSITION controls adjust the location of the trace on the screen. Turning the HORIZONTAL POSITION knob shifts the trace left or right, and turning the VERTICAL POSITION knob moves the trace up or down.

The VERTICAL-ATTENUATOR (LO-HI) switch provides a choice of no attenuation (LO) or 100:1 frequency compensated attenuation (HI) of the input voltage fed to the vertical amplifier.

The VERTICAL GAIN control allows continuous adjustment of the vertical amplifier gain. It is used with the VERT. ATTENUATOR selector to adjust trace height to the desired value.

The SYNC SELECTOR has two positions to permit selection of internal or external sync voltages for the sweep oscillator. At the INT. position, the synchronizing voltage is taken internally from the vertical amplifier. At the EXT. position, an external synchronizing voltage applied between the HORIZ. INPUT terminal and ground is fed to the sweep oscillator.

The SWEEP RANGE switch selects the frequency band over which the SWEEP VERNIER can be varied for frequency adjustment of the internal linear sweep, and also serves as the horizontal input selector. In the four most clockwise positions, the numbers above the position markers are the upper and lower limits of the band (approximately) covered by the SWEEP VERNIER at the particular position. At either of the two most counter-clockwise positions of the SWEEP RANGE SWITCH, 60 CPS LINE and EXT. HOR. the sweep oscillator is disabled. At the 60 CPS LINE position, an a-c sinewave signal of power line frequency is taken from the power supply and applied to the input of the horizontal amplifier. At the EXT. HOR. position, an external signal voltage applied between the HORIZ. INPUT terminal and ground is applied to the input of the horizontal amplifier.

The VERT. INPUT and ground terminals provide for connection of external signals to the vertical amplifier.

An external voltage for purpose of intensity (Z-axis) modulation may be applied between Z-axis jack on the rear panel and ground on the front panel. Never apply an intensity modulating signal that is large enough to swing the grid of the cathode ray tube positive, or the life of the cathode ray tube may be greatly shortened. Positive grid swing is indicated by noticeable defocusing of the trace during the positive phase of the intensity modulating signal.

A pair of pin jacks, J4 and J5 designated DIRECT PLATES are provided at the rear to accommodate direct connections to the vertical plates when this is necessary for accurate display of high frequency waveforms requiring a bandwidth exceeding that of the vertical amplifier.

A pair of .01, 1KV capacitors (C8, C9) block the internal B+ voltage from appearing at the pin jacks. The AMPL. DIR. slide switch S2 adjacent to the pin jacks permits quick and convenient use of the DIRECT PLATES pin jack connections, since by throwing the switch to DIR., it is immediately possible to use these connections; the switch must be set at the AMPL. position whenever signals applied to the VERT. INPUT terminals on the front panel are to be observed.

1-4. NOTES ON CONTROLS AND TERMINALS

1. Proper trace definition will be obtained if the astigmatism control is correctly adjusted, and the 'scope is not operated in strong fields such as are found near transformers, transmitters, and power generating equipment, etc., which may distort the electron beam that produces the trace.

2. A sharply focused short line, or a small spot of high intensity, should not be permitted to remain stationary on the screen for any considerable length of time (more than 1/2 minute), or the screen will be burned. A trace of excessively high intensity will burn the screen in 3 to 5 minutes. These burned portions of the screen will no longer fluoresce and are useless for observation. If it is required to have a fixed trace on the screen for a long period, reduce the trace to minimum.

3. Trimmer capacitor C1 is used for frequency compensating the vertical attenuator at the 100:1 (HI) position. See MAINTENANCE section for adjustment procedure.

4. The EXT. position of the SYNC SELECTOR is for use with generators of other devices which have sync outputs.

5. At maximum gain settings, the sensitivity of the amplifiers is very high. Under these conditions stray pickup may produce patterns on the screen when no signal source is connected to the vertical input terminals. This is normal and does not interfere with the 'scope operation.

SECTION II. OPERATIONS

NOTE 1: To obtain proper results with your 'scope, it is advisable to become acquainted with functions and correct use of the panel controls and terminals by making some simple tests. These tests will also assure you that the instrument is in proper working condition. Do not attempt this procedure with kits before all final checks have been completed and all initial adjustments have been made as described in the MAINTENANCE section.

NOTE 2: Except when using DIRECT PLATES connections at rear, the AMPL.-DIR. slide switch at rear must be set at AMPL., as otherwise severe waveform distortion will occur.

1. Set the INTENSITY, VERT. GAIN, and HOR. GAIN CONTROLS at their furthest counter-clockwise positions.

2. Set the FOCUS, VERT. POS., and HOR. POS. controls at the center of their ranges. All other controls may be set at any position.

3. Insert the power cord into a 105-125 volt, 60 cycle a-c outlet.

WARNING

This instrument will not operate, or operate improperly and even be seriously damaged, if connected to any other type of power line (such as dc, 25 cycle ac, or an ac line above 125 volts).

4. Turn the INTENSITY control clockwise (on), at which the pilot lamp should light. Allow the unit to warm up for about a minute. Then gradually turn the INTENSITY control clockwise until a spot appears somewhere on the screen of the cathode-ray tube. If the spot does not appear, adjust the VERT. POS. and HOR. POS. control slightly, as it may be off screen.

5. Adjust the VERT. POS. and HOR. POS. controls until the spot is in the exact center of the screen, and then adjust the FOCUS control for the sharpest image. Notice that for every setting of the INTENSITY control, there is a best setting for the FOCUS control. The finest control on the right-hand side of the cabinet for the roundest, smallest spot possible.

6. Set the SWEEP RANGE switch at any of the internal linear sweep positions. Now advance the setting of the HOR. GAIN control gradually, and note that the spot extends to a horizontal line. This is the linear horizontal sweep.

7. Set the SWEEP RANGE switch at EXT. HOR. Notice that the horizontal line returns to a spot, as the horizontal amplifier is now connected to the HORIZ. INPUT and ground terminals. Any signal applied to the HORIZ. INPUT and ground terminals will cause the line to lengthen horizontally in proportion to the peak value of the applied signal.

8. Set the SWEEP RANGE switch at 60 CPS LINE. The horizontal line on the screen is the 60-cycle sine sweep.

9. If a power or filament transformer is available, connect a 6 or 12V winding (or the like) to the VERT. INPUT and ground terminals, and the primary side to the power line (NOTE: if necessary, the required 60 cps sinewave voltage may be obtained by removing the instrument from the cabinet, and connecting a jumper from point A on the chassis (see Fig. 7) to the VERT. INPUT terminal. Take care to avoid contact with exposed and dangerous high voltage points. Set the SYNC SELECTOR at INT., the VERT. ATTENUATOR at HI, the SWEEP RANGE switch at 10-100, the SWEEP VERN. control at MIN. Now adjust the VERT. GAIN and HOR. GAIN controls until the pattern extends about two-thirds the width and the height of the cathode-ray tube. The pattern will not be clear because of its rapid horizontal drift. Advance the setting of the SWEEP VERNIER gradually until a single sinewave of power line frequency appears and remains stationary on the screen.

NOTE 1: In rotating the SWEEP VERNIER, it will be noticed that the drift of the pattern slows down as certain critical frequencies are approached, and then reverses direction when the critical frequency is passed. At these critical frequencies, a clear pattern can be discerned. These critical sweep frequencies are sub-multiples of the signal frequency, or the signal frequency itself (when only one cycle of the signal is displayed). The pattern may be locked in at sub-multiples of the signal frequency when it is desired to view more than one cycle of the signal. The sweep frequency is equal to the signal frequency divided by the number of complete cycles displayed on the screen. For example, if two complete cycles of the 60 cps signal are displayed, the sweep frequency is 30 cps.

NOTE 2: At low sweep frequencies, flickering of the pattern is normal due to the slow writing speed of the spot and the persistence of the screen, which together are insufficient to cause the motion to blend into a fixed image.

10. With the filament transformer secondary still connected to the VERT. INPUT and ground terminal, set the SWEEP RANGE switch to 60 CPS LINE. Adjust the VERT. and HOR. GAIN controls as in Step 9. The pattern will be a stationary circle or ellipse. Then set the INTENSITY control at minimum. From an audio oscillator, apply about 10 volts at 300 cps between the INTENSITY MOD. jack on rear of chassis and ground, and then gradually advance the INTENSITY control until a broken line circle or ellipse is seen on the screen. Adjust the frequency of the audio oscillator carefully, until the broken lines stand still, and note that there are 5 such lines. This indicates that the ratio between the frequency applied to the INTENSITY MOD. jack and the frequency applied to the VERTICAL amplifier (60 cps) is 5. The INTENSITY MOD. jack may be used for inserting timing markers on a trace or determining the frequency of an unknown signal.

CAUTION

In any application where a signal is applied to the INTENSITY MOD. jack, the INTENSITY control should just be set at minimum and then advanced until the desired intensity is obtained.

SECTION III. APPLICATIONS

GENERAL: The oscilloscope is an instrument designed for viewing electrical oscillations and transients. Phenomena having a repetition rate from a few cycles per second to several megacycles per second may be displayed on a 'scope.

WAVEFORM INVESTIGATION: When the output of the internal sweep generator is fed to the horizontal channel, the pattern on the screen is actually a graph showing the variation with time of the instantaneous amplitude of the signal applied to the vertical channel. The sweep frequency is usually a sub-harmonic of the signal frequency, so that several complete cycles of the signal are displayed on the screen.

DISPLAY OF WAVEFORMS: Displaying a waveform means obtaining a picture that shows how the amplitude of the signal under observation varies with time. It is generally most convenient to use a time-base signal that varies linearly with time, so that equal intervals of time are represented on the screen by equal intervals of distance along the same axis. The sawtooth output of the sweep generator gives such a time-base on the horizontal axis, the time (in seconds) represented by the overall horizontal deflection being equal to the reciprocal of the sweep frequency (in cycle per second).

Apparently, if the frequency of the observed signal is equal to the sweep frequency, one complete cycle will be observed on the screen. If the frequency of the applied signal is twice the sweep frequency, two complete cycles will be obtained on the screen and so on. Fig. 1 is a projection drawing of a sine wave applied to the vertical plates and a sawtooth wave of the same frequency applied to the horizontal plates. Fig. 2 is a projection drawing showing the resultant pattern when the frequency of the sawtooth is one-half that employed in Fig. 1.

In these figures, points that occur simultaneously are numbered the same. The circle represents the tube screen. If simultaneous projections were drawn from every point on each

wave, the intersections would trace out the sine waves shown in the circles. The sections of sawtooth between 1 and 4 in Fig. 1 and between 1 and 9 in Fig. 2 are the sweep sections during which the displays are produced. The sections of the sawtooth between 4 and 5 in Fig. 1 and between 9 and 10 in Fig. 2 are the sections during which the beam is returned very rapidly to the starting point at the left-hand side of the screen. The return trace appears on the screen as a fine horizontal line.

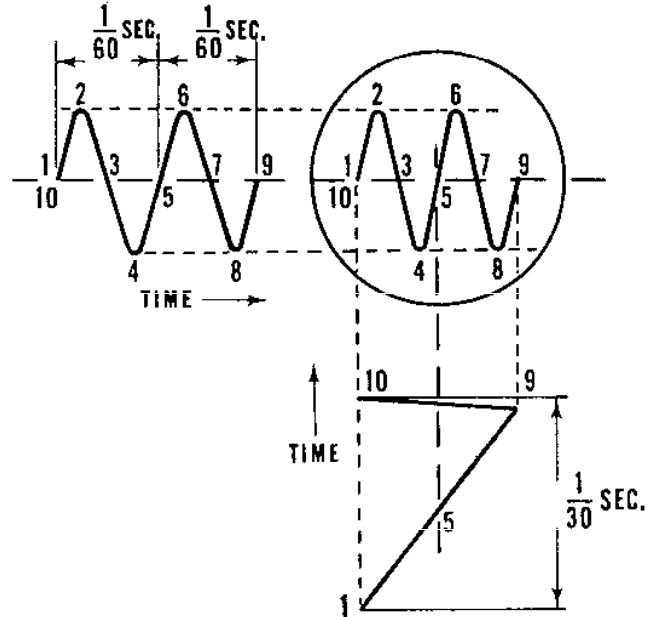
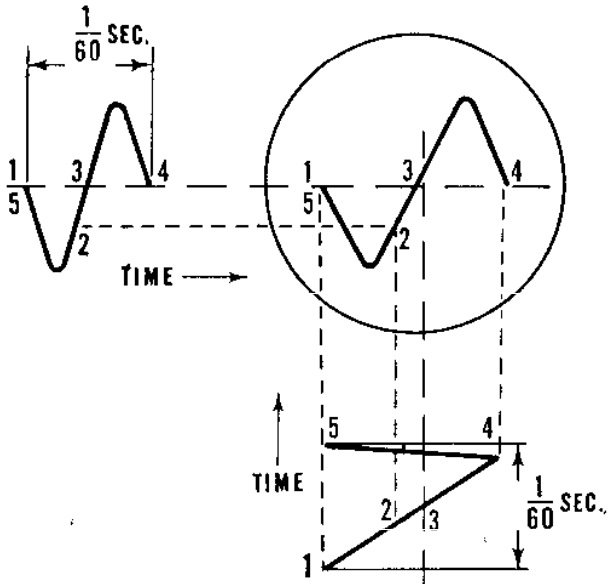

Figure 1. 1 Cycle of Sine Wave vs. Sawtooth

Figure 2. 2 Cycles of Sine Wave vs. Sawtooth

LISAJOUS PATTERNS: Another type of fundamental pattern is obtained when both the vertical and horizontal deflection voltages are sinewaves that are related in frequency as follows: one frequency is a whole number of times larger than the other; one frequency is a simple fraction of the other. When one or the other of these conditions is fulfilled, stationary closed-loop patterns are obtained. These patterns are called Lissajous figures after the 19th century French scientist. They are particularly useful in determining the frequency ratio between two sinewave signals. If the frequency of one signal is known, the frequency of the other signal can be easily determined from the frequency ratio. Usually the known signal is applied to the horizontal channel and the unknown signal to the vertical channel. The shape of the pattern changes with the phase relationship between the known and unknown signals. For example, all the patterns shown in Fig. 3 (and those intermediate) are possible with a frequency ratio of 1:1 if the phase differences indicated exist.

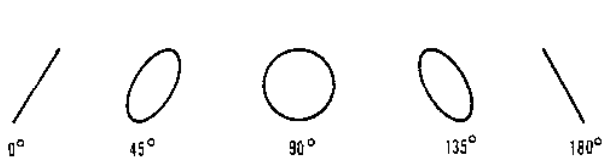

Figure 3. 1:1 Ratio of Lissajous Patterns

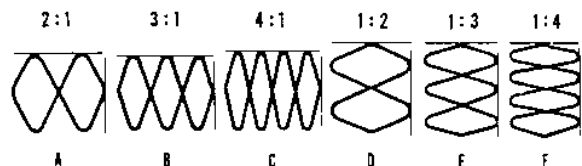

Figure 4. Lissajous Patterns

In general to determine frequency ratio from the Lissajous figure, count the number of points of tangency to horizontal and vertical lines, drawn or imagined (see Fig. 4). Points of tangency at the top of the figures result from the unknown frequency applied to the vertical channel. Those at the side of the figure result from the known frequency applied to the horizontal axis. As a matter of fact, the following relationship holds true in all cases:

$$\frac{\text{V axis freq}}{\text{H axis freq}} = \frac{\text{V pts of tangency}}{\text{H pts of tangency}}$$

As an example, take Fig. 4c, which shows four points of tangency at the top and one point at the side. This indicates that the unknown frequency applied to the vertical axis is four times the known frequency. In Fig. 4f, one point of tangency at the top and four at the side indicate that the unknown frequency is one-fourth the known frequency.

Model 377 Audio Generator or Model 488 Electronic Switch can be used to check amplifiers as to frequency response, phase shift, transient response, deficient design, or faulty components. The equipment is set up as shown in Fig. 5.

First, a means of comparison, the square wave output from the Audio Generator is viewed on the 'scope. The horizontal sweep of the scope should be adjusted so that at least two full cycles can be seen on the screen. (Fig. 6a shows one full cycle of a perfect square wave). The 'scope is then connected to the output of the amplifier under test so that the modified square wave can be viewed on the screen. Possible output wave shapes are shown in Fig. 6b to 6i, and the significance of each waveshape is explained below.

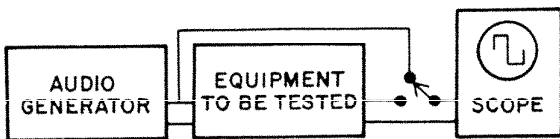

Figure 5. Equipment Test Block Diagram

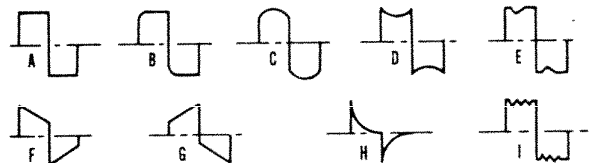

Figure 6. Sample Output Wave Shapes

Fig. 6b shows "rounding" of the leading edge of square wave. This indicates a drop off in gain at high frequencies. "Rounding" will generally be observable when there is a substantial drop in the gain by the tenth harmonic (or less). Therefore, if a 2kc square wave fed to the amplifier is reproduced on the 'scope without "rounding", the amplifier is flat to $10 \times 2\text{kc} = 20\text{kc}$.

Fig. 6c shows the effect of increased gain and Fig. 6d shows the effect of decreased gain the square wave frequency. Fig. 6e indicates lowered gain at a narrow frequency band. If the square wave frequency is brought into this narrow frequency band, Fig. 6d will result.

The effect of phase shift in the amplifier is shown in Figs. 6f and 6g. If, at low frequencies, there is phase shift in the leading direction, the square wave will be tilted as in Fig. 6f. If there is phase shift in the lagging direction, the top of the square wave will be tilted as in Fig. 6g. The steepness of the tilt is proportional to the amount of phase shift. Phase shift is not important in audio amplifiers, although the ear is not entirely insensitive to it. In television and 'scope amplifiers, however, phase shift should not be tolerated.

Fig. 6h shows the pulse output from the amplifier that results when the square wave has undergone differentiation. This will happen when the grid resistor or the coupling condenser

is too low in value or if the coupling condenser is partially open. Lastly, Fig. 6i, shows a square wave with damped oscillations following the leading edge. This results when a high frequency square wave is fed to an amplifier in which distributed capacities and lead inductances resonate at low frequencies. In television and 'scope amplifiers it may result from an undamped peaking coil.

High fidelity audio amplifiers may be given a rapid check by testing first with a square wave of fundamental frequency not less than 3 to 4 times the low frequency limit of the amplifier (3db point) and then with a square wave of fundamental frequency which may be anywhere between 1/100 to 1/10 of the high frequency limit of the amplifier depending upon how many harmonics are considered necessary to produce an acceptable version of a square waveform. Usually, square waves of fundamental frequency from 40 to 60 cps and 1000 to 2000 cps are employed to cover the range up to 20,000 cps.

To insure correct results, the following is suggested: Connect the proper value of load across the amplifier output terminals; use low capacitance cable for connecting the generator to the amplifier input; set the generator output to an ample value but be sure not to overload the amplifier. The square wave signal is fed to the amplifier input and the 'scope is connected across the amplifier load. Use the internal linear sweep to observe the waveform. Note that tone controls have a very marked effect on square wave response and should be set to the "flat" positions unless it is desired to observe their effect. Note, also, that low fidelity and p. a. amplifiers will not reproduce the square waveform.

Video amplifiers may be square wave tested in the same manner as described for testing audio amplifiers. The test frequencies might be 60 cps for the low and in 25,000 cps for high frequency end.

SERVICING TV RECEIVERS: One major use of the scope in tv servicing is alignment in conjunction with a TV/FM Sweep Generator. First, the IF stages are aligned, and then the RF and local oscillator stages, following the general method and theory of alignment described in the sweep generator instruction manuals. The specific methods of alignment depend on the receiver, and the manufacturer's service instruction should always be followed.

Another major use of the 'scope is to check the waveform of the complex tv signal as it passes through the receiver. The exceptional fidelity of the Model 430 'scope is very important in this application, since you must be able to observe small variations in waveform in order to localize and correct the cause of poor picture quality. Here again, the set manufacturer provides representative waveforms to be expected at specific points in a specific model of receiver. These waveform pictures are furnished for the entire receiver, with the exception of the tuner portion. EICO manufactures a complete line of high quality oscilloscope probes meeting all the requirements for waveform observation in any part of a tv receiver.

Keep in mind that two basic frequencies are involved in checking waveform of signals in tv receivers. The vertical or field frequency is 60 cps. Any waveform check, except with the horizontal oscillator, its differentiator network, and the horizontal amplifier stages, can generally be made using an internal linear sweep frequency of 30 cycles to show two complete fields of the signal. To examine the horizontal pulse shape, or the operation of the horizontal deflection system, it is generally suitable to use an internal linear sweep frequency of 7875 cps, again to show two complete lines of the signal.

SECTION IV. MAINTENANCE

4-1. GENERAL

Included in this section are instructions for trimmer capacitor C1 adjustment, troubleshooting, and parts replacement.

4-2. REMOVAL FROM CABINET

To remove the instrument from the cabinet, first disconnect it from the power line and remove the two No. 8-32 x 3/8 machine screws in the cabinet rear. Then slide the chassis out the front of the cabinet.

WARNING

The voltages in this instrument are dangerous. Take caution to avoid personal contact with these voltages when the instrument is being operated outside of its cabinet. Remember that capacitors may remain charged to dangerously high voltages for a considerable time after power has been removed.

4-3. TRIMMER CAPACITOR C1 ADJUSTMENT

Connect a jumper from point B on chassis (see Fig. 7) and the VERT. INPUT terminal. Set the SYNC SELECTOR to INT., the SWEEP RANGE switch at the 1K-10K position, and the SWEEP VERNIER at MIN. Now set the VERT. ATTENUATOR at HI, and then use the panel controls to obtain a centered, focused trace entirely on the screen. With the trimmer C1 adjusted improperly, the trace will appear either as in Fig. 9a or Fig. 9b. If this is the case, adjust C1 (see Fig. 8) until the hook disappears and the trace is a straight line as in Fig. 9c.

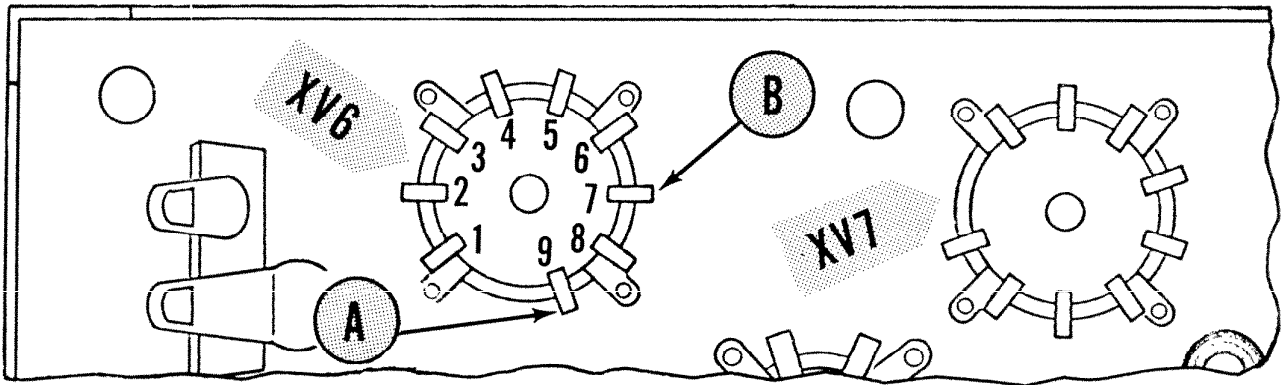

Figure 7. Jumper Points

A much preferred method of adjustment, when the equipment is available, is to apply a square wave of approximately 1kc fundamental frequency to the VERT. INPUT and ground terminals. With the VERT. ATTENUATOR set to HI, adjust trimmer C1 for the best possible square wave reproduction. Internal sweep is employed and the panel controls set for several stationary square waves on the screen before adjusting the trimmer for proper frequency compensation.

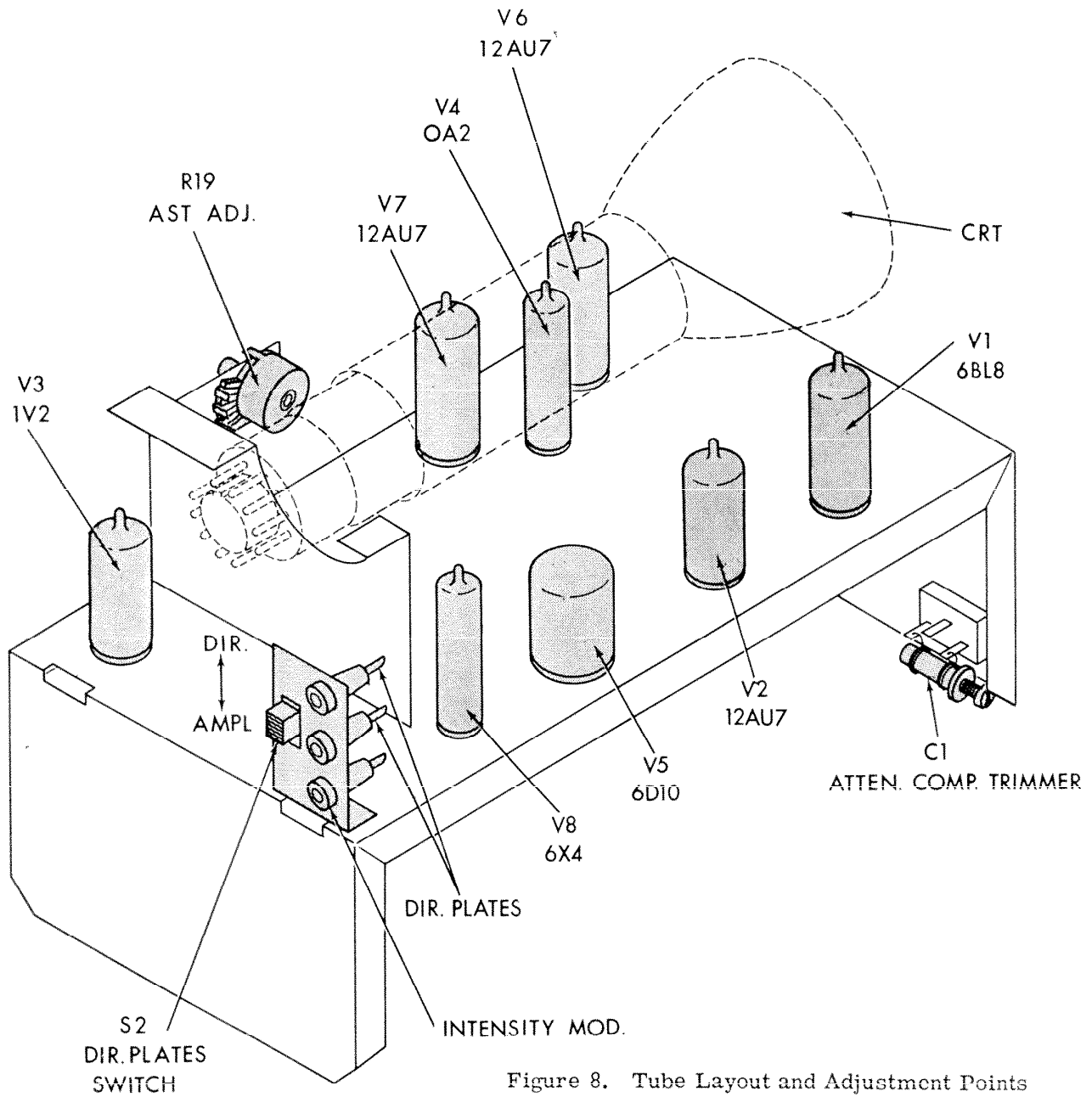

Figure 8. Tube Layout and Adjustment Points

Under-compensation and over-compensation are indicated by square waves appearing as in Figs. 10a and 10b, respectively. Proper compensation is indicated by square waves appearing as in Fig. 10c.

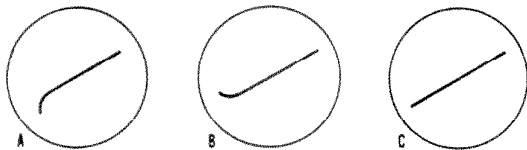

Figure 9. Trimmer Adjust Pattern

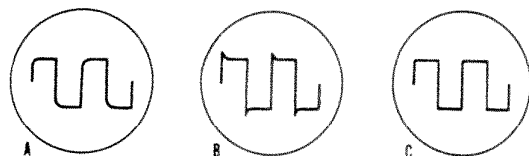

Figure 10. Trimmer Adjust Pattern
(Square Wave)

4-4. TROUBLE-SHOOTING THE 430 OSCILLOSCOPE

The block diagram of the 430 should aid in isolating the circuit in which the trouble is located. Once this is done, reference should be made to the appropriate section of the complete schematic. The next step is to localize the trouble in the particular section to the tube circuit involved and then to try a replacement tube. If the trouble is not eliminated, voltage checks should be made using the schematic diagram.

As an aid in localizing trouble, common symptoms together with their possible causes and remedies have been listed in groups corresponding to the major sections of the instrument. Of course, all possible troubles could not be included in the chart and the make-up of the chart has been based on the assumption that the instrument has worked properly at some previous time. Keep in mind that in trouble-shooting, the main endeavor is to find and eliminate the source of the trouble. Recurrence of a trouble usually indicates that the effect, not the cause has been remedied.

4-5. TUBE REPLACEMENT

Tube location is shown in Fig. 7. Readjustment will be required when replacing V1. When the CRT is replaced, it must be rotated until the horizontal trace is level.

4-6. FUSE REPLACEMENT

A 1 Amp fuse is located in the fuseholder on the rear chassis apron. If the fuse should blow, the component that has failed and caused the excessive current drain must be found and replaced before a new fuse is inserted.

4-7. TROUBLE SHOOTING CHART

POWER SUPPLY		
Pilot light fails to light	INTENSITY switch in OFF position No AC line voltage Pilot lamp open Fuse defective Power transformer defective Broken lead/or leads in the filament path	Turn INTENSITY switch clockwise Trace line failure Replace I1 Replace F1 Replace T1 Repair defective connections
Fuse, F1, blows when AC power is turned on	Shorted AC line cable on the primary side of the power transformer Defective rectifier tubes Defective filter capacitors Short in filament connections	Repair the short Check V7, V8. Replace if bad. Check C14, C21, for low resistance or short. Replace if necessary Check filament connections for shorts. Repair if necessary.
Some or all filaments fail to light	Defective tube or tubes Broken lead from power transformer Power transformer defective	Replace tube or tubes* Check with an ohmmeter for continuity. Repair if necessary. Replace

CRT CIRCUIT

No spot on CRT screen	High voltage rectifier tube, V3, defective Filament leads broken No voltage on second anode	Replace Repair Check circuit. Repair if necessary.
	Note: Spot may be deflected off screen. Adjust V-POS. control for equal voltages from CRT pins 6 & 7 to ground (V. defl. plates) and H. POS. control for equal voltages from CRT pins 9 & 10 to ground (H. defl. plates). The spot should then be centered. If either adjustment is impossible, refer to the vertical or horizontal amplifier sections.	
No spot on CRT screen (All CRT voltages correct)	Defective CRT (V9)	Replace (V9)
Retrace blanking inoperative	C13 open Broken lead from the sweep frequency generator to the cathode of V9	Replace Check if necessary
No focusing	R21 defective R19 defective Note: R32 is the focusing potentiometer. Its action is dependent on the setting of the astigmatism, potentiometer R19. For best focus, both pots must be adjusted simultaneously as an initial adjustment.	Replace Replace
No horizontal positioning	Refer to horizontal amplifier	
No vertical positioning	Refer to vertical amplifier	
Astigmatism control inoperative	R19 defective	Replace

SWEEP CIRCUIT

No sweep (hor. ampl. checks O. K.)	Sweep Selector switch is not set to sweep positions Lead or leads broken V5 defective S3 defective R37 defective Check resistors in V5 chart V5C shorted	Set Sweep Selector to any of the sweep positions. Check and repair if necessary Replace Check. Replace if necessary Check. Replace if necessary Replace if necessary Replace
------------------------------------	----------------------------------------------------------------------------------------------------------------------------------------------------------------------------	------------------------------------------------------------------------------------------------------------------------------------------------------------------------------------------------

SWEEP CIRCUIT (Cont'd.)

Sweep inoperative on some ranges	One of C18-21 defective S3 defective	Replace the defective capacitor* Replace
Loss of synchronization	V5C defective S4 defective C15 open Sync leads defective	Replace V5 Check. Replace if necessary Replace Replace

VERTICAL AMPLIFIER

With appropriate signal applied to INPUT, no vertical displacement of the trace results.	Defective S1 One or more tubes defective One or more components in the vertical amplifier defective	Check. Replace if necessary Check V1. Replace if defective Check resistors and potentiometers with ohmmeter. Replace if defective
No vertical positioning	R12 defective	Replace R12
No vertical signal	C3 open Open leads	Replace C3 Repair
Square wave (1kc) distorted in HI POS. of the attenuator	C1 out of adjustment	Adjust C1
No vertical gain adjust	R8 defective	Replace R8
Trace "jumps" on CRT screen in vertical	Loose connection in vertical amplifier section One of the tubes "microphonic" V4 defective	Repair Tap tubes lightly. Replace the one which is "microphonic". Replace

HORIZONTAL AMPLIFIER

No horizontal deflection; sweep checks O. K. and SWEEP SELECTOR in one of SWEEP positions	C22, C23 open V6 or V7 defective C14D shorted R41 defective S3 defective	Replace Check and replace if bad Replace Replace Replace
No horizontal positioning	R45, R46, R47 defective C26 shorted	Check and replace if necessary Replace
Horizontal deflection present but distorted	C14D open C26 open V6, V7 defective R49, 50 defective	Replace Replace Replace Replace

*Indicates replacement of component in this group makes it necessary to repeat some part of the initial adjustment procedure.

SECTION V. EICO's SERVICE POLICY

SERVICE CONSULTATION

If you are experiencing trouble that you cannot diagnose yourself, you are invited to avail yourself of the EICO Service Consultation Department. The consultant handling your inquiry will make every effort to diagnose the cause of your particular difficulty based on the information that you provide. Please be as thorough as possible. Include the following information about your unit:

- a) Have you made a thorough check of the wiring, checking also for cold solder joints, or accidental shorting between parts, or to chassis? (Check to see whether a bare wire or lead extends far enough to be shorted when the bottom plate is put on).
- b) Have you checked that the proper tube or transistor is in each socket, and also making proper contact in the socket? Are all shields firmly in place?
- c) Does the trouble occur at one time or one operating situation, but not at another time or operating situation? Be as specific as possible in this respect.
- d) If the unit is of the type that involves alignment or calibration, be as specific as possible as to what you have done or not done with regard to these requirements. If the unit incorporates tuned circuits stated to be factory pre-aligned, did you change any settings? If so, what alignment procedure did you use?
- e) Have you observed any peculiarity about a part? If a part appears charred or otherwise damaged by excessive heat, please say so. If you think you have damaged a particular part in the assembly or wiring, please say so. In conjunction with the symptoms, the consultant may be able to determine whether such a part is likely to be defective.
- f) Have you gone through any trouble-shooting procedure that may be provided? If your manual includes a table of contacts made at each switch position, have you checked out the switches accordingly (if the trouble is such that doing this would be appropriate)? Have you been able to make checks of the operating voltages and/or resistances, if this is appropriate, and your manual provides a table of voltages and resistances? What are the results of these checks? Also, have you taken any other trouble-shooting approaches? What have been the results?

In addition, list any code numbers under the words INSTRUCTION MANUAL on the cover of the book provided with your unit. If there are no code numbers, state this specifically. If the unit bears a serial number, it is essential that you include this also.

PARTS REPLACEMENT

If it appears that a component is defective, and you desire a replacement from EICO, address your correspondence to our Customer Service Department.

If you are claiming the right to a no-charge replacement under the terms and conditions of the warranty, it is required that you shall have sent in the registration card within 10 days of the date of purchase, and that you send back the defective part transportation prepaid. EICO will make the necessary replacement at no charge for parts eligible under the terms and conditions of the warranty. In returning tubes, pack them very carefully to avoid breakage in shipment. Broken tubes will not be replaced. Please read the warranty on the subject of parts eligible for replacement.

Further information required on a part returned to the factory for a no-charge replacement under the terms and conditions of the warranty is as follows:

- a) Model number and serial number, if any, of unit. Also any code numbers under the words INSTRUCTION MANUAL on the cover of the book supplied with the unit.
- b) Stock number and description of part as given on the parts list. If the part is not listed (of itself) in the parts list, it means that the part is integral with a sub-assembly. If the sub-assembly is not sealed, and the defective part is definitely identified and easily replaceable (not more than two connections), you may request replacement for the particular part. If the sub-assembly is sealed, or if the defective part is not definitely identified or is not easily replaceable (more than two connections), then remove the sub-assembly and return it to EICO (less any tubes) for repair or replacement, if your unit is in warranty. If your unit is out of warranty, you are generally advised to order a replacement sub-assembly.
- c) Describe as completely as possible the nature of the defect, or your reason for requiring replacement.

FACTORY REPAIR SERVICE

EICO maintains a Factory Repair Service Department for in-warranty or out-of-warranty repair of EICO equipment. It is intended to serve those customers who are not adequately familiar with electronics to make use of the EICO Service Consultation facilities, or whose difficulties cannot be solved by correspondence.

For all out-of-warranty units, there is a minimum labor and handling fee. For the Model No. 430, this fee is \$12.50. Charges for components replace are additional to the minimum fee.

For in-warranty completed kit units, there is a minimum labor and handling fee. For the Model No.

430, this fee is \$12.50. There is no charge for a replaced defective part provided that the terms and conditions of the warranty for no charge replacement are not violated in the judgement of EICO.

For in-warranty factory-wired units, there is no labor and handling fee if the unit complies with the terms and conditions of the warranty in the judgement of EICO. However, if the terms and conditions of the warranty are violated, then there will be charged to customer a minimum labor and handling fee plus the cost of parts replaced.

In all cases, the unit must be sent to the factory transportation prepaid, and the unit will be returned to the customer transportation collect.

The services rendered for the minimum labor and handling fee are the correction of any minor wiring errors (not extensive corrections or re-wiring), the labor involved in replacing defective parts, and any adjustments, alignment, or calibration procedures that would normally be performed on a factory-wired unit. Units not wired according to instructions, or modified in any way, or showing evidence of the use of acid core solder, will not be serviced and will be returned to the customer forthwith.

Units requiring extensive corrections or re-wiring will incur an additional labor charge which will be set by EICO. The customer will be informed of this situation and written authorization from the customer will be required before the work is done.

Please note: minimum labor and handling fees are subject to revision at any time.

LOCAL REPAIR FACILITIES

Out-of-warranty repair work may also be performed by authorized service stations as well as the EICO factory. A list of authorized service stations is provided with this manual. The roster of stations may change from time to time, and if considerable time has elapsed since you purchased your unit, you are advised to contact the station you choose before sending the unit to them for repair. Use of a local service station will often result in faster service, and, usually, lower transportation costs.

It is necessary that you comply with the Shipping Instructions that follow when sending in a unit for service.

SHIPPING INSTRUCTIONS

You are strongly advised to retain the original shipping carton and inserts in the case that re-shipment is required for service or any other purpose. The carton may be collapsed, for storage in as small a space as possible. In very many cases, the same carton is used for kit and factory-wired units so that the kit carton will serve for re-shipment of the completed kit.

To submit a unit for service, either to the factory or an authorized service station*, fill out completely the Service Work Order form provided with the manual. Pack the unit very carefully, preferably in the original shipping carton with the original inserts.

If this is not possible, use a strong oversize carton, preferably wood, allowing at least 3 inches of resilient packing material such as shredded paper or excelsior, to be inserted between all sides of the unit and the carton. Seal the carton with strong gummed paper tape or strong twine, or both. Include the Service Work Order in the carton and in addition, attach a tag to the instrument on which is printed your name and address and brief reference to the trouble experienced. Affix "FRAGILE" or "HANDLE WITH CARE" labels to at least four sides of the carton, or print these words large and clear with a bright color crayon. Ship by prepaid Railway Express or parcel post to:

EICO Electronic Instrument Co., Inc.
33-00 Northern Blvd.
Long Island City 1, New York
Attention: Service Department

Include your name and address on the outside of the carton. Return shipment will be made transportation charges collect. Note that a carrier cannot be held liable for damages in transit, if packing, IN HIS OPINION, is insufficient.

*Authorized service stations are for out-of-warranty units only, unless the station is specifically noted on the List of Authorized Service Stations to be authorized for other work.



THE EICO WARRANTY



The EICO Electronic Instrument Co., Inc., hereafter referred to as EICO, warrants that, for a period of 90 days from the date of purchase, any EICO kit will be free of defects in parts, and that any EICO factory-wired unit will be free of defects in parts and workmanship. For an EICO kit, EICO's obligation is limited to those parts which are returned transportation prepaid to the factory without further damage, and in the judgement of EICO are either originally defective or have become defective in normal use. For an EICO factory-wired unit, EICO's obligation is limited to those parts, sections, or the entire unit which is returned transportation prepaid to the factory without further damage, and in the judgement of EICO are either originally defective or have become defective in normal use.

The warranty does not apply to any parts damaged in the course of handling, assembling, or wiring by the customer, or damaged due to abnormal usage or in violation of instructions or reasonable practice, or further damaged to a consequential degree in return shipment. Furthermore, the foregoing warranty is made only to the original customer, and is and shall be in lieu of all other warranties, whether expressed or implied, and of all other obligations or liabilities on the part of EICO, and in no event shall EICO be liable for any anticipated profits, consequential damages, loss of time, or other losses incurred by the customer in connection with the purchase or operation of EICO products or components thereof.

The registration card, which accompanies each EICO kit or factory-wired unit, must be filled in and returned to the company within 10 days after the date of purchase. This warranty applies only to registered units.

SECTION VI. REPLACEMENT PARTS LIST

SYM. #	STOCK#	AM'T.	DESCRIPTION
--------	--------	-------	-------------

CAPACITORS

C1.....	29513.....	1	capacitor, trimmer, 1.5-6uuf
C2.....	22515.....	1	capacitor, disc, 500uuf, 500V, 10%
C3, 21, 22 ...	20050.....	3	capacitor, paper, .25uf, 200V
C4.....	23065.....	1	capacitor, elect., tubular, 10ufd, 50V
C5.....	23028.....	1	capacitor, elect., tubular, 10ufd, 150V
C6.....	22549.....	1	capacitor, disc, .003ufd, 10%, 500V
C7, 20, 26 ...	20062.....	3	capacitor, mylar, .025ufd, 10%, 200V
C8, 9, 10....	22583.....	3	capacitor, disc, .01ufd, 2KV, 10%
C11, 12.....	20055.....	2	capacitor, paper, .1ufd, 1600V
C13.....	20077.....	1	capacitor, paper, .05ufd, 1500V, 10%
C14.....	24012.....	1	capacitor, elect., can, 3 x 40ufd, 450V-20ufd, 450V
C15.....	20057.....	1	capacitor, mylar, .47ufd, 200V
C16.....	22509.....	1	capacitor, disc, 100uuf, 500V, 10%
C17.....	22546.....	1	capacitor, disc, 56uuf, 500V, 10%
C18.....	22562.....	1	capacitor, disc, 220uuf
C19.....	20507.....	1	capacitor, disc, .0022ufd
C23.....	23070.....	1	capacitor, elect., tubular, 20ufd, 50V
C24.....	22536.....	1	capacitor, disc, 25uuf, 500V, 10%
C25.....	22512.....	1	capacitor, disc, 330uuf, 800V, 10%

F1.....	91002.....	1	fuse, 1 Amp
I1.....	97715.....	1	indicator, neon

J1, 3.....	52006.....	2	binding post
J2.....	52008.....	1	binding post
J4, 5, 6.....	50029.....	3	jack

RESISTORS

R1.....	11577.....	1	resistor, 990K Ω , 1/2W, 5%
R2.....	11500.....	1	resistor, 10K Ω , 1/2W, 5%
R3, 26, 38 ...	10434.....	3	resistor, 2.2M Ω , 1/2W, 10%
R4.....	10439.....	1	resistor, 100 Ω , 1/2W, 10%
R5, 28.....	10406.....	2	resistor, 680 Ω , 1/2W, 10%
R6, 44.....	10400.....	2	resistor, 10K Ω , 1/2W, 10%
R7, 32.....	10424.....	2	resistor, 22K Ω , 1/2W, 10%
R8, 41.....	18107.....	2	potentiometer, 10K Ω , linear
R9, 42.....	10428.....	2	resistor, 47K Ω , 1/2W, 10%
R10.....	10433.....	1	resistor, 560 Ω , 1/2W, 10%
R11.....	10435.....	1	resistor, 150K Ω , 1/2W, 10%
R12.....	18108.....	1	potentiometer, 100K Ω , linear, 20%
R13.....	10425.....	1	resistor, 56K Ω , 1/2W, 10%
R14, 30.....	10855.....	2	resistor, 4700 Ω , 1W, 10%
R15, 16.....	10851.....	2	resistor, 22K Ω , 1W, 10%

SYM. #	STOCK#	AM'T.	DESCRIPTION
R17, 18, 22	10407	3	resistor, 1MΩ, 1/2W, 10%
R19	18017	1	potentiometer, 2MΩ, linear (snap-in)
R20	10415	1	resistor, 4700, 1/2W, 10%
R21	16011	1	potentiometer, 2MΩ, linear
R23/S5	18110	1	potentiometer, 500KΩ, linear, 20% w/SPST
R24, 53	10412	2	resistor, 330KΩ, 1/2W, 10%
R25	10410	1	resistor, 100KΩ, 1/2W, 10%
R27	10419	1	resistor, 270KΩ, 1/2W, 10%
R29	10856	1	resistor, 10KΩ, 2W, 10%
R31	10453	1	resistor, 18KΩ, 1/2W, 10%
R33	10442	1	resistor, 1500Ω, 1/2W, 10%
R34, 49, 50	10849	3	resistor, 47KΩ, 1W, 10%
R35	10452	1	resistor, 8200Ω, 1/2W, 10%
R36	10408	1	resistor, 680KΩ, 1/2W, 10%
R37		1	potentiometer, 10MΩ (on 60120)
R39	10427	1	resistor, 1200Ω, 1/2W, 10%
R40	10416	1	resistor, 15KΩ, 1/2W, 10%
R43	10430	1	resistor, 4700, 1/2W, 10%
R45	10426	1	resistor, 33KΩ, 1/2W, 10%
R46	18109	1	potentiometer, 50KΩ, linear, 20%
R47	10422	1	resistor, 68KΩ, 1/2W, 10%
R48	10852	1	resistor, 15KΩ, 1W, 10%
R51	11300	1	resistor, 10KΩ, 10W, 10%
R52	10970	1	resistor, 330Ω, 2W, 10%

SWITCHES

S1, 4	62017	2	switch, slide
S2	62000	1	switch, slide
S3	60120	1	switch, rotary w/10MΩ pot.

T1	30043	1	transformer
TB1, 11	54002	2	terminal strip, 1 post right w/ground
TB2	54023	1	terminal strip, 2 post left w/ground
TB3, 8, 13	54004	3	terminal strip, 2 post w/ground
TB4	54011	1	terminal strip, 1 post dual upright
TB5	54003	1	terminal strip, 2 post
TB6	54015	1	terminal strip, 3 post, 2 left w/ground
TB7, 14	54018	2	terminal strip, 4 post w/ground
TB9, 10	54014	2	terminal strip, 3 post, 2 left
TB12	54013	1	terminal strip, 1 post left w/ground

TUBES

V1	90071	1	tube, 6BL8
V2, 6, 7	90033	3	tube, 12AU7
V3	90030	1	tube, 1V2
V4	90074	1	tube, OA2

SYM#	STOCK#	AM'T.	DESCRIPTION
V5.....	90081.....	1.....	tube, 6D10
V8.....	90036.....	1.....	tube, 6X4
V9.....	90086.....	1.....	tube, CRT, 3DEP1
XF1.....	97805.....	1.....	fuseholder
XV1, 2, 3, 6,			
7.....	97025.....	5.....	socket, 9 pin, miniature
XV4, 8.....	97022.....	2.....	socket, 7 pin, miniature
XV5.....	97064.....	1.....	socket, 12 pin compactron
XV9.....	97026.....	1.....	socket, CRT

HARDWARE

40000.....	21.....	nut, hex, No. 6-32
40001.....	7.....	nut, hex, 3/8"
40007.....	17.....	nut, hex, No. 4-40
40008.....	4.....	nut, hex, No. 8-32
40016.....	1.....	nut, hex, 1/2"
40017.....	2.....	nut, Tinnerman, No. 8
40019.....	2.....	nut, Tinnerman, No. 6
40034.....	6.....	nut, Tinnerman, No. 4
41003.....	6.....	screw, No. 8-32 x 3/8
41007.....	2.....	screw, No. 6-32 x 3/4
41063.....	2.....	screw, No. 6-32 x 1/4, Fl. Hd.
41086.....	17.....	screw, No. 6-32 x 5/16
41089.....	10.....	screw, No. 6-32 x 3/16, Rd. Hd.
41090.....	15.....	screw, No. 4-40 x 5/16
41091.....	8.....	screw, No. 4-40 x 1/4, Fl. Hd.
41101.....	1.....	screw, No. 6-32 x 1"
42001.....	7.....	washer, flat, 3/8"
42002.....	23.....	washer, lock, No. 6
42005.....	4.....	washer, flat, No. 6
42007.....	21.....	washer, lock, No. 4
42008.....	4.....	washer, lock, No. 8
42029.....	1.....	washer, rubber, 1/2"
42034.....	1.....	washer, fibre, No. 6
42511.....	4.....	retainer, indicator
43000.....	1.....	lug, No. 6
43001.....	3.....	lug, 3/8"
43004.....	3.....	lug, No. 8

STOCK#	AM'T.	DESCRIPTION
MISCELLANEOUS		
46014.....	2	grommet, 1/4
46015.....	7	grommet, 1/8
46016.....	4	foot, plastic
46018.....	1	grommet, 1"
47009.....	1	spring
53036.....	2	knob, large, dark gray
53037.....	4	knob, small, dark gray
53040.....	1	knob, concentric, outer
53041.....	1	knob, concentric, inner
57004.....	1	line cord
59005.....	1	screen
59006.....	1	screen, filter
59306.....	1	CRT neck piece
59308.....	4	CRT felt cushion
81362.....	1	bezel, plastic
82101.....	1	strain relief
89277.....	1	label, nomenclature
89284.....	1	label, rear
66134.....	1	Instruction Manual
66385/S.....	1	Construction Manual (Steps)
66385/F.....	1	Construction Manual (Figures)

SHEET METAL

80135.....	1	panel, front
81363.....	2	clamp, CRT bracket
81364.....	1	support, CRT bracket
81365.....	1	chassis
81914.....	1	bracket, pot.
81975.....	1	bracket, slide switch
86005.....	1	frame
87006.....	1	handle w/links
88113.....	1	cabinet
89649.....	2	handle, mounting bracket

430 3" OSCILLOSCOPE
 PARTS LIST
 TO BE USED IN CONNECTION WITH
 PAGE 21

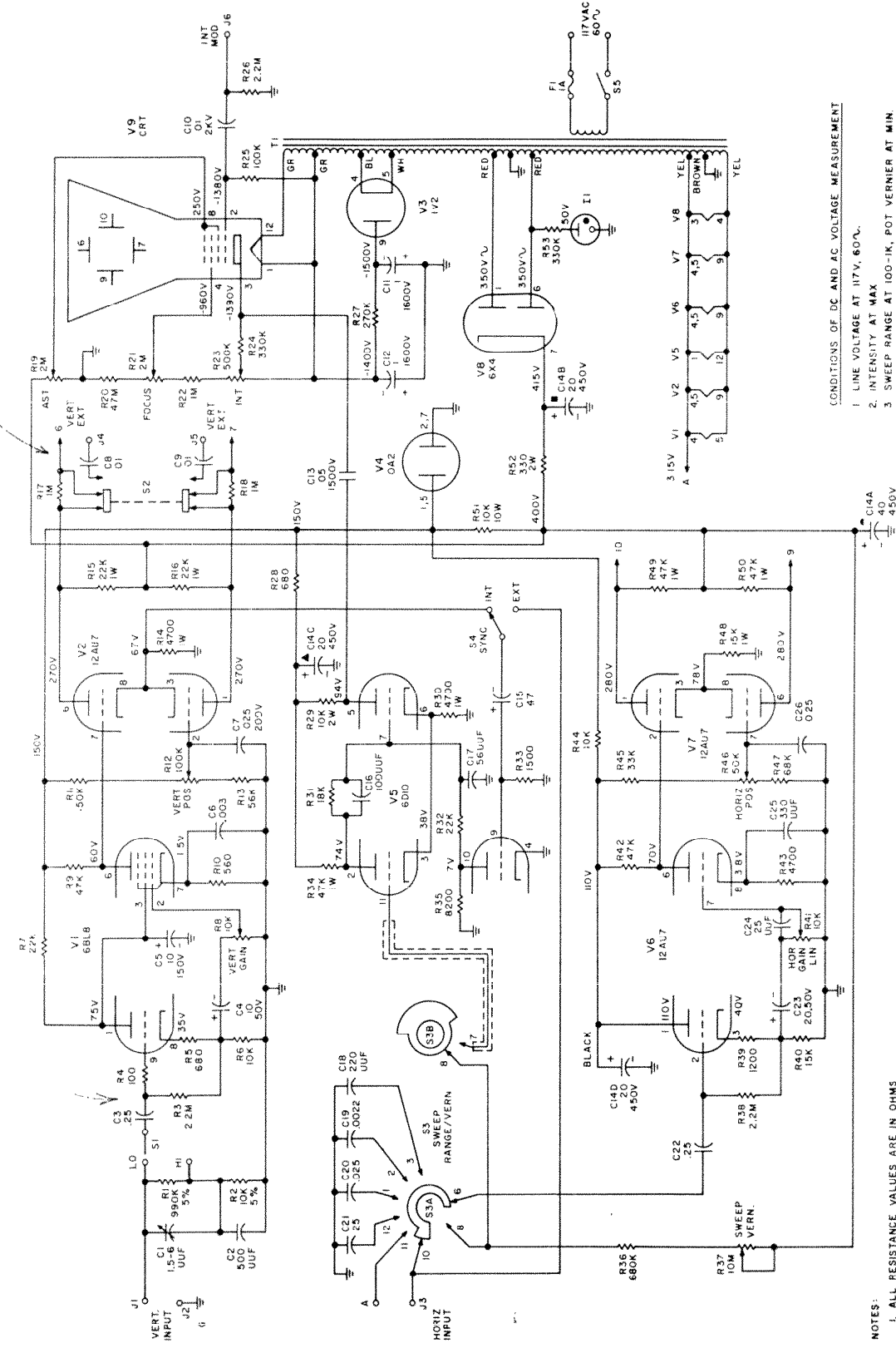

CONDITIONS OF DC AND AC VOLTAGE MEASUREMENT

1. LINE VOLTAGE AT 117V, 60°C.
2. INTENSITY AT MAX.
3. SWEEP RANGE AT 100-1K, POT VERNIER AT MIN.
4. VERTICAL AND HORIZONTAL AMP GAIN AT MIN.
5. VERTICAL ATTEN AT INT.
6. SYNC SEL AT INT.
7. VERTICAL AND HORIZONTAL AT THE CENTER.

NOTES:

1. ALL RESISTANCE VALUES ARE IN OHMS
2. ALL RESISTORS ARE 1/2W 10%, UNLESS OTHERWISE SPECIFIED.
3. ALL CAPACITANCE VALUES ARE IN UFD, (MICROFARAD) UNLESS OTHERWISE SPECIFIED.

Figure 11. Model 430 Schematic Diagram

EICO

Service Policy

PARTS REPLACEMENT

If it appears that a component is defective, and you desire a replacement, contact your EICO Distributor, the nearest EICO Authorized Service Agency or our Customer Service Department.

If you are claiming the right to a no-charge replacement under the terms and conditions of the warranty, it is required that you shall have sent in the registration card within 10 days of the date of purchase, and that you send back the defective part transportation prepaid. In claiming warranty service or parts, please send or show your original sales slip plus the IBM card from the carton. EICO or its authorized agency will make the necessary replacement at no charge for parts eligible under the terms and conditions of the warranty. In returning tubes, pack them very carefully to avoid breakage in shipment. Broken tubes will not be replaced. Please read the warranty on the subject of parts eligible for replacement.

Further information required on a part returned for a no charge replacement under the terms and conditions of the warranty is as follows:

- a) Model number and serial number, if any, of unit. Also any code numbers in red under the words INSTRUCTION MANUAL on the cover of the book supplied with the unit or Revision number, such as Rev. 1, Rev. 2, etc.
- b) Stock number and description of part as given on the parts list. If the part is not listed (of itself) in the parts list, it means that the part is integral with a sub-assembly, which we consider replaceable only as an entity. Parts integral with a sub-assembly may be listed in the parts list, so identified, if we consider that some or all of the parts may be individually replaced in the field under appropriate circumstances. If your unit is out of warranty, you are generally advised to order a replacement sub-assembly.
- c) Describe as completely as possible the nature of the defect, or reason for requiring replacement.

REPAIR SERVICE

EICO maintains a national network of authorized service agencies, in addition to repair facilities at the factory, for in-warranty or out-of-warranty repair of EICO equipment. It is intended to serve those customers who are not sufficiently familiar with electronics to make use of the EICO Service Consultation facilities, or whose difficulties cannot be solved by correspondence.

For all out-of warranty units repaired at the factory there is a minimum labor and handling fee. Charges for parts replaced are additional to the minimum fee.

For in-warranty completed kit units repaired at the factory there is a minimum labor and handling fee. There is no charge for a replaced defective part provided that the terms and conditions of the warranty for no charge replacement are not violated in the judgement of EICO.

For in-warranty factory-wired units, there is no charge for labor or parts if the unit complies with the terms and conditions of the warranty in the judgement of EICO. However, if the terms and conditions of the warranty are violated there will be a charge for labor plus parts.

In all cases, the unit must be sent to the factory or service agency transportation prepaid, and the unit will be returned to the customer transportation collect.

On kits, the services rendered for the minimum labor and handling fee by the factory are the correction of any minor wiring errors (not extensive corrections or rewiring), the labor involved in replacing defective parts, and any adjustments, alignment, or calibration procedures that would normally be performed on a factory-wired unit. Units not wired according to instructions, or modified in anyway, or showing evidence of the use of acid core solder, will not be serviced and will be returned to the customer forthwith.

SEE SCHEDULE OF FACTORY SERVICE CHARGES

Units requiring extensive corrections or rewiring will incur an additional labor charge. An advance estimate will be submitted.

Please note: minimum labor and handling fees and service charges are subject to revision at any time.

LOCAL REPAIR FACILITIES

A list of authorized service stations is provided with your manual. The roster of stations may change from time to time, and if considerable time has elapsed since you purchased your unit, you are advised to contact the station you choose before sending the unit to them for repair. Use of a local service station will often result in faster service, and, usually, lower transportation costs.

It is necessary that you comply with the Shipping Instructions that follow when sending in a unit for service.

SHIPPING INSTRUCTIONS

You are strongly advised to retain the original shipping carton and inserts should reshipment be required for service or any other purpose. The carton may be collapsed for storage in as small a space as possible. In very many cases, the same carton is used for kit and factory-wired units so that the kit carton will serve for reshipment of the completed kit.

When sending a unit for service pack the unit very carefully, preferably in the original shipping carton with the original inserts. Be sure to place the bottom plate, cover, and supporting bracket, if any, on the unit before shipping.

If this is not possible, use a strong oversize carton, preferably wood, and using at least 3 inches of resilient packing material such as shredded paper or excelsior inserted between all sides of the unit and the carton. Seal the carton with strong gummed paper tape or strong twine or both. Attach a tag to the instrument on which is printed your name and address and brief reference to the trouble experienced. Affix "FRAGILE" or "HANDLE WITH CARE" labels to at least four sides of the carton or print these words large and clear with a bright color crayon. Ship prepaid.

Include your name and address on the outside of the carton. Return shipment will be made transportation charges collect. Note that a carrier cannot be held liable for damage in transit, if packing, IN HIS OPINION, is insufficient.

EICO THE EICO WARRANTY **EICO**

The Electronic Instrument Company, Inc., hereafter referred to as EICO, warrants that, for a period of 90 days from the date of purchase, any EICO kit will be free of defects in parts, and that any EICO factory-wired unit will be free of defects in parts and workmanship. For an EICO kit, EICO's obligation is limited to those parts which are returned transportation prepaid to the factory or authorized service agency without further damage, and in the judgement of EICO are either originally defective or have become defective in normal use. EICO's obligation does not include any labor required to locate trouble in or repair a kit. For an EICO factory-wired unit, EICO's obligation is limited to replacement or repair, at EICO's option, of those parts, sections, or entire units returned transportation prepaid to the factory or authorized service agency without further damage, and in the judgement of EICO are either originally defective or have become defective in normal use.

The warranty does not apply to any parts damaged in the course of handling, assembling, or wiring by the customer, or damaged due to abnormal usage or in violation of instructions or reasonable practice, or further damaged to a consequential degree in return shipment. Furthermore, the foregoing warranty is made only to the original customer, and is and shall be in lieu of all other warranties, whether expressed or implied, and of all other obligations or liabilities on the part of EICO, and in no event shall EICO be liable for any anticipated profits, consequential damages, loss of time, or other losses incurred by the customer in connection with the purchase or operation of EICO products or components thereof.

The registration card, which accompanies each EICO kit or factory-wired unit, must be filled in and returned to the company within 10 days after the date of purchase. This warranty applies only to registered units.

SCHEDULE OF FACTORY SERVICE CHARGES

(Consult your local EICO authorized service agency for THEIR charges.)

THESE CHARGES SUPERCEDE CHARGES WHICH MAY BE INDICATED IN YOUR MANUAL OR PREVIOUS SCHEDULES.

1. Same prices for wired units or completed kits.
2. Charges are based on the schedule of minimum charges above.
3. All labor charges are calculated at \$7.50 per hour. For example, if the minimum labor and handling fee is \$15.00, this covers up to 2 hours. Any labor time (in this example only) required over 2 hours is charged for at \$7.50 per hour.
4. Above prices are for labor only. Parts are additional.
5. ESTIMATES: An estimate for repairs will be given before repairs are made where repairs will exceed stated minimum charges. If you choose not to have your unit repaired, a charge of \$4.00 for estimating time will be made.
6. All prices are subject to change without notice.

IE 1371-358

MINIMUM LABOR AND HANDLING FEES

CRA & CRU.....	\$ 3.50	488.....	\$ 7.50
Probes.....	3.50	495.....	7.50
AF4.....	11.50	526.....	7.50
RA6.....	7.50	536.....	7.50
HF12.....	11.50	540.....	7.50
HF14.....	7.50	555.....	7.50
HF20.....	15.00	556.....	7.50
HF22.....	7.50	565.....	7.50
HF30.....	7.50	566.....	7.50
HF32.....	14.50	567.....	7.50
HF35.....	7.50	584.....	7.50
ST40.....	22.50	610.....	7.50
HF50.....	7.50	612.....	7.50
HF52.....	15.00	615.....	7.50
HF60.....	7.50	625.....	9.00
HF61.....	9.00	628.....	10.50
HF61A.....	9.00	630.....	7.50
HF65.....	10.00	632.....	10.50
HF65A.....	10.00	636.....	7.50
ST70.....	22.50	666.....	15.00
HF81.....	20.50	667.....	15.00
ST84.....	15.00	680.....	9.00
HF85.....	12.00	706.....	7.50
HF86.....	13.50	710.....	7.50
HF87.....	13.50	711.....	10.50
HF89.....	13.50	712.....	15.00
HFT90.....	11.50	715.....	7.50
HFT92.....	13.50	717.....	11.50
HFT94.....	11.50	720.....	20.50
ST96.....	20.50	722.....	13.50
ST97.....	20.50	723.....	15.00
MX99.....	11.50	730.....	15.00
RP100.....	45.00	740.....	13.50
Playback Amp only.....	11.50	751.....	16.50
Power Supply only.....	11.50	752.....	16.50
Record Amp only.....	11.50	753.....	37.50
Head Alignment only.....	15.00	760.....	13.50
145.....	7.50	761.....	13.50
145A.....	7.50	762.....	13.50
147.....	7.50	770.....	18.00
214.....	9.00	771-2.....	18.00
221.....	9.00	777.....	30.00
222.....	10.50	779, A.....	25.50
232.....	9.00	791.....	7.50
235.....	10.50	803.....	7.50
249.....	9.00	888.....	9.00
250.....	10.50	902.....	37.50
255.....	10.50	944.....	7.50
260/261.....	10.50	950.....	7.50
315.....	9.00	955.....	9.00
320.....	7.50	965.....	22.50
322.....	7.50	1020.....	7.50
324.....	7.50	1030.....	15.00
342.....	22.50	1040.....	11.50
352.....	7.50	1050.....	7.50
360.....	7.50	1055.....	7.50
368.....	19.00	1060.....	7.50
369.....	19.00	1064.....	9.00
377.....	9.00	1073.....	7.50
378.....	10.50	1078.....	7.50
380.....	24.00	1100.....	7.50
425.....	9.00	1120.....	7.50
427.....	19.00	1140.....	7.50
430.....	19.00	1171.....	7.50
435.....	22.50	1180.....	7.50
460.....	22.50	2036.....	20.50
470.....	22.50	2050.....	20.50
		2080.....	20.50
		2200.....	15.00
		2400.....	30.00
		2510.....	18.00
		2536.....	26.50
		2715/16.....	15.00
		3070.....	18.00
		3200.....	18.00
		3566.....	37.50
		3570.....	39.50
		4000.....	30.00
		7923.....	28.50

ADDITIONAL TROUBLESHOOTING DATA FOR SLO OSCILLOSCOPE and 421K 1 MILLICR SEC

Prior to trouble shooting your Oscilloscope, we advise you to check and double check your wiring. Don't assume anything to be correct. We have found the majority of troubles encountered in scope kits are due to incorrect wiring. Once the wiring has been found to be correct, check every soldered joint both visually and mechanically. Although a soldered connection appears to be good, it may, due to an excess amount of rosin, fail to make a good electrical contact.

A "Rosin Connection" may best be determined by gently pulling on the wire or part which has been soldered.

Below you will find a listing of possible troubles and their probable causes.

<u>SYMPTOM</u>	<u>PROBABLE CAUSE</u>	<u>SUGGESTED PROCEDURE</u>
1. Fuse in AC line blows	(a) Short at fuse block	(a) Clean fuse holder of all excess
2. Pilot light and tubes do not light	(a) Open circuit or rosin joint in filament circuit (b) On-off switch defective (c) Line cord defective	(a) Resolder all filament connections (b) Replace (c) Replace plug
3. Power transformer quakes: TURN OFF IMMEDIATELY	(a) Shorted filter condensers (b) Shorted high voltage condenser	(a) Replace filter condensers C10, C11, C12 (b) Replace condenser C7
4. Intensity control burns out	(a) Short to ground (b) Defective control	(a) check lead going from junction of R20, R21 and R46 to the cathode of CRT (b) Replace R21
5. Positioning not proper	(a) Positioning control defective (b) Defective 5W rectifier (c) Resistor R17 open or shorted (d) Resistors R24 or R25 open or shorted	(a) Replace R13A & B for vertical; R27A & B for Horizontal (b) Replace (c) Replace with 100K- $\frac{1}{2}$ W resistor (d) Replace with 100K- $\frac{1}{2}$ W resistor
6. Poor focusing	(a) Defective resistors in high voltage circuit	(a) Carefully measure values of R17, R18, R19 & R20. If more than 20% off, replace with correct values.

Note: Before making any changes, turn power off and short the HV condenser to ground (remove the short before turning power on again)

WESTERN ELECTRIC LIMITED

TROUBLE SHOOTING DATA FOR EICO MODELS 425 and 425K OSCILLOSCOPES

<u>SYMPTOM</u>	<u>PROBABLE CAUSE</u>	<u>SUGGESTED PROCEDURE</u>
7. No sweep (only a vertical line or dot on the screen; no horizontal trace)	(a) Switch S3 defective (b) Resistor R39 open (c) Resistor R39 defective	(a) Replace (b) Replace (c) Replace
8. One sweep range inoperative	(a) Defective condenser in that range	(a) Range 1-Replace C19 Range 2-Replace C20 Range 3-Replace C21 Range 4- Replace C22 Range 5-Replace C23 or C24
9. No vertical input	(a) Shorted vertical input jack (b) Defective 6J5, V1 (c) Defective 6SN7, V2	(a) Replace shoulder washer on jack (b) Replace (c) Replace
10. No Horizontal input	(a) Shorted horizontal input jack (b) Defective 6J5, V5 Defective 6SN7, V3	(a) Replace shoulder washer on jack (b) Replace (c) Replace
11. Non-linear horizontal sweep	(a) R33 or R34 defective	(a) Replace
12. Excessive transformer hum	(a) Loose connections on transformer	(a) Tighten nuts and bolts on transformer

* For a more detailed description of sweep, see pages 4,5,6 and 7 of the instruction manual.

If you are not too familiar with oscilloscope operation, it is suggested that you consult pages 2 --- 8 in the instruction manual.

If none of the above symptoms or remedies help you to obtain satisfactory results, write our Engineering Department giving all symptoms and information possible, e.g. voltages, visual indication, etc. or any other which will help diagnose the trouble.

If desired, your instrument may be returned to the factory. It will be put in operating condition for a charge of \$5.00 plus any parts or alterations required due to damage or improper construction. Pack well and mark fragile. Ship prepaid. The instrument will be returned as soon as possible.

Electronic Instrument Co., Inc.
84 Withers Street
Brooklyn 11, New York

November 6, 1953

CRG/ab

MODEL PLC PROBE ADDENDA

Please use the following illustration in place of Figure 4 when wiring the 33M ohms resistor to the trimmer capacitor leads. NOTE that resistor is repositioned to permit the assembly to be inserted easily into the probe housing.

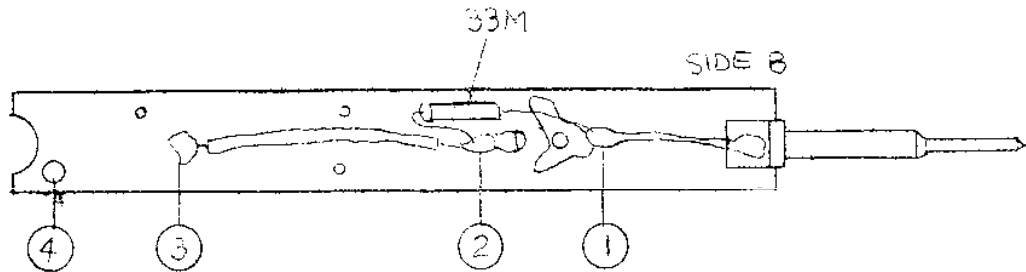

I.E. 1558 EICO Electronic Instrument Co., Inc. 131-01 39th Ave.,
Flushing, N. Y.

LOW CAPACITY PROBE-CONSTRUCTION ADDENDUM

Please read this before starting the construction:

The trimmer capacitor is now supplied pre-assembled to the terminal board. As a result, the following changes should be noted on the construction sheet:

- a) The trimmer ring listed in the Parts List is now omitted and the reference to "placing the trimmer ring around the body of the trimmer" is now disregarded.
- b) Disregard the trimmer mounting instructions (and Fig. 1).
- c) Disregard the note just below Fig. 4.

I.E. 1051 EICO Electronic Instrument Co., Inc., 131-01 39th Ave.,
Flushing, N. Y.



* DC input resistance - 10 MΩ internal plus 1 MΩ in the regular DC or AC/DC probe.
 ** DC input resistance - 10 MΩ internal plus 15 MΩ in the regular DC or AC/DC probe.

SCOPE DIRECT PROBE: One model, PD, may be used with any oscilloscope.

SCOPE LOW CAPACITY PROBE: One model, PLC, may be used with any oscilloscope.

SCOPE DEMODULATOR PROBE: One model, PSD, may be used with any oscilloscope.

Model PTF-25 may be used with any 25 MΩ ** VTVM including the following: EICO 214-221, RCP 345.

Frontic Designs 100, Heath V6, RCA WV 77A, Simpson 303.

Model PTF-11 may be used with any 11 MΩ * VTVM requiring adaptation for peak-to-peak voltage readings including the following: Elec-

VTVM PEAK-TO-PEAK PROBE: Two models, PTF-11 and PTF-25, to accommodate most VTVMs in current use.

Model PRF-25 may be used with any 25 MΩ ** VTVM including the following: EICO 214-221, RCP 345.

709, RCA WV 77A - WV 87A - WV 97A, RCP 655, Simpson 303, Triplett 650.

Model PRF-11 may be used with any 11 MΩ * VTVM including the following: Electronic Designs 100, Heath V6, Hickock 215, Jackson

VTVM RF PROBE: Two models PRF-11 and PRF-25, to accommodate most VTVMs in current use.

EICO VTVM and OSCILLOSCOPE PROBES

ALL 5 EICO VTVM & SCOPE-MATE PROBES HAVE THESE EXTRA CONSTRUCTION FEATURES*

- ★ FULLY SHIELDED from input to output by anodized aluminum housing, co-axial cable
- ★ TERMINAL BOARD MOUNTING of all components
- ★ EXCLUSIVE FLOATING CONSTRUCTION to increase ruggedness
- ★ ALL PARTS ACCESSIBLE for easy inspection and maintenance
- ★ COLOR CODED for easy identification

EICO HIGH-VOLTAGE PROBES



Model HVP-1 Deluxe

\$6⁹⁵



Model HVP-2
safe, light-weight, low cost

\$4⁹⁵

For any VTVM or VOM of 20,000 ohms/volts sensitivity or better. Provides safe accurate TV high voltage measurements up to 30,000 VDC. Multiplier resistors available for practically all instruments.

*Patent applied for



VTVM & Oscilloscope Probes INSTRUCTION BOOK

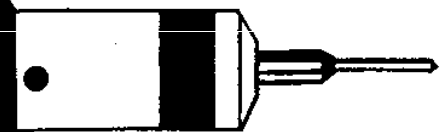

VTVM RF PROBES

VTVM PEAK-TO-PEAK PROBES

For all 11 & 25 megohm DC input VTVMs

OSCILLOSCOPE DEMODULATOR PROBE

OSCILLOSCOPE LOW CAPACITY PROBE

OSCILLOSCOPE DIRECT PROBE

For all oscilloscopes

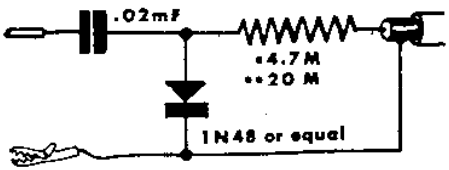
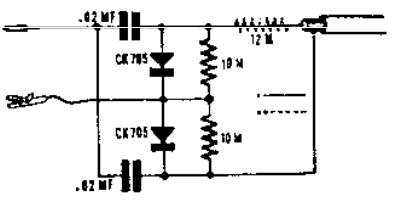
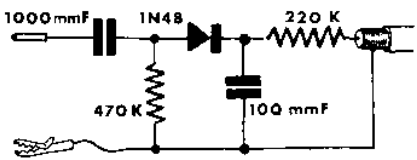
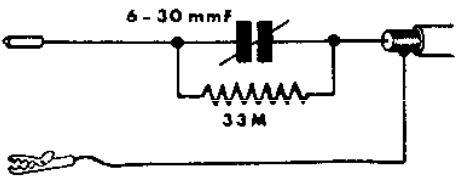
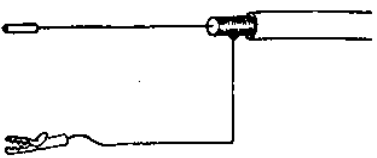
PROBE TYPE	FUNCTION
<p style="text-align: center;">VTVM RF</p>  <p>• MODEL PRF-II •• MODEL PRF-25</p>	<p>RF voltage measurement to 250 mc. Very useful for measurements in all TV & radio RF & IF stages.</p>
<p style="text-align: center;">VTVM PEAK TO PEAK</p>  <p>• MODEL PTP-II •• MODEL PTP-25</p>	<p>Peak-to-peak voltage measurement of complex TV waveforms. Operations over frequency range from 5 kc to 5 mc to cover all TV servicing requirements.</p>
<p style="text-align: center;">SCOPE DEMODULATOR</p>  <p>MODEL PSD</p>	<p>Demodulates amplitude-modulated carriers between 150 kc and 250 mc. Permits your scope to be used as a waveform tracer, gain analyzer, and alignment indicator in all TV & radio RF & IF stages. Audio response practically flat from 20 cps to 6 kc includes both high and low frequency components of demodulated 60 cycle square wave to make this probe particularly good for observation of sweep curve response.</p>
<p style="text-align: center;">SCOPE LOW CAPACITY</p>  <p>MODEL PLC</p>	<p>High impedance--low capacity probe, extremely useful for tracing waveforms in high impedance, high frequency, and wide-band circuits (such as are found in TV) without distortion from overloading or frequency discrimination. (A variable ceramic capacitor provides adjustable frequency compensation.) Particularly valuable for TV sync signal tracing and general tests in video, sync, and sweep circuits.</p>
<p style="text-align: center;">SCOPE DIRECT</p>  <p>MODEL PD</p>	<p>Direct test probe for use in low frequency or low impedance circuits where direct connection to the test point is required in order to utilize maximum scope sensitivity and where the added input capacity contributed by the co-axial cable is unimportant.</p>

LLOSCOPE PROBES

MAX. INPUT	PROBE OUTPUT	REMARKS
30 volts RMS, and/or 600 VDC	Negative DC volts equal to RMS value of RF voltage.	1) Set VTVM for reading negative DC volts. RMS value of RF voltage read directly on DC scales without any need for multiplying factors. 2) If the peak value of an RF voltage is desired, multiply the RMS value by 1.414. 3) To measure AC voltages with frequencies below 1000 cps, use the regular VTVM AC voltage measurement facilities as readings with the probe below this frequency are low.
80 volts peak- to-peak and/or 600 VDC	Negative DC volts equal to peak-to- peak voltage of any waveform, complex or sine.	1) Set VTVM for reading negative DC volts. Peak-to-peak volts read directly on DC scales without any need for multiplying factors. 2) Special calibration required to read voltages below 5 volts peak-to-peak as non-linearity of crystal diodes causes low probe readings at low voltages. 3) Do not make any connection with VTVM common lead.
30 volts RMS, and/or 300 VDC	Low-frequency modulating signal (envelope of carrier) plus DC proportional to amplitude of RF carrier.	In general, standard RF signal tracing methods may be used. However, if signal tracing is required in TV RF circuits, it will usually be necessary to use a swept signal instead of the TV station signal to obtain adequate deflection on the scope.
	Same as input but reduced by probe attenuation.	See description of techniques for frequency compensation and possible adjustment of probe attenuation.
	Same as input.	Two terminals are riveted to the terminal board of this probe. If a direct probe (straight-through connection) is desired, these terminals are not used. If a resistive isolating probe is desired, connect a 50 K Ω , 1/2W resistor between these terminals and then solder the inner conductor of the probe cable and a jumper soldered to the probe tip to opposite ends of the 50 K Ω resistor. The resistive isolating probe is used for testing at the converter grid or TV front ends (the resistor suppresses any tendency toward oscillation due to feed back) and may also be used to filter out the high-frequency components from beat markers to yield a sharp marker on the scope screen.

LOW - CAPACITY PROBE CONSTRUCTION

Unpack the kit and check each part against the following parts list.

PARTS LIST

Stock #	Description	Amt.	Stock #	Description	Amt.	Stock #	Description	Amt.
89507	probe shell (L-C)	1	42019	rubber washer	1	10401	res., 33 MΩ	1
89511	nose-piece	1	51500	alligator clip	1	29506	trimmer cap., 6-30mmf	1
89512	probe tip	1	58403	co-axial cable	1	89514	trimmer ring	1
54506	term. board (L-C)	1	58002	stranded wire	pc	46001	1/4" grommet	1
47001	spring	1	58000	hook-up wire	pc			

NOTE: When ordering replacement parts, please include the stock number of the part and the description given in the parts list.

Follow the step-by-step assembly and wiring procedure that follows closely and carefully for best results. **IMPORTANT:** USE THE BEST GRADE OF FROSIN CORE SOLDER ONLY, preferably one containing the new activated fluxes such as Kester "Resin-Five", Ersin "Multicore" or similar types. **UNDER NO CONDITION USE ACID CORE SOLDER OR ACID FLUX** since acid flux can cause serious corrosion. If for any reason it is necessary to resolder a joint, be sure to use new solder.

Construction is begun by mounting the parts on the terminal board as shown in Figs. 3 and 4. First, install the trimmer capacitor on side A of the board (Fig. 3--same side solder lug is on) as shown in Fig. 1. To do this, hold the top and bottom plates of the trimmer in the board as indicated and then slide the retaining terminal clip in place to secure the assembly*. Bend the terminal lugs away from each other on side B of the board. Then press fit the probe tip into the rectangular notch at one end of the board as shown in Fig. 2.

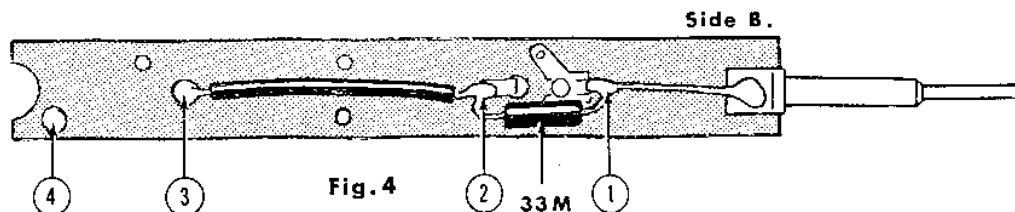
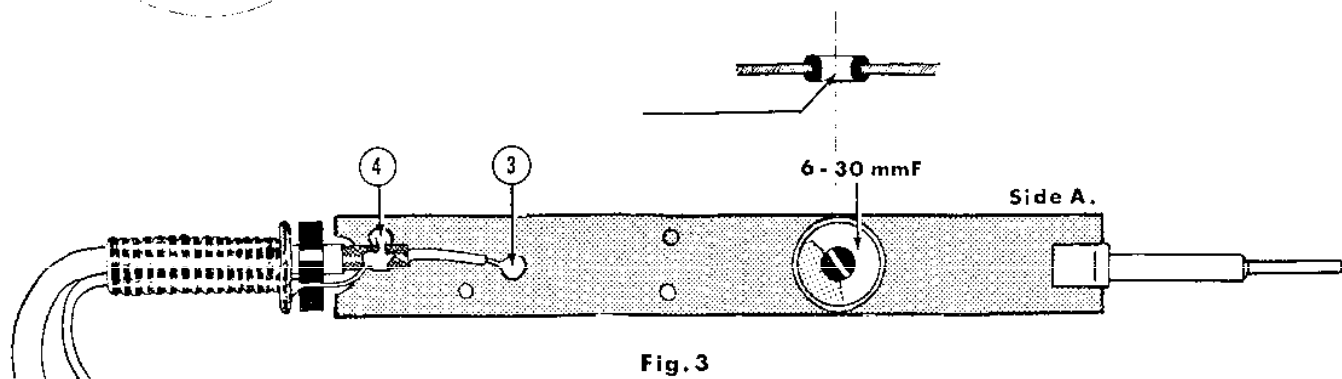
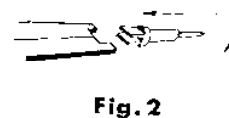
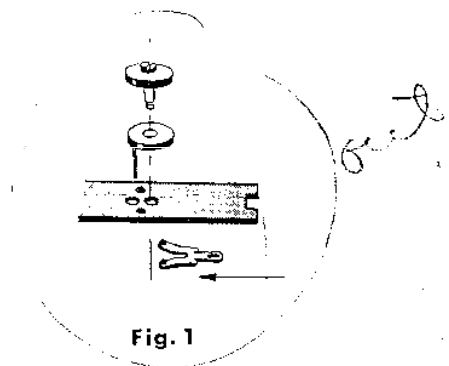

NOTE: The trimmer capacitor as found in the kit has been pre-assembled to a small bakelite board to permit factory testing. Before proceeding with assembly to the probe terminal board as instructed, the trimmer capacitor must be disassembled by sliding out the retaining terminal clip. Discard the small board.

On side B of the board (Fig. 4), solder one end of a bare wire jumper to the flat shank of the probe tip and connect the other end to the retaining terminal clip of the trimmer (terminal 1). Then connect the 33 MΩ resistor** between terminal 1 and terminal 2 (other trimmer capacitor terminal). On side B also, connect a hook-up wire jumper between terminal 2 of the trimmer and terminal 3 on the board. Solder trimmer terminals 1 & 2 and then lay terminal board aside.

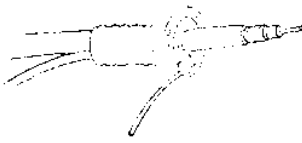
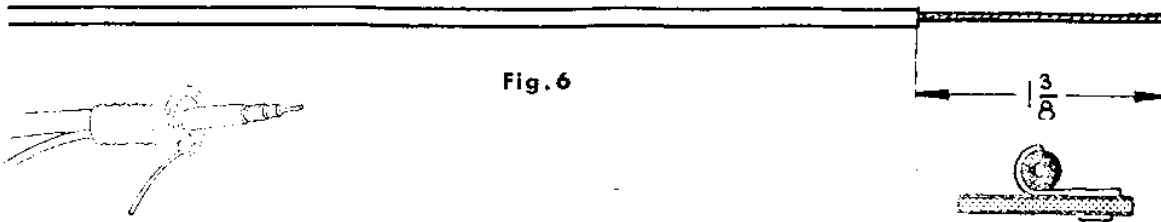
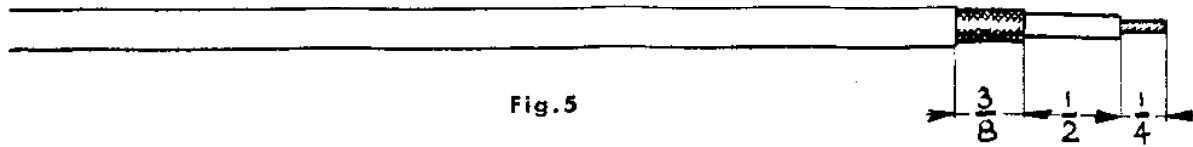

Fig. 7

Fig. 8

Strip the co-axial cable and the ground lead (stranded wire) as shown in Figs. 5 and 6. Position the ground lead in the spring as shown in Fig. 7, and solder it to the spring, as shown, at the point indicated in the drawing. Then insert the co-axial cable in the spring as shown in Fig. 7. Push the rubber washer over the stripped end of the co-axial cable on to the outside insulation and position it as shown in Fig. 3. Next position the stripped end of the co-axial cable so that the end of the outside insulation rests inside the semi-circular notch in the end of the terminal board and the outside braid lays across the solder lug. (Check to see that the inner co-axial conductor reaches eyelet 3.) Then bend the solder lug over to grip the cable braid (Fig. 8 is a profile view) and solder the connection, keeping in mind that overheating will soften the inner co-axial insulation with the consequent danger of a short. Bring the stripped end of the ground lead (extending from the solder point on the spring) around the outside of the rubber washer and insert it in eyelet 4 (Fig. 3), after which solder eyelet 4. Insert the inner conductor of the co-axial cable in eyelet 3 (Fig. 3), after which solder eyelet 3. Next, Place the trimmer ring around the body of the trimmer. This insulating ring prevents accidental shorting between the trimmer and the probe shell.

To complete the construction, pass the free ends of the co-axial cable and the ground lead through the probe shell from the threaded end. Then grasp the probe tip with one hand, and with the other hand move the shell down over the probe body (use a rocking motion and do not force) until the large end of the spring is flush against the rolled-over end of the shell. Position the small hole in the shell directly over the head of the trimmer adjusting screw and insert the 1/4" rubber grommet. Then pass the plastic nose-piece over the probe tip and screw it into the shell (see Fig. 9). At the opposite end of the cable, strip away 3" of outer insulation and 2 1/2" of the outer braid. Cut off 3 1/2" of stranded wire and strip off 1/2" of insulation from one end. Wrap the stripped end around the exposed cable braid and solder, being careful not to overheat the cable. Finally solder a spade lug to the opposite end of this lead and to the inner conductor of the co-axial cable (see Fig. 9). Now proceed with the adjustment instructions given in the instruction sheet.

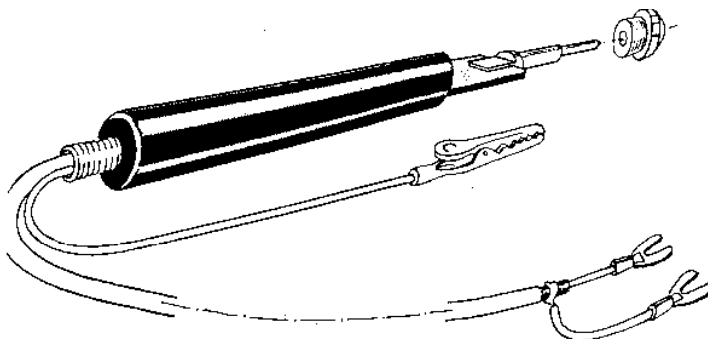

Fig. 9

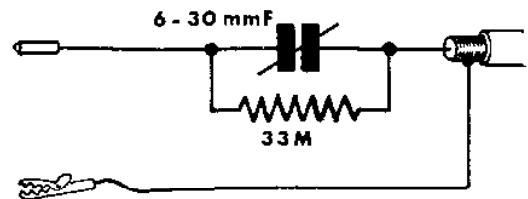

Fig. 10

** Refer to "Low-Capacity Probe Adjustment" in your instruction sheet before performing this step.



ELECTRONIC INSTRUMENT CO.

EICO MODELS P-75 AND P-76 HIGH FREQUENCY RF PROBE

SPECIFICATIONS:

1. Frequency Range: 20 cycles to over 200 MC
2. Effective circuit loading: 3 MMFD and 1 Megohm
3. P-75 with phone plug for VTVM's
4. P-76 with pin tips for oscilloscopes

P-75-DIRECTIONS FOR USE WITH THE VTVM

To use the P-75 RF probe with your VTVM-----

- (1) Set the FUNCTION switch at the DC position.
- (2) Attach the test lead from COMMON to the chassis (ground) of the equipment under test or to the low voltage terminal of the component across which the voltage is to be measured.
- (3) Insert the phone plug on the RF probe in the DC Volts jack.
- (4) Place the tip of the probe at the point (high voltage terminal of the component) where RF voltage is to be measured. A 400 W. V. D. C. blocking capacitor in the probe protects the crystal from D-C voltage.

The voltage ranges marked on the dial of the RANGE switch must be divided by five to obtain the ranges in r.m.s. volts when the VTVM is used with the RF probe. See the table below for the actual maximum value of r.m.s. RF voltage that can be measured at any RANGE switch setting. For example, if the RANGE switch is set at 5 volts, the meter will deflect full scale when the RF voltage across the probe and COMMON has an r.m.s. value of 1 volt. (The probe responds to peak RF voltage but is designed to give an r.m.s. reading on the meter.)

RANGE SWITCH SETTING	ACTUAL VALUE OF RANGE WHEN PROBE IS USED	SCALE ON THE VTVM TO BE READ	MULTIPLY READING BY	READ IN
5 volts	1 r.m.s. volt	0 to 10 figures on DC scale (black)	0.1	r.m.s. volts
10 volts	2 r.m.s. volts		0.2	
100 volts	20 r.m.s. volts		2	
500 volts	100 r.m.s. volts		10	

WARNING: Do not use the probe to measure RF voltage over 50 r.m.s. volts or you will seriously damage the crystal.

P-76-DIRECTIONS FOR USE WITH THE OSCILLOSCOPE

To use the P-76 RF probe with your oscilloscope-----

- (1) Attach the pin tip that is connected to the co-axial lead (inner conductor) of the probe cable to the vertical deflection Input post.
- (2) Attach the pin tip that is connected to the braided shield of the probe cable to the ground post of the oscilloscope.
- (3) Connect the oscilloscope ground to the chassis (ground) of the equipment under test or to the low voltage terminal of the component across which the wave shape of the signal is to be observed.
- (4) Place the tip of the probe at the point (high voltage terminal of the component) where it is desired to observe the wave shape of the signal.

Electronic Instrument Co., Inc.
84 Wighers Street
Brooklyn 11, New York

MODEL P-75 & P-76 RF PROBE

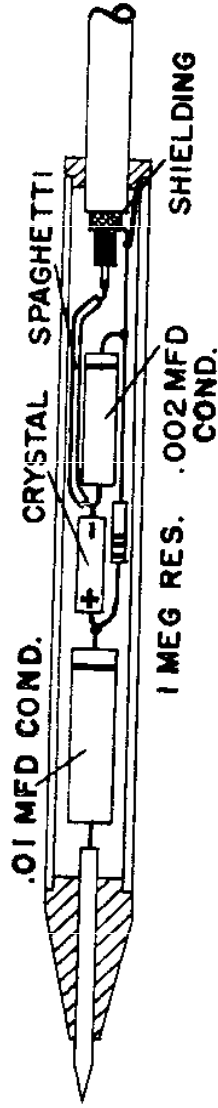

P-76

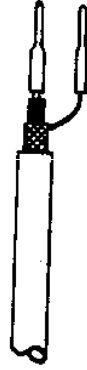

P-75

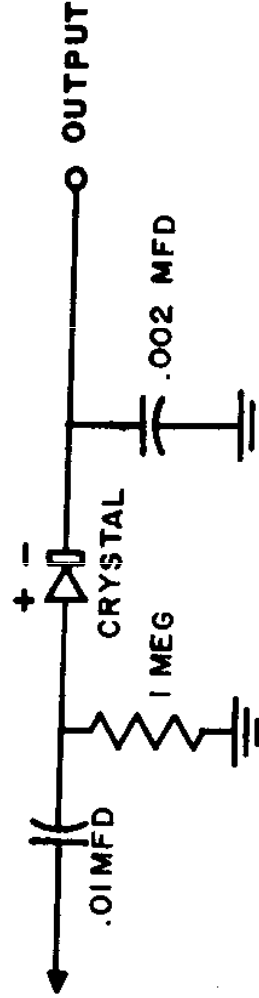

CIRCUIT DIAGRAM



NOTES:

1. DO NOT OVERHEAT RECTIFIER
2. KEEP LEADS SHORT AND RIGID

ELECTRONIC INSTRUMENT
CO., INC.
BROOKLYN, N.Y.

DIRECT PROBE CONSTRUCTION

Unpack the kit and check each part against the following parts list.

PARTS LIST

Stock#	Description	Am't.	Stock#	Description	Am't.
89506	probe shell (Dir)	1	42019	rubber washer	1
89511	nose-piece	1	51500	alligator clip	1
89512	probe tip	1	58403	co-axial cable	pc
54508	term. board (Dir)	1	58002	stranded wire	pc
47001	spring	1	43005	spade lug	2

NOTE: When ordering replacement parts, please include the stock number of the part and the description given in the parts list.

Follow the step-by-step assembly and wiring procedure that follows closely and carefully for best results. **IMPORTANT: USE THE BEST GRADE OF ROSIN CORE SOLDER ONLY**, preferably one containing the new activated fluxes such as Kester "Resin-Five", Ersin "Multicore" or similar types. **UNDER NO CONDITION USE ACID CORE SOLDER OR ACID FLUX** since acid flux can cause serious corrosion. If for any reason it is necessary to resolder a joint, be sure to use new solder.

Construction is begun by stripping the co-axial cable and ground lead as shown in Figs. 1 and 2. Then position the ground lead in the spring and solder it to the spring as shown in Fig. 3. Now insert and position the co-axial cable in the spring, as shown in Fig. 3, and slip the rubber washer in place as shown in Fig. 4. Next, position the co-axial cable on the terminal board and then bend over the solder lug to grip the outside cable braid, all as shown in Fig. 4. (Fig. 6 is a profile view). Solder the connection, keeping in mind that overheating will soften the inner co-axial insulation with the consequent danger of a short. Then bring the stripped end of the ground lead (extending from the solder point on the spring) around the outside of the rubber washer and solder it to the eyelet which secures the solder lug to the terminal board. Finally, press fit the probe tip into the rectangular notch at the opposite end of the terminal board, as shown in Fig. 7, and solder the inner conductor of the co-axial cable to it as shown in Fig. 4.

Pass the free ends of the co-axial cable and the ground lead through the probe shell from the threaded end. Then grasp the probe tip with one hand and with the other hand move the shell down over the probe body with a rocking motion and without forcing. When the large end of the spring is flush against the rolled over end of the shell, pass the plastic nose-piece over the probe tip and screw it into the shell (see Fig. 8). At the opposite end of the cable, strip away 3" of outer insulation and 2 1/2" of the outer braid. Cut off 3 1/2" of stranded wire and strip off 1/2" of insulation from one end. Wrap the stripped end around the exposed cable braid and solder, being careful not to overheat the cable. Finally solder a spade lug to the opposite end of this lead and to the inner conductor of the co-axial cable (see Fig. 8).

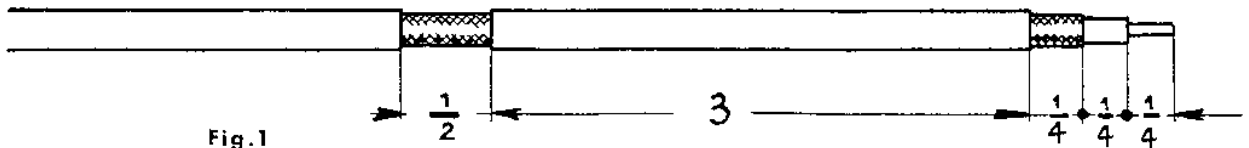

Fig. 1

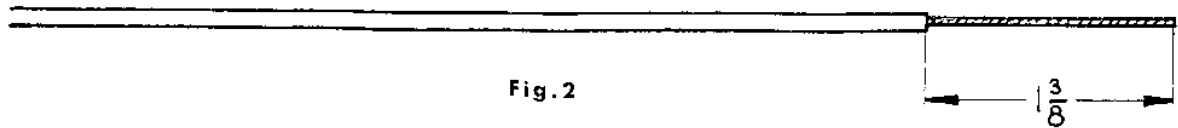

Fig. 2

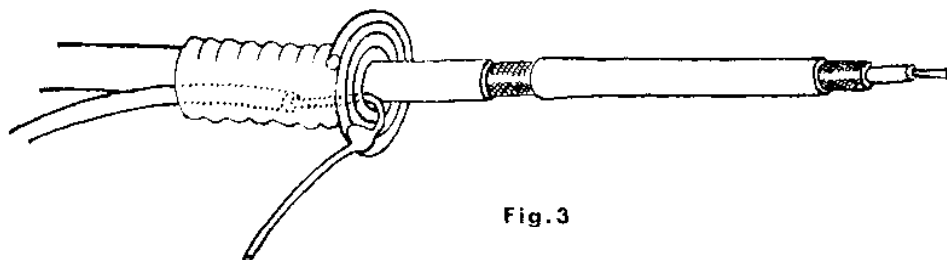
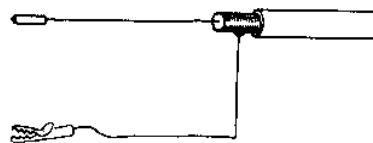
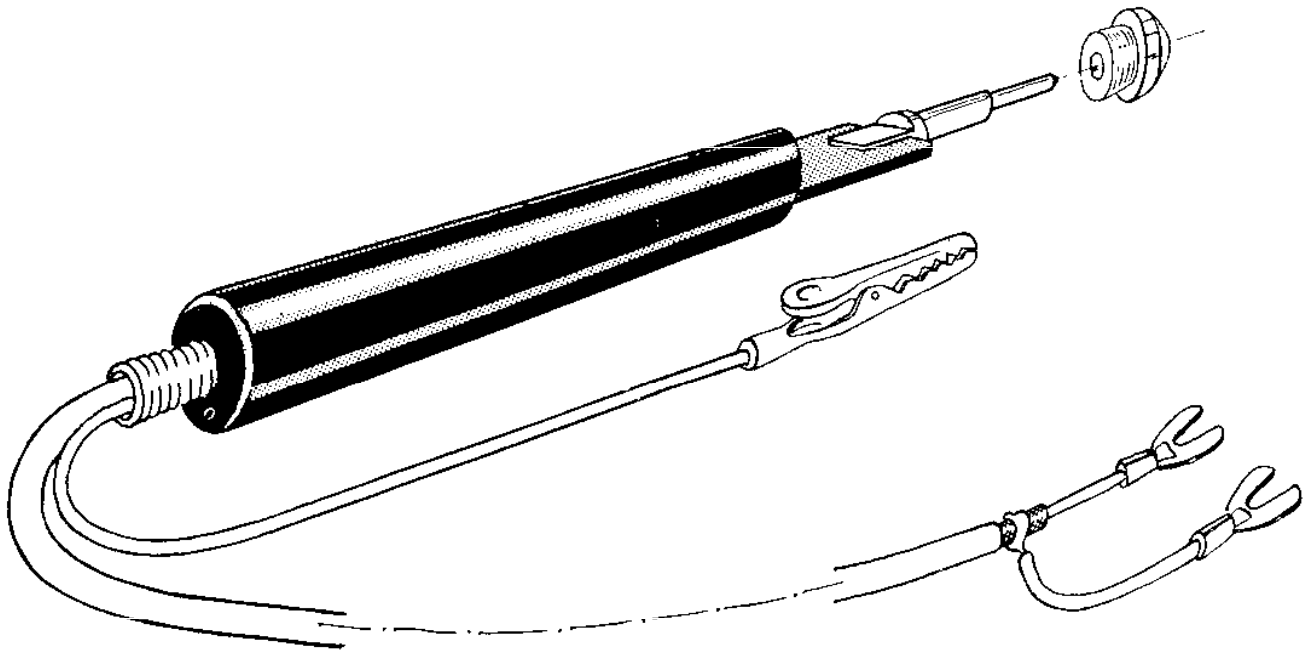
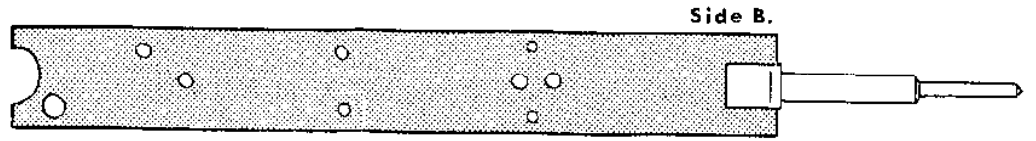
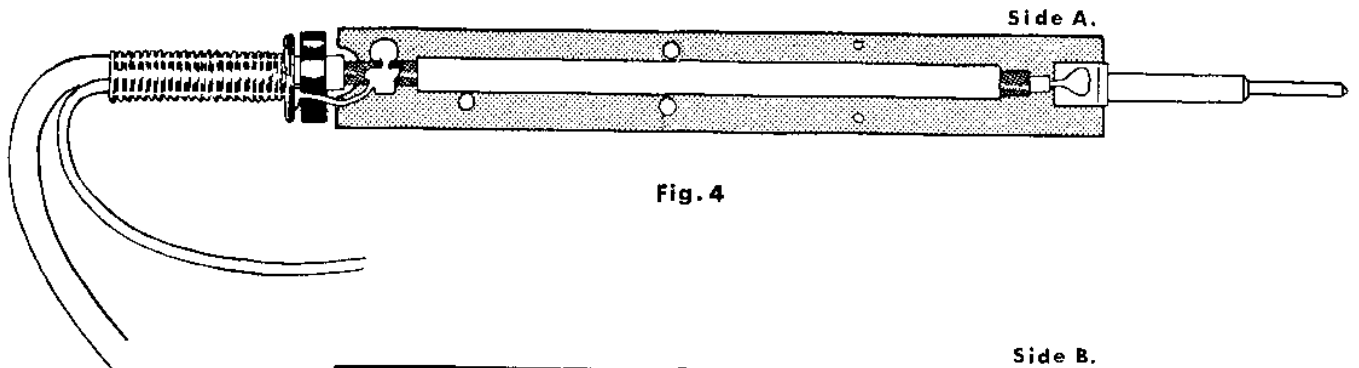

Fig. 3



EICO

ELECTRONIC INSTRUMENT CO.,

MODEL 430 ADDENDUM

Please make the following changes in your Instruction Manual:

Page 18 Replacement Parts List: Change C3, 22 from 20050 to 20044 capacitor, paper, .25ufd, 400V 2
Change R15, 16 from 10851 resistor, 22K Ω , 1W to 10958 resistor, 22K Ω , 2W
Change R20, from 10415 resistor, 4700 1/2W to 10418 resistor, 4.7M.
Change R33 from 10442 resistor, 1500 Ω to 10435 resistor, 150K Ω
Change 41089 screw #6-32 x 3/16 Rd. Hd. to 41126 screw #6-32 x 3/16 Type F, Rd. Hd.

Page 22, Schematic Diagram: Change R15 and R16 from 1W to 2W
Change R33 from 1500 Ω to 150K Ω
Change C26 from .25ufd to .025ufd
From V7 pin #1 at the end of the arrow change #10 to #9.
From V7 pin #6 at the end of the arrow change #9 to #10.
From R17 at the end of the arrow change pin #6 to pin #7.
From R18 at the end of the arrow change pin #7 to pin #6.

If you have the kit, please make the following changes in your Construction Steps Manual:

Page 9, Figures C & D should be reversed.
Page 12, Step 12: Change XV1 to read XV6.
Page 12, Step 13: Change XV2 to read XV7.
Page 12 Step 14: Change XV3 to read XV2.
Page 12, Step 15: Change XV6 to read XV3.
Page 12, Step 17: Change XV7 to read XV1.
Page 14, Steps 3, 4 and 5: Change Step 3 to Step 2.
Page 17, Step 10: Change XV5-1 (C) to XV5-1 (S2).
Page 19, Step 6: Use thick GREY wire instead of thin GREY wire.
Page 19, Step 10: Change C3 from 200V to 400V.
Page 20, Step 17: Change C22 from 200V to 400V.
Page 21, Step 10: Change TB7-4 (C) to TB7-4 (S3).
Page 21, Step 11: Change XV7-7 (S2) to read XV7-7 (S3).
Page 22, Step 17: Change R43 to R34.
Page 23, Step 12: Add this sentence to the first line:

"Position the transformer so that the RED leads pass through the transformer shell closest to the rear apron of the chassis (on which the fuseholder has been previously been mounted)."

Page 24, Step 15: Change XV1-2 (S1) to XF1-2 (S1).
Page 24, Step 16: Change TB10-3 (S4) to TB10-3 (S5).
Page 24, Step 2: Change TB1-1 (S1) to TB1-1 (S2).

- Page 25, Step 4: Change TB2-3 (S3) to TB2-3 (S4).
- Page 25, Step 12: Change R33 from 1500 Ω to 150K Ω , brown, green, yellow, silver.
- Page 26, Step 1: Use Figure 15, Page 13 for proper lug location of capacitor C14.
- Page 27, Second Sentence: Change R46-1 (S1) to R46-3 (S1).
- Page 27, Fifth Sentence: Change S1A-11 to S3A-11.
- Page 27, 7th Sentence: Change S1A-10 to S3A-10.
- Page 27, Figure 13, Steps 2, 3 and 4: Change S1A to S3A.
- Page 28, Step 5: Change R46-3 to R46-1.
- Page 28, Step 7: Change S1A to S3A.
- Page 28, Step 1, 3rd Sentence: Change R12-2 to read R21-2
- Page 29, Step 1, 1st Sentence: Change S2-3 (S1) to S2-3 (C).
- Page 29, 2nd Sentence: Change S2-6 (S1) to S2-6 (C).
- Page 30, Step 9: Change XV9-6 to XV9-7.
- Page 30, Step 10: Change XV9-7 to XV9-6.
- Page 30, Step 12: Change XV9-9 to XV9-10.
- Page 30, Step 13: Change the sentence to read: "Connect the thick GREEN wire to XV9-9 (S1)."
- Page 32, 1st Sentence: Change XV8-1 to XV8-7.

Please make the following changes in your Construction Figures:

- Page 2, Fig. 2: Change #18 next to the transformer to #12.
- Page 5, Fig. 5: Delete from the diagram the wire that is connected from XV5-2 to XV5-7.
- Page 7, Fig. 7: Change the color of the violet wire that is connected from R41-2 to XV6-7 to read "BLUE".
Change the voltage of the capacitor in Step 10 and Step 17 from 200V to 400V.
- Page 9, Fig. 9: Change the resistor value in Step 8 from 270 Ω to 270K Ω .
- Page 10, Fig. 10: Change the value of the resistor in Step 12 from 1500 Ω to 150K Ω . The 15K resistor that is connected from XV7-3 to lug "R" should have a circled #15.
- Page 11, Fig. 12: Reroute the green wire that is connected to R46-1 to R46-3.
Change S1 to read S3.
- Page 12, Fig. 13: Reroute the 68K Ω resistor that is connected to R46-3 to R46-1.
Change S1 to read S3.
- Page 13, Fig. 16: Reroute the red wire that is connected to XV9-7 to XV9-6.
Reroute the orange wire that is connected to XV9-6 to XV9-7.
Reroute the grey wire that is connected to XV9-10 to XV9-9.
Reroute the blue wire that is connected to XV9-9 to XV9-10.
- Page 14, Fig. 17: The handle mounting bracket is shown in reverse. Rotate 180 $^\circ$ so that the mounting holes appear between the two rings.

EVERYTHING 4 LESS



ENJOY YOUR BOOKS



PLEASE VISIT OUR STORE FOR EVEN MORE GREAT STUFF!

WWW.EVERYTHING4LESSSTORE.COM

COPYRIGHT NOTICE

ALL MATERIALS INCLUDING CD/DVD AND PDF FILES ARE COPYRIGHTED

WWW.EVERYTHING4LESSSTORE.COM VON WALTHOUR PRODUCTIONS AND MAY NOT BE REPRODUCED, COPIED OR RESOLD UNDER ANY CIRCUMSTANCES. YOU MAY HOWEVER MAKE A COPY FOR YOUR OWN PERSONAL BACKUP. MATERIALS ARE FOR PERSONAL USE ONLY.

IF YOU PURCHASED THIS FROM ANYWHERE BUT FROM US PLEASE NOTIFY US IMMEDIATELY SO THAT WE MAY CHECK IF YOU PURCHASED FROM AN AUTHORIZED RESELLER SO WE CAN LET YOU KNOW IF YOU NEED TO RETURN FOR FULL REFUND FROM AN UNAUTHORIZED SELLER.

THANKS AGAIN AND PLEASE TAKE THE TIME TO VISIT OUR STORE.

ATTENTION! EVERYTHING ON SALE NOW!!



HOT SALE!

**THIS PAGE COPYRIGHT VON WALTHOUR PRODUCTIONS
WWW.EVERYTHING4LESSSTORE.COM**