

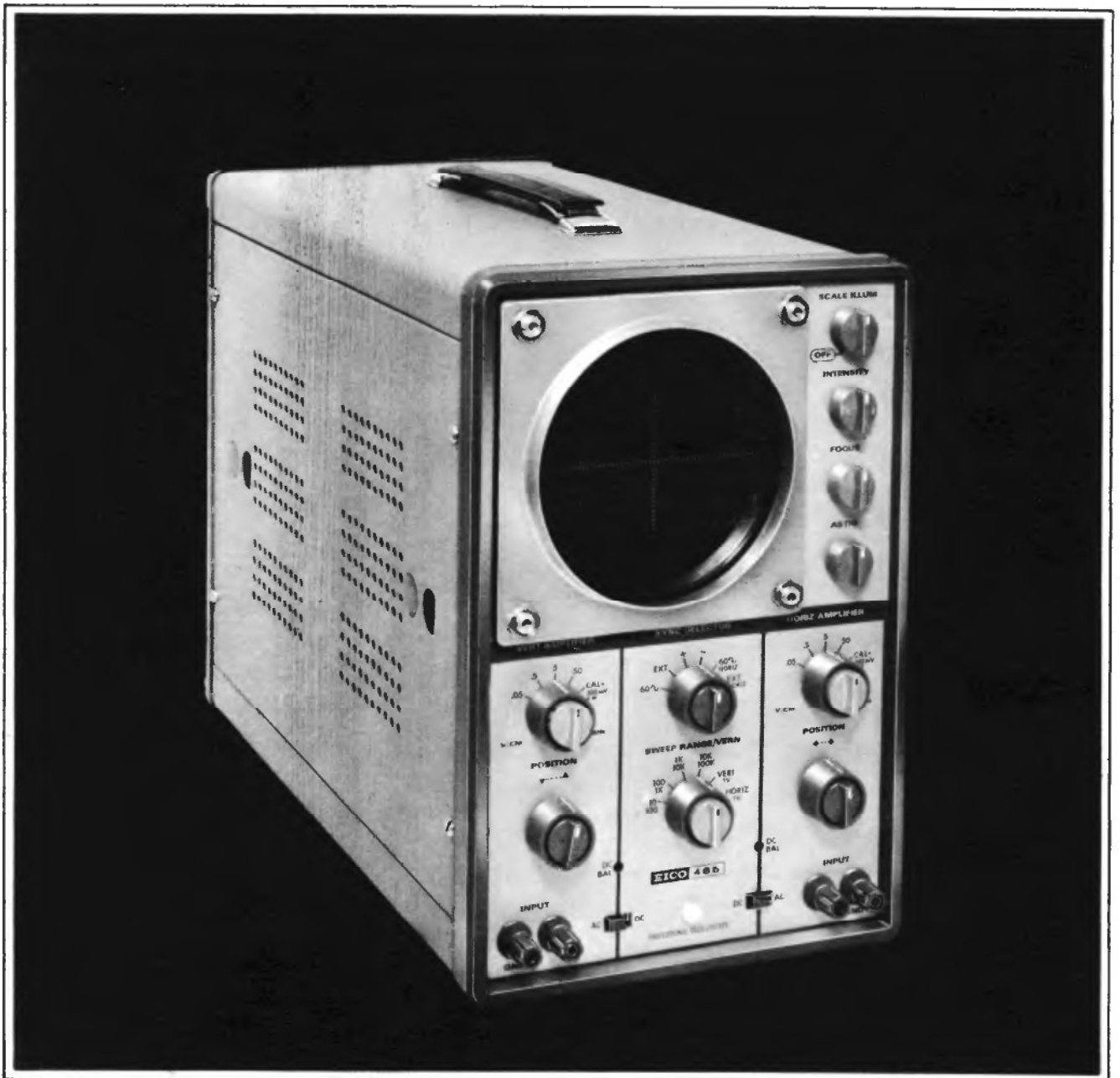

465 | Professional Oscilloscope



www.everything4lessstore.com

OPERATING MANUAL

EVERYTHING 4 LESS

ENJOY YOUR BOOKS

PLEASE VISIT OUR STORE FOR EVEN MORE GREAT STUFF!

WWW.EVERYTHING4LESSSTORE.COM

COPYRIGHT NOTICE

ALL MATERIALS INCLUDING CD/DVD AND PDF FILES ARE COPYRIGHTED

WWW.EVERYTHING4LESSSTORE.COM VON WALTHOUR PRODUCTIONS AND MAY NOT BE REPRODUCED, COPIED OR RESOLD UNDER ANY CIRCUMSTANCES. YOU MAY HOWEVER MAKE A COPY FOR YOUR OWN PERSONAL BACKUP. MATERIALS ARE FOR PERSONAL USE ONLY.

IF YOU PURCHASED THIS FROM ANYWHERE BUT FROM US PLEASE NOTIFY US IMMEDIATELY SO THAT WE MAY CHECK IF YOU PURCHASED FROM AN AUTHORIZED RESELLER SO WE CAN LET YOU KNOW IF YOU NEED TO RETURN FOR FULL REFUND FROM AN UNAUTHORIZED SELLER.

THANKS AGAIN AND PLEASE TAKE THE TIME TO VISIT OUR STORE.

ATTENTION! EVERYTHING ON SALE NOW!!



HOT SALE!

SECTION 1 FEATURES AND SPECIFICATIONS

- 1-1. Physical and electrical specifications
- 1-2. Control features and facilities
- 1-3. Specifications
- 1-4. Controls and input terminals
- 1-5. Notes on controls and terminals

SECTION 2 OPERATION

SECTION 3 APPLICATION

- 3-1. General
- 3-2. Waveform investigation
- 3-3. Waveform display
- 3-4. Lissajous patterns
- 3-5. Servicing TV receivers

SECTION 4 MAINTENANCE

- 4-1. General
- 4-2. Access to chassis
- 4-3. Vertical amplifier adjustments
- 4-4. Horizontal amplifier adjustments
- 4-5. Frequency compensation
 - Vertical channel
 - Horizontal channel
- 4-6. Calibration voltage adjustment
- 4-7. Horizontal TV sweep trimmer adjustment
- 4-8. Troubleshooting
- 4-9. Tube Replacement
- 4-10. Fuse Replacement

SECTION 1 FEATURES AND SPECIFICATIONS

1-1. PHYSICAL AND ELECTRICAL SPECIFICATIONS

- a. DC to 8 MHz (+1, -5 dB) of the vertical amplifier is more than enough needed for both color and monochrome TV service. The horizontal amplifier frequency response is from DC to 1 MHz (+1, - 3 dB). Both amplifiers feature push-pull amplification throughout for minimum distortion, while the direct-coupled design eliminates low-frequency phase shift or response fall off. This DC design also permits making true voltage measurements of any waveform.
- b. A pair of zener-controlled voltage reference sources, and their associated adjustment potentiometers provide an accurate source of calibration voltages for both the horizontal and vertical channels.
- c. Using a 1500-volt accelerating potential provides a sharp, bright, trace free from blooming. A mu-metal CRT neck shield minimizes the effects of external magnetic fields.
- d. Distortionless vertical and horizontal gain and drift-free V & H positioning up to many times the actual viewing screen diameter.
- e. Automatic sync limiter and amplifier provides rock-steady sync signals for the sweep circuits.
- f. Full retrace blanking is provided to remove objectionable background clutter.
- g. Edge-lit calibration grid on a green filter screen has its illumination level controlled by front-panel control.
- h. Human-engineered front panel features all controls in logical order and grouped for easiest use.
- i. Front-panel switches enable switching either vertical or horizontal channel to either AC or DC response.
- j. Heavy-duty power supply reduces generated heat and makes for a long component life.
- k. Each channel is provided with its own internal voltage calibrator.

1-2. CONTROL FEATURES & FACILITIES

- a. Both the vertical and horizontal channels use a four-position, frequency compensated input decade attenuator, plus a calibration position. A concentric gain control is effective in all positions, including the calibration position. A slide-switch is provided for each channel to select either direct coupling (DC) or capacitive coupling (AC).
- b. Both amplifiers can be balanced at any time via a pair of balance controls that can be adjusted through a pair of small holes on the front panel.
- c. The horizontal sync selector permits selection of either internal positive or negative, external, 60 Hz, or provides a 60-Hz sweep. A sixth position passes an external signal into the horizontal amplifier.
- d. Sweep-range selection from 10 Hz to 100 kHz in four overlapping ranges, plus a preset TV vertical and horizontal sweep positions (30 and 7875 Hz respectively). A concentric sweep vernier permits adjustment within any range.
- e. Scale illumination, and CRT intensity, focus, and astigmatism are all controlled by front panel controls.
- f. An intensity modulation input is provided on the rear panel.

1-3. SPECIFICATIONS

a. Vertical amplifier:

Frequency response: DC to 8 MHz (+1, - 5 dB)

Sensitivity: 12 mV per cm r. m. s.

Input impedance: 1 megohm shunted by 35 pF

Calibration voltage: zener-controlled 200 mV peak-to-peak, $\pm 1\%$

Input scale attenuation: .05, .5, 5, and 50 volts/cm

b. Horizontal amplifier:

Frequency response: DC to 1 MHz, +1, -3 dB

Sensitivity: 17 mV per cm r. m. s.

Input Impedance: 1 megohm shunted by 35 pF

Calibration voltage: zener-controlled 500 mV peak-to-peak, $\pm 1\%$

Input scale attenuation: .05, .5, 5, and 50 volts/cm

c. Sweep ranges:

10-100 Hz, 100 Hz- 1 kHz, 1-10 kHz, 10-100 kHz, plus fixed TV vertical (30 Hz), and horizontal (7875 Hz).

d. Intensity modulation:

3 volts r. m. s. blanking

Input impedance 2.2 megohms

e. Tube complement:

1-12AZ7, 1-12AU7, 2-6AU8, 2-12BY7, 3-6BL8; 3 silicon rectifiers, 1 silicon HV rectifier, 2 zener diodes, 5DEPI CRT.

f. Power supply:

117-volts AC, approximately 140 watts

g. Size:

12 1/2 high x 8 1/2 wide x 17 1/2 deep

h. Weight: 27 lbs.

1-4. CONTROLS AND INPUT TERMINALS

The Model 465 has its controls and input terminals grouped in logical arrangement as for use. All controls for either channel are vertically grouped on each side of the front panel, the sync and sweep controls are in the middle segment, while the CRT controls are grouped alongside the CRT screen.

a. The AC power on/off switch is located on the SCALE ILLUMINATION control and is operated by rotating this control clockwise from the OFF position. This also turns up the scale illumination.

b. The INTENSITY, FOCUS, and ASTIGMATISM controls determine the brightness and sharpness of the visible trace. The INTENSITY control determines the brightness, while both FOCUS and ASTIGMATISM determine the sharpness. These three controls interact to a slight extent, therefore, a change in any control setting may require a change in all.

c. In both amplifier groupings, the topmost control (V/CM) selects the amount of input attenuation, in conjunction with its concentric gain control. In both cases, the calibration voltage position is indicated in red. Both POSITION controls adjust the location of the trace on the screen. The HORIZ position control moves the trace to the right or left, while the VERTICAL control adjusts the trace up and down.

Each input attenuator provides four degrees of attenuation; resulting in either .05, .5, 5, or 50 volts-per-cm deflection. Each input is obtainable with either AC or DC coupling by operation of either AC-DC switch located near the bottom of each channel section. The use of direct coupling (DC) prevent phase shifts and amplitude distortions of low-frequency waveforms and also provides a DC reference line to be established for accurate amplitude measurement. AC coupling is used when observing a small a. c. signal superimposed on a relatively large d. c. voltage. At the CAL position, the square-wave calibration voltage is fed directly to the amplifier, bypassing the decade attenuator switch, but not the GAIN control. By setting the vertical GAIN control for a vertical trace size of four major divisions (4 cm), the basic 50 mV/cm sensitivity is obtained when setting the VERT AMPLIFIER V/cm switch to the .05 position and sensitivities of .5, 5, and 50 volts/cm at the other three positions provided that the VERT AMPLIFIER V/CM GAIN control is not changed.

By setting the HORIZ AMPLIFIER V/CM switch to the CAL position, and setting the GAIN control for a trace of 10 divisions long (10 cm), the basic 50 mV/cm sensitivity is obtained for the horizontal channel when resetting the HORIZ AMPLIFIER V/CM switch to the .05 position, and sensitivities of .5, 5, and 50 volts/cm at the other three positions provided that the HORIZ AMPLIFIER V/CM GAIN control is not changed.

d. Both vertical and horizontal channels GAIN controls can be adjusted for any desired signal height, or trace length, if accurate calibration is not needed.

e. Both VERT AMPLIFIER and HORIZ AMPLIFIER INPUT and GND terminals will accept standard scope connectors, probe leads, or plain wires.

f. The SYNC SELECTOR switch has four sync positions to permit sync selection for the sweep generator. At the 60~~Hz~~ position, an a. c. signal of power-line frequency is taken from the power supply and applied to the sweep generator to synchronize it at power-line frequency. At the EXT position, an external signal applied to the HORIZ AMPLIFIER INPUT binding post syncs the sweep generator. At both "+" and "-" positions, the synchronizing signal is derived internally from the vertical (signal) amplifier. At "+", synchronization occurs on the positive-going edge of the applied input signal. At "-", from the negative-going portion of the applied vertical channel signal. At the 60~~Hz~~ HORIZ position, an a. c. voltage is taken from the power supply and used as the input to the horizontal amplifier to form the sweep. In the EXT HORIZ position, the signal applied to the HORIZ AMPLIFIER INPUT binding post forms the sweep.

g. The SWEEP RANGE switch selects the frequency band over which the concentric vernier (VERN) control can be varied for frequency adjustment of the internal linear sweep, or the preset VERT TV or HORIZ TV positions, designed to eliminate the need for repeated adjustment of the SWEEP RANGE switch when working on TV sets that use two widely spaced frequencies for vertical and horizontal circuits. In the four numbered positions, the numbers above the positions markers indicate the upper and lower frequency limits of the band (approximately), for that particular position. The convenience provide by the VERT TV and HORIZ TV positions is as follows: if at the VERT TV position, the SWEEP RANGE VERNier is set to display two full cycles of a 60 Hz signal to obtain a sweep frequency of 30 Hz, placing the SWEEP RANGE switch in the HORIZ TV position will result in an automatic 7875 Hz display without any adjustment of the VERNier.

h. An external voltage for the purpose of intensity (Z axis) modulation may be applied between the rear-panel intensity modulation pin jack and chassis ground. Do not apply more than 3 volts peak to this input or the life of the CRT may be greatly shortened. Do not allow the CRT grid to swing positive (indicated by a noticeable defocussing of the trace).

1-5. NOTES ON CONTROLS AND TERMINALS

a. Proper trace definition will be obtained only if the FOCUS and ASTIG controls are correctly adjusted, and the scope is not operated in strong magnetic fields such as those found near large power transformers, radio transmitters, and power-generating equipment. These strong magnetic fields may distort the electron beam that produces the trace.

b. A sharply focussed line, or a small dot of high intensity, should not be permitted to remain stationary on the screen for any period of time (more than a 1/2 minute or so) or the screen may be burned. A trace of excessively high intensity will burn the screen in 3 to 5 minutes, therefore, do not keep the INTENSITY control turned up for extended periods of time. Burned portions of the screen will no longer fluoresce and are useless for observation. If it is required to have a fixed trace on the screen for a long period of time, reduce the intensity of the trace to minimum.

c. When either AC-DC switch is placed in the DC position, the d. c. component of any signal fed to the amplifier will be amplified along with the a. c. component of the signal. The direction of trace movement is UP for a positive voltage and DOWN for a negative voltage. Therefore, when going from observation of a pure a. c. signal to one containing d. c. (or vice versa), it may be necessary to use the POSITION control to bring the trace back on the screen. Any d. c. component has no effect when the AC-DC switch is in the AC position.

d. A trace can be expanded horizontally and/or vertically to several times full screen without distortion by using the amplifier V/CM switch and concentric GAIN control. Likewise, trace positioning is several times screen diameter to permit examination of any portion of the expanded trace.

e. An independent DC BALANCE control is provided for each channel. These are accessible through small holes on the front panel. When they are properly adjusted, there should be no shifting of the trace (no signal applied) when the GAIN control is rotated from minimum to maximum. Detailed alignment will be given in the MAINTENANCE section.

f. The vertical channel voltage calibration develops a negative-going signal. This means that if the top of the calibration square wave is set to the horizontal center line of the calibration grid, (using the vertical channel POSITION control), the horizontal center line becomes the "zero center" for the calibration grid (assuming that the DC balance is correct). Under these circumstances, direct reading of AC, DC, or AC superimposed on DC voltages can be made. The horizontal center line is zero voltage, while trace points above the center line are positive, and below the center line are negative. Once calibration has been made, then operation of the V/CM control can be used to determine the signal voltage level. Pure DC voltages are determined by noting the distance above the horizontal center line (for positive signals) or below the center line for negative levels, and multiplying the displacement in cm (smallest grid division is 2 mm, major division is 1 cm), by the sensitivity of the particular V/CM switch position. For example - an unknown DC voltage applied to the VERT AMPLIFIER INPUT and GND binding posts at the .05 position of the V/CM switch causes a downward trace displacement of 2 1/2 small grid division (4 1/2 mm). Since the deflection is downward, the voltage is negative. As the sensitivity is 50 mV/cm in the .05 position, the DC voltage is 25 mV. AC waveforms with or without a DC component can be read as to absolute voltages at any point, and including the value of any DC component. For example - an unknown voltage applied to the vertical channel at the .5 position, displays a waveform having a positive peak 4 major divisions above the horizontal center line and a negative peak 2 major divisions below the horizontal center line. As the sensitivity at the .5 position is 500 mV/cm, the positive peak is 2 volts and the negative peak is 1 volt (3 volts peak-to-peak). When the AC-DC switch is in the AC position, the positive peak moves 1 1/2 major divisions (7 1/2 minor divisions) downward so that the positive peak is now only 2 1/2 major divisions (12 1/2 minor divisions) above the horizontal center line. Since 1 major division is 500 mV at the .5 position, the DC component of the voltage is 1 1/2 cm x 500 mV/cm or 750 mV and positive. If the signal under observation is a sine-wave only, the r. m. s. value may be calculated by dividing the peak-to-peak value by 2.8.

SECTION 2 OPERATION

To obtain the best results with your scope, it is advisable to become acquainted with the functions and correct usage of the panel controls and terminals, by making some simple tests. These tests will also assure you that the instrument is in perfect working order. Do not attempt this procedure with kits before all final checks have been completed and all initial adjustments have been completed as explained in the MAINTENANCE section.

- a. Set the SCALE ILLUM control to OFF, INTENSITY, FOCUS, and ASTIG to the center of their range.
- b. On the VERT AMPLIFIER section, set the V/CM switch to 50 and the GAIN control fully counterclockwise. Set POSITION near the center of its range.
- c. On the HORIZ AMPLIFIER section, set the V/CM switch to .05 and the GAIN control fully counterclockwise. The POSITION control should also be set about half way.
- d. Set the SYNC SELECTOR control to EXT. HORIZ. Set the SWEEP RANGE and VERN control to any position.
- e. Insert the power cord into a nominal 117-volt, 60-Hz outlet.

WARNING

This instrument will not operate, and will be seriously damaged, if connected to any other type of power source (such as d. c., 25-Hz, 200/240 - volts a. c.), unless fitted with specialized power supply components.

- f. Rotate the SCALE ILLUM off the OFF position and note the click as the associated switch is operated. The small pilot lamp at the bottom of the front panel should glow. The two scale illumination lamps will start to glow and this glow can be increased by rotating the SCALE ILLUM control more clockwise. Set the scale illumination at a low level.
- g. As the unit warms up, a bright spot should appear. If the spot does not appear, it may be necessary to rotate the INTENSITY control slightly more clockwise, and possibly make some adjustment to both POSITION controls.
- h. Using the POSITION controls, center the spot on the screen.
- i. Adjust the FOCUS and ASTIG controls for the sharpest image. Note that there is some interaction between the INTENSITY, FOCUS, and ASTIG controls, therefore, all three will have to be adjusted for the sharpest results.
- j. Set the SYNC SELECTOR switch to either "+" or "-". Advancing the HORIZ AMPLIFIER GAIN control clockwise should cause the dot to extend into a horizontal line. This is the horizontal linear sweep. Reset the SYNC SELECTOR to EXT HORIZ and note that the trace drops back to a dot. Any signal, even touching the HORIZ AMPLIFIER INPUT terminal, will cause a trace to appear whose length is a function of the HORIZ AMPLIFIER V/CM switch and GAIN control.
- k. Set the SYNC SELECTOR back to 60 Ω HORIZ. The length of the horizontal line seen on the screen is also a function of the setting of the HORIZ AMPLIFIER V/CM switch and its associated GAIN control. This trace is a 60-Hz sine sweep and is used for certain set alignments.
- l. Set the SYNC SELECTOR to "+", and HORIZ AMPLIFIER V/CM and GAIN controls for a useful long trace. Place the SWEEP RANGE switch in the 10-100 position, and the associated VERN control fully counterclockwise.
- m. Set the VERT AMPLIFIER V/CM switch to the CAL position. Adjust the VERT and HORIZ AMPLIFIER GAIN control until the square-wave pattern covers about two thirds of the screen. Center the pattern using the POSITION controls. Lock the pattern on the trace by adjustment of the SWEEP RANGE VERN control until a single square-wave is displayed on the screen, and remains stationary.

NOTE: In rotating the SWEEP RANGE VERN control, the pattern slows down as certain critical frequencies are approached, and then it appears to reverse direction when a critical frequency is passed. At these critical frequencies, a clear square-wave pattern can be discerned. These critical sweep frequencies are sub-multiples of the signal frequency, or the signal frequency itself (when only one cycle is displayed). The pattern may be locked in at any sub-multiple of the signal frequency when it is desired to view more than one cycle of the applied signal. The sweep frequency is equal to the signal frequency divided by the number of complete cycles displayed on the screen. For example - if two complete cycles of the 60-Hz signal are displayed, the sweep frequency is 30 Hz.

At very low sweep frequencies, flickering of the trace is normal due to the slow writing speed of the electron beam, and the persistence of the screen. Taken together, these may be insufficient to cause the beam motion to blend into a clear fixed image.

n. Adjust the SWEEP RANGE VERN until the single square wave pattern locks on the positive-going leading edge, which should not be visible. Placing the SYNC SELECTOR in the "-" position should cause the pattern to move over until sync takes place on the negative transition.

o. If it is desired to observe the operation of the intensity modulation facility, connect the output of an audio generator to the rear panel intensity jack and front panel GND. Be sure that the INTENSITY control is set no higher than is necessary. Set the audio generator to 600 Hz and bring up the generator output until the displayed single pattern breaks up into segments. Do not increase the generator's output above the level required to do this. Fine adjust the generator frequency carefully until the segments become stationary. If the segments are counted, it will be found that there are 10. This indicates that the ratio between the frequency of the intensity modulation (audio generator) and the vertical amplifier input (in this case 60 Hz) is $600/60$ or 10. Therefore, the intensity modulation can be used for introducing timing markers on the trace, or for determining the frequency of an unknown signal.

CAUTION

When using the INTENSITY modulation, the INTENSITY control should first be set at minimum (counterclockwise) and then turned clockwise just enough to obtain normal intensity. If this is done, the possibility of applying excessive intensity modulation signal voltage will be minimized.

SECTION 3 APPLICATION

3-1. GENERAL The oscilloscope are the electronic "eyes" of the technician and enable him to see waveforms that are totally invisible to his normal eyes. The scope is capable of displaying high-speed electrical waveforms of both continuous and transient nature from a few cycles per second to many millions of cycles per second.

3-2. WAVEFORM INVESTIGATION When the output of the scope's internal sweep generator is fed to the horizontal channel, the pattern on the CRT screen is actually a graph displaying the variation with time of the instantaneous amplitude of the signal applied to the vertical channel. The horizontal sweep time can be varied so as to present one or more full cycles on the screen.

3-3. WAVEFORM DISPLAY It is generally most convenient to use a time base that varies linearly with time, so that equal intervals of time are represented on the screen by equal intervals of distance along the horizontal axis.

If the frequency of the observed signal is exactly equal to the sweep frequency, one complete vertical channel cycle will be observed on the screen. If the frequency of the applied signal is twice the horizontal sweep frequency, two complete cycles will be seen on the screen, and so on.

Fig. 1 is projection drawing of a simple sine wave applied to the vertical channel and a linear (with time) sawtooth applied to the horizontal channel. Fig. 2 is a similar drawing showing the resultant pattern when the frequency of the sawtooth is one-half that used in Fig. 1. In both figures,

points that occur simultaneously are numbered the same. The circle represents the CRT screen. If simultaneous projections were drawn from every point on each waveform, the intersections would trace out the sine waves shown within the circles. The sections of the sawtooth between 1 and 4 of Fig. 1, and between 1 and 9 of Fig. 2 are the sweep sections during which the actual CRT display is produced. The sawtooth sections between 4 and 5 of Fig. 1, and between 9 and 10 of Fig. 2, are the sections during which the electron beam is returned very rapidly to the starting point at the left of the screen. This return trace is prevented from appearing on the screen by a built-in blanking circuit.

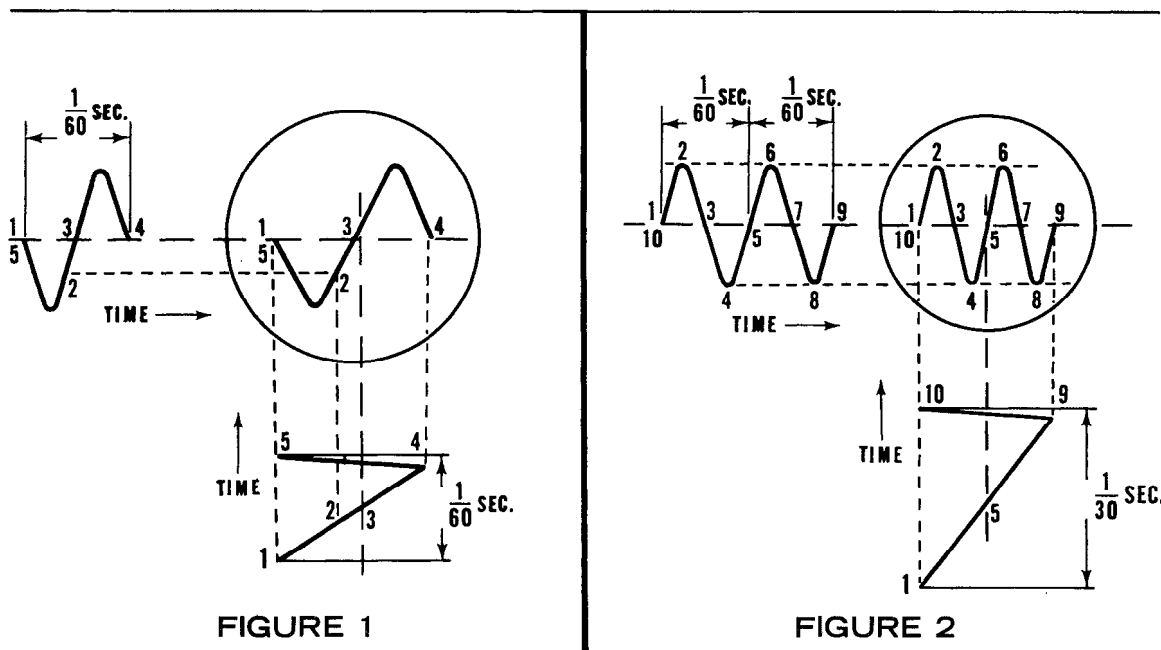

3-4. LISSAJOUS PATTERNS: Another type of fundamental pattern is obtained when both the vertical and horizontal deflection voltages are sine waves that are related in frequency when one frequency is a whole number of times greater than the other; or when one frequency is a simple fraction of the other. When one or the other of these conditions is fulfilled, stationary closed-loop patterns are obtained. These patterns are called Lissajous figures after a 19th century French scientist. They are particularly useful in determining the frequency ratio between two sine wave signals. If the frequency of one signal is known, the frequency of the other signal can be easily determined from the frequency ratio. Usually the known signal is applied to the horizontal channel and the unknown signal to the vertical channel. The shape of the pattern changes with the phase relationship between the known and unknown signals. For example, all the patterns shown in Fig. 3 (and those intermediate) are possible with a frequency ratio of 1:1 if the phase differences indicated exist.

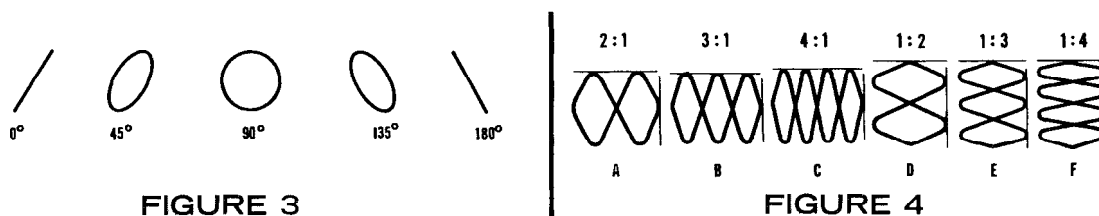

In general, to determine frequency ratio from the Lissajous figure, count the number of points of tangency to horizontal and vertical lines, drawn or imagined (see Fig. 4). Points of tangency at the top of the figures result from the unknown frequency applied to the vertical channel. Those at the side of the figure result from the known frequency applied to the horizontal axis.

$$\frac{V \text{ axis freq}}{H \text{ axis freq}} = \frac{V \text{ pts of tangency}}{H \text{ pts of tangency}}$$

As an example, take Fig. 4c, which shows four points of tangency at the top and one point at the side. This indicates that the unknown frequency applied to the vertical axis is four times the known frequency. In Fig. 4f, one point of tangency at the top and four at the side indicate that the unknown frequency is one-fourth the known frequency.

A square-wave generator such as the EICO Model 377 can be used to rapidly check amplifiers for frequency response, phase shift, transient response, deficient design, or faulty components.

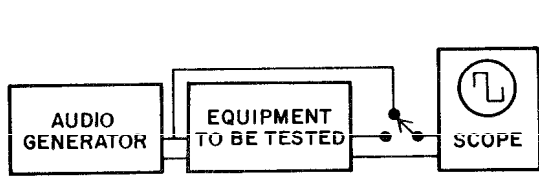

FIGURE 5

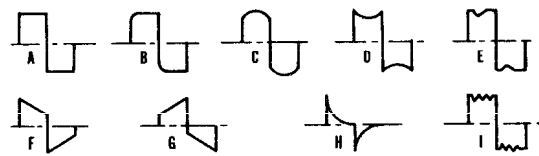

FIGURE 6

First, for a basis of comparison, the square wave output from the Audio Generator is directly viewed on the scope. The horizontal sweep of the scope should be adjusted so that at least two full cycles can be seen on the screen. (Fig. 6a shows one full cycle of a perfect square wave). The scope is then connected to the output of the amplifier under test so that the amplified square wave can be viewed on the screen. Possible output wave shapes are shown in Fig. 6b to 6i, and the significance of each waveshape is explained below.

Fig. 6b shows "rounding" of the leading edge of square wave. This indicates a drop off in gain at high frequencies. "Rounding" will generally be observable when there is a substantial drop in the gain by the tenth harmonic (or less). Therefore, if a 2KHz square wave fed to the amplifier is reproduced on the scope without "rounding", the amplifier is flat to $10 \times 2\text{KHz} = 20\text{KHz}$.

Fig. 6c shows the effect of increased low-frequency gain and Fig. 6d shows the effect of decreased low-frequency gain of the square wave frequency. Fig. 6c indicates lowered gain at a narrow frequency band.

The effect of phase shift in the amplifier is shown in Figs. 6f and 6g. If, at low frequencies, there is phase shift in the leading direction, the square wave will be tilted as in Fig. 6f. If there is phase shift in the lagging direction, the top of the square wave will be tilted as in Fig. 6g. The steepness of the tilt is proportional to the amount of phase shift. Phase shift is not important in audio amplifiers, although the ear is not entirely insensitive to it. In television and scope amplifiers, however, phase shift should not be tolerated.

Fig. 6h shows the pulse output from the amplifier that results when the square wave has undergone differentiation. This will happen when the grid resistor, or the coupling capacitor is too low in value, or if the coupling capacitor is partially open. Lastly, Fig. 6i, shows a square wave with damped oscillations following the leading edge. This results when a square wave is fed to an amplifier in which distributed capacities and lead inductances resonate to produce "shock oscillations". In television and scope amplifiers it may result from an undamped peaking coil.

High-fidelity audio amplifiers may be given a rapid check by testing first with a square wave of fundamental frequency not less than 3 to 4 times the low-frequency limit of the amplifier (3dB point), and then with a square wave of fundamental frequency which may be anywhere between 1/100 to 1/10 of the high-frequency limit of the amplifier depending upon how many harmonics are considered necessary to produce an acceptable version of a square waveform. Usually, square waves of fundamental frequency from 40 to 60 Hz and 1000 to 2000 Hz are employed to cover the range up to 20,000 Hz.

To insure correct results, the following is suggested: Connect the proper value of load across the amplifier output terminals; use low-capacitance cable for connecting the generator to the amplifier input; set the generator output to an ample value but be sure not to overload the amplifier load. The square-wave signal is fed to the amplifier input and the scope is connected across the amplifier load. Use the internal linear sweep to observe the waveform. Note that tone controls have a very marked effect on square wave response and should be set to the "flat" positions unless it is desired to observe their effect. Note, also, that low-fidelity and p. a. amplifiers will not reproduce the square waveform.

Video amplifiers may be square wave tested in the same manner as described for testing audio amplifiers. The test frequencies might be 60 Hz for the low end, and 25,000 Hz for the high end.

3-5. **SERVICING TV RECEIVERS:** One major use of the scope in TV servicing is alignment in conjunction with a TV/FM Sweep Generator. First, the IF stages are aligned, and then the RF and local oscillator stages, following the general method and theory of alignment described in the sweep generator instruction manuals. The specific methods of alignment depend on the receiver, and the manufacturer's service instruction should always be followed.

Another major use of the scope is to check the waveform of the complex TV signal as it passes through the receiver. The exceptional fidelity of the Model 465 scope is very important in this application, since you must be able to observe small variations in waveform to localize and correct the cause of poor picture quality. Here again, the set manufacturer provides representative waveforms to be expected at specific points in a specific model of receiver. These waveform pictures are furnished for the entire receiver, with the exception of the tuner portion. EICO manufactures a complete line of high-quality oscilloscope probes meeting all the requirements for waveform observation in any part of a TV receiver.

Keep in mind that two basic frequencies are involved in checking waveform of signals in TV receivers. The first is the vertical or field frequency of 60 Hz. Any waveform check, except for the horizontal oscillator, its' differentiator network, the horizontal output stage can generally be made using a scope sweep of 30 Hz (to show two complete fields of the signal). To examine the horizontal pulse shape, or the operation of the horizontal deflection system, 7875 Hz is required to show two cycles. The SWEEP RANGE VERT TV and HORIZ TV have been incorporated to provide rapid changeover from one basic TV sweep frequency to the other without the need for control readjustment.

SECTION 4 MAINTENANCE

4-1. GENERAL

Included in this section are the following:

a. Cabinet removal

b. Vertical amplifier adjustments

DC balance

vertical input bias

vertical output bias

c. Horizontal amplifier adjustments

DC balance

horizontal input bias

d. Frequency compensation

Vertical channel

Horizontal channel

e. Calibration voltage adjustment

Vertical channel

Horizontal channel

f. HORIZ TV (SWEEP RANGE switch) adjustment

g. Troubleshooting chart

h. Schematic diagram

i. Voltage and resistance charts

4-2. ACCESS TO CHASSIS

To gain access to the chassis, disconnect the scope from the power line. Then remove the four screws that secure each side panel in place. Once the screws are removed, both side panels are removed and the chassis will be accessible.

WARNING

The voltages in this instrument are dangerous. Take caution to avoid personal contact with these voltages when the chassis is exposed. Remember that capacitors may remain charged to dangerously high voltages for a considerable time after power has been removed.

4-3. VERTICAL AMPLIFIER ADJUSTMENTS

SEE ADDENDUM PAGE 1

Insert the AC power plug into a 117-volt, 60Hz outlet and rotate the SCALE ILLUM switch clockwise until the switch clicks indicating that power has been applied. The power on indicator, and the two scale illuminators will be lit. While the scope is warming up, set the front panel controls as follows: INTENSITY, FOCUS, ASTIG, VERT POSITION, HORIZ POSITION, SWEEP RANGE VERN, VERT GAIN, and HORIZ GAIN to approximately middle of rotation. Set SWEEP RANGE to 10-100, SYNC SELECTOR AT "+", and both V/CM switches at .05. Adjust the CRT controls and the positioning controls for a sharp trace centered on the screen. Set both AC-DC switches to DC.

- a. Connect a shorting link between the VERT AMPLIFIER INPUT and GND binding posts.
- b. Being very careful, connect a VTVM between ground (chassis) and pin 8 of either V1 or V2 (positive lead of VTVM). See Fig. 7. Adjust vertical bias input potentiometer R36 (Fig. 8) for a reading of 2.6 volts.
- c. Move the positive lead of the VTVM to pin 1 of either V3 or V4. Then adjust vertical bias output potentiometer R24 for a reading of 111 volts.
- d. Repeat steps "b" and "c" until the specified voltages are obtained.
- e. Set the VERT AMPLIFIER GAIN control fully counterclockwise (minimum gain). Adjust the VERT AMPLIFIER POSITION control until the trace sits exactly on the main horizontal center line of the calibration grid. Now rotate the GAIN control fully clockwise (maximum gain), and adjust the front panel DC BAL control (R13) using a small screwdriver through the hole, to return the trace exactly to the center line. Repeat until no vertical shift can be detected when the VERT AMPLIFIER GAIN control is rotated from minimum to maximum gain. It is advisable to repeat this procedure after the scope has warmed up for at least half an hour.

4-4. HORIZONTAL AMPLIFIER ADJUSTMENTS

- a. Connect the shorting link between the HORIZ AMPLIFIER INPUT and GND binding posts.
- b. Very carefully, connect the VTVM between ground (chassis) and pin 7 (Fig. 7) of either V7 or V8 (positive lead of VTVM). Adjust horizontal input bias potentiometer R81 (see Fig. 8) for a reading of 2.5 volts.
- c. Set the SYNC SELECTOR switch at EXT HORIZ. A dot should appear on the screen.
- d. Adjust the HORIZ AMPLIFIER GAIN control fully counterclockwise (minimum gain). Adjust the HORIZ AMPLIFIER POSITION control to place the dot exactly on the main vertical reference line on the calibration grid. Now rotate the GAIN control fully clockwise (maximum gain), and adjust the front panel DC BAL control (R66), using a small screwdriver through the hole, to return the dot exactly to the center line. Repeat until no horizontal shift can be detected when the HORIZ AMPLIFIER GAIN control is rotated from minimum to maximum gain. It is advisable to repeat this procedure after the scope has warmed up for at least half an hour.

4-5. FREQUENCY COMPENSATION

- a. Vertical channel stray capacitance shunting the resistive components in each attenuator network could result in frequency discrimination, were not each attenuator frequency compensated by a trimmer capacitor at each switch position. The trimmers for the vertical channel are shown in Fig. 8. The trimmers are: .5 - C6, 5 - C4, 50 - C2. The .05 range has no trimmer.

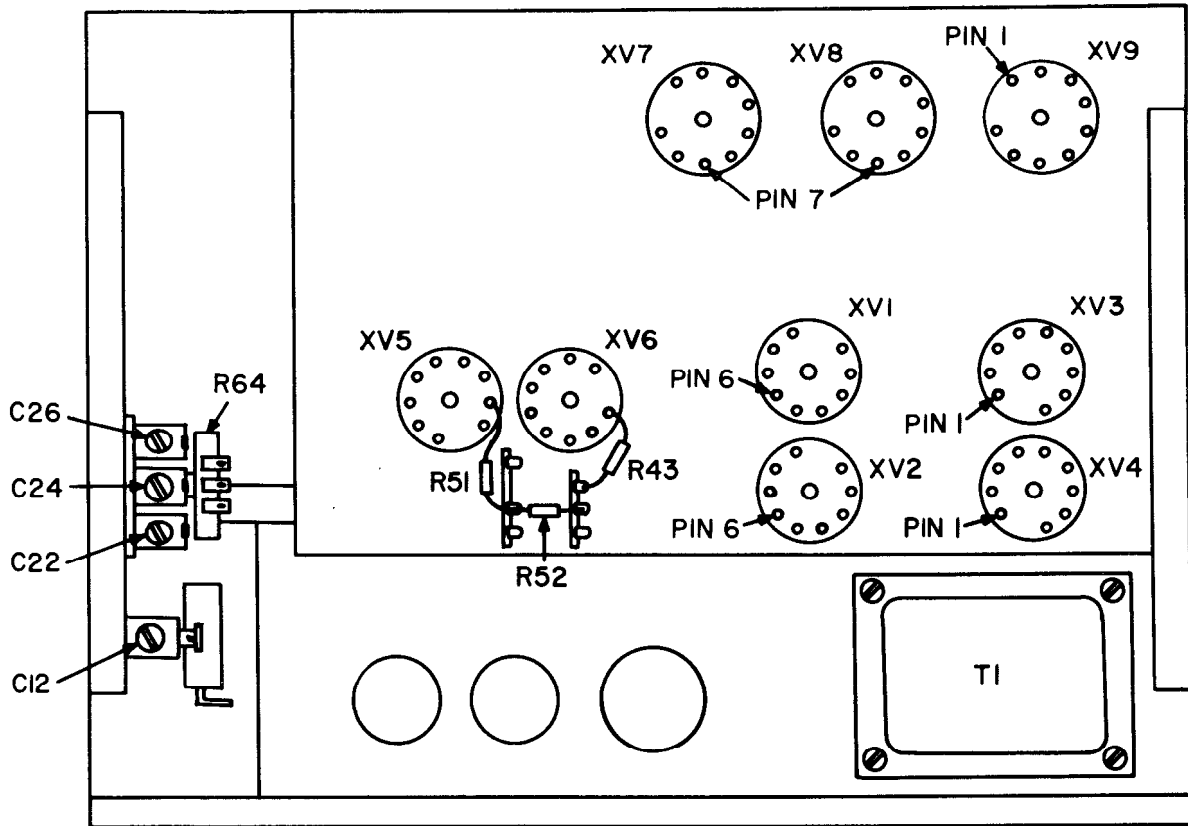

FIGURE 7

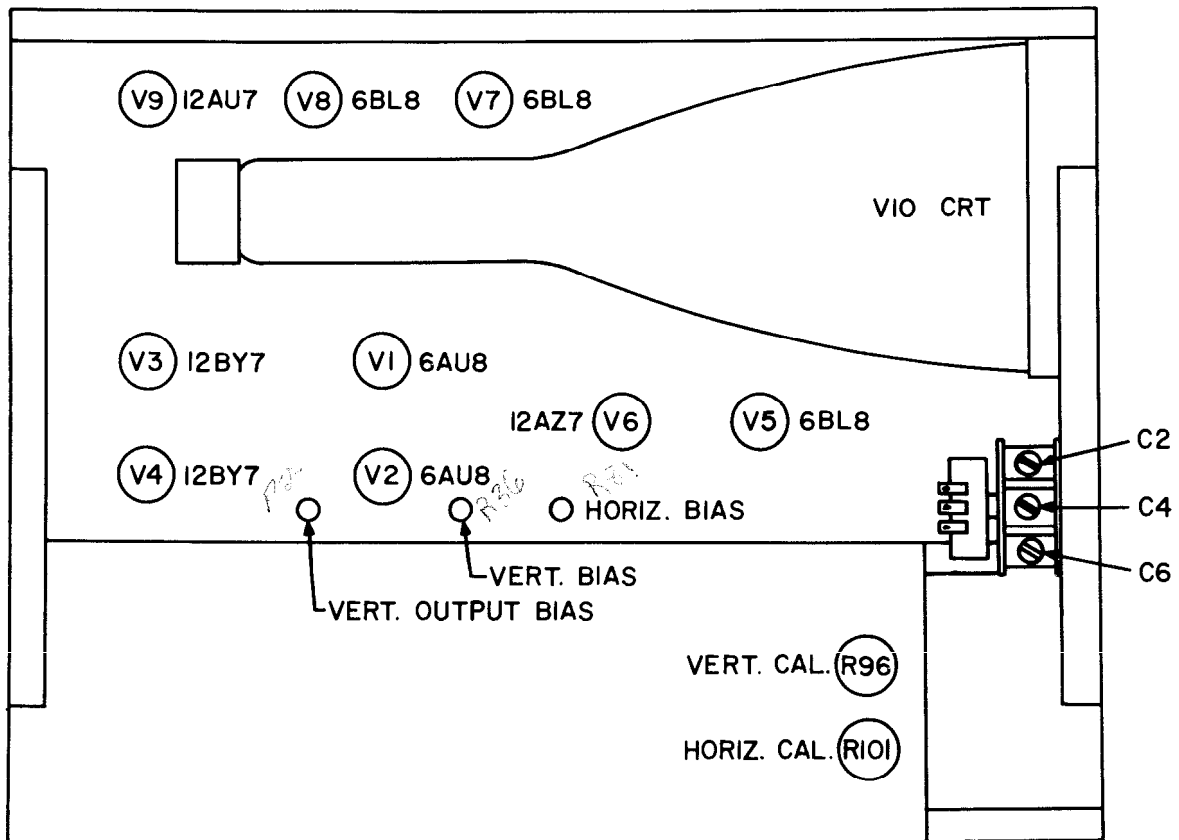

FIGURE 8

b. To adjust these trimmers, connect a jumper between the rotor of HORIZ AMPLIFIER GAIN control (R64) and the VERT AMPLIFIER INPUT binding post. Set the SWEEP RANGE to 10K-100K position and the VERN at minimum. Set the SYNC SELECTOR AT "+", and both AC-DC switches at AC.

c. Set the VERT AMPLIFIER V/CM at .5 and GAIN at maximum. Adjust the HORIZ AMPLIFIER V/CM and GAIN for a trace about 2/3 the screen width. Use the panel controls to center and focus the trace. If C6 is not adjusted properly, the trace will appear as in Fig. 9a or 9b. If this is the case, adjust trimmer C6, using an insulated screwdriver, until the trace is a straight line as shown in Fig. 9c.



d. Set the VERT AMPLIFIER V/CM switch to the 5 position. Remove the end of the jumper from R64 and connect it to pin 1 of V9 (fig. 7). Rotate the GAIN control for minimum gain. If the trace has a "hook", adjust C4 (Fig. 8) for a straight line.

e. Now set the VERT AMPLIFIER V/CM switch to the 50 position and adjust the GAIN control for almost maximum. Adjust C2 (Fig. 8) to make a straight trace. Remove the jumper.

f. Horizontal Channel -Connect a 10-megohm resistor between pin 2 of V6 (Fig. 7) and the end of R43 (68K, 1-watt) that is not connected to pin 1 of V6.

g. Connect a jumper from the junction of R51 and R52 (connected in the cathode circuit of V5B), and shown in Fig. 7 to the HORIZ AMPLIFIER INPUT jack J2. Set both AC-DC switch at AC.

h. Connect a jumper from the HORIZ AMPLIFIER INPUT jack (J2) to the VERT AMPLIFIER input jack (J1). Place the SYNC SELECTOR switch in the "+" position. Place the VERT AMPLIFIER V/CM switch in the 5 position. Set the GAIN at maximum.

i. Place the SWEEP RANGE switch in the 10K-100K position. Center the trace on the screen.

j. With HORIZ AMPLIFIER V/CM at .5, and GAIN at maximum, adjust C26 (see Fig. 7) until the "hook" disappears, and the trace is a straight line.

k. Place the HORIZ AMPLIFIER V/CM switch in the 5 position and adjust C24 until the trace is straight.

l. Place the V/CM switch in the 50 position, and adjust C22 until the trace is straight.

m. Disconnect the 10-megohm resistor and all jumpers.

4-6. CALIBRATION VOLTAGE ADJUSTMENT

VERTICAL CHANNEL

a. The calibration voltage is adjusted by means of R96 (see Fig. 8 for location). Before doing this, make sure that you have performed the DC balance tests discussed in 4-3 and 4-4 for both channels.

b. Place the VERT AMPLIFIER V/CM switch in the .5 position, and the associated AC-DC switch to DC.

- c. Connect a jumper between the VERT AMPLIFIER INPUT and GND binding posts. Use the POSITION control to set the trace on the horizontal center line of the calibration grid.
- d. Adjust the HORIZ AMPLIFIER V/CM switch to 50 and GAIN control to minimum to reduce the trace to a single spot.
- e. Remove the jumper and connect a 1.5-volt dry cell between the VERT AMPLIFIER INPUT and GND binding posts. Then adjust the GAIN control until the deflected spot is 3 cm (3 major divisions on the calibration grid) away from the horizontal center line. Remove the battery, but do not touch the GAIN control.
- f. Reset the VERT AMPLIFIER V/CM switch to the CAL position without touching the GAIN control. The spot will stretch into a vertical line.
- g. Adjust R96 (Fig. 8) until the vertical line is 4 cm (4 major divisions) high. This completes the calibration voltage adjustment for a basic sensitivity of 50 mV/cm. Although the method calibration given here is convenient, it does not yield the maximum possible accuracy because the voltage divider is at the .5 position, which might introduce a possible 5% error (because of the resistors in the attenuator network). A more accurate calibration technique is to use an accurate source of 200 mV to do this calibration. A suggested source for obtaining the required 200 mV is shown in Fig. 10.

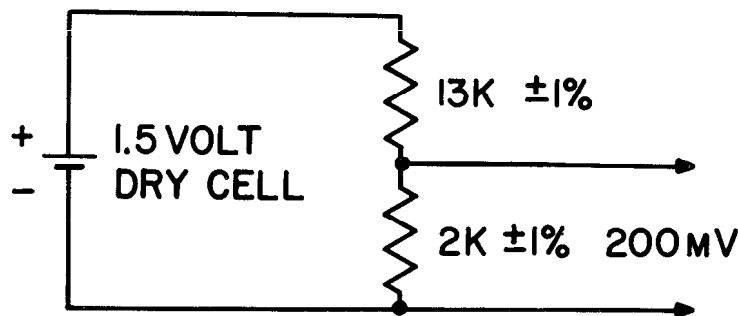

FIGURE 10

HORIZONTAL CHANNEL

- a. Set the HORIZ AMPLIFIER switch at .5 and the associated AC-DC switch at DC. Again make sure that the DC balance tests have been made.
- b. Set the SYNC SELECTOR switch to EXT HORIZ.
- c. Set the VERT AMPLIFIER V/CM switch to 50, and the GAIN to minimum.
- d. Center the spot using the vertical and horizontal POSITION CONTROLS.
- e. Connect a 1.5-volt battery between the HORIZ AMPLIFIER INPUT and GND binding posts.
- f. Adjust the HORIZ AMPLIFIER GAIN control until the spot has deflected 3 cm (3 major divisions), from the center line.
- g. Without touching the GAIN control, place the V/CM switch in the CAL position.
- h. Adjust R101 (Fig. 8) until the peak-to-peak deflection of the trace is 10 cm (10 major divisions). This completes the horizontal channel calibration for a basic sensitivity of 50 mV/cm.

4-7. HORIZONTAL TV SWEEP TRIMMER ADJUSTMENT

- a. Place the SYNC SLECTOR AT EITHER the "+" or "-" position; the HORIZ AMPLIFIER V/CM switch at either the .05 or .5 positions and adjust the GAIN control for a 3/4 screen length trace. Use the POSITION controls to center the trace.
- b. Place the SWEEP RANGE switch in the VERT TV position. Then place the VERT AMPLIFIER V/CM switch in the CAL position. A square wave will appear on the screen. Adjust the GAIN for a 1/2 to 3/4 screen height. You may have to adjust the POSITION controls to center the trace.
- c. Adjust the SWEEP RANGE VERN control until a stationary pattern of two complete cycles appears on the screen. This sets the sweep at exactly 30 Hz (TV vertical frequency). DO NOT touch the SWEEP RANGE VERN control from now on.
- d. Place the SWEEP RANGE switch in the HORIZ TV position. There will be a blur on the screen.
- e. Apply a 15,750 Hz (TV horiz frequency) taken from the horizontal section of an operating TV set between the VERT AMPLIFIER INPUT and GND binding posts. (It is possible to get this waveform without any danger by using a long insulated test lead with one end connected to the VERT AMPLIFIER INPUT binding post and the other end near the TV set yoke. Be careful not to contact any high voltage when doing this.)
- f. Adjust the VERT AMPLIFIER V/CM and GAIN controls to obtain a 1/2 to 3/4 screen height series of pulses. Without touching the SWEEP RANGE VERN control, adjust C12 (Fig. 7) until a stationary pattern of two complete cycles are displayed. This indicates an exact 7875 Hz sweep.
- g. This completes the adjustment, with the result that whenever the SWEEP RANGE switch is set to VERT TV and the VERN is adjusted for a 30 Hz sweep (indicated by 2 cycles of a 60-Hz signal applied to the vertical input), resetting the SWEEP RANGE to HORIZ TV without touching the VERN control automatically produces a 7875 Hz sweep.

4-8. TROUBLE SHOOTING

- a. The block diagram (Fig. 11) should aid in isolating the circuit in which the trouble is located. Once this is done, refer to the appropriate section of the schematic. The next step is to localize the problem to a particular tube circuit, and if required, replace the tube. If the trouble is not eliminated, use the voltage and resistance tables provided.

4-9. FUSE REPLACEMENT

- a. A 2.5 ampere fuse is located in the fuseholder on the rear chassis apron. If the fuse blows repeatedly, troubleshoot the scope.

4-11. TROUBLE-SHOOTING CHART

SYMPTOM	POSSIBLE CAUSE	REMEDY
<p>Pilot lamp fails to light.</p> <p>Fuse F1, blows when AC power is turned on.</p> <p>Some or all filaments fail to light.</p>	<p style="text-align: center;"><u>POWER SUPPLY</u></p> <p>INTENSITY switch in OFF position.</p> <p>No AC line voltage Pilot lamp open Fuse defective Broken lead/or leads in the filament path.</p> <p>Shorted AC line cable on the primary side of the power transformer. Defective rectifier diodes CR3, or CR4. Defective filter capacitors</p> <p>Short in filament connections</p> <p>Defective tube or tubes. Broken leads from power transformer. Power transformer defective</p>	<p>Turn INTENSITY switch clockwise. Trace line failure Replace I1 Replace F1 Repair defective connections</p> <p>Repair the short</p> <p>Check CR3, CR4. Replace if bad. Check C26, C27 for low resistance or short. Replace if necessary. Check filament connections for shorts. Repair if necessary. Replace tube or tubes* Check with an ohmmeter for continuity. Repair if necessary. Replace</p>
<p>No spot on CRT screen.</p>	<p style="text-align: center;"><u>CRT CIRCUIT</u></p> <p>High voltage rectifier diode CR5 defective.</p> <p>No voltage on second anode.</p> <p>NOTE: Spot may be deflected off screen. Adjust VERT. POS. control for equal voltages from CRT pins 6 & 7 to ground (Vertical deflection plates), and HORIZ. POS. control for equal voltages from CRT pins 9 & 10 to ground (horizontal deflection plates). The spot should then be centered. If either adjustment is impossible, refer to the vertical or horizontal amplifier sections.</p>	<p>Replace</p> <p>Repair Check circuit. Repair if necessary.</p>

SYMPTOM	POSSIBLE CAUSE	REMEDY
No spot on CRT screen. (All CRT voltages correct).	Defective CRT (V10)	Replace
Retrace blanking inoperative.	CR1 Open lead in path from sweep generator to cathode of CRT(V10).	Replace Check if necessary
Intensity modulation of trace with internal sync.	R44, R45 defective.	Check. Replace if necessary.
No focusing.	FOCUS control R84 defective. Astigmatism control R82 defective.	Replace Replace
No horizontal positioning.	Refer to horizontal amplifier.	
No vertical positioning.	Refer to vertical amplifier.	
Astigmatism control inoperative.	R82 defective.	Replace
<u>SWEEP CIRCUIT</u>		
No sweeps (horizontal amplifier checks o.k.)	SWEEP RANGE switch is not set to sweep positions. Lead or leads broken. SWEEP RANGE switch S3 defective. HORIZ. SELECTOR switch S2 defective. SWEEP VERNIER R47 defective. One of R38-43 defective. V5 defective	Set SWEEP RANGE switch to one of sweep positions. Check and repair if necessary. Check. Replace if necessary. Check. Replace if necessary. Check. Replace if necessary. Replace defective resistor. Replace
Sweep inoperative on some ranges.	One of C12-17 defective. SWEEP RANGE switch S3 defective.	Replace defective capacitor. Check. Replace if necessary.
Incorrect sweep frequency obtained at TV-HOR. position.	C12 out of adjustment.	Adjust C12. See MAINTENANCE.
Loss of synchronization.	V5 defective. HORIZ. SELECTOR switch S2 defective. C10 defective Sync leads defective.	Replace Replace Replace Repair

VERTICAL AMPLIFIER

SYMPTOM	POSSIBLE CAUSE	REMEDY
With appropriate signal applied across VERT and G binding posts, no vertical displacement of the trace results.	VERT. ATTEN. switch S1 defective. One or more of tubes V1-4 defective. One or more components in the vertical amplifier defective.	Replace Check. Replace if necessary. * Check resistors and potentiometers with ohmmeter. Replace if defective. *
Signal distorted; unable to obtain DC balance.	Peaking coil or coils open. R13 defective. V1-4 defective. Check adjustments of R36 and R24.	Replace Replace* Replace* See MAINTENANCE
No vertical positioning.	VERT. POS. control R16 defective.	Replace
VERT. GAIN control affects position of trace.	DC balance control R13 out of adjustment.	See MAINTENANCE
No vertical signal in AC position of AC-DC switch.	C1 open.	Replace
Square wave (lkc) distorted on .5, 5, 50 positions of VERT. ATTEN. switch.	C2, C4, C6 out of adjustment.	See MAINTENANCE
VERT. GAIN control inoperative.	VERT. GAIN control R12 defective. (Note: Inability to reduce trace size to zero is <u>not</u> a defect, but inherent in DC amplifier design).	Replace
Trace "jumps" on CRT screen in vertical direction.	Loose connection in vertical amplifier section. One of tubes V1-4 is microphonic.	Repair Tap tubes lightly. Replace one which is microphonic. *
No trace when VERT. ATTEN. switch set at CAL.	R94, 95, 96 defective. CR2 shorted.	Replace* Replace*
Calibration inaccurate.	R96 out of adjustment.	See MAINTENANCE

HORIZONTAL AMPLIFIER

SYMPTOM	POSSIBLE CAUSE	REMEDY
No horizontal deflection at either HOR 60 cps or SYNC positions of HORIZ. SELECTOR (sweep circuit checks o. k.)	C19 open. V5, 6 defective. C27 shorted. C21 open. HORIZ. GAIN R53 defective. HORIZ. SELECTOR S2 defective.	Replace Replace Replace Replace Replace Replace
No horizontal positioning.	R86, 69 defective. HORIZ. POS. control R59 defective. C22 shorted.	Check and replace if necessary. Replace Replace
Horizontal deflection present but distorted.	C27 open. C22 open. V6 defective. R77, 78 defective.	Replace Replace Replace Replace

*Indicates replacement of component in this group makes it necessary to repeat some part of the adjustment procedure given in MAINTENANCE.

VOLTAGE CHART

TYPE	PIN NO.											
	1	2	3	4	5	6	7	8	9	10	11	12
V1 6AU8	110V	110V	290V	3.5V AC	3.5V AC	2.7V	0	120V	110V	—	—	—
V2 6AU8	110V	110V	290V	3.5V AC	3.5V AC	2.7V	0	120V	110V	—	—	—
V3 12BY7	110V	120V	120V	3.5V AC	3.5V AC	3.5V AC	300V	250V	110V	—	—	—
V4 12BY7	110V	120V	120V	3.5V AC	3.5V AC	3.5V AC	300V	250V	110V	—	—	—
V5 6BL8	270V	65V -6V	50V	3.5V AC	3.5V AC	62V	0	14V	0	—	—	—
V6 12AZ7	130V	50V	80V	3.5V AC	3.5V AC	230V	80V	80V	3.5V AC	—	—	—
V7 6BL8	215V	0	210V	3.5V AC	3.5V AC	110V	2.8V	120V	120V	—	—	—
V8 6BL8	215V	0	210V	3.5V AC	3.5V AC	110V	2.8V	120V	120V	—	—	—
V9 12AU7	225V	120V	125V	3.5V AC	3.5V AC	300V	120V	120V	3.5V AC	—	—	—
V10 5DEP1	-1500V	-1500V	-1500V to -1300V	-760V to -1200V	—	280V	300V	0 to 375V	310V	240V	—	-1500V

Unless otherwise indicated, all voltages are DC positive and measured to chassis.

Line voltage: 117 Volts 60 Hz.

All measurements made with VTVM of approximately 11 megs. input impedance.

All voltages may vary by $\pm 15\%$.

RESISTANCE CHART

PIN NO.

TUBE	1	2	3	4	5	6	7	8	9	10	11	12
V1 6AU8	47K	150K	150K	F	F	2.5K to 5K	1.2M	150K	150K	—	—	—
V2 6AU8	47K	150K	150K	F	F	2.5K to 5K	100	150K	150K	—	—	—
V3 12BY7	2.5K	47K	2.5K	F	F	F	200K	150K	2.5K	—	—	—
V4 12BY7	2.5K	47K	2.5K	F	F	F	200K	150K	2.5K	—	—	—
V5 6BL8	150K	500K	400K	F	F	4.7K	0	300 2500	2.3M	—	—	—
V6 12AZ7	40K	15M	4.7K	F	F	150K	30K	4.7K	F	—	—	—
V7 6BL8	150K	600	150K	F	F	150K	2.5K	47K	150K	—	—	—
V8 6BL8	150K	100	150K	F	F	150K	2.5K	47K	150K	—	—	—
V9 12AU7	150K	55K	15K	F	F	150K	55K	15K	F	—	—	—
V10 5DEP1	6.2M	7M	6M	3.9M	—	120K	120K	120K	150K	150K	—	6.2M

All controls are set counter-clockwise for resistance measurement.

All 150K resistance measurement will have large delay until final reading can be obtained.

Measurements on V10 Pins will have large delay until final reading can be obtained.

(F) Filament Pins

All resistance values may normally vary by $\pm 15\%$.

All resistance and voltage measurements are taken with respect to ground.

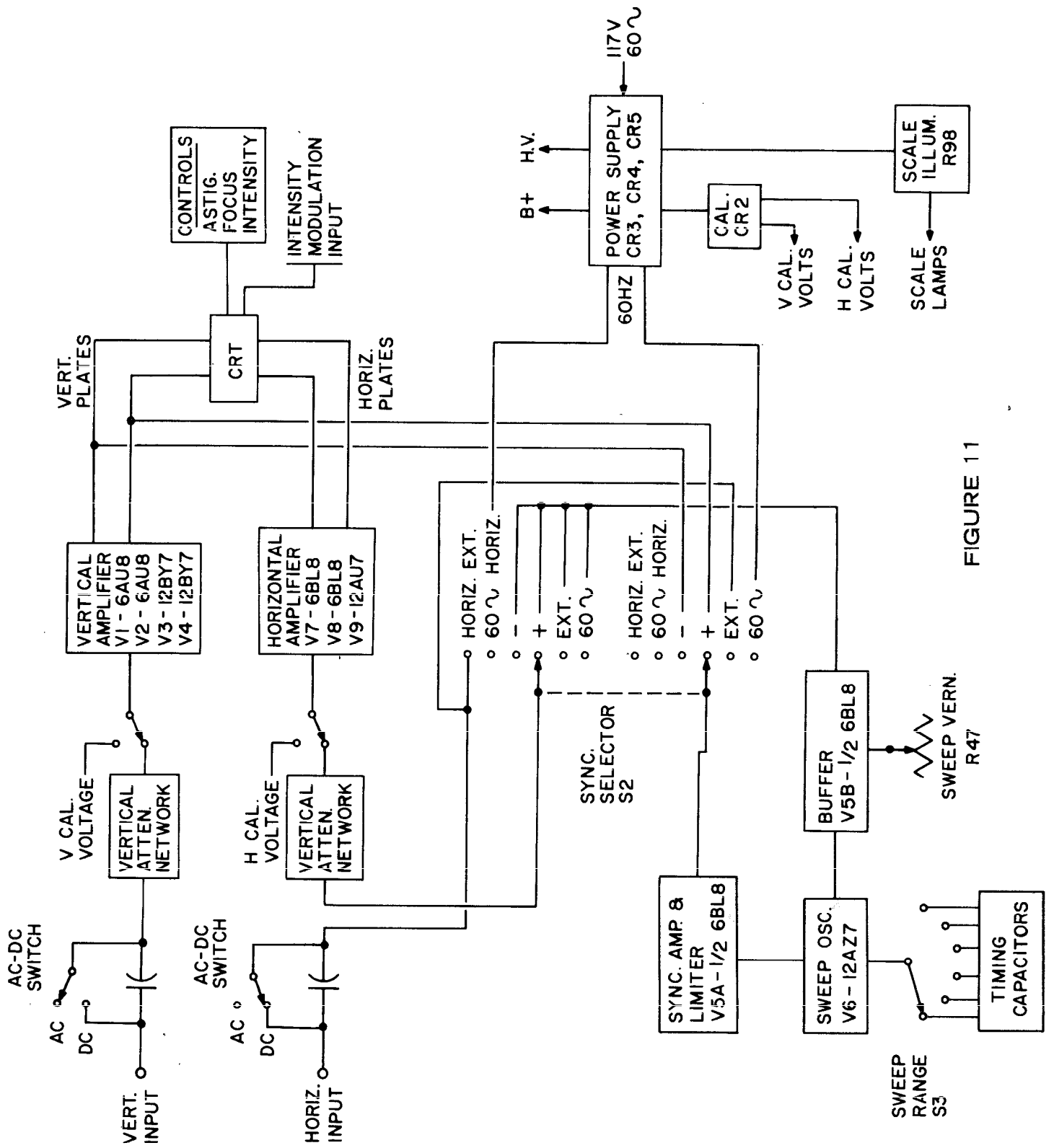
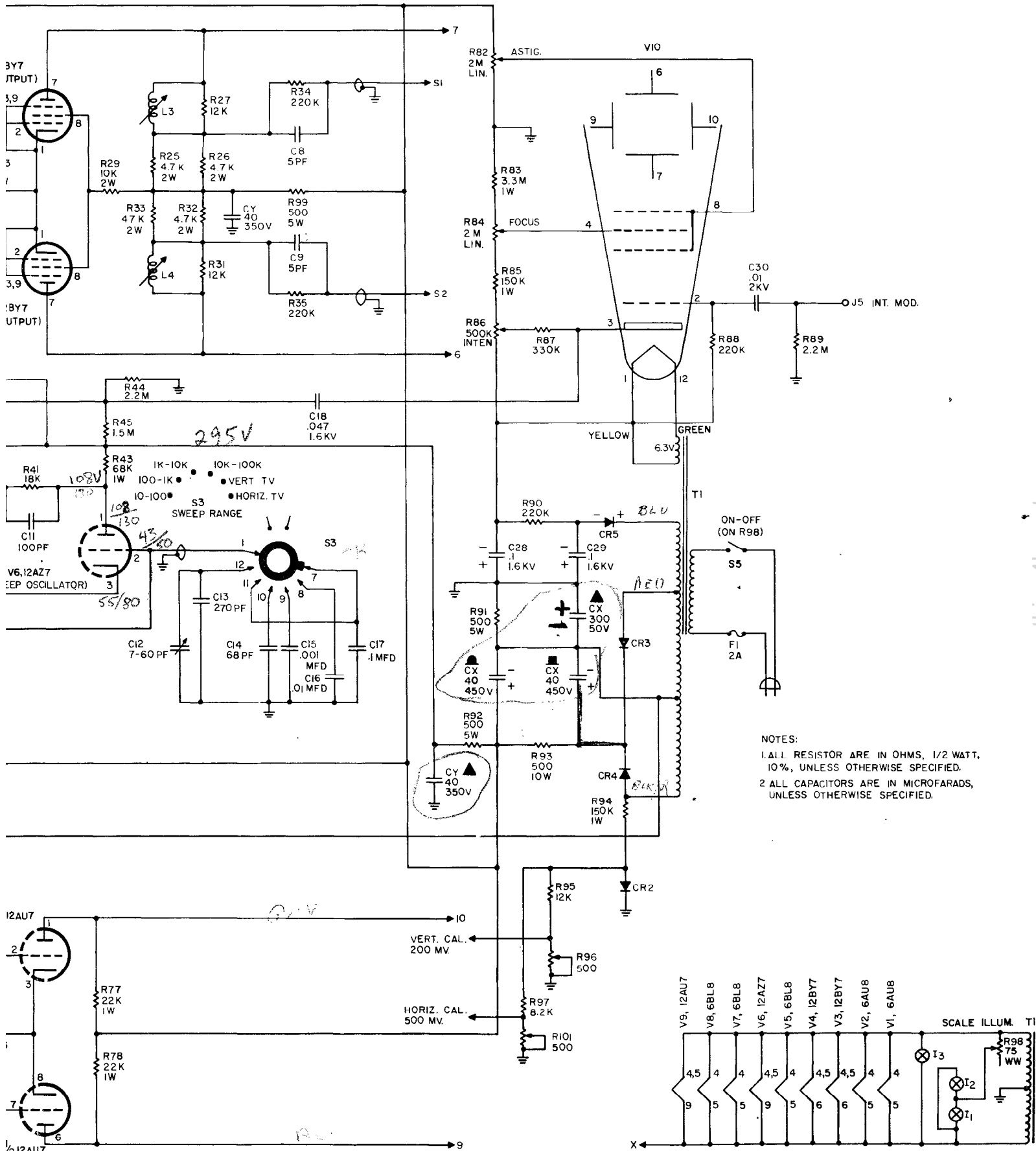

FIGURE 11



NOTES:
 1. ALL RESISTOR ARE IN OHMS, 1/2 WATT, 10%, UNLESS OTHERWISE SPECIFIED.
 2. ALL CAPACITORS ARE IN MICROFARADS, UNLESS OTHERWISE SPECIFIED.

EICO 465 SCHEMATIC DIAGRAM

PARTS LIST

PRICE EACH	STOCK NO.	SYM. NO.	DESCRIPTION	QTY.
RESISTORS (In ohms, 1/2W, 10% unless otherwise specified)				
.08	10423	R62, 63	2.2K	2
.08	10429	R102	470	1
.08	10430	R39	4.7K	1
.08	10431	R37	470K	1
.08	10432	R51	1K	1
.08	10442	R52	1.5K	1
.08	10452	R97	8.2K	1
.08	10455	R45	1.5M	1
.11	10456	R100	820, 1W	1
.09	10559	R2, 55	car., comp., 1K, 5%	2
.09	10560	R4, 57	" " 10K "	2
.09	10561	R6, 59	" " 100K "	2
.18	10838	R83	3.3M, 1W	1
.18	10846	R85, 94	150K "	2
.18	10848	R43	68K "	1
.18	10849	R20, 21, 72, 73	47K "	4
.18	10851	R77, 78	22K "	2
.17	10852	R53, 76	15K "	2
.17	10855	R40	4.7K "	1
.18	10861	R79	470 "	1
.29	10952	R25, 26, 32, 33	4.7K, 2W	4
.29	10956	R29	10K "	1
.31	10960	R68, 69	6.8K "	2
.32	10967 11505	R15, 17, 24	2.5K " 5%	2
.14	11505	R8, 9, 18, 19, 61, 65, 70, 71, 50, 74, 75	100, 5%	11
.14	11518	R44, 49, 89	2.2M, 5%	3
.13	11538	R38	22K "	1
.14	11542	R10, 11	1.6K "	2
.13	11548	R1, 7, 54, 60	1M "	4
.14	11550	R87	330K "	1
.14	11553	R88, 90, 34, 35	220K "	4
.14	11559	R27, 31, 95	12K "	3
.14	11561	R46	680K "	1
.14	11563	R41	18K "	1
.14	11567	R48	270K "	1
.17	11575	R101	9.5K "	1
.17	11576	R5, 58	900K "	2
.17	11577	R3, 56	990K "	2
.38	14300	R42	w.w., 10K, 10W, 10%	1
.36	14301	R14	w.w., 6K " 10%	1
.36	14313	R23	w.w., 2K " 10%	1
.36	14314	R93	w.w., 500 " 10%	1
.32	14500	R91, 92, 99	w.w., 500, 5W, 10%	3
.35	14508	R22	w.w., 2.7K " 10%	1
.37	14513	R80	w.w., 5K " 10%	1

POTENTIOMETERS

.82	16000	R36, 81	2K, linear	2
.91	16001	R16	1K "	1
.82	16011	R82, 84	2M "	2
3.00	18009	R67	5K "	1
1.13	18180	R13, 66	10K "	2
1.13	18181	R86	500K, ccw	1
.48	19003	R96, 103	500Ω	2
3.22	19007	R98	w.w., 75Ω, w/switch	1
2.83	19026	R24	500Ω, 2W	1

PRICE EACH	STOCK NO.	SYM. NO.	DESCRIPTION	QTY.
CAPACITORS				
.56	20015	C1, 19	mylar, .25mfd, 600V, 20%	2
.44	20085	C20	mylar, .22mfd, 200V, 10%	1
.22	20087	C3, 16, 23	mylar, .01mfd, 400V, 10%	3
.35	20089	C10, 17	disc., .1mfd, 400V, 10%	2
1.12	20090	C28, 29	mylar, .1mfd, 1600V, 10%	2
.77	20096	C18	mylar, .047mfd, 1600V, 10%	1
.25	21001	C13	mica, 270pf, 500V, 20%	1
.09	22509	C7, 11, 27	disc., 100pf, 500V, 10%	3
.11	22521	C5, 25, 32	disc., .001mfd, 400V, 10%	3
.13	22556	C14	disc., 68pf, 500V, 10%	1
.26	22583	C30	disc., .01mfd, 2000V, 10%	1
.12	22594	C8, 9	disc., 5pf, 500V, 10%	2
.50	23011	C21, 31	elec., 50mfd, 50V, 10%	2
3.15	24020	CY, CZ	elec., 20-20/400V, 40-40/350V	2
3.35	24025	CX	elec., 40-40/450V, 300/50V	1
.53	29519	C2, 4, 6, 12, 22, 24, 26	trimmer, 7-60pf	7

TRANSFORMERS & COILS

23.12	30091	T1	transformer	1
.60	36010	L1, 2, 3, 4	coil, 100mH	4

JACKS, BINDING POSTS & KNOBS

.16	50029	J5	jack, pin, black	1
.34	52006	J1, 2	binding post, #8	2
.34	52008	J3, 4	binding post, #8, ground	2
.66	53036		knob, 1-1/16 dia.	3
.49	53037		knob, 3/4 dia.	4
.56	53040		knob concentric, outer	3
.30	53107		knob concentric, inner	3

TERMINAL STRIPS

.10	54000	TB7	1 post left	1
.10	54003	TB17	2 post	1
.06	54004	TB4, 6, 8, 10, 15	2 post, w/gnd.	5
.10	54006	TB14, 16	3 post, 2 right	2
.10	54007	TB3, 11	3 post, 2 right, w/gnd.	2
.08	54018	TB1, 2, 5, 9, 13	4 post, w/gnd.	5
.10	54086	TB12	3 post, 2 right, w/gnd. (CSA)	1

PRICE EACH	STOCK NO.	SYM. NO.	DESCRIPTION	QTY.
SWITCHES				
11.40	60152	S3	rotary, w/ ^{10M} Pot.	1
5.16	60196	S2	" "	1
11.10	60198	SL, 6	" w/10M-Pot.	2
.51	62040	S4, 7	slide, SPST	2

TUBES

4.40	90027	V1, 2	6AU8 (GE)	2
2.35	90033	V9	12AU7	1
3.05	90064	V3, 4	12BY7	2
3.75	90071	V5, 7, 8	6BL8	3
2.85	90098	V6	12AZ7	1
44.24	90122	V10	CRT., 5DEPI	1

FUSES, BULBS & DIODES

.14	91011	F1	fuse, 2-1/2 amp. slo-blo	1
1.33	92019	II, 2, 3	bulb, scale illuminations	3
1.40	93017	CR1	diode, power 200ma, 380 PIV	1
3.04	93018	CR2	diode, Zener, IN713	1
3.60	93024	CR3, 4	diode, silicon, 1200 PIV	2
2.24	93039 93042	CR5	diode, selenium, H. V. 3 KU 50MA	1

SOCKETS & FUSEHOLDERS

.42	97026	XV10	socket, 12 PIN CRT	1
.23	97081	XVI, 2, 3, 4, 5, 6, 7, 8, 9	socket, 9 pin min. bot. mt.	9
5.88	97311		Mu metal shield	1
1.02	97800	XF1	fuseholder	1

SHEET METAL & MISCELLANEOUS

4.63	80213		front panel	1
2.40	81521		Bezel	1
2.35	81528		Chassis	1
2.75	81529		Top bracket	1
1.00	81530		side bracket, right	1
1.00	81531		side bracket, left	1
8.00	81532		front sub panel	1
2.60	81533		chassis, main	1
2.20	81534		bottom bracket	1
4.15	81535		side plate	2
3.50	81536		cover, top	1
3.50	81537		cover, bottom	1
7.30	81538		back panel	1
.50	81547		CRT bracket	2
.40	81995		bracket linecord	2
.54	82115		strain relief	1
.67	85020		bushing bezel	4
1.92	86007		frame, front	2
1.65	87017		handle	1
.03	89823		plastic lens cap	1
.03	89830		handle end cap	2

PRICE EACH	STOCK NO.	SYM. NO.	DESCRIPTION	QTY.
MISCELLANEOUS (continued)				
2.28	57002		linecord, 3 cond.	1
.13	59009		graph screen	1
.94	59010		filter	1
.27	59303		felt, CRT bezel	1
.23	59317		strip, sponge, rubber	1
.09	59508		mounting plate, insulated 4 prong	1
1.50	66194		manual, operating	1
3.00	66446		manual, assembly	1

HARDWARE

.01	40000		Nut, Hex, #6-32x1/4	20
.02	40001		" " 3/8-32x1/2	19
.01	40007		" " #4-40x1/4	18
.07	40016		" " 1/2-24(for fuseholder)	1
.01	40045		Nut, Hex, #8-32x5/16	4
.56	40063		" Knurled, 3/8-32	4
.01	41002		screw, #6x3/8, P. K., B. H., Type A	22
.01	41086		screw, #6-32x5/16, B. H.	24
.01	41090		screw, #4-40x5/16, B. H.	18
.01	41091		screw, #4-40x1/4, F. H.	4
.01	41140		screw, #6-32x1/4, Self Tap, Rd. Hd., Phillips	20
.02	42000		washer, lock, 3/8	22
.01	42001		" flat, 3/8	15
.01	42002		" lock, #6	24
.01	42007		" " #4	18
.01	42008		" " #8	4
.03	42029		" rubber, 1/2	1
.02	42511		Retainer ring	2
.02	43000		Lug, ground, #6	1
.02	43001		" pot, ground, 3/8	2
.01	43004		Lug, ground #8	2
.08	46003		Grommet, rubber, 1/2	1
.04	46012		Grommet, rubber, 3/8	1
.09	46016		foot, plastic	4
.03	46024		Grommet, rubber, 5/16	2

Prices and specifications subject to change without notice. To order replacement parts, remit with order; specify part number and descriptions. Add \$1.00 for mailing and handling; if a power transformer is included in the order, add instead \$1.50 for mailing and handling.

EICO—LEADER IN CREATIVE ELECTRONICS

For over 23 years, EICO has been designing and manufacturing electronic products and is now the world's largest producer of electronic kits and factory wired equipment marketed exclusively through dealers and distributors throughout the world.

Whatever your electronics interest, there's a wide range of versatile, professional EICO products for you to choose from, and each designed to provide you with the most pleasure and quality performance for your money.

The fact that more than 3 million EICO products are in use throughout the world attests to their quality and performance. EICO kits are so popular because they represent the best value and are available for inspection and immediate over-the-counter delivery at more than 2500 EICO dealers and distributors.

Should you have any questions about the selection or applications of any EICO product, you may at any time consult by mail with our technical correspondence staff. There's no charge for this service.

For your added convenience — EICO has set up a network of 200 service stations to make available to you on a local neighborhood basis the same high-quality technical service competence and replacement parts you get from our factory, should you ever need them.

The EICO Catalog is available to you Free for the asking. The catalog describes Eico's complete line of 200 "Best Buys" in Electronics. Cortina® Stereo Components, EICOCRAFT® Solid State electronic projects, Citizens Band 2-Way Radios, Automotive electronics, Amateur Radio equipment, Visutronic® Educational Training Aids, TRUVOHM® professional Multimeters and the famous EICO line of Test Instruments for home, shop, factory, laboratory and school.



EICO Electronic Instrument Co., Inc., 283 Malta Street, Brooklyn, N. Y. 11207



EVERYTHING 4 LESS



ENJOY YOUR BOOKS



PLEASE VISIT OUR STORE FOR EVEN MORE GREAT STUFF!

WWW.EVERYTHING4LESSSTORE.COM

COPYRIGHT NOTICE

ALL MATERIALS INCLUDING CD/DVD AND PDF FILES ARE COPYRIGHTED

WWW.EVERYTHING4LESSSTORE.COM VON WALTHOUR PRODUCTIONS AND MAY NOT BE REPRODUCED, COPIED OR RESOLD UNDER ANY CIRCUMSTANCES. YOU MAY HOWEVER MAKE A COPY FOR YOUR OWN PERSONAL BACKUP. MATERIALS ARE FOR PERSONAL USE ONLY.

IF YOU PURCHASED THIS FROM ANYWHERE BUT FROM US PLEASE NOTIFY US IMMEDIATELY SO THAT WE MAY CHECK IF YOU PURCHASED FROM AN AUTHORIZED RESELLER SO WE CAN LET YOU KNOW IF YOU NEED TO RETURN FOR FULL REFUND FROM AN UNAUTHORIZED SELLER.

THANKS AGAIN AND PLEASE TAKE THE TIME TO VISIT OUR STORE.

ATTENTION! EVERYTHING ON SALE NOW!!



HOT SALE!

**THIS PAGE COPYRIGHT VON WALTHOUR PRODUCTIONS
WWW.EVERYTHING4LESSSTORE.COM**