

FLUKE®

10

Multimeter

Users Manual

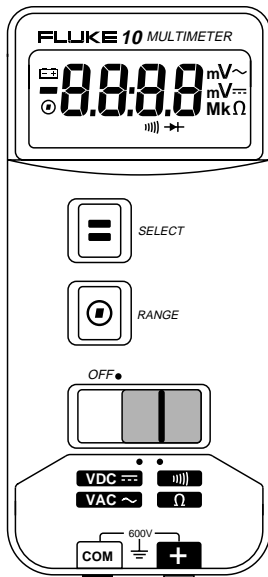

10 Users Manual

Contents	Page
Read First -- Safety Information.....	2
Contacting Fluke for Service, Accessories, or Parts.....	3
Standby Mode	4
Operating Features.....	5
Using Accessories	6
Symbols.....	6
Using the Autorange and Manual Range Modes	7
Measuring Voltage.....	8
Testing Continuity And Measuring Resistance	10
Turning the Beeper Off	10
Testing Diodes.....	12
Maintenance	14
Replacing the Battery	14
Specifications.....	15

Read First -- Safety Information

⚠ Warnings and Cautions

To ensure that the meter is used safely and to avoid damage to the meter:

- Use the meter only as described in this manual, or the protection provided by the meter might be impaired.
- Verify the meter's operation by measuring a known voltage.
- Do not use the meter if the meter or test leads look damaged, or if you suspect that the meter is not operating properly. If in doubt have the meter serviced.
- Replace the battery as soon as the low battery indicator () appears to avoid false readings that can lead to shock and injury.
- Turn off power to the circuit under test before cutting, unsoldering, or breaking the circuit. Small amounts of current can be dangerous.
- Do not apply more than 600 V rms between a terminal and earth ground.
- Use caution when working above 60 V dc or 30 V ac rms. Such voltages pose a shock hazard.
- Keep your fingers behind the finger guards on the probes when using the probes.
- Disconnect the live test lead before disconnecting the common test lead.

Contacting Fluke for Service, Accessories, or Parts

This meter should be serviced only by a qualified service technician.

To order the *10 Series Service Manual* (PN 900824), accessories, parts, or to get other information, contact Fluke at one the phone numbers listed below:

1-888- 993-5853 in USA and Canada

+31 402-678-200 in Europe

+81-3-3434-0181 Japan

+65-738-5655 Singapore

+1-425-446-5500 in other countries

Visit Fluke's web site at **www.fluke.com**.

Address correspondence to Fluke at:

Fluke Corporation
PO Box 9090
Everett, Washington 98206-9090
USA

Fluke Europe B.V
PO Box 1186
5602 BD Eindhoven
The Netherlands

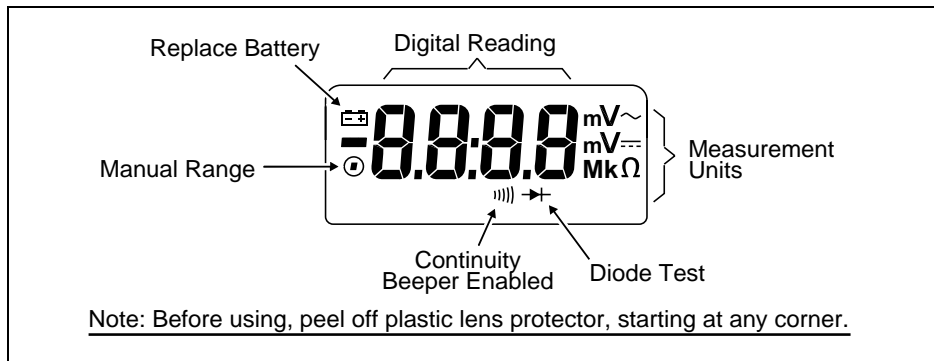

acz01f.eps

Figure 1. Display

Standby Mode

In Standby mode, the display goes blank to preserve battery life. The meter beeps and enters Standby if it is LEFT ON BUT IS INACTIVE for more than 45 minutes. Press any button to resume operation.

Operating Features

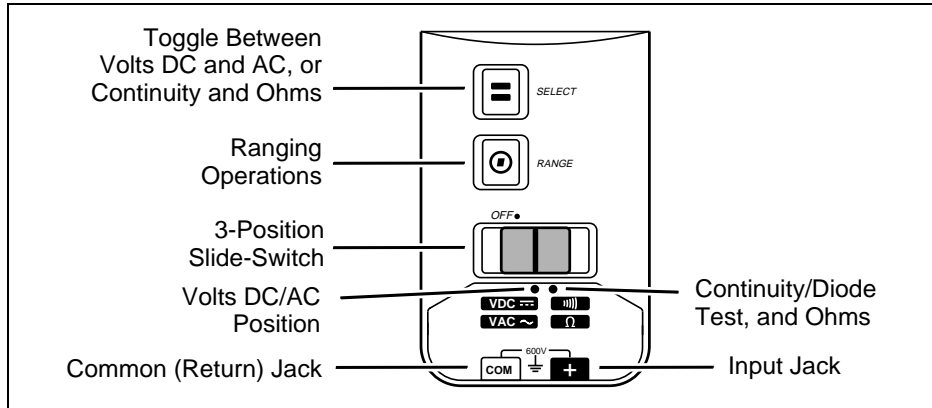

acz02f.eps











Figure 2. Operating Features

Using Accessories

When using accessories, put the slide-switch in the volts position.

For ease of reading, manually select the 4000 mV range. In the 4000 mV range, 1 mV corresponds to 1 unit being measured by the accessory.

Symbols

	Important Information; see manual		Diode
	AC (Alternating Current)		Earth Ground
	DC (Direct Current)		Double Insulation
	Underwriters Laboratories, Inc		VDE (Verband Deutscher Electroniker)
	Battery. Low Battery on Display.		Continuity Beeper

Using the Autorange and Manual Range Modes

The range for each function determines the highest value the meter can measure. If the range is too low, the meter displays **OL** (overload) and beeps. If the range is too high, the display shows fewer digits of resolution.

The meter has an autorange and manual range mode. In autorange, the meter selects the range automatically. The meter defaults to autorange when you turn it on. In manual range, you lock the meter in a range.

To manually select a range:

1. Press [**◻**] **RANGE** to lock the meter in the present range. **◻** is displayed.
2. Press [**◻**] **RANGE** to step through the ranges. NOTE: The 4000 mV range, which can only be entered in manual range, is convenient when using accessories.
3. To return to autorange, press [**◻**] **RANGE** for 2 seconds (until **◻** is no longer displayed), or change the measurement function.

Measuring Voltage

1. Insert the test leads in the jacks.
2. To select a voltage function, put the slide-switch in the middle position. (Figure 3.)
Press the [] **SELECT** button to toggle between dc and ac.
3. Touch the probes to the test points, and read the display.
The meter beeps when **OL** (overload) is displayed.

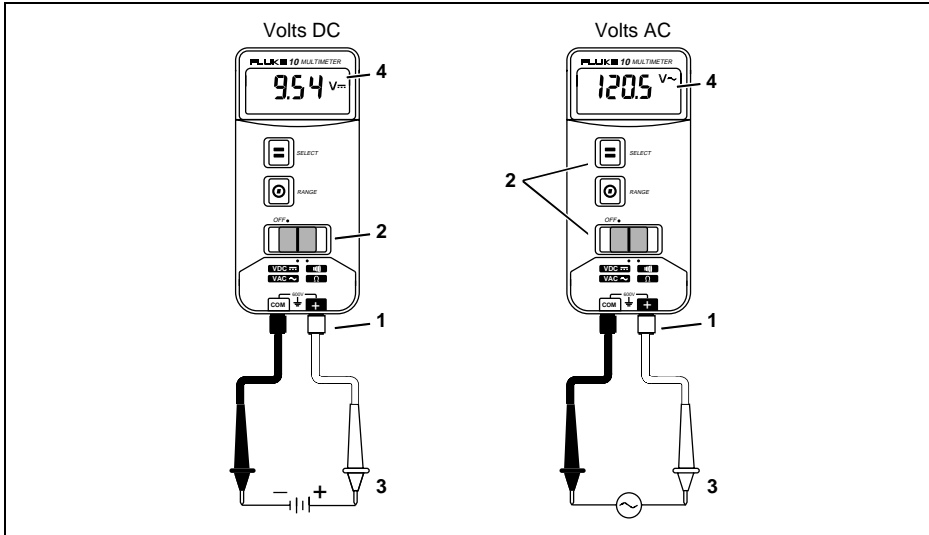





Figure 3. Measuring Voltage

acz03f.eps

Testing Continuity And Measuring Resistance

1. Insert the test leads in the jacks, and turn off power to the circuit under test. External voltage across the components causes invalid readings.
2. Put the slide-switch in the continuity / ohms position (Figure 4). The meter selects the continuity/diode or ohms function.

Press [] **SELECT** to toggle between the continuity / diode () ) and ohms (Ω) functions.

3. Touch the probes to the test points.

In ohms, read the resistance on the display.

In continuity test, the beeper sounds continuously if continuity exists (resistance $<25 \Omega$). Opens and shorts longer than $250 \mu s$ are detected.

Turning the Beeper Off

To disable beeper functions, press and hold down [] for 2 seconds while turning the meter on.

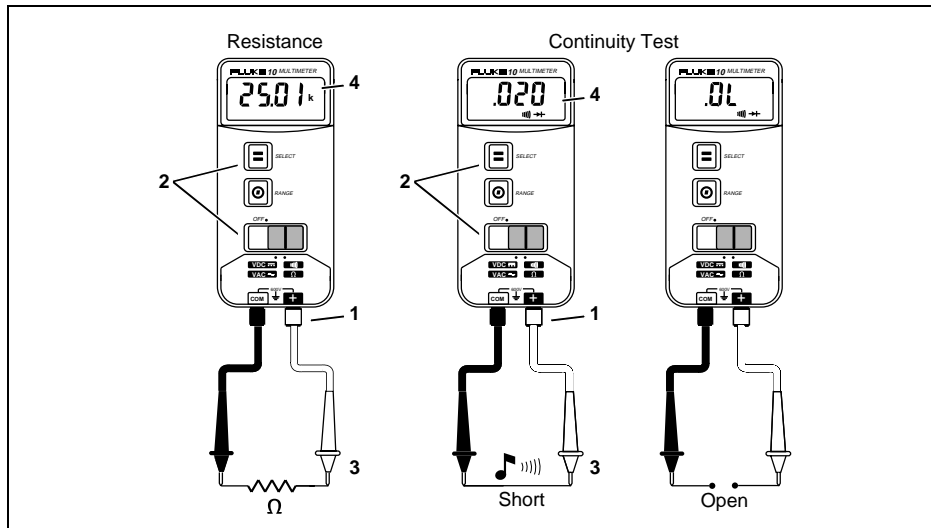



acz04f.eps

Figure 4. Continuity Test and Resistance Measurement

Testing Diodes

1. Insert the test leads in the jacks.
2. Put the slide-switch in the continuity / ohms position. The meter selects either the continuity / diode () or ohms (Ω) function.

If ohms is selected, press [] **SELECT** to toggle to the continuity/diode function. To toggle the beeper on or off in continuity/diode test, press [] **RANGE**. When the beeper is enabled,  is displayed.

3. Touch probes to the diode (Figure 5A). A forward-voltage drop of about 0.6 V (typical for a silicon diode) causes the meter to beep once.
4. Reverse probes (Figure 5B). If the diode is good, **OL** is displayed.
If the diode is shorted (Figure 5C), the beeper sounds continuously in at least one direction.

If the diode is open, **OL** is displayed in both directions.

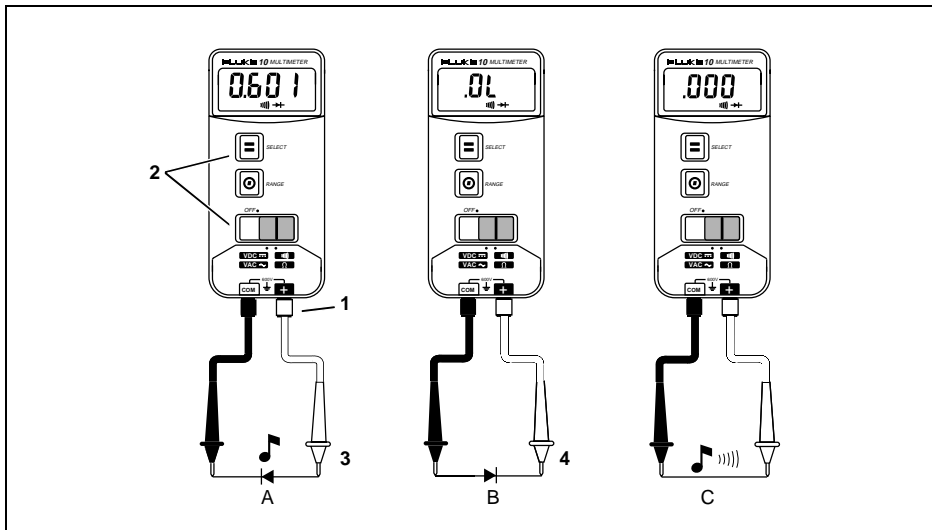

Figure 5. Testing Diodes

acz05f.eps

Maintenance

⚠ Warning

To avoid electrical shock or damage to the meter, do not get water inside the case, and remove the test leads and any input signals before opening the case.

Wipe the case with a damp cloth and detergent.

Do not use abrasives or solvents.

Replacing the Battery

⚠ Warning

Replace the battery as soon as the low battery indicator () appears to avoid false readings that can lead to shock and injury.

To replace the battery:

1. Turn the meter **OFF** and remove the test leads from the meter.
2. Remove the four screws from the back of the meter and lift off the front.
3. Remove the battery and replace it with a 9 V battery (NEDA 1604 or IEC 6F22).

Specifications

This meter complies with Part 15 of FCC Rules. Operation is subject to the following conditions:

1. This meter may not cause harmful interference.
2. This meter must accept any interference received, including interference that may cause undesired operation.

Accuracy is specified for a period of one year after calibration, at 18 °C to 28 °C (64 °F to 82 °F) with relative humidity to 90 %.

AC conversions are ac-coupled, average responding, and calibrated to the rms value of a sine wave input. Accuracy Specifications are given as:

+/- ([% of reading] + number of least significant digits)

Maximum Voltage Between any Terminal and Earth Ground	600 V rms
Display	3 3/4-digits, 4000 counts, updates 4/sec
Operating Temperature	-10 °C to 50 °C
Storage Temperature	-30 °C to 60 °C indefinitely (to -40 °C for 100 hrs)
Temperature Coefficient	0.1 x (specified accuracy) / °C (<18 °C or >28 °C)
Relative Humidity	0 % to 90 % (-10 °C to 35 °C); 0 % to 70 % (35 °C to 50 °C)
Battery Type	9V, NEDA 1604 or IEC 6F22
Battery Life	Alkaline, 650 hrs continuous; Carbon-zinc, 450 hrs continuous
Shock, Vibration	1 meter shock. Vibration per MIL-T-28800D for a Class 3 Instrument
Size (H x W x L)	1.35 x 2.75 x 5.55 inches; (3.46 x 7.05 x 14.23 cm)
Weight	10 oz (286 g)
Safety	Complies with Protection Class II requirement of UL1244, ANSI/ISA-S82, CSA C22.2 No 231, and VDE 0411, and IEC 1010 overvoltage CAT III. CAT III instruments are designed to protect against transients in fixed-equipment installations at the distribution level.
EMI Regulations	Complies with FCC Part 15, Class B, and VDE 0871B.

Function	Range	Resolution	Accuracy (50 to 400 Hz)
V_{\sim}	4000 mV *	1 mV	+/- (2.9 % + 3)
	4.000 V	0.001 V	+/- (2.9 % + 3)
	40.00 V	0.01 V	+/- (2.9 % + 3)
	400.0 V	0.1 V	+/- (2.9 % + 3)
	600 V	1 V	+/- (2.9 % + 3)
V_{DC}	4000 mV *	1 mV	+/- (1.5 % + 2)
	4.000 V	0.001 V	+/- (1.5 % + 2)
	40.00 V	0.01 V	+/- (1.5 % + 1)
	400.0 V	0.1 V	+/- (1.5 % + 1)
	600 V	1 V	+/- (1.5 % + 1)
Ω	400.0 Ω	0.1 Ω	+/- (1.5 % + 2)
	4.000 k Ω	0.001 k Ω	+/- (1.5 % + 1)
	40.00 k Ω	0.01 k Ω	+/- (1.5 % + 1)
	400.0 k Ω	0.1 k Ω	+/- (1.5 % + 1)
	4.000 M Ω	0.001 M Ω	+/- (1.5 % + 1)
	40.00 M Ω	0.01 M Ω	+/- (1.9 % + 3)
$\text{DIP} \rightarrow \text{DIP}$	2.000 V	0.001 V	+/- (1.5 % + 2) **
<p>* The 4000 mV range can only be entered in manual range mode. Use the 4000 mV range with accessories.</p> <p>** The beeper is guaranteed to come on at <25Ω and turn off at >250Ω. The meter detects opens or shorts of 250 μs or longer.</p>			

Function	Overload Protection *	Input Impedance (Nominal)	Common Mode Rejection Ration (1 k Ω Unbalance)	Normal Mode Rejection	
V$\overline{\text{---}}$	600 V dc	>10 M Ω <100 pF 50 Hz or 60 Hz	100 dB @ dc @ 50 or 60 Hz	>50 dB @ 50 or 60 Hz	
V\sim	600 V rms	>5 M Ω <100 pF (ac-coupled)	>60 dB, dc, 60 Hz	NA	
Ω		Open Circuit Test Voltage	Full Scale Voltage		Short Circuit Current
			To 4.0 MΩ	40 MΩ	
	600 V rms	< 1.5 V dc	<450 mV dc	<1.5 V dc	<500 μ A
\rightarrow	600 V rms	2.4 to 3.0 V dc	2.400 V dc	0.95 mA typical	
* 3 x 10 ⁶ V Hz Maximum					