

FLUKE®

***Fluke* 192/196/199**
ScopeMeter

Users Manual

4822 872 00983

October 2000, Rev.2, 2/01

© 2000 Fluke Corporation. All rights reserved. Printed in the Netherlands.

All product names are trademarks of their respective companies.

SCOPE

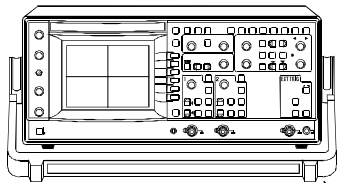

CURSOR

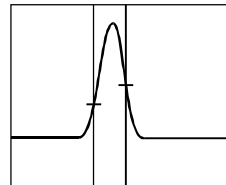

METER

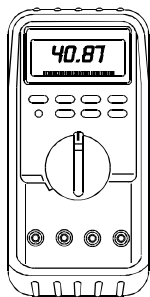

ZOOM

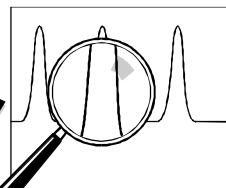

RECORDER

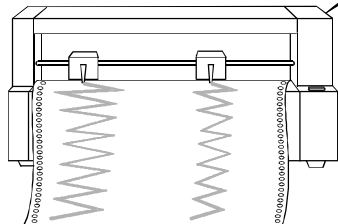

REPLAY

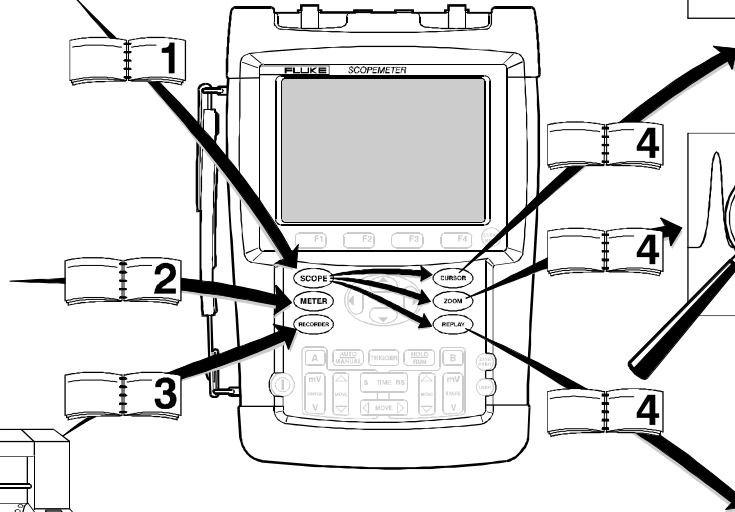

LIMITED WARRANTY & LIMITATION OF LIABILITY

Each Fluke product is warranted to be free from defects in material and workmanship under normal use and service. The warranty period is three years and begins on the date of shipment. Parts, product repairs and services are warranted for 90 days. This warranty extends only to the original buyer or end-user customer of a Fluke authorized reseller, and does not apply to fuses, disposable batteries or to any product which, in Fluke's opinion, has been misused, altered, neglected or damaged by accident or abnormal conditions of operation or handling. Fluke warrants that software will operate substantially in accordance with its functional specifications for 90 days and that it has been properly recorded on non-defective media. Fluke does not warrant that software will be error free or operate without interruption.

Fluke authorized resellers shall extend this warranty on new and unused products to end-user customers only but have no authority to extend a greater or different warranty on behalf of Fluke. Warranty support is available if product is purchased through a Fluke authorized sales outlet or Buyer has paid the applicable international price. Fluke reserves the right to invoice Buyer for importation costs of repair/replacement parts when product purchased in one country is submitted for repair in another country.

Fluke's warranty obligation is limited, at Fluke's option, to refund of the purchase price, free of charge repair, or replacement of a defective product which is returned to a Fluke authorized service center within the warranty period.

To obtain warranty service, contact your nearest Fluke authorized service center or send the product, with a description of the difficulty, postage and insurance prepaid (FOB Destination), to the nearest Fluke authorized service center. Fluke assumes no risk for damage in transit. Following warranty repair, the product will be returned to Buyer, transportation prepaid (FOB Destination). If Fluke determines that the failure was caused by misuse, alteration, accident or abnormal condition of operation or handling, Fluke will provide an estimate of repair costs and obtain authorization before commencing the work. Following repair, the product will be returned to the Buyer transportation prepaid and the Buyer will be billed for the repair and return transportation charges (FOB Shipping Point).

THIS WARRANTY IS BUYER'S SOLE AND EXCLUSIVE REMEDY AND IS IN LIEU OF ALL OTHER WARRANTIES, EXPRESS OR IMPLIED, INCLUDING BUT NOT LIMITED TO ANY IMPLIED WARRANTY OF MERCHANTABILITY OR FITNESS FOR A PARTICULAR PURPOSE. FLUKE SHALL NOT BE LIABLE FOR ANY SPECIAL, INDIRECT, INCIDENTAL OR CONSEQUENTIAL DAMAGES OR LOSSES, INCLUDING LOSS OF DATA, WHETHER ARISING FROM BREACH OF WARRANTY OR BASED ON CONTRACT, TORT, RELIANCE OR ANY OTHER THEORY.

Since some countries or states do not allow limitation of the term of an implied warranty, or exclusion or limitation of incidental or consequential damages, the limitations and exclusions of this warranty may not apply to every buyer. If any provision of this Warranty is held invalid or unenforceable by a court of competent jurisdiction, such holding will not affect the validity or enforceability of any other provision.

Fluke Corporation, P.O. Box 9090, Everett, WA 98206-9090 USA, or

Fluke Industrial B.V., P.O. Box 90, 7600 AB, Almelo, The Netherlands

SERVICE CENTERS

To locate an authorized service center, visit us on the World Wide Web:

<http://www.fluke.com>

or call Fluke using any of the phone numbers listed below:

+1-888-993-5853 in U.S.A. and Canada

+31-40-2675200 in Europe

+1-425-356-5500 from other countries

Table of Contents

Chapter	Title	Page
	Unpacking the Test Tool Kit.....	2
	Safety Information: Read First.....	4
1	Using The Scope.....	7
	Powering the Test Tool.....	7
	Resetting the Test Tool.....	8
	Navigating a Menu.....	9
	Hiding Key Labels and Menus.....	10
	Input Connections.....	10
	Making Scope Connections.....	11
	Displaying an Unknown Signal with Connect-and-View™.....	12
	Making Automatic Scope Measurements.....	13
	Freezing the Screen.....	14
	Using Average, Persistence and Glitch Capture.....	15
	Acquiring Waveforms.....	18
	Analyzing Waveforms.....	20

2	Using The Multimeter.....	21
	Making Meter Connections.....	21
	Making Multimeter Measurements.....	22
	Freezing the Readings	25
	Selecting Auto/Manual Ranges.....	25
	Making Relative Measurements.....	26
3	Using The Recorder Functions.....	27
	Opening the Recorder Main Menu.....	27
	Plotting Measurements Over Time (TrendPlot™).....	28
	Recording Scope Waveforms In Deep Memory (Scope Record™).....	31
	Analyzing a TrendPlot or Scope Record	34
4	Using Replay, Zoom and Cursors	35
	Replaying the 100 Most Recent Scope Screens	35
	Zooming in on a Waveform	38
	Making Cursor Measurements.....	40
5	Triggering on Waveforms	43
	Setting Trigger Level and Slope.....	44
	Using Trigger Delay or Pre-trigger	45
	Automatic Trigger Options.....	46
	Triggering on Edges.....	47
	Triggering on External Waveforms	50
	Triggering on Video Signals.....	51
	Triggering on Pulses	53

6	Using Memory, PC and Printer	57
	Saving and Recalling	57
	Documenting Screens	61
7	Tips	65
	Using the Standard Accessories	65
	Using the Independently Floating Isolated Inputs	68
	Using the Tilt Stand	70
	Resetting the Test Tool	70
	Suppressing Key Labels and Menu's	70
	Changing the Information Language	71
	Adjusting the Contrast and Brightness	71
	Changing Date and Time	72
	Saving Battery Life	73
	Changing the Auto Set Options.....	74
8	Maintaining the Test Tool	75
	Cleaning the Test Tool.....	75
	Storing the Test Tool	75
	Charging the Batteries	76
	Extending Battery Operation Time	77
	Replacing the NiMH Battery Pack BP190.....	78
	Calibrating the Voltage Probes	78
	Displaying Calibration Information.....	80
	Parts and Accessories.....	80
	Troubleshooting.....	85

9	Specifications	87
	Introduction.....	87
	Dual Input Oscilloscope.....	88
	Automatic Scope Measurements	90
	Meter	94
	DMM Measurements on Meter Inputs.....	94
	Recorder.....	96
	Zoom, Replay and Cursors.....	97
	Miscellaneous	97
	Environmental.....	99
	Safety	100
	10:1 Probe.....	101
	Electromagnetic Immunity	103
	Index	

Declaration of Conformity

for

Fluke 192/196/199

ScopeMeter® test tools

Manufacturer

Fluke Industrial B.V.
Lelyweg 1
7602 EA Almelo
The Netherlands

Statement of Conformity

Based on test results using appropriate standards,
the product is in conformity with
Electromagnetic Compatibility Directive 89/336/EEC
Low Voltage Directive 73/23/EEC

Sample tests

Standards used:

EN 61010.1 (1993)

Safety Requirements for Electrical Equipment for
Measurement, Control, and Laboratory Use

EN-IEC61326-1 (1997)

Electrical equipment for
measurements and laboratory
use -EMC requirements-

The tests have been performed in a
typical configuration.

This Conformity is indicated by the symbol **CE**,
i.e. "Conformité Européenne".

Unpacking the Test Tool Kit

The following items are included in your test tool kit:

Note
When new, the rechargeable NiMH battery is not fully charged. See Chapter 8.

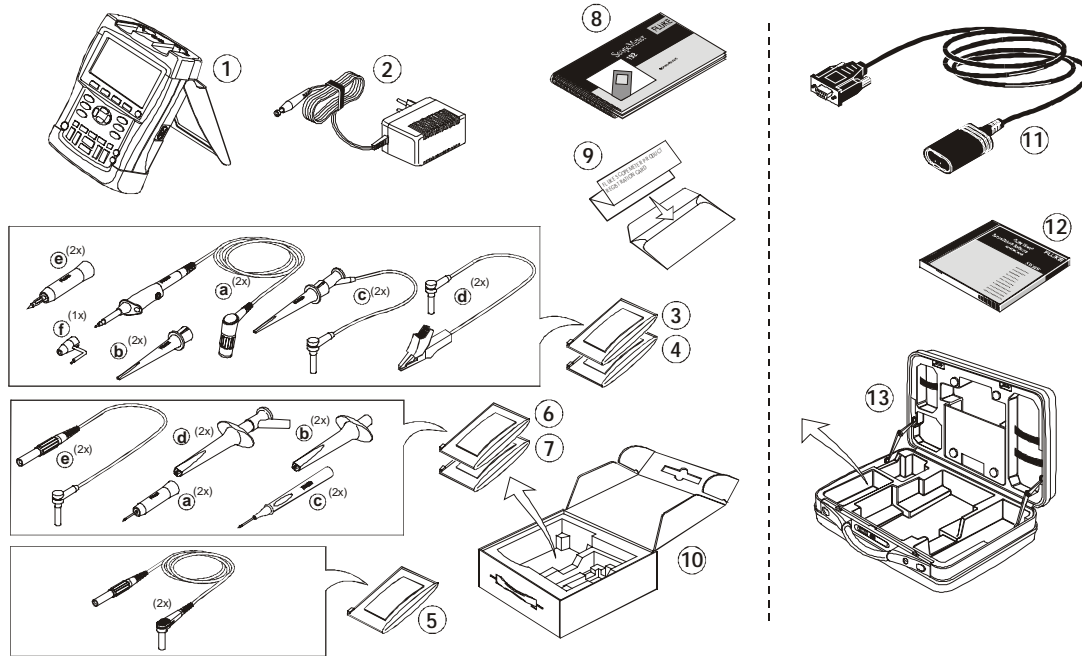

Figure 1. ScopeMeter Test Tool Kit

#	Description
1	ScopeMeter Test Tool
2	Battery Charger (<i>country dependent</i>)
3	10:1 Voltage Probe Set (red) a) 10:1 Voltage Probe (red) b) Hook Clip for Probe Tip (red) c) Ground Lead with Hook Clip (red) d) Ground Lead with Mini Alligator Clip (black) e) 4-mm Test Probe for Probe Tip (red) f) Ground Spring for Probe Tip (black)
4	10:1 Voltage Probe Set (gray) a) 10:1 Voltage Probe (gray) b) Hook Clip for Probe Tip (gray) c) Ground Lead with Hook Clip (gray) d) Ground Lead with Mini Alligator Clip (black) e) 4-mm Test Probe for Probe Tip (gray)
5	Test Leads (red and black)
6	Accessory Set (<i>only for Fluke 196 and 199</i>) a) 2-mm Test Probe for Probe Tip (red) b) Industrial Alligator for Probe Tip (red) c) 2-mm Test Probe for Banana Jack (red) d) Industrial Alligator for Banana Jack (red) e) Ground Lead with 4-mm Banana Jack (black)

#	Description
7	Accessory Set (<i>only for Fluke 196 and 199</i>) a) 2-mm Test Probe for Probe Tip (gray) b) Industrial Alligator for Probe Tip (gray) c) 2-mm Test Probe for Banana Jack (gray) d) Industrial Alligator for Banana Jack (gray) e) Ground Lead with 4-mm Banana Jack (black)
8	Users Manual (this book)
9	Product Registration Card with Envelope
10	Shipment box (<i>basic version only</i>)

Fluke 192-S, 196-S and 199-S versions include also the following items:

#	Description
11	Optically Isolated RS-232 Adapter/Cable
12	FlukeView [®] ScopeMeter [®] Software for Windows [®]
13	Hard Case

Safety Information: Read First









Carefully read the following safety information before using the test tool.

Specific warning and caution statements, where they apply, appear throughout the manual.

A “Warning” identifies conditions and actions that pose hazard(s) to the user.

A “Caution” identifies conditions and actions that may damage the test tool.

The following international symbols are used on the test tool and in this manual:

	See explanation in manual		Double Insulation (Protection Class)
	Disposal information		Earth
	Recycling information		Conformité Européenne
	Safety Approval		Safety Approval

Warning

To avoid electrical shock or fire, use only the Fluke power supply, Model BC190 (Battery Charger / Power Adapter).

Warning

To avoid electrical shock or fire if a test tool input is connected to more than 42 V peak (30 Vrms) or on circuits of more than 4800 VA:

- Use only insulated voltage probes and test leads (and adapters) supplied with the test tool, or equivalents as specified in the accessory list, see Chapter 8.
- Before use, inspect voltage probes, test leads and accessories for mechanical damage and replace when damaged.
- Remove all probes, test leads and accessories that are not in use.
- Always connect the battery charger first to the ac outlet before connecting it to the test tool.
- Do not connect the ground spring to voltages higher than 42 V peak (30 Vrms) from earth ground.
- Do not apply voltages that differ more than 600 V from earth ground to any input when measuring in a CAT III environment. Do not apply voltages that differ more than 1000 V from earth ground to any input when measuring in a CAT II environment.
- Do not apply voltages that differ more than 600 V from each other to the isolated inputs when measuring in a CAT III environment. Do not apply voltages that differ more than 1000 V from each other to the isolated inputs when measuring in a CAT II environment.
- Do not apply input voltages above the rating of the instrument. Use caution when using 1:1 test leads because the probe tip voltage will be directly transmitted to the test tool.
- Do not use exposed metal BNC or banana plug connectors.
- Do not insert metal objects into connectors.
- Always use the test tool only in the manner specified.

Voltage ratings that are mentioned in the warnings, are given as limits for “working voltage”. They represent V ac rms (50-60 Hz) for ac sinewave applications and as V dc for dc applications.

Overvoltage Category III refers to distribution level and fixed installation circuits inside a building.

Overvoltage Category II refers to local level, which is applicable for appliances and portable equipment.

Fluke 192/196/199

Users Manual

The terms 'Isolated' or 'Electrically floating' are used in this manual to indicate a measurement in which the test tool input BNC or banana jack is connected to a voltage different from earth ground.

The isolated input connectors have no exposed metal and are fully insulated to protect against electrical shock.

The red and gray BNC jacks, and the red and black 4-mm banana jacks can independently be connected to a voltage above earth ground for isolated (electrically floating) measurements and are rated up to 1000 Vrms CAT II and 600 Vrms CAT III above earth ground.

If Safety Features are Impaired

Use of the test tool in a manner not specified may impair the protection provided by the equipment.

Before use, inspect the test leads for mechanical damage and replace damaged test leads!

Whenever it is likely that safety has been impaired, the test tool must be turned off and disconnected from the line power. The matter should then be referred to qualified personnel. Safety is likely to be impaired if, for example, the test tool fails to perform the intended measurements or shows visible damage.

Chapter 1

Using The Scope

About this Chapter

This chapter provides a step-by-step introduction to the scope functions of the test tool. The introduction does not cover all of the capabilities of the scope functions but gives basic examples to show how to use the menus and perform basic operations.

Powering the Test Tool

Follow the procedure (steps 1 through 3) in Figure 2 to power the test tool from a standard ac outlet. See Chapter 8 for instructions on using battery power.



Turn the test tool on with the on/off key.

The test tool powers up in its last setup configuration.

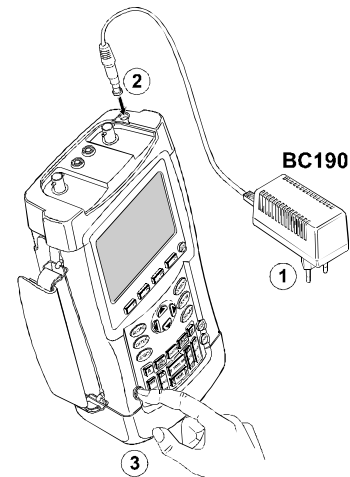





Figure 2. Powering the Test Tool

Resetting the Test Tool

If you want to reset the test tool to the factory settings, do the following:

1		Turn the test tool off.
2		Press and hold.
3		Press and release.

The test tool turns on, and you should hear a double beep, indicating the reset was successful.

4		Release.
---	---	----------

Now look at the display; you will see a screen that looks like Figure 3.

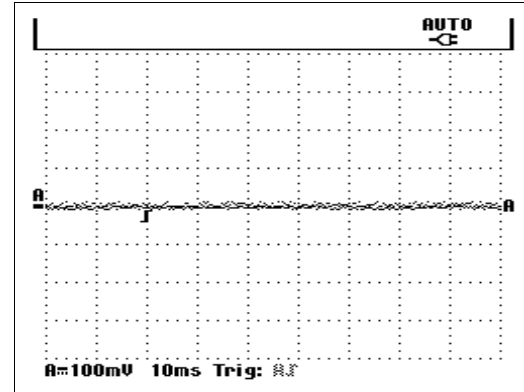



Figure 3. The Screen After Reset

Navigating a Menu

The following example shows how to use the test tool's menus to select a function. Subsequently follow steps 1 through 4 to open the scope menu and to choose an item.

1  Press the **SCOPE** key to display the labels that define the present use for the four blue function keys at the bottom of the screen.

READINGS	READING 1	READING 2	WAVEFORM OPTIONS...
	

Note

To hide the labels for full screen view, press the **SCOPE** key again. This toggling enables you to check the labels without affecting your settings.

2  Open the **Waveform Options** menu. This menu is displayed at the bottom of the screen.

Waveform Options	
Display Glitches:	Waveform:
<input checked="" type="checkbox"/> Yes	<input checked="" type="checkbox"/> Normal
<input type="checkbox"/> No	<input type="checkbox"/> Average...
	<input type="checkbox"/> Persistence...
	<input type="checkbox"/> Mathematics...

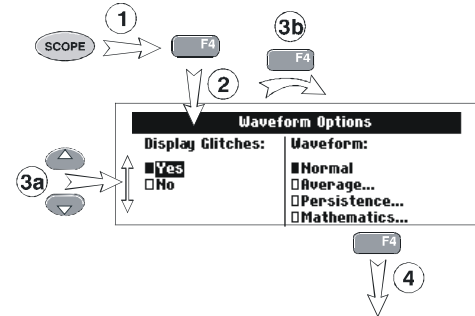





Figure 4. Basic Navigation

3a  Use the blue arrow keys to highlight the item.

3b  Press the blue **ENTER** key to accept the selection.

4  Press the **ENTER** key until you exit the menu.

Note

Repeatedly pressing  lets you to step through a menu without changing the settings.

Hiding Key Labels and Menus

You can hide a menu or key label at any time:



Hide any key label or menu.

To display menus or key labels, press one of the yellow menu keys, e.g. the **SCOPE** key.

Input Connections

Look at the top of the test tool. The test tool has four signal inputs: two safety BNC jack inputs (red input A and gray input B) and two safety 4-mm banana jack inputs (red and black). Use the two BNC jack inputs for scope measurements, and the two banana jack inputs for meter measurements.

Isolated input architecture allows independent floating measurements with each input.

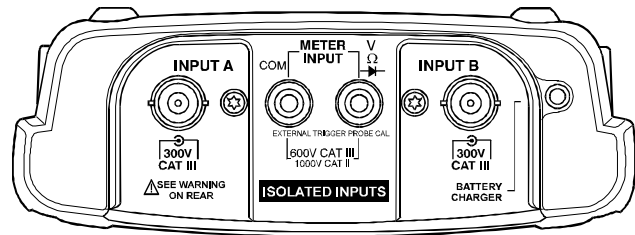

Figure 5. Measurement Connections

Making Scope Connections

To make dual input scope measurements, connect the red voltage probe to input A, and the gray voltage probe to input B. Connect the short ground leads of **each** voltage probe to its **own** reference potential. (See Figure 6.)

Note

To maximally benefit from having independently isolated floating inputs and to avoid problems caused by improper use, read Chapter 7: "Tips".

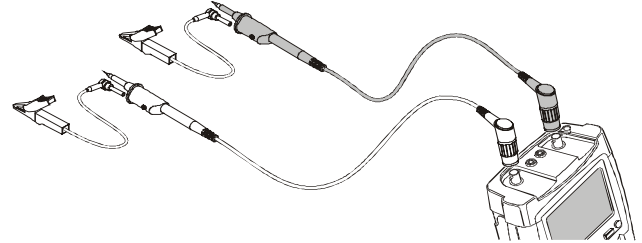



Figure 6. Scope Connections

Displaying an Unknown Signal with Connect-and-View™

The Connect-and-View feature lets the test tool display complex, unknown signals automatically. This function optimizes the position, range, time base, and triggering and assures a stable display of virtually any waveform. If the signal changes, the setup is automatically adjusted to maintain the best display result. This feature is especially useful for quickly checking several signals.

To enable the Connect-and-View feature, do the following:

- 1  Perform an Auto Set. **AUTO** appears at the top right of the screen.

The bottom line shows the range, the time base, and the trigger information.

The waveform identifier (**A**) is visible on the bottom right side of the screen, as shown in Figure 7. The input A zero icon () at the left side of the screen identifies the ground level of the waveform.

- 2  Press a second time to select the manual range again. **MANUAL** appears at the top right of the screen.

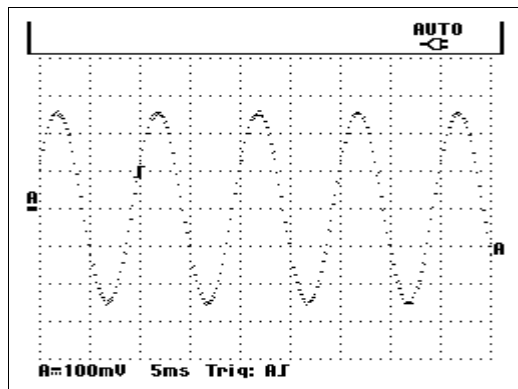



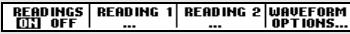

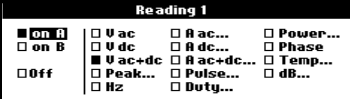

Figure 7. The Screen After an Auto Set

Use the light-gray **RANGE**, **TIME** and **MOVE** keys at the bottom of the keypad to change the view of the waveform manually.

Making Automatic Scope Measurements

The test tool offers a wide range of automatic scope measurements. You can display two numeric readings: **READING 1** and **READING 2**. These readings are selectable independently, and the measurements can be done on the input A or input B waveform

To choose a frequency measurement for input A, do the following:

- 1  Display the **SCOPE** key labels.

- 2  Open the **Reading 1** menu.

- 3  Select **on A**. Observe that the highlight jumps to the present measurement.
- 4  Select the Hz measurement.

Observe that the top left of the screen displays the Hz measurement. (See Figure 8.)

To choose also a **Peak-Peak** measurement for Input B as second reading, do the following:







- 1  Display the **SCOPE** key labels.

- 2  Open the **Reading 2** menu.

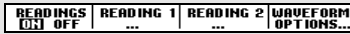
- 3  Select **on B**. The highlight jumps to the measurements field.
- 4  Open the **PEAK** menu.

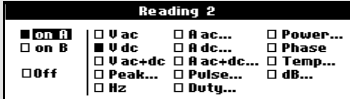
- 5  Select the **Peak-Peak** measurement.

Figure 8 shows an example of the screen. Note that the Peak-Peak reading for input B appears next to the input A frequency reading at the top of the screen.

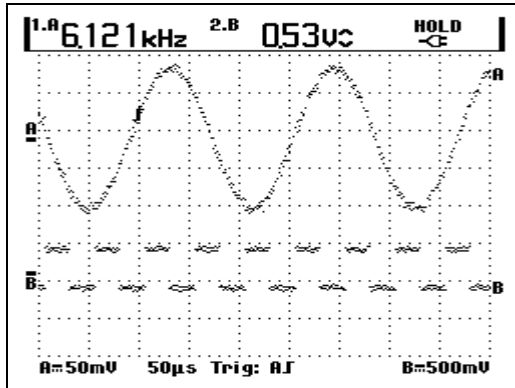



Figure 8. Hz and V peak-peak as Scope Readings

Freezing the Screen



You can freeze the screen (all readings and waveforms) at any time.



- | | | |
|---|---|---|
| 1 |  | Freeze the screen. HOLD appears at the right of the reading area. |
| 2 |  | Resume your measurement. |

Using Average, Persistence and Glitch Capture



Using Average for Smoothing Waveforms

To smooth the waveform, do the following:

- 1  Display the **SCOPE** key labels.
- 2  Open the **Waveform Options** menu.

Waveform Options	
Display Glitches:	Waveform:
<input checked="" type="checkbox"/> Yes	<input checked="" type="checkbox"/> Normal
<input type="checkbox"/> No	<input type="checkbox"/> Average...
	<input type="checkbox"/> Persistence...
	<input type="checkbox"/> Mathematics...
- 3  Jump to **Waveform:**
- 4  Select **Average...** to open the **Average** menu.

Average	
Average:	Factor:
<input type="checkbox"/> Off	<input type="checkbox"/> 2x
<input checked="" type="checkbox"/> Normal	<input type="checkbox"/> 4x
	<input checked="" type="checkbox"/> 8x
	<input type="checkbox"/> 64x

- 5  Select **Normal**, jump to **Factor:** and select **Average 8x**. This averages the outcomes of 8 acquisitions.
- 6  Exit the menu.

You can use the average functions to suppress random or uncorrelated noise in the waveform without loss of bandwidth. Waveform samples with and without smoothing are shown in Figure 9.

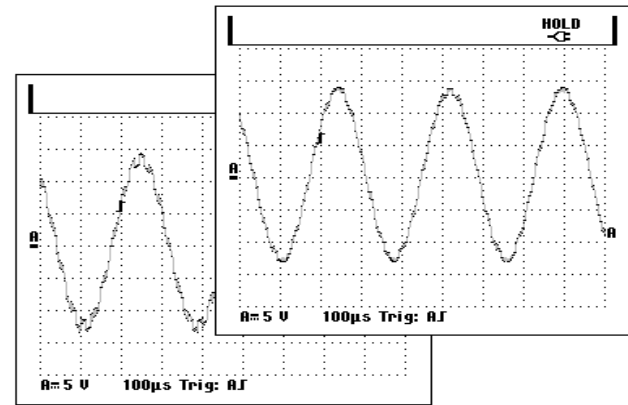





Figure 9. Smoothing a Waveform

Using Persistence to Display Waveforms

When persistence is selected, the test tool displays the upper and lower boundaries of dynamic waveforms.

-  Display the **SCOPE** key labels.
-  Open the **Waveform Options** menu.

Waveform Options	
Display Glitches:	Waveform:
<input checked="" type="checkbox"/> Yes	<input checked="" type="checkbox"/> Normal
<input type="checkbox"/> No	<input type="checkbox"/> Average...
	<input type="checkbox"/> Persistence...
	<input type="checkbox"/> Mathematics...
-  Jump to **Waveform:** and Select **Persistence**, then select **Infinite**.

Persistence	
Persistence:	
<input type="checkbox"/> Off	
<input type="checkbox"/> Short	
<input type="checkbox"/> Medium	
<input checked="" type="checkbox"/> Infinite	
-  Start monitoring the waveform.

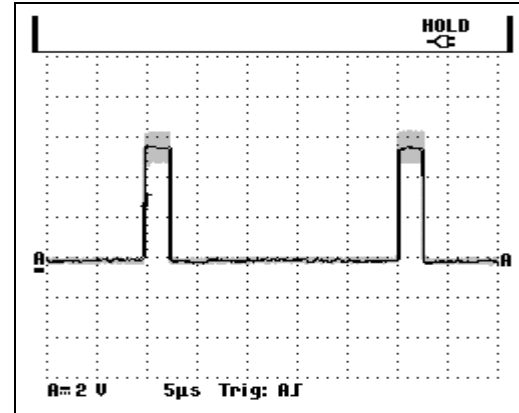



Figure 10. Using Persistence to Display Waveform Variations



Observe that the fluctuating portion of the waveform appears in gray on the screen. See Figure 10.

You can use persistence to observe variations in time or amplitude of input waveforms over time.

Displaying Glitches

To capture glitches on a waveform, do the following:



- 1  Display the **SCOPE** key labels.
- 2  Open the **Waveform Options** menu.

Waveform Options	
Display Glitches:	Waveform:
<input checked="" type="checkbox"/> Yes	<input checked="" type="checkbox"/> Normal
<input type="checkbox"/> No	<input type="checkbox"/> Average...
	<input type="checkbox"/> Persistence...
	<input type="checkbox"/> Mathematics...
- 3  Select **Display Glitches: Yes**
- 4  Exit the menu.

You can use this function to display events (glitches or other asynchronous waveforms) of 50 ns (nanoseconds) or wider, or you can display HF modulated waveforms.

Suppressing High Frequency Noise

Switching **Display Glitches** to **No** will suppress the high frequency noise on a waveform. Averaging will suppress the noise even more.

- 1  Display the **SCOPE** key labels.
- 2  Open the **Waveform Options** menu.

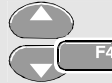
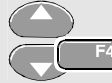
Waveform Options	
Display Glitches:	Waveform:
<input checked="" type="checkbox"/> Yes	<input checked="" type="checkbox"/> Normal
<input type="checkbox"/> No	<input type="checkbox"/> Average...
	<input type="checkbox"/> Persistence...
	<input type="checkbox"/> Mathematics...
- 3  Select **Display Glitches: No**, then select **Average:** to open the **Average** menu
- 4  Select **Average: Normal**, and **Factor : 8x**

Tip

Glitch capture and average do not affect bandwidth. Further noise suppression is possible with bandwidth limiting filters. See Chapter 1: "Working with Noisy Waveforms".

Acquiring Waveforms

Selecting AC-Coupling

After a reset, the test tool is dc-coupled so that ac and dc voltages appear on the screen.

Use ac-coupling when you wish to observe a small ac signal that rides on a dc signal. To select ac-coupling, do the following:

1		Display the INPUT A key labels.
2		Highlight AC.

Observe that the bottom left of the screen displays the ac-coupling icon: .

Reversing the Polarity of the Displayed Waveform

To invert the input A waveform, do the following:







1		Display the INPUT A key labels.
2		Open the Input A menu.
3		Select Inverted and accept inverted waveform display.
4		Exit the menu.

For example, a negative-going waveform is displayed as positive-going waveform which may provide a more meaningful view. An inverted display is identified by an inverted trace identifier () at the right of the waveform.

Working with Noisy Waveforms

To suppress high frequency noise on waveforms, you can limit the working bandwidth to 10 kHz or 20 MHz. This function smoothes the displayed waveform. For the same reason, it improves triggering on the waveform.

To choose HF reject, do the following:

1		Display the INPUT A key labels.												
<table border="1"> <tr> <td>INPUT A</td> <td>COUPLING</td> <td>PROBE A</td> <td>INPUT A</td> </tr> <tr> <td><input checked="" type="checkbox"/> ON</td> <td><input checked="" type="checkbox"/> OFF</td> <td><input checked="" type="checkbox"/> AC</td> <td><input checked="" type="checkbox"/> 10:1...</td> </tr> <tr> <td colspan="4" style="text-align: right;">OPTIONS...</td> </tr> </table>			INPUT A	COUPLING	PROBE A	INPUT A	<input checked="" type="checkbox"/> ON	<input checked="" type="checkbox"/> OFF	<input checked="" type="checkbox"/> AC	<input checked="" type="checkbox"/> 10:1...	OPTIONS...			
INPUT A	COUPLING	PROBE A	INPUT A											
<input checked="" type="checkbox"/> ON	<input checked="" type="checkbox"/> OFF	<input checked="" type="checkbox"/> AC	<input checked="" type="checkbox"/> 10:1...											
OPTIONS...														
2		Open the Input A menu.												
<table border="1"> <tr> <th colspan="2">Input A</th> </tr> <tr> <td>Polarity:</td> <td>Bandwidth:</td> </tr> <tr> <td><input checked="" type="checkbox"/> Normal</td> <td><input checked="" type="checkbox"/> Full</td> </tr> <tr> <td><input type="checkbox"/> Inverted</td> <td><input type="checkbox"/> 10kHz (HF reject)</td> </tr> <tr> <td></td> <td><input type="checkbox"/> 20MHz</td> </tr> </table>			Input A		Polarity:	Bandwidth:	<input checked="" type="checkbox"/> Normal	<input checked="" type="checkbox"/> Full	<input type="checkbox"/> Inverted	<input type="checkbox"/> 10kHz (HF reject)		<input type="checkbox"/> 20MHz		
Input A														
Polarity:	Bandwidth:													
<input checked="" type="checkbox"/> Normal	<input checked="" type="checkbox"/> Full													
<input type="checkbox"/> Inverted	<input type="checkbox"/> 10kHz (HF reject)													
	<input type="checkbox"/> 20MHz													
3		Jump to Bandwidth .												
4	  	Select 10kHz (HF reject) to accept the bandwidth limitation.												

Tip

To suppress noise without loss of bandwidth, use the average function or turn off **Display Glitches**.



Using Waveform Mathematics Functions

When adding (A+B), subtracting (A-B), or multiplying (A*B) the input A and input B waveform, the test tool will display the mathematical result waveform and the input A and input B waveforms.

A versus B provides a plot with input A on the vertical axis and input B on the horizontal axis.

The Mathematics functions perform a point-to-point operation on waveforms A and B.

To use a Mathematics function, do the following:

1		Display the SCOPE key labels.												
2		Open the Waveform Options menu.												
<table border="1"> <tr> <th colspan="2">Waveform Options</th> </tr> <tr> <td>Display Glitches:</td> <td>Waveform:</td> </tr> <tr> <td><input checked="" type="checkbox"/> Yes</td> <td><input checked="" type="checkbox"/> Normal</td> </tr> <tr> <td><input type="checkbox"/> No</td> <td><input type="checkbox"/> Average...</td> </tr> <tr> <td></td> <td><input type="checkbox"/> Persistence...</td> </tr> <tr> <td></td> <td><input type="checkbox"/> Mathematics...</td> </tr> </table>			Waveform Options		Display Glitches:	Waveform:	<input checked="" type="checkbox"/> Yes	<input checked="" type="checkbox"/> Normal	<input type="checkbox"/> No	<input type="checkbox"/> Average...		<input type="checkbox"/> Persistence...		<input type="checkbox"/> Mathematics...
Waveform Options														
Display Glitches:	Waveform:													
<input checked="" type="checkbox"/> Yes	<input checked="" type="checkbox"/> Normal													
<input type="checkbox"/> No	<input type="checkbox"/> Average...													
	<input type="checkbox"/> Persistence...													
	<input type="checkbox"/> Mathematics...													

3



Jump to **Waveform:** and Select **Mathematics...** to open the **Mathematics** menu.

Mathematics			
Function:		Scalefactor:	
<input type="checkbox"/> Off	<input type="checkbox"/> A vs B	<input type="checkbox"/> 1	<input type="checkbox"/> /16
<input checked="" type="checkbox"/> A + B		<input checked="" type="checkbox"/> /2	
<input type="checkbox"/> A - B		<input type="checkbox"/> /4	
<input type="checkbox"/> A * B		<input type="checkbox"/> /8	

4



Select Function: **A+B**, **A-B**, **A*B** or **A vs B**.

5



Select a scale factor to fit the mathematical result waveform onto the display, and return.

Analyzing Waveforms

You can use the analysis functions **CURSOR**, **ZOOM** and **REPLAY** to perform detailed waveform analysis. These functions are described in Chapter 4: “Using Cursors, Zoom and Replay”.

The sensitivity range of the mathematical result is equal to the sensitivity range of the least sensitive input divided by the scale factor.

Chapter 2

Using The Multimeter

About this Chapter

This chapter provides a step-by-step introduction to the multimeter functions of the test tool (hereafter called “meter”). The introduction gives basic examples to show how to use the menus and perform basic operations.

Making Meter Connections

Use the two 4-mm safety red ($\text{V}\Omega\text{--}$) and black (COM) banana jack inputs for the Meter functions. (See Figure 11.)

Note

Typical use of the Meter test leads and accessories is shown in Chapter 7.

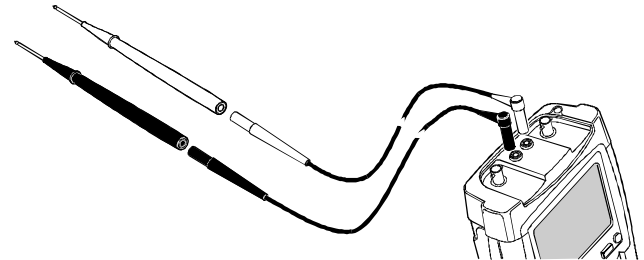





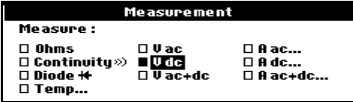

Figure 11. Meter Connections

Making Multimeter Measurements

The screen displays the numeric readings of the measurements on the meter input.

Measuring Resistance Values

To measure a resistance, do the following:

- 1 Connect the red and black test leads from the 4-mm banana jack inputs to the resistor.
- 2  Display the **METER** key labels.

- 3  Open the **Measurement** menu.

- 4  Highlight **Ohms**.
- 5  Select Ohms measurement.

The resistor value is displayed in ohms. Observe also that the bargraph is displayed. (See Figure 12.)

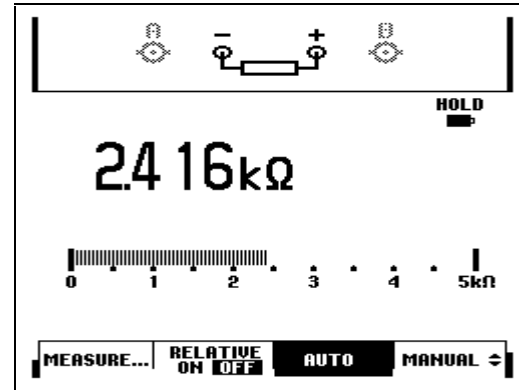

Figure 12. Resistor Value Readings

Making a Current Measurement

You can measure current in both Scope mode and Meter mode. Scope mode has the advantage of two waveforms being displayed while you perform measurements. Meter mode has the advantage of high measurement resolution.

The next example explains a typical current measurement in Meter mode.

Warning

Carefully read the instructions about the current probe you are using.

To set up the test tool, do the following:

- 1 Connect a current probe (e.g. i400, optional) from the 4-mm banana jack outputs to the conductor to be measured.

Ensure that the red and black probe connectors correspond to the red and black banana jack inputs. (See Figure 13.)
- 2  Display the METER key labels.



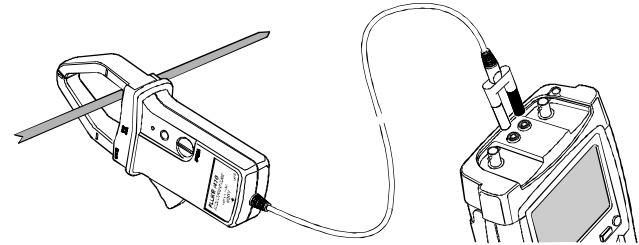

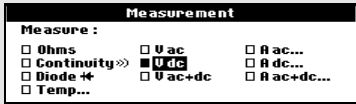

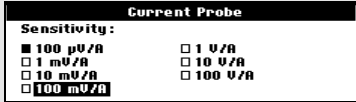

Figure 13. Measurement Setup



- 3  Open the **Measurement** menu.



Measurement		
Measure :		
<input type="checkbox"/> Ohms	<input type="checkbox"/> V ac	<input type="checkbox"/> A ac...
<input type="checkbox"/> Continuity >>	<input checked="" type="checkbox"/> V dc	<input type="checkbox"/> A dc...
<input type="checkbox"/> Diode <<	<input type="checkbox"/> V ac+dc	<input type="checkbox"/> A ac+dc...
<input type="checkbox"/> Temp...		
- 4  Highlight **A ac....**
- 5  Open the **Current Probe** submenu.



Current Probe	
Sensitivity:	
<input checked="" type="checkbox"/> 100 µV/A	<input type="checkbox"/> 1 V/A
<input type="checkbox"/> 1 mV/A	<input type="checkbox"/> 10 V/A
<input type="checkbox"/> 10 mV/A	<input type="checkbox"/> 100 V/A
<input checked="" type="checkbox"/> 100 mV/A	

- 6  Observe the sensitivity of the current probe. Highlight the corresponding sensitivity in the menu, e.g. **10 mV/A**.
- 7  Accept the current measurement.

Now, you will see a screen like in Figure 14.

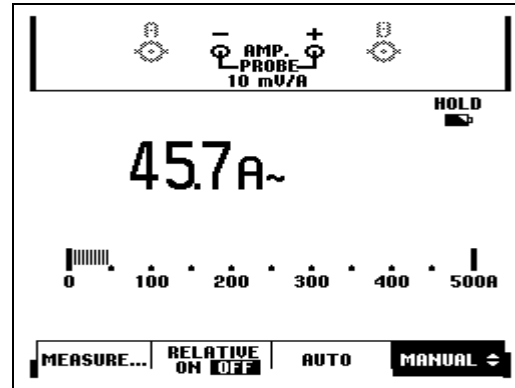



Figure 14. Ampere Measurement Readings

Freezing the Readings

You can freeze the displayed readings at any time.

1		Freeze the screen. HOLD appears at the top right of the reading area.
2		Resume your measurement.



You can use this function to hold accurate readings for later examination.

Note

For saving screens into memory, see Chapter 6.

Selecting Auto/Manual Ranges

To activate manual ranging, do the following during any Meter measurement:

1		Activate manual ranging.
2		Increase or decrease the range.

Observe how the bargraph sensitivity changes.

Use manual ranging to set a fixed bargraph sensitivity and decimal point.



3		Choose auto ranging again.
---	--	----------------------------

When in auto ranging, the bargraph sensitivity and decimal point are automatically adjusted while checking different signals.

Making Relative Measurements

A relative measurement displays the present measurement result relative to a defined reference value.

The following example shows how to perform a relative voltage measurement. First obtain a reference value:

1		Display the METER key labels.
		
2		Measure a voltage to be used as reference value.
3		Set RELATIVE to ON. (ON is highlighted.)

This stores the reference value as reference for subsequent measurements. The stored reference value is displayed in small digits at the bottom right side of the screen after the word REFERENCE.

4		Measure the voltage to be compared to the reference.
---	--	--

Observe that the main reading is displayed as variations from the reference value. The actual reading with its bargraph is displayed beneath these readings. (See Figure 15.)

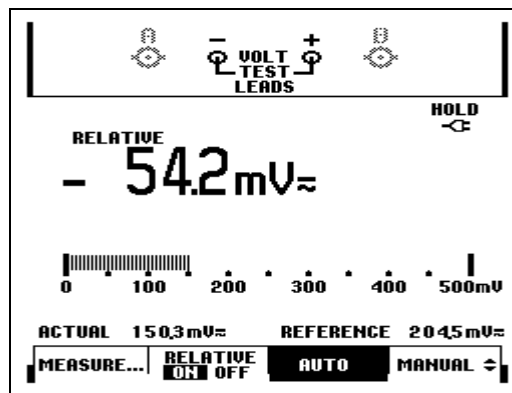

Figure 15. Making a Relative Measurement

You can use this feature when, for example, you need to monitor input activity (voltage, resistance, temperature) in relation to a known good value.

Chapter 3

Using The Recorder Functions

About this Chapter

This chapter provides a step-by-step introduction to the recorder functions of the test tool. The introduction gives examples to show how to use the menus and perform basic operations.

Opening the Recorder Main Menu

First choose a measurement in scope or meter mode. Now you can choose the recorder functions from the recorder main menu. To open the main menu, do the following:

1



Open the RECORDER main menu.
(See Figure 16.)

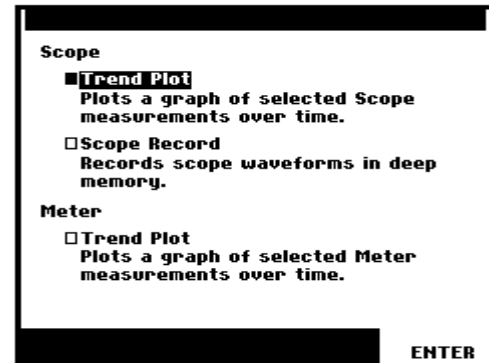

Figure 16. Recorder Main Menu

Plotting Measurements Over Time (TrendPlot™)



Use the TrendPlot function to plot a graph of Scope or Meter measurements as function of time.

Note

Because the navigations for the dual input TrendPlot (Scope) and the single input TrendPlot (Meter) are identical, only TrendPlot (Scope) is explained in the next sections.

Starting a TrendPlot Function

To start plotting a graph of the reading over time, do the following:

- 1 Apply a signal to the red BNC input A and turn on **Reading 1** in scope mode
- 2  Open the **RECORDER** main menu.
- 3  Highlight **Trend Plot (Scope)**.
- 4  Start the TrendPlot recording.

The test tool continuously records the digital readings of the input A measurements and displays these as a graph. The TrendPlot graph rolls from right to left like a paper chart recorder.

Observe that the recorded time from start appears at the bottom of the screen. The present reading appears on top of the screen. (See Figure 17.)

Note

When simultaneously TrendPlotting two readings, the screen area is split into two sections of four divisions each.

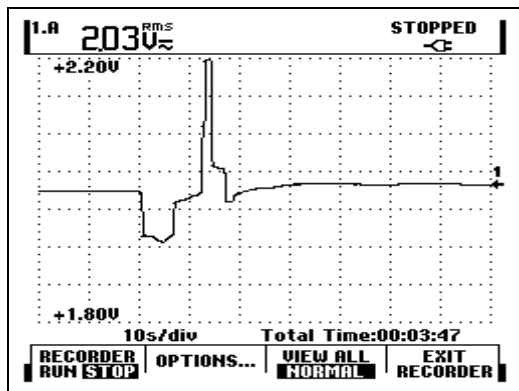

Figure 17. TrendPlot Reading

When the Scope is in automatic mode, automatic vertical scaling is used to fit the TrendPlot graph on the screen.

- 5 Set RECORDER to STOP to freeze the recorder function.
- 6 Set RECORDER to RUN to continue.

Displaying Recorded Data

When in normal view (**NORMAL**), only the nine most recently recorded divisions are displayed on screen. All previous recordings are stored in memory.

VIEW ALL shows **all** data in memory:

- 7 Display an overview of the full waveform.

Press repeatedly to toggle between normal view (**NORMAL**) and overview (**VIEW ALL**)

When the recorder memory is full, an automatic compression algorithm is used to compress all samples into half of the memory without loss of transients. The other half of the recorder memory is free again to continue recording.



Changing the Recorder Options

At the right bottom of the display you can choose to display the time elapsed from start and the actual time of the day.

To change the time reference, proceed from step 6 as follows:

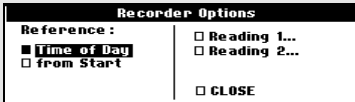
7  Open the **Recorder Options** menu.



8    Select **Time of Day** and jump to the next field.

Now the recorded time and the current time appear at the bottom of the screen.

The options **Reading 1** and **Reading 2** allow you to select the scope readings to be recorded. (Or one meter measurement when in TrendPlot meter mode.)

To continue without making further changes:

9  Close.



Turning Off the TrendPlot Display

10  Exit the recorder function.

Recording Scope Waveforms In Deep Memory (Scope Record™)

The SCOPE RECORD function is a roll mode that logs one or two long waveforms. This function can be used to monitor waveforms like motion control signals or the power-on event of an Uninterruptable Power Supply (UPS). During recording, fast transients are captured. Because of the deep memory, recording can be done for more than one day. This function is similar to the roll mode in many DSO's but has deeper memory and better functionality.

Starting a Scope Record Function

- 1 Apply a signal to the red BNC input A.
- 2  From the Recorder main menu, highlight **Scope Record**.
- 3  Start the recording.

The waveform moves across the screen from right to left like a normal chart recorder. (See Figure 18.)

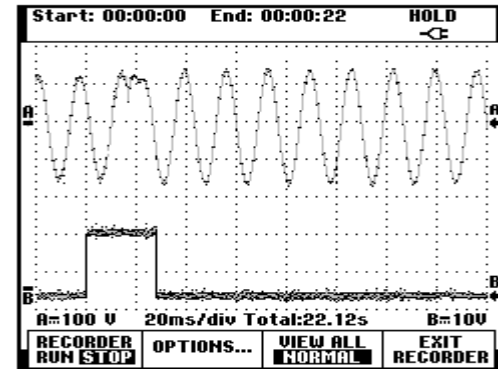

Figure 18. Recording Waveforms

Observe that the top of the screen displays the following:

- Time from start at the top of the screen.
- The status at the bottom of the screen which includes the time/div setting as well as the total timespan that fits the memory.

Note

For accurate recordings it is advised to let the instrument first warm up for five minutes.

Displaying Recorded Data

In Normal view, the samples that roll off the screen are stored in deep memory. When the memory is full, recording continues by shifting the data in memory and deleting the first samples out of memory.

In View All mode, the complete memory contents are displayed on the screen.

- 4  Press to toggle between **VIEW ALL** (overview of all recorded samples) and **NORMAL** view.

You can analyze the recorded waveforms using the Cursors and Zoom functions. See Chapter 4: “Using Replay, Zoom and Cursors”.

Using ScopeRecord in Single Sweep Mode



Use the recorder **Single Sweep** function to automatically stop recording when the deep memory is full.

Continue from step 3 of the previous section:

- 4  Open the **Recorder options** menu.



- 5  (2x) Jump to the **Mode** field.

- 6   Select **Single Sweep** and accept the recorder options.

Using Scope Record in Triggered Single Sweep Mode

To record, for example, the power-on event of an Uninterruptable Power Supply (UPS) it might be useful to start recording on an external trigger signal. The next example explains a typical triggered Single Sweep recording.

To set up the test tool, continue from step 3 of the previous section:

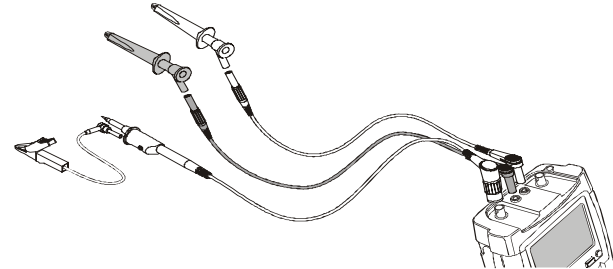







Figure 19. Scope Record Single Sweep

- 4 Apply an Uninterruptable Power Supply signal to the red BNC input A. Apply a start signal to the red and black external trigger banana inputs. (See Figure 19.)
- 5  Open the **Recorder Options** menu.

Recorder Options		
Reference :	Display Glitches :	Mode :
<input checked="" type="checkbox"/> Time of Day	<input checked="" type="checkbox"/> Yes	<input checked="" type="checkbox"/> Single Sweep
<input type="checkbox"/> from Start	<input type="checkbox"/> 10 kHz	<input type="checkbox"/> Continuous
		<input type="checkbox"/> on Ext....
- 6  Jump to **Display Glitches**.
- 7  Select **Yes**, then jump to **Mode**.

- 8  Select **on EXT** to open the **Start Single Sweep on Ext.** menu.

Start Single Sweep on Ext.	
Slope :	Level :
<input checked="" type="checkbox"/> ↑	<input checked="" type="checkbox"/> 0.12 V
<input type="checkbox"/> ↓	<input type="checkbox"/> 1.2 V
- 9  Select positive slope and jump to **Level**.
- 10  Select **1.2 V** and accept all recorder options.

The test tool starts recording after receiving the start signal. All samples are continuously saved in deep memory until the memory is full. The last nine recorded divisions are displayed on the screen. Use View All to display the full memory contents.

Note

To learn more about the Single Shot trigger function, see Chapter 5 “Triggering on Waveforms”.

Analyzing a TrendPlot or Scope Record

From a Scope TrendPlot or Scope Record you can use the analysis functions CURSORS and ZOOM to perform detailed waveform analysis. These functions are described in Chapter 4: “Using Replay, Zoom and Cursors”.

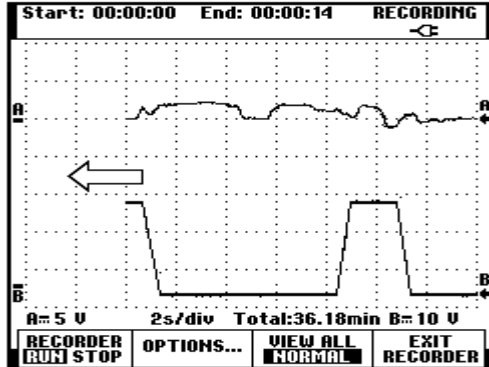

Figure 20. Triggered Single Sweep Recording

Chapter 4

Using Replay, Zoom and Cursors

About this Chapter

This chapter covers the capabilities of the analysis functions **Cursor**, **Zoom**, and **Replay**. These functions can be used with one or more of the primary functions Scope, TrendPlot or Scope Record.

It is possible to combine two or three analysis functions. A typical application using these functions follows:



- First **replay** the last screens to find the screen of special interest.
- Then **zoom** in on the signal event.
- Finally, make measurements using the **cursors**.

Replaying the 100 Most Recent Scope Screens

When you are in scope mode, the test tool automatically stores the 100 most recent screens. When you press the **HOLD** key or the **REPLAY** key, the memory contents are frozen. Use the functions in the **REPLAY** menu to “go back in time” by stepping through the stored screens to find the screen of your interest. This feature lets you capture and view signals even if you did not press **HOLD**.

Replaying Step-by-Step

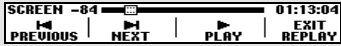
To step through the last scope screens, do the following:

-  From scope mode, open the REPLAY menu.

Observe that the trace is frozen and that REPLAY appears at the top of the screen (see Figure 21).
-  Step through the previous screens.
-  Step through the next screens.

Observe that the bottom of the waveform area displays the replay bar with a screen number and related time stamp:

SCREEN -84  01:13:04

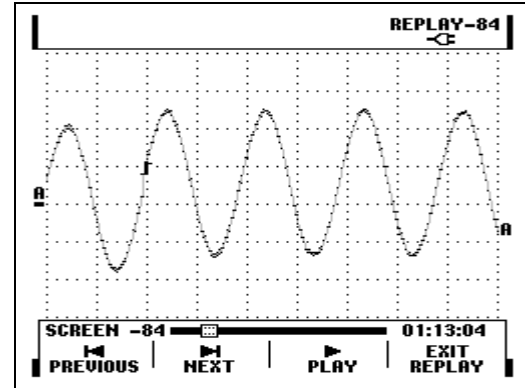



Figure 21. Replaying a Waveform



The replay bar represents all 100 stored screens in memory. The  icon represents the picture being displayed on the screen (in this example: SCREEN -84). If the bar is partly white, the memory is not completely filled with 100 screens.

From this point you can use the zoom and cursor functions to study the signal in more detail.

Replaying Continuously

You can also replay the stored screens continuously, like playing a video tape.

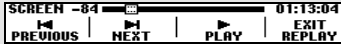
To replay continuously, do the following:

-  From Scope mode, open the **REPLAY** menu.

Observe that the trace is frozen and **REPLAY** appears at the top of the screen.
-  Continuously replay the stored screens in ascending order.

Wait until the screen with the signal event of interest appears.

-  Stop the continuous replay.

Turning Off the Replay Function

-  Turn off **REPLAY**.

Capturing 100 Intermittents Automatically

When you use the test tool in triggered mode, 100 *triggered* screens are captured. This way you could use Pulse Triggering to trigger and capture 100 intermittent glitches or you could use External Triggering to capture 100 UPS startups.





By combining the trigger possibilities with the capability of capturing 100 screens for later replay, you can leave the test tool unattended to capture intermittent signal anomalies.

For triggering, see Chapter 5: “*Triggering on Waveforms*”.

Zooming in on a Waveform

To obtain a more detailed view of a waveform, you can zoom in on a waveform using the **ZOOM** function.

To zoom in on a waveform, do the following:

-  Display the **ZOOM** key labels.

Observe that the trace is frozen, **HOLD** appears at the top of the screen, and the waveform is magnified.
-  Enlarge (decrease the time/div) or shrink (increase the time/div) the waveform.
-  Scroll. A position bar displays the position of the zoomed part in relation to the total waveform.

Tip

Even when the key labels are not displayed at the bottom of the screen, you can still use the arrow keys to zoom in and out.

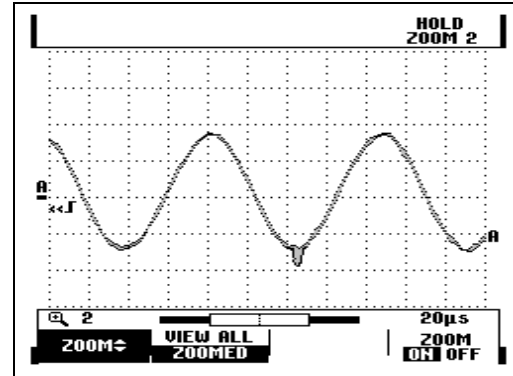



Figure 22. Zooming in a Waveform

Observe that the bottom of the waveform area displays the zoom ratio, position bar, and time/div (see Figure 22). The zoom range depends on the amount of data samples stored in memory.

From this point you can use the cursor function for further measurements on the waveform.

Displaying the Zoomed Waveform

The **VIEW ALL** feature is useful when you quickly need to see the complete waveform and then return to the zoomed part.

4  Display the complete waveform.

Press  repeatedly to toggle between the zoomed part of the waveform and the complete waveform.

Turning Off the Zoom Function









5  Turn off the **zoom** function.

Making Cursor Measurements

Cursors allow you to make precise digital measurements on waveforms. This can be done on live waveforms, recorded waveforms, and on saved waveforms.

Using Horizontal Cursors on a Waveform

To use the cursors for a voltage measurement, do the following:

-  From scope mode, display the cursor key labels.

-  Press to highlight . Observe that two **horizontal** cursors are displayed.
-  Highlight the upper cursor.
-  Move the upper cursor to the desired position on the screen.
-  Highlight the lower cursor.
-  Move the lower cursor to the desired position on the screen.

Note

Even when the key labels are not displayed at the bottom of the screen, you still can use the arrow keys. This allows full control of both cursors while having full screen view.

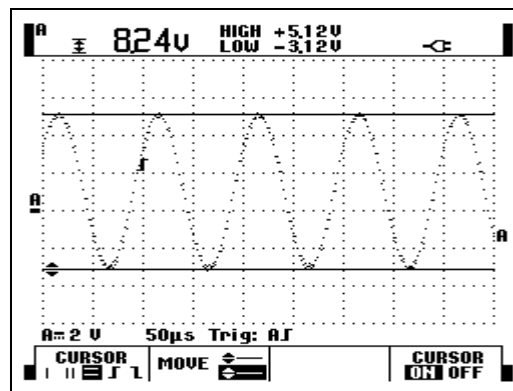



Figure 23. Voltage Measurement with Cursors



The screen shows the voltage difference between the two cursors and the voltage at the cursors. (See Figure 23.)





Use horizontal cursors to measure the amplitude, high or low value, or overshoot of a waveform.

Using Vertical Cursors on a Waveform

To use the cursors for a time measurement, do the following:

- 1  From scope mode, display the cursor key labels.

CURSOR
MOVE
TRACE
CURSOR
- 2  Press to highlight . Observe that two **vertical** cursors are displayed. Markers (–) identify the point where the cursors cross the waveform.

CURSOR
MOVE
TRACE
CURSOR
- 3  If necessary, choose the trace: TRACE A , B , or M (Mathematics).
- 4  Highlight the left cursor.
- 5  Move the left cursor to the desired position on the waveform.
- 6  Highlight the right cursor.

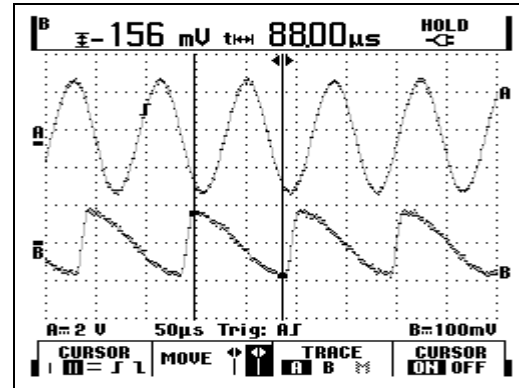



Figure 24. Time Measurement with Cursors

- 7  Move the right cursor to the desired position on the waveform.
- 8  Turn off the cursors.

The screen shows the time difference between the cursors and the voltage difference between the two markers. (See Figure 24.)





Using Cursors on a A+B, A-B or A*B Waveform



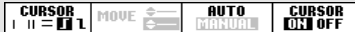

Cursor measurements on a A*B waveform give a reading in Watts if input A measures (milli)Volts and input B measures (milli)Amperes.

For other cursor measurements on a A+B, A-B or A*B waveform no reading will be available if the input A and input B measurement unit are different.

Making Rise Time Measurements

To measure rise time, do the following:

- 1  From scope mode, display the cursor key labels.

- 2  Press to highlight  (rise time). Observe that two **horizontal** cursors are displayed.
- 3  If only one trace is displayed, select MANUAL or AUTO (this automatically does steps 4 to 6). For multiple traces select the required trace A, B, or M (if a math function is active).

- 4   Move the upper cursor to 100% of the trace height. A marker is shown at 90%.
- 5  Highlight the other cursor.
- 6   Move the lower cursor to 0% of the trace height. A marker is shown at 10%.

The reading shows the risetime from 10%-90% of the trace amplitude.

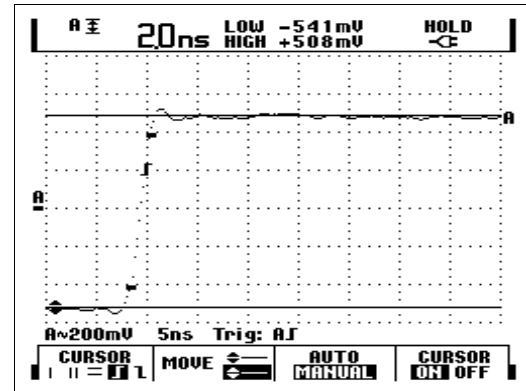

Figure 25. Rise Time Measurement

Chapter 5

Triggering on Waveforms

About this Chapter

This chapter provides an introduction to the trigger functions of the test tool. Triggering tells the test tool when to begin displaying the waveform. You can use fully automatic triggering, take control of one or more main trigger functions (semi-automatic triggering), or you can use dedicated trigger functions to capture special waveforms.

Following are some typical trigger applications:

- Use the Connect-and-View™ function to have full automatic triggering and instant display of virtually any waveform.
- If the signal is unstable or has a very low frequency, you can control the trigger level, slope, and trigger delay for a better view of the signal. (See next section.)
- For dedicated applications, use one of the four manual trigger functions:
 - Edge triggering
 - External triggering
 - Video triggering
 - Pulse Width triggering

Setting Trigger Level and Slope

The Connect-and-View™ function enables hands-off triggering to display complex unknown signals.

When your test tool is in manual range, do the following:



Perform an auto set. **AUTO** appears at the top right of the screen.

Automatic triggering assures a stable display of virtually any signal.

From this point, you can take over the basic trigger controls such as level, slope and delay. To optimize trigger level and slope manually, do the following:

- 1 **TRIGGER** Display the **TRIGGER** key labels.



- 2 **F2** Trigger on either positive slope or negative slope of the chosen waveform.

- 3 **F3** Enable the arrow keys for manual trigger level adjustment.

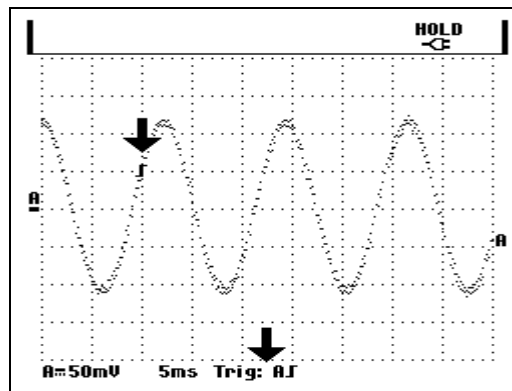

Figure 26. Screen with all Trigger Information

- 4 Adjust the trigger level.

Observe the trigger icon that indicates the trigger position, trigger level, and slope.

At the bottom of the screen the trigger parameters are displayed. (See Figure 26.) For example, **Trig: AJ** means that input A is used as the trigger source with a positive slope.



When no trigger is found, the trigger parameters appear in gray.

Using Trigger Delay or Pre-trigger

You can begin to display the waveform some time before or after the trigger point has been detected. Initially, you have 2 divisions of pre-trigger view (negative delay).

To set the trigger delay, do the following:

5  Hold down to adjust the trigger delay.

Observe that the trigger icon  on the screen moves to show the new trigger position. When the trigger position moves left off of the screen, the trigger icon changes into  to indicate that you have selected a trigger delay. Moving the trigger icon to the right on the display gives you a pre-trigger view.

In case of a trigger delay, the status at the bottom of the screen will change. For example:

AJ **+500.0ms**

This means that input A is used as the trigger source with a positive slope. The 500.0 ms indicates the (positive) delay between trigger point and waveform display.

When no trigger is found, the trigger parameters appear in gray.

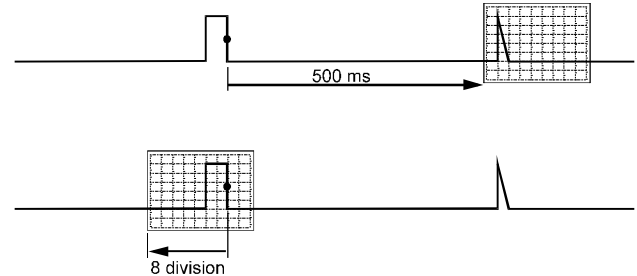

Figure 27. Trigger Delay or Pre-trigger View

Figure 27 shows an example of a trigger delay of 500 ms (top) and an example of pre-trigger view of 8 divisions (bottom).

Automatic Trigger Options

In the trigger menu, settings for automatic triggering can be changed as follows. (See also Chapter 1: “Displaying an Unknown Signal with Connect-and-View”)

- 1  Display the TRIGGER key labels.



Note

The **TRIGGER** key labels can differ depending on the latest trigger function used.

- 2  Open the Trigger Options menu.

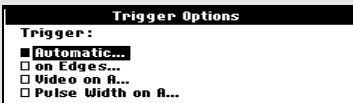

- 3  Open the Automatic Trigger menu.







If the frequency range of the automatic triggering is set to > 15 Hz, the Connect-and-View™ function responds more quickly. The response is quicker because the test tool is instructed not to analyze low frequency signal components. However, when you measure frequencies lower than 15 Hz, the test tool must be instructed to analyze low frequency components for automatic triggering:

- 4  Select > 1 Hz and return to the measurement screen.

Triggering on Edges

If the signal is instable or has a very low frequency, use edge triggering to obtain full manual trigger control.

To trigger on rising edges of the input A waveform, do the following:

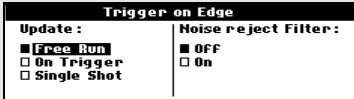

1		Display the TRIGGER key labels.
		
2		Open the Trigger Options menu.
		
3		Open the Trigger on Edge menu.
		

When **Free Run** is selected, the test tool updates the screen even if there are no triggers. A trace always appears on the screen.

When **On Trigger** is selected, the test tool needs a trigger to display a waveform. Use this mode if you want to update the screen *only* when valid triggers occur.

When **Single Shot** is selected, the test tool waits for a trigger. After receiving a trigger, the waveform is displayed and the instruments is set to HOLD.

In most cases it is advised to use the Free Run mode:



4		Select Free Run , jump to Noise reject Filter .
5		Set Noise reject Filter to Off .

Observe that the key labels at the bottom of the screen have adapted to allow further selection of specific edge trigger settings:



Triggering on Noisy Waveforms



To reduce jitter on the screen when triggering on noisy waveforms, you can use a noise rejection filter. Continue from step 3 of the previous example as follows:

- | | | |
|---|---|---|
| 4 |  | Select On Trigger , jump to Noise reject Filter . |
| 5 |  | Set Noise reject Filter to On . |

Observe that the trigger gap has increased. This is indicated by a taller trigger icon .

Making a Single Acquisition

To catch single events, you can perform a **single shot** acquisition (one-time screen update). To set up the test tool for a single shot of the input A waveform, continue from step 3 again:

- | | | |
|---|--|-----------------------------|
| 4 |  | Select Single Shot . |
| 5 |  | Accept the settings. |

The word **WAITING** appears at the top of the screen indicating that the test tool is waiting for a trigger. As soon as the test tool receives a trigger, the waveform is displayed and the instrument is set to hold. This is indicated by the word **HOLD** at top of the screen.

The test tool will now have a screen like Figure 28.

6

HOLD
RUN

Arm the test tool for a new single shot.

Tip

The test tool stores all single shots in the replay memory. Use the Replay function to look at all the stored single shots.

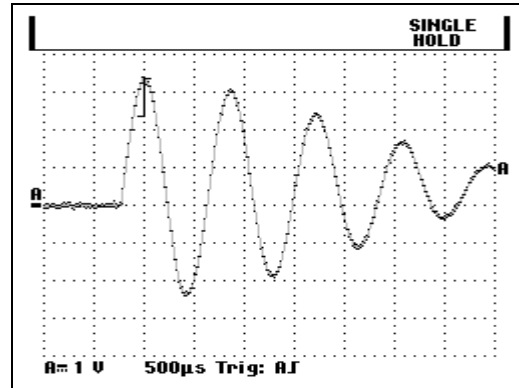



Figure 28. Making a Single Shot Measurement

Triggering on External Waveforms

Use external triggering when you want to display waveforms on inputs A and B while triggering on a third signal. You can choose external triggering with automatic triggering or with edge triggering.

- 1 Supply a signal to the red **and** black 4-mm banana jack inputs. See Figure 29.

In this example you continue from the Trigger on Edges example. To choose the external signal as trigger source, continue as follows:

- 2  Display the **TRIGGER (On Edges)** key labels.

AUTO TRIG	SLOPE	AUTO LEVEL	TRIGGER
[] B Ext	Ed L	MANUAL	OPTIONS...

- 3  Select **Ext** (external) edge trigger.

Observe that the key labels at the bottom of the screen have been adapted to allow selection of two different external trigger levels: 0.12 V and 1.2 V:

EDGE TRIG	SLOPE	Ext LEVEL	TRIGGER
A B [Ext]	Ed L	0.12V [Ext]	OPTIONS...

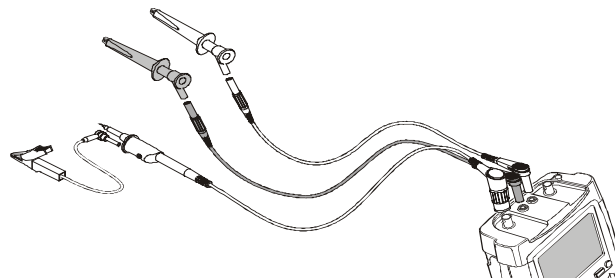



Figure 29. External Triggering

- 4  Select **1.2V** under the **Ext LEVEL** label.

From this point the trigger level is fixed and is compatible with logic signals.

Triggering on Video Signals

To trigger on a video signal, first select the standard of the video signal you are going to measure:

- 1 Apply a video signal to the red input A.
- 2  Display the **TRIGGER** key labels.

AUTO TRIG	SLOPE	AUTO LEVEL	TRIGGER
<input type="checkbox"/> B Ext	<input checked="" type="checkbox"/> L	MANUAL	OPTIONS...
- 3  Open the **Trigger Options** menu.

Trigger Options	
Trigger :	
<input checked="" type="checkbox"/> Automatic...	
<input type="checkbox"/> on Edges...	
<input type="checkbox"/> Video on A...	
<input type="checkbox"/> Pulse Width on A...	
- 4  Select **Video on A** to open the **Trigger on Video** menu.

Trigger on Video	
Polarity :	
<input checked="" type="checkbox"/> Positive	<input checked="" type="checkbox"/> PAL
<input type="checkbox"/> Negative	<input type="checkbox"/> NTSC
	<input type="checkbox"/> PALPlus
	<input type="checkbox"/> SECAM
- 5  Select positive signal polarity for video signals with negative going sync pulses.

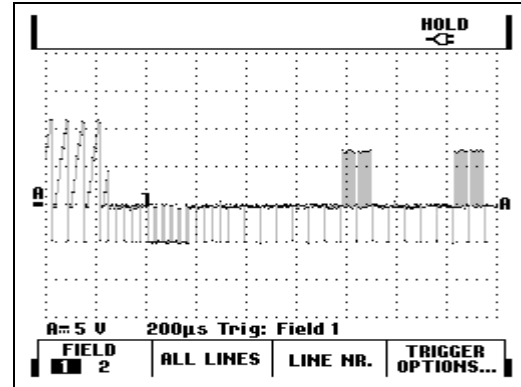



Figure 30. Measuring Interlaced Video Signals

- 6  Select the video standard and return.

Trigger level and slope are now fixed.

Observe that the key labels at the bottom of the screen have been changed to allow further selection of specific video trigger settings:



Triggering on Video Frames

Use **FIELD 1** or **FIELD 2** to trigger either on the first half of the frame (odd) or on the second half of the frame (even).

To trigger on the second half of the frame, do the following:

7  Choose **FIELD 2**.

The signal part of the even field is displayed on the screen.

Triggering on Video Lines



Use **ALL LINES** to trigger on all line synchronization pulses (horizontal synchronization).

7  Choose **ALL LINES**.

The signal of one line is displayed on the screen. The screen is updated with the signal of the next line immediately after the test tool triggers on the horizontal synchronization pulse.

To view a specific video line in more detail, you can select the line number. For example, to measure on video line 123, continue from step 5 as follows:

7  Enable video line selection.

8   Select number 123.

The signal of line 123 is displayed on the screen. Observe that the status line now also shows the selected line number. The screen is continuously updated with the signal of line 123.

Triggering on Pulses

Use pulse width triggering to isolate and display specific pulses that you can qualify by time, such as glitches, missing pulses, bursts or signal dropouts.

Detecting Narrow Pulses



To set the test tool to trigger on narrow positive pulses shorter than 5 ms, do the following:

- 1 Apply a video signal to the red input A.
- 2  Display the **TRIGGER** key labels.

AUTO TRIG	SLOPE	AUTO LEVEL	TRIGGER
<input type="checkbox"/> B Ext	<input type="checkbox"/> L	MANUAL \leftarrow	OPTIONS...
- 3  Open the **Trigger Options** menu.

Trigger Options	
Trigger :	
<input checked="" type="checkbox"/> Automatic...	
<input type="checkbox"/> on Edges...	
<input type="checkbox"/> Video on A...	
<input type="checkbox"/> Pulse Width on A...	



- 4  Select **Pulse Width on A...** to open the **Trigger on Pulse Width** menu.

Trigger on Pulse Width		
Pulses:	Condition:	Update:
<input checked="" type="checkbox"/> T	<input checked="" type="checkbox"/> <t	<input checked="" type="checkbox"/> On Trigger
	<input type="checkbox"/> >t	<input type="checkbox"/> Single Shot
	<input type="checkbox"/> <t (+10%)	
	<input type="checkbox"/> >t (+10%)	
- 5  Select the positive pulse icon, then jump to **Condition**.
- 6  Select <t, then jump to **Update**.
- 7  Select **On Trigger**.

The test tool is now prepared to trigger on narrow pulses only. Observe that the trigger key labels at the bottom of the screen have been adapted to set the pulse conditions:

P. WIDTH	CONDITION	LEVEL	TRIGGER
110.0ms \leftarrow	>t <input checked="" type="checkbox"/> OFF	\leftarrow	OPTIONS...

To set the pulse width to 5 ms, do the following:

- 7  Enable the arrow keys to adjust the pulse width.
- 8   Select 5 ms.

All narrow positive pulses shorter than 5 ms are now displayed on the screen. (See Figure 31.)

Tip

*The test tool stores all triggered screens in the replay memory. For example, if you setup your triggering for glitches, you can capture 100 glitches with time stamps. Use the **REPLAY** key to look at all the stored glitches.*

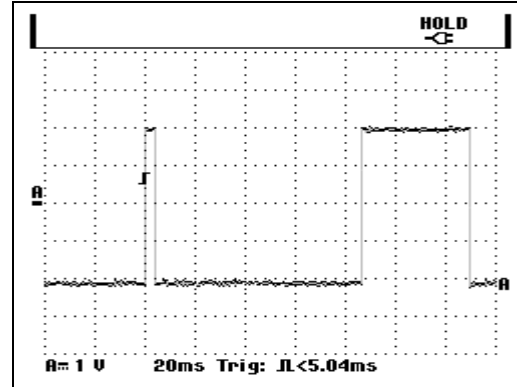





Figure 31. Triggering on Narrow Glitches

Finding Missing Pulses

The next example covers finding missing pulses in a train of positive pulses. In this example it is assumed that the pulses have a 100 ms distance between the rising edges. If the time accidentally increases to 200 ms, a pulse is missing. To set the test tool to trigger on such missing pulses, let it trigger on gaps bigger than about 150 ms. Do the following:

1  Display the TRIGGER key labels.

2  Open the **Trigger Options** menu.

3  Select **Pulse Width on A...** to open the **Trigger on Pulse Width** menu.

JL WIDTH 110.0ms	CONDITION >t OFF	LEVEL	TRIGGER OPTIONS...
---------------------	---------------------	-------	-----------------------

Trigger Options	
Trigger:	
<input checked="" type="checkbox"/>	Automatic...
<input type="checkbox"/>	on Edges...
<input type="checkbox"/>	Video on A...
<input type="checkbox"/>	Pulse Width on A...

Trigger on Pulse Width		
Pulses:	Condition:	Update:
<input checked="" type="checkbox"/> I	<input checked="" type="checkbox"/> <t	<input checked="" type="checkbox"/> On Trigger
<input type="checkbox"/> II	<input type="checkbox"/> >t	<input type="checkbox"/> Single Shot
	<input type="checkbox"/> =t (+10%)	
	<input type="checkbox"/> =t (+10%)	

4  Select the positive pulse icon to trigger on the gap between the positive pulses, then jump to **Condition**.



5  Select **>t**, then jump to **Update**.

6  Select **On Trigger**.

The test tool is now prepared to trigger on pulse gaps. Observe that the trigger menu at the bottom of the screen has been adapted to set the pulse condition:

JL WIDTH 110.0ms	CONDITION >t OFF	LEVEL	TRIGGER OPTIONS...
---------------------	---------------------	-------	-----------------------

To set the pulse width to 150 ms, continue as follows:

- | | | |
|---|---|--|
| 7 |  | Enable the arrow keys to adjust the pulse width. |
| 8 |   | Select 150 ms. |

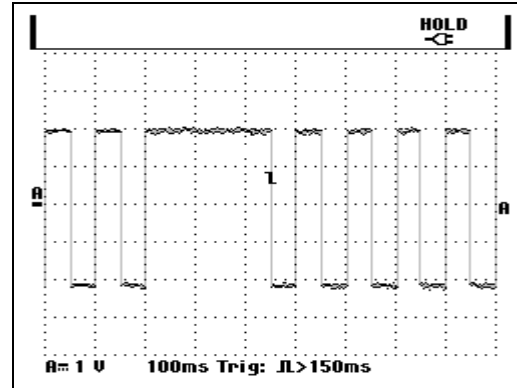

Figure 32. Triggering on Missing Pulses

Chapter 6

Using Memory, PC and Printer

About this Chapter

This chapter provides a step-by-step introduction to the general functions of the test tool that can be used in the three main modes: Scope, Meter, or Recorder. You will find information on printer and computer communication at the end of this chapter.

Saving and Recalling

You can:

- Save screens and setups to memory, and recall them again from memory. The test tool has 10 screen and setup memories and 2 record and setup memories.
- Recall screens and recordings to analyze or print the screen image at a later date.
- Recall a setup to continue a measurement with the recalled operating configuration.

Saving Screens with Associated Setups

To save a screen in memory location 10, do the following:

- 1  Display the **SAVE/PRINT** key labels.

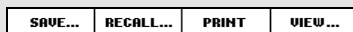

From this point the screen is frozen until you hide the **SAVE/PRINT** key labels again.

- 2  Open the **Save** menu.

Save		
SCREEN 1	SCREEN+SETUP	RECORD +SETUP
SCOPE	<input checked="" type="checkbox"/> 6	<input type="checkbox"/> 1
A = 2 A/div	<input type="checkbox"/> 2 <input type="checkbox"/> 7	<input type="checkbox"/> 2
B = 1 A/div	<input type="checkbox"/> 3 <input type="checkbox"/> 8	<input type="checkbox"/> 1
T = 200ms/div	<input type="checkbox"/> 4 <input type="checkbox"/> 9	<input type="checkbox"/> 2
10/12/97 05:00	<input type="checkbox"/> 5 <input type="checkbox"/> 10	
CANCEL	DELETE	DELETE ALL SAVE

Observe that free memory locations are indicated by an open square (). Filled memory locations are indicated by a solid square ().

- 3  Highlight **SCREEN+SETUP** location 10.

- 4  Save the actual screen.

Note

The two record+setup memory locations store more than what is just visible on the screen. In TrendPlot or scope record mode the full recording is saved. In scope mode you can save all 100 replay screens in a single record+setup memory location.

Deleting Screens with Associated Setups

To delete *all* screens and associated setups, continue from step 2 of the previous example as follows:

3  Delete all saved screens and setups.

To delete only one screen and setup, continue from step 2 of the previous example as follows:

3  Highlight **SCREEN+SETUP** location 5.

4  Delete the saved screen+setup of memory location 5.

Recalling Screens with Associated Setups

To recall screen+setup 2, do the following:

1  Display the **SAVE/PRINT** key labels.

SAVE...	RECALL...	PRINT	VIEW...
---------	-----------	-------	---------

2  Open the **Recall** menu.

Recall		
SCREEN 1	SCREEN+SETUP	RECORD +SETUP
SCOPE	01 06	
A= 2 A/div	02 07	01
B= 1 A/div	03 08	02
T 200ms/div	04 09	
10/12/97 05F00	05 10	
	CANCEL	RECALL SETUP RECALL

3  Highlight **SCREEN+SETUP** location 2.

4  Use **RECALL** to recall the saved screen.



Observe that the recalled waveform is displayed and that **HOLD** appears on the screen. From this point you can use cursors and zoom for analysis or you can print the recalled screen.

Recalling a Setup Configuration

To recall the setup configuration from memory 2, do the following:

- 1  Display the **SAVE/PRINT** key labels.

SAVE...	RECALL...	PRINT	VIEW...
---------	-----------	-------	---------
- 2  Open the **Recall** menu.

Recall		
SCREEN 1	SCREEN+SETUP	RECORD +SETUP
SCOPE	<input checked="" type="checkbox"/> 1 <input type="checkbox"/> 6	<input type="checkbox"/> 1
A m 2 A/div	<input type="checkbox"/> 2 <input type="checkbox"/> 7	<input type="checkbox"/> 2
B m 1 A/div	<input type="checkbox"/> 3 <input type="checkbox"/> 8	
T 200ms/div	<input type="checkbox"/> 4 <input type="checkbox"/> 9	
10/12/97 05:00	<input type="checkbox"/> 5 <input type="checkbox"/> 10	
	CANCEL	RECALL SETUP RECALL
- 3  Highlight **SCREEN+SETUP** location 2.
- 4  Use **RECALL SETUP** to recall the saved setup.

Observe that **RUN** appears at the top right of the screen. From this point you continue in the new operating configuration.

Viewing Stored Screens

To scroll through the memories while looking at the stored screens, do the following:

- 1  Display the **SAVE/PRINT** key labels.

SAVE...	RECALL...	PRINT	VIEW...
---------	-----------	-------	---------
- 2  Open the viewer.

VIEW SCREEN 1 ◀	PRINT	EXIT
-----------------	-------	------
- 3  Scroll through all stored screens.

Use this function to quickly find a stored screen.

Documenting Screens

With the FlukeView® software you can upload waveform data and screen bitmaps to your PC or notebook computer for further processing. Printing can also be done by connecting the test tool directly to a printer.

Connecting to a Computer

To connect the test tool to a PC or notebook computer and use the FlukeView software for Windows® (SW90W), do the following:

- Use the Optically Isolated RS-232 Adapter/Cable (PM9080) to connect a computer to the OPTICAL PORT of the test tool. (See Figure 33.)

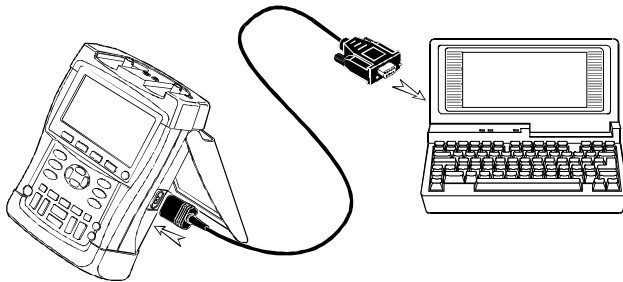

Figure 33. Connecting a Computer

Note

For information about installing and using the FlukeView ScopeMeter software, see the SW90W Users Manual.

A Software & Cable Carrying Case Kit is optionally available as model number SCC190.

Connecting to a Printer

To print a screen directly to a printer, use one of the following adapters:

- The Optically Isolated RS-232 Adapter/Cable (PM9080) to connect a serial printer to the OPTICAL PORT of the test tool. (See Figure 34.)
- The Print Adapter Cable (PAC91, optional) to connect a parallel printer to the OPTICAL PORT of the test tool. (See Figure 35.)

Before printing, you must setup the test tool for a specific printer.

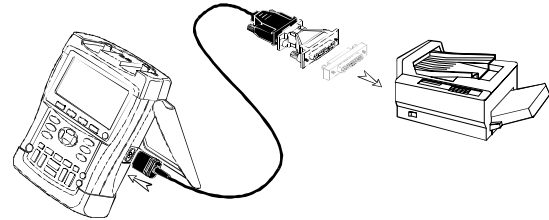

Figure 34. Connecting a Serial Printer

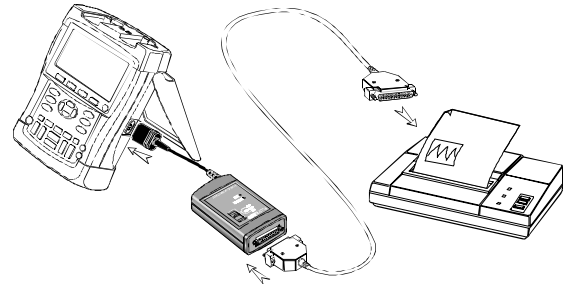

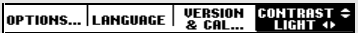



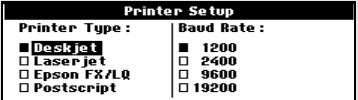



Figure 35. Connecting a Parallel Printer

Setting up the Printing Configuration



This example demonstrates how to set up the test tool for printing on a postscript printer with a 9600 baud rate:

1		Display the USER OPTIONS key labels.
		
2		Open the User Options menu.
		
3		Open the Printer Setup submenu.
		
4		Select Postscript and jump to Baud Rate .
5		Select a baud rate of 9600 and return to normal mode.

Whenever possible, choose the option Postscript when printing screens. This option gives the best printing results. Consult the manual that came with your printer to find out whether it has Postscript printing possibilities.

Printing a Screen

To print the currently displayed screen, do the following:

1		Clear the menu if you do not want to print it.
2		Display the SAVE/PRINT key labels.
3		Start printing.

A message appears at the bottom of the screen indicating that the test tool is busy printing.

Chapter 7

Tips

About this Chapter

This chapter gives you information and tips on how you can make the best use of the test tool.

Using the Standard Accessories

The following illustrations show the use of the standard accessories such as voltage probes, test leads, and the various clips.

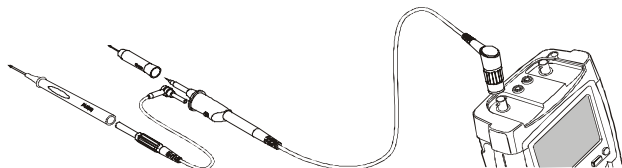

Figure 36. Probing Using 2-mm Heavy Duty Test Probes

Warning

To avoid electrical shock or fire, do not connect the ground spring to voltages higher than 30 Vrms from earth ground.



Figure 37. HF Voltage Probe Connection Using Ground Spring

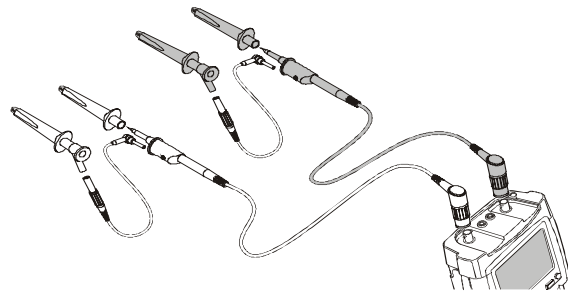

Figure 38. Heavy Duty Fixed Connections for Scope Measurements Using Industrial Alligator Clips

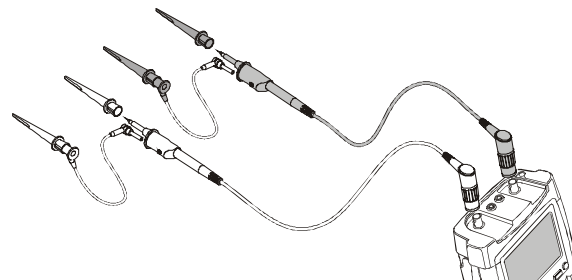

Figure 39. Electronic Connections for Scope Measurements Using Hook Clips and Hook Clip Grounding

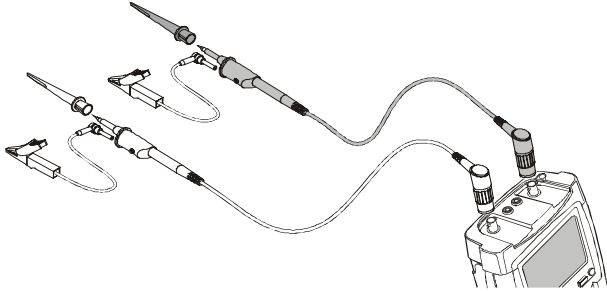

Figure 40. Electronic Connections for Scope Measurements Using Hook Clips and Alligator Clip Grounding

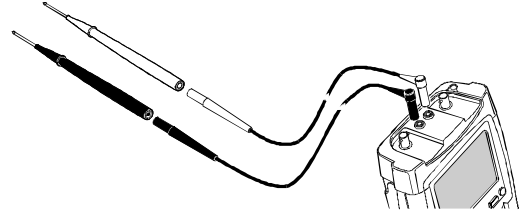

Figure 42. Manual Probing for Meter Measurements using 2-mm Test Probes

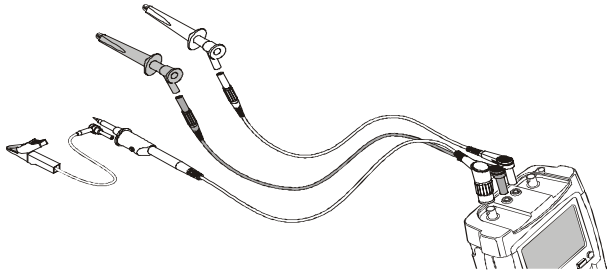

Figure 41. Fixed Electronic Connections for Scope Measurements with Fixed External Triggering

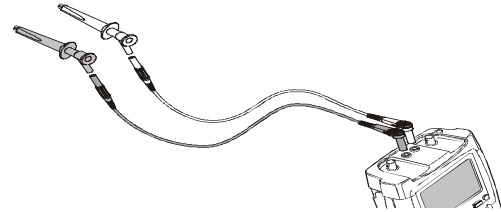

Figure 43. Heavy Duty Fixed Connections for Meter Measurements Using Industrial Alligator Clips

Using the Independently Floating Isolated Inputs

You can use the independently floating isolated inputs to measure signals that are independently floating from each other.

Independently floating isolated inputs offer additional safety and measurement capabilities compared to inputs with common references or grounds.

Measuring Using Independently Floating Isolated Inputs

The test tool has independently floating isolated inputs. Each input section (A, B, External Trigger / DMM) has its own signal input and its own reference input. The reference input of each input section is electrically isolated from the reference inputs of the other input sections. The isolated input architecture makes the test tool about as versatile as having three independent instruments. The advantages of having independently floating isolated inputs are:

- It allows simultaneous measurement of independently floating signals.

- Additional safety. Since the commons are not directly connected, the chance of causing short circuit when measuring multiple signals is greatly reduced.
- Additional safety. When measuring in systems with multiple grounds, the ground currents induced are kept to a minimum.

Because the references are not connected together inside the test tool, each reference of the used inputs must be connected to a reference voltage.

Independently floating isolated inputs are still coupled by parasitic capacitance. This can occur between the input references and the environment, and between the input references mutually (see Figure 44). For this reason, you should connect the references to a system ground or another stable voltage. If the reference of an input is connected to a high speed and / or high voltage signal, you should be aware of parasitic capacitance. (See Figures 45, 46, 47 and 48.)

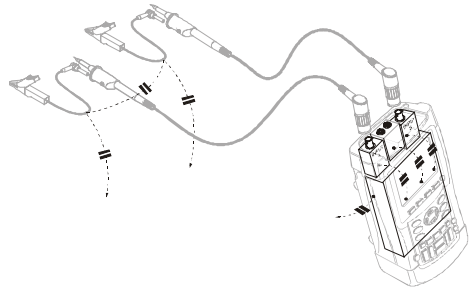

Figure 44. Parasitic capacitance between probes, instrument and environment

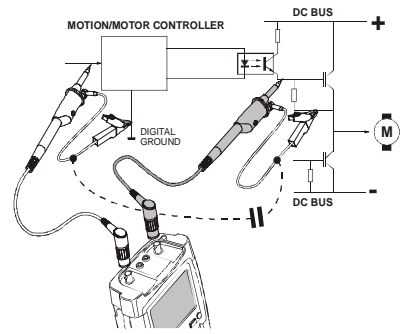

Figure 45. Parasitic capacitance between analog and digital reference

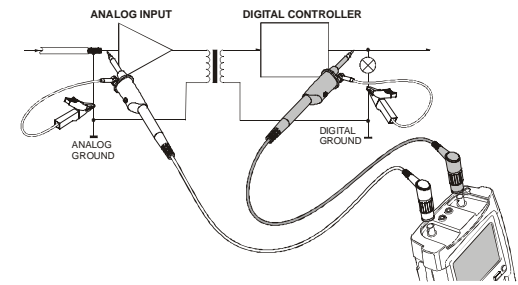

Figure 46. Correct connection of reference leads

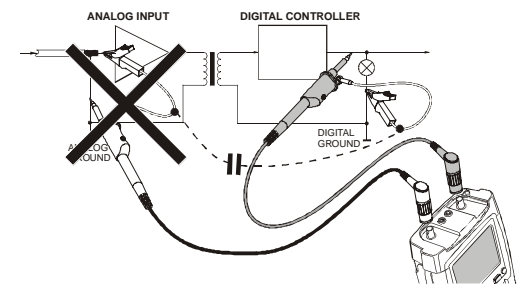

Figure 47. Wrong connection of reference leads

Noise that is picked up by reference lead B can be transmitted by parasitic capacitance to the analog input amplifier.

Using the Tilt Stand

The test tool is equipped with a tilt stand, allowing viewing from an angle while placed on a table. From this position you can access the OPTICAL PORT at the side of the test tool. The typical position is shown in Figure 48.

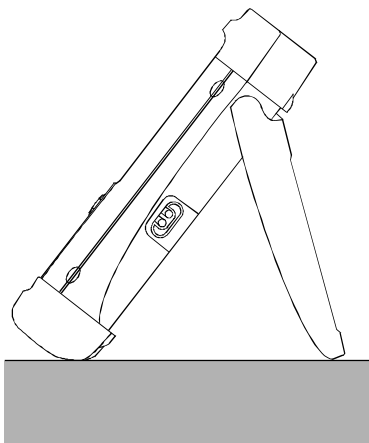





Figure 48. Using the Tilt Stand

Resetting the Test Tool

If you want to reset the test tool to the factory settings, do the following:

- 1  Turn the test tool off.
- 2  Press and hold.
- 3  Press and release.

The test tool turns on, and you should hear a double beep, indicating the reset was successful.

- 4  Release.

Suppressing Key Labels and Menu's

You can hide a menu or key label at any time:







-  Hide any key label or menu.

To display menus or key labels, press one of the yellow menu keys, e.g. the **SCOPE** key.

Changing the Information Language





During operation of the test tool, messages may appear at the bottom of the screen. You can select the language in which these messages are displayed. The combination of selectable languages (one or more) depends on the version ordered.

In this example you can select English or French . To change the language from English to French, do the following:

1		Display the USER key labels.
		
2		Open the Language Select menu.
		
3		Highlight FRENCH .
4		Accept French as the language.

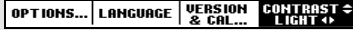
Adjusting the Contrast and Brightness

After power-up, the screen has a bright display. To adjust the contrast and backlight brightness, do the following:

1		Display the USER key labels.
		
2		Enable the arrow keys for manual contrast and backlight adjustment.
3		Adjust the contrast of the screen.
4		Change the backlight.

Note

The new contrast and brightness are stored until a new adjustment is made.









To save battery power, the test tool is in economic brightness mode when operated on the battery. The high brightness intensity increases when you connect the power adapter.



Note

Using dimmed light lengthens maximum battery power operation by about one hour.

Changing Date and Time

The test tool has a date and time clock. For example, to change the date to 19 April, 1999, do the following:

1		Display the USER key labels.	
2		Open the User Options menu.	
3		Open Date Adjust menu.	
4		Choose 1999, jump to Month .	
5		Choose 04, jump to Day .	

6		Choose 19, jump to Format .
7		Choose DD/MM/YY , accept the new date.

You can change the time in a similar way by opening the **Time Adjust** menu (steps 2 and 3.)

Saving Battery Life

When operated on the battery (no battery charger connected), the test tool conserves power by shutting itself down. If you have not pressed a key for at least 30 minutes, the test tool turns itself off automatically.

Note



If the power adapter is connected, there is no automatic power shutdown.



Automatic power shutdown will not occur if TrendPlot or Scope Record is on, but the backlight will dim. Recording will continue even if the battery is low, and retention of memories is not jeopardized.



Setting the Power Down Timer

Initially the power shutdown time is 30 minutes. You can set the power shutdown time to 5 minutes as following:

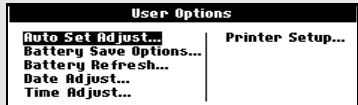
- 1  Display the **USER** key labels.



- 2  Open the **User Options** menu.

- 3  Open the **Battery Save Options** menu.



- 4  Select **5 Minutes**.

Changing the Auto Set Options

With the next procedure you can choose how auto set behaves when you press the **AUTO** (auto set) key.

1  Display the **USER** key labels.

OPTIONS...	LANGUAGE	VERSION & CAL...	CONTRAST \leftarrow
			LIGHT \rightarrow

2  Open the **User Options** menu.

User Options	
Auto Set Adjust...	Printer Setup...
Battery Save Options...	
Battery Refresh...	
Date Adjust...	
Time Adjust...	

3  Open the **Auto Set Adjust** menu.

Auto Set Adjust	
Search for:	Coupling:
<input checked="" type="checkbox"/> Signal > 15Hz	<input checked="" type="checkbox"/> Set To DC
<input type="checkbox"/> Signal > 1Hz	<input type="checkbox"/> Unchanged

If the frequency range is set to > 15 Hz, the Connect-and-View function responds more quickly. The response is quicker because the test tool is instructed not to analyze low frequency signal components. However, when you measure frequencies lower than 15 Hz, the test tool must be instructed to analyze low frequency components for automatic triggering:

4  Select **Signal > 1 Hz**, then jump to **Coupling**.

With the coupling option you can choose how auto set behaves. When you press the **AUTO** (auto set) key, the coupling can either be set to dc or left unchanged:

5  Select **Unchanged**.

Note

The auto set option for the signal frequency is similar to the automatic trigger option for the signal frequency. (See Chapter 5: “Automatic Trigger Options”). However, the auto set option determines the behavior of the auto set function and shows only effect when you press the auto set key.

Chapter 8

Maintaining the Test Tool

About this Chapter

This chapter covers basic maintenance procedures that can be performed by the user. For complete service, disassembly, repair, and calibration information, see the Service Manual. You will find the part number of the Service Manual in the section “*Parts and Accessories*” in this chapter.

Cleaning the Test Tool







Clean the test tool with a damp cloth and a mild soap. Do not use abrasives, solvents, or alcohol. These may damage the text on the test tool.

Storing the Test Tool

If you are storing the test tool for an extended period of time, charge the NiMH (Nickel-Metal Hydride) batteries before storing.

Charging the Batteries

At delivery, the NiMH batteries may be empty and must be charged for 4 hours (with the test tool turned off) to reach full charge. When fully charged, the batteries provide 4 hours of use.

When battery power is used, the battery indicator at the top of the screen informs you about the condition of the batteries. The battery symbols are:      . The symbol  indicates that there are typically five minutes of operating time left.

To charge the batteries and power the instrument, connect the battery charger as shown in Figure 49. To charge the batteries more quickly, turn off the test tool.

Caution

To avoid overheating of the batteries during charging, do not exceed the allowable ambient temperature given in the specifications.

Note

No damage will occur if the charger is connected for long periods, e.g., during the weekend. The instrument then automatically switches to trickle charging.

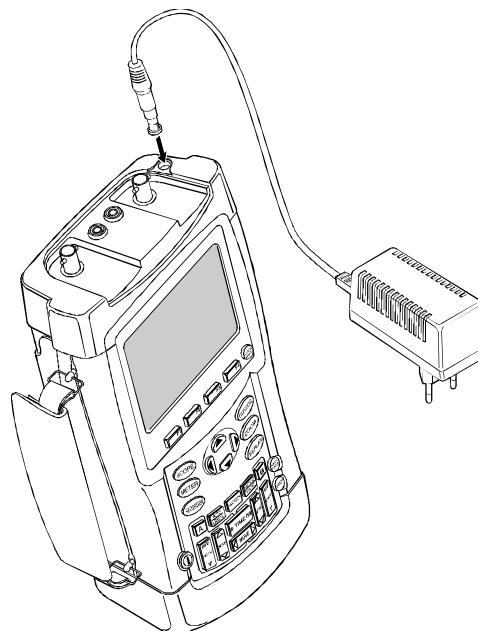



Figure 49. Charging the Batteries



Extending Battery Operation Time

Typically, NiMH batteries always meet the specified operating time. However, if the batteries have been extremely discharged (for example, when empty batteries were stored for a long period) it is possible that the battery condition has deteriorated.

To keep the batteries in optimal condition, observe the following guidelines:

- Operate the test tool on batteries until the  symbol appears at the bottom of the screen. This indicates that the battery level is low and that the NiMH batteries need to be recharged.
- To obtain optimal battery condition again, you can *refresh* the batteries. During a battery refresh, the batteries will be fully discharged and charged again. A complete refresh cycle takes about 12 hours and should be done about four times a year. You can check the latest battery refresh date. See section “Displaying Calibration Information”.

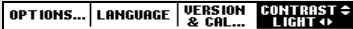
To refresh the battery, make sure that the test tool is line powered and proceed as follows:

1		Display the USER key labels.
		
2		Open the User Options menu.
		

A message appears asking whether you want to start the refresh cycle now.

3		Start the refresh cycle.
----------	--	--------------------------

Do not disconnect the battery charger during the refresh cycle. This will interrupt the refresh cycle.

Note

After starting the refresh cycle, the screen will be black.







Replacing the NiMH Battery Pack BP190

Usually it should not be necessary to replace the battery pack. However, if replacement is needed, this should be done by qualified personnel only. Contact your nearest Fluke center for more information.

Calibrating the Voltage Probes

To meet full user specifications, you need to adjust the red and gray voltage probes for optimal response. The calibration consists of a high frequency adjustment and a dc calibration for 10:1 probes. The dc calibration is not possible for 100:1 probes.

This example shows how to calibrate the 10:1 voltage probes:

1		Display the input A key labels.										
<table border="1"><tr><td>INPUT A</td><td>COUPLING</td><td>PROBE A</td><td>INPUT A</td></tr><tr><td></td><td>OFF</td><td>AC</td><td>10:1... OPTIONS...</td></tr></table>			INPUT A	COUPLING	PROBE A	INPUT A		OFF	AC	10:1... OPTIONS...		
INPUT A	COUPLING	PROBE A	INPUT A									
	OFF	AC	10:1... OPTIONS...									
2		Open the Probe on A menu.										
<table border="1"><tr><td colspan="2">Probe on A</td></tr><tr><td>Probe Type :</td><td>Attenuation :</td></tr><tr><td><input checked="" type="checkbox"/> Voltage</td><td><input type="checkbox"/> 1 : 1 <input type="checkbox"/> 20 : 1</td></tr><tr><td><input type="checkbox"/> Current</td><td><input checked="" type="checkbox"/> 10 : 1 <input type="checkbox"/> 200 : 1</td></tr><tr><td><input type="checkbox"/> Temp</td><td><input type="checkbox"/> 100 : 1 <input type="checkbox"/> 1000 : 1 <input type="checkbox"/> Probe Cal...</td></tr></table>			Probe on A		Probe Type :	Attenuation :	<input checked="" type="checkbox"/> Voltage	<input type="checkbox"/> 1 : 1 <input type="checkbox"/> 20 : 1	<input type="checkbox"/> Current	<input checked="" type="checkbox"/> 10 : 1 <input type="checkbox"/> 200 : 1	<input type="checkbox"/> Temp	<input type="checkbox"/> 100 : 1 <input type="checkbox"/> 1000 : 1 <input type="checkbox"/> Probe Cal...
Probe on A												
Probe Type :	Attenuation :											
<input checked="" type="checkbox"/> Voltage	<input type="checkbox"/> 1 : 1 <input type="checkbox"/> 20 : 1											
<input type="checkbox"/> Current	<input checked="" type="checkbox"/> 10 : 1 <input type="checkbox"/> 200 : 1											
<input type="checkbox"/> Temp	<input type="checkbox"/> 100 : 1 <input type="checkbox"/> 1000 : 1 <input type="checkbox"/> Probe Cal...											
3		Select Voltage , then jump to Attenuation .										

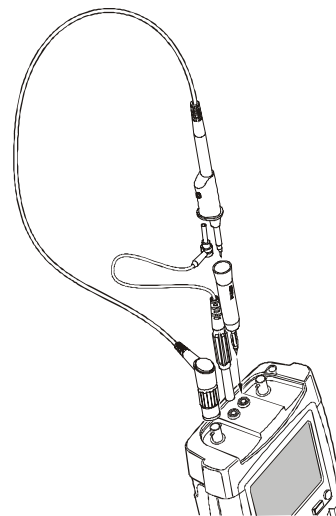



Figure 50. Adjusting Voltage Probes

If the 10:1 option is already selected, proceed with step 5.

4		Select 10:1 , then return.
---	--	-----------------------------------

Repeat steps 2 and 3 and proceed as follows:

5  Select **Probe Cal** with the arrow keys, then accept.

A message appears asking you whether to start the 10:1 probe calibration.

6  Start the probe calibration.

A message appears telling you how to connect the probe. Connect the red 10:1 voltage probe from the red input A jack to the red banana jack. Connect the reference lead to the black banana jack. (See Figure 50.)

7 Adjust the trimmer screw in the probe housing until a pure square wave is displayed.

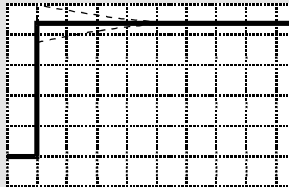

8  Continue with DC calibration. Automatic DC calibration is only possible for 10:1 voltage probes.

The test tool automatically calibrates itself to the probe. During calibration you should not touch the probe. A message indicates when the DC calibration has completed successfully.

9  Return.

Repeat the procedure for the gray 10:1 voltage probe. Connect the grey 10:1 voltage probe from the grey input B jack to the red banana jack. Connect the reference lead to the black banana jack.

Note

When using 100:1 voltage probes, choose 100:1 attenuation to perform a HF adjustment. Automatic dc calibration is not possible with this probe type.

Displaying Calibration Information

You can display version number and calibration date:

1  Display the **USER** key labels.

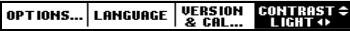

2  Open the **Version & Calibration** menu.



Version & Calibration	
Model Number :	192
Software Version :	001.03
Calibration Number :	#2
Calibration Date :	01/07/2001
Battery Refresh Date :	01/09/2001

The screen gives you information about the model number with software version, the calibration number with latest calibration date, and the latest battery refresh date.

3  Return.

Recalibration must be carried out by qualified personnel. Contact your local Fluke representative for recalibration.



Parts and Accessories

Standard Accessories





The following tables list the user-replaceable parts for the various test tool models. For additional optional accessories, see the ScopeMeter Accessories booklet.

To order replacement parts or additional accessories, contact your nearest service center.

Table 1. Standard Accessories

Item	Ordering Code
<p>Battery Charger, available models:</p> <p>Universal Europe 230 V, 50 and 60 Hz</p> <p>North America 120 V, 50 and 60 Hz</p> <p>United Kingdom 240 V, 50 and 60 Hz</p> <p>Japan 100 V, 50 and 60 Hz</p> <p>Australia 240 V, 50 and 60 Hz</p> <p>Universal 115 V/230 V, 50 and 60 Hz *</p> <p><i>* The 230V rating of the BC190/808 is not for use in North America. A line plug adapter complying with the applicable National Requirements may be provided to alter the blade configurations for a specific country. The universal adapter is standard equipped with a North American line cord.</i></p>	<p> BC190/801</p> <p>BC190/803</p> <p> BC190/804</p> <p>BC190/806</p> <p>BC190/807</p> <p>BC190/808</p>
<p>Voltage Probe Set (Red), designed for use with the Fluke ScopeMeter 190 series test tool.</p> <p>The set includes the following items (not available separately):</p> <ul style="list-style-type: none"> • 10:1 Voltage Probe (red) • 4-mm Test Probe for Probe Tip (red) • Hook Clip for Probe Tip (red) • Ground Lead with Hook Clip (red) • Ground Lead with Mini Alligator Clip (black) • Ground Spring for Probe Tip (black) 	<p> VPS200-R</p>

Fluke 192/196/199*Users Manual*

Item	Ordering Code
<p>Voltage Probe Set (Gray), designed for use with the Fluke ScopeMeter 190 series test tool. </p> <p>The set includes the following items (not available separately):</p> <ul style="list-style-type: none">• 10:1 Voltage Probe (gray)• 4-mm Test Probe for Probe Tip (gray)• Hook Clip for Probe Tip (gray)• Ground Lead with Hook Clip (gray)• Ground Lead with Mini Alligator Clip (black)	VPS200-G
Flexible Test Leads (red and black) 	TL24 <i>(General Purpose Leads)</i>
Accessory Set (Red)  <p>The set includes the following items (not available separately):</p> <ul style="list-style-type: none">• Industrial Alligator for Probe Tip (red)• 2-mm Test Probe for Probe Tip (red)• Industrial Alligator for Banana Jack (red)• 2-mm Test Probe for Banana Jack (red)• Ground Lead with 4-mm Banana Jack (black)	AS200-R
Accessory Set (Gray)  <p>The set includes the following items (not available separately):</p> <ul style="list-style-type: none">• Industrial Alligator for Probe Tip (gray)• 2-mm Test Probe for Probe Tip (gray)• Industrial Alligator for Banana Jack (gray)• 2-mm Test Probe for Banana Jack (gray)• Ground Lead with 4-mm Banana Jack (black)	AS200-G

Item	Ordering Code
Replacement Set for Voltage Probe  <p>The set includes the following items (not available separately):</p> <ul style="list-style-type: none"> • 2x 4-mm Test Probe for Probe Tip (red and gray) • 3x Hook Clip for Probe Tip (2 red, 1 gray) • 2x Ground Lead with Hook Clip (red and gray) • 2x Ground Lead with Mini Alligator Clip (black) • 5x Ground Spring for Probe Tip (black) 	RS200

Table 2. Users Manuals

Item	Ordering Code
Users Manual (English)	4822 872 00983
Users Manual (German)	4822 872 00984
Users Manual (French)	4822 872 00985
Users Manual (Spanish)	4822 872 00986
Users Manual (Portuguese)	4822 872 00987
Users Manual (Italian)	4822 872 00988
Users Manual (Chinese)	4822 872 00989
Users Manual (Japanese)	4822 872 00991
Users Manual (Korean)	4822 872 00992

Optional Accessories

Item	Ordering Code
Software & Cable Carrying Case Kit Set contains the following parts: Optically Isolated RS-232 Adapter/Cable Hard Carrying Case FlukeView [®] ScopeMeter [®] Software for Windows 95 [®] , 98 [®] , Me [®] , 2000 [®] and NT4 [®]	SCC190 PM9080 C190 SW90W
Optically Isolated RS-232 Adapter/Cable	PM9080
Hard Case	C190
Soft Case	C195
Current Shunt 4-20 mA	CS20MA
Print Adapter Cable for Parallel Printers	PAC91

Optional Service Manual

Item	Ordering Code
Service Manual (English)	4822 872 05376

Troubleshooting



The Test Tool Does Not Start Up

- The batteries may be completely empty. In this case the test tool will not start up, even if it is powered by the battery charger. Charge the batteries first: power the test tool with the battery charger without turning it on. Wait about 15 minutes and try turning on the test tool again.

The Test Tool Shuts Down After A Few Seconds

- The batteries may be empty. Check the battery symbol at the top right of the screen. A  symbol indicates that the batteries are empty and must be charged.

The Screen Remains Black

- Make sure that the test tool is on.
- You might have a problem with the screen contrast. Press , then press . Now you can use the arrow keys to adjust the contrast.

The Operation Time Of Fully Charged Batteries Is Too Short

- The batteries may be in poor condition. Refresh the batteries to optimize the condition of the batteries again. It is advised to refresh the batteries about four times a year.

The Printer Does Not Print

- Make sure that the interface cable is properly connected between the test tool and the printer.
- Make sure that you have selected the correct printer type. (See Chapter 6.)
- Make sure that the baud rate matches with the printer. If not, select another baud rate. (See Chapter 6.)
- If you are using the PAC91 (Print Adapter Cable), make sure that it is turned on.

FlukeView Does Not Recognize The Test Tool

- Make sure that the test tool is turned on.
- Make sure that the interface cable is properly connected between the test tool and the PC.
- Make sure that the correct COM port has been selected in FlukeView. If not, change the COM port setting or connect the interface cable to another COM port.

Battery Operated Fluke Accessories Do Not Function

- When using battery operated Fluke accessories, always first check the battery condition of the accessory with a Fluke multimeter.

Chapter 9

Specifications

Introduction

Performance Characteristics

FLUKE guarantees the properties expressed in numerical values with the stated tolerance. Specified non-tolerance numerical values indicate those that could be nominally expected from the mean of a range of identical ScopeMeter test tools.

Environmental Data

The environmental data mentioned in this manual are based on the results of the manufacturer's verification procedures.

Safety Characteristics

The test tool has been designed and tested in accordance with Standards ANSI/ISA S82.01-1994, EN 61010.1 (1993) (IEC 1010-1), CAN/CSA-C22.2 No.1010.1-92 (including approval), UL3111-1 (including approval) Safety Requirements for Electrical Equipment for Measurement, Control, and Laboratory Use.

This manual contains information and warnings that must be followed by the user to ensure safe operation and to keep the instrument in a safe condition. Use of this equipment in a manner not specified by the manufacturer may impair protection provided by the equipment.

Dual Input Oscilloscope

Isolated Inputs A and B (Vertical)

Bandwidth, DC Coupled

FLUKE 199	200 MHz (-3 dB)
FLUKE 196	100 MHz (-3 dB)
FLUKE 192	60 MHz (-3 dB)

Lower Frequency Limit, AC Coupled

with 10:1 probe	<2 Hz (-3 dB)
direct (1:1)	<5 Hz (-3 dB)

Rise Time

FLUKE 199	1.7 ns
FLUKE 196	3.5 ns
FLUKE 192	5.8 ns

Analog Bandwidth Limiters 20 MHz and 10 kHz

Input Coupling AC, DC

Polarity Normal, Inverted

Sensitivity Ranges

with 10:1 probe	50 mV to 1000 V/div
direct (1:1)	5 mV to 100 V/div

Trace Positioning Range ± 4 divisions

Input Impedance on BNC

DC Coupled 1 M Ω (± 1 %)/15 pF (± 2 pF)

Max. Input Voltage

with 10:1 probe	600 V CAT III
	1000 V CAT II
direct (1:1)	300 V CAT III

(For detailed specifications, see "Safety")

Vertical Accuracy $\pm(1.5\% + 0.04 \text{ range/div})$

Digitizer Resolution 8 bits, separate digitizer
for each input

Horizontal

Maximum Time Base Speed:

FLUKE 199	5 ns/div
FLUKE 196	5 ns/div
FLUKE 192	10 ns/div

Minimum Time Base Speed (Scope Record) 2 min/div

Real Time Sampling Rate (for both inputs simultaneously)

FLUKE199:

5 ns to 2 μ s /div	up to 2.5 GS/s
5 μ s to 120 s/div	20 MS/s

FLUKE 196:

5 ns to 2 μ s /div	up to 1 GS/s
5 μ s to 120 s/div	20 MS/s

FLUKE 192

10 ns to 2 μ s /div	up to 500 MS/s
5 μ s to 120 s/div	20 MS/s

Record Length
 Scope Record Mode..... 27500 points on each input
 Scope Normal Mode..... 1000 points on each input
 Scope Glitch Capture Mode... 500 points on each input

Glitch Detection
 5 μ s to 120 s/div displays glitches as fast as 50 ns

Waveform Display A, B, A+B, A-B, A*B, A vs B
 Normal, Average (2,4,8,64 x), Persistence

Time Base Accuracy \pm 100 ppm

Trigger and Delay

Trigger Modes..... Automatic, Edge,
 External, Video, Pulse Width

Trigger Delay up to +1000 divisions

Pre Trigger Viewone full screen length

Max. Delay..... 10 seconds

Automatic Connect-and-View Trigger

Source A, B, EXT

Slope Positive, Negative

Edge Trigger

Screen Update..... Free Run, On Trigger, Single Shot

Source A, B, EXT

Slope Positive, Negative

Trigger Level Control Range..... \pm 4 divisions

Trigger Sensitivity A and B

DC to 5 MHz at $>$ 5 mV/div0.5 divisions

DC to 5 MHz at 5 mV/div 1 division

200 MHz (FLUKE 199) 1 division

250 MHz (FLUKE 199) 2 divisions

100 MHz (FLUKE 196) 1 division

150 MHz (FLUKE 196) 2 divisions

60 MHz (FLUKE 192) 1 division

100 MHz (FLUKE 192) 2 divisions

Isolated External Trigger

Bandwidth 10 kHz

Modes..... Automatic, Edge

Trigger Levels (DC to 10 kHz) 120 mV, 1.2 V

Video Trigger

Standards PAL, PAL+, NTSC, SECAM

Modes..... Lines, Line Select, Field 1 or Field 2

Source A

Polarity..... Positive, Negative

Sensitivity..... 0.7 division sync level

Pulse Width Trigger

Screen Update.....On Trigger, Single Shot
Trigger Conditions..... <T, >T, ≈T (±10 %), ≠T(±10 %)
Source.....A
PolarityPositive or negative pulse
Pulse Time Adjustment Range 1/100 div. to 250 div.
with a maximum resolution of 50 ns.

Continuous Auto Set

Autorangeing attenuators and time base, automatic
Connect-and-View™ triggering with automatic source
selection.

Modes

Normal..... 15 Hz to max. bandwidth
Low Frequency 1 Hz to max. bandwidth

Minimum Amplitude A and B

DC to 1 MHz 10 mV
1 MHz to max. bandwidth.....20 mV

Automatic Capturing Scope Screens

Capacity 100 dual input scope Screens

For viewing screens, see Replay function.

Automatic Scope Measurements

The accuracy of all readings is within ± (% of reading + number of counts) from 18 °C to 28 °C. Add 0.1x (specific accuracy) for each °C below 18 °C or above 28 °C. For voltage measurements with 10:1 probe, add probe accuracy unless the probe has been calibrated on the test tool. At least 1.5 waveform period must be visible on the screen.

General

InputsA and B
DC Common Mode Rejection (CMRR) >100 dB
AC Common Mode Rejection at 50, 60, or 400 Hz>60 dB

DC Voltage (VDC)

Maximum Voltage
with 10:1 probe 1000 V
direct (1:1) 300 V

Maximum Resolution
with 10:1 probe 1 mV
direct (1:1) 100 µV

Full Scale Reading 1100 counts
Accuracy at 5 s to 5 µs/div±(1.5 % +5 counts)
Normal Mode AC Rejection at 50 or 60 Hz >60 dB

AC Voltage (VAC)

Maximum Voltage
 with 10:1 probe..... 1000 V
 direct (1:1)..... 300 V

Maximum Resolution
 with 10:1 probe..... 1 mV
 direct (1:1)..... 100 μ V

Full Scale Reading 1100 counts

Accuracy

DC coupled:

DC to 60 Hz..... $\pm(1.5 \% + 10 \text{ counts})$

AC coupled, low frequencies:

50 Hz direct (1:1)..... $\pm(2.1 \% + 10 \text{ counts})$

60 Hz direct (1:1)..... $\pm(1.9 \% + 10 \text{ counts})$

With the 10:1 probe the low frequency roll off point will be lowered to 2 Hz, which improves the AC accuracy for low frequencies. When possible use DC coupling for maximum accuracy.

AC or DC coupled, high frequencies:

60 Hz to 20 kHz..... $\pm(2.5 \% + 15 \text{ counts})$

20 kHz to 1 MHz..... $\pm(5 \% + 20 \text{ counts})$

1 MHz to 25 MHz..... $\pm(10 \% + 20 \text{ counts})$

For higher frequencies the instrument's frequency roll off starts affecting accuracy.

Normal Mode DC Rejection..... >50 dB

All accuracies are valid if:

- The waveform amplitude is larger than one division
- At least 1.5 waveform period is on the screen

AC+DC Voltage (True RMS)

Maximum Voltage
 with 10:1 probe..... 1000 V
 direct (1:1)..... 300 V

Maximum Resolution
 with 10:1 probe..... 1 mV
 direct (1:1)..... 100 μ V

Full Scale Reading 1100 counts

Accuracy

DC to 60 Hz $\pm(1.5 \% + 10 \text{ counts})$

60 Hz to 20 kHz..... $\pm(2.5 \% + 15 \text{ counts})$

20 kHz to 1 MHz..... $\pm(5 \% + 20 \text{ counts})$

1 MHz to 25 MHz $\pm(10 \% + 20 \text{ counts})$

For higher frequencies the instrument's frequency roll off starts affecting accuracy.

Amperes (AMP)

With Optional Current Probe or Current Shunt

Ranges..... same as VDC, VAC, VAC+DC

Probe Sensitivity100 μ V/A, 1 mV/A, 10 mV/A,
100 mV/A, 1 V/A, 10 V/A, and 100 V/A

Accuracy same as VDC, VAC, VAC+DC
(add current probe or current shunt accuracy)

Peak

ModesMax peak, Min peak, or pk-to-pk

Maximum Voltage
with 10:1 probe 1000 V
direct (1:1) 300 V

Maximum Resolution
with 10:1 probe 10 mV
direct (1:1) 1 mV

Full Scale Reading..... 800 counts

Accuracy
Max peak or Min peak..... ± 0.2 division
Peak-to-peak ± 0.4 division

Frequency (Hz)

Range.....1.000 Hz to full bandwidth

Full Scale Reading 9 999 counts
with at least 10 waveform periods on screen.

Accuracy
1 Hz to full bandwidth $\pm(0.5 \% + 2 \text{ counts})$

Duty Cycle (DUTY)

Range.....4.0 % to 98.0 %

Pulse Width (PULSE)

Resolution (with GLITCH off)..... 1/100 division

Full Scale Reading 999 counts

Accuracy
1 Hz to full bandwidth $\pm(0.5 \% + 2 \text{ counts})$

Power

Power Factor ratio between Watts and VA
 Range 0.00 to 1.00

Watt..... RMS reading of multiplication
 corresponding samples of input A (volts)
 and Input B (amperes)
 Full Scale Reading 999 counts

VA $V_{rms} \times I_{rms}$
 Full Scale Reading 999 counts

VA Reactive $\sqrt{((VA)^2 - W^2)}$
 Full Scale Reading 999 counts

Phase

Range..... -180 to +180 degrees
 Resolution..... 1 degree
 Accuracy

0.1 Hz to 1 MHz ± 1 degrees
 1 MHz to 10 MHz ± 3 degrees

Temperature (TEMP)

With Optional Temperature Probe

Ranges (°C or °F) -40.0 to +100.0 °
 -100 to +250 °
 -100 to +500 °
 -100 to +1000 °
 -100 to + 2500 °

Probe Sensitivity 1 mV/°C and 1 mV/°F

Decibel (dB)

dBV.....dB relative to one volt
 dBm dB relative to one mW in 50 Ω or 600 Ω
 dB on..... VDC, VAC, or VAC+DC
 Accuracy..... same as VDC, VAC, VAC+DC

Meter

Meter Input

Input Coupling DC

Frequency Response DC to 10 kHz (-3 dB)

Input Impedance 1 M Ω (± 1 %)//10 pF (± 1.5 pF)

 Max. Input Voltage 1000 V CAT II
600 V CAT III

(For detailed specifications, see "Safety")

Meter Functions

Ranging Auto, Manual

Modes Normal, Relative

DMM Measurements on Meter Inputs

The accuracy of all measurements is within \pm (% of reading + number of counts) from 18 °C to 28 °C.

Add 0.1x (specific accuracy) for each °C below 18 °C or above 28 °C.

General

DC Common Mode Rejection (CMRR) >100 dB

AC Common Mode Rejection at 50, 60, or 400 Hz >60 dB

Ohms (Ω)

Ranges 500.0 Ω , 5.000 k Ω , 50.00 k Ω ,
500.0 k Ω , 5.000 M Ω , 30.00 M Ω

Full Scale Reading

500 Ω to 5 M Ω 5000 counts

30 M Ω 3000 counts

Accuracy $\pm(0.6$ % +5 counts)

Measurement Current 0.5 mA to 50 nA, ± 20 %
decreases with increasing ranges

Open Circuit Voltage <4 V

Continuity (CONT)

Beep <50 Ω (± 30 Ω)

Measurement Current 0.5 mA, ± 20 %

Detection of shorts of ≥ 1 ms

Amperes (AMP)

With Optional Current Probe or Current Shunt

Ranges..... same as VDC, VAC, VAC+DC

Probe Sensitivity100 μ V/A, 1 mV/A, 10 mV/A,
100 mV/A, 1 V/A, 10 V/A, and 100 V/A

Accuracy same as VDC, VAC, VAC+DC
(add current probe or current shunt accuracy)

Recorder

TrendPlot (Meter or Scope)

Chart recorder that plots a graph of min and max values of Meter or Scope measurements over time.

Measurement Speed..... > 2.5 measurements/s

Time/Div 10 s/div to 20 min/div

Record Size 13500 points per input

Recorded Time Span 90 min to 8 days

Time Reference time from start, time of day

Scope Record

Records scope waveforms in deep memory while displaying the waveform in Roll mode.

Source Input A, Input B

Max. Sample Speed (10 ms/div to 1 min/div)..... 20 MS/s

Glitch capture (10 ms/div to 1 min/div) 50 ns

Time/Div in normal mode 10 ms/div to 2 min/div

Record Size 27500 points per input

Recorded Time Span 11 s to 30 hours

Acquisition Modes Single Sweep
Continuous Roll
External Triggering

Time Reference time from start, time of day

Probe Calibration

Manual pulse adjustment and automatic DC adjustment with probe check.

Generator Output..... 3 Vpp / 500 Hz square wave

Memory

Number of Scope Memories..... 10

Each memory can contain two waveforms plus corresponding setups

Number of Recorder Memories 2

Each memory can contain:

- a dual input TrendPlot (2 x 13500 points per input)
- a dual input Scope Record (2 x 27500 points per input)
- 100 dual input Scope screens

Mechanical

Size 64 x 169 x 254 mm (2.5 x 6.6 x 10 in)

Weight 1.95 kg (4.3 lbs) including battery

Optical InterfacePort

Type RS-232, optically isolated

To Printer..... supports Epson FX, LQ, and HP Deskjet®, Laserjet®, and Postscript

- Serial via PM9080 (optically isolated RS-232 Adapter/Cable, optional).
- Parallel via PAC91 (optically isolated Print Adapter Cable, optional).

To PC/Notebook

- Serial via PM9080 (optically isolated RS-232 Adapter/Cable, optional), using SW90W (FlukeView® software for Windows 95®, 98®, Me®, 2000® and NT4®).

Environmental

Environmental..... MIL-PRF-28800F, Class 2

Temperature

Operating:

battery only.....0 to 50 °C (32 to 122 °F)

power adapter0 to 40 °C (32 to 104 °F)

Storage -20 to +60 °C (-4 to +140 °F)

Humidity

Operating:

0 to 10 °C (32 to 50 °F)..... noncondensing

10 to 30 °C (50 to 86 °F)..... 95 %

30 to 40 °C (86 to 104 °F).....75 %

40 to 50 °C (104 to 122 °F).....45 %

Storage:

-20 to +60 °C (-4 to +140 °F) noncondensing

Altitude

Operating 3 km (10 000 feet)

Storage 12 km (40 000 feet)

Vibration (Sinusoidal) max. 3 g

Shock max. 30 g

Electromagnetic Compatibility (EMC)

Emission and immunity EN-IEC61326-1 (1997)

Enclosure ProtectionIP51, ref: IEC529

⚠ Safety

Designed for measurements on 1000 V Category II Installations, 600 V Category III Installations, Pollution Degree 2, per:

- ANSI/ISA S82.01-1994
- EN61010-1 (1993) (IEC1010-1)
- CAN/CSA-C22.2 No.1010.1-92
- UL3111-1

⚠ Max. Input Voltages

Input A and B directly	300 V CAT III
Input A and B via 10:1 probe	1000 V CAT II 600 V CAT III
METER/EXT TRIG inputs	1000 V CAT II 600 V CAT III

⚠ Max. Floating Voltage

From any terminal to ground	1000 V CAT II 600 V CAT III
Between any terminal.....	1000 V CAT II 600 V CAT III

Voltage ratings are given as “working voltage”. They should be read as Vac-rms (50-60 Hz) for AC sinewave applications and as Vdc for DC applications.

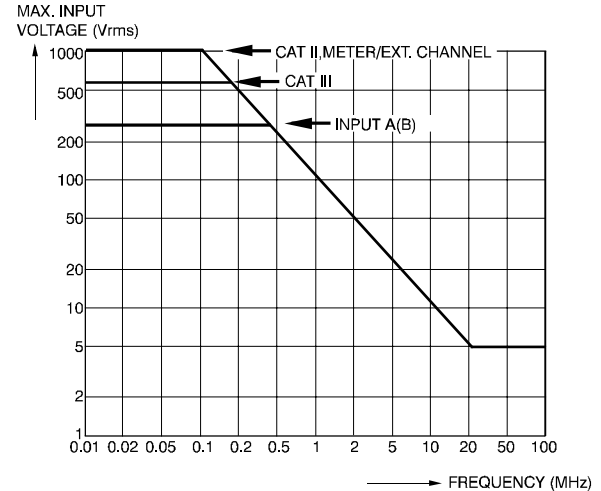

Figure 51. Max. Input Voltage v.s. Frequency

Note

Overvoltage Category III refers to distribution level and fixed installation circuits inside a building. Overvoltage Category II refers to local level, which is applicable for appliances and portable equipment.

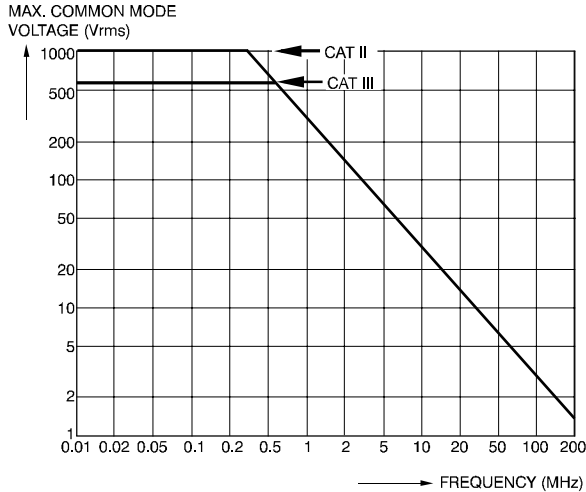

Figure 52. Safe Handling: Max. Input Voltage Between Scope References, and Between Scope References and Meter Reference

10:1 Probe

Safety

⚠ Max. Input Voltage 1000 V CAT II
600 V CAT III

⚠ Max. Floating Voltage
from any terminal to ground..... 1000 V CAT II
600 V CAT III
up to 400 Hz

Electrical specifications

Input Impedance at probe tip 10 MΩ (±2 %)/14 pF (±2 pF)
Capacity Adjustment Range 10 to 22 pF
Attenuation at DC (1 MΩ input) 10 x (±2 %)
Bandwidth (with FLUKE 199)..... DC to 200 MHz (-3 dB)

Environmental

Temperature
Operating 0 to 50 °C (32 to 122 °F)
Storage..... -20 to +60 °C (-4 to +140 °F)

Altitude
Operating 3 km (10 000 feet)
Storage..... 12 km (40 000 feet)

Humidity
Operating at 10 to 30 °C (50 to 86 °F)..... 95 %

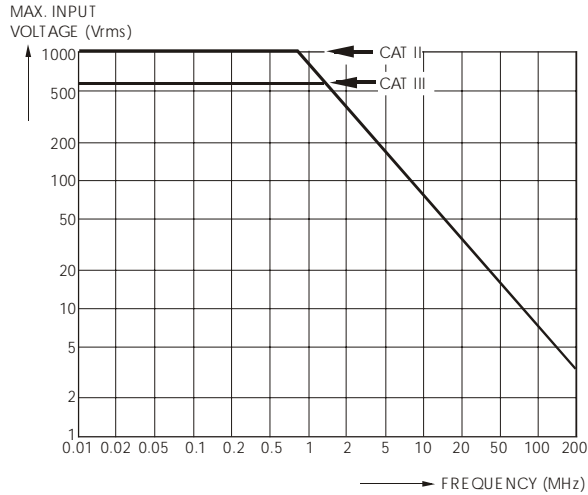

Figure 53. Max. Voltage From Probe Tip to Ground and From Probe Tip to Probe Reference

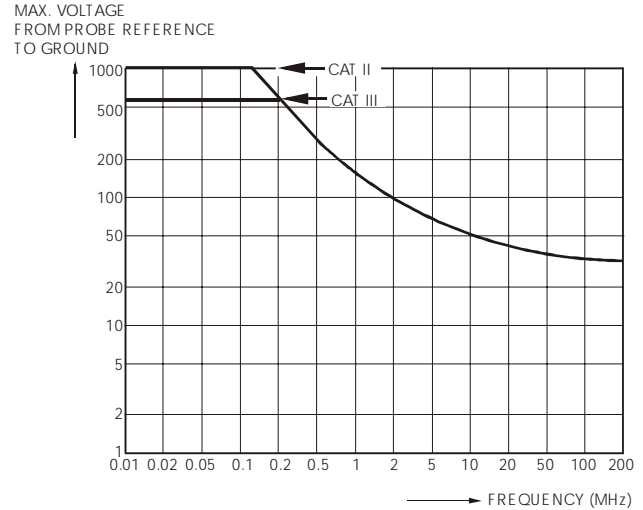

Figure 54. Safe Handling: Max. Voltage From Probe Reference to Ground

Electromagnetic Immunity

The Fluke 190 series, including standard accessories, conforms with the EEC directive 89/336 for EMC immunity, as defined by EN-61326-1, with the addition of the following tables.

Scope Mode (10 ms/div): Trace disturbance with VPS200 voltage probe shorted

Table 1

No visible disturbance	E = 3V/m
Frequency range 10 kHz to 20 MHz	5 mV/div to 100 V/div
Frequency range 20 MHz to 100 MHz	100 mV/div to 100 V/div
Frequency range 100 MHz to 1 GHz	500 mV/div to 100 V/div ^{*)}

(*) With the 20 MHz Bandwidth Filter switched on: no visible disturbance.
 With the 20 MHz Bandwidth Filter switched off: disturbance is max 2 div.

Table 2

Disturbance less than 10% of full scale	E = 3V/m
Frequency range 20 MHz to 100 MHz	10 mV/div to 50 mV/div

Test Tool ranges not specified in tables 1 and 2 may have a disturbance of more than 10% of full scale.

Meter Mode (Vdc, Vac, Vac+dc, Ohm and Continuity): Reading disturbance with test leads shorted

Table 3

Disturbance less than 1% of full scale	E = 3V/m
Frequency range 10 kHz to 1 GHz	500mV to 1000V , 500Ohm to 30 MOhm ranges

Index

—Numerics—

10-1 Voltage Probe, 81
2-mm Test Probes, 3, 82
4-mm Test Probes, 3, 81

—A—

Accessories, 65, 80
AC-Coupling, 18
Acquiring the Waveform, 18
Altitude, 99, 101
Ampere Measurement, 23
Amperes, 92, 96
Analysis Functions, 35, 97
AS200 Accessory Set, 3, 82
Auto Ranges, 25
Auto Set, 90

Automatic Connect-and-View
Trigger, 89
Automatic Power Shutdown, 73
Automatic Scope Measurements, 13
Automatic Triggering, 46
Average, 15
A+B, 19
A-B, 19
A*B, 19
A versus B, 19

—B—

Banana Jack Inputs, 10, 21, 28
Bandwidth, 88, 94
Bargraph, 22
Battery
Charger, 3, 81

Charging, 2, 76
Indicator, 76
Life, 73
Refresh, 77
Refresh Date, 80
Replacing, 78
BC190 Battery Charger, 3, 81

—C—

C190 Hard Case, 3, 84
C195 Soft Case, 84
Calibrating the Test Tool, 80
Calibrating Voltage Probes, 78, 98
Calibration, 98
Capturing 100 Screens, 37, 90
Case, 84
Charge Time, 97

Charger, 81
Charging, 76
Cleaning, 75
Clear Menu, 10, 70
Common Leads, 3
Connect-and-View, 43, 90
Connecting a Computer, 61
Connecting A Printer, 62
Connections, 10, 21
Continuity, 94
Contrast, 71
CS20MA Current Shunt, 84
Current Measurement, 23
Current Probe, 23
Current Shunt, 84
Cursors Measurements, 40

—D—

Date, 72
DC Voltage (VDC), 90, 95
Decibel (dB), 93
Delay, Trigger, 89
Deleting Screens, 59
Diode, 95
Display, 97
Displaying Recorded Data, 29, 32
DMM Measurements, 22
Documenting Screens, 61

Duty Cycle, 92

—E—

Earth Ground, 6
Edge Trigger, 47, 89
Electrical Shock, 5
Electrically Floating, 6
Electromagnetic Compatibility, 1, 99
Electronic Scope Connections, 66
Emission, 99
Environmental, 99
Environmental Data, 87
External Trigger, 89
External Triggering, 50

—F—

FlukeView, 61, 84
Freezing the Readings, 25
Freezing the Screen, 14
Frequency (Hz), 92
Frequency Response, 88, 94

—G—

Glitch Capture, 17, 32, 33
Ground Leads, 3, 81
Ground Spring, 3, 81

—H—

Hard Case, 3, 84
HF Voltage Probe Connection, 66
Hook Clips, 3, 81
Horizontal Cursors, 40
Humidity, 99
Hz, 92

—I—

Immunity, 99
Information Language, 71
Input A Measurement, 13
Input B Measurement, 13
Input Coupling, 94
Input Impedance, 88, 94, 101
Interface, 98
Inverted Display, 18
Isolated, 6

—L—

Language, 71

—M—

Maintenance, 75
Manual, 83
Manual Ranges, 25
Mathematics Functions, 19

Max. Floating Voltage, 100, 101
Max. Input Voltage, 100
Measurement Connections, 10, 21
Measurements, 13, 22
Measurements on Meter Inputs, 94
Mechanical, 98
Memory, 98
Meter Connections, 67
Meter Measurements, 22
Multi Meter Measurements, 22

—N—

Navigating a Menu, 9
NiMH Battery, 75, 76
Noisy Waveforms, 19, 48

—O—

Ohm (Ω), 94
Operating Time, 97
Optical Interface, 61, 62, 98
Oscilloscope, 88

OVERVIEW, 39

—P—

PAC91, 62, 84
Parallel Print Cable, 84
Parallel Printer, 62

Parts, 80
Peak, 92
Performance Characteristics, 87
Persistence, 16
Phase, 93
PM9080, 61, 62, 84
Polarity, 18
Power, 97
Power Adapter, 73, 81
Power Down Timer, 73
Powering the Test Tool, 7
Pre Trigger, 45
Print Cable, 84
Probe, 78
Probe Calibration, 78, 98
Product Registration Card, 3
Pulse Trigger, 53
Pulse Width, 92
Pulse Width Trigger, 90

—R—

Readings, 13
Recalibrating, 80
Recalling Screens, 59
Recalling Setups, 60
Record Length, 89
Record+Setup Memory, 58
Recorder, 96

Recorder Options, 30
Recording Waveforms, 31
Refreshing Batteries, 80
Relative Measurements, 26
Replaceable Parts, 80
Replacement Set, 83
Replacing Batteries, 78
Replay, 35, 58, 97
Resetting the Test Tool, 8, 70
Resistance Measurement, 22
Reversing the Polarity, 18
Rise Time, 42, 88
RMS Voltage, 91
Roll Mode Function, 96
RS200 Replacement Set, 83
RS-232 Adapter/Cable, 3, 61, 62, 84

—S—

Safety, 100
Safety Characteristics, 87
Safety Requirements, 1
Sampling Rate, 88
Saving, 58
SCC 190, 61, 84
Scope, 88
Scope Connections, 11, 66
Scope Cursor Measurements, 97
Scope Measurements, 13

Fluke 192/196/199

Users Manual

Scope Record, 31, 96
Screen Contrast, 71
Screen Without Menus, 10, 70
Serial Printer, 62
Service Manual, 84
Shock, 99
Single Shot, 48
Single Sweep Mode, 32
Slope, 44, 89
Slow Variations, 28
Smooth, 15
Soft Case, 84
Software, 3, 84
Software Version, 80

Specifications, 87
Spike Capture, 17
Stand, 70
Storing, 75
SW90W Software, 3, 61, 84

—T—

Temperature, 93, 95, 99, 101
Test Leads, 3
Test Probes, 3, 81
Tilt Stand, 70
Time, 72
Time Base Accuracy, 89
TL24 Test Leads, 82
TrendPlot™ Function, 28
TrendPlot (Meter), 96
Trigger
 Delay, 45, 89
 Level, 44
 Modes, 89
 Pre-trigger, 45
Trigger Sensitivity, 89
Triggering
 Automatic, 46, 89
 External, 50
 On Edges, 47
 On Pulses, 53
 On Video, 51

 On Waveforms, 43
Troubleshooting, 85
TV Triggering, 51

—U—

Unpacking, 2
Users Manual, 3, 83

—V—

Vertical Accuracy, 88
Vertical Cursors, 41
Vibration, 99
Video Frames, 52
Video Lines, 52
Video Trigger, 51, 89
Viewing Stored Screens, 60
Voltage Probes, 3, 78, 81
VPS200 Voltage Probe Set, 3

—Z—

Zoom, 38, 97