

**FLUKE®**

**45**

Dual Display Multimeter

Users Manual

PN 855981

January 1989, Rev. 4, 7/97

© 1999 Fluke Corporation, All rights reserved. Printed in USA  
All product names are trademarks of their respective companies.

## **LIMITED WARRANTY & LIMITATION OF LIABILITY**

Each Fluke product is warranted to be free from defects in material and workmanship under normal use and service. The warranty period is one year and begins on the date of shipment. Parts, product repairs and services are warranted for 90 days. This warranty extends only to the original buyer or end-user customer of a Fluke authorized reseller, and does not apply to fuses, disposable batteries or to any product which, in Fluke's opinion, has been misused, altered, neglected or damaged by accident or abnormal conditions of operation or handling. Fluke warrants that software will operate substantially in accordance with its functional specifications for 90 days and that it has been properly recorded on non-defective media. Fluke does not warrant that software will be error free or operate without interruption.

Fluke authorized resellers shall extend this warranty on new and unused products to end-user customers only but have no authority to extend a greater or different warranty on behalf of Fluke. Warranty support is available if product is purchased through a Fluke authorized sales outlet or Buyer has paid the applicable international price. Fluke reserves the right to invoice Buyer for importation costs of repair/replacement parts when product purchased in one country is submitted for repair in another country.

Fluke's warranty obligation is limited, at Fluke's option, to refund of the purchase price, free of charge repair, or replacement of a defective product which is returned to a Fluke authorized service center within the warranty period.

To obtain warranty service, contact your nearest Fluke authorized service center or send the product, with a description of the difficulty, postage and insurance prepaid (FOB Destination), to the nearest Fluke authorized service center. Fluke assumes no risk for damage in transit. Following warranty repair, the product will be returned to Buyer, transportation prepaid (FOB Destination). If Fluke determines that the failure was caused by misuse, alteration, accident or abnormal condition of operation or handling, Fluke will provide an estimate of repair costs and obtain authorization before commencing the work. Following repair, the product will be returned to the Buyer transportation prepaid and the Buyer will be billed for the repair and return transportation charges (FOB Shipping Point).

**THIS WARRANTY IS BUYER'S SOLE AND EXCLUSIVE REMEDY AND IS IN LIEU OF ALL OTHER WARRANTIES, EXPRESS OR IMPLIED, INCLUDING BUT NOT LIMITED TO ANY IMPLIED WARRANTY OF MERCHANTABILITY OR FITNESS FOR A PARTICULAR PURPOSE. FLUKE SHALL NOT BE LIABLE FOR ANY SPECIAL, INDIRECT, INCIDENTAL OR CONSEQUENTIAL DAMAGES OR LOSSES, INCLUDING LOSS OF DATA, WHETHER ARISING FROM BREACH OF WARRANTY OR BASED ON CONTRACT, TORT, RELIANCE OR ANY OTHER THEORY.**

Since some countries or states do not allow limitation of the term of an implied warranty, or exclusion or limitation of incidental or consequential damages, the limitations and exclusions of this warranty may not apply to every buyer. If any provision of this Warranty is held invalid or unenforceable by a court of competent jurisdiction, such holding will not affect the validity or enforceability of any other provision.

Fluke Corporation  
P.O. Box 9090  
Everett, WA 98206-9090  
U.S.A.

Fluke Europe B.V.  
P.O. Box 1186  
5602 BD Eindhoven  
The Netherlands

### **Safety Class**

This is an IEC safety class 1 (grounded enclosure) product. For safety, the ground wire in the line cord must be connected when operating from AC power.

When operated from the optional battery pack, this product meets the safety requirements for a safety class 2 (reinforced insulation) product and does not require grounding for safety.

### **Interference Information**

This equipment generates and uses radio frequency energy and if not installed and used in strict accordance with the manufacturer's instructions, may cause interference to radio and television reception. It has been type tested and found to comply with the limits for a Class B computing device in accordance with the specifications of Part 15 of FCC Rules, which are designed to provide reasonable protection against such interference in a residential installation.

Operation is subject to the following two conditions:

- This device may not cause harmful interference.
- This device must accept any interference received, including interference that may cause undesired operation.

There is no guarantee that interference will not occur in a particular installation. If this equipment does cause interference to radio or television reception, which can be determined by turning the equipment off and on, the user is encouraged to try to correct the interference by one of more of the following measures:

- Reorient the receiving antenna
- Relocate the equipment with respect to the receiver
- Move the equipment away from the receiver
- Plug the equipment into a different outlet so that the computer and receiver are on different branch circuits

If necessary, the user should consult the dealer or an experienced radio/television technician for additional suggestions. The user may find the following booklet prepared by the Federal Communications Commission helpful: How to Identify and Resolve Radio-TV Interference Problems. This booklet is available from the U.S. Government Printing Office, Washington, D.C. 20402. Stock No. 004-000-00345-4.

### **Declaration of the Manufacturer or Importer**

We hereby certify that the Fluke Model 45 Dual Display MultiMeter is in compliance with BMPT Vfg 243/1991 and is RFI suppressed. The normal operation of some equipment (e.g. signal generators) may be subject to specific restrictions. Please observe the notices in the users manual. The marketing and sales of the equipment was reported to the Central Office for Telecommunication Permits (BZT). The right to retest this equipment to verify compliance with the regulation was given to the BZT.

# Table of Contents

Chapter	Title	Page
<b>1</b>	<b>Introduction .....</b>	<b>1-1</b>
	Introducing the Fluke 45 Dual Display Multimeter.....	1-1
	Options and Accessories .....	1-2
	Where to go from Here .....	1-2
<b>2</b>	<b>Getting Started .....</b>	<b>2-1</b>
	Introduction.....	2-1
	Getting Started .....	2-1
	Unpacking and Inspecting the Meter .....	2-1
	Front Panel and Rear Panel .....	2-1
	Adjusting the Handle .....	2-1
	Line Power.....	2-1
	Turning the Meter on .....	2-3
	Using the Pushbuttons.....	2-3
	Selecting a Measurement Range .....	2-5
	Automatic Input Terminal Selection.....	2-5
	Taking Some Basic Measurements .....	2-5
	Measuring Voltage, Resistance, or Frequency .....	2-6
	Measuring Current.....	2-6
	Diode/Continuity Testing .....	2-6
	Operating the Meter Under Battery Power (Optional).....	2-9
	Rack Mounting.....	2-9
<b>3</b>	<b>Operating the Meter From the Front Panel .....</b>	<b>3-1</b>
	Introduction.....	3-1
	Front Panel Operations .....	3-1
	Display .....	3-2
	Primary Display.....	3-2
	Secondary Display.....	3-2
	Input Terminals.....	3-4
	Selecting a Measurement Function .....	3-5
	Ranging .....	3-5
	Autoranging .....	3-5
	Manual Ranging .....	3-8

Measuring Frequency.....	3-8
Frequency Ranging.....	3-8
Frequency Measurement Rates.....	3-9
Measuring Frequency of Current (100 mA and 10A) Inputs.....	3-9
Frequency Sensitivity Selection .....	3-9
Selecting A Function Modifier .....	3-10
REL (Relative Readings) Modifier.....	3-11
dB (Decibels and Audio Power) Modifier.....	3-12
HOLD (Touch Hold) Modifier .....	3-13
MN MX (Minimum Maximum) Modifier.....	3-13
Using Function Modifiers in Combination.....	3-13
Selecting A Measurement Rate (Rate) .....	3-14
Using the <i>(2ND)</i> Button .....	3-14
Using The Compare (Comp) Function.....	3-16
The List and Number Editors .....	3-16
Using the List Editor .....	3-17
Using the Number Editor.....	3-18
Power-Up Configuration.....	3-19
Factory Settings of Power-Up Configuration .....	3-19
Changing the Power-Up Configuration .....	3-19
Calibration .....	3-20
<b>4 Applications.....</b>	<b>4-1</b>
Introduction.....	4-1
Using the Dual Display .....	4-1
Using Measurement Functions in Combination .....	4-2
Taking Voltage and Current Measurements Using the Dual Display .....	4-2
Response Times .....	4-4
How the Meter Makes Dual Display Measurements .....	4-5
Updating the Primary and Secondary Displays with a Single Measurement .....	4-5
Updating the Primary and Secondary Displays with Separate Measurements .....	4-5
Update Rate in the Dual Display Mode .....	4-7
External Trigger .....	4-7
Thermal Voltages.....	4-8
When Measuring Resistance.....	4-9
Two-Wire Configuration .....	4-9
Correcting for Test Lead Resistance .....	4-9
True RMS Measurements .....	4-9
Effects of Internal Noise in AC Measurements .....	4-10
Calculated (AC + DC) RMS Measurements .....	4-10
Waveform Comparison (True RMS vs. Average-Responding Meters) .....	4-10
<b>5 Operating the Meter Using the Computer Interface .....</b>	<b>5-1</b>
Introduction.....	5-1
Local and Remote Operations .....	5-1
Preparing the Meter for Operations via the RS-232 Interface .....	5-2
Setting Communication Parameters (RS-232).....	5-2
RS-232 Print-Only Mode.....	5-3
Cabling the Meter to a Host or Printer (RS-232).....	5-4
Character Echoing and Deletion.....	5-4
Device Clear Using ^C (CNTRL C).....	5-4
RS-232 Prompts.....	5-4
Preparing the Meter to be Operated via IEEE-488 Interface .....	5-5
IEEE-488 Operating Limitations.....	5-5

Installing the IEEE-488 Interface .....	5-5
Enabling the IEEE-488 Interface .....	5-5
Addressing the Meter .....	5-5
Cabling the Meter to a Host .....	5-6
Getting Started With An Installation Test .....	5-6
Installation Test for RS-232 Operations .....	5-6
Installation Test for IEEE-488 Operations .....	5-6
If Test Fails .....	5-7
How the Meter Processes Input .....	5-7
Input Strings .....	5-7
Input Terminators .....	5-7
Typical IEEE-488 Input Strings .....	5-8
Sending Numeric Values to the Meter .....	5-8
Sending Command Strings to the Meter .....	5-8
How the Meter Processes Output .....	5-11
Triggering Output .....	5-11
External Triggering from the Front Panel .....	5-11
Setting the Trigger Type Configuration .....	5-12
External Triggering via the Computer Interface .....	5-12
Service Requests (IEEE-488 Only and Status Registers) .....	5-13
Event Status and Event Status Enable Registers .....	5-16
Status Byte Register .....	5-17
Reading the Status Byte Register .....	5-17
Service Request Enable Register .....	5-18
Computer Interface Command Set .....	5-19
IEEE-488 Capabilities and Common Commands .....	5-19
Function Commands and Queries .....	5-22
Function Modifier Commands and Queries .....	5-22
Range and Measurement Rate Commands and Queries .....	5-25
Measurement Queries .....	5-26
Compare Commands and Queries .....	5-27
Trigger Configuration Commands .....	5-27
Miscellaneous Commands and Queries .....	5-28
RS-232 Remote/Local Configurations .....	5-29
Sample Program Using the RS-232 Computer Interface .....	5-30
Sample Programs Using the IEEE-488 Computer Interface .....	5-31

**6 Maintenance..... 6-1**

Introduction .....	6-1
Cleaning .....	6-1
Line Fuse .....	6-1
Current Input Fuses .....	6-2
Testing Current Input Fuses .....	6-2
Replacing the 100 mA Input Fuse .....	6-3
Replacing the 10 A Input Fuse .....	6-3
Self-Test Diagnostics and Error Codes .....	6-4
Performance Tests .....	6-4
Service .....	6-5
Replacement Parts .....	6-7

**Appendices**

A Specifications .....	A-1
B ASCII/IEEE-488 Bus Codes .....	B-1
C IEEE-488.2 Device Documentation Requirements .....	C-1

# List of Tables

Table	Title	Page
1-1.	Accessories.....	1-2
3-2.	Voltage Ranges and Full Scale Values.....	3-6
3-3.	Current Ranges and Full Scale Values.....	3-7
3-4.	Ohms Ranges and Full Scale Values.....	3-7
3-5.	Frequency Ranges and Full Scale Values (Slow and Medium*).....	3-7
3-6.	Frequency Measurement Rates.....	3-9
3-7.	Maximum Sinewave Inputs for Frequency Measurements.....	3-10
3-8.	Reference Impedances in Ohms.....	3-12
3-9.	Display Measurement Rates for Single Function Measurements.....	3-14
3-10.	[2ND] Button Operations.....	3-15
3-11.	Options Available Through List Editor.....	3-18
3-12.	Number Editor Options.....	3-18
3-13.	Power-Up Configuration Set at Factory.....	3-20
4-1.	Sample Dual Display Applications.....	4-3
4-2.	Typical Single Measurement Response Times (in Seconds).....	4-6
4-3.	Typical Settling Delays (in Seconds).....	4-6
4-4.	Typical Measurement Intervals (in Seconds) for Dual Display Measurements.....	4-8
4-5.	Ohms Test Voltage.....	4-9
5-1.	Factory Settings of RS-232 Communication Parameters.....	5-2
5-2.	Approximate Print Rates in RS-232 Print-Only Mode.....	5-3
5-5.	Status Register Summary.....	5-14
5-6.	Description of Bits in ESR and ESE.....	5-17
5-7.	Description of Bits in the Status Byte Register*.....	5-18
5-8.	IEEE-488 Interface Function Subsets.....	5-20
5-9.	IEEE-488 Common Commands.....	5-20
5-11.	Function Commands and Queries.....	5-22
5-12.	Function Modifier Commands and Queries.....	5-23
5-13.	Range and Measurement Rate Commands and Queries.....	5-25
5-14.	Measurement Queries.....	5-26
5-15.	Compare Commands and Queries.....	5-27
5-16.	Trigger Configuration Commands.....	5-27
5-17.	Miscellaneous Commands and Queries.....	5-28
5-18.	Remote/Local Configuration Commands.....	5-29
6-1.	Self-Test Error Codes.....	6-4
6-2.	Performance Tests for Volts, Diode Test, Ohms, and Frequency, Functions.....	6-5

6-3.	Performance Tests for mA Current Functions .....	6-7
6-4.	Performance Tests for A Current Functions.....	6-7
6-5.	Replacement Parts .....	6-7



# List of Figures

Figure	Title	Page
2-1.	Front Panel .....	2-2
2-2.	Rear Panel .....	2-2
2-3.	Adjusting Handle.....	2-3
2-4.	Summary of Basic Pushbutton Operations.....	2-4
2-5.	Measuring Voltage, Resistance, or Frequency .....	2-7
2-6.	Measuring Current or Frequency .....	2-7
2-7.	Continuity Testing.....	2-8
2-8.	Diode Testing .....	2-8
3-1.	Primary Display.....	3-2
3-2.	Display Annunciators .....	3-3
3-3.	Secondary Display.....	3-3
3-4.	Input Terminals .....	3-4
3-5.	Function Selection Buttons .....	3-6
3-6.	Range Selection Buttons .....	3-8
3-7.	Function Modifier Selection Buttons .....	3-11
4-1.	Dual Display Showing Volts AC and Frequency.....	4-2
4-2.	DC Voltage and DC Current Measurement on Input Signal .....	4-4
4-3.	Waveform Comparison Chart .....	4-11
5-1.	Typical IEEE-488 Input Strings .....	5-10
5-2.	External Trigger Using Receive Pin (RX) of RS-232 Interface.....	5-13
5-3.	Overview of Status Data Structures .....	5-15
5-4.	Event Status and Event Status Enable Registers .....	5-16
5-5.	Sample Program for RS-232 Computer Interface .....	5-31
5-6.	Sample Programs for IEEE-488 Computer Interface.....	5-32
6-1.	Replacing the Line Fuse.....	6-2
6-2.	Replacing the 100mA Input Fuse.....	6-3

# Chapter 1

## Introduction

### **Introducing the Fluke 45 Dual Display Multimeter**

#### *Note*

*This manual contains information and warnings that must be followed to ensure safe operation and retain the meter in safe condition.*

#### **⚠ Warning**

**To avoid electric shock or injury, read the "multimeter safety" sheet preceding Chapter 2 before using the meter.**

The Fluke 45 Dual Display Multimeter (also referred to as "the meter") is a 4<sup>1</sup>/<sub>2</sub>-digit (30,000 count) meter with a 5-digit (100,000 count) high resolution mode. The meter is designed for bench-top, field service, and system applications. Complete specifications are provided in Appendix A.

With the (optional) IEEE-488 computer interface installed, the meter is fully programmable for use on the IEEE Standard 488.1 interface bus(1987). The meter is also designed in compliance with supplemental standard IEEE-488.2 (1987).

Some features provided by the meter are:

- A dual, vacuum fluorescent, display that allows two properties of an input signal to be displayed at the same time. (e.g., ac voltage in one display and frequency in the other).
- Remote operation via the RS-232 interface (included) or the IEEE-488 interface (optional).
- True rms ac
- (AC + DC) rms, calculated
- Frequency measurements to greater than 1 MHz
- 1  $\mu$ V sensitivity in volts dc
- Decibels with variable reference impedance and audio power measurement capability.
- A compare mode to determine if a measurement is within, above, or below a designated range.

- 100,000, 30,000, and 3,000 selectable count resolution, with display reading speeds of 2.5, 5, and 20 readings per second (rps), respectively.
- Built-in self-tests with closed-case calibration (no internal calibration adjustments).

## Options and Accessories

Two options are available. These options can be installed in the meter at the factory or by the customer on site:

- The IEEE-488 Interface (Option -O5K) provides full programmability, and automated calibration. The IEEE-488 computer interface command set is identical to the RS-232 interface commands wherever possible.
- The Battery Kit (Option -01 K) consists of a rechargeable, 8 V, lead-acid battery, with battery bracket and charger assembly. The battery has a typical operating time of eight hours and is fully operable at ambient temperatures between 0 and 50 °C. For complete battery specifications, refer to Appendix A.

Available accessories are listed and described in Table 1-1.

**Table 1-1. Accessories**

Model	Description
C40	Soft carrying case. Provides padded protection for the meter. Includes a pocket for the manual and pouch for the test leads and line cord.
M00-200-634	Rackmount Kit. Allows meter to be mounted on either the right or left side of a standard 19-inch rack.
RS40	RS-232 terminal interface cable. Connects the Fluke 45 to any terminal or printer with properly configured DTE connector (DB-25 socket), including an IBM PC <sup>®</sup> , IBM PC/XT <sup>®</sup> or IBM PS/2 (models 25, 30, 50, P60, 70, and 80).
RS41	RS-232 modem cable. Connects the Fluke 45 to a modem with properly configured DB-25 male pin connector.
S45	QuickStart <sup>™</sup> , a PC software package, simplifies operation of the Fluke 45 when using the RS-232 computer interface. Readings are recorded in files that can be accessed by Lotus 1-2-3 <sup>®</sup> , dBase III <sup>®</sup> and other graphics packages.
Y8021	Shielded IEEE-488 one-meter (39.4 inches) cable, with plug and jack at each end.
Y8022	Shielded IEEE-488 two-meter (78.8 inches) cable, with plug and jack at each end.
Y8023	Shielded IEEE-488 four-meter (13 feet) cable, with plug and jack at each end.

## Where to go from Here

This manual has been organized to assist you in getting started quickly. It is not necessary for you to read the entire manual before using the meter effectively. However, we recommend that you do so in order to use your meter to its full advantage.

Begin by scanning the Table of Contents to familiarize yourself with the organization of the manual. Then, read Chapter 2, "GETTING STARTED". Refer to the appropriate chapter of the manual as needed. The contents of each chapter are summarized below.

### Chapter 1: Introduction

Introduces the Fluke 45 Dual Display Multimeter, describing its features, options, accessories, and users manual.

**Chapter 2: Getting started**

Explains how to prepare the meter for operation and get started quickly taking basic measurements from the front panel.

**Chapter 3: Operating the meter from the front panel**

Provides a complete description of each operation that can be performed using the push-buttons on the front panel. Chapter 3 is organized so that related operations and functions are grouped together.

**Chapter 4: Applications**

Describes how to use the meter in more advanced operations and sophisticated applications. Assumes a basic knowledge of the meter and front panel operations.

**Chapter 5: Operating the Meter using the Computer Interface**

Describes how to connect the meter to a terminal or host and operate it via the RS-232-C or (optional) IEEE-488 interface. Assumes a basic knowledge of the meter and front panel operations.

**Chapter 6: Maintenance**

Describes how to perform basic maintenance and repairs (e.g., replacing fuses) and how to order replacement parts. Complete service and repair procedures are contained in the "Fluke 45 Dual Display Multimeter Service Manual" (P/N 856042).

**Appendices**

- A. Specifications
- B. ASCII/ IEEE-488 Bus Codes
- C. IEEE-488.2 Device Documentation Requirements



# MULTIMETER SAFETY

The Fluke 45 Dual Display Multimeter has been designed and tested according to IEC Publication 348, Safety Requirements for Electronic Measuring Apparatus. This manual contains information and warnings which must be followed to ensure safe operation and retain the meter in safe condition. Use of this equipment in a manner not specified herein may impair the protection provided by the equipment.

The meter is designed for IEC 664, Installation Category II use. It is designed for use in circuits with a VA rating of <4800 VA.

Some common international electrical symbols used in this manual are shown below.

~	AC - ALTERNATING CURRENT	⚡	DANGEROUS VOLTAGE
≡	DC - DIRECT CURRENT	⏏	EARTH GROUND
⋈	EITHER AC OR DC CURRENT	⚠	SEE EXPLANATION IN MANUAL
⊞	FUSE	⊞	DOUBLE INSULATION FOR PROTECTION AGAINST ELECTRIC SHOCK

Before using the meter, read the following safety information carefully. In this manual, "**WARNING**," is reserved for conditions and actions that pose hazard(s) to the user; "**CAUTION**," is reserved for conditions and actions that may damage your meter.

## ⚠ WARNING TO AVOID ELECTRICAL SHOCK OR OTHER INJURY:

- Avoid working alone
- Follow all safety procedures for equipment being tested.
- Inspect the test leads for damaged insulation or exposed metal. Check test lead continuity. Damaged leads should be replaced.
- Be sure the meter is in good operating condition.
- Select the proper function for your measurement.
- To avoid electrical shock, use caution when working above 60V dc or 30V ac RMS.
- Disconnect the live test lead before disconnecting the common test lead.
- Disconnect the power and discharge high-voltage capacitors before testing in  $\Omega$  and  $\rightarrow$  (|)|).
- When making a current measurement, turn the circuit power off before connecting the meter in the circuit.
- Check meter fuses before measuring transformer secondary or motor winding current. (See Section 6, MAINTENANCE.) An open fuse may allow high voltage build-up, which is potentially hazardous.
- Use clamp-on probes when measuring circuits exceeding 10 amps.
- When servicing the meter, use only the replacement parts specified.
- Do not allow meter to be used if it is damaged or if its safety is impaired.

# Chapter 2

## Getting Started

### Introduction

Chapter 2 explains how to prepare the meter for operation, discusses general operating features, and walks you through the basics of taking some common measurements.

### Getting Started

#### Unpacking and Inspecting the Meter

Carefully remove the meter from its shipping container and inspect it for possible damage or missing items. If the meter is damaged or something is missing, contact the place of purchase immediately. Save the container and packing material in case you have to return the meter.

#### Front Panel and Rear Panel

The front panel (shown in Figure 2-1.) has three main elements: the input terminals on the left, the primary and secondary displays, and the pushbuttons. The pushbuttons are used to select major functions, ranging operations, and function modifiers. These elements are described in detail in Chapter 3.

The rear panel (shown in Figure 2-2) contains the power-line cord connector, an RS-232 interface connector, a cutout for the (optional) IEEE-488 interface connector, a serial number label, and a line fuse. (For fuse testing and replacement procedures, refer to Chapter 6.) *Rotate the rear feet 180 degrees before using the meter.*

#### Adjusting the Handle

For bench-top use, the handle can be positioned to provide two viewing angles. To adjust its position, pull the ends out to a hard stop (about 1/4-inch on each side) and rotate it to one of the four stop positions shown in Figure 2-3. To remove the handle, adjust it to the vertical stop position and pull the ends all the way out.

#### Line Power

##### **⚠Warning**

**To avoid shock hazard, connect the instrument power cord to a power receptacle with earth ground. A protective ground connection by way of the grounding conductor in the power cord is essential for safe operation.**

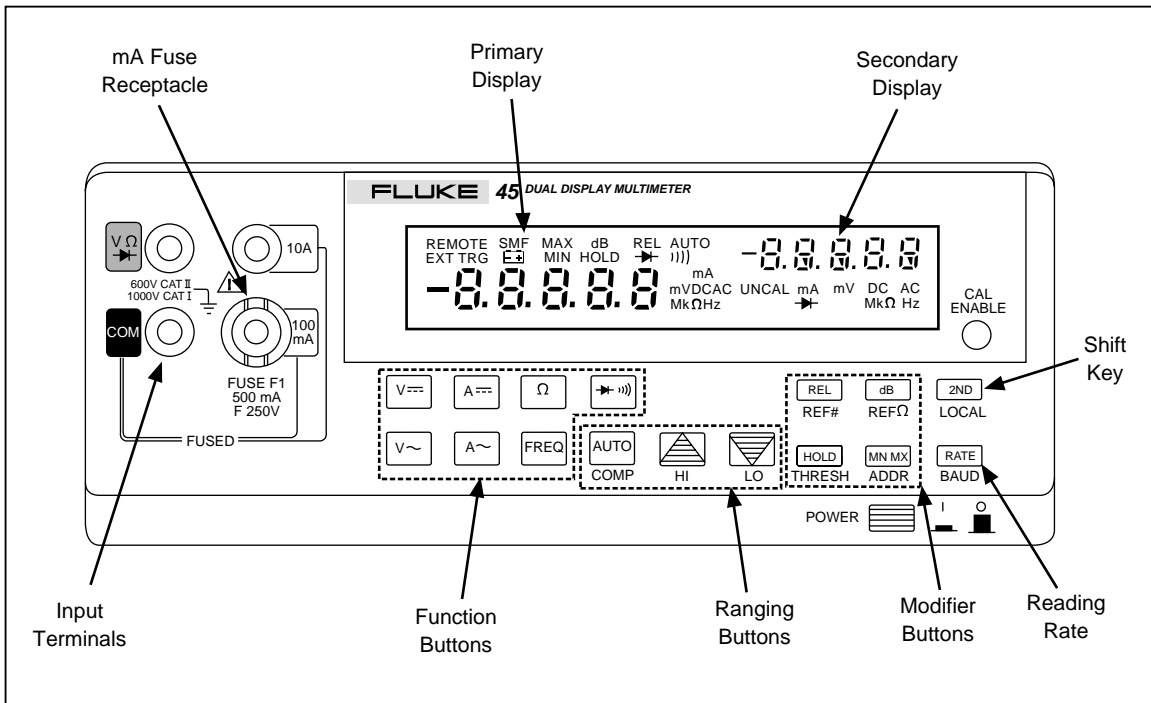
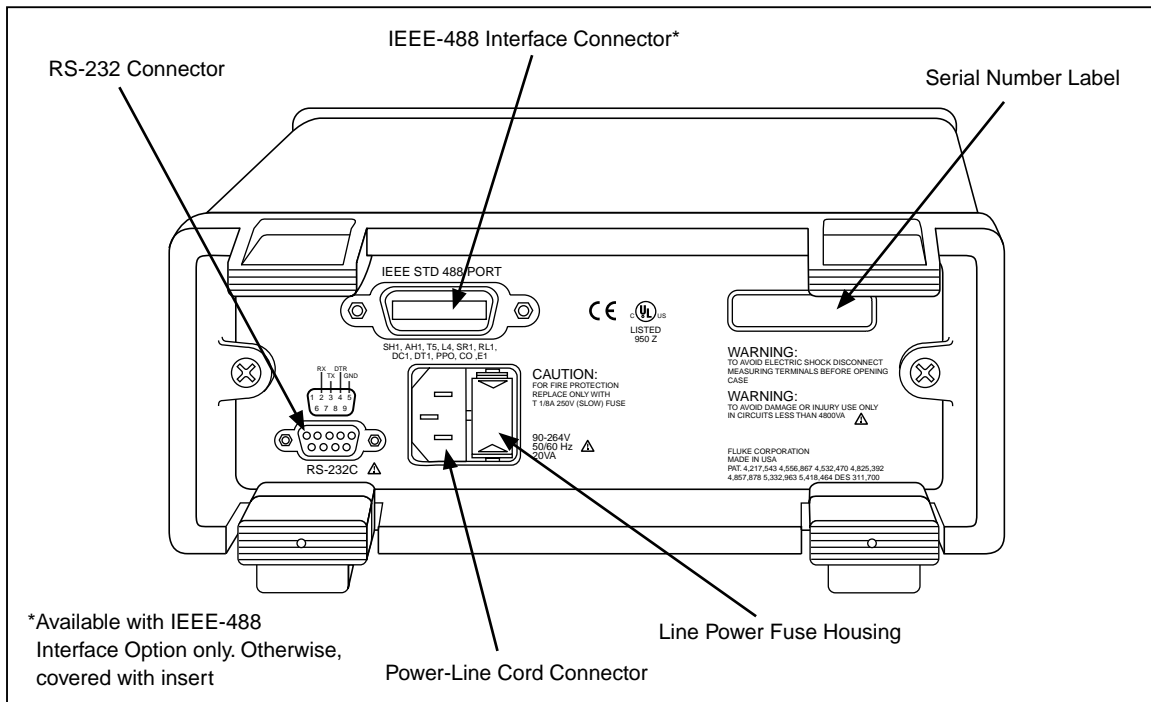

Figure 2-1. Front Panel

aam01f.eps



\*Available with IEEE-488 Interface Option only. Otherwise, covered with insert

Figure 2-2. Rear Panel

aam02f.eps



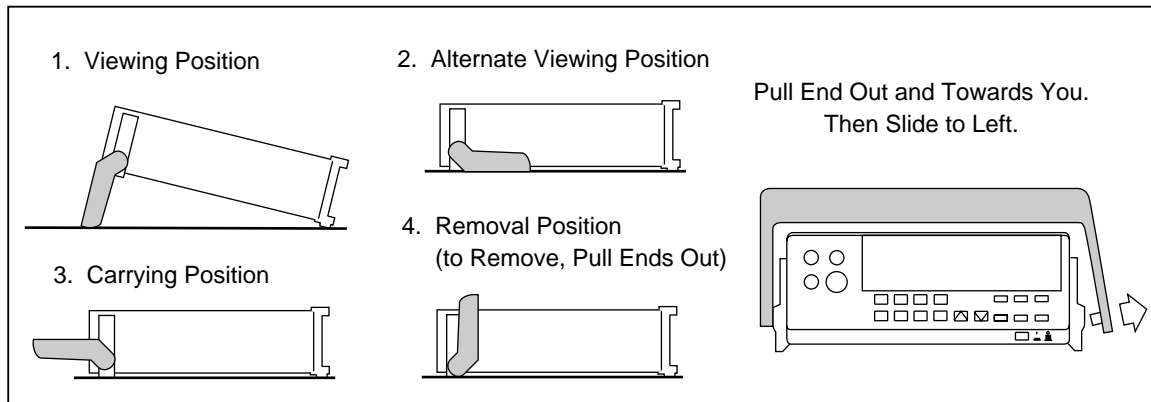

Figure 2-3. Adjusting Handle

aam03f.eps

If you have not already done so, plug the line cord into the connector on the rear of the meter. The meter will operate on any line voltage between 90 V ac and 264 V ac without adjustment, and any frequency between 45 and 440 Hz. However, it is only warranted to meet published specifications at 50/60 Hz.

## Turning the Meter on

To turn the meter on, press in the green, POWER button located on the lower-right of the front panel. If the meter is being operated under battery power and you turn the meter off, you must wait five seconds before turning the meter back on. If you do not, the meter will not power-up.

When the meter is turned on, the primary and secondary displays light for about 4 seconds while the instrument performs an internal self-test of its digital circuitry. These tests check RAM, ROM, A/D, calibration, and the display. The meter has passed all tests and is ready for normal operation if an error code is not displayed. However, if an error is detected, the meter will still attempt to operate. (Refer to "Self-Test Diagnostics and Error Codes" in Chapter 6.)

If any front panel button other than **AUTO** is held down while the power-up sequence is in progress, the entire display stays on until another button is pressed. Then, the powerup sequence continues.

After the meter completes the power-up sequence, it assumes the power-up measurement configuration stored in non-volatile memory. The power-up configuration set at the factory is shown in Table 3-13. (To change the power-up configuration, refer to "Changing the Power-Up Configuration" in Chapter 3.)

## Using the Pushbuttons

The pushbuttons on the front panel select meter functions and operations. A summary of basic pushbutton operations is shown in Figure 2-4.

Pushbuttons can be used in three ways. You can:

- Press a single button to select a function or operation.  
EXAMPLE: Press **V~** to select volts ac for the primary display.
- Press a combination of buttons, one after the other.

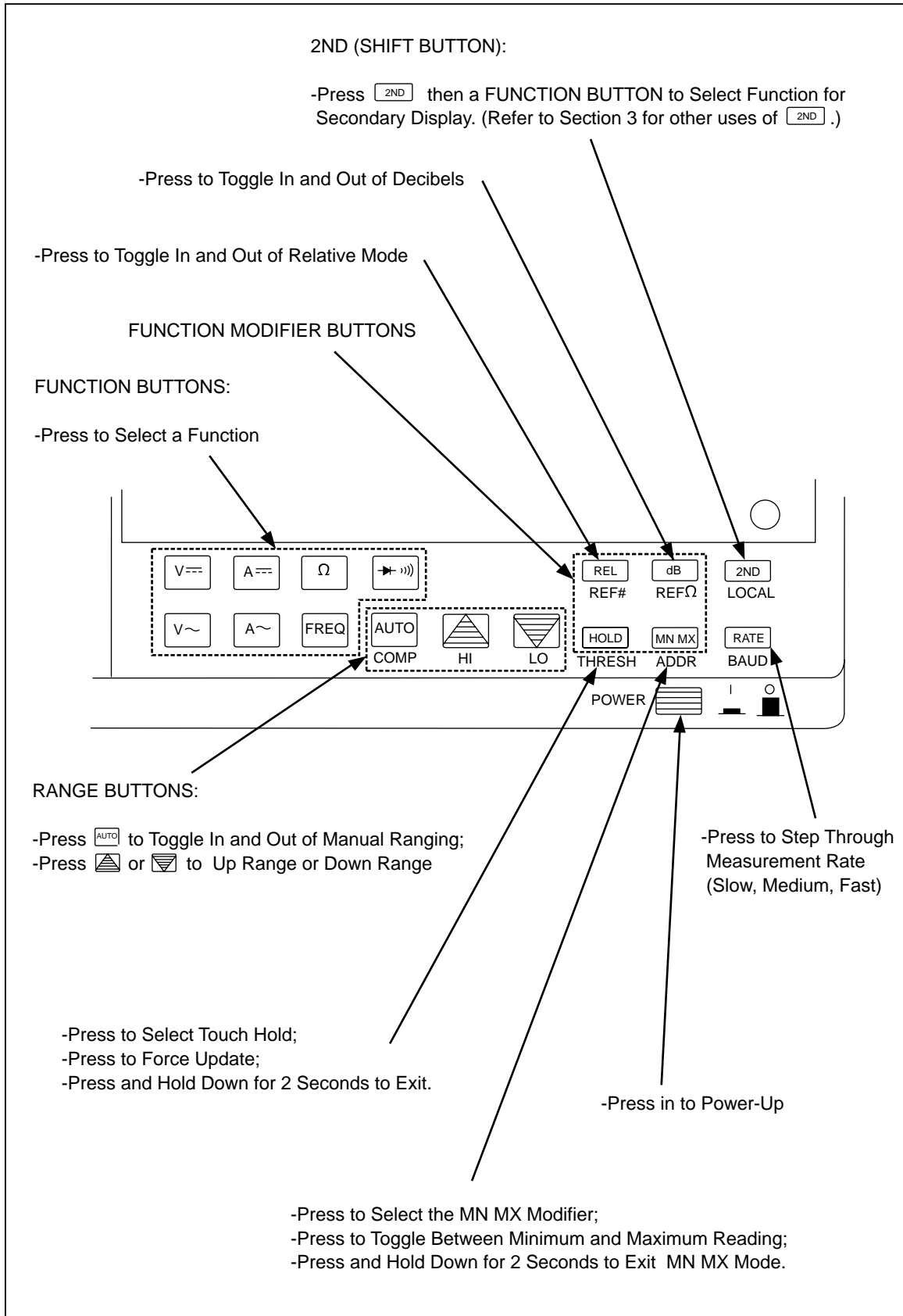





Figure 2-4. Summary of Basic Pushbutton Operations

aam04f.eps

EXAMPLE: Press  to select volts ac for the primary display, then press  to select the decibels modifier.





- Press multiple buttons simultaneously.

EXAMPLE: Press  and  simultaneously to select true rms volts ac + volts dc (calculated) in the primary display.

For more details on the uses of each button, refer to Chapter 3, "OPERATING THE METER FROM THE FRONT PANEL."

## Selecting a Measurement Range



Measurement ranges can be selected automatically by the meter in "autorange" or manually by the user. In the autorange mode, the meter selects the appropriate range for the measurement reading.

To manually select a range, press  to toggle in (and out) of the manual ranging mode, or press  or . In the manual range mode, press  or  to up range or down range to the desired range. For more details on ranging, refer to "Ranging" in Chapter 3.

## Automatic Input Terminal Selection

If current (ac or dc) is being measured in the autorange mode and there is no input on the 100 mA terminal, the meter switches automatically between the 100 mA and 10 A input terminals looking for a signal. A front panel annunciator indicates that the meter is in the mA range while the meter attempts to select the correct input terminal.

When a signal is detected at either input terminal, the display updates with the measurement results. If an input signal is not found on either input terminal, a measurement is taken on the mA terminal.

Automatic input terminal selection is disabled when the meter is in the manual ranging mode. Use the  and  buttons to select the appropriate current input terminal and range.

## Taking Some Basic Measurements

### Warning

**Read "Multimeter Safety" before operating this meter.**

The following procedures describe the basics of taking common measurements from the front panel. These procedures are provided for the user who needs to get started quickly, but does not want to read the rest of the manual at this time. However, in order to take full advantage of your meter, you should read the remainder of this manual carefully and completely.

### Warning

**To avoid electrical shock or damage to the meter, do not apply more than the rated voltage between any terminal and earth ground. The meter is protected against overloads up to the limits shown in Table 3-1. Exceeding these limits poses a hazard to the meter and operator.**

### Measuring Voltage, Resistance, or Frequency

To measure voltage, resistance, or frequency, press the desired function button and connect the test leads as shown in Figure 2-5. The meter will select the appropriate range in the autorange mode, and an annunciator on the display will indicate measurement units.

#### Note

*After measuring high voltage to 1000 V dc, errors may occur when making measurements with 1 to 10  $\mu$ V resolution. Allow up to two minutes prior to making low-level measurements.*

### Measuring Current

To measure current, insert the test leads in the 100 mA input terminal for currents up to 100 mA or in the 10 A input terminal for higher current. Press  $\overline{\text{A}\text{---}}$  or  $\overline{\text{A}\sim}$  and connect the test leads as shown in Figure 2-6 and described in the following procedure:

1. Turn off power in the circuit to be measured.
2. Break the circuit (on the ground side to minimize the common mode voltage), and place the meter in series at that point. (To measure current without breaking the circuit, use a current clamp.)
3. Turn on power to the circuit, and read the display. The meter will select the appropriate range automatically, and an annunciator on the display will indicate the units of the measurement value shown.
4. Turn off power to the circuit and disconnect the meter from the tested circuit.

#### Note

*After measuring high current using the 10 A input, thermal voltages are generated that may create errors when making low-level (high sensitivity) dc measurements of volts, current, or ohms. To make the most accurate measurements, allow up to ten minutes for the thermals to settle out.*

### Diode/Continuity Testing

Diode and continuity tests are performed by a diode test function with a continuity beeper that can be turned on and off.

The continuity test determines whether a circuit is intact (i.e., has a resistance less than about 30  $\Omega$ ). The meter detects continuity for intervals as brief as 50  $\mu$ s. The continuity test function cannot be selected for the secondary display.

To perform a continuity test, press  $\overline{\text{---}\parallel}$ , and connect the test leads as shown in Figure 2-7. The beeper emits a single beep when the input drops below +0.8 V (approximately 1 k $\Omega$ ), and emits a continuous tone when the input goes below +25 mV (approximately 30  $\Omega$ ).

The diode test measures the forward voltage of a semiconductor junction (or junctions) at approximately 0.7 mA. Readings are displayed in the 3 V range at the medium and fast measurement rates. "OL" is displayed for voltages above +2.5 V. If the diode test is performed at the slow reading rate, readings are displayed in millivolts on the 1000 mV (1 V) range.

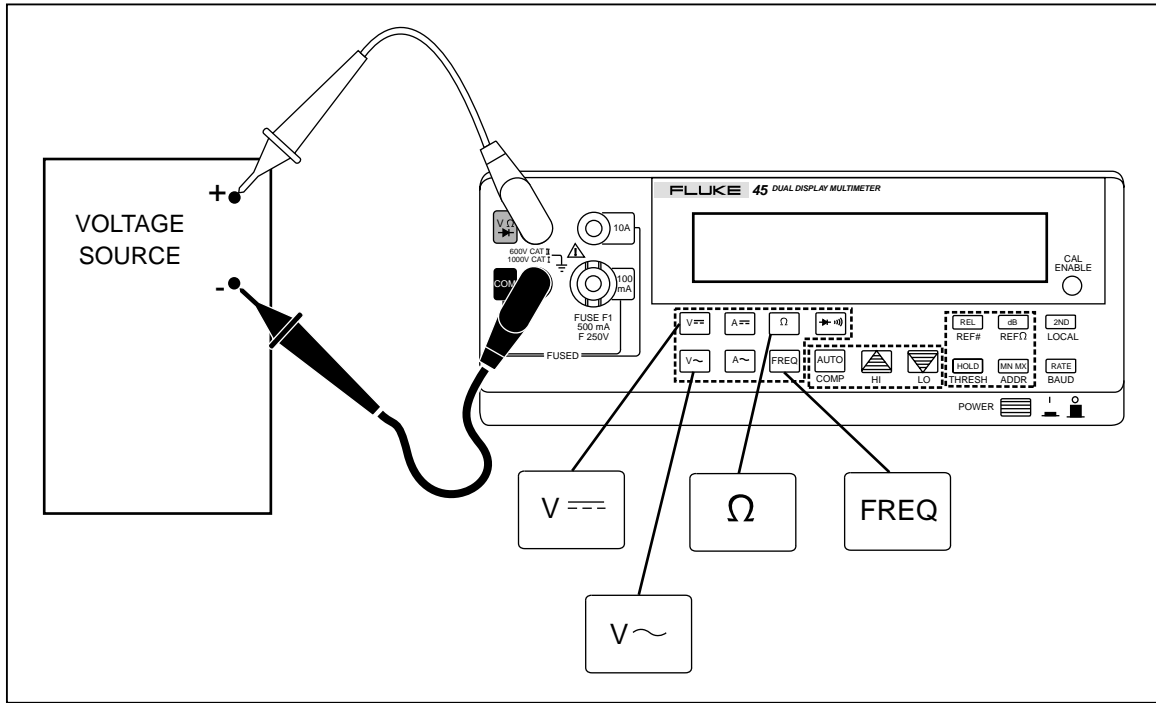

Figure 2-5. Measuring Voltage, Resistance, or Frequency

aam05f.eps

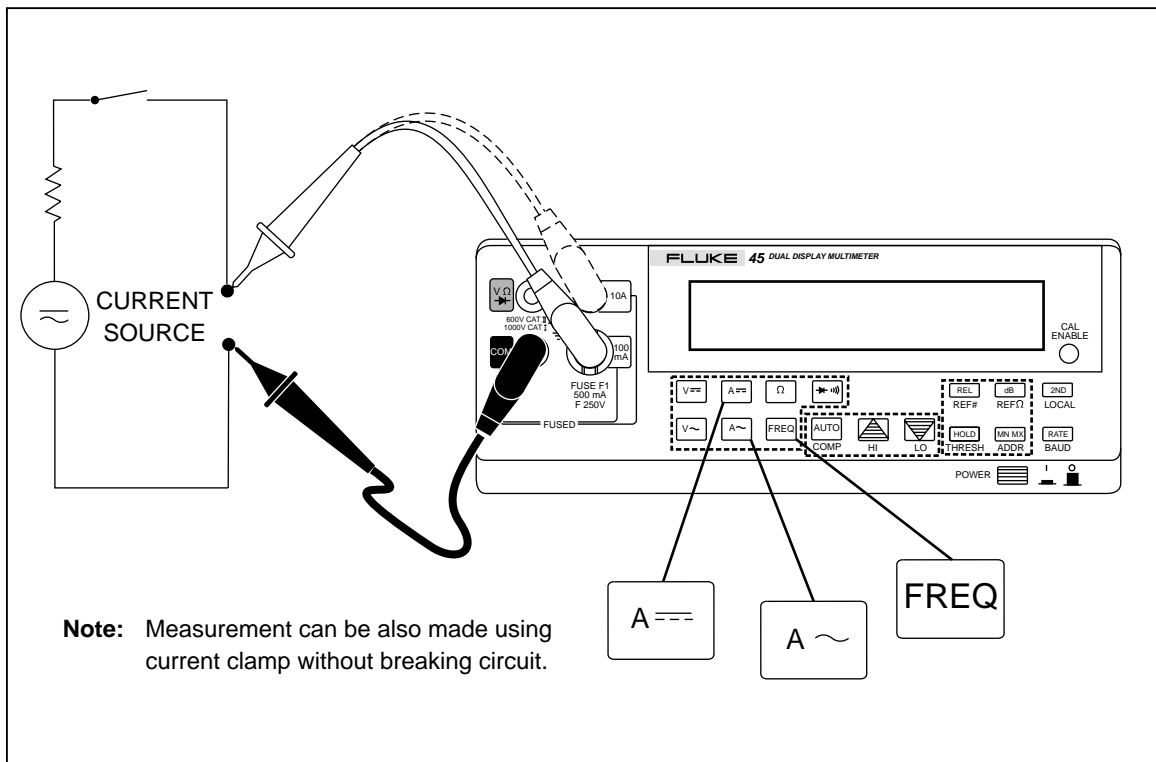

Figure 2-6. Measuring Current or Frequency

aam06f.eps

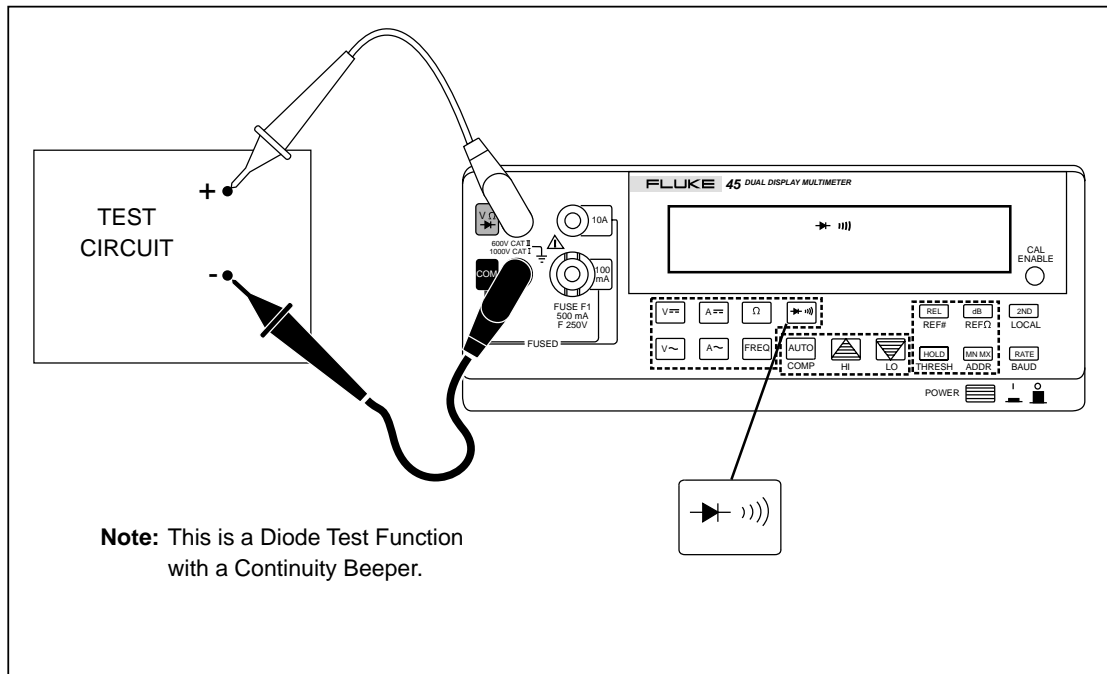
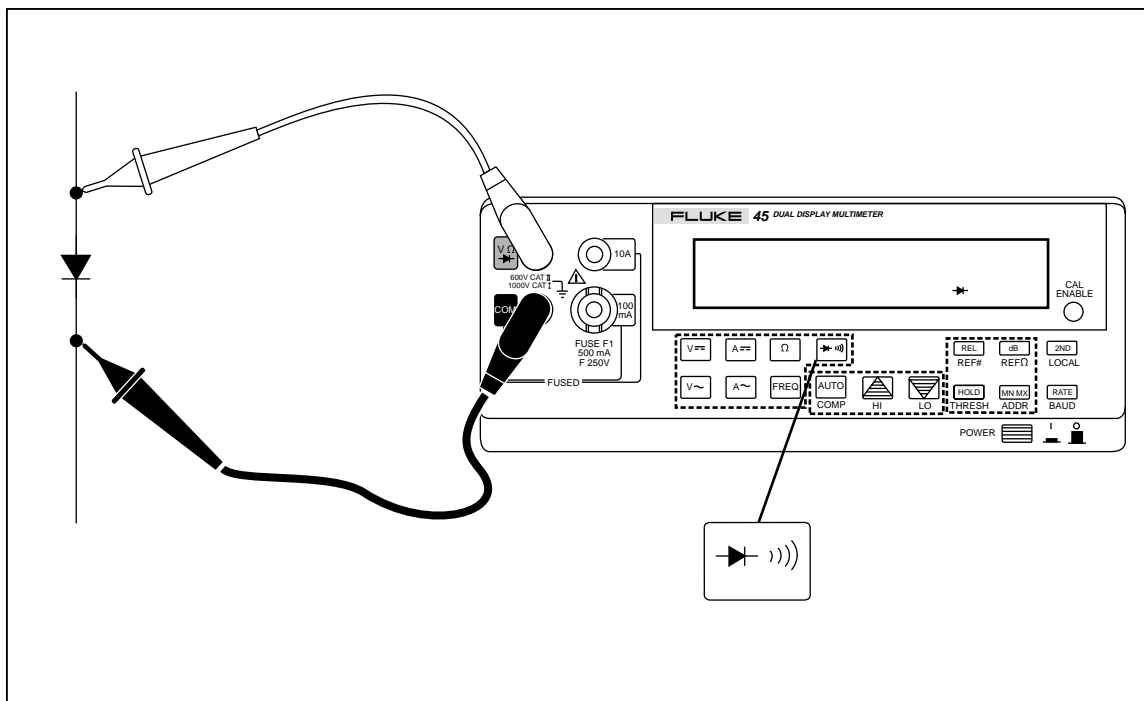



Figure 2-7. Continuity Testing

aam07f.eps



aam08f.eps

To perform a diode or transistor junction test, press  to select the diode/continuity function. (Each press of  turns the continuity beeper on and off.) Then connect the test leads across the diode as shown in Figure 2-8. Notice how the test leads are placed. Reversing the polarity will reverse-bias the diode.

## **Operating the Meter Under Battery Power (Optional)**

The meter can be powered by an 8 V, lead-acid battery. The battery module consists of a battery, battery bracket, and battery charger circuit assembly. The battery is rechargeable, requires no maintenance, and is fully operable at ambient temperatures between 0 and 50 °C. Refer to Appendix A for specifications.

The battery has a typical operating time of eight hours. When less than 1/2-hour of battery life remains,  turns on. If you turn the meter off when it is being operated under battery power, you must wait five seconds before turning the meter back on. Otherwise the meter will not power-up.

To maintain a fully charged battery (and maximize battery life), always recharge the battery after the meter has been operated on battery power. To recharge the battery, plug the meter into line power and turn the meter off. It will take approximately 16 hours to fully recharge a discharged battery with the meter turned off.

The battery remains fully charged as long as the meter is connected to line power. You need not be concerned about over-charging the battery. Do not store the battery for extended periods in a discharged state. Always fully charge the battery before storage and at least once every six months during storage. If the meter has been stored for a long period with the battery installed, fully recharge the battery before using the meter on battery power.

## **Rack Mounting**

You can mount the meter in a standard 19-inch rack using the M00-200-634 Rack Mount Kit. The rear feet can be rotated to clear a narrow rack space.

To install the rack mount kit, refer to the instructions provided with it.





# Chapter 3

## ***Operating the Meter From the Front Panel***

### ***Introduction***

Chapter 3 explains how to operate the meter from the front panel. Refer to Chapter 4 for information concerning specific applications. Chapter 5 provides instructions on how to operate the meter using the computer interface (RS-232 or IEEE-488).

### ***Front Panel Operations***

The following operations can be performed from the front panel:

- Select a measurement function (volts dc, volts ac, current dc, current ac, resistance, frequency, and diode/continuity test) for the primary and secondary display.
- Take a measurement and display a reading.
- Select the manual or autorange mode (AUTO).
- Manually select a measurement range for the primary display.
- Select function modifiers that cause the meter to display relative readings (REL), minimum or maximum values (MN MX), or decibels (dB), or to enter the Touch Hold mode (HOLD) to hold a reading on the primary display.
- Change the measurement rate (slow, medium, fast).
- Set the dB reference resistance (REF  $\Omega$ ).
- Take a measurement and compare (COMP) it against a tolerance range (HI, LO, or PASS).
- Use the "editor" to select from option lists, to enter a relative base, or to enter a HILO range for the compare (COMP) mode.
- Configure the computer interface (RS-232 or IEEE-488).
- Take an audio power reading.
- Send measurements directly to a printer or terminal through the RS-232 interface (RS-232 print-only mode).

These and other front panel operations are described in the remainder of Chapter 3.

## Display

The meter has a 5-digit, vacuum-fluorescent, dual display. This display shows measurement readings, annunciators, and messages. The annunciators indicate measurement units and the meters operating configuration.

The dual display allows you to see two properties (e.g., volts ac and frequency) of the input signal you are measuring. Readings are taken and displayed in an alternating fashion. That is, a reading is taken of one property of the input and sent to a display; then a reading of the other property is taken and sent to the other display. (For more detail, see "How the Meter makes Dual Display Measurements" in Chapter 4.)

The display flashes when a measurement exceeds 1000 V dc or 750 V ac, the maximum rated input level. If an input exceeds the full scale value of the selected range, the overload annunciator (OL) is displayed.

### Primary Display

The primary display (shown in Figure 3-1) consists of the larger digits and annunciators (see Figure 3-2) and is located on the left side of the front panel. Readings using the relative (REL), minimum maximum (MN MX), Touch Hold (HOLD), or decibels (dB) modifiers can be shown on the primary display only.

### Secondary Display

The secondary display consists of a set of smaller digits on the right side of the dual display (see Figure 3-3).

Press **[2ND]** to turn the secondary display on and off. A series of five dashes is shown in the secondary display when the secondary display has been turned on but a function has not yet been selected.

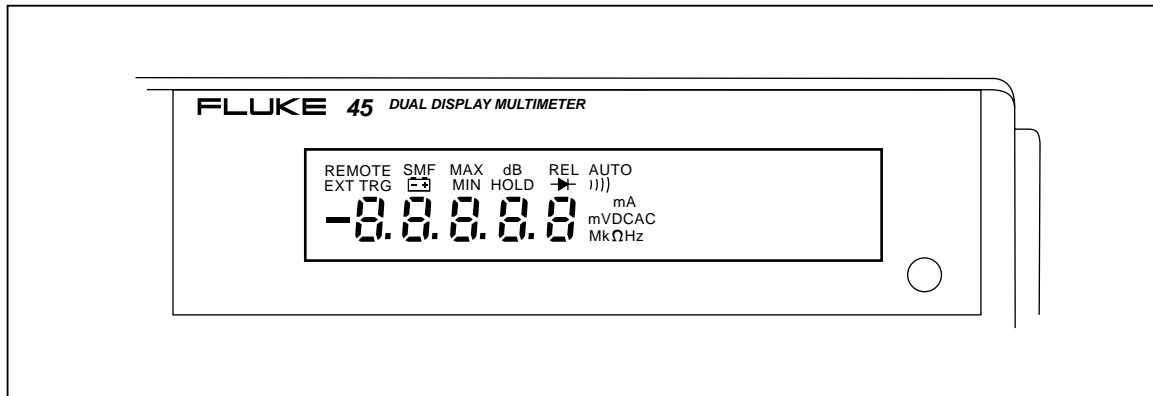

Figure 3-1. Primary Display

aam09f.eps

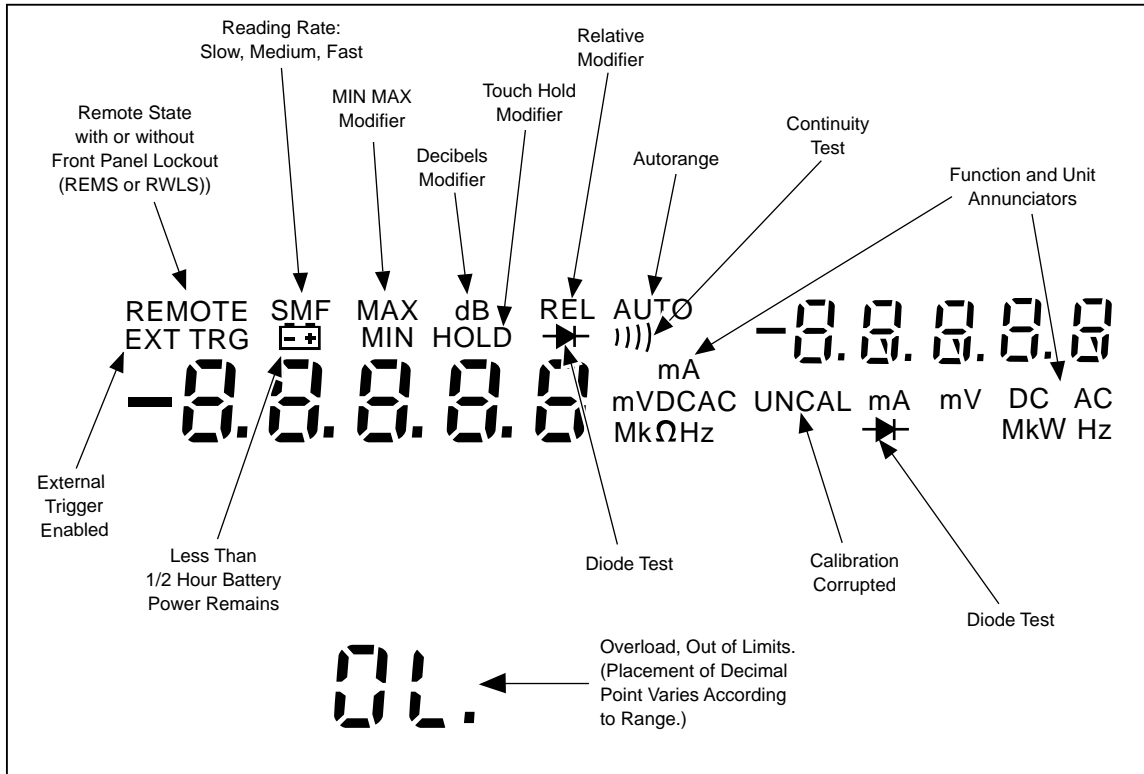

Figure 3-2. Display Annunciators

aam10f.eps

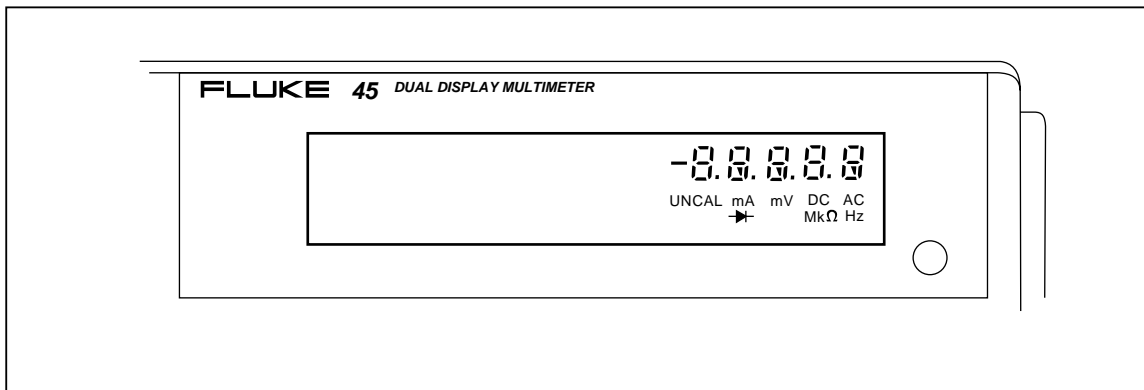

Figure 3-3. Secondary Display

aam11f.eps

If the secondary display has been turned on, press a function button (white) to select a measurement function for the secondary display. The reading in the primary display will not be affected. When the secondary display is active, pressing any function button turns off the secondary display and selects that function on the primary display. To turn the secondary display off without affecting the primary display, press **[2ND]** twice.

*Note*

*If you press **[+|)]**, only a diode test voltage reading will be shown in the secondary display; continuity is restricted to the primary display.*

Neither function modifiers (REL, dB, HOLD, and MN MX) nor the manual range mode can be selected in the secondary display. Measurement ranges in the secondary display are always selected through autoranging.

## Input Terminals

The input terminals, shown in Figure 3-4, are located on the left of the front panel.

The meter is protected against overloads up to the limits shown in Table 3-1. Exceeding these limits poses a hazard to both the meter and operator.

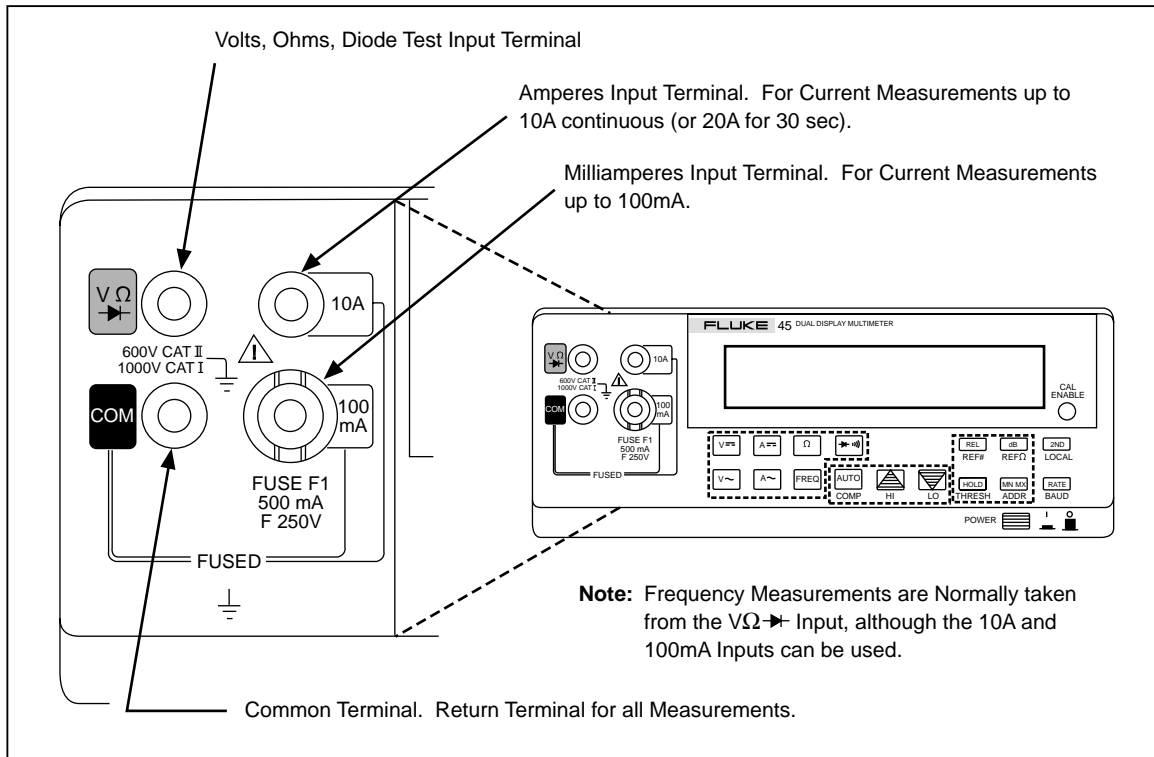

aam12f.eps

Figure 3-4. Input Terminals

Table 3-1. Input Limits

FUNCTION	INPUT TERMINALS	MAXIMUM INPUT
V $\overline{\text{=}}$	V $\Omega$ $\rightarrow$ and COM	1000V dc
V $\sim$ and FREQ	V $\Omega$ $\rightarrow$ and COM	750V ac rms, 1000V peak, $2 \times 10^7$ V-Hz normal mode, or $1 \times 10^6$ V-Hz common mode (whichever is less)
mA $\overline{\sim}$ and FREQ	100 mA and COM	300 mA dc or ac rms
A $\sim$ and FREQ	10A and COM	10A dc or ac rms (or 20A dc or ac rms for 30 sec. Max)
$\Omega$	V $\Omega$ $\rightarrow$ and COM	500V dc or ac rms on all ranges
$\rightarrow$	V $\Omega$ $\rightarrow$ and COM	500V dc or ac rms
All Functions	Any terminal to earth	1000V dc or peak ac

### Selecting a Measurement Function



Press a function button (white), shown in Figure 3-5, to select a measurement function. To select ac + dc total rms readings, press (V $\sim$ ) and (V $\overline{\text{=}}$ ), or (A $\sim$ ) and (A $\overline{\text{=}}$ ), simultaneously.

When you select a function, annunciators turn on to indicate the function selected. If a reading is shown on the secondary display when a function button is pressed, the secondary display will be turned off.

Ranges and full scale values are summarized in Table 3-2 for voltage, Table 3-3 for current, Table 3-4 for ohms, and Table 3-5 for frequency.

### Ranging



Ranging operations are performed using the (AUTO), , and  buttons (see Figure 3-6).

### Autoranging

When you are in the autorange mode, the AUTO annunciator is lit.

In autorange, the meter automatically selects the next higher range when a reading is greater than full scale. If no higher range is available, "OL" (overload) is displayed on the primary or secondary display. The meter automatically selects a lower range when a reading is less than approximately 9 % of full scale.

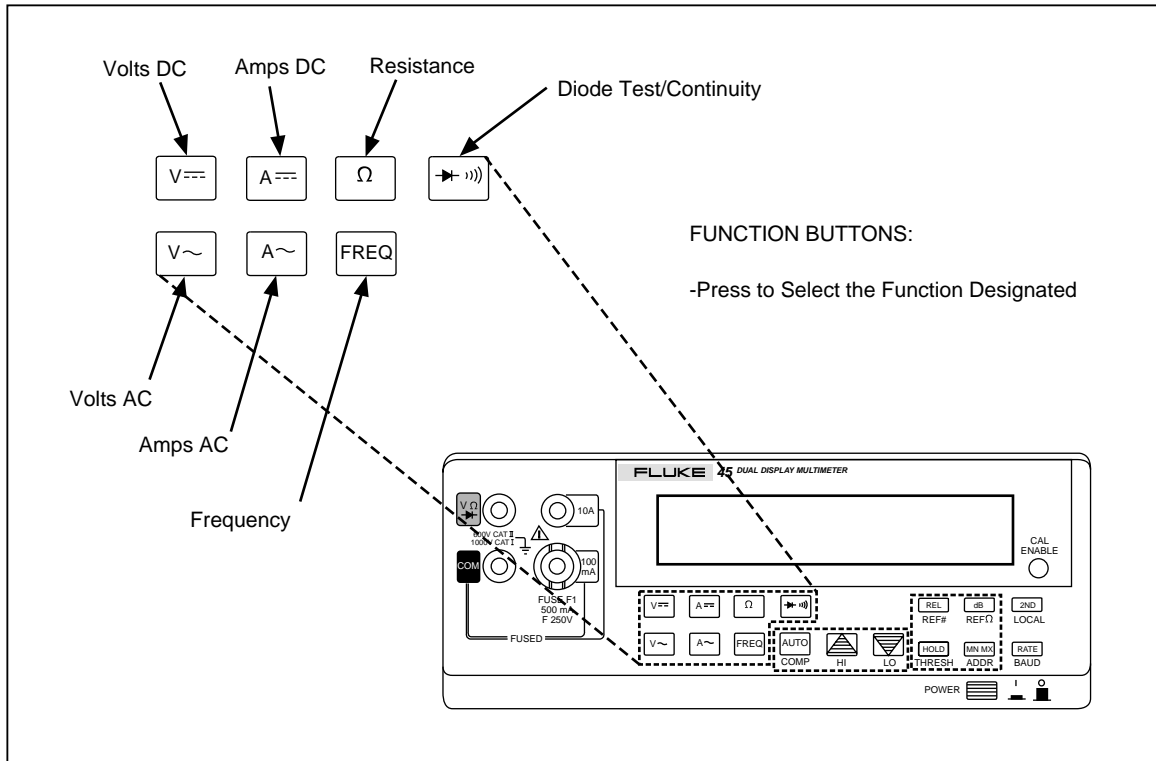

Figure 3-5. Function Selection Buttons

aam13f.eps

Table 3-2. Voltage Ranges and Full Scale Values

Fast Reading Rate		Medium Reading Rate		Slow Reading Rate	
Range	Full Scale	Range	Full Scale	Range	Full Scale
300 mV	300.0 mV	300 mV	300.00 mV	100 mV	99.999 mV
3 V	3.000 V	3 V	3.0000 V	1000 mV	999.99 mV
30 V	30.00 V	30 V	30.000 V	10 V	9.9999 V
300 V	300.0 V	300 V	300.00 V	100 V	99.999 V
1000 V*	1000 V*	1000 V*	1000.0 V*	1000 V*	999.99 V*

\* 750V for volts ac

**Table 3-3. Current Ranges and Full Scale Values**

Fast Reading Rate		Medium Reading Rate		Slow Reading Rate	
Range	Full Scale	Range	Full Scale	Range	Full Scale
30 mA	30.00 mA	30 mA	30.000 mA	10 mA	9.9999 mA
100 mA	100.0 mA	100 mA	100.00 mA	100 mA	99.999 mA
10 A	10.00 A*	10 A	10.000 A*	10 A	9.9999 A
* 20 A for maximum of 30 seconds					

**Table 3-4. Ohms Ranges and Full Scale Values**

Fast Reading Rate		Medium Reading Rate		Slow Reading Rate	
Range	Full Scale	Range	Full Scale	Range	Full Scale*
300 Ω	300.0 Ω	300 Ω	300.00 Ω	100 Ω	98.000 Ω
3 kΩ	3.000 kΩ	3 kΩ	3.0000 kΩ	1000Ω	980.00 Ω
30 kΩ	30.00 kΩ	30 kΩ	30.000 kΩ	10 kΩ	9.8000 kΩ
300 kΩ	300.0 kΩ	300 kΩ	300.00kΩ	100 kΩ	98.000 kΩ
3 MΩ	3.000 MΩ	3 MΩ	3.0000 MΩ	1000 kΩ	980.00 kΩ
30 MΩ	30.00 MΩ	30 MΩ	30.000 MΩ	10 MΩ	9.8000 MΩ
300 MΩ	300 MΩ	300 MΩ	300.0 MΩ	100 MΩ	98.0 MΩ**
*Typical					
** Because of the method used to measure resistance, the 100 M (slow) and 300 M (medium and fast) ranges cannot measure below 3.125 M and 20 M respectively. "UL" (Underload) is shown on the display for resistances below these nominal points, and the computer interface outputs "+1 E-9".					

**Table 3-5. Frequency Ranges and Full Scale Values (Slow and Medium\*)**

Range	Full Scale
1000 Hz	999.99 Hz
10 kHz	9.9999 kHz
100 kHz	99 999 kHz
1000 kHz	999.99 kHz
1 MHz	9.9999 MHz
* Fast (F) reading rate has one digit of resolution less.	

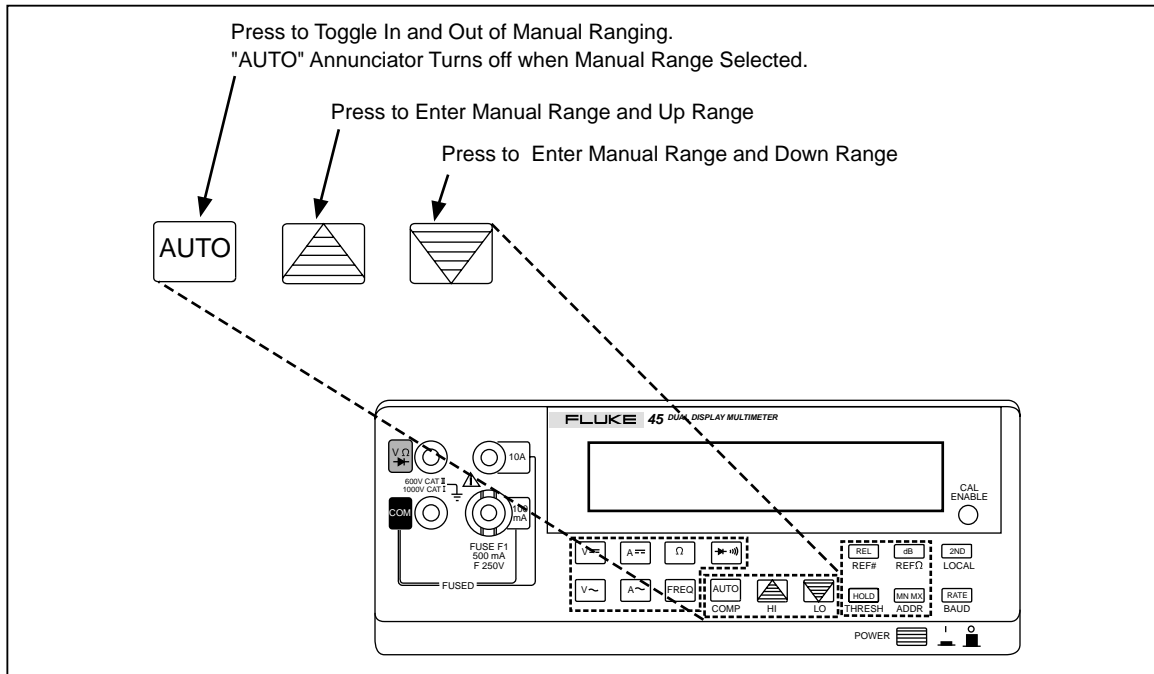



aam14f.eps



Figure 3-6. Range Selection Buttons

### Manual Ranging

Press **AUTO** to toggle in and out of manual ranging. The range you are in when you enter the manual range mode becomes the selected range.

In manual range, the meter remains in the selected range regardless of input. Press **AUTO** to toggle back to autoranging. Manual ranging can only be performed on readings shown on the primary display; the secondary display always autoranges.

Press  to up range. If the  is pressed when the meter is still in autorange, manual ranging is selected, the AUTO annunciator turns off, and the next higher range is selected (if there is one).



Press  to down range. If the  is pressed when the meter is still in autorange, manual ranging is selected, the AUTO annunciator turns off, and the next lower range is selected (if there is one).

### Measuring Frequency

**(FREQ)**

#### Frequency Ranging

Frequency measurements from 5 Hz to > 1 MHz are automatically ranged so that a frequency measurement is always displayed with maximum resolution.

If the frequency function (FREQ) is selected in the primary display, press the  or  to manually select a range. (Manual ranging is not allowed in the secondary display.) If you select a frequency range manually, frequency measurements that exceed the full scale value of that range cause "OL" (overload) to be displayed. Refer to Table 3-5 for frequency ranges and full scale values.



### Frequency Measurement Rates

The rate at which frequency measurements are taken is a factor of the frequency being measured (see Table 3-6).

When the frequency function has been selected, pressing **[RATE]** has no effect on the frequency update rate.

**Table 3-6. Frequency Measurement Rates**

Frequency	Reading Rate
@ > 150 Hz	1.8/sec
@ 100 Hz	1.6/sec
@ 60 Hz	1.3/sec
@ 15 Hz	1/1.2sec
@10Hz	1/1.7sec
@5Hz	1/3.2 sec

### Measuring Frequency of Current (100 mA and 10A) Inputs



Frequency measurements are always taken using the ac input circuitry of the meter. Normally, measurements are taken on the **VΩ→** input terminal. However, frequency measurements can also be taken on current inputs. *If frequency is to be measured using a current input, ac current must be selected in the primary display and frequency must be selected in the secondary display.*

When the ac current function in a mA range is selected in the primary display and frequency is selected as the secondary display function, the frequency of the current at the 100 mA terminal will be measured. Similarly, when the ac current function in the 10 A range is selected for the primary display and frequency is selected in the secondary display, the frequency of the current at the 10 A input terminal is measured.

### Frequency Sensitivity Selection

Before a frequency measurement is started, the amplitude of the input signal is sampled and the optimum ac range is selected automatically. For most applications, therefore, the user need not be concerned with setting the measurement sensitivity for stable frequency readings.

However, if necessary, measurement sensitivity can be selected manually. To do so, use the dual display as described in the following procedure:

1. Power-up the meter and press **[V~]** or **[A~]** to select an ac voltage or current function in the primary display.
2. Press **[AUTO]**, **[**, or **[** to manually select an ac measurement range.
3. Press **[2ND]** then press **[FREQ]** to select the frequency function in the secondary display.

All frequency measurements on the secondary display will be taken on the selected ac range.

The maximum input voltage that may be applied on any ac measurement range for reliable frequency measurements is listed in Table 3-7.

The minimum signal for a stable frequency measurement varies depending on the frequency and waveform being measured.

**Table 3-7. Maximum Sinewave Inputs for Frequency Measurements**

Range	Maximum Input Voltage
300 mV	1 V rms
3 V	6 V rms
30 V	60 V rms
300 V	750 V rms
750 V	750 V rms

The input signal sensitivity is listed under the frequency specifications in Appendix A. These values are based on sine waveforms. The signal level must be increased for lower crest factor inputs (the crest factor is the ratio of the peak voltage to the ac rms voltage of the waveform). If the input signal is below the required level, the frequency will be displayed as zero. If the measurements are unstable, the input signal may be near the threshold level.

### Selecting A Function Modifier

(REL), (dB), (HOLD), (MN MX)

Selecting a function modifier (see Figure 3-7) causes the meter to perform an action on an input (e.g., convert to decibels or compare to another value) before a reading is displayed. Function modifiers can be used in combination. (See "Using Function Modifiers in Combination," later in Chapter 3.)

To use a function modifier, press a function button to select a primary function, then press a function modifier button (or buttons). Modified readings are shown only on the primary display.

After a function modifier has been selected, pressing any (white) function button turns off all modifiers, causes the secondary display to go blank, and returns unmodified readings to the primary display.

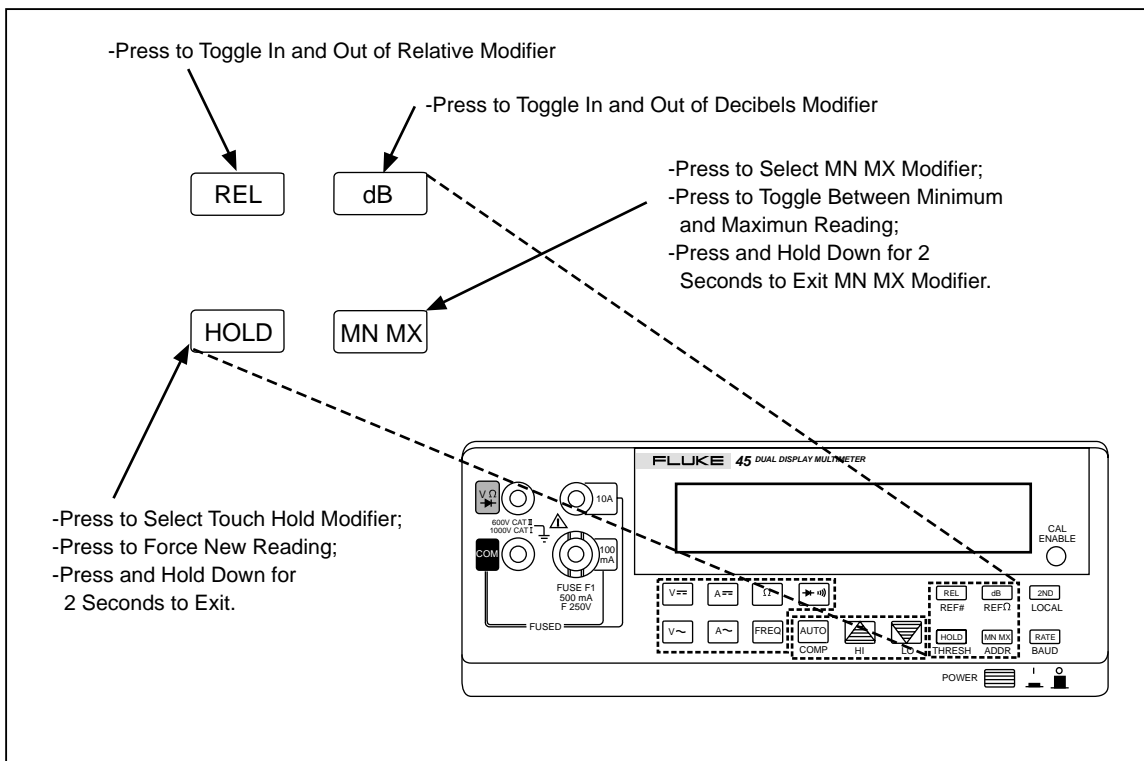

Figure 3-7. Function Modifier Selection Buttons

aam15f.eps

### REL (Relative Readings) Modifier

When the relative modifier (REL) is selected, the reading on the primary display is always the difference between the relative base and an input measurement. For example, if the relative base is 15.000 V, and the present reading is 14.100 V, the display will show -0.900.

#### ⚠ Warning

**To avoid electrical shock or damage to the meter, note that a relative reading may not indicate the presence of dangerous voltages at the input connectors or test leads.**

Press **REL** to toggle in and out of the relative modifier. When the relative modifier is selected: the last valid reading is stored as the relative base, the primary display zeroes out, and "**REL**" is shown on the primary display. (The secondary display is unaffected.)

To edit the relative base, use the number editor as described in "Using the Number Editor" later in Chapter 3).

#### Note

*The relative modifier cannot be selected if the display shows "OL" or is blank. (The display would be blank, for example, because of external triggering or range changes.)*

Selecting the relative modifier **REL** turns off autoranging and locks in the present range. Make sure you are in the correct range before selecting the relative modifier. If you press **Ω** or **Ω** after the relative modifier has been selected, you will automatically exit **REL**.

When you are in REL, the relative base can be shown in the secondary display by pressing **2ND** and, while holding it down, pressing **REL**. Now, whenever the relative

modifier is selected, the relative base is shown in the secondary display. To turn off this feature, press **[2ND]** and, while holding it down, press **[REL]**.

### **dB (Decibels and Audio Power) Modifier**

The decibels modifier takes a voltage measurement, converts it to dBm (measure of decibels relative to one milliwatt), and displays the result on the primary display.

Press **[dB]** to toggle in and out of the decibels modifier. When the decibels modifier is selected, "dB" is shown on the primary display.

Decibels can be selected only when a voltage function is selected on the primary display (volts ac, volts dc, or volts ac + dc). Decibels are always displayed in a single, fixed range with 0.01 dB resolution. However, the basic measurement itself (e.g. volts ac) autoranges.

A voltage measurement is converted to dBm using the following formula:

$$\text{dBm} = 10 * \log (1000 * \text{value}^2 / \text{reference impedance})$$

where "value" is the measurement value. The reference impedance can be set to any of 21 reference impedances listed in Table 3-8 by using the list editor as described in "Using the List Editor" later in Chapter 3.

**Table 3-8. Reference Impedances in Ohms**

8000	300	93
1200	250	75
1000*	150	50
900	135	16†
800	125	8†
600	124	4†
500	110	2†

\* Voltage annunciator lit  
† Audio power readings possible

To access the reference impedance list, press **[2ND]** then press **[dB]** (**REF Ω**). The reference impedance currently selected is displayed, along with the **db** and **Ω** annunciators. Press **[▲]** or **[▼]** to scroll to the desired value, then press **[AUTO]** to select a reference impedance and return the primary display to the measurement function. Press any function (white) or modifier (light grey) button to exit the reference impedance list without selecting a new value.

Setting the dB reference resistance to 16, 8, 4, or 2 ohms allows you to use the meter to calculate audio power. After the reference resistance has been set to 16, 8, 4, or 2 ohms, press **[dB]** twice to select the audio power modifier. "POWER" will be shown on the secondary display.

The following equation is used to make a power calculation:

$$\text{Audio power} = \text{Volts} / \text{reference resistance}$$

where volts is the measurement value.

### **HOLD (Touch Hold) Modifier**

The Touch Hold modifier allows you to take a measurement and "hold" that measurement on the display. This feature can be particularly advantageous in difficult or hazardous circumstances when you might want to keep your eyes fixed on the probes, and then read the display when it is safe or convenient to do so. When a new, stable reading is detected, a beep is emitted, and the display is automatically updated.





Press **[HOLD]** to select the Touch Hold modifier. When Touch Hold is selected, "HOLD" is shown in the primary display. In Touch Hold, each press of **[HOLD]** forces a new reading to be displayed. To exit Touch Hold, press down **[HOLD]** for two seconds.

If you are in the autorange mode when Touch Hold is selected, you will autorange to the correct range. If you are in the manual range mode, you will enter Touch Hold in the selected (fixed) range you were in when Touch Hold was selected.

The Touch Hold modifier can be combined with the MN MX modifier to hold and update only when a new minimum or maximum value is detected. Pressing **[HOLD]** less than two seconds when Touch Hold has been selected forces the display to update.

The meter allows you some choice when it comes to determining the minimum response level needed for Touch Hold to capture and display a measurement. You can choose among three Touch Hold sensitivity levels:



- Level 1 (5 % of range)
- Level 2 (7 % of range)
- Level 3 (8 % of range)

To change this level, press **[2ND]**, then press **[HOLD]**. The number "1," "2," " or " 3 " appears on the primary display. Press  or  to step to the desired sensitivity level. Then press **[AUTO]** to set the level and return the primary display. You can return to the primary display without changing the sensitivity level by pressing any button except **[AUTO]**, , or .

### **MN MX (Minimum Maximum) Modifier**

The MN MX modifier causes the meter to store the minimum and maximum inputs measured since the MN MX modifier was selected.

Press **[MN MX]** to select the MN MX modifier. When the MN MX modifier is first selected, the minimum and maximum values are set to the displayed reading and the "MIN" annunciator lights. Press **[MN MX]** again to display the maximum reading (and the "MAX" annunciator). Each subsequent press of the **[MN MX]** button toggles between the minimum and maximum measurements taken. To exit the MN MX modifier, press and hold down the **[MN MX]** button for two seconds.

Selecting the MN MX modifier turns off autoranging and locks in the present range. Make sure you are in the correct range before selecting the MN MX modifier. If you press  or  after MN MX has been selected, you will automatically exit the MN MX modifier.

To observe the quantity being measured without resetting the stored MN MX values, use the secondary display by pressing **[2ND]**, then select the same measurement function that is selected for the primary display.

### **Using Function Modifiers in Combination**

The meter allows you to use multiple function modifiers (dB, REL, HOLD, MN MX) simultaneously. The selected modifiers are evaluated in the following order: HOLD, dB, MN MX, and REL. That is, the meter first looks for a stable measurement for Touch

Hold, then converts the measurement to decibels, then determines if the measurement is either a new minimum or maximum value, and then subtracts the relative base from the measurement.

When using multiple modifiers, the order in which modifiers are selected is important. For example, if **(REL)** is pressed when you are in the MN MX, either the minimum or maximum value (which ever is currently displayed) becomes the relative base. Pressing **(MNMx)** again as the next action causes the meter to display the difference between the minimum and maximum value. If, on the other hand, **(MNMx)** is pressed when you are in REL, the difference between the relative base and the minimum or maximum value (depending on what was displayed) is shown.

### Selecting A Measurement Rate (Rate)

The meter takes measurements at one of three, user-selectable rates: slow, medium, and fast. Rate selection allows you to maximize either measurement speed or noise rejection, which affects accuracy (see Table 3-9). The rate selected is indicated by "S," "M," "F" (slow, medium, or fast, respectively) in the primary display.

Press **(RATE)**, located in the lower-right corner of the front panel, to step through measurement rates. The selected rate applies to all basic measurements, except frequency. (When frequency is measured, the rate is a factor of the frequency being measured (see Table 3-6), and pressing **(RATE)** has no effect on the frequency update rate.)

**Table 3-9. Display Measurement Rates for Single Function Measurements**

Measurement Rate	Digits	Display Counts	Results Per Second
Slow	5	99,999*	2-1/2
Medium	4-1/2	30,000	5
Fast	3-1/2	3,000	20

\* All ranges and functions except ohms will display up to 99999. Ohms displays up to 98000 (typical).

### Using the **(2ND)** Button











































Pressing **(2ND)** (located on the lower-right of the front panel) causes the next button pushed to perform a second level operation.

A second level operation can be selected by:

- Pressing **(2ND)** then pressing another button (or buttons);
- Pressing and holding down **(2ND)** and pressing another button;

The second level operation available on a pushbutton is engraved below it on the front panel and enclosed in parentheses in Table 3-10. (The LOCAL function associated with **(2ND)** operates only when the meter is in REMS [remote without front panel lockout]. See Table 5-15 in Chapter 5.)

**Table 3-10.  Button Operations**



Pushbuttons	Operations
 then 	Show volts ac reading in secondary display
 then 	Show volts dc reading in secondary display
 then 	Show amperes ac reading in secondary display
 then 	Show amperes dc reading in secondary display
 then 	Show ohms reading in secondary display
 then 	Show Hz reading in secondary display
 then 	Show diode test reading in secondary display
 then  (COMP)	Compare mode in primary display. (See "Using the Compare Function" in Chapter 3, below.)
 then  (LO)	Edit Compare mode low point. (See "Using the Compare Function" in Chapter 3, below.)
 then  (Hi)	Edit Compare mode high point. (See "USING THE COMPARE FUNCTION" in Chapter 3, below)
 and  (LO)	Store value on primary display as LO compare point (See "USING THE COMPARE FUNCTION" in Chapter 3, below.)
 and  (HI)	Store value on primary display as HI compare point (See "USING THE COMPARE FUNCTION" in Chapter 3, below.)
 then  (REF #)	Edit relative base. (See "Using the List and Number Editor" in Chapter 3 below.)
 and 	Toggle display of relative base in secondary display.
 then  (THRESH)	Select Touch Hold sensitivity threshold
 then  (REF Ω)	Select dB reference impedance.
 then  (ADDR)	Select computer interface address for IEEE-488 operations or RS-232 print only rate. (See also "RS-232 Print-Only Mode" in Chapter 5.)
 then  (BAUD)	Select RS-232 baud rate or "IEEE" to enable an installed IEEE-488 interface.
 Then 	Turn off secondary display, leaving primary display unaffected.
 and 	Store present operating configuration of meter as power-up configuration. (See "Changing the Power-Up Configuration" later in Chapter 3.)
 and 	Display software version.

## Using The Compare (Comp) Function

The compare function (COMP) provides an easy way to determine if a reading falls within a designated range of values. In the compare mode, the meter displays a reading in the primary display and indicates in the secondary display if that value is lower (LO) than, higher (HI) than, or within a range (PASS) you selected.

The compare function can be used with any other function modifier — i.e., REL, MN MX, HOLD, or dB.

Before selecting the compare function, set the high and low points of the tolerance range that a reading will be compared against. This can be done in three ways:

- Set the high and low compare points to the present reading by pressing and holding down **(2ND)**, and then pressing either  (HI) or  (LO).

The value presently displayed becomes either the high or low point. If the display is blank, the meter emits a beep and previously set high or low point remains unchanged.

OR

- Use the number editor, as described under "Using the Number Editor" later in Chapter 3. (Before entering the number editor, be sure you are in the appropriate range.)

The decimal point and input range are fixed according to the range in the editor.

OR

- Use the computer interface commands COMPHI and COMPLO to set the high and low compare points remotely. (Refer to Chapter 5 and Table 5-13.)

To select the compare function, press **(2ND)**, then press **(AUTO)** (COMP). When COMP is first selected, Touch Hold is also activated (and annunciated). Before a stable value is detected, two dashes are shown in the secondary display. When a stable value is detected, the meter emits a beep, the reading is displayed in the primary display, and "HI", "LO", or "PASS" is shown in the secondary display. If the value is either HI or LO, the meter emits a second beep. (If the reading is near zero, only two dashes are shown in the secondary display.)

Touch Hold can be turned off by pressing and holding down **(HOLD)** for longer than one second. The secondary display then updates each time a new reading is taken, but a beep is not sounded.

### The List and Number Editors

Two editors can be invoked from the front panel:

- The "list editor" allows you to scroll through and select from a list of options.
- The "number editor" allows you to edit or enter a numeric value.

"Editing" is performed in the primary display. The normal operation of the meter is interrupted when either editor is invoked.

If a computer interface command is received by the meter during editing, the edit is aborted, and the meter returns to normal operation. The item being edited is not changed.





### **Using the List Editor**



Use the list editor to select an option from a list. Table 3-11 summarizes the options available through the list editor.

To use the list editor, proceed as follows:

1. Press **2ND**.
2. Press the appropriate modifier button, as indicated in Table 3-11, to call the list editor on an options list.

The option currently selected is shown in the primary display and an annunciator, indicating the option list, is shown in the secondary display.

3. Press  or  to step through the list. (Holding down either button for longer than two seconds causes it to scroll.)
4. As you step through the list, only the selected option is shown in normal intensity (bright), all others are dimmed. When the desired option is shown, press **AUTO** to select it. The selected option is then displayed in normal intensity.

To abort the operation, press any button except **AUTO**, , and . When the option selection operation is aborted, the editor is exited, and the meter resumes normal operation.

For example, to set the decibel reference impedance to 16:

















1. Press **2ND**, then press **dB**.  
 “Ω”, “dB”, and the reference impedance are shown in the primary display.
2. Press and hold down  to scroll to 16. (If the reference impedance is less than 16, press and hold down .) Each option other than the selected reference impedance is dimmed. Also, since power can be selected with this reference, "POWER" is shown in the secondary display.

Table 3-11. Options Available Through List Editor

To Set	Pushbuttons	Options	Annunciator
Touch Hold Minimum Response Level	 then  (THRESH)	"1" (5 % of range); "2" (7 % of range); or	"HOLD" "3" (8% of range)
Decibel Reference Impedance in Ohms	 then  (REF Ω)	2, 4,8,16,50,75,93, 110,124,125,135,150, 250, 300,500,600, 800, 900,1000,1200, or 8000	"dB" and "Ω"; also "V" when 1000Ω
RS-232 Baud Rate	 then  (BAUD)	300,600,1200,2400, 4800, or 9600	"baud"
	Parity options list displayed	"E" (even), "O" (odd), "no" (none)	"PAR" for parity
	Echo Mode	On or Off	"Echo" and "On" or "OFF"
IEEE-488 Address(If IEEE-488 Interface Installed and selected.)	 then  (ADDR)	Valid addresses between 0-30	"IEEE"
RS-232 PrintOnly Mode (If RS-232 Interface Selected)	 then  (ADDR)	1,2,5,10,20,50,100, 200, 500,1000,2000, 5000,10000,20000, or 50000	"PRINT"
Trigger Type	 and  simultaneously	1,2,3,4, 5 (See Table 5- 14.)	"tri"

- When you have scrolled to 16, press  to set the dB reference impedance. "16" now becomes bright, indicating that it is the selected value.

This dB reference will remain selected until you change it (as described above), turn the meter off, or reset the meter to the power-up configuration by pressing and holding down  during power-up. (See "Changing the Power-Up Configuration" later in Chapter 3.)

### Using the Number Editor

Use the number editor to set the relative base, or the low (LO) and high (HI) points for compare (COMP) operations (see "Using the Compare Function" earlier in Chapter 3).



To use the number editor, proceed as follows:





- To invoke the desired number editor, press  then press  ,  , or  (REF #). See Table 3-12





Table 3-12. Number Editor Options

Pushbuttons	Number Editor Invoked On
 then  (LO)	Low Point for Compare Mode
 then  (Hi)	High Point for Compare Mode
 then  (REF #)	Relative Base

The last number entered (or, in REL, the last measured value) is shown with the left most digit displayed in normal intensity and the remaining digits dim. (If the number is negative, the minus sign is dim.) Related annunciators are lit, and "EDIT" is shown in the secondary display.

2. Press  to step the bright digit through numbers between 0 and 9. Holding down  causes this digit to scroll continuously.

Press  to select the digit to be edited. Each press of  causes the digit to the right to be selected and go bright, while causing the previously selected digit to go dim. When the right most digit has been selected, the next press of  selects the sign: if the sign is positive, the negative annunciator flashes bright dim; if the sign is negative, the negative annunciator is bright.  will toggle the sign between positive and negative.

3. Any time during editing, you can store a selected value by pressing .
4. To abort the edit and return the meter to normal operation, press any button except , , and .

## Power-Up Configuration



### Factory Settings of Power-Up Configuration

When the meter is turned on and completes the power-up sequence, it assumes its power-up configuration. The power-up configuration set at the factory is shown in Table 3-13.

The IEEE-488 address, the RS-232 baud rate, parity, echo, and print-only rate are not changed when power is cycled off and on. These parameters remain as set until changed by the user.

### Changing the Power-Up Configuration

You can change the power-up configuration to one that more closely meets your needs and preferences. Any combination of meter parameters can become the power-up configuration.

To save any configuration in which the meter is operating, press  and, while holding it down, press . The following parameters are saved:

- Measurement function and initial range on primary display.
- Measurement function and initial range on secondary display.

Table 3-13. Power-Up Configuration Set at Factory

Parameter	Configurations
Function Setting	DC volts
Range Mode	Autorange
Reading Rate	Medium (30,000 counts @ 5 readings/second)
Touch Hold Sensitivity Level	Level "2" (1 to 2 % of Range)
Reference Impedance (for dB)	600 ohms
High/Low Values for Compare (COMP) Mode	0
Minimum and Maximum values in MN MX Modifier	0
Relative Base	0
Relative Base in Secondary Display	Disabled
Trigger Type	Internal

- Range mode on primary display (manual or autorange).
- Measurement rate ("S" (slow) "M" (medium) or "F" (fast)).
- Dual display status (active or inactive).
- Any combination of selected function modifiers (MIN or MAX, HOLD, dB or dB POWER, REL, and COMP).
- Touch Hold sensitivity level ("1", "2", or "3").
- dB reference impedance (see Table 3-8 for available values).
- Last recorded minimum and maximum values for MN MX modifier.
- Last recorded relative base.
- Relative base shown in secondary display (enabled or disabled).
- Last HI-LO settings in compare mode.
- Trigger type (see Table 5-3 for available trigger types).
- Echo (on or off)

To restore the power-up configuration to the factory settings and erase any user-defined configuration, press and hold down **AUTO**, while turning the meter on. The meter beeps when the factory settings are restored.

## Calibration

The CAL ENABLE button is located in the lower-right corner of the display. Press and Hold for three seconds to enable calibration. The meter allows for closed case calibration using reference sources. See the *Fluke 45 Dual Display Multimeter Service Manual* (P/N 856042) for calibration procedures.

# Chapter 4

## Applications

### Introduction

Chapter 4 discusses some applications that will help you use the meter effectively. These applications assume you are familiar with the basic operation of the meter and have a basic understanding of electronics. A sophisticated understanding of electrical circuits is not necessary.

### Using the Dual Display

Using the dual display effectively and with ingenuity can greatly enhance your test and measurement capabilities. By allowing you to make several measurements on a particular input signal, the dual display makes it easy to take measurements that in the past required you to use two meters or make a series of measurements.

To see the ease with which the dual display can be used to take a reading of the ac component of a signal on one display and its frequency on the other, perform the following procedure to measure the voltage and frequency of line power:

1. Press in **POWER** to turn the meter on.
2. Plug the test leads into the **V $\Omega$ →** and **COM** input terminals.
3. Press **(V~)** to select volts ac for the primary display.
4. Press **(2ND)**, then press **(FREQ)** to select frequency for the secondary display.
5. Insert the test lead probes into a wall socket. The display will appear something like Figure 4-1.

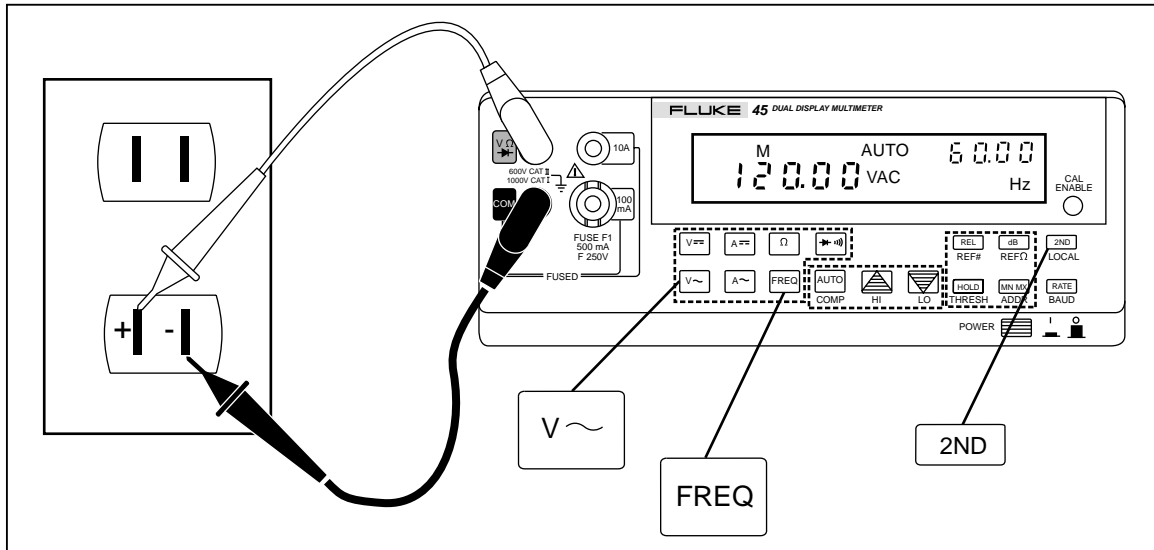

Figure 4-1. Dual Display Showing Volts AC and Frequency

aam16f.eps

### Using Measurement Functions in Combination

The dual display allows you to display two properties of the input signal being measured. Any combination of two properties from the list below is allowed, even those that may not be useful:

- Volts dc
- Volts ac
- Current dc
- Current ac
- Resistance
- Frequency
- Diode Test/Continuity

#### Note

*Volts (dc + ac) rms or Current (dc + ac) rms measurements can only be made in the primary display. While (dc + ac) measurements are being made, another function cannot be selected for the secondary display.*

Additional combinations of dual readings are added if you use the function modifiers—i.e., REL, MN MX, HOLD, or dB.

Some applications of the dual display using common combinations of readings are provided in Table 4-1.

### Taking Voltage and Current Measurements Using the Dual Display

Most applications of the dual display listed in Table 4-1 can be performed using a single set of test leads connected to the **VΩ** and COM input terminals.

However, to measure the voltage and current of an input signal requires three leads. Be sure that the voltage and current measurements share the same common as shown in Figure 4-2. Then simply follow the precautions you would follow if you were making normal current measurements without a current clamp.

**Table 4-1. Sample Dual Display Applications**

Primary Display	Secondary Display	Applications
Volts DC	Volts AC	<ul style="list-style-type: none"> <li>• Monitor dc level and ac ripple of power supply</li> <li>• Troubleshoot amplifier circuits</li> </ul>
Volts DC	Current DC	<ul style="list-style-type: none"> <li>• Check power supply load regulation</li> <li>• Monitor UUT current draw and circuit voltages</li> <li>• Monitor loop current and voltage drop across transmitter</li> </ul>
Volts DC	Current AC	<ul style="list-style-type: none"> <li>• Line and load regulation tests</li> <li>• dc/ac or ac/dc converters</li> </ul>
Volts AC	Current DC	<ul style="list-style-type: none"> <li>• Line and load regulation tests</li> <li>• dc/ac or ac/dc converters</li> </ul>
Volts AC	Current AC	<ul style="list-style-type: none"> <li>• Line and load regulation tests</li> <li>• Transformer (magnetic circuit) saturation</li> </ul>
Volts AC	Frequency	<ul style="list-style-type: none"> <li>• Measure ac amplitude and frequency for line voltage and ac signal analysis</li> <li>• Measure frequency response of an amplifier</li> <li>• Adjust ac motor control</li> <li>• Read noise in telecommunication applications</li> <li>• Adjust portable power generator to optimize power output</li> <li>• Set frequency compensation for a network</li> </ul>
dB (in Volts dc)	Frequency	<ul style="list-style-type: none"> <li>• Use in "print-only" mode (see "RS-232 Print-Only Mode" in Chapter 5) for quick Bode plots (frequency vs. amplitude)</li> <li>• Test frequency response</li> </ul>
Current DC	Current AC	<ul style="list-style-type: none"> <li>• Measure ripple and dc current draw of switching power supply</li> <li>• Measure current dissipation in protective fuse resistors used in power supplies</li> <li>• Measure ripple and noise on a line</li> </ul>
MN MX	Actual Value	<ul style="list-style-type: none"> <li>• Show the minimum or maximum value recorded and the present measurement</li> </ul>
REL	Actual Value	<ul style="list-style-type: none"> <li>• Show actual measurement and the difference between this value and the relative base.</li> </ul>
REL	Resistance	<ul style="list-style-type: none"> <li>• Select and sort resistors. (See also "Using the Compare Function" in Chapter 3.)</li> </ul>
HOLD	Actual Value	<ul style="list-style-type: none"> <li>• Show actual measurement while holding a previous, stable measurement on the primary display</li> </ul>

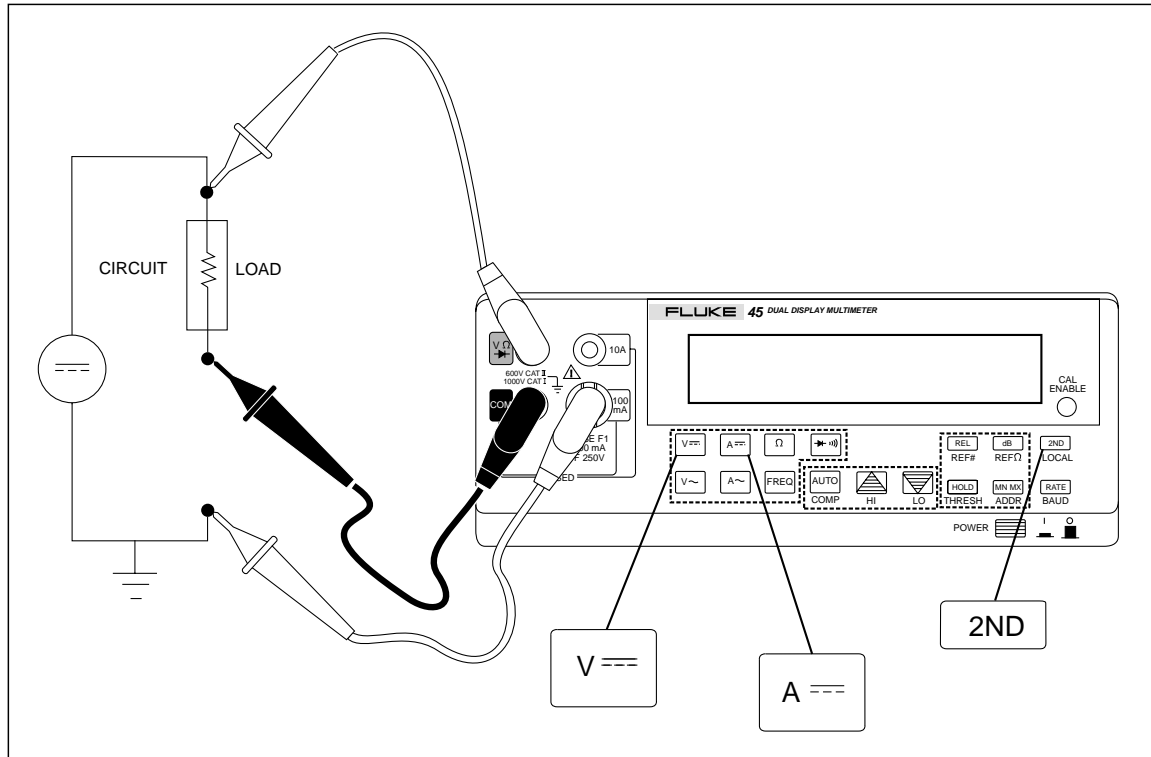

aam17f.eps

**Figure 4-2 DC Voltage and DC Current Measurement on Input Signal**

The lead from the internal measuring circuitry of the meter to the COM binding post (on the front panel) is the same for both voltage and current measurements. The resistance of this lead is approximately  $.003 \Omega$ . If current is being measured, therefore, a voltage drop will occur in the resistance that is common to both circuits. This internal resistance, when added to the external resistance of the lead from the COM input terminal will affect the accuracy of the voltage reading. For instance, if the external lead resistance is  $.007 \Omega$ , the "total" common resistance is  $.010 \Omega$ . If there is 1 A of current, the voltage reading would be affected by

$$(1 \text{ A} \times .01 \Omega) = .01 \text{ V or } 10 \text{ mV.}$$

Depending on the circumstances, this may be significant.

If you want to measure dc voltage on an input signal in the primary display and dc current in the secondary display, proceed as follows:

1. Turn the meter on.
2. Press **V** to select the dc voltage function for the primary display.
3. Press **2ND**, then press **A** to select the dc current function for the secondary display.
4. Connect the leads to the test circuit as shown in Figure 4-2 and read the measurements on the displays. Although current will be displayed as negative, it is in fact positive when interpreted according current flow convention.

## Response Times

Response time is the time between a change in an input and when that change is displayed. The meter's response time depends on many factors: the measurement function selected, number of measurements being made (single measurement when only the primary display is used, or two measurements when both the primary and secondary display are used), the input



level, range type (autorange or manual range), the measurement rate (slow, medium, or fast), and whether measurement types are mixed or not. (Measurements are either ac-type [ac volts or amps] or dc-type [all others]).

Typical response times for a single measurement are shown in Table 4-2. For a single measurement, results are displayed as soon as the correct range is found. However, additional time needs to be allowed for the measurement to be fully settled in order for the displayed result to meet the meter's accuracy specifications. This "settling delay" varies, depending on the differences between the primary and secondary displays.

The settling delay is longer when ac- and dc-type measurements are mixed. Examples of mixed ac and dc measurements are volts dc and amps ac, and volts ac and amps dc. Settling times are listed in Table 4-3.

## **How the Meter Makes Dual Display Measurements**

When the meter is in the dual display mode (i.e., both the primary and secondary displays are on), the meter takes measurements and updates the displays in one of two ways: (1) it takes a single measurement and updates both displays using that measurement; or (2) it updates each display using a separate measurement.

### *Note*

*When measuring AC + DC, (or any dual display combination of AC and DC) in the fast reading rate, the Fluke 45 may show significant reading errors. This results from a lack of filtering on the DC portion of the measurement for the fast reading rate. To avoid this problem, use only the "slow" and "medium" reading rates for AC + DC or AC and DC combinations.*

## **Updating the Primary and Secondary Displays with a Single Measurement**

*The meter takes a measurement and updates both displays using that measurement only when the meter is in the autorange mode, and the measurement function and range are the same for both the primary and secondary displays.*

This will happen, for instance, if dB (which always causes the voltage measurement in the primary display to autorange) or HOLD (with autoranging on) is applied to a measurement function on the primary display and the same function is selected for the secondary display.

If for example, the dB value of an ac voltage measurement were shown in the primary display and the ac voltage itself were shown in the secondary display, the meter would take a single measurement and update both displays with it.

## **Updating the Primary and Secondary Displays with Separate Measurements**

*If the measurement function, range, and ranging mode in the primary display are not identical to those in the secondary display, the meter updates each display using a separate measurement.*

Table 4-2. Typical Single Measurement Response Times (in Seconds)

Meas. Function	Slow Rate		Medium Rate		Fast Rate	
	Auto Range <sup>1</sup>	Single Range <sup>2</sup>	Auto Range <sup>1</sup>	Single Range <sup>2</sup>	Auto Range <sup>1</sup>	Single Range <sup>2</sup>
V $\overline{\text{---}}$	1.00	0.60	0.80	0.40	0.30	0.10
V $\sim$	2.20	0.80	2.00	0.60	1.00	0.30
A $\overline{\text{---}}$	0.60	0.50	0.40	0.30	0.20	0.10
A $\sim$	0.60	0.50	0.40	0.30	0.50	0.30
$\Omega$	1.40	0.60	1.20	0.40	0.40	0.10
$\rightarrow \text{     }$ )	0.50	0.50	0.30	0.30	0.10	0.10
FREQ <sup>3</sup>	1.20	0.50	1.20	0.50	0.70	0.30

1. Time to autorange a new measurement from the lowest to the highest range and to display the result.
2. Typical time to change to the next higher or lower range and display the result.
3. Frequency greater than 150 Hz. Refer to frequency measurement rates in Table 3-6.

Table 4-3. Typical Settling Delays (in Seconds)

		Settling Delay					
		Single Function or All AC or All DC Type			AC & DC Types Mixed		
Meas. Function	Range	Slow	Med	Fast	Slow	Med	Fast
V $\overline{\text{---}}$	All	0.30	0.30	0.00	0.40	0.40	0.00
V $\sim$	All	1.00	1.00	0.20	1.30	1.30	0.20
A $\overline{\text{---}}$	All	0.30	0.30	0.00	0.40	0.40	0.00
A $\sim$	All	1.00	1.00	0.20	1.30	1.30	0.20
$\Omega$	300 $\Omega$	0.30	0.30	0.00	N/A	N/A	N/A
	3 k $\Omega$	0.30	0.30	0.00	N/A	N/A	N/A
	30 k $\Omega$	0.30	0.30	0.00	N/A	N/A	N/A
	300 k $\Omega$	0.70	0.70	0.00	N/A	N/A	N/A
	3 M $\Omega$	0.70	0.70	0.00	N/A	N/A	N/A
	30 M $\Omega$	1.40	1.40	0.00	N/A	N/A	N/A
	300 M $\Omega$	1.60	1.60	0.00	N/A	N/A	N/A
$\rightarrow \text{     }$ )	NA	0.70	0.50	0.10	N/A	N/A	N/A
FREQ	NA	0.50	0.50	0.30	0.70	0.70	0.30

For example, assume the meter has a 1 volt dc input and is taking measurements and updating the primary display on the 30 volt range (medium reading rate, autoranging off). If you then select the volts dc function for the secondary display, the meter will not use the same measurement to update both displays. It will autorange to the 3 volt range (the secondary display always autoranges) and take an additional measurement of the input (on the 3 volt range) for the secondary display.

### Update Rate in the Dual Display Mode

The update rate is the time between successive measurements for a *steady state signal*.

In the dual display mode (when both the primary and secondary displays are on), if the measurement functions or the ranges selected for the primary and secondary displays are different, the update rate for each measurement function will vary from the update rate for that measurement function when only the primary display is on.

When the secondary display is on, the meter always waits for the measurement to be fully settled after changing the range or function before displaying a reading. The amount of delay depends on the functions and ranges selected for the primary and secondary displays as shown in Table 4-3.

AC and DC voltage measurements, however, are always optimized to be measured with a minimum of delay (including ac + dc volts). For these measurements, the update rate is the update rate for each single display measurement plus an additional 75 ms.

Table 4-4 lists the interval between measurements when the measurement function or range of the primary and secondary display differ. These intervals vary by measurement function, range, measurement rate (slow, medium, or fast), and measurement type (ac-and-dc-type measurements mixed or not mixed).

### External Trigger

The external trigger can be used with or without settling delays, as shown in Table 4-3. (Refer to Table 5-3 for trigger types.) The amount of trigger delay varies depending on differences between the primary and secondary displays, as described in the previous section.

When external trigger is enabled, the meter determines the ranges for the primary and secondary (if enabled) displays based on the input at that time. The meter is then ready to begin measuring the input on the optimum range as soon as the trigger is received. If the input changes so that either display autoranges after the trigger is received, the autoranging response times (as shown in Table 4-2) may be required before each measurement result is displayed.

The rear panel trigger input is level sensitive. A high level (above +3 V) will be recognized as a trigger within at most 3 ms (more than 3 ms if the computer interface or front panel is being used during the trigger time). If the trigger input line is still low when the previously triggered measurement is completed, another measurement will be triggered.

Table 4-4. Typical Measurement Intervals (in Seconds) for Dual Display Measurements

Meas.	Range	All AC or All DC Type			AC & DC Types Mixed		
		Slow	Med	Fast	Slow	Med	Fast
$V_{\text{DC}}$	300 mV	0.70	0.50	0.10	1.10	0.90	0.10
	3V	0.70	0.50	0.10	1.00	0.80	0.10
	30V	0.80	0.60	0.10	1.10	0.90	0.10
	300V	0.80	0.60	0.10	1.00	0.80	0.10
	1000V	0.80	0.60	0.10	1.00	0.80	0.10
$V_{\text{AC}}$	All	1.80	1.60	0.50	2.30	2.10	0.50
$A_{\text{DC}}$	All	0.70	0.50	0.10	0.90	0.70	0.10
$A_{\text{AC}}$	All	1.50	1.30	0.50	1.80	1.60	0.50
$\Omega$	300 $\Omega$	0.70	0.50	0.10	N/A	N/A	N/A
	3 k $\Omega$	0.80	0.60	0.10	N/A	N/A	N/A
	30 k $\Omega$	0.90	0.70	0.10	N/A	N/A	N/A
	300 k $\Omega$	1.40	1.20	0.10	N/A	N/A	N/A
	3 M $\Omega$	1.30	1.10	0.10	N/A	N/A	N/A
	30 M $\Omega$	1.90	1.70	0.10	N/A	N/A	N/A
	300 M $\Omega$	2.10	1.90	0.10	N/A	N/A	N/A
$\rightarrow \parallel$	N/A	0.70	0.50	0.10	N/A	N/A	N/A
FREQ*	N/A	0.50	0.50	0.30	0.70	0.70	0.30

\* Frequency greater than 150 Hz. Refer to frequency measurement rates in Table 3-6.

## Thermal Voltages

Thermal voltages are the thermovoltic potentials generated at the junction between dissimilar metals. Thermal voltages typically occur at binding posts and can be greater than 1  $\mu\text{V}$ . When making low-level tic measurements, thermal voltages can present an additional source of error.

Thermal voltages can also cause problems in the low ohms ranges. Some low-value resistors are constructed with dissimilar metals. Just handling such resistors can cause thermal voltages large enough to introduce measurement errors.

Use the following techniques to reduce the effect of thermal voltages:

1. Use similar metals for connections wherever possible (e.g., copper-to-copper, gold-to-gold, etc.).
2. Use tight connections.
3. Use clean connections (especially free of grease and dirt).
4. Use caution when handling the circuit under test.
5. Wait for the circuit to reach thermal equilibrium. (Thermal voltages are generated only where there is a temperature gradient.)

## When Measuring Resistance

### Two-Wire Configuration

The meter measures resistance in a two-wire configuration using a resistance ratio (sometimes called ratio-ohms) technique. Two-wire resistance measurements are simple to set up and yield good results for most measurement conditions.

The full-scale voltage for each resistance range is shown in Table 4-5. The  $V\Omega \rightarrow \oplus$  input test lead is positive with respect to the COM lead.

### Correcting for Test Lead Resistance

The resistance of the test leads can introduce error when measuring low resistances. Typical test leads may add as much as 0.5  $\Omega$  to readings.

To correct for this error using the relative modifier (REL):

1. Insert test leads in the  $V\Omega \rightarrow \oplus$  and COM input terminals.
2. Turn the meter on and press  $\Omega$  to select the resistance function.
3. Select the manual range mode by pressing  $\text{AUTO}$ ,  $\text{}$ , or  $\text{}$ . Then press  $\text{}$  or  $\text{}$  to select the desired range. This is necessary because autoranging is turned off (and the meter is locked in the range it is in) when the relative mode is selected.
4. Touch the test leads together. The display will show the resistance of the test leads.
5. With the test leads still touching, press  $\text{REL}$ . The resistance in the test leads becomes the relative base and the meter should show 0  $\Omega$ .
6. As long as the relative modifier remains selected, the resistance readings shown on the display will be the resistance measured minus the relative base, which in this case is the resistance in the test leads.

Table 4-5. Ohms Test Voltage

Medium and Fast Reading Rates		Slow Reading Rate	
Range	Typical Full Scale Voltage	Range	Typical Full Scale Voltage
300 $\Omega$	0.25	100 $\Omega$	0.09
3 k $\Omega$	0.24	1000 $\Omega$	0.10
30 k $\Omega$	0.29	10 k $\Omega$	0.11
300 k $\Omega$	0.29	300 k $\Omega$	0.11
3 M $\Omega$	0.3	1000 k $\Omega$	0.12
30 M $\Omega$	2.25	10 M $\Omega$	0.65
300 M $\Omega$	2.9	100 M $\Omega$	2.75

Open circuit voltage is 3.2 V (maximum) on the 100  $\Omega$ , 300  $\Omega$ , 30 M $\Omega$ , 100 M $\Omega$ , and 300 M $\Omega$  ranges, and 1.5 V (maximum) on all other ranges.

### True RMS Measurements

The meter measures the true rms value of ac voltages and currents. In physical terms, the rms (root-mean-square) value of a waveform is the equivalent dc value that causes the same amount of heat to be dissipated in a resistor. True rms measurement greatly simplifies the analysis of complex ac signals. Since the rms value is the dc equivalent of the original waveform, it provides a reliable basis for comparing dissimilar waveforms.

By contrast, many meters use average-responding ac converters rather than true rms converters. The scale factor in these meters is adjusted so that they display the rms value for a harmonic-free sine wave. However, if a signal is not sinusoidal, average-responding meters do not display correct rms readings.

### Effects of Internal Noise in AC Measurements

With the input shorted in an ac function (volts ac, current ac, or frequency) the display will read approximately 50 due to internal amplifier noise. Because the meter is a true rms responding meter, this noise has only minimal contribution to the reading at the specified floor (1500 counts in the medium rate) of each range. When the rms value of the two signals (internal noise and range floor) is calculated, the effect of the noise is shown:

$$\text{Total rms digits} = \sqrt{(50^2 + 1500^2)} = 1500.8$$

The display will read 1501. At the down-range point (2800 display counts in the medium rate), the display will read 2800 with no observable error.

#### Note

*Do not use the relative modifier (REL) to "zero" the meter because the relative reading is simply subtracted from the present reading.*

### Calculated (AC + DC) RMS Measurements

When  $\text{V}\text{---}$  and  $\text{V}\sim$ , or  $\text{A}\text{---}$  and  $\text{A}\sim$  are pressed simultaneously, the meter will alternately take a dc and an ac measurement then calculate and display the rms value:

$$\text{RMS value} = \sqrt{\text{dc}^2 + \text{ac}^2}$$

In the dual display mode, when the volts ac and volts dc functions are selected, the 10 M $\Omega$  dc input divider is in parallel with the ac-coupled 1 M $\Omega$  ac divider.

#### Note

*When measuring AC + DC, (or any dual display combination of AC and DC) In the fast reading rate, the Fluke 45 may show significant reading errors. This results from a lack of filtering on the DC portion of the measurement for the fast reading rate. To avoid this problem, use only the "slow" and "medium" reading rates for AC + DC or AC and DC combinations.*

### Waveform Comparison (True RMS vs. Average-Responding Meters)

Figure 4-3 illustrates the relationship between ac and dc components for common waveforms, and compares readings for true rms meters and average-responding meters. For example, consider the first waveform, a 1.41421 V (zero-to-peak) sine wave. Both the Fluke 45 and rms-calibrated average-responding meters display the correct rms reading of 1.0000 V (the dc component equals 0). However, consider the 2 V (peak-to-peak) square wave. Both types of meter correctly measure the dc component (0 V), but your Fluke 45 also correctly measures the ac component (1.0000 V). The average-responding meter measures 1.111 V, which amounts to an 11 % error.

Since average-responding meters have been in use for so long, you may have accumulated test or reference data based on them. The conversion factors in Figure 4-3 should help you convert between the two measurement methods.

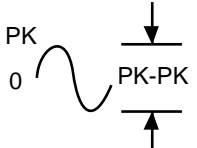
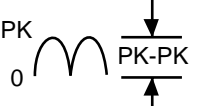
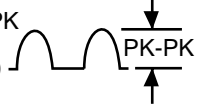
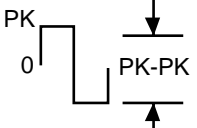
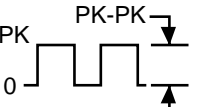
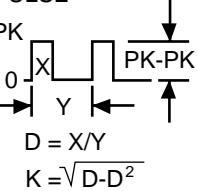
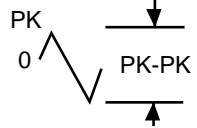
AC-COUPLED INPUT WAVEFORM	PEAK VOLTAGES		METERED VOLTAGES			DC AND AC TOTAL RMS
	PK-PK	0-PK	AC COMPONENT ONLY		DC COMPONENT ONLY	
			RMS CAL*	FLUKE 45		TRUE RMS = $\sqrt{ac^2 + dc^2}$
SINE 	2.828	1.414	1.000	1.000	0.000	1.000
RECTIFIED SINE (FULL WAVE) 	1.414	1.414	0.421	0.436	0.900	1.000
RECTIFIED SINE (HALF WAVE) 	2.000	2.000	0.779	0.771	0.636	1.000
SQUARE 	2.000	1.000	1.111	1.000	0.000	1.000
RECTIFIED SQUARE 	1.414	1.414	0.785	0.707	0.707	1.000
RECTANGULAR PULSE  <p><math>D = X/Y</math> <math>K = \sqrt{D-D^2}</math></p>	2.000	2.000	$4.442 K^2$	2K	2D	$2\sqrt{D}$
TRIANGLE SAWTOOTH 	3.464	1.732	0.962	1.000	0.000	1.000

\* RMS CAL IS THE DISPLAYED VALUE FOR AVERAGE RESPONDING METERS THAT ARE CALIBRATED TO DISPLAY RMS FOR SINE WAVES

aam18f.eps

**Figure 4-3. Waveform Comparison Chart**





# **Chapter 5**

## **Operating the Meter Using the Computer Interface**

### **Introduction**

The meter can be operated from a host (e.g., a terminal, controller, PC, or computer) by sending commands to it through a computer interface on the rear panel.

Chapter 5 describes how to set up, configure, and operate the meter via the RS-232 or (optional) IEEE-488 computer interface. With the (optional) IEEE-488 computer interface installed, the meter is fully programmable for use on the IEEE Standard 488.1 interface bus (1987). The meter is also designed in compliance with supplemental standard IEEE-488.2 (1987).

This chapter assumes you are familiar with the basics of data communication, the RS-232 interface, and the IEEE-488 bus. For an introduction to the IEEE-488 interface, request Fluke Application Bulletin AB-36, "IEEE Standard 488-1978 Digital Interface for Programmable Instrumentation."

An annotated sample program, illustrating the use of the RS-232 computer interface, is provided at the end of Chapter 5. Refer to Chapter 3 for complete descriptions of all meter functions and features. Remote calibration procedures are provided in the Fluke 45 Dual Display Multimeter Service Manual (P/N 856042).

### **Local and Remote Operations**

When the meter is operated from a host, it is said to be operated "remotely." When the meter is operated from its front panel, it is said to be operated "locally."

Most operations that can be performed locally can also be performed remotely, over the computer interface. Some operations, like setting communications parameters for the RS-232 interface and addressing the meter for IEEE-488 operations, can only be performed from the front panel.

### **Computer Interfaces**

The meter comes equipped with an RS-232 (serial) interface. The IEEE-488 interface is optional and is contained on a single printed circuit assembly (pca). Only one computer interface can be enabled at a time. Using either interface turns the meter into a fully programmable instrument that can be integrated into an automated instrumentation system.

If you are using the RS-232 interface, continue reading. If you are using the IEEE-488 interface, skip to "Preparing Meter for Operations via IEEE-488 Interface" later in Chapter 5.

To determine which computer interface is enabled, press in POWER to turn the meter on. Press **(2ND)**, then press **(RATE)**. If "baud" and a rate are displayed, the RS-232 interface is enabled; if "IEEE" is displayed, the IEEE-488 interface is enabled.

## Preparing the Meter for Operations via the RS-232 Interface

The RS-232 interface allows ASCII, asynchronous, serial communication between the meter and a host, a serial printer, or terminal.

### Setting Communication Parameters (RS-232)

The communication parameters for the RS-232 computer interface are shown in Table 5-1 as they are set when the meter leaves the factory. Interface, baud rate and parity parameters can be set directly by the user; data bit and stop bit parameters cannot.

In order for the meter and host to communicate via the RS-232 interface, the communication parameters of the meter must match those of the host. Setting RS-232 communication parameters can only be done from the front panel. If the communications parameters of the host and meter do not match, proceed as follows to select the appropriate baud rate and parity parameters for the meter:

1. Press in the POWER button on the front panel to turn the meter on.
2. Press **(2ND)**, then press **(RATE)**.

The baud rate currently selected is shown in the primary display, and "baud" is shown in the secondary display.

**Table 5-1. Factory Settings of RS-232 Communication Parameters**

Parameter	Factory Setting
Interface	RS-232 (Print-only rate set to 0)
Baud Rate	9600
Parity	None (Parity bit 0)
Number of Data Bits	8 (7 Data bits plus 1 parity bit)
Number of Stop Bits	1
Echo	On

3. Press **(▲)** or **(▼)** to scroll to the desired baud; then press **(AUTO)** to set the selected baud rate.

If a baud rate other than "IEEE" is selected, the RS-232 interface is enabled, and the list editor is invoked on parity.

4. Press **(▲)** or **(▼)** to scroll to "E" for even, "Odd", or "no" for none; then press **(AUTO)** to set the parity.
5. "Echo" now appears on the secondary display, and "On" or "OFF" appears on the primary display.

When Echo is "On", each command sent to the meter over the RS-232 interface is "echoed" to the host's display screen. If Echo is "OFF", commands are not echoed.

To select an Echo mode, press **(▼)** or **(▲)** to select "OFF" or "On", respectively. Then press **(AUTO)** to set the selected Echo state.

**RS-232 Print-Only Mode**

The print-only mode is intended to be used primarily in those cases where you want to send measurements taken by the meter to a printer or terminal automatically.

While the meter will respond to remote commands during "print-only" operations, we recommend first setting the meter's echo mode to "OFF" (see above). This will prevent mixing echoed command characters and incoming data.

In the print-only mode, the meter sends every Nth reading shown on the primary and/or secondary displays out the RS-232 port. The print rate (N) is selected by the user from the available values for N, provided in Table 5-2. The duration between output is determined by the reading rate of the meter (slow (2.5), medium (5.0), or fast (13.5) and the print-only rate. The output is formatted as one measurement per line from the primary display or two measurements per line from the primary and secondary display.

**Table 5-2. Approximate Print Rates in RS-232 Print-Only Mode**

Rate (N)	Seconds Between Output			Minutes Between Output			Hours Between Output		
	Slow	Medium	Fast	Slow	Medium	Fast	Slow	Medium	Fast
1	0.4	0.2	0.07						
2	0.8	0.4	0.1						
5	2.0	1.0	0.3						
10	4.0	2.0	0.6	0.1					
20	8.0	4.0	1.0	0.1	0.1				
50	20.0	10.0	3.0	0.3	0.2				
100	40.0	20.0	6.0	0.7	0.3	0.1			
200	80.0	40.0	11.0	1.3	0.7	0.2			
500	200.0	100.0	25.0	3.3	1.7	0.4	0.1		
1000	400.0	200.0	50.0	6.7	3.3	0.8	0.1	0.1	
2000	800.0	400.0	100.0	12.3	6.7	1.7	0.2	0.1	
5000	2000.0	1000.0	250.0	33.3	16.7	4.2	0.6	0.3	0.1
10000	4000.0	2000.0	500.0	66.7	33.3	8.3	1.1	0.6	0.1
20000	8000.0	4000.0	1000.0	133.3	66.7	16.7	2.2	1.1	0.3
50000	20000.0	10000.0	2500.0	333.3	166.7	41.7	5.6	2.8	0.7

A 240 milliseconds asynchronous pause in the data output of occurs every three seconds.

Perform the following procedure to select the print-only mode and set a printing rate (N):

1. Press in the POWER button on the front panel to turn the meter on.
2. Press **2ND**, then press **MN MX** (ADDR).

If the RS-232 interface is selected, "PRINT" is shown in the secondary display and the list editor is invoked on the print rate list.

3. Press **▲** or **▼** to scroll to one of the print rates shown in Table 5-2, then press **AUTO** to select that rate. A print rate of "0" disables the print-only mode.

The meter exits the list editor, returns to normal operation, and is configured for RS-232 print-only operations.

### **Cabling the Meter to a Host or Printer (RS-232)**

The meter communicates with a host through a DB-9 interface connector on the rear panel of the meter. A connector pinout for the RS-232 interface is on the rear of the instrument.

Cable the meter to the host or terminal using a cable appropriate to your application (see Table 1-1) that is less than 50 feet (15 meters) long. Longer cables are permitted, providing that the load capacitance measured at the interface point (including the signal terminator) does not exceed 2500 picofarads.

To connect the meter with an IBM PC/ AT (DB-9 connector), use both an RS40 and RS41 cable connected end-to-end. Alternatively, a cable intended for interconnecting two IBM PC/ATs can be used.

To connect the meter to a specific brand of RS-232 printer, use the cable that would be used to connect that printer to an RS-232 port on an IBM PC/AT (DB-9 connector).

After cabling is complete, turn the meter back on, and you are now ready to operate the meter over the RS-232 interface.

### **Character Echoing and Deletion**

When the meter is operated via the RS-232 interface, you can control whether characters are echoed to the host's display screen.

When Echo is set "On", characters sent to the meter are echoed on the host's display screen. With Echo "OFF", characters are not echoed. To set the Echo parameter, refer to the procedure under "Setting Communication Parameters (RS-232)", above.

If you send a character to the meter over the RS-232 interface directly from a keyboard, pressing the <DELETE> or <BACKSPACE> key deletes the previous character. A backspace is echoed to the display screen if Echo is "ON".

### **Device Clear Using ^C (CNTRL C)**

^C (CNTRL C) is the RS-232 equivalent of IEEE-488 DCI (device clear), causing "=>" followed by a carriage return and line feed to be output.

### **RS-232 Prompts**

When the host sends a command to the meter over the RS-232 interface, the meter parses it, executes it and returns a response (if appropriate), and sends you one of three prompts:

=> No errors were detected and the command was successfully parsed and executed.

?> A Command Error was detected. The command was not executed because it was not understood.

For instance, this prompt would be returned if the meter was sent an input string that contained a syntax error.

!> An Execution Error was detected. The command was understood but not executed (i.e., a device-dependent error).

For instance, this prompt would be returned if you attempted to use the decibels modifier (dB) on a frequency measurement (FREQ); or if you sent the meter calibration commands when it was not in calibration mode.

## Preparing the Meter to be Operated via IEEE-488 Interface

To turn the meter into a fully programmable element of an automated testing system, use the IEEE-488 Interface option, as described below.

### IEEE-488 Operating Limitations

The following limitations govern the IEEE-488 interface:

- A maximum of 15 devices can be connected in a single IEEE-488 bus system.
- The maximum length of IEEE-488 cable used in one IEEE-488 system must be the lesser of 20 meters or 2 meters times the number of devices in the system.

### Installing the IEEE-488 Interface

If the meter was not shipped with the IEEE-488 option installed, install the IEEE-488 interface according to the instructions provided with it.

To determine if the IEEE-488 interface is installed, perform the procedure under "Enabling the IEEE-488 Interface" (below). "IEEE" is displayed only if the IEEE-488 interface is installed in the meter.

### Enabling the IEEE-488 Interface

The IEEE-488 interface can only be enabled from the front panel. Perform the following procedure to enable the IEEE-488 interface:

1. Press in the POWER button on the front panel to turn the meter on.
2. Press **[2ND]**, then press **[RATE]**.

The baud rate currently selected is shown in the primary display and "baud" in the secondary display.

3. Press the **[▼]** to scroll to "IEEE"; then press **[AUTO]** to enable the IEEE-488 interface. RS-232 capability is now disabled.

#### *Note*

*"IEEE" can only be selected if the IEEE-488 interface board has been installed and the meter is connected to line power. If the meter is under battery power and you attempt to select "IEEE" the **[E+]** flashes and "IEEE" cannot be selected until the meter is connected to line power.*

### Addressing the Meter

After the IEEE-488 interface board has been installed and enabled, the meter must be assigned an address between "0" and "30".

Perform the following procedure to assign the meter a valid address:

1. Press in POWER to turn the meter on.
2. Press **[2ND]**, then press **[MIN MAX]** (ADDR).
3. Press **[▲]** or **[▼]** to scroll to the desired address. Then press **[AUTO]** to select that address.

The address will remain selected until it is changed.

4. To exit and return the meter to normal operation without changing the address, press any button but **[AUTO]**, **[▲]**, or **[▼]**.

### **Cabling the Meter to a Host**

The meter communicates with a host through an interface connector on the rear panel of the meter. First turn the meter off, then cable the meter to the host.

### **Getting Started With An Installation Test**

After the meter has been cabled to a host and prepared to communicate with it via the RS-232 or IEEE-488 interface (as described above), test the system to verify that it is operational.

#### **Installation Test for RS-232 Operations**

The procedure below illustrates how the meter performs a computer interface command and, at the same time, confirms that the meter has been properly set up and cabled for remote operations:

1. Press the POWER button in to turn the meter on.
2. Verify that the computer interface parameters (e.g., baud, parity, etc.) are set correctly.
3. Turn the host on.
4. Send the meter the following command.

```
*IDN? <CR>
```

5. Verify that the meter sends the following response

```
FLUKE, 45, nnnnnnn, n.n Dn.n
```

```
=>
```

nnnnnnn is your meter's serial number; n.n identifies the main software version; and Dn.n identifies the display software version. The RS-232 prompt => means that the command has been executed and the interface is ready to accept another command.

#### **Installation Test for IEEE-488 Operations**

The procedure below illustrates how the meter performs a computer interface command and, at the same time, confirms that the meter has been properly set up and cabled for IEEE-488 operations:

1. Press the POWER button in to turn the meter on.
2. Verify that the meter's IEEE-488 address is set correctly.
3. Turn on the host or controller.
4. Enter the following at the host:

#### *Note*

*This is a program as entered from a Fluke 1722A Instrument Controller using Fluke BASIC commands. Syntax may vary with the host.*

```
INIT PORT 0<CR>
```

```
CLEAR PORT 0<CR>
```

```
PRINT @<address of meter>, "*IDN?"<CR>
```

```
INPUT LINE @<address of meter>, A$<CR>
```

```
PRINT A$<CR>
```

5. Verify that the meter sends the following response  
FLUKE, 45, nnnnnnn, n.n Dn.n  
nnnnnnn is your meter's serial number, n.n identifies the main software version, and Dn.n identifies the display software version.

### **If Test Fails**

If the meter does not respond to the test procedure as indicated:

1. Check all cable connections.
2. If you are using the RS-232 interface, check to see that the communication parameters (e.g., baud rate, parity, etc.) on the meter and host are identical.
3. If you are using the IEEE-488, check to see that it has been properly enabled and addressed.

### **How the Meter Processes Input**

The following paragraphs summarize how the meter processes input that is received from a host (or stand-alone terminal).

#### *Note*

*In this manual "input "means a string sent to the meter from a host. "Output " means a string sent from the meter through the computer interface to the host.*

### **Input Strings**

The meter processes and executes valid "input strings" sent by the host. A valid input string is one or more syntactically correct commands followed by an "input terminator." ASCII and IEEE-488 bus codes are provided in APPENDIX B.

When the meter receives input, it stores it in a 350-byte input buffer.

#### *Note*

*Input strings received over the RS-232 interface are not executed or checked for proper syntax until an input terminator is received or the input buffer becomes full.*

The meter accepts alphabetic characters in either upper- or lower-case. If a command cannot be understood (i.e. the equivalent of an IEEE-488 "Command Error'), the command and the rest of the command line are ignored.

### **Input Terminators**

An input terminator is a character or command (IEEE-488.1) sent by the host that identifies the end of an string.

In RS-232 applications, when the meter receives an input terminator it executes all commands entered since the last terminator was received on a first-in first-out basis. (In IEEE-488 applications, commands are not delayed until receipt of an input terminator, but are executed as they are received.)

As input characters are processed and executed, space is made available in the input buffer for new characters. In RS-232 applications, if a communications error (e.g., parity, framing, over-run) is detected, a device-dependent error is generated, and the input string is discarded. If the meter's input buffer becomes full when it is used with the RS-232 interface, a device-dependent error is generated (see "Event Status and Event Status

Enable Register" later in Chapter 5) and the input string is discarded. If, on the other hand, the input buffer becomes full when the IEEE-488 interface is used, the meter stops accepting characters until there is room in the buffer. Characters in the input buffer cannot be over-written with the IEEE-488 interface.

Valid terminators for the RS-232 interface are:

- LF (Line Feed)
- CR (Carriage Return)
- CR LF (Carriage Return/ Line Feed)

Valid terminators for the IEEE-488 interface are:

- EOI (End or Identity) on any character
- LF (Line Feed)

In some instances, a terminator is automatically transmitted at the end of the host's output string (i.e., the meter's input string). For example, in Fluke BASIC, the PRINT statement finishes with a CR LF pair.

### **Typical IEEE-488 Input Strings**

Two typical strings that could be sent to the meter over the IEEE-488 interface are shown in Figure 5-1. These strings are written in Fluke BASIC to be sent from a Fluke 1722A Instrument Controller.

### **Sending Numeric Values to the Meter**

Numeric values can be sent to the meter as integers, real numbers, or real numbers with exponents as shown in the following examples:

EXAMPLE	EXPLANATION
+12345689	Sends the signed integer "+12345689"
-1.2345E2	Sends -1.2345 x 10 <sup>2</sup>

### **Sending Command Strings to the Meter**

Observe the following rules when you construct strings to be sent to the meter over the computer interface:

- **RULE 1: READ METER'S OUTPUT BUFFER ONLY ONCE FOR EACH QUERY COMMAND.**

The meters output buffer is cleared after it has been read. This prevents previously read data from being read a second time by mistake. If you attempt to read the meters output buffer twice without an intervening query, the meter will not respond to the second read.



- **RULE 2: READ QUERY RESPONSES BEFORE SENDING ANOTHER COMMAND STRING.**

Output data remains available in the output buffer until it is read by the host or until the next command string is received by the meter. This means the meters output buffer must be read by the host before, rather than after, the next command string is sent to the meter.

- **RULE 3: THE METER EXECUTES EACH COMMAND COMPLETELY, IN THE ORDER RECEIVED, BEFORE MOVING ON TO THE NEXT COMMAND.**

If an input string contains a trigger, enter the commands in the following order, that is, from left to right, as written:

1. Commands to configure the meter (if any).
2. The trigger command.
3. Commands to read the result of a triggered measurement (VAL?), or to reconfigure the instrument (if any).
4. The terminator.

In the following examples, <space> between commands is for readability only. However a <space> between a command and its argument is required. The PRINT command sends a terminator at the end of the string.

**EXAMPLE 1:** The following string configures the meter and triggers an ohms reading to be shown on the primary display.

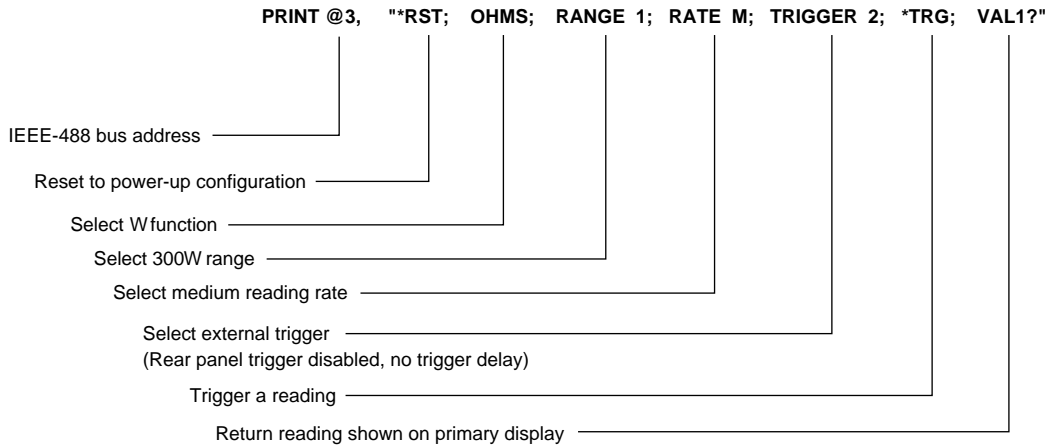

**EXAMPLE 2:** The following string configures the meter and triggers a volts ac reading in primary display and a frequency reading in the secondary display.

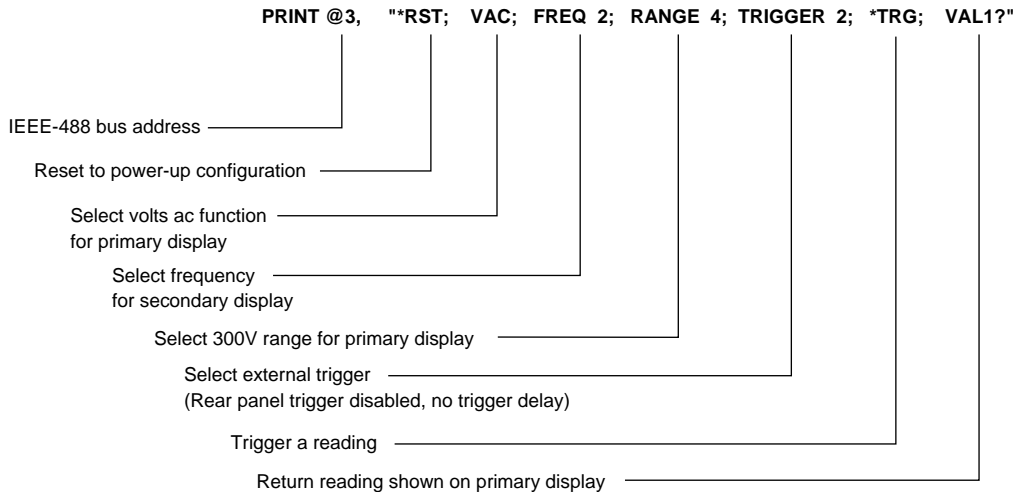

Figure 5-1. Typical IEEE-488 Input Strings

aam19f.eps

## How the Meter Processes Output

The following paragraphs summarize how the meter processes output. The meter outputs an alphanumeric string in response to a query command from the host. (Query commands are easily identified because they all end with "?".) An output string is terminated by a Carriage Return and Line Feed (<CR><LF>) for RS-232 applications or a Line Feed with End or Identity (<LF><EOI>) for IEEE-488.

After sending the meter a command via the RS-232 interface, wait for the meter to return a prompt before sending another command. If you do not do so, a device-dependent command error is generated, and the second string is discarded.

If the meter is part of an IEEE-488 bus system, the output data is not actually sent onto the bus until the host addresses the meter as a talker. When the output buffer is loaded, the Message Available (MAV) bit in the Status Byte Register is set true. (For more information, see "Status Byte Register" later in Chapter 5.)

Numeric output from the meter is displayed as shown in the following examples:

EXAMPLE	EXPLANATION
+1.2345E+0	Measured value of 1.2345
+1.2345E+6	Measured value of 1.2345 x 10 <sup>6</sup>
+12.345E+6 OHM	Measured value of 12.345 x 10 <sup>6</sup> ohms (format 2)
+1E+9	Positive overload (OL on the display).
-1E+9	Negative overload (OL on the display).

## Triggering Output

The meter takes measurements when it is triggered to do so. The five trigger types available on the meter (see Table 5-3) fall into two basic categories:



- An "internal trigger" triggers measurements continuously.
- An "external trigger" triggers a measurement only at the direction of the user.

A measurement can be externally triggered in four ways:

- External trigger with rear trigger disabled (Trigger type "2" or "3" from Table 5-3). See "External Triggering from the Front Panel", below.
- External trigger with rear trigger enabled (Trigger type "4" or "5" from Table 5-3). See "External Triggering via the Computer Interface", below.
- IEEE-488.1 GET command
- IEEE-488.2 \*TRG command (see Table 5-8).

### External Triggering from the Front Panel

To enable an external trigger and trigger a measurement from the front panel, perform the following procedure:

1. Make sure that the RS-232 interface is enabled by pressing , then : the RS-232 interface is enabled if "baud" and a baud rate are displayed.





If the RS-232 interface is enabled, press any button but , , or .

If the RS-232 interface needs to be enabled, refer to the procedure under "Setting Communication Parameters (RS-232)" earlier in Chapter 5.

- Press **AUTO** and  simultaneously.  
"tri" and a number corresponding to the selected trigger type ("1", "2", "3", "4", or "5" from Table 5-3) are displayed.

*Note*

*If **AUTO** is pressed before (rather than simultaneously with) , the meter will toggle from autorange to manual range or vice-versa, depending upon the range mode you are in.*

- Press  or  to step up or down the trigger type list.  
Step to trigger type "2" (external trigger with settling delay disabled) or "3" (external trigger with settling delay enabled) to allow measurements to be triggered from the front panel. (Typical settling delays are provided in Table 4-3.)
- When the desired trigger type is highlighted, press **AUTO** to select that trigger type.  
If trigger type "2" or "3" has been selected, "REMOTE" and "EXT TRG" will be displayed, confirming that you are in the remote mode and external trigger has been enabled. (If you are not in the remote mode, you will not be able to trigger measurements from the front panel.)
- Press  to trigger a measurement. Each subsequent press of the  triggers a measurement.
- To exit the remote mode, press **2ND**.  
You will still be in external trigger. In order to return the meter to its internal (continuous) trigger state, perform steps 1-3 above to select trigger type "1".  
If you exit the remote mode with trigger type "4" or "5" selected, the meter will still be in external trigger, but because it is no longer in the remote mode, you will only be able to trigger measurements with the rear trigger (types "4" and "5") or over the computer interface (using the \*TRG command). To re-enter the remote mode, re-select trigger type "2" or "3" as described above.

### Setting the Trigger Type Configuration

To select a trigger type over the computer interface, send the command:

```
TRIGGER <type>
```

where <type> is a number between 1 and 5 that identifies a trigger type. See Table 5-3. If <type> is not one of these numbers, an Execution Error is generated.

Select a trigger type that enables the settling delay (type 3 or 5) when the input signal is not stable before a measurement is triggered. Typical settling delays are provided in Table 4-3. The reading transfer rates are provided in Table 5-4.

### External Triggering via the Computer Interface

To trigger a measurement over the RS-232 or IEEE-488 computer interface, send the meter a \*TRG command over the computer interface. See Table 5-8.

The following external triggering methods can be used only when the IEEE-488 interface is enabled:

- When the IEEE-488 interface is enabled, the receive pin (RX) of the RS-232 interface can be configured for use as an external trigger input. (See the TRIGGER command, Table 5-14).

A measurement is triggered while the input is greater than +3 V. A method for using DTR (pin 4) and an external switch to trigger a measurement is shown in Figure 5-2.

- Send the IEEE-488 GET interface message (IEEE-488 Operations).

**Table 5-3. Trigger Type**

Type	Trigger	Rear Trigger	Settling Delay
1	Internal	Disabled	—
2	External	Disabled	Off
3	External	Disabled	On
4	External	Enabled	Off
5	External	Enabled	On

**Table 5-4. RS-232 and IEEE-488 Reading Transfer Rates**

RATE	Readings per Second	
	Internal Trigger Operation (Trigger 1)	Internal Trigger Operation (Trigger 4)
Slow	2.5	1.5
Medium	4.5	2.4
Fast	4.5	3.8

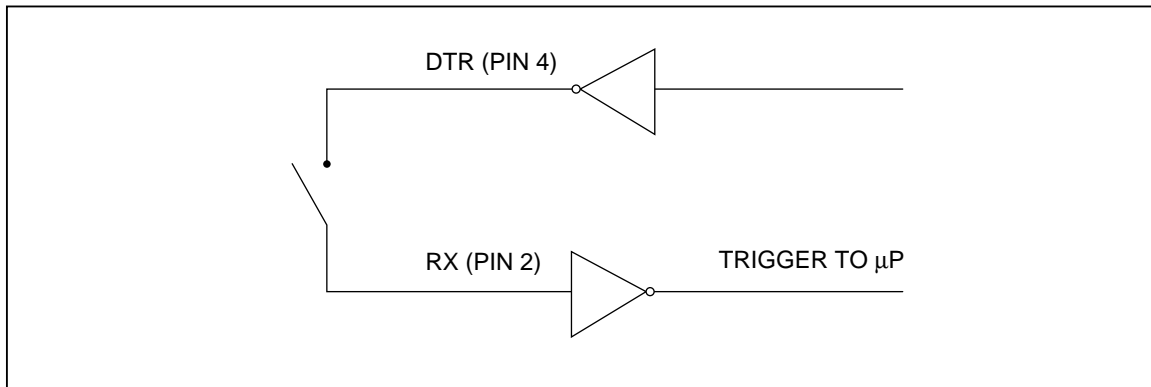

**Figure 5-2. External Trigger Using Receive Pin (RX) of RS-232 Interface**

aam20f.eps

## Service Requests (IEEE-488 Only and Status Registers)

Service requests let a meter on the IEEE-488 bus get the attention of the host. Service requests are sent over the service request (SRQ) bus line.

*Note*

*If the meter is in the remote state without front panel lockout (i.e., REMS), a service request can be sent from the front panel by pressing .*

If more than one instrument on the bus is capable of sending service requests, the host can determine which instrument made the request by taking a "serial poll." Each instrument on

the bus responds to the poll by sending the contents of its Status Byte Register. If an instrument on the bus has made a service request, the request service bit (RQS, bit 6) of its Status Byte Register will be set to 1, identifying it as an instrument that requested service.

The contents of the Status Byte Register (STB) is determined by the Service Request Enable Register (SRE), Event Status Register (ESR), Event Status Enable Register (ESE), and the output buffer. These status registers are discussed below and summarized in Table 5-5. Figure 5-3 shows the relationship of these registers.

**Table 5-5. Status Register Summary**

Register	Read Command	Write Command	Enable Register
Status Byte Register	*STB?	None	SRE
Service Request Enable Register	*SRE?	*SRE	None
Event Status Register	*ESR?	None	ESE
Event Status Enable Register	*ESE?	*ESE	None

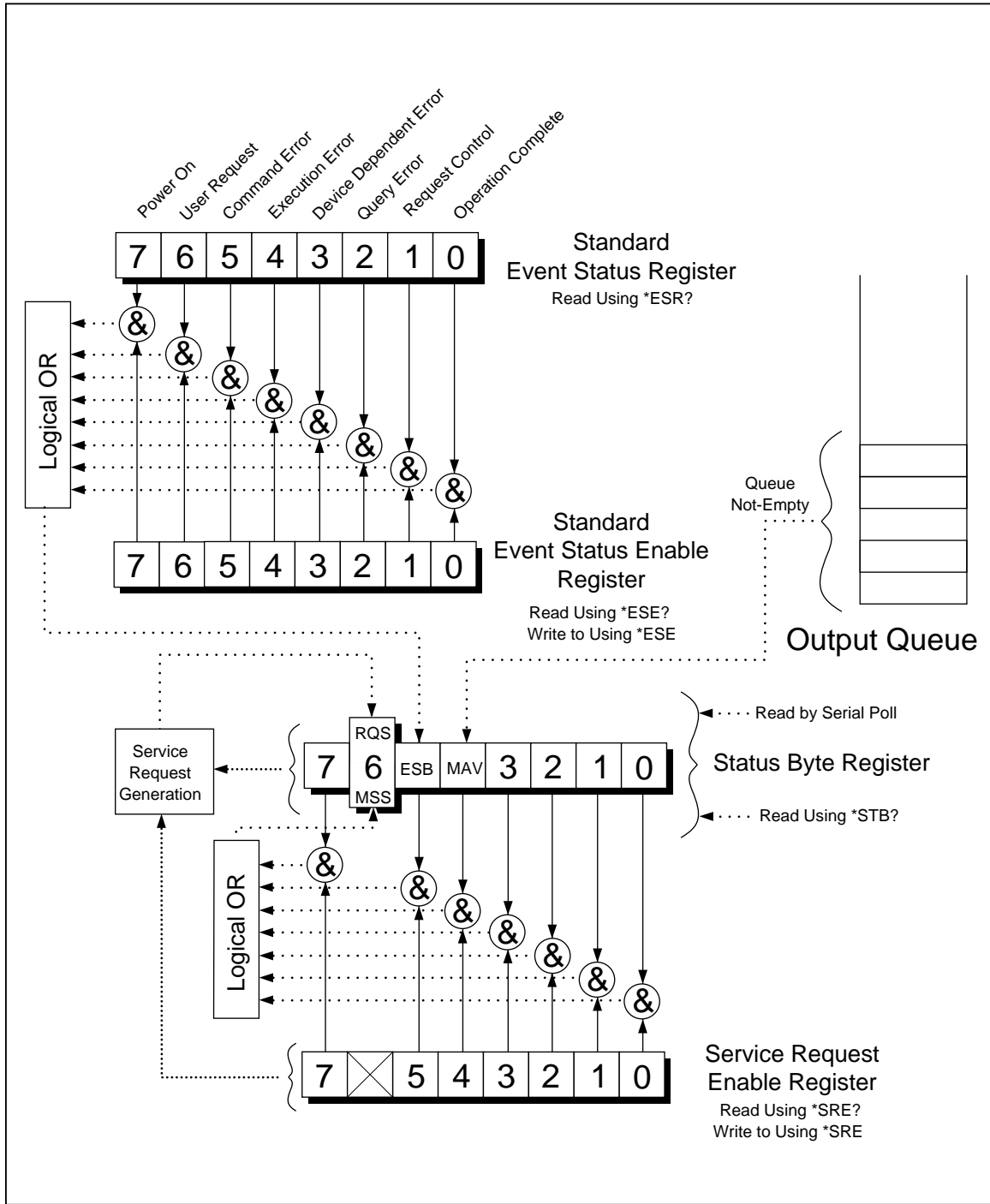

Figure 5-3. Overview of Status Data Structures

aam21f.eps

Figure 5-3 reprinted from ANSI/IEEE Std 488.2-1987. Copyright 1988. By the Institute of Electrical and Electronics Engineers, Inc. By permission of the IEEE Standards Department.

### Event Status and Event Status Enable Registers

The Event Status Register (ESR) assigns specified events to specific bits (see Figure 5-4 and Table 5-6). When a bit in the ESR is set (i.e., 1), the event that corresponds to that bit has occurred since the register was last read or cleared. For example, if bit 3 (DDE) is set to 1, a device-dependent error has occurred.

The Event Status Enable Register (ESE) is a mask register that allows the host to enable or disable (mask) each bit in the ESR. When a bit in the ESE is 1, the corresponding bit in the ESR is enabled. When any enabled bit in the ESR changes from 0 to 1, the ESB bit in the Status Byte Register also goes to 1. When the ESR is read (using the \*ESR? command) or cleared (using the \*CLS command), the ESB bit in the Status Byte Register returns to 0.

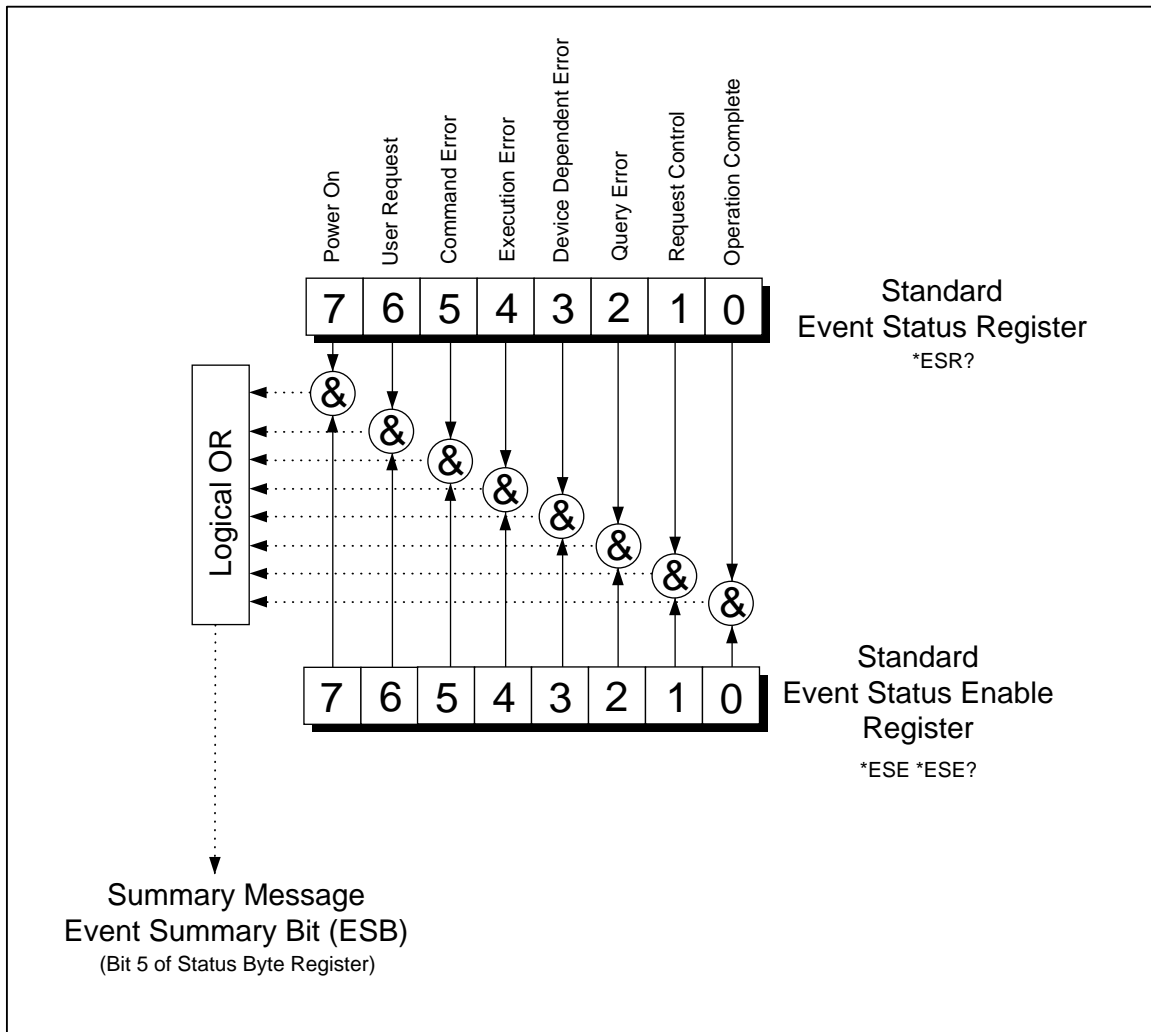

Figure 5-4. Event Status and Event Status Enable Registers

aam22f.eps

Figure 5-4 reprinted from ANSI/IEEE Std 488.2-1987. Copyright 1988. By the Institute of Electrical and Electronics Engineers, Inc. By permission of the IEEE Standards Department.



**Table 5-6. Description of Bits in ESR and ESE**

Bit No.	Name	True (Set to 1) Conditions
0	Operation Complete (OPC).	All commands previous to receipt of an *OPC command have been executed. Interface is ready to accept another message.
1	Not used.	Always set to 0.
2	Query Error (QYE).	Attempt has been made to read data from the meter's output buffer when no output is present or pending. Or, a new command line has been received before a previous query has been read. Or, Both input and output buffers are full.
3	Device-Dependent Error (DDE)	Incorrect input during calibration, or RS-232 input buffer overflow.
4	Execution Error (EXE)	Command was understood but could not be executed. Result, for example, of an inappropriate parameter.
5	Command Error (CME)	Command was not executed because it was not understood. This condition could result, for example, if a command sent to the meter contained a syntax error.
6	Not used.	Always set to 0.
7	Power On	(PON) Power has been cycled off and on since the last time the ESR was read or cleared.

### **Status Byte Register**

The Status Byte Register (STB) is a binary-encoded register that contains eight bits. Note that the Service Request Enable Register (SRE) uses bits 1 through 5 and bit 7 to set bit 6, the request service (RQS) bit, as enabled by the SRE. When the RQS bit is set true(1), the meter sets the SRQ line true (1), which generates a service request. The eight bits of the Status Byte Register (as read by the \*STB? command) are described in Table 5-7.

### **Reading the Status Byte Register**

The host can read the Status Byte Register by taking a serial poll or sending the meter a "\*STB?" query. The value of the status byte is not affected by the STB? query. When the Status Byte Register is read, an integer is returned. This integer is the decimal equivalent of an 8-bit binary number. [For example 48 is the decimal equivalent of the binary 00110000, and means that bit 4 (MAY) and bit 5 (ESB) are set to "1".]

If the status byte is read by serial poll, bit 6 is returned as a request service (RQS); if it is read with an "\*STB?" query, bit 6 is returned as Master Summary Status (MSS).

#### **EXAMPLE**

#### **EXPLANATION**

\*STB?      Reads the Status Byte Register. Assume that "32" is returned. Converting 32 to the binary 00100000 indicates that bit 5 (ESB) is set to 1. To determine the event status, you would have to read the Event Status Register in the same manner, using the "ESR?" command.

Table 5-7. Description of Bits in the Status Byte Register\*

Bit No.	Name	True (Set to 1) Condition
0	Not used.	Always set to 0.
1	Not used.	Always set to 0.
2	Not used.	Always set to 0.
3	Not used.	Always set to 0.
4	Message Available (MAV)	Data is available in the output buffer. Bit set to 1 when response to query placed in output buffer. Bit cleared (set to 0) when output terminator sent to host.
5	Event Status (ESB)	One or more of enabled events in the Event Status Register have occurred. To determine which events have occurred, send the meter "*ERR?" to read the Event Status Register.
6	Master Summary Status† (MSS)	Set to 1 if any enabled bit in the STB (MSS) register is set to 1, otherwise set to 0. Status of MSS bit returned by STB? query command.  Request Service (RQS) Set to 1 if service requested from front panel or MSS set to 1. Status of bit returned by serial poll, which clears RQS.
7	Not used.	Always set to 0.

† As read by \*STB? command. If the Status Byte Register is read by a serial poll, bit 6 is returned as RQS.

### Service Request Enable Register

The SRE Register is an 8-bit register that enables or disables (i.e., masks) corresponding summary messages in the Status Byte Register.

The meter may be programmed to make a service request on errors or when output is available. Conditions that trigger a service request are specified by writing a binary-weighted value to the SRE Register, using the "\*SRE" command.

#### EXAMPLE

\*SRE 16

Enables the generation of an SRQ when bit 4 (MAV) in the Status Byte Register is set to 1. 16 is the decimal equivalent of 00010000 binary. This means that bit 4 in SRE Register (that corresponds to the MAV bit in the Status Byte Register) is 1 and all other bits are 0.

#### EXPLANATION

#### EXAMPLE

\*SRE 48

Enables the generation of an SRQ when bits 4 and 5 (MAV and ESB) in the Status Byte Register are set to 1. The binary equivalent of 48 is 00110000, indicating that bits 4 and 5 are set to 1.

#### EXPLANATION

If any bit in the SRE is set to 1, the RQS bit (bit 6) in the Status Byte Register is enabled, meaning a service request can be generated when the appropriate bits in STB become 1. At power-up or on any device-clear command, the SRE Register is set to 00 (decimal).

Use the "\*SRE?" query (see Table 5-8) to read the SRE Register. The meter returns a binary-weighted integer that represents the enabled bits in the register. (The value of bit

6 will always be zero.) Convert the returned value to binary to determine the status of register bits.

**EXAMPLE**

**EXPLANATION**

*SRE?	Reads the value of the SRE Register. Assume "32" is returned. Converting 32 to the binary 00100000 indicates that bit 5 in the SRE is set to 1.
-------	---

## **Computer Interface Command Set**

The remainder of Chapter 5 describes the RS-232 and IEEE-488 computer interface commands. RS-232 and IEEE-488 commands are identical, except where indicated. These commands, grouped by related function, are listed in the tables that follow. A parameter that must be supplied by the user, or a string returned by the meter is enclosed in angle brackets (e.g., <value>).

- IEEE-488 Capabilities and Common Commands (Tables 5-8 and 5-9)
- Function Commands and Queries (Table 5-11)
- Function Modifier Commands and Queries (Table 5-12)
- Range and Measurement Rate Commands and Queries (Table 5-13)
- Measurement Queries (Table 5-14)
- Compare Commands and Queries (Table 5-15)
- Trigger Configuration Commands (Table 5-16)
- Miscellaneous Commands and Queries (Table 5-17)
- RS-232 Remote/ Local Configuration Commands (Table 5-18)

### **IEEE-488 Capabilities and Common Commands**

The meter supports the IEEE-488 capabilities shown in Table 5-8.

Table 5-9 Summarizes the IEEE-488 Common Commands.

Table 5-8. IEEE-488 Interface Function Subsets

SH1	Source Handshake
AH1	Acceptor Handshake
T5	Talker
L4	Listener
SRI	Service Request
RL1	Remote/Local
DC1	Device Clear*
DT1	Device Trigger
E1	Electrical interface

^C (CNTRL C) is the RS-232 equivalent of DC1, causing <CR><LF> and a new prompt to be output.

Table 5-9. IEEE-488 Common Commands

Command	Name	Description
*CLS	Clear Status	Clears all event registers summarized in the status byte, except for "Message Available," which is cleared only if *CLS is the first message in the command line.
*ESE <value>	Event Status Enable	Sets "Event Status Enable Register" to <value>, an integer between 0 and 255. <value> is an integer whose binary equivalent corresponds to the state (1 or 0) of bits in the register. If <value> is not between 0 and 255, an Execution Error is generated.  EXAMPLE: decimal 16 converts to binary 00010000. Sets bit 4 (EXE) in ESE to 1.
*ESE?	Event Status Enable Query	Meter returns the <value> of the "Event Status Enable Register" set by the *ESE command. <value> is an integer whose binary equivalent corresponds to the state (1 or 0) of bits in the register.
*ESR?	Event Status Register Query	Meter returns the <value> of the "Event Status Register" and then clears it. <value> is an integer whose binary equivalent corresponds to the state (1 or 0) of bits in the register.
*IDN	Identification Query	Meter returns the identification code of the meter as four fields separated by commas. These fields are: manufacturer ("FLUKE"); model ("45"); seven-digit serial number; version of main software and version of display software.
*OPC	Operation Complete Command	Meter sets the Operation Complete bit in the Standard Event Status Register when parsed.
*OPC?	Operation Complete Query	Meter places an ASCII "1 " In The output Queue when parsed.
*RST	Reset	Meter performs power-up reset except that the state of IEEE-488 interface is unchanged, including: 1) instrument address, 2) Status Byte and, 3) Event Status Register.

**Table 5-10. IEEE-488 Common Commands (cont)**

Command	Name	Description																						
*SRE <value>	Service Request Enable	<p>Sets the "Service Request Enable Register" to &lt;value&gt;, an integer between 0 and 255. The value of bit six is ignored because it is not used by the Service Request Enable Register.</p> <p>&lt;value&gt; is an integer whose binary equivalent corresponds to the state (1 or 0) of bits in the register. If &lt;value&gt; is not between 0 and 255, an Execution Error is generated.</p>																						
*SRE?	Service Request Enable Query	<p>Meter returns the &lt;value&gt; of the "Service Request Enable Register" (with bit six set to zero) &lt;value&gt; is an integer whose binary equivalent corresponds to the state (1 or 0) of bits in the register.</p>																						
*STB?*TRG	Read Status Byte Trigger	<p>Meter returns the &lt;value&gt; of the "Status Byte" with bit six as the "Master Summary" bit.</p>																						
*TST	Self-Test Query	<p>&lt;value&gt; is an integer whose binary equivalent corresponds to the state (1 or 0) of bits in the register.</p> <p>Causes the meter to trigger a measurement when parsed.</p> <p>Causes the meter to run internal self-test. Test takes about 15 seconds. All display segments are lit during the test. No user interaction is required.</p> <p>The number returned corresponds to a state described in the table below. Meter reverts to power-up configuration after tests performed.</p> <table border="1" style="width: 100%; border-collapse: collapse;"> <thead> <tr> <th style="text-align: center;">Number</th> <th style="text-align: center;">State</th> </tr> </thead> <tbody> <tr><td style="text-align: center;">0</td><td>Passes</td></tr> <tr><td style="text-align: center;">1</td><td>A/ D self-test failed</td></tr> <tr><td style="text-align: center;">2</td><td>A/D dead</td></tr> <tr><td style="text-align: center;">4</td><td>EEPROM instrument configuration bad</td></tr> <tr><td style="text-align: center;">8</td><td>EEPROM calibration data bad</td></tr> <tr><td style="text-align: center;">16</td><td>Display dead</td></tr> <tr><td style="text-align: center;">32</td><td>Display self-test failed</td></tr> <tr><td style="text-align: center;">64</td><td>ROM test failed</td></tr> <tr><td style="text-align: center;">128</td><td>External RAM test failed</td></tr> <tr><td style="text-align: center;">256</td><td>Internal RAM test failed</td></tr> </tbody> </table>	Number	State	0	Passes	1	A/ D self-test failed	2	A/D dead	4	EEPROM instrument configuration bad	8	EEPROM calibration data bad	16	Display dead	32	Display self-test failed	64	ROM test failed	128	External RAM test failed	256	Internal RAM test failed
Number	State																							
0	Passes																							
1	A/ D self-test failed																							
2	A/D dead																							
4	EEPROM instrument configuration bad																							
8	EEPROM calibration data bad																							
16	Display dead																							
32	Display self-test failed																							
64	ROM test failed																							
128	External RAM test failed																							
256	Internal RAM test failed																							
*WAI	Wait-to-continue	<p>Command required by IEEE-488.2 standard. Non-operational in Fluke 45 Dual Display Multimeter. Command accepted but has no effect.</p>																						

### Function Commands and Queries

The commands in Table 5-11 relate to measurement functions. See Table 5-13 for ranges and measurement rates. Refer to Chapter 3 for a detailed description of each function.

Commands under Primary Display and Secondary Display cause functions to be performed on the primary display or secondary display, respectively.

**Table 5-11. Function Commands and Queries**

Commands		Function
Primary Display	Secondary Display	
AAC	AAC2	AC current
AACDC*	—	AC plus DC rms current. Available in the primary display only.
ADC	ADC2	DC current
—	CLR2	Clears measurement from secondary display if one shown
CONT	—	Continuity test. Available in the primary display only.
DIODE	DIODE2	Diode test
FREQ	FREQ2	Frequency
FUNC1 ?	—	Meter returns the function selected for the primary display as command mnemonic.  EXAMPLE: If frequency is selected for the primary display, "FUNC1?" returns "FREQ".
	FUNC2?	Meter returns the function selected for the secondary display as command mnemonic. If the secondary display is not in use, an Execution Error is generated.  EXAMPLE: If frequency is selected for the secondary display, "FUNC2?" returns "FREQ".
OHMS	OHMS2	Resistance
VAC	VAC2	AC volts
VACDC*	—	AC plus DC rms volts. Available in the primary display only.
VDC	VDC2	DC volts

\* If AACDC or VACDC is selected in the primary display, no other function can be selected for the secondary display. An execution error is generated if this is attempted.

### Function Modifier Commands and Queries

The commands in Table 5-12 relate to the function modifiers. A function modifier causes the meter to modify the normal operation of a measurement function (or perform an action on a measurement) before displaying a reading. For example, the relative modifier (REL) causes the meter to display the difference between a measured value and the relative base. The results of function modifier commands can only be shown in the primary display. Refer to Chapter 3 for a more information about each function modifier.

**Table 5-12. Function Modifier Commands and Queries**

Command	Description																																																
DB	Meter enters decibels modifier. Any reading shown in the primary display is in decibels.  An Execution Error is generated if the meter is not in a volts ac and/or dc function.																																																
DBCLR	Meter exits the decibels modifier and displays readings in normal units. Also clears dB Power, REL, and MN MX modifiers.																																																
DBPOWER	Meter enters dB Power modifier if the reference impedance is set to 2, 4, 8, or 16 ohms and a voltage function has been selected. Otherwise an Execution Error is generated. In dB Power, readings shown in the primary display are in Watts.																																																
DBREF <value>	Set dB reference impedance to a <value> shown in Table 5-10A. This value corresponds to the reference impedance (ohms) indicated.  If <value> is not a value in Table 5-10A, an Execution Error is generated.																																																
<p><b>Table 5-12A. Reference Impedance Values</b></p> <table border="1" style="margin: auto; border-collapse: collapse;"> <thead> <tr> <th style="width: 15%;">Value</th> <th style="width: 15%;">Ref Impedance</th> <th style="width: 15%;">Value</th> <th style="width: 15%;">Ref Impedance</th> </tr> </thead> <tbody> <tr><td style="text-align: center;">1</td><td style="text-align: center;">2</td><td style="text-align: center;">12</td><td style="text-align: center;">150</td></tr> <tr><td style="text-align: center;">2</td><td style="text-align: center;">4</td><td style="text-align: center;">13</td><td style="text-align: center;">250</td></tr> <tr><td style="text-align: center;">3</td><td style="text-align: center;">8</td><td style="text-align: center;">14</td><td style="text-align: center;">300</td></tr> <tr><td style="text-align: center;">4</td><td style="text-align: center;">16</td><td style="text-align: center;">15</td><td style="text-align: center;">500</td></tr> <tr><td style="text-align: center;">5</td><td style="text-align: center;">50</td><td style="text-align: center;">16</td><td style="text-align: center;">600</td></tr> <tr><td style="text-align: center;">6</td><td style="text-align: center;">75</td><td style="text-align: center;">17</td><td style="text-align: center;">800</td></tr> <tr><td style="text-align: center;">7</td><td style="text-align: center;">93</td><td style="text-align: center;">18</td><td style="text-align: center;">900</td></tr> <tr><td style="text-align: center;">8</td><td style="text-align: center;">110</td><td style="text-align: center;">19</td><td style="text-align: center;">1000</td></tr> <tr><td style="text-align: center;">9</td><td style="text-align: center;">124</td><td style="text-align: center;">20</td><td style="text-align: center;">1200</td></tr> <tr><td style="text-align: center;">10</td><td style="text-align: center;">125</td><td style="text-align: center;">21</td><td style="text-align: center;">8000</td></tr> <tr><td style="text-align: center;">11</td><td style="text-align: center;">135</td><td></td><td></td></tr> </tbody> </table>		Value	Ref Impedance	Value	Ref Impedance	1	2	12	150	2	4	13	250	3	8	14	300	4	16	15	500	5	50	16	600	6	75	17	800	7	93	18	900	8	110	19	1000	9	124	20	1200	10	125	21	8000	11	135		
Value	Ref Impedance	Value	Ref Impedance																																														
1	2	12	150																																														
2	4	13	250																																														
3	8	14	300																																														
4	16	15	500																																														
5	50	16	600																																														
6	75	17	800																																														
7	93	18	900																																														
8	110	19	1000																																														
9	124	20	1200																																														
10	125	21	8000																																														
11	135																																																
DBREF?	Meter returns a <value> shown in Table 5-11A. This value corresponds to the reference impedance indicated.																																																
HOLD	Meter enters Touch Hold modifier. (See "HOLD Modifier" in Chapter 3 for more on Touch Hold.) If HOLD is sent when the meter is already in Touch Hold, a reading is forced and shown on the display.																																																
HOLDCLR	Meter exits Touch Hold and restores display to normal operation.																																																
HOLDTHRESH <threshold>	Set HOLD measurement threshold to <threshold>. <threshold> must be "1" (very stable), "2" (stable), or "3" (noisy). Any other value generates an Execution Error. See "HOLD Modifier" in Chapter 3.																																																
HOLDTHRESH?	Meter returns Touch Hold <threshold> (i.e., "1", "2", or "3"). See "HOLD Modifier" in Chapter 3 for a description of Touch Hold thresholds.																																																
MAX	Meter enters MN MX modifier with present reading as maximum value. If already in MN MX modifier, meter displays maximum value. In MN MX modifier, autoranging is disabled. See "MN MX Modifier" in Chapter 3.																																																

Table 5-12. Function Modifier Commands and Queries (cont.)

Command	Description
MAXSET <numeric value>	Meter enters MN MX modifier with <numeric value> as the maximum value. <numeric value> can be a signed integer, signed real number without exponent, or signed real number with exponent. Autoranging is disabled. See "MN MX Modifier" in Chapter 3.  If <numeric value> exceeds the measurement range, an Execution Error is generated.
MIN	Meter enters MN MX modifier with present reading as minimum value. If already in MN MX modifier, meter displays minimum value. In MN MX modifier, autoranging is disabled. See "MN MX Modifier" in Chapter 3.
MINSET <numeric value>	Meter enters MN MX modifier with <numeric value> as the minimum value. <numeric value> can be a signed integer, signed real number without exponent, or signed real number with exponent. Autoranging is disabled. See "MN MX Modifier" in Chapter 3.  If <numeric value> exceeds the measurement range, an Execution Error is generated.
MMCLR	Meter exits the MN MX modifier. The stored minimum and maximum values are lost, and the meter returns to the ranging mode and range selected prior to selecting MN MX modifier.
	<i>Note</i>  <i>When the MN MX modifier is selected, you can toggle between displaying the minimum and maximum reading without losing the minimum and maximum values stored.</i>
MOD?	Meter returns a numeric value indicating modifiers in use. 1 = MN, 2 = MX, 4=HOLD, 8=dB, 16=dB Power, 32=REL, 64=COMP.  If multiple modifiers are selected, the value returned is equal to the sum of the values of the selected modifiers. For example, if dB and REL are selected, "40" is returned.
REL	Meter enters the relative (REL) modifier, using the value shown on the primary display as the relative base. Autoranging is disabled. See "REL Modifier" in Chapter 3 for more on the relative modifier.
RELCLR	Meter exits the relative modifier and returns to the ranging mode and range selected prior to selecting the relative modifier.
RELSET <relative base>	Meter enters the relative (REL) modifier, using <relative base> as the offset <relative base> value.  <relative base> can be a signed integer, signed real number without exponent, or signed real number with exponent. Autoranging is disabled.  If <relative base> exceeds the measurement range, an Execution Error is generated. See "REL Modifier" in Chapter 3 for more on the relative modifier.
RELSET?	Meter returns <relative base>. If the relative modifier has not been selected, an Execution Error is generated.



**Range and Measurement Rate Commands and Queries**

The commands in Table 5-13 relate to ranging and measurement rates (i.e., readings/second). In the autorange mode, the meter automatically selects a range for each reading; in the manual range mode, the user selects a fixed range.

**Table 5-13. Range and Measurement Rate Commands and Queries**

Command	Description																																								
AUTO	Causes the meter to enter the autoranging mode on the primary display. If the autorange mode cannot be selected (e.g., if REL, dB, MN MX, or diode/continuity test is selected), an Execution Error is generated.																																								
AUTO?	Causes meter to return "1" if it is in autorange, or "0" if it is not.																																								
FIXED	Causes the meter to exit autoranging on the primary display and enter manual ranging. The present range becomes the selected range.																																								
RANGE <range>	Sets the primary display to the range designated by <range>. <range> is a number between 1 and 7 that corresponds to a range shown in Tables 5-12A and 5-12B.																																								
<b>Table 5-13A. Ranges at Fast &amp; Medium Measurement Rate</b>																																									
<table border="1"> <thead> <tr> <th>Range Value</th> <th>Voltage Range</th> <th>Ohms Range</th> <th>Current Range</th> <th>Frequency Range</th> </tr> </thead> <tbody> <tr> <td>1</td> <td>300 mV</td> <td>300 Ω</td> <td>30 mA</td> <td>1000 Hz</td> </tr> <tr> <td>2</td> <td>3 V</td> <td>3 kΩ</td> <td>100 mA</td> <td>10 kHz</td> </tr> <tr> <td>3</td> <td>30 V</td> <td>30 kΩ</td> <td>10 A</td> <td>100 kHz</td> </tr> <tr> <td>4</td> <td>300 V</td> <td>300 kΩ</td> <td>ERROR</td> <td>1000 kHz</td> </tr> <tr> <td>5</td> <td>1000 V dc*</td> <td>3 MΩ</td> <td>ERROR</td> <td>1 MHz</td> </tr> <tr> <td>6</td> <td>ERROR</td> <td>30 MΩ</td> <td>ERROR</td> <td>ERROR</td> </tr> <tr> <td>7</td> <td>ERROR</td> <td>300 MΩ</td> <td>ERROR</td> <td>ERROR</td> </tr> </tbody> </table>		Range Value	Voltage Range	Ohms Range	Current Range	Frequency Range	1	300 mV	300 Ω	30 mA	1000 Hz	2	3 V	3 kΩ	100 mA	10 kHz	3	30 V	30 kΩ	10 A	100 kHz	4	300 V	300 kΩ	ERROR	1000 kHz	5	1000 V dc*	3 MΩ	ERROR	1 MHz	6	ERROR	30 MΩ	ERROR	ERROR	7	ERROR	300 MΩ	ERROR	ERROR
Range Value	Voltage Range	Ohms Range	Current Range	Frequency Range																																					
1	300 mV	300 Ω	30 mA	1000 Hz																																					
2	3 V	3 kΩ	100 mA	10 kHz																																					
3	30 V	30 kΩ	10 A	100 kHz																																					
4	300 V	300 kΩ	ERROR	1000 kHz																																					
5	1000 V dc*	3 MΩ	ERROR	1 MHz																																					
6	ERROR	30 MΩ	ERROR	ERROR																																					
7	ERROR	300 MΩ	ERROR	ERROR																																					
* 1000 V dc, 750 V ac																																									
<b>Table 5-13B. Ranges at Slow Measurement Rate</b>																																									
<table border="1"> <thead> <tr> <th>Range Value</th> <th>Voltage Range</th> <th>Ohms Range</th> <th>Current Range</th> <th>Frequency Range</th> </tr> </thead> <tbody> <tr> <td>1</td> <td>100 mV</td> <td>100 Ω</td> <td>10 mA</td> <td>1000 Hz</td> </tr> <tr> <td>2</td> <td>1000 mV</td> <td>1000 Ω</td> <td>100 mA</td> <td>10 kHz</td> </tr> <tr> <td>3</td> <td>10 V</td> <td>10 kΩ</td> <td>10 A</td> <td>100 kHz</td> </tr> <tr> <td>4</td> <td>100 V</td> <td>100 kΩ</td> <td>ERROR</td> <td>1000 kHz</td> </tr> <tr> <td>5</td> <td>1000 V dc*</td> <td>1000 kΩ</td> <td>ERROR</td> <td>1 MHz</td> </tr> <tr> <td>6</td> <td>ERROR</td> <td>10 MΩ</td> <td>ERROR</td> <td>ERROR</td> </tr> <tr> <td>7</td> <td>ERROR</td> <td>100 MΩ</td> <td>ERROR</td> <td>ERROR</td> </tr> </tbody> </table>		Range Value	Voltage Range	Ohms Range	Current Range	Frequency Range	1	100 mV	100 Ω	10 mA	1000 Hz	2	1000 mV	1000 Ω	100 mA	10 kHz	3	10 V	10 kΩ	10 A	100 kHz	4	100 V	100 kΩ	ERROR	1000 kHz	5	1000 V dc*	1000 kΩ	ERROR	1 MHz	6	ERROR	10 MΩ	ERROR	ERROR	7	ERROR	100 MΩ	ERROR	ERROR
Range Value	Voltage Range	Ohms Range	Current Range	Frequency Range																																					
1	100 mV	100 Ω	10 mA	1000 Hz																																					
2	1000 mV	1000 Ω	100 mA	10 kHz																																					
3	10 V	10 kΩ	10 A	100 kHz																																					
4	100 V	100 kΩ	ERROR	1000 kHz																																					
5	1000 V dc*	1000 kΩ	ERROR	1 MHz																																					
6	ERROR	10 MΩ	ERROR	ERROR																																					
7	ERROR	100 MΩ	ERROR	ERROR																																					
* 1000 V dc, 750 V ac																																									

Table 5-13. Range and Measurement Rate Commands and Queries (cont.)

Command	Description
RANGE1?	Returns the range presently selected on the primary display.
RANGE2?	Returns the range presently selected on the secondary display. If the secondary display is inactive, an Execution Error is generated.
RATE <speed>	Sets the measurement rate to <speed>. <speed> is either "S" for slow (2.5 readings/second), "M" for medium (5 readings/second), or "F" for fast (20 readings/second). "S", "M", and "F" can be sent as either upper- or lower-case letters. Any other entry for <speed> generates an Execution Error.
RATE?	Returns <speed> as "S" for slow (2.5 readings/second), "M" for medium (5.0 readings/second), or "F" for fast (20 readings/second).

### Measurement Queries

The commands in Table 5-14 cause the meter to return readings shown on the primary and/or secondary displays.

Table 5-14. Measurement Queries

Command	Description
MEAS1?	Meter returns the value shown on the primary display after the <i>next triggered measurement is complete</i>
MEAS2?	Meter returns the value shown on the secondary display after the <i>next triggered measurement is complete</i> If the secondary display is off, an Execution Error is generated.
MEAS?	If both displays are on, meter returns the value shown on both displays after the next triggered measurement <i>is complete</i> in the format selected. These values are separated by a comma (format 1); or a space, measurement units, a comma and space (format 2). See FORMAT command in Table 5-15.  Example of Format 1: +1.2345E+0,+6.7890E+3<CR><LF>  Example of Format 2: +1.2345E+0 VDC, +6.7890E+3 ADC<CR><LF>  If the secondary display is not on, MEAS? is equivalent to MEAS1?  <i>Note</i>  <i>If MEAS is used in external trigger (TRIGGER 2 through TRIGGER 5), unexpected results will be obtained.</i>
VAL1?	Meter returns the value shown on the primary display. If the primary display is blank, the next triggered measurement is returned.
VAL2?	Meter returns the value shown on the secondary display. If the secondary display is blank, the next triggered measurement is returned. If the secondary display is off, an execution error is generated.
VAL?	If both displays are on, meter returns the value shown on both displays in the format selected. These values are separated by a comma (format 1); or a space, measurement units, a comma and space (format 2). See FORMAT command in Table 5-15.  Example of Format 1: +1.2345E+0,+6.7890E+3<CR><LF> Example of Format 2: +1.2345E+0 VDC, +6.7890E+3 ADC<CR><LF> If the secondary display is not on, VAL is equivalent to VAL1. If a display is blank, the next triggered measurement on that display (or displays) is returned.

### Compare Commands and Queries

The commands in Table 5-15 cause the meter to determine whether a measurement is higher than, lower than, or within a specified range. These commands correspond to the COMP, HI, and LO buttons on the front panel.

**Table 5-15. Compare Commands and Queries**

Command	Description
COMP	Meter enters compare (COMP) function. Touch Hold is automatically turned on. (Touch Hold can be turned off with "HOLDCLR" command.)
COMP?	Meter returns "HI" if the last COMP measurement reading was above the compare range, "LO" if it was below it, "PASS" if within compare range, or "—" if a measurement has not completed.
COMPCLR	Meter exits compare function (and Touch Hold if it is selected), and restores display to normal operation.
COMPHI <high value>	Sets "HI" compare (COMP) value to <high value>. <high value> can be a signed integer, signed real number without exponent, or signed real number with exponent.
COMPLO <low value>	Sets "LO" compare (COMP) value to <low value>. <low value> can be a signed integer, signed real number without exponent, or signed real number with exponent.
HOLDCLR	Meter exits Touch Hold and restores display to normal operation, but does not exit the compare function.

### Trigger Configuration Commands

The commands in Table 5-16 set and return the trigger configuration.

**Table 5-16. Trigger Configuration Commands**

Command	Description																								
TRIGGER <type>	<p>Sets the trigger configuration to &lt;type&gt;.</p> <p>&lt;type&gt; corresponds to a number between 1 and 5 selected from Table 5-15A. If the &lt;type&gt; entered is not one of these numbers, an Execution Error is generated.</p> <p style="text-align: center;"><b>Table 5-15A. Trigger Type</b></p> <table border="1" style="margin-left: auto; margin-right: auto;"> <thead> <tr> <th style="text-align: center;">Type</th> <th style="text-align: center;">Trigger</th> <th style="text-align: center;">Rear Trigger</th> <th style="text-align: center;">Settling Delay</th> </tr> </thead> <tbody> <tr> <td style="text-align: center;">1</td> <td style="text-align: center;">Internal</td> <td style="text-align: center;">Disabled</td> <td style="text-align: center;">—</td> </tr> <tr> <td style="text-align: center;">2</td> <td style="text-align: center;">External</td> <td style="text-align: center;">Disabled</td> <td style="text-align: center;">Off</td> </tr> <tr> <td style="text-align: center;">3</td> <td style="text-align: center;">External</td> <td style="text-align: center;">Disabled</td> <td style="text-align: center;">On</td> </tr> <tr> <td style="text-align: center;">4</td> <td style="text-align: center;">External</td> <td style="text-align: center;">Enabled</td> <td style="text-align: center;">Off</td> </tr> <tr> <td style="text-align: center;">5</td> <td style="text-align: center;">External</td> <td style="text-align: center;">Enabled</td> <td style="text-align: center;">On</td> </tr> </tbody> </table>	Type	Trigger	Rear Trigger	Settling Delay	1	Internal	Disabled	—	2	External	Disabled	Off	3	External	Disabled	On	4	External	Enabled	Off	5	External	Enabled	On
Type	Trigger	Rear Trigger	Settling Delay																						
1	Internal	Disabled	—																						
2	External	Disabled	Off																						
3	External	Disabled	On																						
4	External	Enabled	Off																						
5	External	Enabled	On																						
TRIGGER?	<p>Select a trigger type with the settling delay (type 3 or 5) enabled when the input signal is not stable before a measurement is triggered. Typical settling delays are provided in Table 4-4.</p> <p>Returns the trigger &lt;type&gt; set by the TRIGGER command.</p>																								

**Miscellaneous Commands and Queries**

Miscellaneous commands and queries are summarized in Table 5-17.



**Table 5-17. Miscellaneous Commands and Queries**

Command	Description																
^C (CNTRL C) FORMAT <frmt>          FORMAT? SERIAL?	<p>The RS-232 equivalent of IEEE-488 DCL. Causes &lt;CR&gt;&lt;LF&gt; and =&gt;&lt;CR&gt;&lt;LF&gt;_to be output.</p> <p>Set output &lt;frmt&gt; to "1" or "2". Format 1 is compatible with IEEE-488.2.</p> <p>Format 1 outputs measurement values <i>without</i> measurement units (e.g., "VDC," "ADC," "OHMS," etc.).</p> <p>Format 2 allows measurement units (as represented below) to be output with measurement values. Format 2 is intended primarily for use with RS-232 print-only mode.</p> <p style="text-align: center;"><b>Table 5-16A. Measurement Units Output with Format 2</b></p> <table border="1" data-bbox="522 774 1304 1066"> <thead> <tr> <th data-bbox="522 774 922 823">Measurement Function</th> <th data-bbox="922 774 1304 823">Units Output As</th> </tr> </thead> <tbody> <tr> <td data-bbox="522 823 922 863">Volts dc</td> <td data-bbox="922 823 1304 863">VDC</td> </tr> <tr> <td data-bbox="522 863 922 900">Volts ac</td> <td data-bbox="922 863 1304 900">VAC</td> </tr> <tr> <td data-bbox="522 900 922 938">Amps dc</td> <td data-bbox="922 900 1304 938">ADC</td> </tr> <tr> <td data-bbox="522 938 922 976">Amps ac</td> <td data-bbox="922 938 1304 976">AAC</td> </tr> <tr> <td data-bbox="522 976 922 1014">Resistance</td> <td data-bbox="922 976 1304 1014">OHMS</td> </tr> <tr> <td data-bbox="522 1014 922 1052">Frequency</td> <td data-bbox="922 1014 1304 1052">HZ</td> </tr> <tr> <td data-bbox="522 1052 922 1066">Diode/Continuity Test</td> <td data-bbox="922 1052 1304 1066">VDC</td> </tr> </tbody> </table> <p>Meter returns &lt;frmt&gt; in use as "1" or "2".</p> <p>Meter returns its serial number.</p>	Measurement Function	Units Output As	Volts dc	VDC	Volts ac	VAC	Amps dc	ADC	Amps ac	AAC	Resistance	OHMS	Frequency	HZ	Diode/Continuity Test	VDC
Measurement Function	Units Output As																
Volts dc	VDC																
Volts ac	VAC																
Amps dc	ADC																
Amps ac	AAC																
Resistance	OHMS																
Frequency	HZ																
Diode/Continuity Test	VDC																

**RS-232 Remote/Local Configurations**

The commands in Table 5-18 are used with the RS-232 interface to set up the Remote/ Local configuration of the meter. These commands are valid only when the RS-232 interface is enabled.

**Table 5-18. Remote/Local Configuration Commands**

Command	Description
REMS	<p>Puts the meter into the IEEE-488 REMS state, i.e., IEEE-488 remote operating mode without front panel lockout. "REMOTE" is shown on the display.</p> <p>When in the IEEE-488 REMS state (remote): pressing  (LOCAL) returns the meter to local (i.e., front panel) control; pressing  triggers a measurement if external triggering is enabled. All other front panel buttons are disabled.</p>
RWLS	<p>Puts the meter in the IEEE-488 RWLS state, i.e., IEEE-488 remote operating mode with front panel lockout. "REMOTE" is shown on the display. When in RWLS, all front panel buttons are disabled.</p>
LOCS	<p>Puts the meter in the IEEE-488 LOOS state, i.e., local operating mode without lockout. All front panel buttons are enabled.</p>
LWLS	<p>Puts the meter in the IEEE-488 LWLS state, i.e., local operating mode lockout. All front panel buttons are disabled.</p>

## Sample Program Using the RS-232 Computer Interface

Figure 5-5 is an annotated BASIC A program, written for an IBM PC (or compatible), that demonstrates how the meter can be used with the RS-232 computer interface.

```

10 ' EXAMPLE.BAS Fluke 45 program to record magnitude and frequency data
11 '           - initialize RS-232 communication and set up Fluke 45
12 '           - check command acceptance by Fluke 45
13 '           - display and record measurement data in 'TESTDATA.PRN'
100 CLS : KEY OFF
110 RESULTS = "" ' Define data input
120 PROMPTS = "" ' Define string to hold command completion prompt
130 CMD$ = "" ' Define string to hold command to Fluke 45
140 IN$ = "" ' Define input string
150 ESC$ = CHR$(27) ' Define program termination command string
160 COUNT = 0 ' Initialize number of readings
200 '
201 ' Open communications port 9600 Baud, no parity, 8 bit data,
202 '   ignore Clear to Send, Data Set Ready, Carrier Detect
210 OPEN "com1:9600,n,8,,cs,ds,cd" AS #1
220 IF ERRORCODE <> 0 THEN PRINT "ERROR - Could not open com1:" : END
221 '
230 OPEN "testdata.prn" FOR OUTPUT AS #2 ' Open data file
231 '
232 ' Set up Fluke 45:
233 '   "rems" Put the Fluke 45 into Remote mode
234 '   "vac" Primary measurement is Volts AC
235 '   "db" Add decibels modifier to primary measurement
236 '   "freq2" Secondary display measurement to be frequency
237 '   "format 1" Data to be formatted without units
240 CMD$ = "rems; vac; db; freq2; format 1"
250 GOSUB 1000 ' Send command and get response
300 '
310 LOCATE 1, 1 : PRINT "Program to record Magnitude and Frequency data."
320 LOCATE 12, 15 : PRINT "Magnitude/Frequency: ";
330 LOCATE 25, 10 : PRINT "Press any key to record Press ESC key to exit";
331 '
340 WHILE IN$ <> ESC$
350 PRINT #1, "meas?" ' Request next measurement results
360 ECHOS = INPUT$(LEN("meas?")+2, #1) ' Discard echoed command string
370 LINE INPUT #1, RESULTS ' Get the measurements
380 PROMPTS = INPUT$(5, #1) ' Get the prompt + trailing <LF>
390 LOCATE 12, 36 : PRINT RESULTS; ' Print the measurement result
400 IN$ = INKEY$ ' Read the keyboard buffer
401 ' If a key has been pressed, record the data
410 IF IN$ = "" OR IN$ = ESC$ THEN GOTO 450
420 PRINT #2, RESULTS ' Store data in Lotus ".PRN" format
430 COUNT = COUNT + 1 ' Increment number of readings
440 LOCATE 13, 32 : PRINT COUNT; " Readings recorded";
441 ' ENDIF
450 WEND
460 LOCATE 14, 1 : PRINT "Test Complete - Data stored in 'TESTDATA.PRN'";
470 CLOSE 1, 2
480 KEY ON
490 END
1000 '
1001 ' Subroutine: Command_check
1002 ' Reads and discards echoed commands and checks for error response prompt
1003 ' The possible command responses are:
1004 '   "=><CR><LF>" (command successful)
1005 '   "?><CR><LF>" (command syntax error)
1006 '   "!=><CR><LF>" (command execution error)
1007 '
1010 PRINT #1, CMD$
1020 ECHOS = INPUT$(LEN(CMD$)+2, #1) ' Discard echoed command string
1030 PROMPTS = INPUT$(4, #1) ' Get prompt
1040 IF INSTR(1, PROMPTS, "=>") <> 0 THEN RETURN ' Command successful
1050 IF INSTR(1, PROMPTS, "?>") <> 0 THEN PRINT "Command syntax!!"
1060 IF INSTR(1, PROMPTS, "!=>") <> 0 THEN PRINT "Command failure!!"
1070 PRINT "Program execution Halted"
1080 END

```

aam23f.eps

Figure 5-5. Sample Program for RS-232 Computer Interface

## Sample Programs Using the IEEE-488 Computer Interface

Figure 5-6 illustrates three annotated GWBASIC programs, that demonstrate how the meter can be used with three different IEEE-488 Interface driver cards.

```

1 'DEMONSTRATION PROGRAM FOR THE FLUKE 45 USING THE PHILIPS PM2201
2 'IEEE-488 DRIVER
3 CLEAR ,64000!
4 INIT1 = 64000! : INIT2 = INIT1 + 2
5 DIM A%(26)
6 BLOAD "IOBIB.M", INIT1
7 CALL INIT1(A%(0),A%(1),A%(2),A%(3),A%(4),A%(5),A%(6),A%(7),A%(8),A%(9),
A%(10),A%(11),A%(12),A%(13),A%(14),A%(15),A%(16),A%(17),A%(18),A%(19),A%(20),A
%(21),A%(22),A%(23),A%(24))
8 CALL INIT2(A%(25),A%(26))
9 '
10 IOINIT      = INIT1 + A%(0)
11 IORESET     = INIT1 + A%(1)
12 IOABORT     = INIT1 + A%(2)
13 IOCONTROL   = INIT1 + A%(3)
14 IOEOI       = INIT1 + A%(4)
15 IOEOL       = INIT1 + A%(5)
16 IOGETTERM   = INIT1 + A%(6)
17 IOMATCH     = INIT1 + A%(7)
18 IOOUTPUTS   = INIT1 + A%(8)
19 IOOUTPUT    = INIT1 + A%(9)
20 IOOUTPUTA   = INIT1 + A%(10)
21 IOENTERS    = INIT1 + A%(11)
22 IOENTER     = INIT1 + A%(12)
23 IOENTERA    = INIT1 + A%(13)
24 IOSEND      = INIT1 + A%(14)
25 IOS POLL    = INIT1 + A%(15)
26 IOSTATUS    = INIT1 + A%(16)
27 IOTIMEOUT   = INIT1 + A%(17)
28 IOREMOTE    = INIT1 + A%(18)
29 IOLOCAL     = INIT1 + A%(19)
30 IOLLOCKOUT  = INIT1 + A%(20)
31 IOCLEAR     = INIT1 + A%(21)
32 IOTRIGGER   = INIT1 + A%(22)
33 IOGTS       = INIT1 + A%(23)
34 IORSV       = INIT1 + A%(24)
35 IOWAIT      = INIT1 + A%(25)
36 '
37 DEF.ERR     = INIT1 + A%(26)
38 PCIB.ERR$   = SPACE$(40)
39 CALL DEF.ERR(PCIB.ERR, PCIB.ERR$)
40 FALSE      = 0
41 TRUE       = 1
42 NOERR      = 0
43 EOFLOW     = 14
44 EUNKNOWN   = 100001!
45 ESEL       = 100002!
46 ERANGE     = 100003!
47 ETIME      = 100004!
48 ECTRL      = 100005!
49 EPASS      = 100006!
50 ENUM       = 100007!
51 EADDR      = 100008!
52 '
53 ERASE A%
54 '
55 'Start application program after this line
56 '
100 '***** Demo program for the Fluke 45 ****
    
```

aam24s.tif

Figure 5-6. Sample Programs for IEEE-488 Computer Interface

```

110 '
120 'Initialisations
130 '
140 CLS
150 AD=7 'Adapter number is 7
160 DMM=702 'GPIB address of Fluke 45 is 2
170 SC=1 'Controller is system controller
180 RESULT=0
190 X=0
200 '
210 CALL IORESET(AD) 'Initialisation of GPIB
220 GOSUB 630 'Error handling routine
230 CALL IOCLEAR(DMM) 'Clear the Fluke 45
240 TIME=20
250 CALL IOTIMEOUT(AD,TIME) 'Set timeout to 20 seconds
260 '
270 'Setup the Fluke 45
280 '
290 'VDC: Select the DC Volts function
300 'AUTO: Enable Autoranging
310 'TRIGGER 3: Set External Trigger, delay enabled
320 '*RST: Reset the Fluke 45
330 '
340 '
350 '
360 CMD$="VDC;AUTO;TRIGGER 3" 'Set-up command to DMM
370 RST$="*RST"
380 RD$="MEAS?" 'Command the DMM to make a measurement

390 NCHAR=LEN(CMD$) 'Number of characters in CMD$
400 RCHAR=LEN(RD$) 'Number of characters in RD$
410 CALL IOOUTPUTS(DMM,CMD$,NCHAR) 'Send string to set up Fluke 45
420 GOSUB 630 'Error handling routine
430 '
440 'Read and display 10 measured values
450 '
460 PRINT "MEASUREMENTS RECEIVED FROM THE FLUKE 45"
470 PRINT
480 FOR I=1 TO 10
490 CALL IOTRIGGER(DMM) 'Trigger the Fluke 45
500 EVENT=1
520 STAT=0
530 CALL IOOUTPUTS(DMM,RD$,RCHAR) 'Ask the 45 for its reading
540 CALL IOENTER(DMM,RESULT) 'Input a numeric value from Fluke 45
550 GOSUB 630 'Error handling routine
560 IF PCIB.ERR=0 THEN PRINT "Reading = ";I;" = ";RESULT
570 STAT=0
580 NEXT I
590 CALL IOOUTPUTS(DMM,RST$,RCHAR) 'Reset the DMM
600 CALL IOLOCAL(DMM)
610 END
620 '
630 'Error handler
640 IF PCIB.ERR>0 THEN PRINT "error is: ",PCIB.ERR$
650 IF (PCIB.ERR=100007!) OR (PCIB.ERR=0) THEN RETURN ELSE END

```

aam25s.tif

Figure 5-6. Sample Programs for IEEE-488 Computer Interface (cont.)



```

1  'DEMONSTRATION PROGRAM FOR THE FLUKE 45 USING THE NATIONAL GPIB-PC
2  'IEEE-488 DRIVER WITH A PCIIA INTERFACE CARD
10  CLEAR ,60000! : IBINIT1=60000! : IBINIT2=IBINIT1+3 :
    BLOAD "bib.m",IBINIT1
20  CALL IBINIT1 (IBFIND,IBTRG,IBCLR,IBPCT,IBSIC,IBLOC,IBPPC,IBBNA,IBONL,
    IBRSC,IBSRE,IBRSV,IBPAD,IBSAD,IBIST,IBDMA,IBEOS,IBTMO,IBEOT,IBRDF,IBWRTF,IBTRA
    P)
30  CALL IBINIT2 (IBGTS,IBCAC,IBWAIT,IBPOKE,IBWRT,IBWRTA,IBCMD,IBCMDA,
    IBRD,IBRDA,IBSTOP,IBRPP,IBRSP,IBDIAG,IBXTRC,IBRDI,IBWRTI,IBRDIA,IBWRTIA,IBSTA%
    ,IBERR%,IBCNT%)
40  CLS
50  BDNAMES$="DEV2"                'Device at address 2
60  V%=&HA+&H400                    'Set end of receive string to LF
70  RD$=SPACE$(30)                  'Reading place holder
80  CALL IBFIND (BDNAME$,DEV2%)      'Initialize
90  'Must set this to receive data from the Fluke 45
100 CALL IBEOS (DEV2%,V%)           'Set End-of-String on interface
110 IF DEV2%<0 THEN PRINT "Device not responding": GOTO 310
120 '
130 '*RST = Reset the Fluke 45; VDC = Volts AC in the primary display
140 'TRIGGER 2 = External trigger, without delay
150 '*TRG = Trigger the Fluke 45
160 'VAL? = Request the output from the triggered reading
170 '
180 CMD$="*RST; VDC; RANGE 2; TRIGGER 2"
190 TRG$="*TRG; VAL?"
200 '
210 CALL IBWRT (DEV2%,CMD$)
220 IF IBSTA%<0 THEN GOTO 320
230 FOR IN = 1 TO 10
240     CALL IBWRT (DEV2%,TRG$)
250     IF IBSTA%<0 THEN GOTO 320
260     CALL IBRD (DEV2%,RD$)
270     IF IBSTA%<0 THEN GOTO 320
280 '     Print the reading from IBRD less the line feed
290     PRINT "Reading ";IN;" = ";MID$(RD$,1,(IBCNT%-1))
300 NEXT IN
310 END
320 REM IEEE-488 error routine
330 PRINT "An IEEE-488 error occured"
340 PRINT "ERROR = ";IBERR
350 GOTO 310
    
```

aam26s.tif

Figure 5-6. Sample Programs for IEEE-488 Computer Interface (cont.)

```

10 'DEMONSTRATION PROGRAM FOR THE FLUKE 45 USING THE IOtech Personal488
20 'CONTROLLER PROGRAM
30 'PROGRAM NAME          DEMO45.BAS
40 CLS
50 '
60 OPEN "\DEV\IEEEEOUT" FOR OUTPUT AS #1
70 IOCTL#1,"BREAK"
80 PRINT#1,"RESET"
90 OPEN "\DEV\IEEEEIN" FOR INPUT AS #2
100 PRINT#1,"FILL ERROR"
110 '
120 ON ERROR GOTO 340
130 PRINT#1,"ERROR OFF"
140 '
150 '*RST:  reset the Fluke 45
160 'VDC:  Select the DC Volts function
170 'RANGE 1:  Select the 300 mV range
180 'RATE M:  Select the Medium reading rate
190 'TRIGGER 2:  Select external trigger, no delay
200 '
210 'Send the command string to the Fluke 45
220 PRINT #1,"OUTPUT 02; *RST; VDC; RANGE 1; RATE M; TRIGGER 2"
230 '
240 'Trigger, input and display 20 readings
250 FOR IN=1 TO 20
260     PRINT #1,"OUTPUT 02; *TRG; VAL?"
270     'Set the driver to receive with a Line Feed and EOI terminator
280     PRINT #1,"ENTER 02 LF EOI"
290     LINE INPUT #2, A$
300     PRINT "Reading ";IN;" = ";A$
310 NEXT IN
320 END
330 '
340 ' Error Handler
350 '
360 IOCTL#1,"BREAK"
370 PRINT#1,"STATUS"
380 INPUT#2,ST$
390 PRINT CHR$(7);"Error #";MID$(ST$,15,2);": ";MID$(ST$,27)
400 RESUME NEXT

```

Figure 5-6. Sample Programs for IEEE-488 Computer Interface (cont.)

aam27s.tif



# Chapter 6

## Maintenance

### *Note*

*When servicing the meter, use only the replacement parts specified.*

### **Introduction**

Chapter 6 provides the information necessary for the user to perform basic maintenance. Users should not attempt to perform maintenance not described in this chapter. Qualified service personnel should refer to the 45 Service Manual (P/N 856042) for complete maintenance, service, and calibration procedures.

### **Cleaning**

#### **⚠ Warning**

**To avoid electrical shock or damage to the meter, never get water inside the case.**

#### **Caution**

**To avoid damaging the meters housing, never apply solvents to the meter.**

If the meter requires cleaning, wipe it down with a cloth that is lightly dampened with water or a mild detergent. Do not use aromatic hydrocarbons, chlorinated solvents, or methanol-based fluids when wiping down the meter.

### **Line Fuse**

The meter has a T 125mA, 250V, (Slow blow) line fuse in series with the power supply. This fuse is located on the rear panel. To replace this fuse, unplug the line cord and remove the fuse holder with fuse as shown in Figure 6-1. The meter is shipped with a replacement fuse.

#### **⚠ Warning**

**To avoid electric shock or fire, do not use makeshift fuses or short-circuit the fuse holder.**

## Current Input Fuses

The 100 mA and 10 A inputs are protected by user-replaceable fuses.

- The 100 mA input is protected by a fuse rated at F 500 mA, 250 V (Fast blow), 1500 A minimum breaking capacity, IEC-127 Sheet I.
- The 10 A input is protected by a fuse rated at F 15 A, 250 V (Fast blow), 10,000 A breaking capacity, [or F 15 A, 600 V, (Fast blow), 10,000 A minimum breaking capacity].

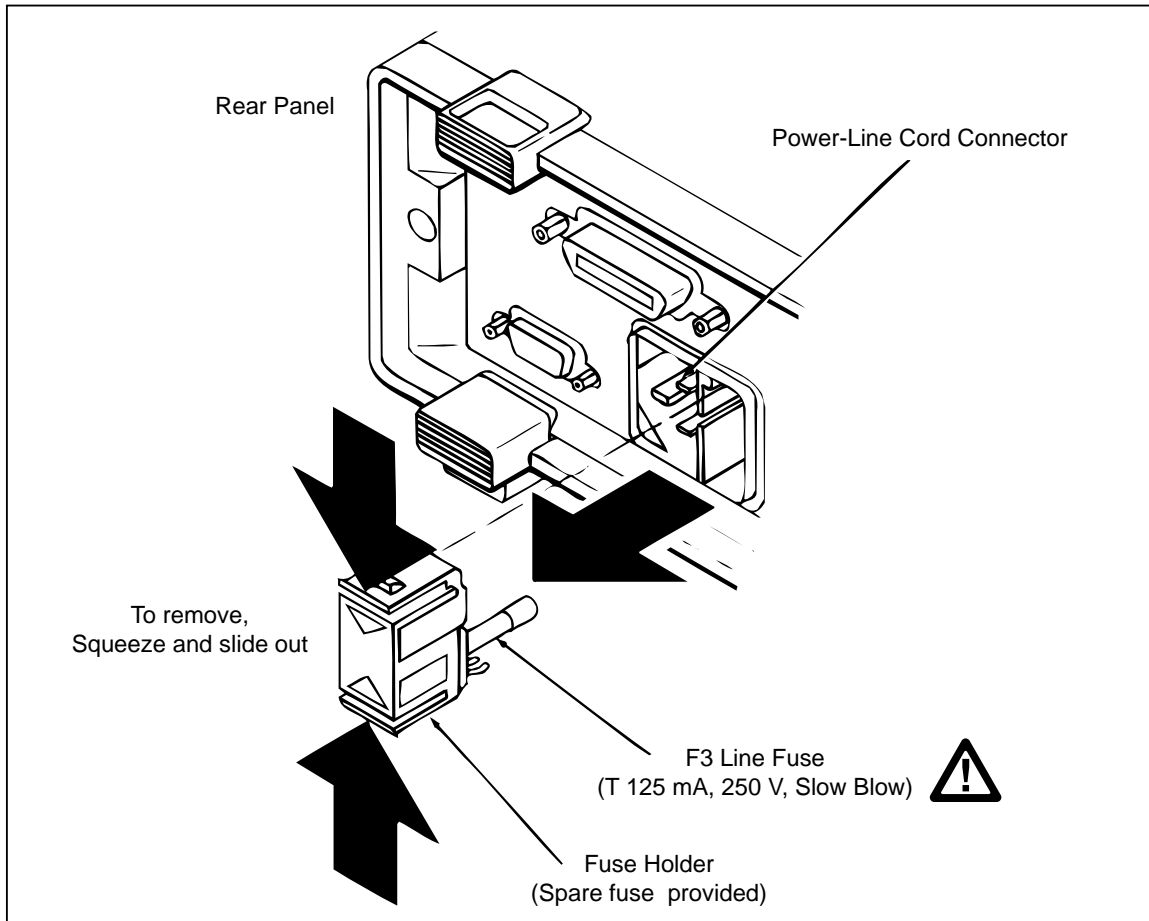

Figure 6-1. Replacing the Line Fuse

qb12f.eps

## Testing Current Input Fuses

Perform the following procedure to test these fuses:

1. Plug a test lead into the  $V\Omega \rightarrow +$  input terminal and power-up the meter.
2. Press  $\Omega$  to select the ohms function.
3. Insert the test lead probe into the 100 mA input terminal.

If the fuse is good, the meter will read between 11  $\Omega$  and 15  $\Omega$ . If the fuse is blown, the meter will read >10 M $\Omega$  to OL.

4. Remove the test lead probe from the 100 mA input terminal and insert it into the 10A input terminal.

If the fuse is good, the meter will read between  $.04 \Omega$  and  $1.0 \Omega$ . If the fuse is blown, the meter will read  $>10 \text{ M}\Omega$  to OL.

### Replacing the 100 mA Input Fuse

#### **⚠ Warning**

**For protection against fire or arc flash, replace a blown fuse only with one of identical rating.**

The 100 mA input fuse is mounted in the front panel input jack (see Figure 6-2).

To replace this fuse, first unplug the line cord. Then press in on the input jack and turn it 90 degrees counter-clockwise as shown in Figure 6-2. Slide out the fuse holder and fuse.

Replace a blown fuse with one of identical rating (see Table 6-5) and reinsert the fuse and holder into the input terminal socket. Secure the fuse holder by pressing in and turning the holder 90 degrees clockwise.

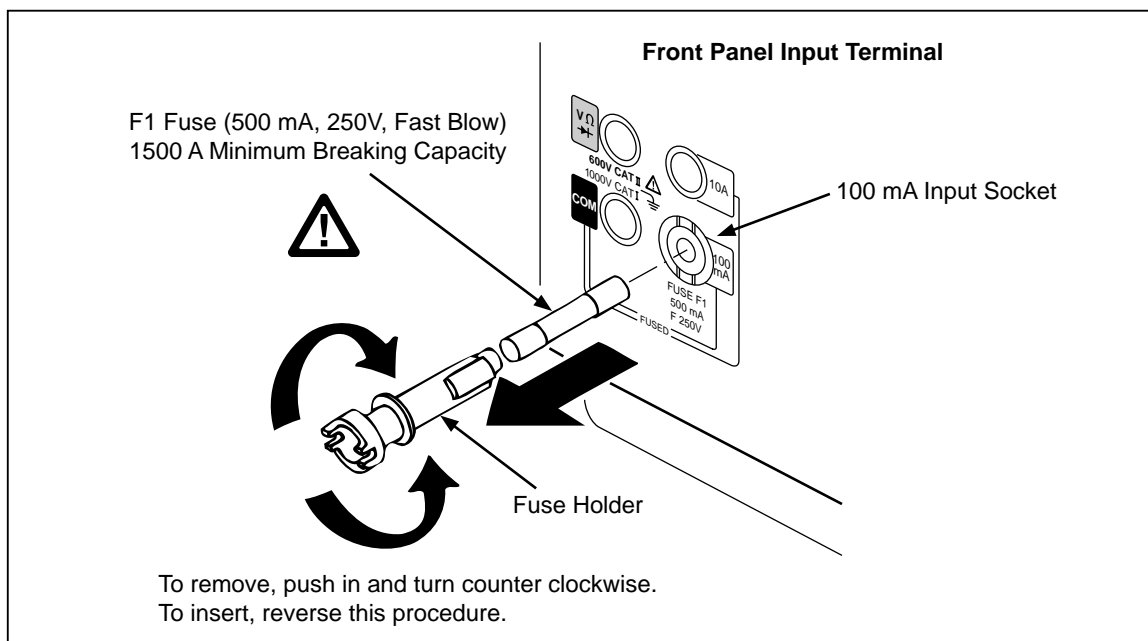

Figure 6-2. Replacing the 100 mA Input Fuse

qb13f.eps

### Replacing the 10 A Input Fuse

The 10 A input fuse is located inside the meter. To replace the fuse:

1. Remove the single Phillips-head screw on the bottom of the case and the Phillips-head screw on each side of the rear bezel.

#### **⚠ Warning**

**Opening the case may expose hazardous voltages. To avoid electric shock, always disconnect the power cord and measuring inputs before opening the case.**

2. Remove the bezel and slip the case back from the front of the meter. The fuse and fuse clip are visible at the front of the main printed circuit assembly (pca) near the input terminals.

3. Carefully remove the fuse and replace it with one rated as listed above.
4. Reverse the disassembly procedure to reassemble the meter.

## Self-Test Diagnostics and Error Codes

If the meter fails the self-test diagnostics performed at power-up, an error code is displayed in the primary display and "ERROR" is displayed in the secondary display. An error code is displayed for two seconds or until a button is pressed. Error codes are listed in Table 6-1.

**Table 6-1. Self-Test Error Codes**

Error No.	Meaning
1	ROM test failed
2	External RAM test failed
3	Internal RAM test failed
4	Display self-test failed
5	Display dead
6	EEPROM instrument configuration corrupted
7	EEPROM calibration data corrupted ("UNCAL" annunciator also lights)
8	A/D chip dead
9	Measurement self-test failed

## Performance Tests

The meter should be calibrated and in operating condition when you receive it.

The following performance tests are provided to ensure that the meter is in proper operating condition. If the instrument fails any of the performance tests, then calibration adjustment and/ or repair is needed. To perform these tests, you will need a Fluke 5700A Multifunction Calibrator and 5725A Amplifier (or equivalents).

Each of the measurements listed in the following steps assume the instrument is being tested after a one-hour warmup, in an environment with an ambient temperature of 18 °C to 28 °C, and a relative humidity of less than 90 % (70 % for 1,000 kΩ range and above).

*Note*

*All measurements listed in the performance test tables are made in the medium reading rate unless otherwise noted.*

1. Power-up the meter and allow it to stabilize for one hour.
2. Connect a cable from the Output VA HI and LO connectors of the 5700A to the **VΩ→** and COM connectors on the Fluke 45.

Select the function and range on the Fluke 45 and the input level from the 5700A using the values listed in Table 6-2. The display should read between the minimum and maximum values listed in the table.

3. Connect a cable from the Output VA HI and LO connectors of the 5700A to the 100 mA and COM connectors on the Fluke 45. Select the function and range on the Fluke 45 and the input level from the 5700A using the values contained in Table 6-3. The display should read between the minimum and maximum readings listed in the table.

- The following tests require a Fluke 5725A Amplifier (or equivalent) to be used with the 5700A. The input level for the performance test will be set on the 5700A but will be output from the 5725A Amplifier.

Connect a cable from the Output VA HI and LO connectors of the 5725A to the 10A and COM connectors on the Fluke 45. Select the function and range on the Fluke 45 and the input level from the 5700A using the values contained in Table 6-4. The display should read between the minimum and maximum readings listed in the table.

## Service

If you suspect that the meter has failed, review this manual to make sure you are operating it correctly. If the meter still fails to operate properly, pack it securely (in its original container if available) and forward it, postage paid, to the nearest Fluke Service Center. Include a brief description of the problem. Fluke assumes NO responsibility for damage in transit.

To locate an authorized service center, call Fluke using any of the phone numbers listed below, or visit us on the World Wide Web: [www.fluke.com](http://www.fluke.com)

1-800-44-FLUKE (1-800-443-5853) in U.S.A and Canada

31 40 267 8200 in Europe

1-425-356-5500 from other countries

**Table 6-2. Performance Tests for Volts, Diode Test, Ohms, and Frequency, Functions**

Function	Range (Rate)	Input Level	Frequency	Display	
				Min	Max
<b>V<sub>DC</sub></b>	100 mV (slow)	Short	—	-0.006	0.006
		+90 mV	—	89.971	90.029
	1000 mV (slow)	+900 mV	—	899.71	900.29
	300 mV	short	—	-0.02	0.02
		300 mV	—	299.90	300.10
	3 V	+3 V	—	2.9990	3.0010
		-3 V	—	-3.0010	-2.9990
	30 V	+30 V	—	29.990	30.010
300 V	+300 V	—	299.90	300.10	
	1000 V	+1000 V	—	999.5	1000.5
<b>▶+</b>	—	short	—	0.0008	0.0008
	—	open	—	(tone) OL	(tone) OL
<b>V<sub>AC</sub></b>	300 mV	Short	—	—	<75
		15 mV	1 kHz	14.87	15.13
			100 kHz	13.75	16.25
		300 mV	1 kHz	299.30	300.70
	3 V		100 kHz	284.50	315.50
		3.0 V	1 kHz	2.9930	3.0070
		30 V	1 kHz	29.930	30.070
		300 V	1 kHz	299.30	300.70
750 V	750 V	1 kHz	747.5	752.5	



Table 6-2. Performance Tests for Volts, Diode Test, Ohms, and Frequency, Functions (cont.)

Function	Range (Rate)	Input Level	Frequency	Display	
				Min	Max
$\Omega$	Using decades of 3:				
	300 $\Omega$	Short	—	0.00	0.04
		300 $\Omega$	—	299.83	300.19
	3 k $\Omega$	short	—	0.0000	0.0002
		3 k $\Omega$	—	2.9983	3.0017
	30 k $\Omega$	30 k $\Omega$	—	29.983	30.017
	300 k $\Omega$	300 k $\Omega$	—	299.83	300.17
	3 M $\Omega$	3 M $\Omega$	—	2.9980	3.0020
	30 M $\Omega$ *	30 M $\Omega$	—	29.922	30.078
	300 M $\Omega$ *	300 M $\Omega$	—	294.0	306.0
	Using decades of 1.9:				
	300 $\Omega$	Short	—	0.00	0.04
		190 $\Omega$	—	189.88	190.14
	3 k $\Omega$	short	—	0.0000	0.0002
		1.9 k $\Omega$	—	1.8988	1.9012
	30 k $\Omega$	19 k $\Omega$	—	18.988	19.012
	300 k $\Omega$	190 k $\Omega$	—	189.88	190.12
	3 M $\Omega$	1.9 M $\Omega$	—	1.8987	1.9013
	30 M $\Omega$ *	19 M $\Omega$	—	18.949	19.051
	300 M $\Omega$ *	190 M $\Omega$	—	186.2	193.8
	Using decades of 1:				
	300 $\Omega$	Short	—	0.00	0.04
		100 $\Omega$	—	99.93	100.09
	3 k $\Omega$	short	—	0.0000	0.0002
		1 k $\Omega$	—	0.9993	1.0007
	30 k $\Omega$	10 k $\Omega$	—	9.993	10.007
	300 k $\Omega$	100 k $\Omega$	—	99.93	100.07
	3 M $\Omega$	1 M $\Omega$	—	0.9992	1.0008
	30 M $\Omega$ *	10 M $\Omega$	—	9.972	10.028
	300 M $\Omega$ *	100 M $\Omega$	—	98.0	102.0
FREQ	10/100 kHz	0.1 V to 10 V	10 kHz	9.9949	10.006
* Optional test points that can be used if standards are available.					

**Table 6-3. Performance Tests for mA Current Functions**

Function	Range (Rate)	Input Level	Frequency	Display	
				Min	Max
<b>A<sup>==</sup></b> (mA)	30 mA	+30 mA	—	29.982	30.018
	100 mA	+100 mA	—	99.93	100.07
<b>A<sup>~</sup></b> (mA)	30 mA	30 mA	1 kHz	29.840	30.160
	100 mA	100 mA	1 kHz	99.40	100.60

**Table 6-4. Performance Tests for A Current Functions**

Function	Range (Rate)	Input Level	Frequency	Display	
				Min	Max
<b>A<sup>==</sup></b>	10 A	+10 A	—	9.975	10.025
<b>A<sup>~</sup></b>	10 A	10 A	1 kHz	9.890	10.110

## Replacement Parts

Parts that can be replaced by the user are listed in Table 6-5. Other parts must be replaced by qualified service personnel only, following the procedures in the Service Manual.

Replacement parts and price information can be obtained from Fluke or an authorized Fluke distributor. To ensure prompt and efficient handling, include the following information with your order:

- Quantity
- Fluke Part Number
- Part Description
- Instrument Model and Serial number.

**Table 6-5. Replacement Parts**





ITEM	DESCRIPTION	FLUKE PART NO.
C40*	Soft Carrying Case (Optional)	—
F1 	mA Input Fuse. F 500 mA, 250 V, (Fast blow), 1500 A breaking capacity	838151
F2 	10 A Input Fuse. F 15 A, 250 V, (Fast blow), 10,000 A minimum breaking capacity; Or, F 15 A, 600 V, (Fast blow), 10,000 A minimum breaking capacity 820829	830802
F3 	Line Fuse. T 125 mA, 250 V, (Slow blow)	822254
F5 	See Supplement	—
RS40*	RS-232 terminal interface cable. Connects Fluke 45 to any properly configured DTE connector (DB-25, male pins). IBM PC or IBM PC/XT, IBM PS/2 (Models 25,30,50, 60,70,80).	—

Table 6-5. Replacement Parts (cont.)

ITEM	DESCRIPTION	FLUKE PART NO.
RS41 *	RS-232 modem cable. Connects Fluke 45 to any modem.	—
TL20*	Industrial Test Leads (Optional)	—
TL70*	Test Leads (Standard)	—
TM1	User's Manual (English)	855981
TM2	User's Manual (German/French)	856034
TM3	User's Manual (Japanese)	857859
TM4	Service Manual	856042
TM5	Quick Reference Guide	856021
Y8021 *	Shielded IEEE-488 one-meter (39.4-inch) cable. Plug and jack at each end.	—
Y8022*	Shielded IEEE-488 two-meter (78.8-inch) cable. Plug and jack at each end.	—
Y8023*	Shielded IEEE-488 four-meter (13-feet) cable. Plug and jack at each end.	—
<p>* Fluke accessories that are available from your authorized Fluke distributor. In USA, for Fluke parts, call 1 -800-356-4731.</p> <p>⚠ To ensure safety, use exact replacement only.</p>		

# ***Appendices***

<b>Appendix</b>	<b>Title</b>	<b>Page</b>
A	Specifications .....	A-1
B	ASCII/IEEE-488 Bus Codes .....	B-1
C	IEEE-488.2 Device Documentation Requirements .....	C-1



# Appendix A Specifications

## Introduction

Appendix A contains the specifications of the Fluke 45 Dual Display Multimeter. These specifications assume:

- A 1-year calibration cycle
- An operating temperature of 18 °C to 28 °C (64.4 °F to 82.4 °F)
- Relative humidity not exceeding 90 % (non-condensing) (70 % for 1,000 kΩ range)

Accuracy is expressed as +(percentage of reading + digits).

## Display Counts and Reading Rates

Rate	Readings per Second	Full Range Display Counts
Slow	2.5	99,999*
Medium	5	30,000
Fast	20	3,000

\* Ohms full range will typically be 98,000 counts

## RS-232 and IEEE-488 Reading Transfer Rates

Rate	Reading Per Second		
	Internal Trigger Operation (TRIGGER 1)	Internal Trigger Operation (TRIGGER 4)	Print Mode Operation (Print set at 1)
Slow	2.5	1.5	2.5
Medium	4.5	2.4	5.0
Fast	4.5	3.8	13.5

## Response Times

Refer to Section 4 for detailed information.

## DC Voltage

Range	Resolution			Accuracy	
	Slow	Medium	Fast	(6 Months)	(1 Year)
300 mV	—	10 $\mu$ V	100 $\mu$ V	0.02 % + 2	0.025 % + 2
3 V	—	100 $\mu$ V	1 mV	0.02 % + 2	0.025 % + 2
30 V	—	1 mV	10 mV	0.02 % + 2	0.025 % + 2
300 V	—	10 mV	100 mV	0.02 % + 2	0.025 % + 2
1000 V	—	100 mV	1 V	0.02 % + 2	0.025 % + 2
100 mV	1 $\mu$ V	—	—	0.02 % + 6	0.025 % + 6
1000 mV	10 $\mu$ V	—	—	0.02 % + 6	0.025 % + 6
10 V	100 $\mu$ V	—	—	0.02 % + 6	0.025 % + 6
100 V	1 mV	—	—	0.02 % + 6	0.025 % + 6
1000 V	10 mV	—	—	0.02 % + 6	0.025 % + 6

### Input Impedance

10 M $\Omega$  in parallel with <100 pF

#### Note

*In the dual display mode, when the volts ac and volts dc functions are selected, the 10 M $\Omega$  dc input divider is in parallel with the 1 M $\Omega$  ac divider.*

### Normal Mode Rejection Ratio

>80 dB at 50 Hz or 60 Hz, slow and medium rates

>54 dB for frequencies between 50-440 Hz, slow and medium rates

>60 dB at 50 Hz, fast rate (Note: Fast rate has no filtering)

### Maximum Allowable AC Voltage While Measuring DC Voltage or (AC + DC) Voltages

Range		Max Allowable Peak AC Voltage	Peak Normal Mode Signal	
			NMRR* >80 dB†	NMRR >60 dB†
300 mV	100 mV	15 V	15 V	15 V
3 V	1000 mV	15 V	15 V	15 V
30 V	10 V	1000 V	50 V	300 V
300 V	100 V	1000 V	50 V	300 V
1000 V	1000 V	1000 V	200 V	1000 V

\* NMRR is the Normal Mode Rejection Ratio  
† Normal Mode Rejection Ratio at 50 Hz or 60 Hz  $\pm$ 0.1 %

### Common Mode Rejection Ratio

>90 dB at do, 50 or 60 Hz, (1 k $\Omega$  unbalanced, medium and slow rates)

### Maximum Input

1000V dc or peak ac on any range

### True RMS AC Voltage, AC-Coupled

Range	Resolution		
	Slow	Medium	Fast
300 mV	—	10 $\mu$ V	100 $\mu$ V
3 V	—	100 $\mu$ V	1 mV
30 V	—	1 mV	10 mV
300 V	—	10 mV	100 mV
750 V	—	100 mV	1 V
100 mV	1 $\mu$ V	—	—
1000 mV	10 $\mu$ V	—	—
10 V	100 $\mu$ V	—	—
100 V	1 mV	—	—
750 V	10 mV	—	—

### Accuracy

Frequency	Linear Accuracy			dB Accuracy		Power*	Max Input at Upper Freq
	Slow	Medium	Fast	Slow/Med	Fast		
20-50 Hz	1 % + 100	1 % + 10	7 % + 2	0.15	0.72	2 % + 10	750 V
50 Hz-10 kHz	0.2 % + 100	0.2 % + 10	0.5 % + 2	0.08	0.17	0.4 % + 10	750 V
10-20 kHz	0.5 % + 100	0.5 % + 10	0.5 % + 2	0.11	0.17	1 % + 10	750 V
20-50 kHz	2 % + 200	2 % + 20	2 % + 3	0.29	0.34	4 % + 20	400 V
50-100 kHz	5 % + 500	5 % + 50	5 % + 6	0.70	0.78	10 % + 50	200 V

\* Error in power mode will not exceed twice the linear accuracy specification

Accuracy specifications apply within the following limits, based on reading rate:

Slow Reading Rate: Between 15,000 and 99,999 counts (full range)

Medium Reading Rate: Between 1,500 and 30,000 counts (full range)

Fast Reading Rate: Between 150 and 3,000 counts (full range)

### Decibel Resolution

Resolution	
Slow & Medium	Fast
0.01 dB	0.1 dB



**Decibel Reference Resistance**

8000 Ω	500 Ω	124 Ω	8 Ω†
1200 Ω	300 Ω	110 Ω	4 Ω†
1000 Ω	250 Ω	93 Ω	2 Ω†
900 Ω	150 Ω	75 Ω	
800 Ω	135 Ω	50 Ω	
600 Ω*	125 Ω	16 Ω†	

\* Default resistance  
† Reading displayed in watts (POWER)

**Input Impedance**

1 MΩ in parallel with <100 pF

**Maximum Crest Factor**

3.0

**Common Mode Rejection Ratio**

>60 dB at 50 Hz or 60 Hz (1 kΩ unbalanced medium rate)

**Maximum Input**

750 V rms, 1000 V peak

2 X 10<sup>7</sup> Volt-Hertz product on any range, normal mode input

1 x 10<sup>6</sup> Volt-Hertz product on any range, common mode input

**(AC + DC) Voltage Accuracy**

Total Measurement Error will not exceed the sum of the separate ac and dc accuracy specifications, plus 1 display count. Refer to the table under "Maximum Allowable AC Voltage while Measuring DC Voltage or (AC + DC) Voltages" located on page A3.

*Note*

*When measuring ac + dc, (or any dual display combination of ac and dc) in the fast reading rate, the Fluke 45 may show significant reading errors. This results from a lack of filtering on the dc portion of the measurement for the fast reading rate. To avoid this problem, use only the "slow" and "medium" reading rates for ac + dc or ac and dc combinations.*

**Maximum Frequency of AC Voltage Input While Measuring AC Current**

When the meter makes ac current and ac voltage measurements using the dual display, the maximum frequency of the voltage input is limited to the maximum frequency of the current function. For example, if you are making an ac current measurement on the 10 A range, the maximum frequency of the voltage input must be less than 2 kHz.

## DC Current

Range	Resolution			Accuracy	Burden Voltage
	Slow	Medium	Fast		
30 mA	—	1 $\mu$ A	10 $\mu$ A	0.05 % + 3	0.45 V
100 mA	—	10 $\mu$ A	100 $\mu$ A	0.05 % + 2	1.4 V
10 A	—	1 mA	10 mA	0.2 % + 5	0.25 V
10 mA	100 nA	—	—	0.05 % +	0.14 V
100 mA	1 $\mu$ A	—	—	50.05 % + 5	1.4 V
10 A	100 $\mu$ A	—	—	0.2 % + 7	0.25 V

\* Typical at full range

## Maximum Input

To be used in protected, low energy circuits only, not to exceed 250 V or 4800 Volt-Amps. (IEC 664 Installation Category II.)

mA 300 mA dc or ac rms. Protected with a 500 mA, 250V, IEC 127-sheet 1, fast blow fuse

A 10 A dc or ac rms continuous, or 20 A dc or ac rms for 30 seconds maximum. Protected with a 15 A, 250 V, 10,000 A interrupt rating, fast blow fuse.

### Note

Resistance between the COM binding post and the meter's internal measuring circuits is approximately .003  $\Omega$ .

## AC Current

Range	Resolution			Burden Voltage*
	Slow	Medium	Fast	
10 mA	100 nA	—	—	0.14 V
30 mA	—	1 $\mu$ A	10 $\mu$ A	0.45 V
100 mA	1 $\mu$ A	10 $\mu$ A	100 $\mu$ A	1.4 V
10 A	100 $\mu$ A	1 mA	10 mA	0.25 V

\* Typical at full range

**Accuracy**

Range	Frequency	Accuracy		
		Slow	Medium	Fast
mA (To 100 mA)	20-50 Hz	2 % + 100	2 % + 10	7 % + 2
mA (To 100 mA)	50 Hz-10 kHz	0.5 % + 100	0.5 % + 10	0.8 % + 2
mA (To 100 mA)	10 -20 kHz	2 % + 200	2 % + 20	2 % + 3
A (1-10A)	20-50 Hz	2 % + 100	2 % + 10	7 % + 2
A (1-10A)	50 Hz-2 kHz	1 % + 100	1 % + 10	1.3 % + 2
A (0.5 to 1A)	20-50 Hz	2 % + 300	2 % + 30	7 % + 4
A (0.5 to 1A)	50Hz-2 kHz	1 % + 300	1 % + 30	1.3 % + 4

mA accuracy specifications apply within the following limits, based on reading rate:

Slow Reading Rate:           Between 15,000 and 99,999 counts (full range)

Medium Reading Rate:        Between 1,500 and 30,000 counts (full range)

Fast Reading Rate:            Between 150 and 3,000 counts (full range)

**Maximum Crest Factor**

3.0

**Maximum Input**

To be used in protected, low energy circuits only, not to exceed 250 V or 4800 Volt-Amps. (IEC 664 Installation Category II.)

mA    300 mA dc or ac rms. Protected with a 500 mA, 250 V, IEC 127-sheet 1, fast blow fuse

A       10 A dc or ac rms continuous, or 20 A dc or ac rms for 30 seconds maximum. Protected with a 15 A, 250 V, 10,000 A interrupt rating, fast blow fuse.

*Note*

*Resistance between the COM binding post and the meter's internal measuring circuits is approximately .003Ω.*

## Ohms

Range	Resolution			Accuracy	Typical Full Scale Voltage	Max Current Through the Unknown
	Slow	Medium	Fast			
300 Ω	—	10 mΩ	100 MΩ	0.05 % + 2 + 0.02Ω	0.25	1 mA
3 kΩ	—	100 MΩ	1 Ω	0.05 % + 2	0.24	120 μA
30 kΩ	—	1 Ω	10 Ω	0.05 % + 2	0.29	14 μA
300 kΩ	—	10 Ω	100 Ω	0.05 % + 2	0.29	1.5 μA
3 MΩ	—	100 Ω	1 kΩ	0.06 % + 2	0.3	150 μA
30 MΩ	—	1 kΩ	10 kΩ	0.25 % + 3	2.25	320 μA
300 MΩ*	—	100 kΩ	1 MΩ	2 %	2.9	320 μA
100 Ω	1 mΩ	—	—	0.05 % + 8 + 0.02 Ω	0.09	1 mA
1000 Ω	10 mΩ	—	—	0.05 % + 8 + 0.02Ω	0.10	120 μA
10 kΩ	100 mΩ	—	—	0.05 % + 8	0.11	14 μA
100 kΩ	1 Ω	—	—	0.05 % + 8	0.11	1.5 μA
1000 kΩ	10 Ω	—	—	0.06 % + 8	0.12	150 μA
10 MΩ	100 Ω	—	—	0.25 % + 6	1.5	150 μA
100 MΩ*	100 kΩ	—	—	2 % + 2	2.75	320 μA

\*Because of the method used to measure resistance, the 100 MΩ (slow) and 300 MΩ (medium and fast) ranges cannot measure below 3.2 MΩ and 20 MΩ, respectively. "UL" (underload) is shown on the display for resistances below these nominal points, and the computer interface outputs "+1 E-9".

### Open Circuit Voltage

3.2 V maximum on the 100 Ω, 300 Ω, 30 MΩ, 100 MΩ, and 300 MΩ ranges, 1.5 V maximum on all other ranges.

### Input Protection

500 V dc or rms ac on all ranges

### Diode Test/Continuity

	Maximum Reading	Resolution
Slow	999.99 mV	10 μV
Medium	2.5 V	100 μV
Fast	2.5 V	1 mV

### Test Current

Approximately 0.7 mA when measuring a forward biased junction.

### Audible Tone

Continuous tone for continuity. Brief tone for normal forward biased diode or semiconductor junction.

### Open Circuit Voltage

3.2 V maximum  
Continuity Capture Time  
50 us maximum, 10 us typical

### Input Protection

500 volts dc or rms ac

#### Note

*When the meter is set to measure frequency and there is no input signal (i.e., input terminals are open), the meter may read approximately 25 kHz (rather than the expected zero). This is due to internal capacitive pickup of the inverter power supply into the high-impedance, input circuitry. With source impedance of <math><2\text{ k}\Omega</math>, this pickup will not affect the accuracy or stability of the frequency a reading.*

### Frequency

Frequency Range  
5 Hz to >1 MHz  
Applicable Functions  
Volts ac and Current AC

Range	Resolution		Accuracy
	Slow & Medium	Fast	
1000 Hz	.01 Hz	.1 Hz	05% + 2
10 kHz	.1 Hz	1 Hz	.05% + 1
100 kHz	1 Hz	10 Hz	.05% + 1
1000 kHz	10 Hz	100 Hz	.05% + 1
1 MHz*	100 Hz	1 kHz	Not Specified

\* Specified to 1 MHz, but will measure above 1 MHz.

### Sensitivity of AC Voltage

Frequency	Level (sine wave)
5 Hz-100 kHz	30 mV rms
100 kHz - 300 kHz	100 mV rms
300 kHz - 1 MHz	1 V V rms
Above 1 MHz	Not specified

### Sensitivity Level of AC Current

Frequency	Input	Level
5 Hz-20 kHz	100 mA	>3 mA rms
45 Hz-2 kHz	10 A	>3 A rms

*Note*

*When the meter is set to measure frequency and there is no input signal (i.e., the input terminals are open), the meter may read approximately 25 kHz (rather than zero). This is due to internal capacitive pickup of the inverter power supply into the high-impedance, input circuitry. With source impedance of <2 kΩ, this pickup will not affect the accuracy or stability of the frequency reading.*

## Environmental

<b>Warmup time</b>	1 hour to rated specifications for warmup < 1 hour, add 0.005 % to all accuracy specifications.						
<b>Temperature Coefficient</b>	<0.1 times the applicable accuracy specification per degree C for 0 °C to 18 °C and 28 °C to 50 °C (32 °F to 64.4 °F and 82.4 °F to 122 °F)						
<b>Operating Temperature</b>	0 °C to 50 °C (32 °F to 122°F)						
<b>Storage Temperature</b>	-40 °C to + 70 °C (-40 °F to 158°F)  Elevated temperature storage of battery will accelerate battery self-discharge. Maximum storage time before battery must be recharged: <table border="0" style="margin-left: 40px;"> <tr> <td>20 °C – 25 °C</td> <td>1000 days</td> </tr> <tr> <td>50 °C</td> <td>180 days</td> </tr> <tr> <td>70 °C</td> <td>40 days</td> </tr> </table>	20 °C – 25 °C	1000 days	50 °C	180 days	70 °C	40 days
20 °C – 25 °C	1000 days						
50 °C	180 days						
70 °C	40 days						
<b>Relative Humidity (non-condensing)</b>	To 90 % at 0 °C to 28 °C (32-82.4 °F), To 80 % at 28 °C to 35 °C (82.4-95 °F), To 70 % at 35 °C to 50 °C (95 °F -122 ° F) except to 70 % at 0 °C to 50 °C (32 °F -122 °F) for the 1000 kΩ, 3 MΩ, 10 MΩ, 30 MΩ, 100 MΩ, and 300 MΩ ranges.						
<b>Altitude</b>	Operating                      0 to 10,000 feet Non-operating                0 to 40,000 feet						
<b>Electromagnetic Compatibility</b>	In an RF field of 1 V/m on all ranges and functions: Total Accuracy = Specified Accuracy +0.4% of range. Performance above 1 V/m is not specified						
<b>Vibration</b>	3 G @ 55 Hz						
<b>Shock</b>	Half sine 40 G. Per Mil-T- 28800D, Class 3, Style E. Bench Handling. Per Mil-T-28800D, Class 3.						

## General

<b>Common Mode Voltage</b>	1000 V dc or peak ac maximum from any input to earth
<b>Size</b>	9.3 cm high, 21.6 cm wide, 28.6 cm deep (3.67 in high, 8.5 in wide, 11.27 in deep)
<b>Weight</b>	Net, 2.4 kg (5.2 lbs) without battery; 3.2 kg (7.0 lbs) with battery; Shipping, 4.0 kg (8.7 lbs) without battery; 4.8 (10.5 lbs) with battery
<b>Power</b>	90 V to 264 V ac (no switching required), 50 Hz and 60 Hz < 15 VA maximum
<b>Standards</b>	Complies with: IEC 348, UL1244, CSA Bulletin 566B
<b>RS-232-C</b>	EMC: Part 15 subpart J of FCC Rules, and VDE 0871. Baud rates: 300, 600, 1200, 2400, 4800 and 9600 Odd, even or no parity One stop bit

## Options

<b>Battery (Option -01 K)</b>	Type	8 V, Lead-Acid
	Operating Time	8 hours (typical).  lights when less than 1/2 hour of battery operation remains. Meter still meets specifications.
	Recharge Time	16 hours (typical) with meter turned off and plugged into line power. Battery will not charge when meter is turned on.
<b>IEEE-488 (Option -05K)</b>	Capability codes	SH1, AH1, T5, L4, SRI, RL1, PP0, DC1, DT1, E1, TED, LEO and C0
	External Trigger Input	
	VIH	1.35 V minimum
	VIL	1.25 V maximum
	Input Threshold Hysteresis	0.6 V minimum

***Appendix B***  
***ASCII/IEEE-488 Bus Codes***





**FLUKE** ASCII & IEEE-488 BUS CODES

B <sup>7</sup> B <sup>6</sup> B <sup>5</sup> BITS B <sup>4</sup> B <sup>3</sup> B <sup>2</sup> B <sup>1</sup> B <sup>0</sup>	0 0 0 0	0 0 0 1	0 0 1 0	0 0 1 1	0 1 0 0	0 1 0 1	0 1 1 0	0 1 1 1	1 0 0 0	1 0 0 1	1 0 1 0	1 0 1 1	1 1 0 0	1 1 0 1	1 1 1 0	1 1 1 1
	CONTROL		NUMBERS SYMBOLS		UPPER CASE		LOWER CASE									
	0 0 0 0	16 10	32 20	48 30	64 40	80 50	96 60	112 70								
0 0 0 0	NUL NUL	ρ DLE	SP SPACE MLA0	0 MLA16	@ MTA0	P MTA16	' MSA0	p MSA16								
0 0 0 1	β SOH GTL	σ DC1	! MLA1	1 MLA17	A MTA1	Q MTA17	a MSA1	q MSA17								
0 0 1 0	γ STX	τ DC2	" MLA2	2 MLA18	B MTA2	R MTA18	b MSA2	r MSA18								
0 0 1 1	δ ETX	υ DC3	# MLA3	3 MLA19	C MTA3	S MTA19	c MSA3	s MSA19								
0 1 0 0	ε EOT SDC	φ DC4 DCL	\$ MLA4	4 MLA20	D MTA4	T MTA20	d MSA4	t MSA20								
0 1 0 1	ζ ENQ PPC	χ NAK PPU	% MLA5	5 MLA21	E MTA5	U MTA21	e MSA5	u MSA21								
0 1 1 0	η ACK	ψ SYN	& MLA6	6 MLA22	F MTA6	V MTA22	f MSA6	v MSA22								
0 1 1 1	BEL BEL	ω ETB	' MLA7	7 MLA23	G MTA7	W MTA23	g MSA7	w MSA23								
1 0 0 0	BS BS GET	Ω CAN SPE	( MLA8	8 MLA24	H MTA8	X MTA24	h MSA8	x MSA24								
1 0 0 1	HT HT TCT	√ EM SPD	) MLA9	9 MLA25	I MTA9	Y MTA25	i MSA9	y MSA25								
1 0 1 0	LF LF	→ SUB	* MLA10	:	J MTA10	Z MTA26	j MSA10	z MSA26								
1 0 1 1	VT VT	ESC ESC	+ MLA11	;	K MTA11	[ MTA27	k MSA11	{ MSA27								
1 1 0 0	FF FF	↑ FS	, MLA12	< MLA28	L MTA12	\ MTA28	l MSA12	! MSA28								
1 1 0 1	CR CR	÷ GS	- MLA13	= MLA29	M MTA13	] MTA29	m MSA13	} MSA29								
1 1 1 0	S0 S0	Σ RS	. MLA14	> MLA30	N MTA14	^ MTA30	n MSA14	~ MSA30								
1 1 1 1	SI SI	≈ US	/ MLA15	? UNL	O MTA15	— UNT	o MSA15	▣ RUB OUT MSA31								
2 <sup>3</sup> 2 <sup>2</sup> 2 <sup>1</sup> 2 <sup>0</sup>	ADDRESSED UNIVERSAL COMMANDS COMMANDS		LISTEN ADDRESSES		TALK ADDRESSES		SECONDARY ADDRESSES OR COMMANDS									

Form No. F739 Rev 1.3 / 85

**KEY** decimal 38 & 26 hex 1722A DISPLAY  
 ASCII & MLA6 IEEE-488

# Appendix C

## IEEE-488.2 Device Documentation Requirements

### Introduction

Section 4.9 of the IEEE Standard 488.2-1987 states: "All devices shall supply information to the user about how the device has implemented this standard. " (In this context, "device" means the Fluke 45 Dual Display Multimeter.) The information in Appendix C is provided in compliance with this requirement.

### Implementation of IEEE Standard 488.2-1987

Items 1-23 below correspond, one-to-one, to the specific items of information required by Section 4.9, "Device Documentation Requirements", of the Standard. The information supplied by Fluke in response is italicized. (Throughout Appendix C, the word "Section" refers to the section(s) in the Standard, not this manual.)

1. A list of IEEE 488.2 Interface Function subsets implemented, Section 5.

*IEEE-488. 1 interface functions implemented in the Fluke 45 are listed under "IEEE-488 (Option -05)" capability codes in Appendix A.*

2. A description of device behavior when the address is set outside the range 0-30, Section 5.2.

*It is not possible to set the Fluke 45 address outside the specified range.*

3. A description of when a user initiated address change is recognized by the device.

*An address change is recognized when set via the address editor which is entered by pressing (2ND), then (MN MX) (ADDR). This address will be used until it is changed.*

4. A description of the device setting at power-on, Section 5.12. Any commands which modify the power-on settings shall also be included.

*The default meter setting is: volts tic, autoranging, secondary display inactive. A different power-up configuration can be set by pressing (2ND) and (AUTO) at the same time; the present configuration of the meter then becomes the power-up configuration.*

A description of message exchange options:

5A. The size and behavior of the input buffer.

*The input buffer size is 350 bytes. If the input buffer fills, the IEEE-488.1 bus will be held off until there is room in the buffer for a new byte.*

5B. Which queries return more than one <RESPONSE MESSAGE UNIT>, Section 6.4.3.

*The \*IDN? query always returns four<RESPONSE MESSAGE UNITS>. The CAL? and MEAS? queries may return one or two <RESPONSE MESSAGE UNITS>—one if only the primary display is in use, two if both the primary and secondary displays are in use.*

5C. Which queries generate a response when parsed, Section 6.4.5.4.

*All queries generate a response when parsed.*

5D. Which queries generate a response when read, Section 6.4.5.4.

*No queries generate a response when read by the controller.*

5E. Which commands are coupled, Section 6.4.5.3.

*No commands are coupled.*

6. A list of functional elements used in constructing device-specific commands. Whether <compound command program header> elements are used must also be included, Section 7.1.1 and 7.3.3.

*Device-specific commands used:*

*<PROGRAM MESSAGE> <PROGRAM MESSAGE TERMINATOR> <PROGRAM MESSAGE UNIT> <PROGRAM MESSAGE UNIT SEPARATOR> <COMMAND MESSAGE UNIT> <QUERY MESSAGE UNIT> <COMMAND PROGRAM HEADER> <QUERY PROGRAM HEADER> <PROGRAM DATA> <CHARACTER PROGRAM DATA> <DECIMAL NUMERIC PROGRAM DATA>*

7. A description of any buffer size limitations related to block data, Section 7.7.6.5.

*No block data is used.*

8. A list of <PROGRAM DATA> elements which may appear within an <expression> as well as the maximum sub-expression nesting depth Any additional syntax restrictions which the device may place on the <expression> shall also be included.

*No sub-expressions are used. The only <PROGRAM DATA> functional elements used are <CHARACTER PROGRAM DATA> AND <DECIMAL NUMERIC PROGRAM DATA>.*

9. A description of the response syntax for every query, Section 8.

*RATE?, FUNC1?, FUNC2?, RANGE1?, RANGE2?, BUTTON?, EEREG?, DBREF?, HOLDTHRESH?, RELBASE?, \*ESR?, \*SRE?, \*TST?, and \*OPC? all return <NRI NUMERIC RESPONSE DATA>.*

*FUNC1?, FUNC2?, COMP?, and SERIAL? all return <CHARACTER RESPONSE DATA>.*

*MEAS?*, *MEAS1?*, *MEAS2?*, *VAL?*, *VAL1?*, and *VAL2?* return one of two possible formats (set with the *FORMAT* command). In addition, the *VAL?*, and *MEAS?* queries will return two comma-separated values if both displays are in use:

- *Format 1: <NR3 NUMERIC RESPONSE DATA>*
- *Format 2: <NR3 NUMERIC RESPONSE DATA> < UNIT>*

*MEASUREMENT <UNITS>*

*Volts dc VDC*

*Volts ac VAC*

*Current dc ADC*

*Current ac AAC*

*Resistance OHMS*

*Frequency HZ*

*Continuity Test VDC*

*Diode Test VDC*

10. A description of any device-to-device message transfer traffic which does not follow the rules for <RESPONSE MESSAGE> elements, Section 8.1.

*There are no device-to-device messages.*

11. The size of any block data responses, Section 8.7.9.4.

*There are no block data responses.*

12. A list of common commands and queries which are implemented, Section 10.

*See Table 5-9 in the Users Manual.*

13. A description of the state of the device after successful completion of the Calibration query, Section 10.2.

*The \*CAL? command not implemented (an optional command).*

14. The maximum length of the block used to define the trigger macro, if \*DDT is implemented, Section 10.4.

*\*DDT is not implemented.*

15. The maximum length of macro labels, the maximum length of the block used to define a macro, and how recursion is handled during macro expansion, if the macro commands are implemented, Section 10.7.

*Macros are not implemented.*

16. A description of the response to the identification common query, \*IDN?, Section 10.14.

*The \*IDN? query returns, for example:*

*FLUKE, 45, 1234567, 1.0 D1.0*

*where "1234567" will be replaced by the serial number of an actual meter, and "1.0 D1.0" are the version numbers of the main software and the display sub-system software, respectively.*

17. The size of the protected user data storage area, \*PUD, Section 10.27.

*\*PUD not implemented. There is no protected user data storage area.*

18. The size of the resource description, if the \*RDT command or \*RDT? query are implemented, Sections 10.30 and 10.31.

*The \*RDT and \*RAT? commands are not implemented.*

19. A description of the states affected by \*RST (Section 10.32), \*LRN? (Section 10.17), \*RCL (Section 10.29), and \*SAY (Section 10.33).

*\*LRN.2, \*RCL, and \*SAT are not implemented. \*RST restores the meter to the state assumed at power-up (using the stored configuration), except for those items specifically forbidden by the \*RST command definition.*

20. A description of the scope of the self-test performed by the \*TST? query, Section 10.38.

*\*TST? performs the tests listed under "\*TAT?" in Table 5-8 of the Users Manual. The meter reverts to the stored configuration after performing these tests.*

21. A description of additional status data structures used in the device's status reporting, Section 11.

*There are no additional data structures.*

22. For each command, a statement describing whether is overlapped or sequential.

*All commands are sequential; none are overlapped.*

23. For each command, the device documentation shall specify the functional criteria that are met when an operation complete message is generated in response to that command, Section 12.8.3.

*Operation complete is generated when the command is parsed. Note that MEAS?, MEAS1?, and MEAS2? prevent the parser from continuing until all requested measurements have completed. (This includes any time waiting for the trigger). The VAL, VAL2?, and VAL2? queries will also wait for trigger if the needed display measurements have never been done*