

# ***6080A/82A***

***SYNTHESIZED RF SIGNAL GENERATOR***

## **Operator Manual**

PN 861034  
May 1990, Revised June 1995  
Printed in USA

***Giga-tronics***

# WARRANTY

Notwithstanding any provision of any agreement, the following warranty is exclusive:

Giga-tronics Inc. warrants each instrument it manufactures to be free from defects in material and workmanship under normal use and service for the period of one year from the date of shipment. This warranty extends only to the original purchaser. This warranty shall not apply to fuses, disposable batteries (rechargeable batteries are warranted for 90 days), or any product or parts which have been subject to misuse, neglect, accident, or abnormal conditions of operation.

In the event of failure of a product covered by this warranty, Giga-tronics Inc. will repair and calibrate an instrument returned to an authorized service facility within one year of the original shipment, provided that examination discloses to the satisfaction of Giga-tronics that the product was defective. Giga-tronics may, at its option, replace the product in lieu of repairing it. With regard to any instrument returned within one year of the original shipment, said repairs or replacement will be made without charge. If the failure has been caused by misuse, neglect, accident, or abnormal conditions of operation, repairs will be billed at a nominal cost. In such cases, an estimate will be submitted before work is started, if requested.

THE FOREGOING WARRANTY IS IN LIEU OF ALL OTHER WARRANTIES, EXPRESSED OR IMPLIED, INCLUDING BUT NOT LIMITED TO ANY IMPLIED WARRANTY OF MERCHANTABILITY, FITNESS, OR ADEQUACY FOR ANY PARTICULAR PURPOSE OR USE. GIGA-TRONICS INC. SHALL NOT BE LIABLE FOR ANY SPECIAL, INCIDENTAL, OR CONSEQUENTIAL DAMAGES, WHETHER IN CONTRACT, TORT, OR OTHERWISE.

## IF ANY FAILURE OCCURS, THE FOLLOWING STEPS SHOULD BE TAKEN:

1. Notify Giga-tronics Inc., or the nearest authorized service facility (a list of authorized facilities is included in the manual), giving full details of the difficulty, and include the model number, type number, and serial number. On receipt of this information, service data or shipping instructions will be forwarded to you.
2. On receipt of the shipping instructions, forward the instrument, transportation prepaid. Repairs will be made at the service facility and the instrument returned, transportation prepaid.

## SHIPPING TO THE MANUFACTURER FOR REPAIR OR ADJUSTMENT

All shipments of Giga-tronics instruments should be made prepaid (air freight recommended). Ship the instrument in the original packing carton; or, if that is not available, use any suitable container that is rigid and of adequate size. If a substitute container is used, the instrument should be wrapped in paper and surrounded with at least four inches of excelsior or similar shock-absorbing material.

## CLAIM FOR DAMAGE IN SHIPMENT TO THE ORIGINAL PURCHASER

The instrument should be thoroughly inspected immediately upon original delivery to the purchaser. All material in the container should be checked against the enclosed packing list. The manufacturer will not be responsible for shortages against the packing sheet unless notified immediately. (To obtain a quotation to repair shipment damage, contact Giga-tronics Inc., or any of its authorized service facilities.) Final claim and negotiations with the carrier must be completed by the customer.

Giga-tronics Inc. will address all questions about applications, in order to enhance your use of the instrument. Please address your requests or correspondence to:

GIGA-TRONICS INC., 4650 NORRIS CANYON ROAD, SAN RAMON, CALIFORNIA, 94583, ATTN: SERVICE  
(TELEPHONE: 510 328-4650)

## List of Illustrations

<b>FIGURES</b>	<b>TITLE</b>	<b>PAGE</b>
2-1.	Line Power Cords Available from Fluke .....	2-3
2-2.	Fuse/Line Voltage Selection Assembly .....	2-4
3-1.	Front Panel Features .....	3-2
3-2.	Rear Panel Features .....	3-11
5A-1.	Overview of Status Data Structure .....	5A-8
5A-2.	Bit Assignments for the STB and SRE .....	5A-9
5A-3.	Bit Assignments for ESR and ESE .....	5A-11
5A-4.	Bit Assignments for the ISR, ISCR, and ISCE .....	5A-14
5A-5.	IEEE-488 Connector and Pin Assignments .....	5A-21

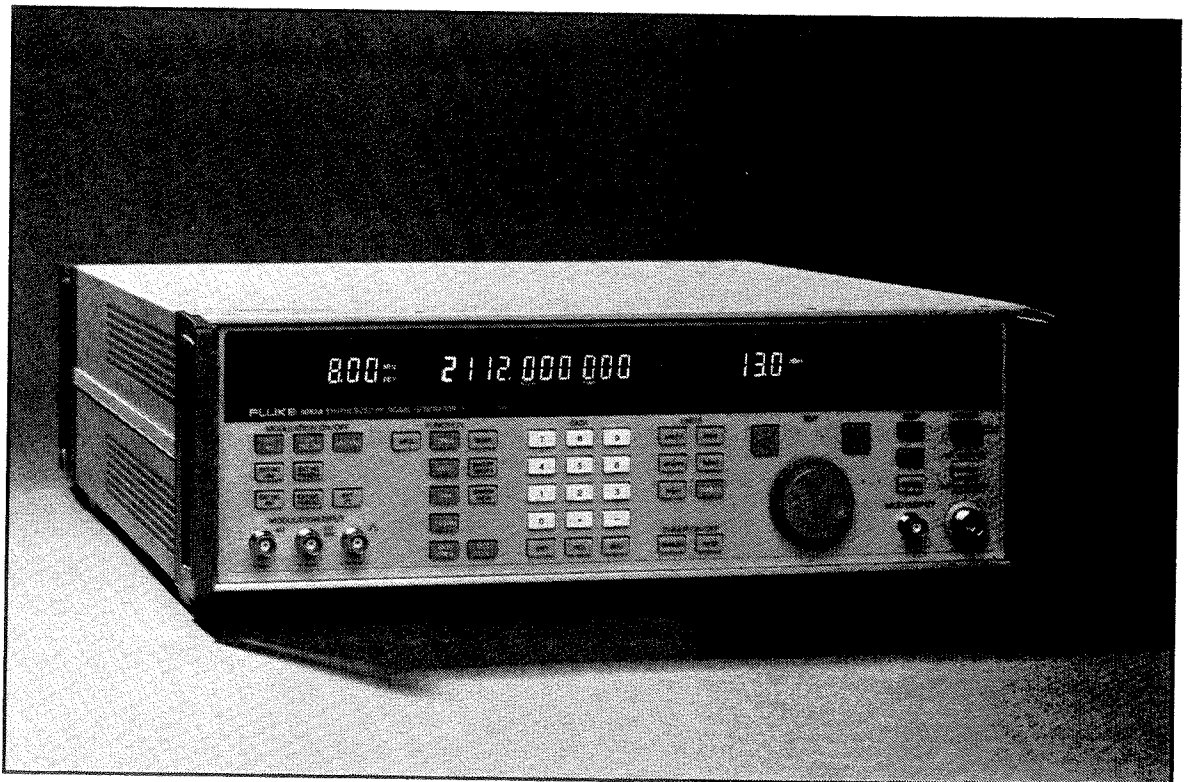

# OPERATOR SAFETY SUMMARY

## SAFETY TERMS IN THIS MANUAL

This instrument has been designed and tested in accordance with IEC Publication 348, Safety Requirements for Electronic Measuring Apparatus. This Operator Manual contains information, warnings, and cautions that must be followed to ensure safe operation and to maintain the signal generator in a safe condition.

**WARNING** statements identify conditions or practices that could result in personal injury or loss of life.

**CAUTION** statements identify conditions or practices that could result in damage to equipment.

## POWER SOURCE

The signal generator is intended to operate from a power source that will not apply more than 264V ac rms between the supply conductors or between either supply conductor and ground. A protective ground connection by way of the grounding conductor in the power cord is essential for safe operation.

## USE THE PROPER FUSE

To avoid fire hazard, use only a fuse identical in type, voltage rating, and current rating as specified on the rear panel fuse rating label.

## GROUNDING THE SIGNAL GENERATOR

The signal generator is a Safety Class I (grounded enclosure) instrument as defined in IEC 348. The enclosure is grounded through the grounding conductor of the power cord. To avoid electrical shock, plug the power cord into a properly wired earth grounded receptacle before connecting anything to any of the signal generator terminals. A protective ground connection by way of the grounding conductor in the power cord is essential for safe operation.

## USE THE PROPER POWER CORD

Use only the power cord and connector appropriate for the voltage and plug configuration in your country.

Use only a power cord that is in good condition.

Refer cord and connector changes to qualified service personnel.

## DO NOT OPERATE IN EXPLOSIVE ATMOSPHERES

To avoid explosion, do not operate the signal generator in an atmosphere of explosive gas.

### **DO NOT REMOVE COVER**

To avoid electric shock, do not remove the signal generator cover. Do not operate the signal generator without the cover properly installed. Normal calibration is accomplished with the cover closed, and there are no user-serviceable parts inside the signal generator, so there is no need for the operator to ever remove the cover. Access procedures and the warnings for such procedures are contained in the Service Manual. Service procedures are for qualified service personnel only.

### **DO NOT ATTEMPT TO OPERATE IF PROTECTION MAY BE IMPAIRED**

If the signal generator appears damaged or operates abnormally, protection may be impaired. Do not attempt to operate it. When in doubt, have the instrument serviced.

# Table of Contents

SECTION	TITLE	PAGE
<b>1</b>	<b>INTRODUCTION AND SPECIFICATIONS .....</b>	<b>1-1</b>
1-1.	INTRODUCTION .....	1-1
1-2.	INSTRUCTION MANUALS .....	1-2
1-3.	6080A/82A Operator Manual .....	1-2
1-4.	6080A/82A Operator Reference Guide .....	1-2
1-5.	6080A/82A Remote Programming Reference Guide .....	1-2
1-6.	6080A/82A Special Functions Decal .....	1-2
1-7.	6080A and 6082A Service Manuals .....	1-3
1-8.	OPTIONS .....	1-3
1-9.	WARRANTY AND SERVICE INFORMATION .....	1-3
1-10.	SPECIFICATIONS .....	1-4
<b>2</b>	<b>INSTALLATION .....</b>	<b>2-1</b>
2-1.	INTRODUCTION .....	2-1
2-2.	UNPACKING AND INSPECTION .....	2-1
2-3.	RACK OR BENCH MOUNTING .....	2-1
2-4.	POWER REQUIREMENTS .....	2-1
2-5.	LINE VOLTAGE SELECTION AND FUSE REPLACEMENT .....	2-2
2-6.	CONNECTING TO LINE POWER .....	2-4
2-7.	INTERNAL/EXTERNAL FREQUENCY REFERENCE .....	2-4
2-8.	LOCAL AND REMOTE OPERATION .....	2-5
2-9.	POWER-ON SEQUENCE .....	2-5
<b>3</b>	<b>FEATURES .....</b>	<b>3-1</b>
3-1.	INTRODUCTION .....	3-1
3-2.	FRONT PANEL FEATURES .....	3-1
3-5.	REAR PANEL FEATURES .....	3-1
<b>4</b>	<b>FRONT PANEL OPERATION .....</b>	<b>4-1</b>
4-1.	INTRODUCTION .....	4-1
4-2.	RECALLING PREVIOUS INSTRUMENT SETTINGS AT POWER-UP .....	4-1
4-3.	ENTERING AND MODIFYING PARAMETERS .....	4-1

TABLE OF CONTENTS, *continued*

SECTION	TITLE	PAGE
4-4.	Entering Parameters Directly .....	4-2
4-5.	Editing the Bright Digit .....	4-2
4-6.	Incrementing and Decrementing by Step .....	4-3
<b>4A</b>	<b>RF OUTPUT FREQUENCY .....</b>	<b>4A-1</b>
4A-1.	INTRODUCTION .....	4A-1
4A-2.	SETTING RF OUTPUT FREQUENCY .....	4A-1
4A-3.	SETTING RF OUTPUT FREQUENCY STEP SIZE .....	4A-2
4A-4.	USING RF OUTPUT FREQUENCY RELATIVE MODE .....	4A-2
4A-5.	ADJUSTING THE PHASE OF THE RF CARRIER .....	4A-3
4A-6.	USING AN EXTERNAL FREQUENCY REFERENCE .....	4A-3
4A-7.	RF OUTPUT FREQUENCY BANDS .....	4A-4
4A-8.	RF OUTPUT BLANKING DURING FREQUENCY CHANGES .....	4A-4
<b>4B</b>	<b>RF OUTPUT AMPLITUDE .....</b>	<b>4B-1</b>
4B-1.	INTRODUCTION .....	4B-1
4B-2.	SETTING RF OUTPUT AMPLITUDE .....	4B-1
4B-3.	CONVERTING RF OUTPUT AMPLITUDE UNITS .....	4B-2
4B-4.	SELECTING ALTERNATE dB REFERENCE UNITS .....	4B-2
4B-5.	USING UNTERMINATED OUTPUT (EMF) MODE .....	4B-3
4B-6.	SETTING RF OUTPUT AMPLITUDE STEP SIZE .....	4B-4
4B-7.	USING RF AMPLITUDE RELATIVE MODE .....	4B-4
4B-8.	ENABLING AND DISABLING RF OUTPUT .....	4B-6
4B-9.	RF OUTPUT AMPLITUDE BANDS .....	4B-6
4B-10.	USING RF OUTPUT AMPLITUDE FIXED-RANGE MODE .....	4B-7
4B-11.	USING ALTERNATE OUTPUT COMPENSATION MODES .....	4B-8
4B-12.	SELECTING ALTERNATE OUTPUT COMPENSATION DATA .....	4B-8
<b>4C</b>	<b>MODULATION .....</b>	<b>4C-1</b>
4C-1.	INTRODUCTION .....	4C-1
4C-2.	INTERNAL MODULATION OSCILLATOR .....	4C-1
4C-3.	Setting Modulation Frequency and Step Size .....	4C-2
4C-4.	Setting Modulation Level and Step Size .....	4C-3
4C-5.	Enabling and Disabling Modulation Output .....	4C-4
4C-6.	Selecting the Internal Modulation Waveform .....	4C-4
4C-7.	Using the Extended Resolution Mode for Modulation Frequency .....	4C-5
4C-8.	AMPLITUDE MODULATION (AM) .....	4C-5
4C-9.	Setting AM Depth and AM Depth Step Size .....	4C-5
4C-10.	Activating Internal AM .....	4C-6
4C-11.	Activating External AM (AC Coupled) .....	4C-6
4C-12.	Activating External AM (DC Coupled) .....	4C-7
4C-13.	FREQUENCY AND PHASE MODULATION (FM/ $\phi$ M) .....	4C-7
4C-14.	Setting FM/ $\phi$ M Deviation and FM/ $\phi$ M Step Size .....	4C-7
4C-15.	Converting FM/ $\phi$ M Units .....	4C-9
4C-16.	Activating Internal FM/ $\phi$ M .....	4C-10
4C-17.	Activating External FM/ $\phi$ M (AC Coupled) .....	4C-10
4C-18.	Activating External FM (DC Coupled) .....	4C-10
4C-19.	FM Bands .....	4C-11
4C-20.	Using Low Distortion and Fixed-Range FM Modes .....	4C-12
4C-21.	Using Low Rate FM Mode .....	4C-13



SECTION	TITLE	PAGE
4C-22.	Using High Rate $\phi$ M Mode .....	4C-13
4C-23.	PULSE MODULATION .....	4C-14
4C-24.	Activating External Pulse Modulation .....	4C-14
4C-25.	Activating Internal Pulse Modulation .....	4C-14
4C-26.	Using the Mod Oscillator as a Pulse Generator .....	4C-14
4C-27.	Setting Pulse Width .....	4C-15
<b>4D</b>	<b>INSTRUMENT STATE MEMORY .....</b>	<b>4D-1</b>
4D-1.	ORGANIZATION OF INSTRUMENT STATE MEMORY .....	4D-1
4D-2.	STORING AND RECALLING INSTRUMENT STATES .....	4D-3
4D-3.	RECALLING A SEQUENCE OF INSTRUMENT STATES .....	4D-4
4D-4.	DIVIDING MEMORY INTO PARTITIONS .....	4D-4
4D-5.	WRITE-PROTECTING MEMORY LOCATIONS .....	4D-6
4D-6.	RESETTING ALL MEMORY LOCATIONS TO FACTORY DEFAULT .....	4D-6
4D-7.	STORING AND RECALLING SINGLE PARAMETERS .....	4D-6
4D-8.	SECURE MODE AND NONVOLATILE MEMORY ERASURE ....	4D-7
4D-9.	Enabling Secure Mode .....	4D-7
4D-10.	Erasing Nonvolatile Memory .....	4D-7
4D-11.	Changing the erase Operation Repeat Count .....	4D-9
<b>4E</b>	<b>SWEEP .....</b>	<b>4E-1</b>
4E-1.	INTRODUCTION .....	4E-1
4E-2.	SELECTING FREQUENCY OR AMPLITUDE SWEEP .....	4E-2
4E-3.	SUMMARY OF SWEEP MODES .....	4E-2
4E-4.	SELECTING SYMMETRIC OR ASYMMETRIC SWEEP .....	4E-3
4E-5.	SETTING SWEEP DWELL TIME .....	4E-3
4E-6.	FREQUENCY SWEEP .....	4E-4
4E-7.	Setting Frequency Sweep Width .....	4E-5
4E-8.	Setting Frequency Sweep Increment .....	4E-5
4E-9.	Digital Frequency Sweep Example .....	4E-6
4E-10.	AMPLITUDE SWEEP .....	4E-6
4E-11.	Setting Amplitude Sweep Width .....	4E-8
4E-12.	Setting Amplitude Sweep Increment .....	4E-8
4E-13.	Digital Amplitude Sweep Example .....	4E-9
4E-14.	CALIBRATING A RECORDER OR OSCILLOSCOPE .....	4E-10
4E-15.	ANALOG FREQUENCY SWEEP .....	4E-10
<b>4F</b>	<b>SPECIAL FUNCTIONS .....</b>	<b>4F-1</b>
4F-1.	INTRODUCTION .....	4F-1
4F-2.	ENABLING SPECIAL FUNCTIONS .....	4F-3
4F-3.	VIEWING ENABLED SPECIAL FUNCTIONS .....	4F-3
4F-4.	THE SPCL ANNUNCIATOR .....	4F-4
4F-5.	MISCELLANEOUS SPECIAL FUNCTIONS .....	4F-4
4F-6.	Disable Special Functions .....	4F-4
4F-7.	Restore Instrument Preset State .....	4F-4
4F-8.	Execute Self-Test and Display Self-Test Results .....	4F-4
4F-9.	Display Loaded Options .....	4F-4

TABLE OF CONTENTS, *continued*

SECTION	TITLE	PAGE
4F-10.	Display Instrument ID and Software Revision Level .....	4F-4
4F-11.	Blank Front Panel Display .....	4F-5
4F-12.	Select Repeat Rate for Step Keys .....	4F-5
4F-13.	Configure Edit Knob and Step Keys .....	4F-5
<b>4G</b>	<b>ERROR AND STATUS REPORTING .....</b>	<b>4G-1</b>
4G-1.	GENERAL DESCRIPTION .....	4G-1
4G-2.	THE STATUS KEY .....	4G-1
4G-3.	DISPLAYING SELF-TEST STATUS AND CALIBRATION/COMPENSATION DATA .....	4G-2
<b>5</b>	<b>REMOTE OPERATION .....</b>	<b>5-1</b>
5-1.	INTRODUCTION .....	5-1
5-2.	SETTING UP THE IEEE-488 INTERFACE .....	5-1
5-3.	Address Setup Procedure .....	5-2
5-4.	Talker/Listener Mode Selection Procedure .....	5-2
5-5.	Compatibility Language Selection Procedure .....	5-3
<b>5A</b>	<b>REMOTE PROGRAMMING .....</b>	<b>5A-1</b>
5A-1.	INTRODUCTION .....	5A-1
5A-2.	COMMAND SYNTAX INFORMATION .....	5A-2
5A-3.	Parameter Syntax Rules .....	5A-2
5A-4.	Extra Space Characters .....	5A-3
5A-5.	Terminators .....	5A-3
5A-6.	Incoming Character Processing .....	5A-4
5A-7.	Response Message Syntax .....	5A-4
5A-8.	INPUT BUFFER OPERATION .....	5A-4
5A-9.	COMMANDS .....	5A-4
5A-10.	Multiple Commands .....	5A-5
5A-11.	Command Processing .....	5A-5
5A-12.	Command Restrictions .....	5A-5
5A-13.	Commands That Require the CAL COMP Switch To Be Set .....	5A-5
5A-14.	REMOTE/LOCAL STATE TRANSITIONS .....	5A-6
5A-15.	CHECKING THE INSTRUMENT STATUS .....	5A-7
5A-16.	Serial Poll Status Byte (STB) .....	5A-7
5A-17.	BIT ASSIGNMENTS FOR THE STB AND SRE .....	5A-7
5A-18.	SERVICE REQUEST LINE (SRQ) .....	5A-9
5A-19.	SERVICE REQUEST ENABLE REGISTER (SRE) .....	5A-9
5A-20.	PROGRAMMING THE STB AND SRE .....	5A-10
5A-21.	Event Status Register (ESR) .....	5A-10
5A-22.	BIT ASSIGNMENTS FOR THE ESR AND ESE .....	5A-10
5A-23.	EVENT STATUS ENABLE REGISTER (ESE) .....	5A-12
5A-24.	PROGRAMMING THE ESR AND ESE .....	5A-12
5A-25.	Output Queue .....	5A-13
5A-26.	Error Queue .....	5A-13
5A-27.	Instrument Status Register (ISR) .....	5A-14
5A-28.	BIT ASSIGNMENTS FOR THE ISR, ISCR, AND ISCE .....	5A-14
5A-29.	INSTRUMENT STATUS CHANGE REGISTER (ISCR) .....	5A-14

SECTION	TITLE	PAGE
5A-30.	INSTRUMENT STATUS CHANGE ENABLE REGISTER (ISCE) .....	5A-15
5A-31.	PROGRAMMING THE ISR, ISCR, AND ISCE .....	5A-15
5A-32.	Status Queue .....	5A-16
5A-33.	IEEE-488 INTERFACE CONFIGURATION .....	5A-16
5A-34.	BUS COMMUNICATION OVERVIEW .....	5A-16
5A-35.	Definition: Queries and Commands .....	5A-17
5A-36.	Functional Elements of Commands .....	5A-17
5A-37.	Interface Messages .....	5A-19
5A-38.	THE IEEE-488 CONNECTOR .....	5A-21
5A-39.	REMOTE PROGRAM EXAMPLES .....	5A-22
5A-40.	Using the *OPC?, *OPC, and *WAI Commands .....	5A-22
5A-41.	Using the *DDT and *TRG Commands .....	5A-23
<b>5B</b>	<b>REMOTE COMMAND TABLES .....</b>	<b>5B-1</b>
5B-1.	REMOTE COMMAND SUMMARY .....	5B-1
5B-2.	REMOTE COMMANDS .....	5B-1
<b>5C</b>	<b>TALK-ONLY/LISTEN-ONLY OPERATION .....</b>	<b>5C-1</b>
5C-1.	INTRODUCTION .....	5C-1
5C-2.	TALK-ONLY OPERATION .....	5C-1
5C-3.	LISTEN-ONLY OPERATION .....	5C-2
5C-4.	LISTEN-ONLY/TALK-ONLY EXAMPLE .....	5C-2
<b>5D</b>	<b>COMPATIBILITY LANGUAGES .....</b>	<b>5D-1</b>
5D-1.	INTRODUCTION .....	5D-1
5D-2.	SELECTING THE ACTIVE LANGUAGE .....	5D-1
5D-3.	USING THE 6060 AND 6070 FAMILY LANGUAGES .....	5D-2
5D-4.	Incompatibilities .....	5D-2
5D-5.	Converting 6060 and 6070 Programs to Use the 6080 Language .....	5D-9
5D-6.	USING THE HP 8642 FAMILY LANGUAGE .....	5D-12
5D-7.	IEEE-488 (GPIB) Address .....	5D-12
5D-8.	IEEE-488 (GPIB) Interface Capabilities .....	5D-12
5D-9.	Data Input and Numeric Formatting .....	5D-13
5D-10.	Data Output .....	5D-13
5D-11.	HP8642 Commands .....	5D-13
5D-12.	RF Output Frequency .....	5D-13
5D-13.	Relative RF Frequency .....	5D-16
5D-14.	RF Frequency Sweep .....	5D-16
5D-15.	RF Output Amplitude .....	5D-17
5D-16.	EMF Units .....	5D-17
5D-17.	Relative Amplitude .....	5D-17
5D-18.	Amplitude Sweep .....	5D-17
5D-19.	AM/Pulse Modulation .....	5D-17
5D-20.	FM/ $\phi$ M .....	5D-17
5D-21.	Internal Modulation Oscillator .....	5D-18
5D-22.	Instrument Preset/Partial Preset .....	5D-19

TABLE OF CONTENTS, *continued*

SECTION	TITLE	PAGE
5D-23.	Knob Control/Entry Off .....	5D-19
5D-24.	Step, Increment Set .....	5D-19
5D-25.	Save/Recall Register .....	5D-19
5D-26.	Special Functions .....	5D-20
5D-27.	Messages .....	5D-20
<b>Appendix A</b>		
	<b>Instrument Preset State .....</b>	<b>A-1</b>
<b>Appendix B</b>		
	<b>Special Function Table .....</b>	<b>B-1</b>
<b>Appendix C</b>		
	<b>Rejected Entry Codes .....</b>	<b>C-1</b>
<b>Appendix D</b>		
	<b>Overrange/Uncal Status Codes .....</b>	<b>D-1</b>
<b>Appendix E</b>		
	<b>Self-Test Status Codes .....</b>	<b>E-1</b>
<b>Appendix F</b>		
	<b>Rear Panel AUX Connector Pinout .....</b>	<b>F-1</b>

## List of Tables

TABLE	TITLE	PAGE
1-1.	Specifications for Model 6080A .....	1-5
1-2.	Specifications for Model 6082A .....	1-12
2-1.	Standard Equipment .....	2-2
2-2.	Line Power Cord Types Available from Fluke .....	2-2
2-3.	Accessories .....	2-3
3-1.	Front Panel Features .....	3-3
3-2.	Rear Panel Features .....	3-12
4-1.	Step Size Defaults .....	4-3
4A-1.	Signal Generator Frequency Bands .....	4A-4
4B-1.	Relative Amplitude Unit Combinations .....	4B-5
4B-2.	RF Output Amplitude Bands .....	4B-6
4C-1.	FM/ $\phi$ M Deviation Limits (FM/ $\phi$ M Enabled) .....	4C-9
4C-2.	FM Band Limits .....	4C-11
4C-3.	FM Band Limits - Low Distortion Mode .....	4C-12
4D-1.	Non-Storable/Recallable Parameters .....	4D-2
4D-2.	Nonvolatile Memory Locations .....	4D-2
4F-1.	Special Function Codes .....	4F-2
4F-2.	Functions of Edit Knob and Step Keys .....	4F-5
4G-1.	Interpreting Status Codes .....	4G-2
5A-1.	Remote/Local State Transitions .....	5A-7
5A-2.	IEEE-488 Interface Function Subsets Supported .....	5A-9
5A-3.	Functional Elements of Commands .....	5A-18
5A-4.	Interface Messages that the Signal Generator Accepts .....	5A-19
5A-5.	Interface Messages that the Signal Generator Sends .....	5A-21
5B-1.	Remote Command Summary .....	5B-2
5B-2.	Units That Can Be Used With Remote Commands .....	5B-7
5B-3.	Remote Commands .....	5B-8
5D-1.	6060 Compatibility Language Codes and Special Functions .....	5D-3
5D-2.	6070 Compatibility Language Codes and Special Functions .....	5D-5
5D-3.	6060 and 6070 Compatibility Language Commands .....	5D-7
5D-3A.	Commands not in 6060 or 6070 Compatibility Language .....	5D-10
5D-4.	6060 and 6070 Compatibility Language Units .....	5D-11
5D-5.	IEEE-488 Interface Capabilities/HP8642 Language .....	5D-11
5D-6.	6080 to HP8642 Error Code Mapping .....	5D-14
5D-7.	HP8642 Commands That Are Not Emulated .....	5D-15
5D-8.	HP8642 RF Output Frequency Commands That Are Not Emulated .....	5D-15
5D-9.	Frequency Sweep Commands That Are Not Emulated .....	5D-16
5D-10.	Amplitude Sweep Commands That Are Not Emulated .....	5D-18
5D-11.	FM/ $\phi$ M Commands That Are Not Emulated .....	5D-18
5D-12.	HP8642 Special Functions Emulated .....	5D-20



# Section 1

## Introduction and Specifications

### INTRODUCTION

1-1.

The Model 6080A and 6082A Synthesized RF Signal Generators are fully programmable, precision, synthesized signal source. They are designed for applications that require good modulation, frequency, and output level performance with excellent spectral purity. Both Signal Generators are well suited for testing a wide variety of RF components, subassemblies, and systems, including filters, amplifiers, mixers, and receivers, particularly off-channel radio testing.

Both models are called the Signal Generator in this manual. It is noted wherever information applies specifically to one model or the other.

Specifications of the Signal Generator are provided at the end of this section. Features of the Signal Generator include the following:

- Frequency range, in 1 Hz steps, as follows:
  - 6080A: 10 kHz to 1056 MHz
  - 6082A: 100 kHz to 2112 MHz
- Amplitude ranges as follows, with 0.1 dB resolution:
  - 6080A: +19 to -140 dBm for RF output frequencies below 512 MHz, and +17 to -140 dBm for RF output frequencies 512 MHz and above.
  - 6082A: +16 to -140 dBm for RF output frequencies below 1056 MHz, and +13 to -140 dBm for RF output frequencies 1056 MHz and above.
- Amplitude units accepted and displayed: dB, dBm, dBf, dB $\mu$ V, dBmV, mV,  $\mu$ V, V, and EMF.
- Internal and external modulation: AM, FM,  $\phi$ M, and pulse.
- Internal 0.1 Hz to 200 kHz direct-digital synthesis modulation oscillator that provides sine, square, triangular, and pulse waveforms.
- Digital frequency sweep and digital amplitude sweep.
- Fifty storable and recallable instrument state memory locations.

## INTRODUCTION AND SPECIFICATIONS

- Standard IEEE-488 (GPIB) Interface, complying with ANSI-IEEE Standards 488.1-1987 and 488.2-1987.
- Software compatibility modes for emulation of Fluke 6060/6070 or Hewlett Packard HP8642A/B remote programming languages.
- Closed case calibration capabilities for frequency reference, AM, FM, and level.

### INSTRUCTION MANUALS

1-2.

The 6080A/82A Manual Set provides complete information for the operator and service or maintenance personnel. The set includes the following manuals:

- 6080A/82A Operator Manual, PN 861034
- 6080A/82A Operator Reference Guide, PN 882154
- 6080A/82A Remote Programming Reference Guide, PN 882147
- 6080A/82A Special Functions Decal, PN 860911
- 6080A/82A Service Manual, PN 868914
- 6080A/82A Service Manual, PN 881888

Each Signal Generator is shipped one each of the first four manuals above, plus the applicable Service Manual. The two reference guides and the special functions decal are packaged with this Operator Manual. You can order additional copies of the manuals, reference guides, or decal separately using the part number provided. For ordering instructions, refer to the Giga-tronics Catalog, or contact a Giga-tronics sales representative. A list of Giga-tronics Sales and Service centers is in Appendix G.

#### 6080A/82A Operator Manual

1-3.

This 6080A/82A Operator Manual provides complete information for installing the Signal Generator and operating it from the front panel controls and in remove over the IEEE-488 Bus.

#### 6080A/82A Operator Reference Guide

1-4.

The 6080A/82A Operator Reference Guide is a pocket-sized booklet that contains a summary of operating instructions from the Operator Manual, including a front and rear panel feature reference, special function codes, and status and error codes.

#### 6080A/82A Remote Programming Reference Guide

1-5.

The 6080A/82A Remote Programming Reference Guide is a pocket-sized booklet that contains a summary of remote operating information, including syntax rules, remote commands, parameters, and responses, plus how to determine system status using the status byte and registers.

#### 6080A/82A Special Functions Decal

1-6

The 6080A/82A Special Functions Decal is an adhesive-backed reference card intended to be affixed to the top surface of the Signal Generator. The card contains a summary of the Special Functions that are activated by entering number codes with the numeric keypad.



## **6080A and 6082A Service Manuals**

**1-7.**

These service manuals are maintenance guides for the Signal Generator. The following topics are included in the service manual:

- Theory of operation
- Closed-case calibration
- Performance testing
- Access procedures
- Troubleshooting and alignment
- Parts lists
- Schematic diagrams

## **OPTIONS**

**1-8.**

Three options are available for the 6080A:

- 6080A-830 Rear Output and Modulation Input
- 6080A-130 High Stability Reference (see Specifications)
- 6080A-132 Medium Stability Reference (see Specifications)

All three options are factory-installable only. The -830 option moves the MOD OUTPUT, RF OUTPUT, and MODULATION INPUT connector to the rear panel. The front panel connector holes are covered with plugs.

Operation of the Signal Generator is the same with or without the -130 or -132 option installed. Refer to the specifications for the time and temperature stability of each type of reference.

Theory of operation and schematics for these options are contained in the Options section of the applicable Service Manual.

## **WARRANTY AND SERVICE INFORMATION**

**1-9.**

Each Signal Generator is warranted for a period of 1 year upon delivery to the original purchaser. The warranty is on the back of the title page of this manual.

Factory authorized service for the Signal Generator is available at selected Giga-tronics Technical Service Centers. For service, return the Signal Generator to the nearest Giga-tronics Technical Service Center. The local service center will handle transportation to and from the selected service center as required. A complete list of Giga-tronics Sales and Technical Service Centers is provided following the parts lists in Section 10.

To reship the Signal Generator, use its original shipping carton. If the original carton is not available, use a container that provides adequate protection during shipment. Protect the Signal Generator with at least three inches of shock-absorbing material on all sides of the container. Do not use loose fill to pad the shipping container. Loose fill allows the signal generator to settle to one corner of the shipping container, which could result in damage during shipment.

After-warranty service is available, but you may choose to repair the Signal Generator using the information in the Troubleshooting section of the service manual and the Module Exchange Program. Refer to the Giga-tronics catalog or contact a Technical Service Center representative for the module exchange procedure.

## INTRODUCTION AND SPECIFICATIONS

### SPECIFICATIONS

1-10.

Table 1-1 lists specifications for the 6080A. Table 1-2 lists specifications for Model 6082A. Specifications are valid after a warm-up period of 20 minutes. Specifications remain valid after two years only if the Signal Generator is calibrated at that time as described in the service manual, and every two years or more frequently thereafter. In the specification table, dBc refers to decibels relative to the amplitude of the carrier.

## INTRODUCTION AND SPECIFICATIONS

**Table 1-1. Specifications for Model 6080A**

<b>FREQUENCY</b>				
<b>Range:</b> 10 kHz to 1056 MHz. (Also see Internal Modulation Oscillator for coverage from 0.1 Hz to 200 kHz.) <b>Frequency Bands:</b> The carrier frequency band endpoints are shown below.				
BAND DESIGNATION	APPROXIMATE CARRIER FREQUENCY BAND (MHz)	SPECIFIC CARRIER FREQUENCY BAND (MHz)		
A	0.01 to 15	0.01 to 14.999,999		
B	15 to 32	15 to 31.999,999		
C	32 to 64	32 to 63.999,999		
D	64 to 128	64 to 127.999,999		
E	128 to 256	128 to 255.999,999		
F	256 to 512	256 to 511.999,999		
G	512 to 1056	512 to 1056		
<b>Resolution:</b> 1 Hz <b>Display Resolution:</b> 10 digits <b>Stability:</b> Same as Internal Reference Oscillator				
<b>10 MHz INTERNAL REFERENCE OSCILLATOR</b> <b>Type:</b> Temperature Compensated Crystal Oscillator (TCXO) <b>Temperature Stability:</b> Less than $\pm 1$ ppm p-p over the range 0 to $+50^\circ\text{C}$ <b>Typical Aging Rate:</b> Less than $\pm 1$ ppm/yr <b>Reference Output:</b> 10 MHz, $>0$ dBm for $50\Omega$ load, available at the rear panel REF OUT connector.				
<b>PROVISION FOR EXTERNAL REFERENCE</b> The rear panel REF IN connector accepts an external source of 10 MHz $\pm 10$ ppm sine wave, 0.2 to 2.0V rms for a $50\Omega$ load. One alternate external reference frequency setting of 1, 2, or 5 MHz is available at a time, through Special Function 761 or a remote command. The default alternate reference frequency is 5 MHz. See the Service Manual for setting internal DIP switches for use with a 1 or 2 MHz external reference.				
<b>AMPLITUDE</b> <b>Range:</b> $+19$ to $-140$ dBm for RF output frequency $<512$ MHz. $+17$ to $-140$ dBm for RF output frequency $>512$ MHz. <b>Resolution:</b> 0.1 dB (0.1% or 1 nV in volts). Annunciators for dB, dBm, V, mV, $\mu\text{V}$ , dBf, dB $\mu\text{V}$ , dBmV, and EMF <b>Display Resolution:</b> 3 1/2 digits  <b>Accuracy (0 to <math>50^\circ\text{C}</math>):</b>				
FREQUENCY (MHz)	AMPLITUDE IN dBm			
	$+19$	$+17$	$-127$	$-140$
0.01 to 0.1	$\leftarrow \text{---} \pm 3 \text{ dB} \text{---} \rightarrow$			
0.1 to 0.4	$\leftarrow \text{---} \pm 2 \text{ dB} \text{---} \times \text{---} \pm 3 \text{ dB} \text{---} \rightarrow$			
0.4 to 512	$\leftarrow \text{---} \pm 1 \text{ dB} \text{---} \times \text{---} \pm 3 \text{ dB} \text{---} \rightarrow$			
512 to 1056	$\leftarrow \text{---} \pm 1 \text{ dB} \text{---} \times \text{---} \pm 3 \text{ dB} \text{---} \rightarrow$			

INTRODUCTION AND SPECIFICATIONS

Table 1-1. Specifications for Model 6080A (cont.)

<p>Source SWR: &lt;1.5:1 below +6 dBm &lt;2.0:1 above +6 dBm</p> <p>Flatness (0 to 50°C): ±0.75 dB at +10 dBm, for frequencies &gt;0.1 MHz</p> <p>Intermodulation Distortion (Amplitude of +4 dBm, CW only):</p>			
FREQUENCY (MHz)	SPACING		
	1 kHz	25 kHz	
0.01 to 128 MHz	-60 dBc	-75 dBc	
128 to 512 MHz	-65 dBc	-75 dBc	
512 to 1056 MHz	-65 dBc	-70 dBc	
<p><b>SPECTRAL PURITY (CW ONLY)</b></p> <p>Spurious Signals: &lt;-100 dBc for offsets greater than 10 kHz. Fixed-frequency spurious signals are &lt;-100 dBc or &lt;-140 dBm, whichever is greater.</p> <p>Harmonics: &lt;-30 dBc for amplitudes less than +13 dBm.</p> <p>Subharmonics: None.</p> <p>Power Line Spurious Signals (offsets less than 10 kHz): &lt;-56 dBc</p> <p>Residual FM: (NOTE 1)</p>			
FREQUENCY BAND (MHz)	RESIDUAL FM		
	0.3 to 3 kHz	50 Hz to 15 kHz	
0.01 to 15	0.2	0.4	
15 to 32	0.2	0.4	
32 to 64	0.2	0.4	
64 to 128	0.2	0.4	
128 to 256	0.4	0.5	
256 to 512	0.7	1.0	
512 to 1056	1.5	2.0	
<p><b>SSB Phase Noise: (NOTE 1)</b></p>			
CARRIER FREQUENCY BAND (MHz)	OFFSET FREQUENCY		
	1 kHz (dBc/Hz)	20 kHz (dBc/Hz)	100 kHz (dBc/Hz)
0.01 to 15	-112	-138	-138
15 to 32	-124	-145	-146
32 to 64	-118	-144	-146
64 to 128	-112	-144	-145
128 to 256	-106	-141	-144
256 to 512	-100	-136	-142
512 to 1056	-94	-131	-138
<p>Residual AM (50 Hz to 15 kHz Band): &lt; .01% (-80 dBc)</p>			
<p><b>NOTE 1:</b> Allowable operating modes CW, AM, FM (peak dev. &lt;1.5% of max in operating band), <math>\emptyset</math>M (same comment as FM), Pulse.</p>			

Table 1-1. Specifications for Model 6080A (cont.)

**AMPLITUDE MODULATION**

- Depth Range: 0% to 99.9% for RF output level <+10 dBm.
- AM Resolution: 0.1%
- AM Display: 3 digits
- AM Accuracy: ±(2% + 4% of setting) for rate = 1 kHz and depth <90%
- AM Distortion (Rate = 1 kHz) (NOTE 2): <1.5% THD to 30% AM  
<3% THD to 70% AM  
<5% THD to 90% AM
- AM 3-dB Bandwidth (NOTE 2): AC-coupled AM, 20 Hz to 50 kHz  
DC-coupled AM, dc to 50 kHz

Incidental ØM: <0.20 radian at 1 kHz rate and 30% AM

**FREQUENCY MODULATION (NOTE 3)**

- FM Display Ranges:  
 0 to 999 Hz Dev, 1 Hz Resolution  
 and Resolution  
 1 to 9.99 kHz Dev, 10 Hz Resolution  
 10 to 99.9 kHz Dev, 100 Hz Resolution  
 100 to 999 kHz Dev, 1 kHz Resolution  
 1 to 4.00 MHz Dev, 10 kHz Resolution

**Maximum Deviation:**

FREQUENCY BAND (MHz)	MAXIMUM DEVIATION			
	DC-COUPLED FM	AC-COUPLED FM (the smaller of)		
		ABSOLUTE MAXIMUM	RATE LIMITED MAXIMUM	
			DEV ≥ 1/64 MAX	DEV < 1/64 MAX
0.01 to 15	500 kHz	500 kHz	fmod x 5000	fmod x 78
15 to 32	125 kHz	125 kHz	fmod x 1250	fmod x 19
32 to 64	250 kHz	250 kHz	fmod x 2500	fmod x 39
64 to 128	500 kHz	500 kHz	fmod x 5000	fmod x 78
128 to 256	1 MHz	1 MHz	fmod x 10000	fmod x 156
256 to 512	2 MHz	2 MHz	fmod x 20000	fmod x 312
512 to 1056	4 MHz	4 MHz	fmod x 40000	fmod x 625

**FM Distortion:**

- Standard Mode: <2% for 0.5 to 1.0 times maximum deviation; <1% for <0.5 times maximum deviation. Applies for rates of 50 Hz to 50 kHz.
- Low-Distortion Mode (Special Function 731): <0.15% for ≤ 3.5 kHz peak deviation and rates 0.3 to 3 kHz.
- FM Accuracy: ±(5% of setting + 10 Hz) for rates of 50 Hz to 50 kHz

NOTE 2: AM specifications apply where (RF output frequency - mod frequency) >150 kHz.

NOTE 3: FM specifications apply where: (RF output frequency - deviation) >150 kHz and (RF output frequency - mod rate) >150 kHz.

**INTRODUCTION AND SPECIFICATIONS**

**Table 1-1. Specifications for Model 6080A (cont.)**

<b>FM 3-dB Bandwidth:</b>		
<b>DEVIATION</b>	<b>COUPLING</b>	
	<b>INTERNAL AC</b>	<b>EXTERNAL AC (DC)</b>
0% to 25% Maximum	20 Hz to 175 kHz	20 Hz (dc) to 175 kHz
25% to 100% Maximum	20 Hz to 100 kHz	20 Hz (dc) to 100 kHz
<p><b>Incidental AM:</b> &lt;1% depth for peak deviation &lt;100 kHz at 1-kHz rate and carrier frequency &gt;0.5 MHz  <b>DC-Coupled FM Center Frequency Error, at 1 GHz, after dcFM internal cal, and without any FM range changes:</b> &lt;(.1% of dev + 500 Hz)  <b>Low-Rate External AC-Coupled FM (Special Function 711):</b></p>		
<b>FREQUENCY BAND (MHz)</b>	<b>MAX DEV, IN kHz (AT 10 Hz RATE)</b>	
	<b>SINE WAVE</b>	<b>SQUARE WAVE</b>
0.01 to 15	80	40
15 to 32	20	10
32 to 64	40	20
64 to 128	80	40
128 to 256	160	80
256 to 512	320	160
512 to 1056	640	320
<p><b>Droop:</b> &lt;30% on a 5 Hz square wave  <b>3-dB Bandwidth:</b> 0.5 Hz to 100 kHz (typical)  <b>Maximum DC Input:</b> ±10 mV  <b>Incidental AM:</b> &lt;1% AM at 1 kHz rate and &lt;10 kHz deviation</p>		
<b>PHASE MODULATION (NOTE 4)</b>		
<p><b>Display Ranges:</b> 0 to .999 radians, 1 to 9.99 radians, 10 to 99.9 radians, 100 to 400 radians  <b>Display Resolution:</b> 3 digits</p>		
<b>Maximum Deviation:</b>		
<b>FREQUENCY BAND (MHz)</b>	<b>MAXIMUM DEVIATION (RADIAN)</b>	
0.01 to 15	50	
15 to 32	12.5	
32 to 64	25	
64 to 128	50	
128 to 256	100	
256 to 512	200	
512 to 1056	400	
<p><b>NOTE 4:</b> Phase modulation specifications are valid where (RF frequency - mod frequency) &gt;150 kHz</p>		

Table 1-1. Specifications for Model 6080A (cont.)

High-Rate Phase Modulation Maximum Deviation (Special Function 721):	
FREQUENCY BAND (MHz)	MAXIMUM DEVIATION (RADIAN)
0.01 to 15	5
15 to 32	1.25
32 to 64	2.5
64 to 128	5
128 to 256	10
256 to 512	20
512 to 1056	40

**Accuracy:**  $\pm(5\%$  of setting + 0.1 radian) at 1-kHz rate  
**Distortion (NOTE 5):** <2% THD from maximum deviation to 1/2 max deviation, and <1% THD at 1/2 maximum deviation or less at 1-kHz rate.  
**3-dB Bandwidth:** AC-coupled phase modulation, 20 Hz to 15 kHz  
DC-coupled phase modulation, dc to 15 kHz  
**High-Rate Phase Modulation 3-dB Bandwidth (Special Function 721):**  
AC-coupled phase modulation, 20 Hz to 100 kHz  
DC-coupled phase modulation, dc to 100 kHz  
**Incidental AM (valid for output frequency >500 kHz):** 1% AM at 1-kHz rate for peak deviation <10 radians.

**PULSE MODULATION (For RF Output Frequencies >10 MHz)**  
**On/Off Ratio:** 40 dB minimum for frequencies from 100 to 1056 MHz  
60 dB minimum for frequencies <100 MHz  
**Rise and Fall Times:** <15 ns, 10% to 90%  
**Level Error:** For pulse widths >50 ns, the power in the pulse is within  $\pm 0.7$  dB of the measured CW level.  
**Duty Cycle (External Modulation):** 0 to 100%  
**Repetition Rate (External Modulation):** DC to 10 MHz  
**Internal Modulation:** Internal rates and widths  
**External Modulation:** The pulse input is TTL compatible, terminated in 50 $\Omega$  with internal active pull-up. It can be modeled as 1.2V in series with 50 $\Omega$  at the pulse mod input connector. The instrument senses input terminal voltage and turns the RF OUTPUT off when the terminal voltage drops below  $1 \pm 0.1$ V. The maximum allowable input is  $\pm 10$ V.

**PULSE MODULATION (For RF Output Frequencies <10 MHz)**  
**Rise and Fall Times:** <2 times the period of the RF output frequency  
**Level Error:** For pulse widths >10 times the period of the RF output frequency, the power in the pulse is within  $\pm 0.7$  dB of the measured CW level.  
Other pulse specifications are the same as for the >10 MHz frequency range.

**NONVOLATILE INSTRUMENT STATE MEMORY**  
50 instrument states are retained for typically 2 years, even with ac line power disconnected.

**REVERSE-POWER PROTECTION**  
**Protection Level:** Up to 50 watts from a 50 $\Omega$  source; up to 50V dc. RF OUTPUT is ac coupled. Protection is provided when the signal generator is turned off.

**NOTE 5:** Valid for rates from 50 Hz to 50 kHz in high-bandwidth mode. Does not include effects of residual phase noise.

## INTRODUCTION AND SPECIFICATIONS

**Table 1-1. Specifications for Model 6080A (cont.)**

**Trip/Reset:** A flashing RF OFF annunciator indicates a tripped condition. Pressing RF ON/OFF button resets the signal generator.

### IEEE-488 REMOTE CONTROL

**Extent of Remote Control:** All controls except the POWER, REF/INT EXT, and CAL/COMP switches are remotely programmable via the IEEE-488 Interface (Std. 488.2-1987). All status including the option complement are available remotely.

**Interface Functions Supported:** SH1, AH1, T5, TE0, L3, LE0, SR1, RL1, PP0, DC1, DT1, C0, and E2.

### INTERNAL MODULATION SOURCE (Sine Wave)

**Rates:** 0.1 Hz to 200 kHz, key-selectable 400/1000 Hz

**Display Ranges:** 00.1 to 99.9 Hz

100 to 999 Hz

1.00 to 9.99 kHz

10.0 to 99.9 kHz

100 to 200 kHz

**Frequency Resolution:** 0.1 Hz or 3 digits

**Frequency Accuracy:** Same as reference oscillator  $\pm 7$  millihertz

**Output Level Range:** 0 to 4V pk into 600 $\Omega$

**Output Level Resolution:** 1 mV pk or 3 digits, whichever is greater.

**Distortion:**  $< 0.15\%$  THD for output levels  $> 0.2V$  pk and modulation frequency  $< 20$  kHz.

**Output Level Accuracy:**  $\pm(4\% + 15 \text{ mV})$  for modulation frequency  $< 100$  kHz.

**Output Impedance:** 600 $\Omega \pm 2\%$

#### Other Waveforms Available by Special Function:

- Square Wave (Special Function 752)
- Triangle Wave (Special Function 751)
- Pulse (Special Functions 758,759), width 100 ns to 1/Fmod in 100 ns or 3-digit increments, whichever is greater. Rate and width are coherent with signal generator time base.

### EXTERNAL MODULATION

1V pk provides indicated modulation index. Nominal input impedance is 600 $\Omega$ . Maximum level is  $\pm 5V$  pk.

### MODULATION MODES

Any combination of AM, PULSE, and FM or  $\emptyset$ M, internal or external, may be used.

### DIGITAL FREQUENCY SWEEP

**Sweep Modes:** Auto, single, or manual

**Adjustable Parameters:** Sweep symmetry, sweep speed, sweep width, and sweep increment.

**Sweep Speed:** Minimum 40 ms/increment selectable as (minimum + dwell time) where dwell time can be 0, 20, 50, 100, 200, 500 ms, or 1, 2, 5, or 10s at each increment.

### DIGITAL AMPLITUDE SWEEP

**Sweep Type:** Linear (volts) or logarithmic (dB)

**Sweep Modes:** Auto, single, or manual.

**ADJUSTABLE PARAMETERS:** Sweep symmetry, sweep speed, sweep width, and sweep increment.

**Sweep Speed:** Minimum 30 ms/increment selectable as (minimum + dwell time) where dwell time can be 0, 20, 50, 100, 200, 500 ms, or 1, 2, 5, or 10s at each increment.

### SWEEP OUTPUT (AUX Connector Pin 5)

0 to +10V  $\pm 10\%$ , up to 4096 points in a stepped ramp, load  $> 2 \text{ k}\Omega$ .



Table 1-1. Specifications for Model 6080A (cont.)

**PEN LIFT OUTPUT (AUX Connector Pin 4)**

TTL level, high during sweep retrace, load >2 kΩ.

**GENERAL SPECIFICATIONS**

**Temperature:** Operating, 0 to +50°C (+32 to +122°F).

Nonoperating, -40 to +75°C (-40 to +167°F).

**Operating Humidity Range:** 95% to +30°C, 75% to +40°C, and 45% to +50°C.

**Operating Altitude:** Up to 10,000 ft.

**Vibration:** Nonoperating, 5 to 15 Hz at 0.06 in, 15 to 25 Hz at 0.04 in, and 25 to 55 Hz at 0.02 in, double amplitude (DA).

**Shock:** Nonoperating, bench handling per MIL T 28800C Class 5, Style E.

**Electromagnetic Compatibility:** The radiated emissions induce <0.5 μV (at RF carrier frequency) into a 1-inch diameter, 2-turn loop, 1-inch from any surface as measured into a 50Ω receiver.

**Complies with Standards:**

- CE03 of MIL-STD-461B (Power and interconnecting leads), 0.015 to 50 MHz.
- RE02 of MIL-STD-461B (14 kHz to 10 GHz).
- FCC Part 15, Class B.
- VDE 0871B
- CISPR 22

<b>Size:</b>	<b>Width</b>	<b>Height</b>	<b>Depth</b>
	43 cm	13.3 cm	59.7 cm
	17 in	5.25 in	23.5 in

**Power Requirements:** 100, 120, 220, or 240V, each ±10%; 48-63 Hz; 200 VA, <15 VA in standby, with any options installed.

**Weight:** 27 kg (60 lbs).

**OPTION -130 HIGH-STABILITY REFERENCE**

**Aging Rate:**  $\leq 5 \times 10^{-10}$ /day, after 21 days continuous operation.

**Temperature Stability:**  $\leq 2 \times 10^{-10}$ /°C. (Oven remains powered in standby.)

**OPTION -132 MEDIUM-STABILITY REFERENCE**

**Aging Rate:**  $\leq 1 \times 10^{-7}$ /month after 5 days continuous operation.

**Temperature Stability:**  $\leq 1 \times 10^{-7}$  (0 to +50°C)

**OPTION -830 REAR PANEL CONNECTORS**

Moves connectors for MODULATION INPUT, MOD output, and RF OUTPUT to the rear panel. The front panel connector locations are covered with plugs.

**SUPPLEMENTAL CHARACTERISTICS**

The following characteristics are provided to assist in signal generator applications and to describe some other aspects of typical performance.

**Frequency Switching Speed:** <100 ms to settle within 100 Hz

**Amplitude Switching Speed:** <100 ms to settle within 0.1 dB

**Pulse Modulation Delay:** 80 ns typical

# INTRODUCTION AND SPECIFICATIONS

**Table 1-2. Specifications for Model 6082A**

<b>FREQUENCY</b>				
<p><b>Range:</b> 100 kHz to 2112 MHz. (See Internal Modulation Oscillator for coverage from 0.1 Hz to 200 kHz.)  <b>Frequency Bands:</b> The carrier frequency band endpoints are shown below.</p>				
BAND DESIGNATION	APPROXIMATE CARRIER FREQUENCY BAND (MHz)	SPECIFIC CARRIER FREQUENCY BAND (MHz)		
A	0.1 to 15	0.1 to 14.999,999		
B	15 to 32	15 to 31.999,999		
C	32 to 64	32 to 63.999,999		
D	64 to 128	64 to 127.999,999		
E	128 to 256	128 to 255.999,999		
F	256 to 512	256 to 511.999,999		
G	512 to 1056	512 to 1055.999,999		
H	1056 to 2112	1056 to 2112		
<p><b>Resolution:</b> 1 Hz  <b>Display Resolution:</b> 10 digits  <b>Stability:</b> Same as Internal Reference Oscillator</p>				
<p><b>10 MHz INTERNAL REFERENCE OSCILLATOR</b>  <b>Type:</b> Temperature Compensated Crystal Oscillator (TCXO)  <b>Temperature Stability:</b> Less than <math>\pm 1</math> ppm p-p over the range 0 to <math>+50^{\circ}\text{C}</math>  <b>Typical Aging Rate:</b> Less than <math>\pm 1</math> ppm/yr  <b>Reference Output:</b> 10 MHz, <math>&gt;0</math> dBm for <math>50\Omega</math> load, available at the rear panel REF OUT connector.</p>				
<p><b>PROVISION FOR EXTERNAL REFERENCE</b>  The rear panel REF IN connector accepts an external source of 10 MHz <math>\pm 10</math> ppm sine wave, 0.2 to 2.0V rms for a <math>50\Omega</math> load. One alternate external reference frequency setting of 1, 2, or 5 MHz is available at a time, through Special Function 761 or a remote command. The default alternate reference frequency is 5 MHz. See the Service Manual for setting internal DIP switches for use with a 1 or 2 MHz external reference.</p>				
<p><b>AMPLITUDE</b>  <b>Range:</b> +16 to -140 dBm for RF output frequency <math>&lt;1056</math> MHz.  +13 to -140 dBm for RF output frequency <math>&gt;1056</math> MHz.  <b>Resolution:</b> 0.1 dB (0.1% or 1 nV in volts). Annunciators for dB, dBm, V, mV, <math>\mu\text{V}</math>, dBf, dB<math>\mu\text{V}</math>, dBmV, and EMF  <b>Display Resolution:</b> 3 1/2 digits  <b>Accuracy (<math>+23</math> to <math>\pm 5^{\circ}\text{C}</math>):</b></p>				
FREQUENCY (MHz)	AMPLITUDE IN dBm			
	+16	+13	-127	-140
0.1 to 0.4	----- $\pm 2$ dB -----		----- $\pm 3$ dB -----	
0.4 to 1056	----- $\pm 1$ dB -----		----- $\pm 3$ dB -----	
1056 to 2112	----- $\pm 1$ dB -----		----- $\pm 3$ dB -----	

Table 1-2. Specifications for Model 6082A (cont.)

Accuracy (0 to 50°C):		
FREQUENCY (MHz)	AMPLITUDE IN dBm	
	+16	+13
0.1 to 0.4	±2 dB	
0.4 to 1056	±1.5 dB	
1056 to 2112	±1.5 dB	
	-127	-140
	±3 dB	
	±3 dB	
	±3 dB	
<b>Source SWR:</b> <1.5:1 below +1 dBm <2.0:1 above +1 dBm <b>Flatness (0 to 50°C):</b> ±1.0 dB at +10 dBm <b>Intermodulation Distortion (Amplitude of +4 dBm, CW only):</b>		
FREQUENCY (MHz)	SPACING	
	1 kHz	25 kHz
0.1 to 128 MHz	-60 dBc	-75 dBc
128 to 512 MHz	-65 dBc	-75 dBc
512 to 2121 MHz	-65 dBc	-70 dBc
<b>SPECTRAL PURITY (CW ONLY)</b> <b>Spurious Signals:</b> <-100 dBc for offsets greater than 10 kHz and RF output frequency <1056 MHz. <94 dBc for offsets greater than 10 kHz and RF output frequency >1056 MHz. Fixed-frequency spurious signals for RF output frequency <1056 MHz are <-100 dBc or <-140 dBm, whichever is greater. Fixed-frequency spurious signals for RF output frequency >1056 MHz are <-94 dBc or <-140 dBm, whichever is greater. <b>Harmonics:</b> <-30 dBc for amplitudes less than +13 dBm at 1 to 2112 MHz. <b>Subharmonics:</b> <-45 dBc for RF output frequencies from 1056 to 2112 MHz. <b>Power Line Spurious Signals (offsets less than 10 kHz):</b> <-56 dBc for RF output frequencies <1056 MHz. <-50 dBc for RF output frequencies >1056 MHz.		
<b>Residual FM: (NOTE 1)</b>		
FREQUENCY BAND (MHz)	RESIDUAL FM	
	0.3 to 3 kHz	50 Hz to 15 kHz
0.1 to 15	0.2	0.4
15 to 32	0.2	0.4
32 to 64	0.2	0.4
64 to 128	0.2	0.4
128 to 256	0.4	0.5
256 to 512	0.7	1.0
512 to 1056	1.5	2.0
1056 to 2112	3.0	4.0
<b>NOTE 1:</b> Allowable operating modes CW, AM, FM (peak dev. <1.5% of max in operating band), ØM (same comment as FM), Pulse.		

INTRODUCTION AND SPECIFICATIONS

Table 1-2. Specifications for Model 6082A (cont.)

SSB Phase Noise: (NOTE 1)			
CARRIER FREQUENCY BAND (MHz)	OFFSET FREQUENCY		
	1 kHz (dBc/Hz)	20 kHz (dBc/Hz)	100 kHz (dBc/Hz)
0.1 to 15	-112	-137	-137
15 to 32	-124	-144	-144
32 to 64	-118	-143	-144
64 to 128	-112	-143	-144
128 to 256	-106	-140	-143
256 to 512	-100	-136	-142
512 to 1056	-94	-131	-138
1056 to 2112	-88	-125	-132

**Residual AM (50 Hz to 15 kHz Band):** < .01% (-80 dBc)

**AMPLITUDE MODULATION**

**Depth Range:** 0% to 99.9% for RF output level <+7 dBm

**AM Resolution:** 0.1%

**AM Display:** 3 digits

**AM Accuracy:** ±(2% + 4% of setting) for rate = 1 kHz and depth <90%

**AM Distortion (Rate = 1 kHz) (NOTE 2):** <1.5% THD to 30% AM  
 <3% THD to 70% AM  
 <5% THD to 90% AM

**AM 3-dB Bandwidth (NOTE 2):** AC-coupled AM, 20 Hz to 50 kHz  
 DC-coupled AM, dc to 50 kHz

**Incidental ØM:** <0.20 radian at 1 kHz rate and 30% AM

**FREQUENCY MODULATION (NOTE 3)**

**FM Display Ranges and Resolution:**

- 0 to 999 Hz Dev, 1 Hz Resolution
- 1 to 9.99 kHz Dev, 10 Hz Resolution
- 10 to 99.9 kHz Dev, 100 Hz Resolution
- 100 to 999 kHz Dev, 1 kHz Resolution
- 1 to 8.00 MHz Dev, 10 kHz Resolution

---

**NOTE 2:** AM specifications apply where (RF output frequency - mod frequency) is greater than 150 kHz.

**NOTE 3:** FM specifications apply where: (RF output frequency - deviation) >150 kHz and RF output frequency - mod rate) >150 kHz.

INTRODUCTION AND SPECIFICATIONS

Table 1-2. Specifications for Model 6082A (cont.)

Maximum Deviation:				
FREQUENCY BAND (MHz)	MAXIMUM DEVIATION			
	DC-COUPLED FM	AC-COUPLED FM (the smaller of)		
		ABSOLUTE MAXIMUM	RATE LIMITED MAXIMUM	
			DEV ≥ 1/64 MAX	DEV < 1/64 MAX
0.01 to 15	500 kHz	500 kHz	fmod x 5000	fmod x 78
15 to 32	125 kHz	125 kHz	fmod x 1250	fmod x 19
32 to 64	250 kHz	250 kHz	fmod x 2500	fmod x 39
64 to 128	500 kHz	500 kHz	fmod x 5000	fmod x 78
128 to 256	1 MHz	1 MHz	fmod x 10000	fmod x 156
256 to 512	2 MHz	2 MHz	fmod x 20000	fmod x 312
512 to 1056	4 MHz	4 MHz	fmod x 40000	fmod x 625
1056 to 2112	8 MHz	8 MHz	fmod x 80000	fmod x 1250

**FM Distortion:**  
**Standard Mode:** <2% for 0.5 to 1.0 times maximum deviation; <1% for <0.5 times maximum deviation. Applies for rates of 50 Hz to 50 kHz.  
**Low-Distortion Mode (Special Function 731):** <0.15% for ≤ 3.5 kHz peak deviation and rates 0.3 to 3 kHz.  
**FM Accuracy:** ±(5% of setting + 10 Hz) for rates of 50 Hz to 50 kHz  
**FM 3-dB Bandwidth:**

DEVIATION	COUPLING	
	INTERNAL AC	EXTERNAL AC (DC)
0% to 25% Maximum	20 Hz to 175 kHz	20 Hz (dc) to 175 kHz
25% to 100% Maximum	20 Hz to 100 kHz	20 Hz (dc) to 100 kHz

**Incidental AM:** <1% depth for peak deviation <100 kHz at 1 kHz rate and carrier frequency >0.5 MHz  
**DC-Coupled FM Center Frequency Error, at 1 GHz, after dcFM internal cal, and without any FM range changes:** <(0.1% of dev + 500 Hz)  
**Low-Rate External AC-Coupled FM (Special Function 711):**

FREQUENCY BAND (MHz)	MAX DEV, IN kHz (AT 10 Hz RATE)	
	SINE WAVE	SQUARE WAVE
0.01 to 15	80	40
15 to 32	20	10
32 to 64	40	20
64 to 128	80	40
128 to 256	160	80
256 to 512	320	160
512 to 1056	640	320
1056 to 2112	1280	640

INTRODUCTION AND SPECIFICATIONS

Table 1-2. Specifications for Model 6082A (cont.)

<p><b>Drop:</b> &lt;30% on a 5 Hz square wave  <b>3-dB Bandwidth:</b> 0.5 Hz to 100 kHz (typical)  <b>Maximum DC Input:</b> ±10 mV  <b>Incidental AM:</b> &lt;1% AM at 1 kHz rate and &lt;10 kHz deviation</p>	
<p><b>PHASE MODULATION (NOTE 4)</b>  <b>Display Ranges:</b> 0 to .999 radians                                    1 to 9.99 radians                                    10 to 99.9 radians                                    100 to 800 radians  <b>Display Resolution:</b> 3 digits  <b>Maximum Deviation:</b></p>	
FREQUENCY BAND (MHz)	MAXIMUM DEVIATION (RADIAN)
0.1 to 15	50
15 to 32	12.5
32 to 64	25
64 to 128	50
128 to 256	100
256 to 512	200
512 to 1056	400
1056 to 2112	800
<p><b>High-Rate Phase Modulation Maximum Deviation (Special Function 721):</b></p>	
FREQUENCY BAND (MHz)	MAXIMUM DEVIATION (RADIAN)
0.1 to 15	5
15 to 32	1.25
32 to 64	2.5
64 to 128	5
128 to 256	10
256 to 512	20
512 to 1056	40
1056 to 2112	80
<p><b>Accuracy:</b> ±(5% of setting + 0.1 radian) at 1-kHz rate  <b>Distortion (NOTE 5):</b> &lt;2% THD from maximum deviation to 1/2 max deviation, and &lt;1% THD at 1/2 maximum deviation or less at 1-kHz rate.  <b>3-dB Bandwidth:</b> AC-coupled phase modulation, 20 Hz to 15 kHz                                    DC-coupled phase modulation, dc to 15 kHz</p>	
<p><b>NOTE 4:</b> Phase modulation specifications are valid where (RF frequency - mod frequency) &gt;150 kHz.  <b>NOTE 5:</b> Valid for rates from 50 Hz to 50 kHz in high-bandwidth mode. Does not include effects of residual phase noise.</p>	

Table 1-2. Specifications for Model 6082A (cont.)

**High-Rate Phase Modulation 3-dB Bandwidth (Special Function 721):**

AC-coupled phase modulation, 20 Hz to 100 kHz

DC-coupled phase modulation, dc to 100 kHz

**Incidental AM (valid for  $f > 500$  kHz):** <1% AM at 1-kHz rate for peak deviation <10 radians.**PULSE MODULATION (For RF Output Frequencies >10 MHz)****On/Off Ratio:** 80 dB minimum**Rise and Fall Times:** <15 ns, 10% to 90%**Level Error:** For pulse widths >50 ns, the power in the pulse is within  $\pm 0.7$  dB of the measured CW level.**Duty Cycle (External Modulation):** 0 to 100%**Repetition Rate (External Modulation):** DC to 10 MHz**Internal Modulation:** Internal rates and widths**External Modulation:** The pulse input is TTL compatible, terminated in  $50\Omega$  with internal active pull-up. It can be modeled as 1.2V in series with  $50\Omega$  at the pulse mod input connector. The instrument senses input terminal voltage and turns the RF OUTPUT off when the terminal voltage drops below  $1\pm 0.1$ V. The maximum allowable input is  $\pm 10$ V.**PULSE MODULATION (For RF Output Frequencies <10 MHz)****Rise and Fall Times:** <2 times the period of the RF output frequency**Level Error:** For pulse widths >10 times the period of the RF output frequency, the power in the pulse is within  $\pm 0.7$  dB of the measured CW level.

Other pulse specifications are the same as for the &gt;10 MHz frequency range.

**NONVOLATILE INSTRUMENT STATE MEMORY**

50 instrument states are retained for typically 2 years, even with ac line power disconnected.

**REVERSE-POWER PROTECTION****Protection Level:** Up to 25 watts from a  $50\Omega$  source; up to 25V dc. RF OUTPUT is ac coupled. Protection is provided when the signal generator is turned off.**Trip/Reset:** A flashing RF OFF annunciator indicates a tripped condition. Pressing RF ON/OFF button resets the signal generator.**IEEE-488 REMOTE CONTROL****Extent of Remote Control:** All controls except the POWER, REF/INT EXT, and CAL/COMP switches are remotely programmable via the IEEE-488 Interface (Std. 488.2-1987). All status including the option complement are available remotely.**Interface Functions Supported:** SH1, AH1, T5, TE0, L3, LE0, SR1, RL1, PP0, DC1, DT1, C0, and E2.**INTERNAL MODULATION SOURCE (Sine Wave)****Rates:** 0.1 Hz to 200 kHz, key-selectable 400/1000 Hz**Display Ranges:** 00.1 to 99.9 Hz

100 to 999 Hz

1.00 to 9.99 kHz

10.0 to 99.9 kHz

100 to 200 kHz

**Frequency Resolution:** 0.1 Hz or 3 digits**Frequency Accuracy:** Same as reference oscillator  $\pm 7$  millihertz

## INTRODUCTION AND SPECIFICATIONS

Table 1-2. Specifications for Model 6082A (cont.)

**Output Level Range:** 0 to 4V pk into 600 $\Omega$

**Output Level Resolution:** 1 mV pk or 3 digits, whichever is greater.

**Distortion:** <0.15% THD for output levels >0.2V pk and modulation frequency <20 kHz.

**Output Level Accuracy:**  $\pm(4\% + 15 \text{ mV})$  for modulation frequency <100 kHz.

**Output Impedance:** 600 $\Omega \pm 2\%$

**Other Waveforms Available by Special Function:**

- Square Wave (Special Function 752)
- Triangle Wave (Special Function 751)
- Pulse (Special Functions 758,759), width 100 ns to 1/F<sub>mod</sub> in 100 ns or 3-digit increments, whichever is greater. Rate and width are coherent with signal generator time base.

### EXTERNAL MODULATION

1V pk provides indicated modulation index. Nominal input impedance is 600 $\Omega$ . Maximum level is  $\pm 5\text{V}$  pk.

### MODULATION MODES

Any combination of AM, PULSE, and FM or  $\emptyset$ M, internal or external, may be used.

### DIGITAL FREQUENCY SWEEP

**Sweep Modes:** Auto, single, or manual

**Adjustable Parameters:** Sweep symmetry, sweep speed, sweep width, and sweep increment.

**Sweep Speed:** Minimum 40 ms/increment selectable as (minimum + dwell time) where dwell time can be 0, 20, 50, 100, 200, or 500 ms, or 1, 2, 5, or 10s at each increment.

### DIGITAL AMPLITUDE SWEEP

**Sweep Type:** Linear (volts) or logarithmic (dB)

**Sweep Modes:** Auto, single, or manual.

**Adjustable Parameters:** Sweep symmetry, sweep speed, sweep width, and sweep increment.

**Sweep Speed:** Minimum 30 ms/increment selectable as (minimum + dwell time) where dwell time can be 0, 20, 50, 100, 200, or 500 ms, or 1, 2, 5, or 10s at each increment.

### SWEEP OUTPUT (AUX Connector Pin 5)

0 to +10V $\pm 10\%$ , up to 4096 points in a stepped ramp, load >2 k $\Omega$ .

### PEN LIFT OUTPUT (AUX Connector Pin 4)

TTL level, high during sweep retrace, load >2 k $\Omega$ .

### GENERAL SPECIFICATIONS

**Temperature:** Operating, 0 to +50 $^{\circ}\text{C}$  (+32 to +122 $^{\circ}\text{F}$ ).

Nonoperating, -40 to +75 $^{\circ}\text{C}$  (-40 to +167 $^{\circ}\text{F}$ ).

**Operating Humidity Range:** 95% to +30 $^{\circ}\text{C}$ , 75% to +40 $^{\circ}\text{C}$ , and 45% to +50 $^{\circ}\text{C}$ .

**Operating Altitude:** Up to 10,000 ft.

**Vibration:** Nonoperating, 5 to 15 Hz at 0.06 in, 15 to 25 Hz at 0.04 in, and 25 to 55 Hz at 0.02 in, double amplitude (DA).

**Shock:** Nonoperating, bench handling per MIL T 28800C Class 5, Style E.

**Electromagnetic Compatibility:** The radiated emissions induce <0.5  $\mu\text{V}$  (at RF carrier frequency) into a 1-inch diameter, 2-turn loop, 1-inch from any surface as measured into a 50 $\Omega$  receiver.



Table 1-2. Specifications for Model 6082A (cont.)

**Complies with Standards:**

- CE03 of MIL-STD-461B (Power and interconnecting leads), 0.015 to 50 MHz.
- RE02 of MIL-STD-461B (14 kHz to 10 GHz).
- FCC Part 15, Class B.
- VDE 0871B
- CISPR 22

<b>Size:</b>	<b>Width</b>	<b>Height</b>	<b>Depth</b>
	43 cm	13.3 cm	59.7 cm
	17 in	5.25 in	23.5 in

**Power Requirements:** 100, 120, 220, or 240V, each  $\pm 10\%$ ; 48-63 Hz; 200 VA, <15 VA in standby, with any options installed.

**Weight:** 30 kg (65 lbs).

**OPTION -130 HIGH-STABILITY REFERENCE**

**Aging Rate:**  $\leq 5 \times 10^{-10}$ /day, after 21 days continuous operation.

**Temperature Stability:**  $\leq 2 \times 10^{-10}/^{\circ}\text{C}$ . (Oven remains powered in standby.)

**OPTION -132 MEDIUM-STABILITY REFERENCE**

**Aging Rate:**  $\leq 1 \times 10^{-7}$ /month after 5 days continuous operation.

**Temperature Stability:**  $\leq 1 \times 10^{-7}$  (0 to  $+50^{\circ}\text{C}$ )

**OPTION -830 REAR PANEL CONNECTORS**

Moves connectors for MODULATION INPUT, MOD output, and RF OUTPUT to the rear panel. The front panel connector locations are covered with plugs.

**SUPPLEMENTAL CHARACTERISTICS**

The following characteristics are provided to assist in signal generator applications, and to describe some other aspects of typical performance.

**Frequency Switching Speed:** <100 ms to settle within 100 Hz

**Amplitude Switching Speed:** <100 ms to settle within 0.1 dB

**Pulse Modulation Delay:** 80 ns typical



## Section 2 Installation

### INTRODUCTION

2-1.

This section provides instructions for unpacking and installing the Signal Generator. Procedures for selecting line voltage, replacing the fuse, rack mounting, and configuration of the Signal Generator for local and remote operation are provided here.

### UNPACKING AND INSPECTION

2-2.

The Signal Generator is shipped in a special protective carton that should prevent damage during shipment. Check the shipping order against the contents of the carton and report any damage or short shipment to the place of purchase or the nearest Fluke Technical Service Center. Instructions for inspection and claims are included on the shipping container. Refer to Section 1 for reshipment instructions.

The shipping container should include the items in Table 2-1. Accessories ordered for the Signal Generator are shipped in a separate container. Table 2-2 lists accessories available for the Signal Generator.

### RACK OR BENCH MOUNTING

2-3.

#### CAUTION

**To prevent overheating, allow at least 3 inches of clearance behind and on each side of the Signal Generator.**

You can place the Signal Generator on a work bench or mount it in a standard (24-inch deep) equipment rack. The outside dimensions of the Signal Generator are shown in Table 1-1.

To mount the Signal Generator in an equipment rack, use the Model Y6080-01 Rack Mount Kit. The rack mount kit contains 5 ¼-inch rack mount ears and 22-inch slides, and comes with an instruction sheet. For optimum cooling airflow, it is recommended that you install a Model Y6080-03 Filler Panel, which occupies 1 ¾ inches of rack space, directly below the Signal Generator. The added airflow space decreases the instrument's operating temperature by approximately 3° C.

### POWER REQUIREMENTS

2-4.

The Signal Generator uses a line voltage of 110/120V ac  $\pm 10\%$ , with a 2.0A fast-blow fuse; or 220/240V ac  $\pm 10\%$ , with a 1.0A fast-blow fuse. The line frequency must be between 48 and 63 Hz. Power consumption of the Signal Generator is less than 200 VA.

# INSTALLATION

Table 2-1. Standard Equipment

ITEM	MODEL OR PART NUMBER
Signal Generator	6080A or 6082A
Line Power Cord	See Table 2-2 and Figure 2-1
6080A/82A Operator Manual	861034
6080A/82A Operator Reference Guide	882154
6080A/82A Remote Programming Reference Guide	882147
6080A/82A Special Functions Decal	860911
6080A Service Manual	868914
or	
6082A Service Manual	881888
Two BNC dust caps	478982

Table 2-2. Line Power Cord Types Available from Fluke

TYPE	VOLTAGE/CURRENT	FLUKE OPTION NUMBER
North America	120V/15A	LC-1
North America	240V/15A	LC-2
Universal Euro	220V/16A	LC-3
United Kingdom	240V/13A	LC-4
Switzerland	220V/10A	LC-5
Australia	240V/10A	LC-6
South Africa	240V/5A	LC-7

## LINE VOLTAGE SELECTION AND FUSE REPLACEMENT

2-5.

### CAUTION

**To prevent instrument damage, verify that the correct fuse is installed for the line voltage setting, and that the line voltage setting is compatible with local line power before plugging in the line cord.**

The Signal Generator arrives from the factory configured for the line voltage normally appropriate for the country of purchase, or as specified at the time of your purchase order. The Signal Generator also comes with the appropriate line power plug for the country of purchase. If you need a different type, refer to Table 2-3 and Figure 2-1. They list and illustrate the line power plug types available from Fluke.

Refer to Figure 2-2 to set the line voltage of the Signal Generator to match the available source. Insert the small pc board in the fuse module so that the appropriate voltage label is towards you. Figure 2-2 also shows how to replace the line fuse. A plate attached to the rear panel shows the correct fuse value for each of the two line voltages.

Table 2-3. Accessories

DESCRIPTION	ACCESSORY NO.
Rack Mount Kit (includes 5 1/4-inch rack mount ears 22-inch rack slides)	Y6080-01
Rack Ear Set	Y6080-02
Rack Filler Panel (for improved cooling airflow, 1 <sup>3</sup> / <sub>4</sub> -inches)	Y6080-03
IEEE-488 Shielded Cable, 1 meter	Y8021
IEEE-488 Shielded Cable, 2 meters	Y8022
IEEE-488 Shielded Cable, 4 meters	Y8023
Coaxial Cable, 50 ohms, 3 feet, BNC (m) both ends	Y9111
Coaxial Cable, 50 ohms, 6 feet, BNC (m) both ends	Y9112

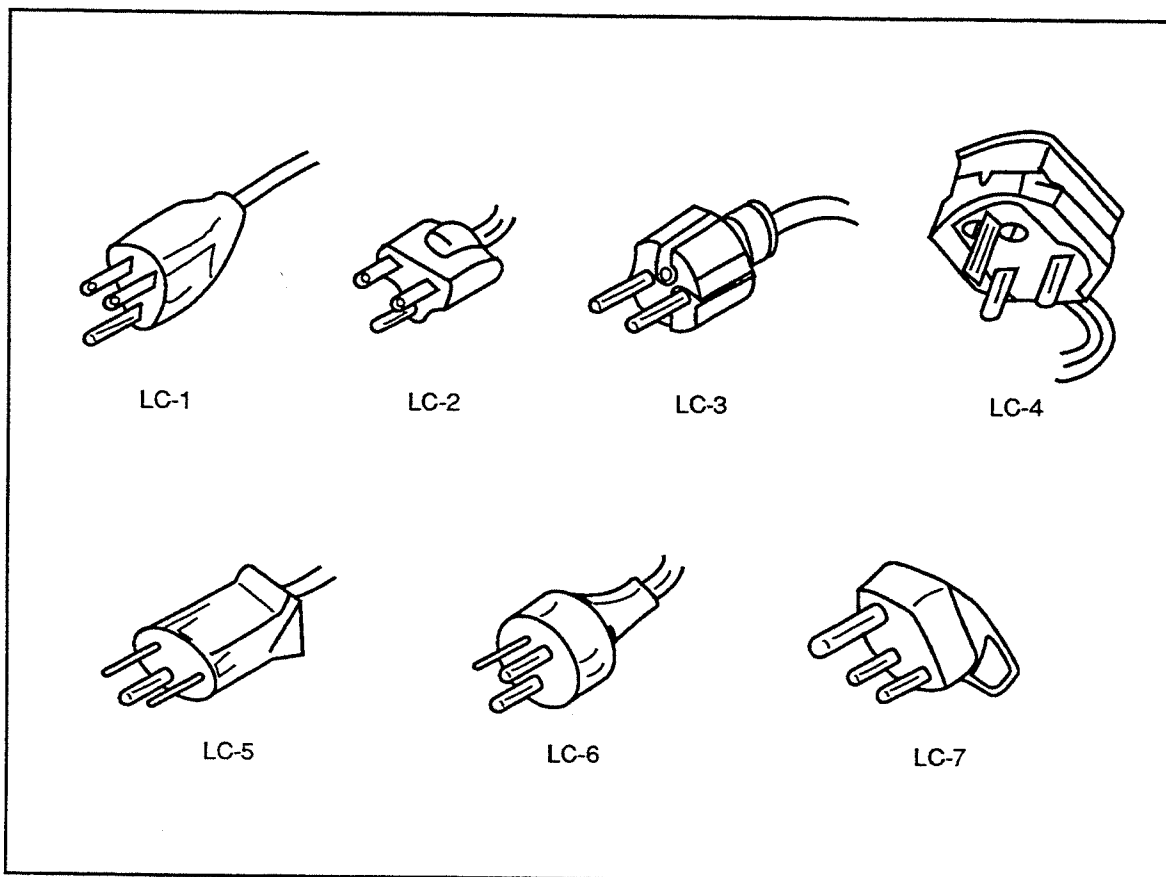

Figure 2-1. Line Power Cords Available from Fluke

## INSTALLATION

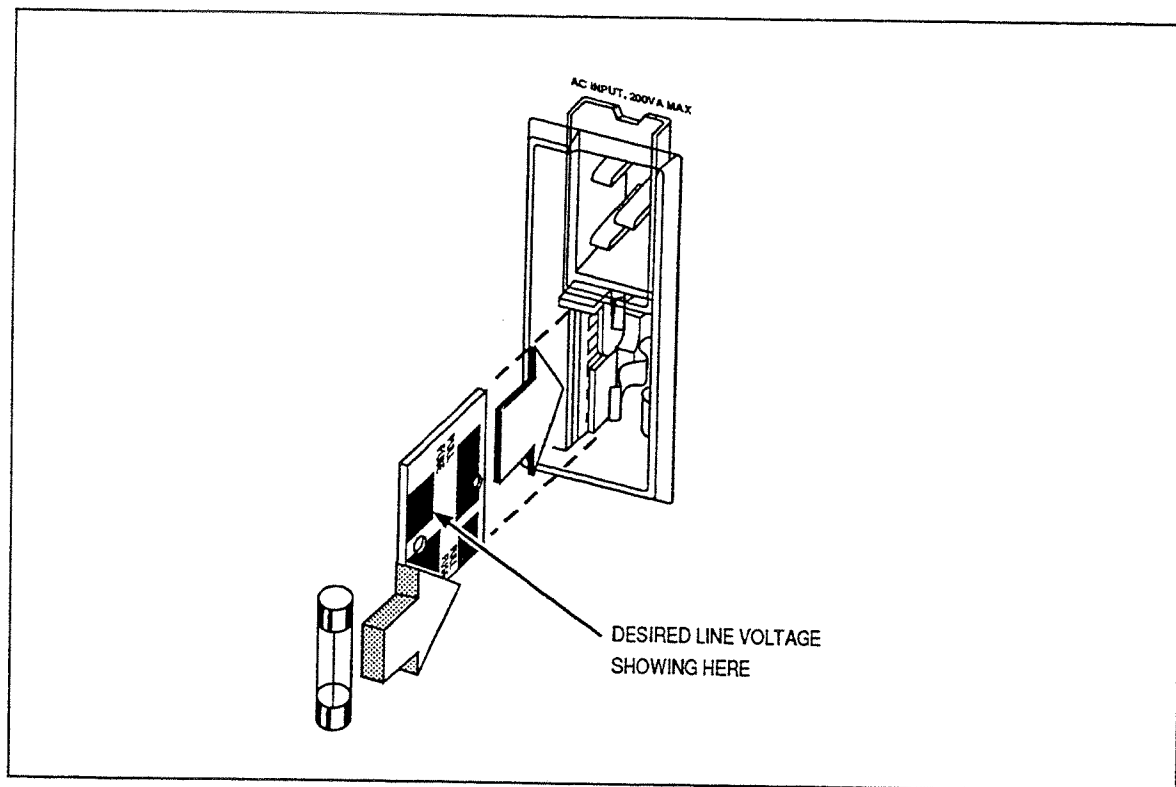

Figure 2-2. Fuse/Line Voltage Selection Assembly

### CONNECTING TO LINE POWER

2-6.

#### WARNING

**TO AVOID SHOCK HAZARD, CONNECT THE FACTORY SUPPLIED THREE-CONDUCTOR LINE POWER CORD TO A PROPERLY GROUNDED POWER OUTLET. DO NOT USE A TWO-CONDUCTOR ADAPTER OR EXTENSION CORD; THIS WILL BREAK THE PROTECTIVE GROUND CONNECTION.**

After you verify that the line voltage selection pc board is in the correct position, verify that the correct fuse for that line voltage is installed. Connect the Signal Generator to a properly grounded three-prong outlet.

### INTERNAL/EXTERNAL FREQUENCY REFERENCE

2-7.

The Signal Generator normally operates with an internal reference oscillator. However, if desired, the Signal Generator can be operated with an external reference by setting the rear panel REF INT/EXT switch to EXT and connecting the external reference to the REF IN connector.

#### NOTE

*When the Signal Generator is operating on internal reference, a 10-MHz Signal is present at the 10 MHz OUT connector. To meet the specified radiated emissions, this connector must be terminated with a BNC non-shorting dust cap. A dust cap, PN 478982, is supplied with the signal Generator. If a cable is connected, it must be a double-shielded coaxial cable such as RG-223 terminated in a 50-ohm load.*

**NOTE**

*Do not operate the Signal Generator on internal reference with an external reference signal applied. This causes output spectral degradation.*

**LOCAL AND REMOTE OPERATION****2-8.**

The Signal Generator output is controlled by either local (front panel) operation or remote operation. In the local operation mode, controls on the front panel are used to control the Signal Generator. In Remote, an IEEE-488 controller controls the Signal Generator by sending programming commands over the IEEE-488 Interface. Section 5 provides instructions for remote operation.

**NOTE**

*To meet the specified radiated emissions, a shielded IEEE-488 cable, such as a Fluke Y8021 must be used.*

**POWER-ON SEQUENCE****2-9.**

When the Signal Generator is turned on, a power-on sequence starts. During the power-on sequence, the microprocessor tests the front panel display, the analog circuitry, the instrument RAM, and the nonvolatile memory containing compensation and calibration data. A front panel display test lights all segments for a brief period while the rest of the self-tests take place. After successful completion of the self tests, the Signal Generator is in the preset state, as defined in Appendix A. The instrument settings in effect when the Signal Generator was turned off can be recalled by pressing

.

If any of the self-tests fail, the Signal Generator displays one or more status codes. Any front panel entry that occurs before the power-on sequence is completed aborts the self-test, and sets the Signal Generator to the preset state. The power-on self-tests are explained in detail in the Service Manual.





## **Section 3 Features**

### **INTRODUCTION** **3-1.**

Section 3 is a reference for the functions and locations of the front panel and rear panel features of the Signal Generator. Please read this information before operating the Signal Generator. Front panel operating instructions are provided in Section 4, and remote operating instructions are provided in Section 5.

### **FRONT PANEL FEATURES** **3-2.**

Figure 3-1 shows the front panel. Table 3-1 describes the front panel features.

### **REAR PANEL FEATURES** **3-3.**

Figure 3-2 shows the rear panel. Table 3-3 describes the rear panel features.

# FEATURES

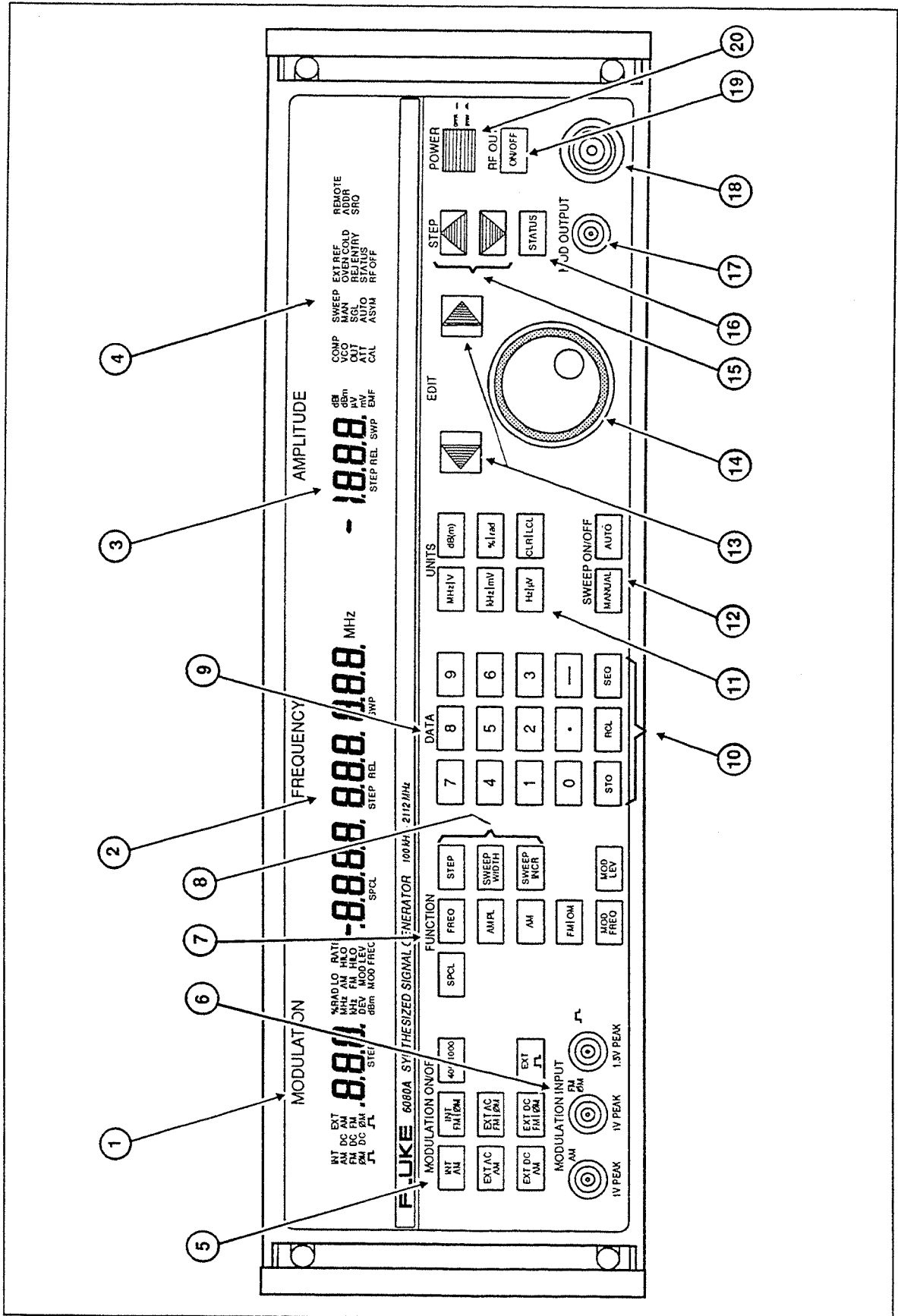



Figure 3-1. Front Panel Features

Table 3-1. Front Panel Features

<p>①</p> <p><b>MODULATION DISPLAY FIELD</b></p>	<p>A three-digit display, with associated annunciators, used to display the AM depth, FM/ØM deviation, source of modulation signal, modulation frequency and modulation level. It is also used to display active error codes and status codes.</p>
<p>INT AM</p>	<p>Indicates that the internal modulation oscillator signal is amplitude modulating the output.</p>
<p>INT FM</p>	<p>Indicates that the internal modulation oscillator signal is frequency modulating the output.</p>
<p>INT ØM</p>	<p>Indicates that the internal modulation oscillator signal is phase modulating the output.</p>
<p>INT </p>	<p>Indicates that the internal modulation oscillator signal is pulse modulating the output.</p>
<p>EXT AC</p>	<p>Indicates that the ac-coupled signal at the AM MODULATION INPUT connector is amplitude modulating the output.</p>
<p>EXT DC AM</p>	<p>Indicates that the dc-coupled signal at the AM MODULATION INPUT connector is amplitude modulating the output.</p>
<p>EXT DC FM</p>	<p>Indicates that the dc-coupled signal at the FM/ØM MODULATION INPUT connector is frequency modulating the output.</p>
<p>EXT FM</p>	<p>Indicates that the ac-coupled signal at the FM/ØM MODULATION INPUT connector is frequency modulating the output.</p>
<p>EXT ØM</p>	<p>Indicates that the ac-coupled signal at the FM/ØM MODULATION INPUT connector is phase modulating the output.</p>
<p>EXT DC ØM</p>	<p>Indicates that the dc-coupled signal at the FM/ØM MODULATION INPUT connector is phase modulating the output.</p>
<p>EXT </p>	<p>Indicates that the dc-coupled signal at the FM/ØM MODULATION INPUT connector is pulse modulating the output.</p>
<p>STEP</p>	<p>Indicates that the Step Size Entry, and Step Increment and Decrement keys affect the displayed modulation parameter.</p>
<p>%</p>	<p>Indicates that the value displayed is the AM depth in percent.</p>
<p>MHz kHz DEV</p>	<p>Indicates that the value displayed is the FM deviation in MHz, kHz, or Hz.</p>
<p>rad</p>	<p>Indicates that the value displayed is the Phase Modulation Deviation in radians.</p>
<p>dBm</p>	<p>Indicates that the value displayed is the target level in dBm when performing a level calibration/compensation procedure.</p>

## FEATURES

**Table 3-1. Front Panel Features (cont)**

LO RATE	Indicates that the Signal Generator is in low-rate FM modulation mode.
AM HI	Indicates that the external ac-coupled AM modulation signal is more than 2% above the nominal 1V pk input requirement.
AM LO	Indicates that the external ac-coupled AM modulation signal is more than 2% below the nominal 1V pk input requirement.
FM HI	Indicates that the external ac-coupled FM modulation signal is more than 2% above the nominal 1V pk input requirement.
FM LO	Indicates that the external ac-coupled FM modulation signal is more than 2% below the nominal 1V pk input requirement.
V MOD LEV	Indicates that the value displayed is the peak modulation output Level in volts.
Hz kHz MOD FREQ	Indicates that the value displayed is the modulation frequency in Hz or kHz.
② <b>FREQUENCY DISPLAY FIELD</b>	A signed 10-digit display with four annunciators that displays RF output frequency parameters of the Signal Generator. It is also used to display Special Function codes, status codes, or stored/recalled memory location codes.
STEP	Indicates that the Step Size Entry and the Step Increment and Decrement keys affect the RF frequency.
REL	Indicates that the displayed frequency is relative to a reference frequency.
SPCL	Indicates certain Special Functions are enabled that are not otherwise annunciated. Pressing the <input type="button" value="SPCL"/> key causes the enabled Special Function codes to be displayed.
SWP	Indicates that the SWEEP ON/OFF keys apply to frequency sweep.
③ <b>AMPLITUDE DISPLAY FIELD</b>	A signed 3 1/2-digit display with eight annunciators that displays RF output amplitude parameters and status codes. Except when EMF units are selected, displayed amplitudes are referenced to a 50Ω load.
STEP	Indicates that the Step Size Entry and the Step Increment and Decrement keys affect the RF output amplitude.
REL	Indicates that the displayed amplitude is relative to a reference amplitude.
SWP	Indicates that the SWEEP ON/OFF keys apply to amplitude sweep.

Table 3-1. Front Panel Features (cont)

	dBf	Indicates that the displayed amplitude is in decibels relative to one femtowatt.
	dB	Indicates that the displayed amplitude is in decibels relative to a reference amplitude, or is a step size value, a sweep increment value, or a sweep width value.
	dBm	Indicates that the displayed amplitude is in decibels relative to one milliwatt.
	V $\mu$ V mV	Indicates that the displayed amplitude is in volts, microvolts, or millivolts.
	dB mV	Indicates that the displayed amplitude is in decibels relative to one millivolt.
	dB $\mu$ V	Indicates that the displayed amplitude is in decibels relative to one microvolt.
	EMF	Indicates that the displayed amplitude is in EMF units, delivered into an open circuit or unterminated output. Toggled by Special Function 851/850.
④	<b>STATUS DISPLAY ANNUNCIATORS</b>	The status display field is composed of 17 annunciators and a yellow LED, all of which denote the status of the Signal Generator.
	COMP	Indicates that a compensation procedure is in progress. Flashes when the rear panel CAL COMP switch is set to 1 (ON).
	VCO	Indicates that a coarse loop, sum loop, or subsynthesizer compensation procedure is in progress.
	OUT	Indicates that an output compensation procedure is in progress.
	ATT	Indicates that an attenuator compensation procedure is in progress.
	CAL	Indicates that a calibration procedure is in progress. Flashes when the rear panel CAL COMP switch is set to 1 (ON).
	SWEEP	Indicates that a sweep is active.
	MAN	Indicates that manual sweep mode is active.
	SGL	Indicates that single sweep mode is active.
	AUTO	Indicates that auto sweep mode is active.

**Table 3-1. Front Panel Features (cont)**









ASYM	Indicates that the Signal Generator is configured to sweep in asymmetric mode.
EXT REF	Indicates that the rear panel REF switch is in the EXT (external) position.
OVEN COLD	Indicates ovened timebase oscillator has not stabilized.
REJ ENTRY	Flashes when an invalid entry is made.
STATUS	Indicates when the Signal Generator is operating outside its specified range. Flashes when a hardware-limited or a hardware fault condition is detected.
RF OFF	Indicates that the RF OUTPUT is disabled. Flashes when the RPP has been tripped.
REMOTE	Indicates that the Signal Generator is in the remote (IEEE-488 Interface) mode of operation.
ADDR	Indicates that the Signal Generator is addressed to listen or talk on the IEEE-488 interface Bus.
SRQ	Indicates that the Signal Generator has asserted the IEEE-488 SRQ signal.
Yellow LED	When lit, indicates that the Signal Generator is in the standby state and is connected to the power mains. The LED is off when the Signal Generator is operating.
<b>5</b>	<b>MODULATION ON/OFF KEYS</b>
	Used to select type and source of modulation. With the exception of the <b>400/1000</b> key, these keys operate as independent push-on/push-off switches for the given modulation.
	Enables internal amplitude modulation.
	Enables external ac-coupled amplitude modulation using the signal applied to the AM MODULATION INPUT connector.
	Enables external dc-coupled amplitude modulation using the signal applied to the AM MODULATION INPUT connector.
	Enables internal frequency or phase modulation.
	Enables external ac-coupled frequency or phase modulation using the signal applied to the FM/øM MODULATION INPUT connector.
	Enables external dc frequency or phase modulation using the signal applied to the FM/øM MODULATION INPUT connector.
	Toggles the internal modulation oscillator frequency between 400 and 1000 Hz. Used as an alternative to the  key and data input.

Table 3-1. Front Panel Features (cont)





















	<p>Enables external pulse modulation using the signal applied to the  MODULATION INPUT connector.</p>
<p>6</p>	<p><b>MODULATION INPUT CONNECTORS</b></p>
<p>AM</p>	<p>A BNC connector for input of a 1V pk external AM modulation signal.</p>
<p>FM/ØM</p>	<p>A BNC connector for input of a 1V pk external FM/ØM modulation signal.</p>
	<p>A BNC connector for input of a 1.5V pk external pulse modulation signal.</p>
<p>7</p>	<p><b>FUNCTION KEYS</b></p>
<p>SPCL</p>	<p>Enables the Special Function mode. Special functions are enabled and disabled by using the DATA keys to enter a two-or-three digit numeric code. Refer to Section 4F, "Special Functions" for a detailed description and a list of the special functions.</p>
<p>FREQ</p>	<p>Selects the RF output frequency parameter to be programmed.</p>
<p>AMPL</p>	<p>Selects the RF output amplitude parameter to be programmed.</p>
<p>AM</p>	<p>Selects the amplitude modulation depth parameter to be programmed.</p>
<p>FM/ØM</p>	<p>Selects the frequency or phase modulation deviation parameter to be programmed.</p>
<p>MOD FREQ</p>	<p>Selects the modulation frequency parameter to be programmed.</p>
<p>MOD LEV</p>	<p>Selects the modulation level parameter to be programmed.</p>
<p>8</p>	<p><b>FUNCTION MODIFIER KEYS</b></p>
<p>STEP</p>	<p>After selecting one of the six functions, pressing this key displays the step size for the parameter and allows a new step size to be entered. The STEP  or  (increase or decrease) keys are enabled for the selected parameter.</p>
<p>SWEEP WIDTH</p>	<p>After the frequency or amplitude function has been selected, pressing this key displays the sweep width for the function and allows a new sweep width to be entered. The SWEEP mode keys are enabled for the selected function.</p>

Table 3-1. Front Panel Features (cont)

SWEEP INCR	<p>After the frequency or amplitude function has been selected, pressing this key displays the sweep increment for the function and allows a new sweep increment to be entered. The SWEEP mode keys are enabled for the selected function.</p>
9	<p><b>DATA</b></p> <p>A 10-digit (plus sign and decimal key) keypad used for entering a parameter value, a Special Function code, or an Instrument State Memory recall/store location.</p>
10	<p><b>INSTRUMENT STATE MEMORY OPERATION KEYS</b></p>
STO	<p>Used with the DATA keys to store the current instrument state in a memory location. Memory locations 01 through 50 are available. You can store a single function parameter when you use one of these keys with any of the six FUNCTION keys.</p>
RCL	<p>Used with the DATA keys to recall an instrument state from a memory location. Memory locations 01 through 50 are available for storage of instrument states. (Location 00 retains the instrument state in effect when the power is turned off and location 98 contains the Instrument Preset State described in Appendix A.) You can recall a single function parameter when you use one of these keys with any of the six FUNCTION keys.</p>
SEQ	<p>Sequentially recalls, in increasing location order, the instrument state stored in memory. While the SEQ key is pressed, successive memory locations are displayed. When the key is released, the location last displayed is recalled. Pressing RCL followed by — sequentially recalls, in decreasing order, the stored instrument states.</p>
11	<p><b>UNITS KEYS</b></p> <p>These keys, with the exception of CLR LCL, terminate entry of a function parameter. You can also use these keys to convert displayed amplitude or FM/ØM units.</p>
MHz V	<p>Used with the FREQ, FM ØM, and MOD FREQ function keys to specify units of megahertz. Used with the AMPL and MOD LEV function keys to specify units of volts. You also use this key with the Pulse Width Entry Special Function to specify units of microseconds.</p>
kHz mV	<p>Used with the FREQ, FM ØM, and MOD FREQ function keys to specify units of kilohertz. You also use this key with the AMPL and MOD LEV function keys to specify units of millivolts, and with the Pulse Width entry Special Function to specify units of milliseconds.</p>
Hz µV	<p>Used with the FREQ, FM ØM, and MOD FREQ function keys to specify units of hertz. Used with the AMPL and MOD LEV function keys to program the parameter data in units of microvolts. Used with the Pulse Width entry Special Function to program the parameter data in units of seconds.</p>



Table 3-1. Front Panel Features (cont)

	Used with the  function key to program the parameter data in terms of decibels relative to one milliwatt or to an alternate reference if selected by Special Function. You also use this key in relative amplitude mode or with the   or  function modifier keys to specify units of decibels ratio.
	Used with the  function key to program the parameter data in units of percentage of AM depth. You also use this key with the  function key to specify units of radians of ØM deviation.
	When the Signal Generator is in local operation, this key clears an entry and returns the Signal Generator to the last valid state. When the Signal Generator is in remote operation, this key returns local control.
<b>12</b> SWEEP ON/OFF KEYS	These keys enable or disable a sweep mode. The keys operate as independent push-on and push-off switches for the given sweep mode.
	Enable or disable manual sweep mode. The edit knob is used to move up or down within the sweep range for the selected sweep function.
	Enable or disable auto sweep mode. The Signal Generator repetitively progresses through the sweep range for the selected sweep function.
<b>13</b> EDIT KEYS	These keys position the bright digit within a display field. Both keys repeat while they are pressed.
	Moves the bright digit one digit to the left in the active display field.
	Moves the bright digit one digit to the right in the active display field.
<b>14</b> EDIT KNOB	Used to increase or decrease the value of the bright digit. You move the bright digit to the desired display field by pressing the one of the FUNCTION keys.
<b>15</b> STEP KEYS	These two keys work in conjunction with the  Function Modifier key. Both keys repeat while held down.
	Increments the function parameter for the field that has has STEP annunciator lit, by the programmed step size.
	Decrements the function parameter for the field that has has STEP annunciator lit, by the programmed step size.
<b>16</b> STATUS KEY	Used to display a Rejected Entry (REJ ENTRY annunciator flashing) or Status codes in the display fields.
<b>17</b> MOD OUTPUT CONNECTOR	A BNC connector for output of the internal modulation oscillator signal.

## FEATURES

**Table 3-1. Front Panel Features (cont)**

18	<b>RF OUTPUT CONNECTOR</b>	A Type "N" connector that supplies the Signal Generator RF output signal.
19	<b>RF OUTPUT KEY</b>	A push-on/push-off key (with a corresponding RF OFF ON/OFF annunciator in the STATUS display field) that enables and disables the RF output of the Signal Generator.
20	<b>POWER SWITCH</b>	A push-on/push-to-standby detent switch that enables line power to the Signal Generator or enables standby power.

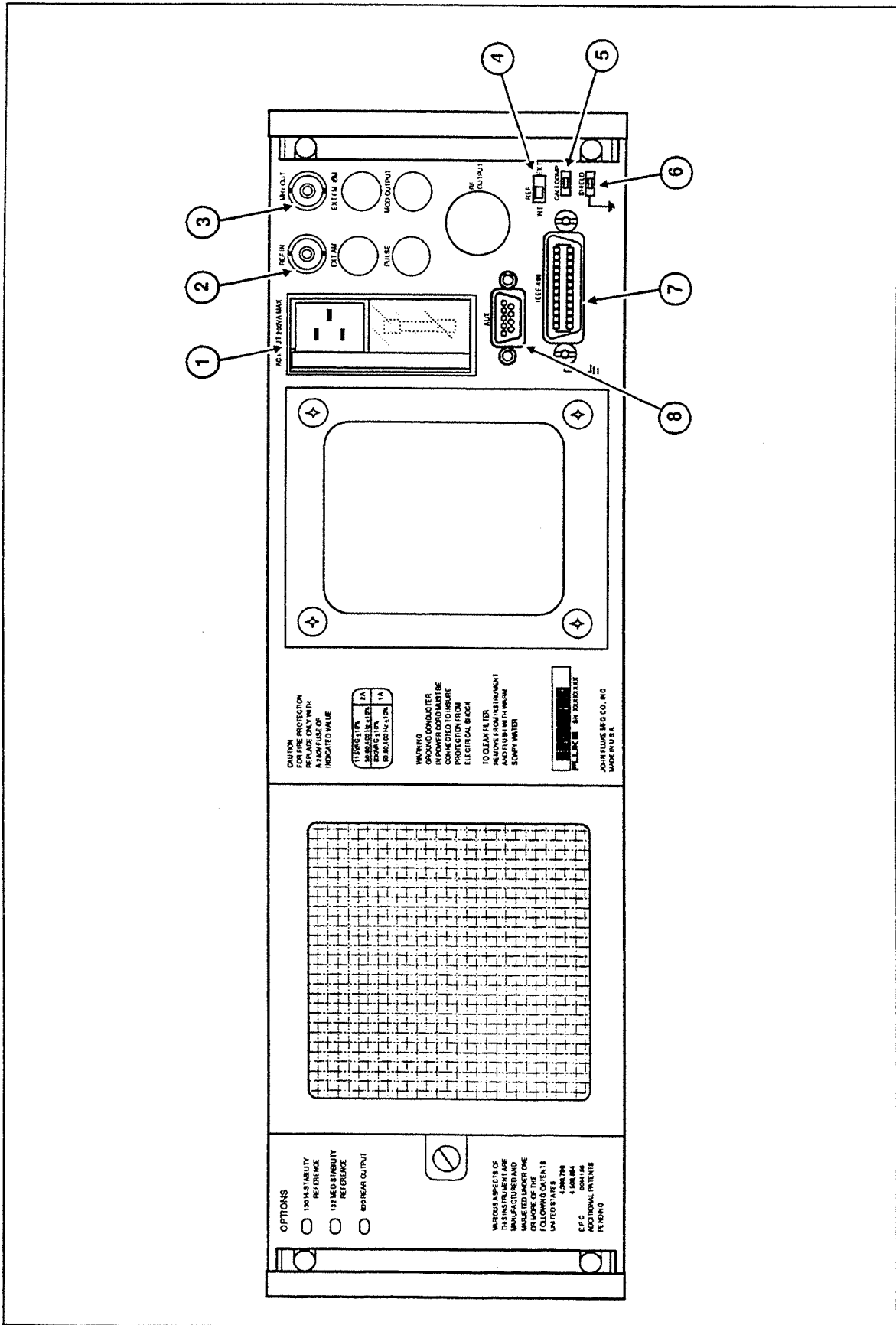

Figure 3-2. Rear Panel Features

Table 3-2. Rear Panel Features

①	<b>AC INPUT MODULE</b>	Permits operation from 115V or 230V. The number visible through the window on the selector card indicates the nominal line voltage to which the Signal Generator must be connected. The line voltage is selected by orienting the selector card appropriately. A 2-ampere fuse is required for 115V operation and a 1-ampere fuse is required for 230V operation.
②	<b>REF IN CONNECTOR</b>	A BNC connector that accepts a 1 MHz, 2 MHz, 5 MHz, or 10 MHz, 0.2 to 2V rms sine or square wave signal into a nominal 50Ω termination. This becomes the Signal Generator reference signal when the REF INT/EXT switch is set to EXT.
③	<b>10 MHz OUT CONNECTOR</b>	A BNC connector that presents a 10 MHz reference signal, greater than 0 dBm for a 50Ω load, to external devices.
④	<b>REF INT/EXT SWITCH</b>	This switch selects the Signal Generator frequency reference. When set to INT, the Signal Generator operates on the 10-MHz internal reference. The internal 10 MHz reference signal is available at the 10-MHz OUT connector. When set to EXT, the Signal Generator reference is a 1, 2, 5 or 10-MHz signal applied to the external REF IN connector.
⑤	<b>CALCOMP SWITCH</b>	When set to 1, enables the Signal Generator to run closed-case calibration and compensation procedures. When set to 0, it write-protects calibration and compensation data memory.
⑥	<b>Shield ⊥ SWITCH</b>	This switch connects the shield of the IEEE-488 connector and cable to the instrument ground.
⑦	<b>IEEE-488 CONNECTOR</b>	Allows remote operation of the Signal Generator via the IEEE-488 bus.
⑧	<b>AUX CONNECTOR</b>	A 9-pin D-Subminiature connector for sweep z-axis blanking/penlift (pin 4), and sweep DAC (x-axis) signals (pin 5). It is also for remote control of bright digit and memory sequence up and down operations. See Appendix F for the pinout diagram.

# Section 4

## Front Panel Operation

### INTRODUCTION

4-1.

Section 4 provides instructions for operating the Signal Generator using the front panel controls. The front panel features are described in Section 3.

Each of Sections 4A through 4G describes procedures that are specific to one area of Signal Generator operation. Included with instructions for a particular operation are the equivalent remote (IEEE-488 bus) commands. This is intended to help the remote programmer who needs to refer to the operating instructions while writing a remote program. Refer to Section 5 for complete information about programming the Signal Generator via the IEEE-488 bus.

### RECALLING PREVIOUS INSTRUMENT SETTINGS AT POWER-UP

4-2.

Every time you toggle the power off and on, the Signal Generator is reset to the Preset State, as listed in Appendix A. However, the settings that were in effect when the power was turned off are saved in non-volatile memory as instrument state memory location 00. To recall the previous settings, including programmed step sizes, active modes, etc., press   .

For more information about storing and recalling up to 50 different sets of instrument states, refer to Section 4D. For more information about the Preset State and other factory default tables, refer to Appendix A.

### ENTERING AND MODIFYING PARAMETERS

4-3.

The six primary parameters of the Signal Generator correspond to the six Function Keys, as follows:

- (RF output frequency)
- (RF output amplitude)
- (AM depth)
- (FM/φM deviation)
- (Modulation frequency)
- (Modulation level)

The value of each can be individually set or modified by any of three methods:

- Entering parameters directly
- Editing the bright digit
- Incrementing and decrementing by step

Each of these methods accomplishes the same result, but each method is particularly suited for a specific application. For example, you can establish an initial parameter value by entering it directly, then adjust that parameter with by editing the bright digit or incrementing (or decrementing) it by step.

### Entering Parameters Directly

4-4.

To enter a parameter directly, proceed as follows:

1. Select a function.

Select one of the six functions by pressing a FUNCTION key. The bright digit appears in the corresponding display field. The presence of the bright digit in the display field indicates that the parameter for the selected function is ready to be entered or modified.

2. Enter the numeric data.

Enter the numeric data using the DATA keys. The numbers appear in the selected display field. The bright digit is off when numeric data is being entered.

3. Enter a unit.

Press a UNITS key. This gives the numeric data its absolute value and causes the microprocessor to verify that the entered value is within allowable limits and to program the Signal Generator to the new state. The bright digit is redisplayed.

A function remains selected until you press a new FUNCTION key (or send a function remote command). Parameter data for a selected function must be followed by a unit value and must be within the allowable range for the function. If the data is not within the allowable range, the display field flashes, and the REJ ENTRY status annunciator flashes. A rejected entry does not affect the output of the Signal Generator. The output of the Signal Generator remains at its previous setting until a new value is accepted.

You can terminate entry of a function parameter at any time by pressing  or by selecting another function.

Parameter entry commands are provided for remote control of the six functions. Refer to Section 5, "Remote Operation" for more information.

### Editing the Bright Digit

4-5.

To adjust the value of a parameter by editing the bright digit, proceed as follows:

1. Select a display field.

Select one of the six functions using the FUNCTION keys. A bright digit appears in the selected display field.

2. Position the bright digit.

Use the  or  EDIT keys to position the bright digit on the desired decade of resolution.

3. Adjust the value of the bright digit.

Turn the knob clockwise to increment the bright digit. Turn the knob counterclockwise to decrement the bright digit.

The position of the bright digit within a display field is retained when the bright digit is moved from one display field to another and back to the original field. Note that each function sharing the MODULATION display field (AM Depth, FM/ $\phi$ M Deviation, Modulation Frequency and Modulation Level) retains its own bright digit position.

The bright digit is turned off while Manual Sweep is active. Refer to Section 4E for more information about the sweep function.

An edit operation is ignored when the result would cause the value of the edited parameter to exceed its programmable limit.

Bright digit positioning and editing commands are also provided for remote operation for each of the six functions. Refer to Section 5 for more information.

### Incrementing and Decrementing by Step

4-6.



You can change the value of a parameter in increments of a programmable step size by pressing the  or  STEP keys. The step size for a given function remains in effect until a new step size is selected, even after power is turned off. If you do not initially change the step sizes, the defaults shown in Table 4-1 are in effect.

Table 4-1. Step Size Defaults

PARAMETER	DEFAULT STEP SIZE
Frequency	10 MHz
Amplitude	10 dB
AM Depth	10%
FM/ $\phi$ M Deviation	1 kHz
Modulation Frequency	1 kHz
Modulation Level	0.1V

To change the magnitude of a step size, proceed as follows:

1. Select the step field.

Select the field for which you would like to change the step by pressing a FUNCTION key, followed by the  key to enable the step size entry.



2. Enter data for step size.



Select the numeric step size using the DATA keys.

3. Select the units.

Select a UNIT key to give the data its absolute value.

## FRONT PANEL OPERATION

While the  key is pressed, the display field of the selected parameter shows the step size. The STEP annunciator is lit in the display field affected by the  key.

The repeat rate of the  or  STEP keys may be changed to a faster or slower rate (a medium repeat rate is the default) with a Special Function. Refer to Section 4F for more information about the Special Functions.

A step increment or decrement is ignored when the result of that step would cause the value of the stepped parameter to exceed its programmable limit.

Step entry and step up/down commands are also provided for remote operation for each of the six functions. Refer to Section 5 for more information.



# Section 4A

## RF Output Frequency

### INTRODUCTION

4A-1.

Section 4A describes the procedures for setting the RF output frequency and the associated parameters of RF output frequency.

### SETTING RF OUTPUT FREQUENCY

4A-2.

Set the RF output frequency by pressing **FREQ**, the necessary DATA keys, and a UNITS key. The RF output frequency is displayed in fixed-point notation in MHz. Pressing **FREQ** key moves the bright digit to the FREQUENCY display field and places the Signal Generator in the RF output frequency entry mode.

	RF FREQUENCY	
	RANGE	RESOLUTION
6080A	0.01 to 1056	1 Hz
6082A	0.1 to 2112 MHz	1 Hz

SYNTAX:

**FREQ** --Numeric Data-- **MHz|V**  
**kHz|mV**  
**Hz| $\mu$ V**

EXAMPLE: Set RF Frequency to 10.7 MHz

FRONT PANEL: **FREQ** **1** **0** **.** **7** **MHz|V**

REMOTE: FREQ 10.7 MHZ

## SETTING RF OUTPUT FREQUENCY STEP SIZE

4A-3.

You can change the magnitude of the RF output frequency by programmable step using the  $\triangle$  and  $\nabla$  keys. The default step size is 10 MHz. View the current set step size by holding down **STEP**, the step size shows on the display. To change this step size and save your change in non-volatile memory, proceed as follows:

1. Press **FREQ** followed by **STEP**.
2. Enter the data for step size using the DATA keys.
3. Press **MHz|V** or **kHz|mV** to give the data its absolute value. The value you have selected is held momentarily in the FREQUENCY display field.

RF FREQUENCY		
	RANGE	RESOLUTION
6080A	0.01 to 1056 MHz	1 Hz
6082A	0.1 to 2112 MHz	1 Hz

SYNTAX:

**FREQ** **STEP** -- Numeric Data--  
**MHz|V**  
**kHz|mV**  
**Hz| $\mu$ V**

EXAMPLE: Set RF Frequency Step Size to 103 kHz

FRONT PANEL: **FREQ** **STEP** **1** **0** **3** **kHz|mV**

REMOTE: **FREQ\_STEP** 103 KHZ

## USING RF OUTPUT FREQUENCY RELATIVE MODE

4A-4.

The RF output frequency relative mode is useful for establishing a reference frequency and then changing the output relative to that reference. Setting a reference is done by programming the RF output frequency to the desired value, and then enabling the relative mode using a Special Function command from the front panel, or with the **FREQ\_REL** command in remote. This lights the REL annunciator in the FREQUENCY display field, and sets the displayed frequency value to zero. The Signal Generator output does not change during this operation. In relative frequency mode, you can modify parameters as usual: by direct entry, by editing the bright digit, or by increment/decrementing by step.

In relative frequency mode, the RF output frequency is the sum of the reference and the displayed frequency. You can display the RF output frequency by pressing the **FREQ** key. In remote, query the output frequency with the **FREQ\_ABS?** command, and query the reference frequency with the **FREQ\_BASE?** command.

Relative mode may not be enabled or disabled while sweep is active. See Section 4E, "Sweep" for more information.

SYNTAX:

	FRONT PANEL	REMOTE
Turn Relative Frequency Off	<input type="button" value="SPCL"/> <input type="button" value="2"/> <input type="button" value="0"/>	FREQ_REL OFF
Turn Relative Frequency On	<input type="button" value="SPCL"/> <input type="button" value="2"/> <input type="button" value="1"/>	FREQ_REL ON

**ADJUSTING THE PHASE OF THE RF CARRIER**

**4A-5.**

The phase of the RF output carrier can be adjusted relative to another phase coherent signal source using the front panel edit controls. For example, two 6080As or 6082As can be made phase coherent by driving the REF IN on one unit with the 10 MHz OUT from the other unit. The unit receiving the external reference must be set to EXT REF on the rear panel.

Entering     initiates the carrier phase adjust mode. The message "PHASE" is displayed in the FREQUENCY display field and the initial phase adjustment of zero degrees is displayed in the AMPLITUDE display field. Turn the edit knob to advance/retard the phase in 1 degree or 10 degree increments. The edit  and  keys change the resolution of the bright digit.

The Signal Generator does not measure the phase of the other signal source so it cannot display the absolute phase relationship between the two signals. The display shows the relative phase adjustment applied to the rf output. Pressing the  key sets the relative phase adjustment to zero establishing a reference. Press any other key to exit the carrier phase adjust mode.

The relative phase adjustment may also be zeroed by entering     while outside of the carrier phase adjust mode.

The remote command PHASE adjusts the carrier phase by the specified number of degrees. The relative phase adjustment is updated internally, but is not displayed when the remote commands are received. The command PHASE? queries the relative phase adjustment. The command "PHASE\_ZERO" zeros the relative phase adjustment.

The display is momentarily blanked during a phase adjustment.

**USING AN EXTERNAL FREQUENCY REFERENCE**

**4A-6.**

The Signal Generator normally derives its output frequency based on a 10-MHz internal reference oscillator. However, if you desire, you can substitute an external source for the internal reference. To use an external reference, set the rear panel REF INT/EXT switch to EXT and connect an external source of 10 MHz  $\pm$ 10 ppm sine wave, 0.2 to 2.0V rms, to the rear panel REF IN connector.

You can also use an external reference of 1, 2, or 5 MHz. One alternate external reference frequency setting is available at a time, through Special Function 761. (Special Function 760 resets the Signal Generator for a 10-MHz external reference.) The default alternate reference frequency is 5 MHz. See "Selecting an Alternate Reference Frequency" in the Service Manual for how to set internal DIP switches for a 1 or 2 MHz external reference.

In remote, use the EXTREF\_FREQ command. The selected external reference frequency is in effect whenever the rear panel REF INT/EXT switch is set to EXT.

**FRONT PANEL OPERATION**  
**RF OUTPUT FREQUENCY**

SYNTAX:

	FRONT PANEL	REMOTE
Select Standard (10MHz) External Reference Frequency	<input type="checkbox"/> SPCL <input type="checkbox"/> 7 <input type="checkbox"/> 6 <input type="checkbox"/> 0	EXTREF_FREQ STD
Select Alternate External Reference Frequency	<input type="checkbox"/> SPCL <input type="checkbox"/> 7 <input type="checkbox"/> 6 <input type="checkbox"/> 1	EXTREF_FREQ ALT

**RF OUTPUT FREQUENCY BANDS**

**4A-7.**

All RF output frequencies are synthesized from a fundamental frequency in the range of 480 to 1056 MHz. This fundamental frequency is divided, heterodyned, or doubled to produce the programmed output frequency. The frequency bands of the Signal Generator are shown in Table 4A-1.

**Table 4A-1. Signal Generator Frequency Bands**

BAND DESIGNATION	FREQUENCY RANGE (MHz)	DIVIDE RATIO
A (6080A)	.01 to 14.999999	8 (Het)
A (6082A)	0.1 to 14.999999	8 (Het)
B	15 to 31.999999	32
C	32 to 63.999999	16
D	64 to 127.999999	8
E	128 to 255.999999	4
F	256 to 511.999999	2
G (6080A)	512 to 1056	1
G (6082A)	512 to 1055.999999	1
H (6082A)	1056 to 2112	0.5

**RF OUTPUT BLANKING DURING FREQUENCY CHANGES**

**4A-8.**

The Signal Generator output typically settles within 100 ms after you change the frequency. During the transition period, frequency transients may appear at the RF output, particularly when the change causes frequency synthesis circuitry to rerange.

If transients that occur during frequency range changes are troublesome in your application, you can suppress them by enabling Special Function 781. (Special Function 780 disables the mode.) Special Function 781 blanks the RF output for 60 ms during synthesis hardware transitions before the RF output is set to the new programmed value.

Table 4A-1 lists the major frequency bands. In addition, there are many minor bands that also cause the RF output to be blanked (when Special Function 781 is active) as their limits are crossed.

SYNTAX:

	FRONT PANEL	REMOTE
Disable RF Output Blanking Mode	<input type="checkbox"/> SPCL <input type="checkbox"/> 7 <input type="checkbox"/> 8 <input type="checkbox"/> 0	FREQ_BLANK OFF
Enable RF Output Blanking Mode	<input type="checkbox"/> SPCL <input type="checkbox"/> 7 <input type="checkbox"/> 8 <input type="checkbox"/> 1	FREQ_BLANK ON

# Section 4B

## RF Output Amplitude

### INTRODUCTION

4B-1.

Section 4B describes the procedures for programming the RF output amplitude and the associated parameters of RF output amplitude.

### SETTING RF OUTPUT AMPLITUDE

4B-2.

The RF output amplitude can be controlled with the FUNCTION-DATA-UNIT entry sequence. The amplitude display is fixed point for dBm and dB units and is floating point for voltage units. The selected unit is retained until a numeric entry is terminated with the alternate unit, the display units are converted, or an alternate dB unit is selected by Special Function. Pressing the AMPL function key moves the bright digit to the AMPLITUDE display field and places the Signal Generator in the RF amplitude entry mode.

#### RF AMPLITUDE

RANGE	RESOLUTION
-147 to +20 dBm	0.1 dB*
10 nV to 2.24 V	3 digits

\*0.01 dB over IEEE bus

#### SYNTAX:

AMPL -- Numeric Data -- 
 dB(m)  
MHz|V  
kHz|mV  
Hz|µV

EXAMPLE: Set Amplitude to -7.5 dBm.

FRONT PANEL: AMPL - 7 . 5 dB(m)

REMOTE: AMPL -7.5 DBM

## CONVERTING RF OUTPUT AMPLITUDE UNITS

4B-3.

You can convert displayed RF output amplitude quantity from dBm units to voltage units or from voltage units to dBm units by selecting the Amplitude function, then pressing the desired unit key. The output of the Signal Generator does not change during these operations. The display units remain in effect until a numeric entry is terminated with an alternate unit or the display units are converted by reversing the procedure.

### AMPLITUDE UNITS CONVERSION:

$$V = 10^{(dBm - 13.0)/20.0}$$

$$dBm = 13.0 + 20.0 \log_{10}(V)$$

### SYNTAX:

TO CONVERT	FRONT PANEL	REMOTE
dBm to Volts	<b>AMPL</b> <b>MHz V</b>	AMPL_UNITS V
Volts to dBm	<b>AMPL</b> <b>dB(m)</b>	AMPL_UNITS DBM

## SELECTING ALTERNATE DB REFERENCE UNITS

4B-4.

If the RF output amplitude is displayed as a dBm quantity, alternate units of dBmV, dBμV, or dBf may be selected. Selection of an alternate dB reference does not change the output of the Signal Generator. The selected alternate units are retained when changing to or from voltage units, and remain in effect for any Amplitude entry terminated with the **dB(m)** unit key.

To select an alternate dB reference unit from the front panel, use a Special Function. To select an alternate amplitude unit in remote, use the alternate amplitude unit as the unit terminator for the AMPL command. See Section 5, "Remote Operation" for more information.

### ALTERNATE AMPLITUDE UNITS:

$$\begin{aligned} dBmV &= dBm + 47.0 \\ dB\mu V &= dBm + 107.0 \\ dBf &= dBm + 120.0 \end{aligned}$$

### SYNTAX:

	FRONT PANEL	REMOTE
Select dBm Units	<b>SPCL</b> <b>8</b> <b>4</b> <b>0</b>	AMPL <numeric value> DBM
Select dBmV Units	<b>SPCL</b> <b>8</b> <b>4</b> <b>1</b>	AMPL <numeric value> DBMV
Select dBμV Units	<b>SPCL</b> <b>8</b> <b>4</b> <b>2</b>	AMPL <numeric value> DBUV
Select dBf Units	<b>SPCL</b> <b>8</b> <b>4</b> <b>3</b>	AMPL <numeric value> DBF

## USING UNTERMINATED OUTPUT (EMF) MODE

4B-5.

When enabled, unterminated output mode (EMF units) causes amplitude values to be doubled for voltage units, or offset by 6 dB for dBmV or dB $\mu$ V units. This includes the displayed amplitude, the base amplitude (if the relative amplitude mode is on), the amplitude sweep increment (if in volts), and the amplitude sweep width (if in volts). This also includes all limits to the amplitude values. The unterminated output mode has no effect if the displayed quantity has units of dBm or dBf.

To select the Unterminated Output Display mode from the front panel, use a Special Function. To select the mode in remote, use the AMPL\_EMFOUT command.

Enabling this mode has no effect on the Signal Generator output. The EMF units are retained when changing to or from voltage units, and remain in effect for any Amplitude entry based on a voltage unit.

Disabling this mode may change the Signal Generator output since resolution may be lost. For example, an RF output amplitude of 201 mV programmed when in the unterminated output mode will be converted to 100 mV, not 100.5 mV when the mode is disabled.

### EMF UNITS CONVERSION:

$$\begin{aligned} \text{EMF dBmV} &= \text{dBmV} + 6 \text{ dBmV} \\ \text{EMF dB}\mu\text{V} &= \text{dB}\mu\text{V} + 6 \text{ dB}\mu\text{V} \\ \text{EMF V} &= 2 \cdot \text{V} \end{aligned}$$

### SYNTAX:

	FRONT PANEL	REMOTE
Normal Amplitude Display Mode	<input type="button" value="SPCL"/> <input type="button" value="8"/> <input type="button" value="5"/> <input type="button" value="0"/>	AMPL_EMFOUT OFF
Unterminated Output Display Mode	<input type="button" value="SPCL"/> <input type="button" value="8"/> <input type="button" value="5"/> <input type="button" value="1"/>	AMPL_EMFOUT ON

## SETTING RF OUTPUT AMPLITUDE STEP SIZE

4B-6.

The RF output amplitude step size can be selected for entry by pressing the **AMPL** key, followed by the **STEP** key. As long as the **STEP** key is pressed, the step size is displayed. Upon entering a new step size, the value is held momentarily in the AMPLITUDE display field. Step Increment/Decrement operations are rejected unless the units of the amplitude and amplitude step match.

Note that 0.01 dB resolution is available for amplitude step sizes less than 20.0 dB, even though the RF output amplitude is always displayed with 0.1 dB resolution. In the event that a step size with 0.01 dB resolution is selected, stepping the amplitude up or down may cause the display to become inconsistent with the actual amplitude. Parameter entry of a new RF output amplitude always zeros the 0.01 dB digit; however, bright-digit edit operations retain the 0.01 dB resolution.

RF AMPLITUDE STEP SIZE

RANGE	RESOLUTION
0.00 to 19.99 dB	0.01 dB
20.0 to 167.0 dB	0.1 dB
0 V to 2.24 V	3 digits

SYNTAX:

**AMPL** **STEP** -- Numeric Data -- **dB(m)**  
**MHz|V**  
**kHz|mV**  
**Hz|μV**

EXAMPLE: Set Amplitude Step Size to 6 dB.

FRONT PANEL: **AMPL** **STEP** **6** **dB(m)**

REMOTE: AMPL\_STEP 6 DB

## USING RF AMPLITUDE RELATIVE MODE

4B-7.

The RF amplitude relative mode lets you establish a reference amplitude then set the output relative to that reference. You set a reference by setting the RF output amplitude to the desired value and then enabling the relative mode using a Special Function command from the front panel, or with the AMPL\_REL command in remote. This causes the REL annunciator to light in the AMPLITUDE display field and the displayed value to become zero. The Signal Generator output does not change during this operation. In the relative mode, you can use the usual means of parameter modification: Function Entry, Bright-Digit Edit, or Step Increment/Decrement.

In the relative amplitude mode, the output amplitude is the sum of the reference and the displayed amplitude when the reference and the displayed quantities have the same units. The output amplitude may be displayed by pressing the **AMPL** key. In remote, the output amplitude can be queried with the AMPL\_ABS? command and the reference amplitude can be queried with the AMPL\_BASE? command.



Note that a reference amplitude having dBm, dBmV, dB $\mu$ V, or dBf units is converted to a dB (ratio) value, so that the displayed value retains the units of the reference; the output is the displayed value scaled by the reference value. With mixed units (voltage and dB), the output amplitude is the voltage value scaled by the dB value. With voltage units, the output is the sum of the reference and the displayed values. Table 4B-1 illustrates the allowed combinations of reference and displayed amplitude, and shows how the amplitude values are interpreted with the relative amplitude mode enabled.

Relative mode may not be enabled or disabled while sweep is active. See Section 4E, "Sweep" for more information.

SYNTAX:

	FRONT PANEL	REMOTE
Disable Relative Amplitude	<input type="button" value="SPCL"/> <input type="button" value="3"/> <input type="button" value="0"/>	AMPL_REL OFF
Enable Relative Amplitude	<input type="button" value="SPCL"/> <input type="button" value="3"/> <input type="button" value="1"/>	AMPL_REL ON

EXAMPLE: Compensate for external gain or loss. A +10.0 dB gain amplifier is connected to the output of the Signal Generator. Program the Signal Generator to display the boosted output level using Relative Amplitude.

FRONT PANEL: Press the following keys to program the Signal Generator to -10 dBm. The output of the amplifier is 0.0 dBm

Press the following keys to select Relative Amplitude. The Signal Generator display now reflects the amplifier output (0.0 dBm).

REMOTE: AMPL 10.0 DBM; AMPL\_REL ON

Table 4B-1. Relative Amplitude Unit Combinations

AMPLITUDE WHEN RELATIVE MODE ENABLED	REFERENCE AMPLITUDE UNITS	DISPLAYED AMPLITUDE UNITS	OUTPUT AMPLITUDE ( <input type="button" value="AMPL"/> PRESSED)
dBm	dB	dBm	dBm (displayed) + dB (reference)
dBmV	dB	dBmV	dBmV (displayed) + dB (reference)
dB $\mu$ V	dB	dB $\mu$ V	dB $\mu$ V (displayed) + dB (reference)
dBf	dB	dBf	dBf (displayed) + dB (reference)
dBxx*	dB	voltage	voltage (displayed) x dB (reference)
voltage	voltage	dB	voltage (referenced) x dB (displayed)**
voltage	voltage	voltage	voltage (displayed) + V (reference)**

\* Any dB-based units (i.e. dBm, dB $\mu$ V, dBmV, dBf).  
 \*\* Units conversion of the displayed amplitude is not allowed when the reference amplitude has Voltage units, since an absolute quantity (Volts) cannot be converted to a ratio (dB).

**ENABLING AND DISABLING RF OUTPUT**

**4B-8.**

You can enable and disable the RF output signal by pressing the RF OUTPUT  ON/OFF key, or with the RFOUT command in remote. Turning the RF output on resets the Reverse Power Protection (RPP) circuitry if it has been tripped.

Pressing the RF OUTPUT  ON/OFF key alternately turns the output off and on. When the RF output is off, the RF OFF annunciator is lit. The amplitude setting when the RF is turned off is restored when the output is turned on again. The displayed amplitude is not changed when the output is turned off.

SYNTAX:

	FRONT PANEL	REMOTE
Turn On RF Output (RF OFF annunciator on)	RF OUTPUT <input type="checkbox"/> ON/OFF	RFOUT ON
Turn Off RF Output (RF OFF annunciator off)	RF OUTPUT <input type="checkbox"/> ON/OFF	RFOUT OFF

**RF OUTPUT AMPLITUDE BANDS**

**4B-9.**

Amplitude settings for the Signal Generator are achieved by cascading the RF output through a series of attenuators for coarse control and through a DAC for vernier control. The attenuator series consists of a single 6-dB section, a single 12-dB section, and five 24-dB sections. When Amplitude Modulation (AM) is enabled, the amplitude band switch points are shifted down by 3 dB (frequencies <1056 MHz or if frequency sweep is enabled in Model 6082A) or 6 dB (frequencies ≥ 1056 MHz; 6082A only) Table 4B-2 lists the Signal Generator amplitude band divisions of the in dBm units.

Table 4B-2. RF Output Amplitude Bands

AMPLITUDE RANGE IN dBm					
AM OFF		AM ON (f<1056 MHz)		AM ON (f≥1056 MHz)	
+7.0	+20.0	+4.0	+20.0	+1.0	+20.0
+1.0	+6.9	-2.0	+3.9	-5.0	+0.9
-5.0	+0.9	-8.0	-2.1	-11.0	-5.1
-11.0	-5.1	-14.0	-8.1	-17.0	-11.1
-17.0	-11.1	-20.0	-14.1	-23.1	-17.1
-23.1	-17.1	-26.1	-20.1	-29.1	-23.2
-29.1	-23.2	-32.1	-26.2	-35.1	-29.2
-35.1	-29.2	-38.1	-32.2	-41.1	-35.2
-41.1	-35.2	-44.1	-38.2	-47.1	-41.2
-47.1	-41.2	-50.1	-44.2	-53.2	-47.2
-53.2	-47.2	-56.2	-50.2	-59.2	-53.3
-59.2	-53.3	-62.2	-56.3	-65.2	-59.3
-65.2	-59.3	-68.2	-62.3	-71.2	-65.3
-71.2	-65.3	-74.2	-68.3	-77.2	-71.3
-77.2	-71.3	-80.3	-74.3	-83.3	-77.3
-83.3	-77.3	-86.3	-80.4	-89.3	-83.4

Table 4B-2. RF Output Amplitude Bands (cont)

AMPLITUDE RANGE IN dBm					
AM OFF		AM ON (f<1056 MHz)		AM ON (f≥1056 MHz)	
-89.3	-83.4	-92.3	-86.4	-95.3	-89.4
-95.3	-89.4	-98.3	-92.4	-101.3	-95.4
-101.3	-95.4	-104.4	-98.4	-107.4	-101.4
-107.4	-101.4	-110.4	-104.5	-113.4	-107.5
-113.4	-107.5	-116.4	-110.5	-119.4	-113.5
-119.4	-113.5	-122.4	-116.5	-125.4	-119.5
-125.4	-119.5	-128.4	-122.5	-131.5	-125.5
-147.0	-125.5	-147.0	-128.5	-147.4	-131.6

**USING RF OUTPUT AMPLITUDE FIXED-RANGE MODE**

**4B-10.**

When enabled, Amplitude Fixed-Range mode fixes the setting of the attenuators at the given output level. This allows monotonic and nontransient level control over a limited range around those levels where the attenuators are normally reranged.

Fixed-range mode is enabled using a Special Function command from the front panel, or with the AMPL\_RANGE command in remote. The SPCL annunciator is lit when fixed-range mode is enabled. Fixed-range level control remains in effect only during Bright-Digit Edit of the AMPLITUDE display field. Other methods of changing the output cause the attenuators to rerange if necessary. Changing the RF output frequency, initiating an RF amplitude sweep, or enabling/disabling AM will also cause the attenuators to rerange.

The level vernier in fixed-range mode has a specified accuracy range of 12 dB around the point at which fixed-range mode is enabled. If an attempt is made to edit the amplitude value beyond the range of the vernier, the STATUS annunciator flashes, and the output level is not guaranteed.

SYNTAX:

	FRONT PANEL	REMOTE
Disable Fixed-Range	SPCL 5 0	AMPL_RANGE NORMAL
Enable Fixed-Range	SPCL 5 1	AMPL_RANGE FIXED

EXAMPLE: Set the Signal Generator for monotonic and nontransient amplitude control (Bright-Digit Edit only) over the range of the vernier level control below 0.25V.

FRONT PANEL: AMPL . 2 5 MHz V SPCL 5 1

REMOTE: AMPL 0.25 V ; AMPL\_RANGE FIXED

## USING ALTERNATE OUTPUT COMPENSATION MODES

4B-11.

Alternate output compensation modes are available on the Signal Generator. Normally, a factory-generated set of data which characterizes the output circuitry is applied, and a factory-generated set of data which characterizes the attenuators is applied. It is possible to configure the Signal Generator to apply the output circuitry compensation data only (no attenuator compensation) to the output, or to apply no compensation data to the output. Selecting a compensation mode is done using a Special Function command from the front panel, or with the `AMPL_COMP` command in remote. The SPCL annunciator is lit when an alternate compensation mode is selected.

### SYNTAX:

	FRONT PANEL	REMOTE
Apply All Compensation Data	SPCL 9 2 0	<code>AMPL_COMP ALL</code>
Apply No Compensation Data*	SPCL 9 2 1	<code>AMPL_COMP NONE</code>
Apply Output Compensation Only	SPCL 9 2 2	<code>AMPL_COMP OUTPUT</code>

\* NOTE: Also disables Level Calibration

## SELECTING ALTERNATE OUTPUT COMPENSATION DATA

4B-12.

The Signal Generator has provision for user-definable output (output circuitry) compensation data. It is possible to characterize the Signal Generator when the RF output is connected through a lengthy or lossy path and store this data. The method for generating this data is described under "Compensating Level Flatness Errors in an External System" in Section 7 of the Service Manual. Once an alternate set has been loaded, the alternate compensation data can be selected for use using a Special Function command from the front panel, or with the `AMPL_CMPDAT` command in remote. The SPCL annunciator is lit when alternate compensation data are selected.

### SYNTAX:

	FRONT PANEL	REMOTE
Apply Standard Output Compensation Data	SPCL 9 3 0	<code>AMPL_CMPDAT STD</code>
Apply Alternate Output* Compensation Data	SPCL 9 3 1	<code>AMPL_CMPDAT ALT</code>

\* NOTE: This compensation data is only applied to the Output Circuitry.

# Section 4C

## Modulation

### INTRODUCTION

4C-1.

The Signal Generator offers four modulation capabilities:

- Amplitude modulation (AM)
- Frequency modulation (FM)
- Phase modulation ( $\phi$ M)
- Pulse modulation (┌┐)

The MODULATION ON/OFF keys enable and disable one or more types of modulation from internal and external sources. Each modulation key is a toggle on/off type. Annunciators in the MODULATION display field indicate the enabled modulation types.

Various combinations of AM, FM/ $\phi$ M, and pulse modulation may be enabled in either internal or external (or both) modes. Some restrictions exist for certain combinations:

- FM and  $\phi$ M are always mutually exclusive
- External ac and dc modes of each modulation form are mutually exclusive.

It is easier to understand by considering AM, FM/ $\phi$ M, and pulse modulation as three separate groups, where FM and  $\phi$ M are mutually exclusive members of a single group. While interactions and exclusions exist within each group, there are no interactions between groups. In other words, no combination of AM on/off modes ever interacts with FM/ $\phi$ M on/off modes, or pulse modulation on/off modes.

The MODULATION display field is shared by amplitude modulation depth, frequency/phase modulation deviation, modulation frequency, and modulation level. Since there is only one modulation display, the displayed modulation parameter is determined by the last modulation FUNCTION key pressed.

### INTERNAL MODULATION OSCILLATOR

4C-2.

An internal modulation oscillator digitally synthesizes one of three waveforms (sine, square, triangular) at a specified modulation frequency. The internal modulation oscillator uses DDS (Direct Digital Synthesis) to provide excellent signal purity. It can also be configured as a pulse generator where the pulse width and repetition rate are programmable. The synthesized modulation waveform is available at the front panel connector labeled MOD OUTPUT.

### Setting Modulation Frequency and Step Size

4C-3.

The modulation frequency (Mod Frequency) is displayed in the Signal Generator front panel MODULATION display field with three digits of resolution. The Mod Frequency is displayed with kHz or Hz units, with the MOD FREQ annunciator on.

Mod Frequency and the Mod Frequency Step Size are controlled using the FUNCTION-DATA-UNIT entry sequence. Pressing the **MOD FREQ** function key causes the MODULATION display field to display the Mod Frequency, moves the bright digit to the MODULATION display field and places the Signal Generator in the Mod Frequency entry mode. Entry or modification of the Mod Frequency does not change the Signal Generator's RF output unless internal modulation is enabled. The Mod Frequency step size is selected for entry by pressing the **STEP** key after selecting the Mod Frequency function.

As a shortcut method, use the **400/1000** key to toggle the Mod Frequency between 400 and 1000 Hz. The MODULATION display field is updated to reflect 400 Hz or 1.00 kHz as the values are selected. This key is inactive when the front panel bright digit is turned off.

MODULATION FREQUENCY	
RANGE	RESOLUTION
0.1 Hz to 200 kHz	3 digits

SYNTAX:

Modulation Frequency

**MOD FREQ** -- numeric data -- **MHz|V**  
**kHz|mV**  
**Hz|V**

Modulation Frequency Step Size

**MOD FREQ** **STEP** -- numeric data -- **MHz|V**  
**kHz|mV**  
**Hz|V**

EXAMPLE 1: Set Modulation Frequency to 19 kHz

FRONT PANEL: **MOD FREQ** **1** **9** **kHz|mV**

REMOTE: MODF 19 KHZ

EXAMPLE 2: Set Modulation Frequency Step Size to 1 kHz

FRONT PANEL: **MOD FREQ** **STEP** **1** **kHz|mV**

REMOTE: MODF\_STEP 1 KHZ

### Setting Modulation Level and Step Size

4C-4.

Modulation level refers to the peak level signal present at the front panel connector (labeled MOD OUTPUT), into a 600Ω load. The modulation level (Mod Level) is displayed in the Signal Generator front panel MODULATION display field with three digits of resolution. The Mod Level is displayed with V units, with the MOD LEVEL annunciator on.

The Mod Level and Mod Level step size are controlled using the FUNCTION-DATA-UNIT entry sequence. Pressing the **MOD LEV** key causes the MODULATION display field to display the current Mod Level, moves the bright digit to the MODULATION display field, and places the Signal Generator in the Mod Level entry mode. The Mod Level setting has no effect on the Signal Generator RF output. The Mod Level step size is selected for entry by pressing the **STEP** key after selecting the Mod Level function.

#### MODULATION LEVEL

RANGE	RESOLUTION
0.0 to 4.00 V	3 digits

#### MODULATION LEVEL STEP SIZE

RANGE	RESOLUTION
0.0 to 4.00 V	3 digits

#### SYNTAX:

Modulation Level

**MOD LEV** -- numeric data -- **MHz|V**  
**kHz|mV**  
**Hz|μV**

Modulation Level Step Size

**MOD LEV** **STEP** -- numeric data-- **MHz|V**  
**kHz|mV**  
**Hz|μV**

EXAMPLE 1: Set Modulation Level to 1.41 v

FRONT PANEL: **MOD LEV** 1 . 4 1 **MHz|V**

REMOTE: MODL 1.41 V

EXAMPLE 2: Set Modulation Level Step Size to 1 mV

FRONT PANEL: **MOD LEV** **STEP** 1 **kHz|mV**

REMOTE: MODL\_STEP 1 MV

### Enabling and Disabling Modulation Output

4C-5.

Output of the internal modulation oscillator signal through the MOD OUTPUT connector on the front panel may be enabled and disabled. Note that the internal modulation signal is normally output through this connector, even though all internal modulation is off. To disable the modulation output, use a Special Function from the front panel, or the MODOUT command in remote. The SPCL annunciator is lit when the modulation output is disabled.

SYNTAX:

	FRONT PANEL	REMOTE
Disable Modulation Output	<div style="display: inline-block; border: 1px solid black; padding: 2px;">SPCL</div> <div style="display: inline-block; border: 1px solid black; padding: 2px; margin-left: 10px;">4</div> <div style="display: inline-block; border: 1px solid black; padding: 2px; margin-left: 10px;">1</div>	MODOUT OFF
Enable Modulation Output	<div style="display: inline-block; border: 1px solid black; padding: 2px;">SPCL</div> <div style="display: inline-block; border: 1px solid black; padding: 2px; margin-left: 10px;">4</div> <div style="display: inline-block; border: 1px solid black; padding: 2px; margin-left: 10px;">0</div>	MODOUT ON

### Selecting the Internal Modulation Waveform

4C-6.

The Signal Generator internal modulation oscillator is capable of producing a variety of output waveforms. These waveforms are: sine wave, triangle wave, and square wave. The oscillator may also be configured as a variable width pulse generator. Only one of the waveforms, or the internal pulse generator mode can be enabled at any given time.

The selected waveform may be applied to the internal AM, internal FM, or internal pulse circuitry. Each modulation path (AM, FM, pulse) is controlled independently of the others.

This selection scheme allows any waveform to be applied to internal AM, internal FM, or internal pulse. In addition, multiple modulation paths (e.g., internal AM and internal FM) may be simultaneously enabled to use the selected waveform, although the resulting output may be of little use.

The SPCL annunciator is lit when an alternate modulation waveform is selected. The following Front Panel key sequences and Remote commands select the waveform of the modulation oscillator:

SYNTAX:

WAVEFORM	FRONT PANEL	REMOTE
Sine	<div style="display: inline-block; border: 1px solid black; padding: 2px;">SPCL</div> <div style="display: inline-block; border: 1px solid black; padding: 2px; margin-left: 10px;">7</div> <div style="display: inline-block; border: 1px solid black; padding: 2px; margin-left: 10px;">5</div> <div style="display: inline-block; border: 1px solid black; padding: 2px; margin-left: 10px;">0</div>	MOD_WAVE SINE
Triangle	<div style="display: inline-block; border: 1px solid black; padding: 2px;">SPCL</div> <div style="display: inline-block; border: 1px solid black; padding: 2px; margin-left: 10px;">7</div> <div style="display: inline-block; border: 1px solid black; padding: 2px; margin-left: 10px;">5</div> <div style="display: inline-block; border: 1px solid black; padding: 2px; margin-left: 10px;">1</div>	MOD_WAVE TRIANGLE
Square	<div style="display: inline-block; border: 1px solid black; padding: 2px;">SPCL</div> <div style="display: inline-block; border: 1px solid black; padding: 2px; margin-left: 10px;">7</div> <div style="display: inline-block; border: 1px solid black; padding: 2px; margin-left: 10px;">5</div> <div style="display: inline-block; border: 1px solid black; padding: 2px; margin-left: 10px;">2</div>	MOD_WAVE SQUARE



**Using the Extended Resolution Mode for Modulation Frequency 4C-7.**

An extended resolution mode is available for entry of Mod Frequency. This mode is enabled with a Special Function command and allows the Mod Frequency to be input from the front panel with 0.1 Hz resolution over its entire range. This resolution is always available in remote using the "MODF" command.

Entering    displays the current modulation frequency in the FREQUENCY display field with 0.1 Hz resolution followed by a question mark prompt which indicates that a new modulation frequency can be entered. If a new modulation frequency is entered in response to the prompt, it is rounded to 0.1 Hz resolution and the modulation oscillator circuitry is programmed accordingly. The new modulation frequency is displayed in the MODULATION display field. If it has more than three significant digits, it is rounded to three digits before it is displayed.

Mod Frequency entries are stored in two formats: with the displayed 3-digit resolution and with extended 0.1 Hz resolution. Every Mod Frequency or extended resolution Mod Frequency entry is stored in both formats. However, step, edit, store and recall operations operate on the displayed value only. Extended resolution Mod Frequency entries are temporary entries, in that any edit or step increment/decrement operations force the value back into normal resolution. Only Special Function 42 will display an extended entry with full resolution, and only if no intervening commands have truncated it.

SYNTAX:

-- Numeric Data--

**AMPLITUDE MODULATION (AM) 4C-8.**

Amplitude modulation depth is displayed in the Signal Generator modulation display field with 0.1% of resolution. The AM depth is displayed with "%" units.

Note that internal AM can be combined with external ac-coupled AM (ACAM) or external dc-coupled AM (DCAM). However, external ACAM and external DCAM are mutually exclusive. Enabling external ACAM while external DCAM is enabled turns off external DCAM, and vice versa.

**Setting AM Depth and AM Depth Step Size 4C-9.**

The AM depth and AM depth step size are controlled using the FUNCTION-DATA-UNIT entry sequence. Pressing the  function key causes the MODULATION display field to display the AM depth, moves the bright digit to the MODULATION display field and places the Signal Generator in the AM depth entry mode. Entry or modification of the AM depth value does not change the Signal Generator output unless AM is enabled. The AM depth step size is selected for entry by pressing the  key after selecting the AM function.

**FRONT PANEL OPERATION  
MODULATION**

**AM DEPTH**

RANGE	RESOLUTION
0 to 99.9%	0.1%

**AM DEPTH STEP SIZE**

RANGE	RESOLUTION
0 to 99.9%	0.1%

**SYNTAX:**

Set AM Depth

-- numeric data --

Select AM Depth Step Size

-- numeric data --

**EXAMPLE 1:** Set AM depth to 23.5%

FRONT PANEL:

REMOTE: AM 23.5 PCT

**EXAMPLE 2:** Set AM depth step size to 1.0%

FRONT PANEL:

REMOTE: AM\_STEP 1.0 PCT

**Activating Internal AM**

**4C-10.**

Internal AM is enabled by pressing the  key from the front panel, or using the INT\_AM ON command in remote. The INT AM annunciator is lit when Internal AM is enabled. With Internal AM enabled, the internal modulation oscillator modulates the RF signal to the specified AM Depth at the modulation frequency rate. This rate may be viewed by pressing . Pressing the  key again disables internal AM, as does the INT\_AM OFF command in remote.

**Activating External AM (AC Coupled)**

**4C-11.**

External ac-coupled AM (ACAM) is enabled by pressing the  key from the front panel, or with the EXTAC\_AM ON command in remote. The EXT AM annunciator is lit when External AM is enabled. When external AM is enabled, the modulating signal is applied through the front panel external AM input connector. Pressing the  key again disables External AM, as does the EXTAC\_AM OFF command in remote.

External AM uses a 1V pk input signal. Two annunciators on the front panel give indications of when the external ACAM modulation signal is outside the range of  $1V \pm 2\%$ . These annunciators are lit only when external ACAM is enabled and are not active when external DCAM is enabled. If the signal is greater than 1.02V, the AM HI annunciator is lit. If the signal is less than 0.98V, the AM LO annunciator is lit.

### Activating External AM (DC Coupled)

4C-12.

External dc-coupled AM (DCAM) is enabled by pressing the  key from the front panel, or using with the EXTDC\_AM ON command in remote. The EXT DC AM annunciator is lit when External AM is enabled. When external AM is enabled, the modulating signal is applied through the front panel external AM input connector. External AM is normalized for a 1V pk input signal. Pressing the  key again disables External DC AM, as does the EXTDC\_AM OFF command in remote.

#### NOTE

*When AM is enabled, the amplitude band switch point may change. See "RF Output Amplitude Bands" in Section 4B for details.*

### FREQUENCY AND PHASE MODULATION (FM/ $\phi$ M)

4C-13.

Frequency modulation (FM) deviation and phase modulation ( $\phi$ M) deviation are displayed in the Signal Generator front panel MODULATION display field with three digits of resolution. FM is displayed with MHz DEV, kHz DEV, or Hz DEV units, and  $\phi$ M is displayed with rad units.

$\phi$ M entries and modifications are processed internally as FM after the  $\phi$ M deviation is converted to an equivalent FM deviation. The modulation circuitry is configured to maintain this relationship over the range of allowed modulation frequencies and deviations. Because of this direct relationship between FM and  $\phi$ M, this section focuses on FM programming, with references to  $\phi$ M where appropriate.

#### NOTE

*FM and  $\phi$ M are always mutually exclusive. For FM, external ACFM and external DCFM are mutually exclusive. For  $\phi$ M, external AC $\phi$ M and external DC $\phi$ M are mutually exclusive. Enabling external ACFM while external DCFM is enabled, turns off external DCFM, and vice versa. The same holds true for  $\phi$ M.*

### Setting FM/ $\phi$ M Deviation and FM/ $\phi$ M Step Size

4C-14.

The FM/ $\phi$ M deviation and FM/ $\phi$ M deviation step size are controlled using the FUNCTION-DATA-UNIT entry sequence. Pressing the FM/ $\phi$ M deviation function key  causes the MODULATION display field to display the current FM/ $\phi$ M deviation, moves the bright digit to the MODULATION display field, and places the Signal Generator in the FM/ $\phi$ M deviation entry mode. Entry or modification of the FM/ $\phi$ M deviation value does not change the Signal Generator output unless FM/ $\phi$ M is enabled.

The FM/ $\phi$ M deviation step size is selected for entry by pressing the  key after selecting the FM/ $\phi$ M function. Although the FM/ $\phi$ M deviation and FM/ $\phi$ M deviation step size may have different units, Step Increment and Decrement operations are rejected unless the units are consistent.

**FRONT PANEL OPERATION  
MODULATION**

FM/φM DEVIATION			
		RANGE	RESOLUTION
6080A	FM	0 to 4.00 MHz	3 digits
	φM	0 to 400 rad	3 digits
FM/φM DEVIATION STEP SIZE			
		RANGE	RESOLUTION
6080A	FM	0 to 4.00 MHz	3 digits
	φM	0 to 400 rad	3 digits
6082A	FM	0 to 8.00 MHz	3 digits
	φM	0 to 800 rad	3 digits

**SYNTAX:**

Set FM Deviation

**FMloM** -- numeric data -- **MHz|V**  
**kHz|mV**  
**Hz|μV**

Set φM Deviation

**FMloM** -- numeric data -- **%|rad**

Select FM deviation step size

**FMloM** **STEP** -- numeric data -- **MHz|V**  
**kHz|mV**  
**Hz|μV**

Select φM deviation step size

**FMloM** **STEP** -- numeric data -- **%|rad**

**EXAMPLE 1: Set FM deviation to 50 kHz**

FRONT PANEL: **FMloM** **5** **0** **kHz|mV**

REMOTE: FM 50 KHZ

**EXAMPLE 2: Set FM deviation step size to 500 Hz**

FRONT PANEL: **FMloM** **STEP** **5** **0** **0** **Hz|μV**

REMOTE: FM\_STEP 500 HZ

The maximum FM/ϕM deviation allowed when FM or ϕM is enabled depends on the rf output frequency. Deviations up to 4 MHz/400 radians (6080A) or 8 MHz/800 radians (6082A) may be entered regardless of the output frequency; however, the STATUS annunciator is flashed if FM/ϕM modulation is enabled and the limits specified in Table 4C-1 are exceeded.

Table 4C-1. FM/ϕM Deviation Limits (FM/ϕM Enabled)

FREQUENCY BAND (MHz)	MAXIMUM FM DEVIATION	MAXIMUM ϕM DEVIATION
.01 to 15 (6080A)	500 kHz	50.0 radians
.1 to 15 (6082A)	500 kHz	50.0 radians
15 to 32	125 kHz	12.5 radians
32 to 64	250 kHz	25.0 radians
64 to 128	500 kHz	50.0 radians
128 to 256	1.0 MHz	100 radians
256 to 512	2.0 MHz	200 radians
512 to 1056	4.0 MHz	400 radians
1056 to 2112 (6082A)	8.0 MHz	800 radians

### Converting FM/ϕM Units

4C-15.

When converting from FM deviation to ϕM deviation and vice versa, the output of the Signal Generator does not change. However, the programmed modulation frequency must be taken into account, specifically:

$$\text{FM deviation (Hz)} = \text{ϕM deviation (rad)} * \text{Modulation Frequency (Hz)}$$

$$\text{ϕM deviation (rad)} = \text{FM deviation (Hz)} / \text{Modulation Frequency (Hz)}$$

The Mod Frequency used in these equations is always that of the internal modulation oscillator. Note that certain combinations of modulation frequency and the FM deviation or ϕM deviation may not be converted into the alternate units if the resulting deviation is outside the range allowed for those units.



Since the frequency of an external modulation source cannot be determined, FM/ϕM units conversion is rejected if external FM or ϕM is enabled.

#### SYNTAX:

TO CONVERT	FRONT PANEL	REMOTE
FM to ϕM	FM ϕM    % rad	FM_UNITS RAD
ϕM to FM	FM ϕM    MHz V kHz mV Hz μV	FM_UNITS HZ



### Activating Internal FM/ $\phi$ M

4C-16.

Internal FM/ $\phi$ M is enabled by pressing the  key from the front panel or with the INT\_FM ON command in remote. The unit specified for the FM deviation determines if the INT FM or INT  $\phi$ M annunciator is lit when Internal FM/ $\phi$ M is enabled. With Internal FM/ $\phi$ M enabled, the internal modulation oscillator modulates the RF output to the specified FM deviation or  $\phi$ M phase angle at the modulation frequency rate. This rate may be viewed by pressing . Pressing the  key again disables Internal FM/ $\phi$ M, as does the INT\_FM OFF command in remote.

### Activating External FM/ $\phi$ M (AC Coupled)



4C-17.

External AC-coupled FM/ $\phi$ M (ACFM) is enabled by pressing the  key from the front panel, or with the EXTAC\_FM ON command in remote. The EXT FM annunciator is lit when External FM is enabled, and the EXT  $\phi$ M annunciator is lit when External  $\phi$ M is enabled. When either is enabled, the modulating signal is applied through the front panel external FM/ $\phi$ M input connector. Pressing the  key again disables External FM/ $\phi$ M, as does the EXTAC\_FM OFF command in remote.

External FM/ $\phi$ M uses a 1V pk input signal. Two annunciators on the front panel give indications of when the external ACFM or AC $\phi$ M modulation signal is outside the range of 2% of 1V. These annunciators are only lit when external ACFM or AC $\phi$ M is enabled and are not active when external DCFM or DC $\phi$ M is enabled. If the signal is more than 1.02V, the FM HI annunciator is lit. If the signal is less than 0.98V, the FM LO annunciator is lit.

### Activating External FM (DC Coupled)

4C-18.

External DCFM is enabled by pressing the  key from the front panel, or with the EXTDC\_FM ON command in remote. The EXT DC FM annunciator is lit when External FM is enabled, and the EXT DC  $\phi$ M annunciator is lit when External DC  $\phi$ M is enabled. When either is enabled the modulating signal is applied through the front panel external FM/ $\phi$ M input connector. External FM/ $\phi$ M is normalized for a 1V pk input signal. Pressing the  key again disables External FM/ $\phi$ M, as does using the EXTDC\_FM OFF command in remote.

The external DCFM mode allows the RF signal to be frequency modulated by dc or by slowly varying ac rates by an input signal connected to the front panel FM/ $\phi$ M MODULATION INPUT connector. Enabling DCFM forces the FM circuitry to search for a correction voltage that maintains the RF frequency when the FM loop is unlocked. The FM loop is then configured to the unlocked state, and the dc-coupled path from the external FM/ $\phi$ M connector is selected.

This search for the FM loop correction voltage is called a DCFM "cal cycle". The time required to perform a DCFM cal cycle is determined by the selected FM band (see paragraph 4C-13). In most cases, the DCFM cal cycle completes in 0.5 seconds. However, if FM deviation in excess of 250 kHz is selected, the DCFM cal cycle can take up to 5 seconds. Once DCFM has been enabled, the message "PAUSE" appears in the FREQUENCY display field. When the hardware has settled, the display returns to its normal state.

While DCFM is enabled, the RF output frequency will drift with time. To remove the offset caused by this drift, a DCFM cal cycle should be performed as necessary. To force a DCFM cal cycle to occur, ACFM should be enabled (by pressing the **EXT AC FM/φM** key), followed by re-enabling DCFM.

External DC φM is identical to external AC φM except that the external FM/φM modulation input is dc coupled. Pressing the **EXT DC FM/φM** key while the FM/φM display shows φM in radians units, enables the dc-coupled path from the external FM/φM input connector, and enables the FM/φM circuitry programmed in the phase modulation mode. The external DCφM mode is entirely different from external DCFM, as the FM oscillator loop remains locked.

**FM Bands**

**4C-19.**

The interdependence between RF output frequency bands and FM bands is summarized in Tables 4C-2 and 4C-3. Table 4C-2 shows the FM band limits for normal FM mode. Table 4C-3 shows these limits when Low-Distortion FM is enabled. Each table is a two-dimensional matrix: the column entries represent RF output frequency bands, and the row entries represent each FM band. Each box lists the FM deviations that correspond to the upper and lower limits for that intersection of FM band and RF output frequency band.

**Table 4C-2. FM Band Limits**

FREQUENCY BAND (MHz)							
FM RANGE	1056-2112 (6082A)	512-1056	256-512	128-256	64 -128 Het	32 - 64	15 - 32
6	8.00 MHz 2.01 MHz	4.00 MHz 1.01 MHz	2.00 MHz 501 kHz	1.00 MHz 251 kHz	500 kHz 126 kHz	250 kHz 62.6 kHz	125 kHz 31.3 kHz
5	2.00 MHz 501 kHz	1.00 MHz 251 kHz	500 kHz 126 kHz	250 kHz 62.6 kHz	125 kHz 31.3 kHz	62.5 kHz 15.7 kHz	31.2 kHz 7.82 kHz
4	500 kHz 126 kHz	250 kHz 62.6 kHz	125 kHz 31.3 kHz	62.5 kHz 15.7 kHz	31.2 kHz 7.82 kHz	15.6 kHz 3.91 kHz	7.81 kHz 1.96 kHz
3	125 kHz 31.3 kHz	62.5 kHz 15.7 kHz	31.2 kHz 7.82 kHz	15.6 kHz 3.91 kHz	7.81 kHz 1.96 kHz	3.90 kHz 977 Hz	1.95 kHz 489 Hz
2	31.2 kHz 7.82 kHz	15.6 kHz 3.91 kHz	7.81 kHz 1.96 kHz	3.90 kHz 977 Hz	1.95 kHz 489 Hz	976 Hz 245 Hz	488 Hz 123 Hz
1	7.81 kHz 0 Hz	3.90 kHz 0 Hz	1.95 kHz 0 Hz	976 Hz 0 Hz	488 Hz 0 Hz	244 Hz 0 Hz	122 Hz 0 Hz
0	CW MODE						

**FRONT PANEL OPERATION  
MODULATION**

**Table 4C-3. FM Band Limits - Low Distortion Mode**

FREQUENCY BAND (MHz)							
FM RANGE	1056-2112 (6082A)	512-1056	256-512	128-256	64 -128 Het	32 - 64	15 - 32
6	8.00 MHz 2.01 MHz	4.00 MHz 1.01 MHz	2.00 MHz 501 kHz	1.00 MHz 251 kHz	500 kHz 126 kHz	250 kHz 62.6 kHz	125 kHz 31.3 kHz
5	2.00 MHz 501 kHz	1.00 MHz 251 kHz	500 kHz 126 kHz	250 kHz 62.6 kHz	125 kHz 31.3 kHz	62.5 kHz 15.7 kHz	31.2 kHz 7.82 kHz
4	500 kHz 56.1 kHz	250 kHz 28.1 kHz	125 kHz 14.1 kHz	62.5 kHz 7.01 kHz	31.2 kHz 3.51 kHz	15.6 kHz 1.76 kHz	7.81 kHz 876 Hz
3	56.0 kHz 31.3 kHz	28.0 kHz 15.7 kHz	14.0 kHz 7.81 kHz	7.00 kHz 3.91 kHz	3.50 kHz 1.96 kHz	1.75 kHz 977 Hz	875 Hz 489 Hz
2	31.2 kHz 4.01 kHz	15.6 kHz 2.01 kHz	7.80 kHz 1.01 kHz	3.90 kHz 501 Hz	1.95 kHz 251 Hz	976 Hz 126 Hz	488 Hz 63 Hz
1	4.00 kHz 0 Hz	2.00 kHz 0 Hz	1.00 kHz 0 Hz	500 Hz 0 Hz	250 Hz 0 Hz	125 Hz 0 Hz	62 Hz 0 Hz
0	CW MODE						

**Using Low Distortion and Fixed-Range FM Modes**

**4C-20.**

Two modes are available to modify or limit the ranging of the FM circuitry. These modes offer improved performance of the FM circuitry for certain applications. These modes are enabled using a Special Function command from the front panel, or with the FM\_RANGE command in remote. Entering either of these modes lights the SPCL annunciator below the FREQUENCY display field.

In the normal operation mode, the optimal FM band is determined for the specified combination of RF output frequency and FM deviation.

In FM Low Distortion mode, the total harmonic distortion is diminished, with a corresponding increase in phase noise. This mode provides the optimum phase noise-to-distortion performance at 3.5-kHz FM deviation at Mod Frequencies of 0.3 to 3 kHz.

In FM Fixed-Range mode, total harmonic distortion is improved over a wide range of FM deviation, with the lowest distortion near the lower end of each FM band. In this mode, it is possible to edit above or below the normal FM band limits since the normal FM autorange function is inhibited. The Fixed-Range mode locks to the FM band so that all subsequent adjustments made to the FM deviation and the RF output



frequency with the edit knob are processed without the auto-range. If an attempt is made to edit either of these values beyond the range limit, the STATUS annunciator flashes, and the value is constrained to the limit.

When FM Fixed-Range mode is enabled, FM deviation or step entries that map into FM ranges other than the current range will cause the FM circuitry to rerange. Fixed-Range mode remains in effect with the new FM range locked in. In addition, a change in the RF output frequency can also force a FM rerange.

SYNTAX:

	FRONT PANEL	REMOTE
Normal FM Ranging Mode	<input type="button" value="SPCL"/> <input type="button" value="7"/> <input type="button" value="3"/> <input type="button" value="0"/>	FM_RANGE NORMAL
Low Distortion FM Mode	<input type="button" value="SPCL"/> <input type="button" value="7"/> <input type="button" value="3"/> <input type="button" value="1"/>	FM_RANGE LOWDISTORT
Fixed-Range FM Mode	<input type="button" value="SPCL"/> <input type="button" value="7"/> <input type="button" value="3"/> <input type="button" value="2"/>	FM_RANGE FIXED

**Using Low Rate FM Mode**

**4C-21.**

Certain applications require FM at low modulation rates but cannot tolerate the shortcomings associated with operating in the DCFM mode when the FM loop is unlocked. When Low-Rate FM is enabled, lower modulation rates may be applied.

Low Rate FM mode is enabled with a Special Function command from the front panel, or with the LORATEFM command in remote. Although the mode is enabled, the FM circuitry is not set to the low-rate configuration unless internal FM or external FM is also enabled. Enabling this function does not affect the circuitry if the Signal Generator is programmed for phase modulation.

When the low-rate FM mode is enabled, the SPCL annunciator in the FREQUENCY display field is lit. The LO RATE annunciator in the MODULATION display field is lit when internal or external FM is enabled.

SYNTAX:

	FRONT PANEL	REMOTE
Turn Low Rate FM Off	<input type="button" value="SPCL"/> <input type="button" value="7"/> <input type="button" value="1"/> <input type="button" value="0"/>	LORATEFM OFF
Turn Low Rate FM On	<input type="button" value="SPCL"/> <input type="button" value="7"/> <input type="button" value="1"/> <input type="button" value="1"/>	LORATEFM ON

### Using High Rate $\phi$ M Mode

4C-22.

The high-rate  $\phi$ M mode trades higher modulation rates (up to 100 kHz) for less phase modulation deviation. Up to 40 radians of phase deviation are allowed in this mode.

High Rate  $\phi$ M mode is enabled with a Special Function command from the front panel, or with the HIRATEPM command in remote. When the high-rate  $\phi$ M mode is enabled, the SPCL annunciator in the FREQUENCY display field is lit.

SYNTAX:

	FRONT PANEL	REMOTE
Disable High Rate $\phi$ M	<div style="display: inline-block; border: 1px solid black; padding: 2px;">SPCL</div> <div style="display: inline-block; border: 1px solid black; padding: 2px; margin: 0 5px;">7</div> <div style="display: inline-block; border: 1px solid black; padding: 2px; margin: 0 5px;">2</div> <div style="display: inline-block; border: 1px solid black; padding: 2px; margin: 0 5px;">0</div>	HIRATEPM OFF
Enable High Rate $\phi$ M	<div style="display: inline-block; border: 1px solid black; padding: 2px;">SPCL</div> <div style="display: inline-block; border: 1px solid black; padding: 2px; margin: 0 5px;">7</div> <div style="display: inline-block; border: 1px solid black; padding: 2px; margin: 0 5px;">2</div> <div style="display: inline-block; border: 1px solid black; padding: 2px; margin: 0 5px;">1</div>	HIRATEPM ON



### PULSE MODULATION

4C-23.

External and internal pulse modulation are supported in the Signal Generator. Both internal and external pulse modulation may be enabled simultaneously. External pulse modulation input is always dc coupled.

### Activating External Pulse Modulation

4C-24.

External Pulse is enabled by pressing the  key from the front panel, or with the EXT\_PULSE ON command in remote. The EXT  annunciator is lit when External Pulse is enabled. Pressing the  key again disables External Pulse Mode, as does the EXT\_PULSE OFF command in remote.

External pulse modulation input is always dc coupled, and can be driven by a TTL-compatible signal. External pulse modulation is triggered at a 1V threshold crossing; any modulating signal applied to the EXT  front panel connector causes full scale output when the input signal exceeds the threshold and full attenuation when the input signal is below the threshold.

### Activating Internal Pulse Modulation

4C-25.

Internal pulse modulation is enabled with a Special Function command from the front panel, or with the INT\_PULSE command in remote. The INT  annunciator is lit when internal pulse is enabled.

Activating internal pulse modulation causes the internal modulation oscillator to configure itself as a pulse generator. More about this mode of operation is described under the next heading.

SYNTAX:

	FRONT PANEL	REMOTE
Turn Off Internal Pulse Modulation	<div style="display: inline-block; border: 1px solid black; padding: 2px;">SPCL</div> <div style="display: inline-block; border: 1px solid black; padding: 2px; margin: 0 5px;">7</div> <div style="display: inline-block; border: 1px solid black; padding: 2px; margin: 0 5px;">4</div> <div style="display: inline-block; border: 1px solid black; padding: 2px; margin: 0 5px;">0</div>	INT_PULSE OFF
Turn On Internal Pulse Modulation	<div style="display: inline-block; border: 1px solid black; padding: 2px;">SPCL</div> <div style="display: inline-block; border: 1px solid black; padding: 2px; margin: 0 5px;">7</div> <div style="display: inline-block; border: 1px solid black; padding: 2px; margin: 0 5px;">4</div> <div style="display: inline-block; border: 1px solid black; padding: 2px; margin: 0 5px;">1</div>	INT_PULSE ON

## Using the Mod Oscillator as a Pulse Generator

4C-26.

When internal pulse modulation is enabled, the internal modulation oscillator is configured as a variable width pulse generator. You can also configure the internal modulation oscillator as a pulse generator independent of internal pulse mode by using the Special Function or remote command in the following syntax diagram. When configured as a pulse generator, the internal mod oscillator generates a free running pulse train. Triggering of this pulse train is not possible.

Pulse periods in the range of 100 ms to 5 us are available by programming the Mod Frequency in the range from 10 Hz to 200 kHz. If a pulse period less than the pulse width is specified, the STATUS annunciator is flashed, and a pulse width that is 0.1 us less than the pulse period is substituted.

The pulse period is given priority over the pulse width. However, if a Mod Frequency is entered that would result in a pulse period less than the stored pulse width, the pulse width will be programmed to 0.1 us less than the pulse period.

Modulation frequencies less than 10 Hz (pulse periods greater than 100 ms) can be entered; however, the STATUS annunciator is flashed and the pulse period is programmed to 100 ms.

The internal pulse generator mode is enabled with a Special Function command from the front panel or with the MOD\_WAVE command in remote.

### SYNTAX:

	FRONT PANEL	REMOTE
Disable Internal Pulse Generator	SPCL 7 5 0	MOD_WAVE SINE
Disable Internal Pulse Generator	SPCL 7 5 8	MOD_WAVE PULSE

## Setting Pulse Width

4C-27.

When the modulation oscillator is configured as a variable width pulse generator, any pulse width in the valid range may be entered using a Special Function command from the front panel or the PULSE\_WIDTH command from Remote.

The pulse width will be specified with 0.1  $\mu\text{s}$  resolution over its entire range of values. Entering     displays the current pulse width in the FREQUENCY display field with 0.1  $\mu\text{s}$  resolution followed by a question mark prompt which indicates that a new pulse width can be entered. The characters " $\mu\text{S}$ " are displayed in the AMPLITUDE display field to clarify that this is the pulse width entry even though it is displayed in the FREQUENCY display field. If the entered pulse width is longer than the pulse period ( $1/\text{Mod Frequency}$ ), the STATUS annunciator is flashed, and the pulse width is set to 0.1  $\mu\text{s}$  less than the pulse period.

### PULSE WIDTH

RANGE	RESOLUTION
0.1 us to 99.9999 ms	0.1 $\mu\text{s}$

#### SYNTAX:

-- numeric data --

#### NOTE

The pulse width is always displayed with microsecond units. Pulse width entries are terminated with one of the following:

microsecond units =   
 millisecond units =   
 second units =

EXAMPLE: Program a pulse width of 100.0  $\mu\text{s}$

FRONT PANEL: Enter

The current pulse width is displayed in the FREQUENCY display field with a question mark prompt.

10 0000 ? US (current setting is 10000.0  $\mu\text{s}$ )

Enter     to program a 100 microsecond pulse width.

REMOTE: PULSE\_WIDTH 100 US

## Section 4D

# Instrument State Memory

### ORGANIZATION OF INSTRUMENT STATE MEMORY

4D-1.

The Signal Generator features nonvolatile memory for storage and recall of instrument settings. Up to 50 full instrument settings can be saved and recalled through memory operations. Six different memory operations are allowed from the front panel:

- Recall of a memory location
- Store to a memory location
- Recall next memory location
- Recall previous memory location
- Store a single function parameter.
- Recall a single function parameter.

In addition, a secure mode is available that blanks the display and erases nonvolatile memory (see “Secure Mode and Nonvolatile Memory Erasing” for details). All memory operations except single-function store and recall are available in remote. The contents of nonvolatile memory are preserved for at least 2 years with the Signal Generator’s power off. Whenever you turn off the power, memory location 00 always saves the last instrument settings.

Each memory location contains all of the commonly accessed parameters needed to program the Signal Generator. However, the RF on/off state is unaffected by memory recall operations. Certain other parameters are also not storable or recallable. These parameters are described in the Table 4D-1. Nonvolatile memory locations are organized as shown in Table 4D-2.

**FRONT PANEL OPERATION  
INSTRUMENT STATE MEMORY**

**Table 4D-1. Non-Storable/Recallable Parameters**

PARAMETER CATEGORY	PARAMETER
IEEE	Address Talk-Only/Listen-Only/Addressed Mode Language Service Request Enable Event Status Enable Instrument Status Change Enable Device Trigger Buffer Protected User Data
MEMORY	Dividers Memory Lock State
MISCELLANEOUS	RF ON/OFF state Alternate External Reference Frequency Output Correction Display ON/OFF state Key Repeat Rate State

**Table 4D-2. Non-volatile Memory Locations**

LOCATIONS	DESCRIPTIONS
00	<p>A scratch pad location that is a copy of the last valid instrument state before a memory store or recall operation. On power-on, it contains the instrument state when the power was turned off.</p> <p>If the last memory operation was store, location 00 contains the instrument state in the memory location that was written by the store operation. If the last memory operation was a recall or sequence, location 00 contains the instrument state before the recall operation. The entry <input type="text" value="RCL"/> <input type="text" value="0"/> <input type="text" value="0"/> can be thought of as an "undo" command for memory operations.</p>
01-50	Available for storage and recall of preset states of the Signal Generator.
51-95	Not used.
96	Holds the single parameter store and recall values. See the heading "Single Parameter Store and Recall" in this Section.
97	The Signal Generator Default Memory Location.
	All memory locations can be initialized to this setting with a Special Function command. See paragraph 4D-6 "Resetting Memory Locations" for more information. The Instrument Preset State is presented in Appendix A.
98	6060/6070 Compatibility Language Default Memory Location.
99	The current instrument state.

## STORING AND RECALLING INSTRUMENT STATES

4D-2.

Storage and recall of Signal Generator instrument states in nonvolatile memory locations is accomplished with the **STO** and **RCL** keys. Note that memory store and recall operations perform no action while digital sweep is active.

### SYNTAX:

#### Storing a Signal Generator Instrument State

1. The current instrument state is stored by pressing the **STO** key.

The last memory location stored or recalled is displayed in the FREQUENCY display field.

2. The DATA keys are used to enter the two-digit memory location code. The entered code must contain both digits (e.g., 01, 02, ...50).

The location code appears in the FREQUENCY display field as it is entered. When the second digit key of the location code is released, the store operation is performed. From Remote, the \*SAV command is used to store an instrument state.

#### Recalling a Signal Generator Instrument State

1. An instrument state is recalled by pressing the **RCL** key. The last memory location stored or recalled is displayed in the FREQUENCY display field.

2. Use the DATA keys to enter the memory location code of the desired instrument state. Again, the entered code must contain both digits of the two-digit memory location code. When the second digit key of the location code is released, the recall operation is performed. From Remote, the \*RCL command is used to recall an instrument state.

EXAMPLE: Recall the default memory location (97), program the RF Frequency to 6 MHz, and store it in memory location 06.

FRONT PANEL: **RCL** **9** **7** **FREQ** **6** **MHz V** **STO** **0** **6**

REMOTE: \*RCL 97; FREQ 6 MHZ; \*SAV 6

## RECALLING A SEQUENCE OF INSTRUMENT STATES

4D-3.

The following information describes the method for sequencing through memory locations containing the Signal Generator instrument states. Note that memory sequence operations perform no action while any digital sweep is active.

1. The  key allows the stored instrument states to be sequentially recalled. The sequence operation recalls the next higher memory location, starting from the most recent memory location stored or recalled. When the highest location is reached, the sequence starts over again at location 01. In remote, the SEQ UP command accomplishes the same result.
2. While  is pressed, the next memory location number is displayed and the memory location is recalled. While this key is pressed, the function continues to sequence up through memory locations.
3. The previous memory location may be recalled by entering  . This is equivalent to a sequence down function. While the  key is pressed, the function continues to sequence down through memory. The sequence down function "wraps" just as the sequence up function does. Entering   when the last location was location 01 recalls the highest available memory location. In remote, the SEQ DOWN command accomplishes the same result.

## DIVIDING MEMORY INTO PARTITIONS

4D-4.

Memory sequence dividers can be defined that partition the 50 memory locations into multiple subsets for sequence operations. Once defined, a memory divider sets an upper bound for sequence up operations and a lower bound for sequence down operations. From the front panel, the dividers are defined with a Special Function command; in remote, they are defined with the MEM\_DIVIDER command.

If no dividers have been defined, the sequence up operation sequences through every location and wraps around at location 50 back to location 01. The sequence down operation sequences down through every location and wraps around at location 01.

If, for example, a divider is defined at location 10, the memory locations are partitioned into two subsets (1-9 and 10-50). Note that the memory location corresponding to the divider location is included in the upper subset and is excluded from the lower subset.

Up to four memory dividers can be defined at once. Locations 01 and 50 are always used as the absolute boundaries regardless of the divider settings. Therefore, four dividers can provide up to five memory location subsets.

Entering     displays the current memory divider settings. The settings of all four of the dividers are displayed at once. Inactive dividers are displayed as location 00. If a numeric key is pressed while the divider settings are displayed, it is interpreted as a new divider entry, and the Signal Generator enters the memory divider entry mode.



Once in the memory divider entry mode, the Signal Generator expects settings for all four dividers to be entered before any are updated. Only numeric keys and the  key are allowed. All other keys immediately exit the entry mode and all partial entries are discarded. The  key skips to the next divider entry (if no partial entry has been made) to simplify the entry process if some of the dividers are to be changed but others are to be left unchanged. A divider is deleted when its location is specified as 00.

After all four divider settings have been updated, the entries are sorted and redisplayed for five seconds. The following example illustrates the memory divider setting display and the memory divider entry mode.

EXAMPLE: Current divider settings are 00, 00, 07, 22. Change the divider settings to 00, 07, 14, 31.

FRONT PANEL:

Enter    . The display shows:

00 00 07 22

To change divider #1 from 00 to 14 (entries will be sorted automatically), enter . The display shows:

d1 1\_ ?

Enter  to complete the entry. The display then shows divider #2:

d2 00 ?

Only three dividers are in use, so enter . The display then shows divider #3:

d3 07 ?

Leave this divider set to 07 by entering  again. The display then shows divider #4.

d4 22 ?

Enter . The display shows:

d4 3\_ ?

Enter . The display shows:

d4 31 ?

When the  key is released, the new divider settings are sorted and the display shows for five seconds:

00 07 14 31

Note that location 07 has moved from divider #3 to divider #2. Since the dividers are kept sorted, the actual divider number is not particularly important. However, the divider numbers do provide a way to uniquely identify each divider.

REMOTE: MEM\_DIVIDER 00,07,14,31

**FRONT PANEL OPERATION**  
**INSTRUMENT STATE MEMORY**

From the front panel, divider entries that are out of range are immediately rejected. To enter a valid divider following an erroneous entry, the entry process must be started over from the beginning. Duplicate divider entries are not checked as they are entered, but are eliminated during the sorting process.

**WRITE-PROTECTING MEMORY LOCATIONS** **4D-5.**

Memory locations 01 through 50 and 96 can be write-protected with a Special Function command from the front panel, or with the MEM\_LOCK command in remote. When enabled, all memory recall and sequence operations operate as usual, but memory store operations are rejected.

SYNTAX:

	FRONT PANEL	REMOTE
Disable Memory Lock	<input type="button" value="SPCL"/> <input type="button" value="8"/> <input type="button" value="1"/> <input type="button" value="0"/>	MEM_LOCK OFF
Enable Memory Lock	<input type="button" value="SPCL"/> <input type="button" value="8"/> <input type="button" value="1"/> <input type="button" value="1"/>	MEM_LOCK ON

**RESETTING ALL MEMORY LOCATIONS TO FACTORY DEFAULT** **4D-6.**

The contents of the 50 nonvolatile memory locations and memory locations 96 and 99 can be reset to the default memory location (97) with a Special Function command from the front panel as described below. (Memory location 97 is described in Appendix A, "Instrument Preset State".)

1. Entering     from the front panel causes the message "Sto ?" to appear in the FREQUENCY display field. (The remote command MEM\_RESET automatically resets all memory locations without displaying the "Sto ?" prompt.)
2. If the  key is pressed within 5 seconds, the memory contents are reset to the memory location default (97).
3. If the  key is not pressed within 5 seconds, or if any other key is pressed, memory locations are not changed.

**STORING AND RECALLING SINGLE PARAMETERS** **4D-7.**

A single function parameter may be stored or recalled individually without affecting the entire instrument state. This allows individual storage and recall of commonly used RF output frequency, RF amplitude, AM depth, FM/ $\phi$  deviation, modulation frequency and modulation level parameter values. The stored parameters are saved in memory location 96. This location is initialized to the instrument default state if no parameters have been stored.

Pressing the  key followed by a FUNCTION key stores the current value of the function parameter for later use. Pressing the  key followed by a FUNCTION key recalls only the specified parameter leaving all other Signal Generator parameters unchanged. For example, entering   saves the current RF output frequency. Entering   recalls the parameter value without affecting any other programmed functions.

The RF output frequency store and recall operations preserve the state of Relative Frequency Mode along with the offset and the reference value. Likewise, the RF amplitude store and recall operations preserve the state of Relative Amplitude Mode along with the offset and the reference value.

**SECURE MODE AND NONVOLATILE MEMORY ERASURE 4D-8.**

The Signal Generator provides a special operating mode, called secure mode, with the following properties:

1. If secure mode is enabled when the Signal Generator is powered off, nonvolatile memory is erased automatically when the Signal Generator is powered back on.
2. If secure mode is enabled, nonvolatile memory is erased automatically when secure mode is disabled.
3. If secure mode is enabled and the display is blanked, the display cannot be restored until secure mode is disabled.
4. Nonvolatile memory can be erased at any time, using a separate front panel Special Function or remote command, whether or not secure mode is enabled. Nonvolatile memory can be erased even if it has been write-protected.

*NOTE*

*When using secure mode, it is recommended that you allow power-on self-tests to run to completion so that in the event of a memory-erasing or other type of error, you see an error message on the display.*

**Enabling Secure Mode 4D-9.**

Secure mode is enabled via a front panel Special Function or a remote command. Enabling secure mode has no immediate effect on the contents of nonvolatile memory. If the display is blanked while secure mode is enabled, the word "SECURE" is displayed.

SYNTAX:

	FRONT PANEL	REMOTE
Disable Secure Mode	<div style="display: inline-block; border: 1px solid black; padding: 2px;">SPCL</div> <div style="display: inline-block; border: 1px solid black; padding: 2px; margin-left: 5px;">8</div> <div style="display: inline-block; border: 1px solid black; padding: 2px; margin-left: 5px;">2</div> <div style="display: inline-block; border: 1px solid black; padding: 2px; margin-left: 5px;">0</div>	SECURITY OFF
Enable Secure Mode	<div style="display: inline-block; border: 1px solid black; padding: 2px;">SPCL</div> <div style="display: inline-block; border: 1px solid black; padding: 2px; margin-left: 5px;">8</div> <div style="display: inline-block; border: 1px solid black; padding: 2px; margin-left: 5px;">2</div> <div style="display: inline-block; border: 1px solid black; padding: 2px; margin-left: 5px;">1</div>	SECURITY ON

**Erasing Nonvolatile Memory 4D-10.**

A Special Function is available to clear parameters from nonvolatile memory that could be used to determine previous instrument settings. The area of memory cleared includes the instrument state memory locations. The erase operation consists of the following steps:

1. Write 10101010 binary to each byte and read each byte back to verify its value.
2. Write 01010101 binary to each byte and read each byte back to verify its value.

**FRONT PANEL OPERATION**  
**INSTRUMENT STATE MEMORY**

3. Write the values 1 through 251 decimal to successive bytes, repeating the sequence to the end of the nonvolatile memory address space, then read and verify the entire sequence to verify correct operation of the address lines.
4. Write 00000000 binary to each byte and read each byte back to verify its value.

The previous four steps are repeated a minimum of 12 times, taking about 5 seconds to complete. The number of repetitions may be increased to a maximum of 99 using Special Function 828 or the remote command ERASE\_RPT.

Table 4D-3 shows parameters that are erased. Table 4D-4 shows parameters that are preserved. After affected parameters are cleared to 0, they are reset to factory default values.

If any byte fails verification, nonvolatile memory and the current instrument state are set to factory default values, the message "ErASE Err" is flashed on the display, an execution error is posted, secure mode is disabled, and the display is enabled.

**Table 4D-3. Erased Parameters**

Memory dividers
Memory protection status
Front panel key repeat rate
Alternate output correction data
Relative frequency status, base, and offset
Relative amplitude status, base, and offset
Trigger buffer
Protected user data (PUD) buffer
SRE
ESE
ISCE
Instrument state memory locations 00-50, 96, 99
Blank RF output during frequency range change setting
DCFM DAC used in high deviation ranges
DCFM DAC used in low deviation ranges
Sweep active status

**Table 4D-4. Preserved Parameters**

Operating time
Attenuator log
Serial number
IEEE address
IEEE mode
IEEE language
Rear output option status
Phase clock frequency
Alternate reference frequency selection
Calibration and compensation data
Low-noise external reference frequency selection
Erase repeat count

SYNTAX:

	FRONT PANEL	REMOTE
Erase Non-Volatile Memory	<input type="button" value="SPCL"/> <input type="button" value="8"/> <input type="button" value="2"/> <input type="button" value="9"/>	MEM_ERASE

**NOTE**

*After you enter Special Function 829 on the front panel, the instrument displays the Sto? prompt in the FREQUENCY field for 5 seconds. You have 5 seconds in which to press  to execute the memory erasure. If you do not press  within 5 seconds, the memory erase operation aborts. (When the remote command is used, the erase operation occurs immediately.)*

**Changing the Erase Operation Repeat Count**

**4D-11.**

To change the number of repetitions of the four-step erase operation from the default of 12 to a value from 12 to 99, use the following Special Function or remote command:

SYNTAX:

	FRONT PANEL	REMOTE
Display/Change Erase Repetitions	<input type="button" value="SPCL"/> <input type="button" value="8"/> <input type="button" value="2"/> <input type="button" value="8"/>	ERASE_RPT

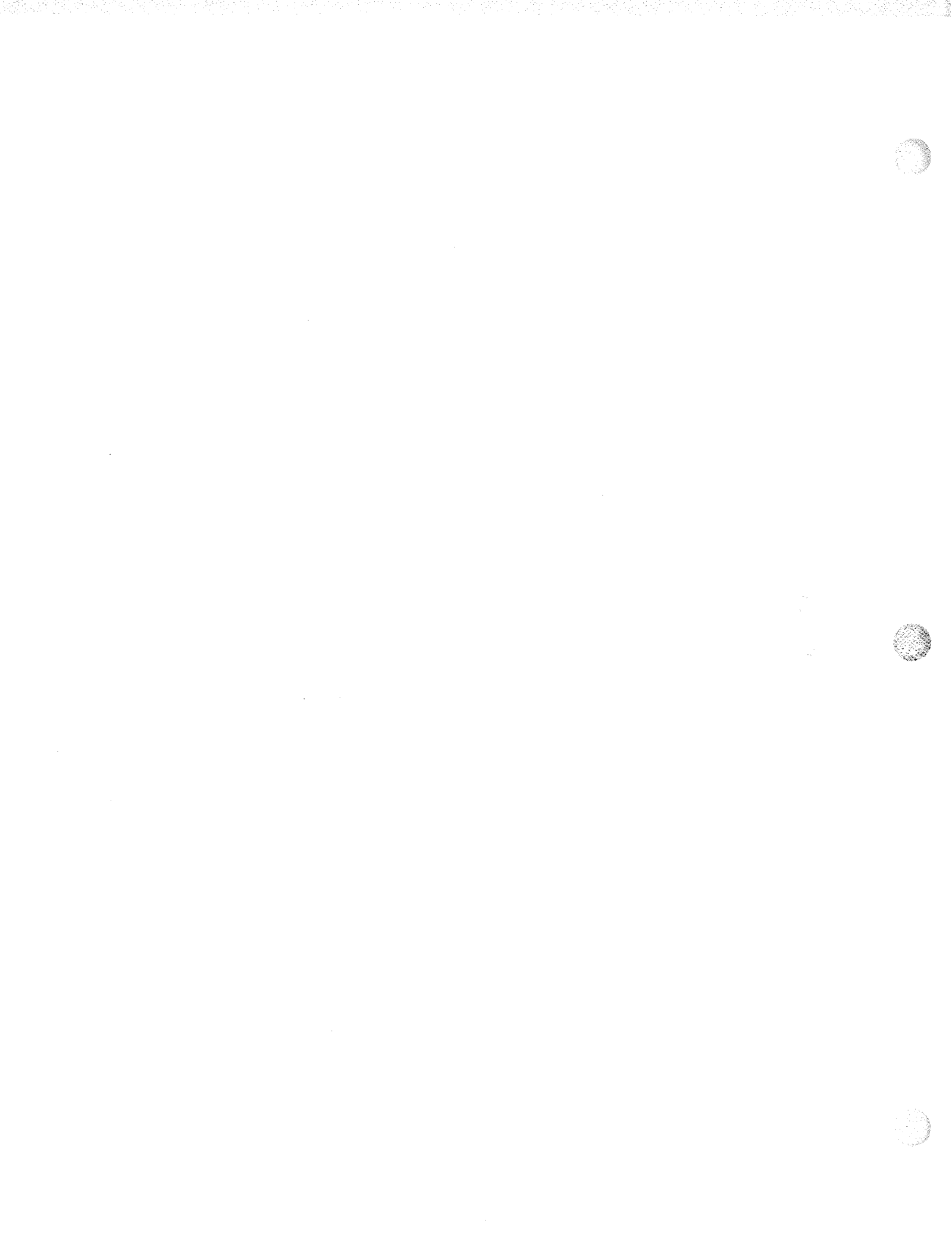

## Section 4E Sweep

### INTRODUCTION

4E-1.

The Signal Generator provides digital sweep capability for both RF output frequency and RF amplitude. Each has three modes of operation: auto sweep, manual sweep, and single sweep.

Auto digital sweep mode cycles continuously through the sweep range, with a selected dwell time at each discrete frequency or amplitude. The display reflects the center frequency or amplitude; the bright digit remains on. All numeric function entries are allowed while auto sweep is active.

Manual digital sweep mode increments and decrements within the sweep range with the edit knob, in units of the sweep increment. The display reflects the output (relative mode off) or offset (relative mode on) frequency or amplitude. The display bright digit is turned off, and any key entry that relies on the position of the bright digit is disallowed. This includes function selection, numeric entry, and units entry. All other front panel keys are allowed.

Single digital sweep mode runs through the sweep range once, with a selected dwell time at each discrete frequency or amplitude. The display is continuously updated to reflect the output (relative mode off) or offset (relative mode on) frequency or amplitude, with the bright digit off. Only the RF OUTPUT  ,  ,  and  keys are active.

When any mode of digital sweep is active, a 0 to 10V stepped output ramp is available at the rear panel AUX connector. This signal is an analog of the progress of the sweep. A TTL-level pulse is available on this connector for X-Y recorder pen lift control or for oscilloscope Z-axis blanking. When an auto or single sweep reaches the end of its range, the signal is driven high for a 100 millisecond (minimum) pulse. See Appendix F for the AUX connector pinout diagram.

In all sweep modes, memory store and recall operations (the  ,  , and  keys) are disallowed. If the Signal Generator is powered off while any sweep is active, the active sweep is terminated, and the power-down memory location (location 00) is programmed to the center frequency or amplitude.

## SELECTING FREQUENCY OR AMPLITUDE SWEEP

4E-2.

Selection of frequency sweep or amplitude sweep from the front panel is performed by pressing the desired function key, followed by either sweep parameter. No numeric entry or unit entry is necessary to change the sweep field. The SWEEP\_FIELD command selects the desired function from Remote. The selected function has the SWP annunciator lit in its display field. This operation ties the selected function (frequency or amplitude) to the sweep mode controls, but does not activate any of the sweep modes (auto, manual, or single). The sweep field may not be changed while a sweep is active.

SYNTAX:

	FRONT PANEL	REMOTE
Select Frequency Sweep	<div style="display: flex; justify-content: space-around;"> <div style="border: 1px solid black; padding: 2px;">FREQ</div> <div style="border: 1px solid black; padding: 2px;">SWEEP WIDTH</div> </div> <p style="text-align: center;">OR</p> <div style="display: flex; justify-content: space-around;"> <div style="border: 1px solid black; padding: 2px;">FREQ</div> <div style="border: 1px solid black; padding: 2px;">SWEEP INCR</div> </div>	SWEEP_FIELD FREQ
Select Amplitude Sweep	<div style="display: flex; justify-content: space-around;"> <div style="border: 1px solid black; padding: 2px;">AMPL</div> <div style="border: 1px solid black; padding: 2px;">SWEEP WIDTH</div> </div> <p style="text-align: center;">OR</p> <div style="display: flex; justify-content: space-around;"> <div style="border: 1px solid black; padding: 2px;">AMPL</div> <div style="border: 1px solid black; padding: 2px;">SWEEP INCR</div> </div>	SWEEP_FIELD AMPL

## SUMMARY OF SWEEP MODES

4E-3.

From the front panel, Auto and Manual Sweep Mode are enabled and disabled by pressing keys located in the SWEEP ON/OFF section, while Single Sweep is enabled with a Special Function command. In remote, the SWEEP command selects a Sweep Mode.

The sweep on/off keys operate as toggle functions; the key enables a sweep mode is pressed again to disable the mode. For example, pressing the **AUTO** key once enables the auto sweep mode and pressing the **AUTO** key again turns off the auto sweep. The same holds true for the **MANUAL** key. Since the single sweep mode is enabled by Special Function and terminates automatically, no direct toggle capability is provided. However, pressing either the **AUTO** or **MANUAL** key twice terminates a single sweep. From Remote, the SWEEP OFF command turns off any active sweep.

If **MANUAL** is pressed while a single or auto sweep is active, the manual sweep mode is entered precisely at the point in the sweep range where the Signal Generator was at the time the key was pressed. This allows the neighborhood of a particular frequency or amplitude in the sweep range to be examined in greater detail. If **AUTO** or **SPCL** **8** **8** **2** is pressed again, the sweep resumes from the last point where it was left in the manual sweep.

SYNTAX:

	FRONT PANEL	REMOTE
Initiate Auto Sweep	<b>AUTO</b>	SWEEP AUTO
Initiate Manual Sweep	<b>MANUAL</b>	SWEEP MANUAL
Initiate Single Sweep	<b>SPCL</b> <b>8</b> <b>8</b> <b>2</b>	SWEEP SINGLE
Terminate Sweep	<b>AUTO</b> if AUTO on <b>MANUAL</b> if MANUAL on	SWEEP OFF



NOTE

*Enabling frequency sweep on the 6082A while AM is enabled may cause the amplitude band switch points to change. See "RF Output Amplitude Bands" in Section 4B for details.*

**SELECTING SYMMETRIC OR ASYMMETRIC SWEEP**

**4E-4.**

Both symmetric (sweep range is evenly centered about displayed frequency or amplitude) and asymmetric sweep (displayed frequency or amplitude is an endpoint of the sweep range) are selectable with a Special Function command from the front panel. In remote, the SWEEP\_SYM command is used. When asymmetric sweep is selected the ASYM annunciator is lit. If a selection is made that would cause an invalid sweep range while a sweep is active, the entry is rejected.

SYNTAX:

	FRONT PANEL	REMOTE
Select Symmetric Sweep	SPCL 8 8 0	SWEEP_SYM SYMM
Select Asymmetric Sweep	SPCL 8 8 1	SWEEP_SYM ASYM

**SETTING SWEEP DWELL TIME**

**4E-5.**

The time that an active auto or single sweep dwells at each discrete frequency or amplitude in the sweep range can be adjusted. This dwell time is in addition to the nominal switching time for frequency and amplitude. One of six different minimum dwell times can be selected with a Special Function command from the front panel, or with the SWEEP\_DWELL command in remote. The selected dwell time remains in effect for all subsequent sweep modes.

SYNTAX:

	FRONT PANEL	REMOTE
Select 0 ms Dwell	SPCL 8 9 0	SWEEP_DWELL 0 MS
Select 20 ms Dwell	SPCL 8 9 1	SWEEP_DWELL 20 MS
Select 50 ms Dwell	SPCL 8 9 2	SWEEP_DWELL 50 MS
Select 100 ms Dwell	SPCL 8 9 3	SWEEP_DWELL 100 MS
Select 200 ms Dwell	SPCL 8 9 4	SWEEP_DWELL 200 MS
Select 500 ms Dwell	SPCL 8 9 5	SWEEP_DWELL 500 MS
Select 1s Dwell	SPCL 8 9 6	SWEEP_DWELL 1 S
Select 2s Dwell	SPCL 8 9 7	SWEEP_DWELL 2 S
Select 5s Dwell	SPCL 8 9 8	SWEEP_DWELL 5 S
Select 10s Dwell	SPCL 8 9 9	SWEEP_DWELL 10 S

## FREQUENCY SWEEP

4E-6.

The Signal Generator allows digital frequency sweep between any two valid frequencies with a resolution of 1 Hz per increment.

Four parameters define the sweep:

- The RF output frequency in effect before the sweep is enabled becomes the center frequency if symmetric sweep is selected, or the start frequency if asymmetric sweep is selected. It is generically called the center frequency ( $F_c$ ).
- The frequency sweep width ( $F_w$ ) is the total width of the sweep and may be either a positive or a negative quantity.
- The frequency sweep increment ( $F_i$ ) is the increment size and must be a positive quantity. The sweep increment may be larger than the absolute value of the sweep width.
- Sweep symmetry is selected by Special Function, as described in the under the heading "Digital Sweep Symmetry".

The following equations show the relationship of these parameters.

### NOTE

*The progression of the sweep is always from F1 to F2. (Fw can be negative.)*

Symmetric sweep: ASYM annunciator is off.

$$F1 = \text{start frequency} = F_c - F_w/2$$

$$F2 = \text{end frequency} = F_c + F_w/2$$

Asymmetric sweep: ASYM annunciator is lit.

$$F1 = \text{start frequency} = F_c$$

$$F2 = \text{end frequency} = F_c + F_w$$

Some sweep parameters may be changed while sweep is active. Any parameter change that would result in an invalid sweep condition is rejected, and the sweep continues with the existing sweep parameters. If an attempt is made to start a sweep with such a combination of parameters, the sweep mode selection is rejected.

During auto sweep, both sweep width and sweep increment can be inspected and modified, and the center frequency can be modified, edited, or stepped. If the entry is valid, the new sweep range or increment takes effect immediately for the sweep. These parameters cannot be displayed or changed during manual or single sweep, although the center frequency may be stepped during manual sweep. Sweep symmetry may be changed at any time (so long as the resulting sweep range is valid) for auto or manual sweep. Sweep symmetry may not be changed while a single sweep is active.

A sweep in relative mode is possible by enabling relative frequency mode before entering a sweep. However, relative mode may not be enabled or disabled while a sweep is active.

### Setting Frequency Sweep Width

4E-7.

The frequency sweep width can be selected for entry by first pressing the **FREQ** key to select the FREQUENCY display field, then pressing the **SWEEP WIDTH** key. Upon programming a new sweep width, the value is held momentarily in the FREQUENCY display field. A negative sweep width can be entered; this causes the Signal Generator to sweep in the reverse direction, that is, starting at the high frequency and proceeding towards the low frequency.

#### FREQUENCY SWEEP WIDTH

	RANGE	RESOLUTION
6080A	$\pm 1$ Hz to $\pm 1056$ MHz	1 Hz
6082A	$\pm 1$ Hz to $\pm 2112$ MHz	1 Hz

SYNTAX:

**FREQ** **SWEEP WIDTH** -- numeric data -- **MHz|V**  
**kHz|mV**  
**Hz| $\mu$ V**

EXAMPLE: Set Frequency Sweep Width to 230 MHz

FRONT PANEL: **FREQ** **SWEEP WIDTH** **2** **3** **0** **MHz|V**

REMOTE: `FREQ_SWIDTH 230 MHZ`

### Setting Frequency Sweep Increment

4E-8.

The frequency sweep increment can be selected for entry by first pressing the **FREQ** key, to select the FREQUENCY display field, then pressing the **SWEEP INCR** key. Upon programming a new sweep increment, the new value is held momentarily in the FREQUENCY display field.

#### FREQUENCY SWEEP INCREMENT

	RANGE	RESOLUTION
6080A	1 Hz to 1056 MHz	1 Hz
6082A	1 Hz to 2112 MHz	1 Hz

SYNTAX:

**FREQ** **SWEEP INCR** -- numeric data -- **MHz|V**  
**kHz|mV**  
**Hz| $\mu$ V**

EXAMPLE: Set Frequency Sweep Increment to 230 MHz

FRONT PANEL: **FREQ** **SWEEP INCR** **2** **3** **0** **MHz|V**

REMOTE: `FREQ_SINCR 230 MHZ`

## Digital Frequency Sweep Example

4E-9.

EXAMPLE: Configure a digital frequency sweep From: 500 MHz to 540 MHz, with a sweep increment of 100 kHz and a dwell of 0 ms at each point. Enable Single sweep for this configuration.

1. Select 520 MHz RF frequency

FRONT PANEL:

REMOTE: FREQ 520 MHZ

2. Select 40 MHz frequency sweep width and select frequency as the active sweep field

FRONT PANEL:

REMOTE: FREQ\_SWIDTH 40 MHZ ; SWEEP\_FIELD FREQ

3. Select 100 kHz frequency sweep increment

FRONT PANEL:

REMOTE: FREQ\_SINCR 0.1 MHZ

4. Select symmetric sweep

FRONT PANEL:

REMOTE: SWEEP\_SYM SYMM

5. Select 0 ms sweep dwell time

FRONT PANEL:

REMOTE: SWEEP\_DWELL 0 MS

6. Enable single sweep

FRONT PANEL:

REMOTE: SWEEP SINGLE

## AMPLITUDE SWEEP

4E-10.

The Signal Generator allows both digital linear and digital logarithmic amplitude sweep. If all amplitude sweep parameters are specified in linear (voltage) quantities, the sweep will be digital linear. If all amplitude sweep parameters are specified in logarithmic (dBm, dBmV, dB $\mu$ V or dBf) quantities, the sweep will be digital logarithmic.

Four parameters define the sweep:

- The RF amplitude in effect before the sweep is enabled becomes the Center Amplitude if symmetric sweep is selected, or the start amplitude if asymmetric sweep is selected. It is generically called the Center Amplitude ( $A_c$ ).
- The amplitude sweep width ( $A_w$ ) is the total width of the sweep and may be either a positive or a negative quantity.

- The amplitude sweep increment ( $A_i$ ) is the increment size and must be a positive quantity. The sweep increment may be larger than the absolute value of the sweep width.
- Sweep symmetry is selected by Special Function.

The following equations show the relationship of these parameters.

*NOTE*

*The progression of the sweep is always from A1 to A2. "Aw" can be negative.*

Symmetric sweep: ASYM annunciator is off.

$$A1 = \text{start amplitude} = A_c - A_w/2$$

$$A2 = \text{end amplitude} = A_c + A_w/2$$

Asymmetric sweep: ASYM annunciator is lit.

$$A1 = \text{start amplitude} = A_c$$

$$A2 = \text{end amplitude} = A_c + A_w$$

Certain sweep parameters may be changed while sweep is active. Any parameter change that would result in an invalid sweep condition is rejected and the sweep continues with the existing sweep parameters. If an attempt is made to start a sweep with such a combination of parameters, the sweep mode selection is rejected.

During auto sweep, sweep width and sweep increment can be inspected and modified, the center amplitude can be edited or stepped, and sweep symmetry may be changed. If the entry is valid, the new sweep range or increment takes effect immediately. With the exception of stepping the center amplitude during manual sweep, these parameters cannot be displayed or changed during manual or single sweep.

The center amplitude, sweep width, and sweep increment must all have consistent units (dB or volts). If these parameters have inconsistent units, the amplitude sweep will be rejected when a sweep mode (auto, manual, or single) is enabled. Likewise, the units of the sweep parameters may not be converted while amplitude sweep is active.

A sweep in relative mode is possible by enabling relative amplitude mode before entering a sweep. However, relative mode may not be enabled or disabled while a sweep is active.

The maximum sweep width in either logarithmic or linear mode is restricted to 20 dB (approximately a 10:1 ratio). Furthermore, when in linear mode, the ratio of the maximum output voltage in the amplitude sweep to the sweep increment cannot exceed 999.

### Setting Amplitude Sweep Width

4E-11.

The amplitude sweep width can be selected for entry by first pressing the **AMPL** key to select the AMPLITUDE display field, then pressing the **SWEEP WIDTH** key. When a new sweep width is programmed, the value is held momentarily in the AMPLITUDE display field. A negative sweep width can be entered; this causes the Signal Generator to sweep in the reverse direction, that is, starting at the larger amplitude and proceeding towards the smaller amplitude.

AMPLITUDE SWEEP WIDTH	
RANGE	RESOLUTION
$\pm 0.1$ dB to $\pm 20$ dB	0.1 dB
$\pm 10$ nV to $\pm 2.24$ V	3 digits

SYNTAX:

**AMPL** **SWEEP WIDTH** -- numeric data -- **dB(m)**  
**MHz|V**  
**kHz|mV**  
**Hz| $\mu$ V**

EXAMPLE: Set Amplitude Sweep Width to 12 dB

FRONT PANEL: **AMPL** **SWEEP WIDTH** **1** **2** **dB(m)**

REMOTE: AMPL\_SWIDTH 12 DB

### Setting Amplitude Sweep Increment

4E-12.

The amplitude sweep increment can be selected for entry by first pressing the **AMPL** key to select the AMPLITUDE display field, then pressing the **SWEEP INCR** key. Upon programming a new sweep increment, the new value is held momentarily in the AMPLITUDE display field.

AMPLITUDE SWEEP INCREMENT	
RANGE	RESOLUTION
0.1 to +20 dB	0.1 dB
10 nV to 2.24 V	3 digits

SYNTAX:

**AMPL** **SWEEP INCR** -- numeric data -- **dB(m)**  
**MHz|V**  
**kHz|mV**  
**Hz| $\mu$ V**

EXAMPLE: Set amplitude sweep increment to 0.5 dB

FRONT PANEL: **AMPL** **SWEEP INCR** **0** **.** **5** **dB(m)**

REMOTE: AMPL\_SINCR 0.5 DB

## Digital Amplitude Sweep Example

4E-13.

EXAMPLE: Configure a digital amplitude sweep from -20.0 dBm to -15.0 dBm, with a sweep increment of 0.1 dB and a dwell of 100 ms at each point. Enable Auto sweep for this configuration.

1. Select -20.0 dbm RF amplitude

FRONT PANEL:

REMOTE: AMPL -20 DBM

2. Select 5 dB amplitude sweep width and select amplitude as the active sweep field

FRONT PANEL:

REMOTE: AMPL\_SWIDTH 5 DB ; SWEEP\_FIELD AMPL

3. Select 0.1 dB amplitude sweep increment

FRONT PANEL:

REMOTE: AMPL\_SINCR 0.1 DB

4. Select asymmetric sweep

FRONT PANEL:

REMOTE: SWEEP\_SYM ASYM

5. Select 100 ms sweep dwell time

FRONT PANEL:

REMOTE: SWEEP\_DWELL 100 MS

6. Enable auto sweep

FRONT PANEL:

REMOTE: SWEEP AUTO

## CALIBRATING A RECORDER OR OSCILLOSCOPE

4E-14.

To calibrate an X-Y plotter/recorder or oscilloscope to the Signal Generator X-axis (sweep DAC) output and the blanking/pen lift signals, use the following procedure:

1. Set the X-axis output to 0 volts:

Enable manual sweep and turn the edit knob to the start frequency (F1) or the start amplitude (A1).

2. Set the X-axis output to +10 volts:

Enable manual sweep and turn the edit knob to the end frequency (F2) or the end amplitude (A2).

The blanking/pen lift signal is maintained "low" for the above conditions; it is maintained "high" if no sweep is active.

## ANALOG FREQUENCY SWEEP

4E-15.

It is possible to configure the Signal Generator FM circuitry to perform an analog frequency sweep that is symmetric about the RF output frequency. This mode is entirely controlled by the programmed modulation parameters and is not related to the synthesized digital sweep.

Three parameters must be configured to perform an analog frequency sweep:

- The sweep rate, determined by the modulation frequency.

At lower modulation frequencies, it may be necessary to enable Low Rate FM or External DC FM. See Section 4C, "Modulation" for more information.

- The programmed FM deviation (one-half of the sweep width).

The maximum FM deviation allowed depends on the RF output frequency. See Section 4C, "Modulation" for more information.

The following equations determine the start and end frequencies:

$$F1 = \text{start frequency} = \text{RF output frequency} - \text{FM deviation}$$

$$F2 = \text{end frequency} = \text{RF output frequency} + \text{FM deviation.}$$

- The triangle internal modulation waveform must be selected.

See Section 4C, "Modulation" for more information.

Once internal FM is enabled, the RF output frequency sweeps from F1 to F2, then back down to F1 each period (period = 1/Modulation Frequency).



EXAMPLE: Configure an analog frequency sweep from 199.5 MHz to 200.5 MHz, with a sweep rate of 100 Hz.

1. Select 200-MHz RF frequency

FRONT PANEL:

REMOTE: FREQ 200 MHz

2. Select 100-Hz modulation frequency

FRONT PANEL:

REMOTE: MODF 100 Hz

3. Select 1 MHz FM deviation

FRONT PANEL:

REMOTE: FM 1 MHz

4. Select triangle internal modulation waveform

FRONT PANEL:

REMOTE: MOD\_WAVE TRIANGLE

5. Enable internal FM modulation

FRONT PANEL:

REMOTE: INT\_FM ON

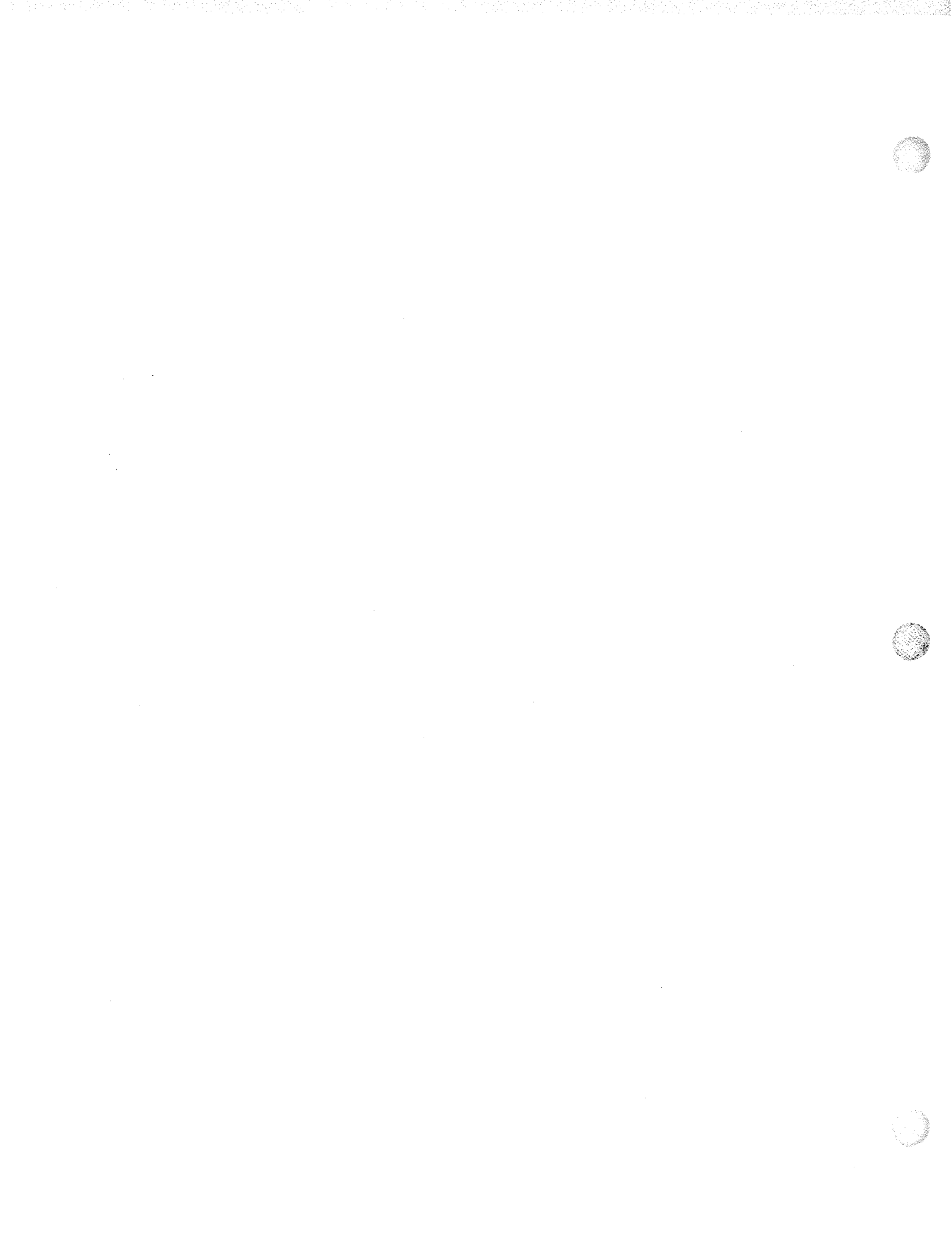

# Section 4F

## Special Functions

### INTRODUCTION

4F-1.

Special Functions are divided into three functional groups:

- Stored mode
- Immediate action
- Hidden parameter display/entry.

All are activated by pressing the  key followed by either a two- or three-digit numeric code.

Stored-mode Special Functions change a specific operating mode of the Signal Generator. Examples are RF output frequency Relative mode, Low-rate FM mode, and High-rate  $\phi$ M mode. All of the active stored-mode Special Function numeric codes can be viewed by pressing the  key.

Each of the stored-mode Special Functional groups is allocated a decade of Special Function numeric codes. For example, Relative RF output frequency OFF/ON is 20/21, low-rate FM OFF/ON is 710/711, and High-rate  $\phi$ M OFF/ON is 720/721. The unit digit of the code determines whether functions of this type are off or on (0 = OFF, 1 = ON). The Signal Generator's default, preset state forces these functions to the OFF state, except for the display, which is on by default.

Most enabled stored-mode functions are cleared with Special Function 00.

Some of the stored-mode functions have more than two choices. For example, there are 10 selections (890 through 899) for sweep dwell time, and three selections (750 through 752) for the internal modulation waveform. Again, the unit digit of the code determines the selection within the decade, with the zero-state the default state.

Immediate-action Special Functions typically perform an immediate action without affecting the stored state of the Signal Generator. Examples of immediate-action functions are commands to display the software revision level and execute self tests. Since immediate-action functions do not change the stored state of the Signal Generator, their Special Function numbers are not allocated in decades.

Hidden-parameter Special Functions let you display and modify Signal Generator parameters not normally displayed on the front panel. These Special Functions are used primarily when a parameter is programmable to a wide range of values. When you select a hidden-parameter Special Function, the instrument displays the current value

**FRONT PANEL OPERATION  
SPECIAL FUNCTIONS**

of the parameter with a question mark prompt. You have a brief period of time in which to enter a new value. If you do not enter a new value, the display returns to normal format and the parameter is unchanged.

Table 4F-1 lists Special Function codes by action. Appendix B list all Special Function codes.

**Table 4F-1. Special Function Codes**

SPECIAL FUNCTION DESCRIPTION	FRONT PANEL	REMOTE COMMAND	LIGHTS SPCL ANNUNCIATOR WHEN ENABLED
<b>FREQUENCY</b>			
Relative frequency mode	20,21	FREQ_REL	
Enable phase adjustment	701	PHASE	
Zero phase adjustment	702	PHASE_ZERO	
External reference input frequency	760,761	EXTREF_FREQ	
Low-noise external reference	950,951	LOWNOISE	
<b>AMPLITUDE</b>			
Relative amplitude mode	30,31	AMPL_REL	
Fixed-range amplitude	50,51	AMPL_RANGE	*
Amplitude display units	840-843	AMPL	
EMF-Volts amplitude display mode	850,851	AMPL_EMFOUT	
<b>MODULATION</b>			
Modulation oscillator output	40,41	MODOUT	*
Enter modulation frequency to 0.1 Hz	42	MODF	
Low-rate FM	710,711	LORATEFM	*
High-rate FM	720,721	HIRATEPM	*
Low-distortion/fixed-range FM	730-732	FM_RANGE	*
Internal pulse modulation	740,741	INT_PULSE	
Modulation oscillator waveform	750-752, 758	MOD_WAVE	*
Enter pulse width	759	PULSE_WIDTH	
<b>SWEEP</b>			
Sweep dwell time	890-899	SWEEP_DWELL	
Sweep symmetry	880,881	SWEEP_SYM	
Initiate single sweep	882	SWEEP_SINGLE	
<b>INSTRUMENT STATE MEMORY</b>			
Reset memory locations	801	MEM_RESET	
Display/Set memory sequence dividers	802	MEM_DIVIDER	
Write-protect memory locations	810,811	MEM_LOCK	
Nonvolatile memory erase repeat count	828	ERASE_RPT	
Erase nonvolatile memory	829	MEM_ERASE	
<b>REMOTE</b>			
Display/Set IEEE-488 address	10	n/a	
Display/Set IEEE-488 address mode	11	n/a	
Display/Set IEEE-488 language	12	GAL	
Display/Enter service request mask	13	*SRE	
Set user request SRQ	14	n/a	
Clear SRQ	15	n/a	

Table 4F-1. Special Function Codes (cont)

SPECIAL FUNCTION DESCRIPTION	FRONT PANEL	REMOTE COMMAND	LIGHTS SPCL ANNUNCIATOR WHEN ENABLED
<b>MISCELLANEOUS</b>			
Clear all special functions	00	SPCL 00	
Restore Instrument Preset State	01	SPCL 01	
Initiate power-on self tests	02	*TST?	
Display self test results	03	STATUS	
Display option loading status	08	*OPT?	
Display software revision level	09	*IDN?	
Disable display	770,771	DISPLAY	
Frequency blanking	780,781	FREQ_BLANK	
Enable secure mode	820,821	SECURITY	*
Step key repeat rate	860-862	KEY_RATE	
Knob and step key operation	870-873	KNOB_STEP	*
<b>SERVICE</b>			
Amplitude compensation	920-922	AMPL_COMP	*
Output compensation data	930,931	AMPL_CMPDAT	
See Service Manual for Others			

## ENABLING SPECIAL FUNCTIONS

### 4F-2.

The Special Function code is a two- or three-digit number. Special Functions 00 through 19 perform an immediate action. Special functions 20 through 59 and 600 through 999 change the instrument state. The first digit of a Special Function indicates its classification, and the second digit defines it. A Special Function executes when you enter the last digit of its code.

#### SYNTAX:

<n> = 0..9:

Special Functions 00 through 59  <n> <n>

Special Functions 600 through 999  <n> <n> <n>

## VIEWING ENABLED SPECIAL FUNCTIONS

### 4F-3.

A list of the active stored-mode Special Functions is displayed while the  key is pressed. A Special Function is defined as active, and its code is displayed, only when it is programmed to a state other than its default state. If all Special Functions are in their default or OFF state, the code 00 is displayed.

Up to four Special Function codes are displayed at a time. If more than four Special Functions are active, repeatedly pressing the  key scrolls through the list. For more information on the operation of the Special Function status display, see Section 4G, "Error and Status Reporting".

## **THE SPCL ANNUNCIATOR**

**4F-4.**

Several Special Functions enable operating modes that cause a distinct change to the state of the Signal Generator, but do not have a dedicated annunciator in the display. The SPCL annunciator in the FREQUENCY display field is lit when any of these special operating modes are enabled.

In addition, the SPCL annunciator is lit for Special Functions for which there is a dedicated annunciator, but are context dependent. For example, enabling the low-rate FM Special Function lights the SPCL annunciator immediately, but the LO RATE annunciator is lit only if Internal or External FM is also enabled.

## **MISCELLANEOUS SPECIAL FUNCTIONS**

**4F-5.**

### **Disable Special Functions**

**4F-6.**

Enabled stored-mode Special Functions except Secure Mode can be cleared with Special Function 00.

### **Restore Instrument Preset State**

**4F-7.**

Enabled stored-mode Special Functions can also be cleared with Special Function 01. This function recalls memory location 97 clears all sweep modes and cal/comp procedures. The scope of Special Function 01 is detailed in Appendix A.

### **Execute Self-Test and Display Self-Test Results**

**4F-8.**

The Signal Generator performs self-tests of its digital and analog hardware at power-on or by Special Function. Self-tests can be run at any time with Special Function 02.

The test sequence can be terminated immediately by pressing any front panel key. At the end of the test sequence, the Signal Generator assumes the power-on-state. Numeric error codes are displayed if one or more of the self tests failed. If the tests were aborted with a key entry, error code 301 is displayed to indicate that the tests were not run to completion.

The results of the self-tests can be displayed with Special Function 03. See Appendix E for the status codes and their explanations.

For safety (for example where an amplifier is attached to the Signal Generator), self tests are run without energizing the RF output. To run self-tests that include energizing the RF output, use Special Function 06.

### **Display Loaded Options**

**4F-9.**

Special Function 08 causes the loaded instrument options to be displayed for approximately 5 seconds or until another key is pressed.

### **Display Instrument ID and Software Revision Level**

**4F-10.**

Special Function 09 causes the instrument ID and software revision level to be displayed for approximately 5 seconds or until another key is pressed.



**Blank Front Panel Display**

**4F-11.**

The front panel display can be blanked with Special Function 771. This Special Function blanks the display and disables the edit knob. Special Function 770 restores the display and functionality of the knob.

**Select Repeat Rate for Step Keys**

**4F-12.**

The repeat rate for the front panel step  and  keys is selected with Special Functions 860 through 862. The default repeat rate for the step keys is medium, corresponding to Special Function 860. Special Function 861 selects a fast repeat rate, while Special Function 862 selects a slow repeat rate.

**Configure Edit Knob and Step Keys**

**4F-13.**

The front panel edit knob can be disabled and the functional role of the step increment/decrement keys and the edit knob can be modified with Special Functions 871 through 873 (see Table 4F-2). With Special Function 871, the bright digit remains displayed even though edit operations are disabled.

**Table 4F-2. Functions of Edit Knob and Step Keys**

SPECIAL FUNCTION KEYS	EDIT KNOB	STEP INCREMENT/DECREMENT
870	Enabled	Enabled as step
871	Disabled	Enabled as step
872	Enabled	Enabled as edit
873	Disabled	Enabled as edit





## Section 4G

# Error and Status Reporting

### GENERAL DESCRIPTION

4G-1.

There are five types of status information that the Signal Generator generates:

- Rejected Entry Errors
- Instrument Overrange/Uncal Status
- Self-Test Status
- Calibration/Compensation Data Checksum Status
- Calibration/Compensation Data Origin Status

The rejected entry annunciator REJ ENTRY is flashed whenever a front panel or Remote entry is rejected. Numeric data in one of the display fields may also flash to indicate the rejected value. Any function key may be pressed to clear the flashing entry and the REJ ENTRY annunciator.

The STATUS annunciator is lit but not flashed to indicate when the Signal Generator is operating outside its specified performance range. If abnormal operation or aberrated output occurs, the STATUS annunciator is flashed to emphasize the severity of the problem.

Since there is never more than one rejected entry error at a time, rejected entry errors are always given precedence over the status codes. To avoid ambiguity, the STATUS annunciator is always turned off when the rejected entry annunciator is flashing.

The Self-Test Status and Calibration/Compensation Data Status are not presented in the normal operation of the Signal Generator. A Special Function command displays the active status codes for these conditions.

### THE STATUS KEY

4G-2.

When the REJ ENTRY annunciator is flashing, pressing the **STATUS** key displays the Rejected Entry Error Code; when the STATUS annunciator is flashing or lit, pressing the **STATUS** key displays the Overrange or Uncal Status Codes. These codes provide detailed information on the nature of the rejected entry or status condition.

To avoid ambiguity, every Rejected Entry, Overrange/Uncal, Self-Test and Calibration Compensation memory condition has a unique status code. These codes are organized numerically to facilitate their interpretation, as shown in Table 4G-1.

A numeric list and explanation of all of the error and status codes is presented in Appendixes C, D, and E.

Table 4G-1. Interpreting Status Codes

ERROR/STATUS CODE	INTERPRETATION
00	No Errors or Status
01 to 199	Rejected Entry Errors
201 to 299	Instrument Overrange or Uncal Status
301 to 399	Self-Test Status
401 to 499	Calibration/Compensation Data Checksum Status
501 to 599	Calibration/Compensation Data Origin Status

When the front panel REJ ENTRY annunciator is flashing, pressing the **STATUS** key displays a numeric code, in the MODULATION display field, indicating the specific reason why the entry was rejected. In remote, the ERROR? command is used to query errors.

When the front panel STATUS annunciator is lit or flashing, pressing the **STATUS** key displays one or more numeric codes detailing the set of overrange or uncal conditions. In remote, the STATUS? command is used to query status.

Up to four codes can be displayed at a time. If more than four status codes are active, repeatedly pressing the **STATUS** key will scroll through the active codes. Only three codes at a time are displayed when the active list is scrolled through. Three dots appear in the fourth (rightmost) field to indicate that there are additional codes.

**DISPLAYING SELF-TEST STATUS AND CALIBRATION/  
 COMPENSATION DATA**

**4G-3.**

Self-Test, Calibration/Compensation Data Checksum, and Origin status codes can also be displayed. Each set of status codes are displayed with a Special Function and scrolled using the **STATUS** key like the overrange/uncal status codes. In remote, the STATUS command is used to load the status queue with the requested information, and the STATUS? command is used to query the status. The Calibration/Compensation Data Checksum and Origin Status codes are described in the Signal Generator Service Manual.

SYNTAX:

	FRONT PANEL	REMOTE
Display/Load Overrange /Uncal Status	<b>STATUS</b>	STATUS UNCAL STATUS?
Display/Load Self Test Status	<b>SPCL</b> <b>0</b> <b>3</b> <b>STATUS</b>	STATUS SELFTEST STATUS?
Display/Load Cal/Comp Data Checksum Status	<b>SPCL</b> <b>0</b> <b>4</b> <b>STATUS</b>	STATUS CHECKSUM STATUS?
Display/Load Cal/Comp Data Origin Status	<b>SPCL</b> <b>0</b> <b>5</b> <b>STATUS</b>	STATUS ORIGIN STATUS?

# Section 5

## Remote Operation

### INTRODUCTION

5-1.

The Signal Generator operates directly from the front panel controls or under remote control of an instrument controller or computer. The following sections describe how to connect, configure, and operate the Signal Generator in the remote mode.

The Signal Generator is fully programmable for use on the IEEE Standard 488.1 interface bus (IEEE-488 bus). The interface also complies with supplemental standard IEEE-488.2. Devices connected to the bus in a system are designated as talkers, listeners, talker/listeners, or controllers. Under the remote control of an instrument controller such as the Fluke 1722A, the Signal Generator operates exclusively as a talker/listener on the IEEE-488 bus. This operation is described in Section 5A, "Remote Programming". The programming commands are listed in Section 5B, "Remote Command Tables".

For an introduction to the basics of the IEEE-488 interface bus, request Fluke Application Bulletin AB-36, "IEEE Standard 488-1978 Digital Interface for Programmable Instrumentation."

The Signal Generator can also be operated on the IEEE-488 bus without an instrument controller in a talk-only or listen-only mode. In this mode, two Signal Generators can be configured to track each other in operation. This mode is described in Section 5C, "Listen-Only/Talk-Only Operation".

The Signal Generator internal software includes compatibility languages for emulating Fluke Models 6060A, 6060B, 6061A, 6062A, 6070A, and 6071A, and Hewlett Packard Models 8642A or B. This capability allows substituting a 6080A or 6082A for one of the above instruments in an existing system, with no, or in some cases minor, software modifications. These compatibility languages are described in Section 5D, "Compatibility Languages".

### SETTING UP THE IEEE-488 INTERFACE

5-2.

The Signal Generator is set at the Fluke factory to operate in the normal talker/listener mode. If the listen-only/talk-only modes or the compatibility languages are to be used, follow the setup procedures described in this section.

### Address Setup Procedure

5-3.

Setting up the Signal Generator on the IEEE-488 bus requires only a choice of address and connection to a controller. The address is set at the Fluke factory to 2. To change the Signal Generator address, proceed as follows:

Enter    to display the current IEEE-488 address. The address is shown in the FREQUENCY display field, and the talker/listener mode is shown in the AMPLITUDE display field. For example:

EXAMPLE	EXPLANATION
"Addr 01 ? "	Normal mode with address of 1
"Addr 12 ? to"	Talk-only mode, address is ignored
"Addr 23 ? Lo"	Listen-only mode, address is ignored

Enter two digits for the desired new address. Addresses are allowed in the range of 0 to 30. The new address is displayed for 2 seconds.

The address is stored in non-volatile memory and is retained when the power is turned off.

### Talker/Listener Mode Selection Procedure

5-4.

When using an IEEE-488 bus controller, the Signal Generator should be set to operate in the addressed mode. A talk-only and listen-only mode are provided for use on the IEEE-488 bus without a controller. Two Signal Generators can be connected together to track each other with the talk-only and listen-only modes.

Enter    to display the current talker/listener mode in the FREQUENCY display field.

EXAMPLE	EXPLANATION
Addr ?	Normal (Addressed) mode
to ?	Talk-only mode
Lo ?	Listen-only mode

When the Signal Generator is in talk-only or listen-only, it is always addressed to talk or listen, so the ADDR annunciator on the front panel is always lit.

Enter  to select the addressed mode,  to select the talk-only mode, and  to select the listen-only mode. The new talker/listener mode is displayed for 2 seconds.

The selected mode is stored in non-volatile memory and retained when the power is turned off.

**Compatibility Language Selection Procedure****5-5.**

The default language for the Signal Generator is described in this section. To select and use an alternate language for emulating a supported model of signal generator, refer to Section 5D.

If anything but the 6080 language is selected, the Signal Generator will not respond to the commands described in this section. See Section 5D for more information.

Verify that the default 6080 language is selected by entering    to display the current IEEE-488 language in the FREQUENCY display field. If the display reads anything but L6080, press  to select the default language.

The language setting is stored in non-volatile memory and is retained when the power is turned off.



# Section 5A

## Remote Programming

### INTRODUCTION

5A-1.

Communication between the controller and the Signal Generator consists of interface messages and commands. Interface messages are defined by the IEEE-488.1 standard and control the lowest level of bus communication. Interface messages are handled automatically by the controller. (The interface messages that the Signal Generator accepts and sends are listed in Tables 5A-4 and 5A-5.) Commands are sent to the Signal Generator literally, for example, with the Fluke 1722A BASIC PRINT statement. The commands are described in Tables 5B-1 and 5B-3. There are three types of commands:

1. Common commands

Commands that start with an asterisk which are defined by the IEEE-488.2 standard.

2. Device-dependent commands

Commands specific to the Signal Generator

3. Queries

Commands that cause the Signal Generator to send a response to the controller. (These commands always end with a question mark (?)).

A controller program first needs to initialize the interface and the Signal Generator. The following sample program can be used.

```
10 INIT PORT 0 \ REMOTE @2           ! PUT SIGNAL GENERATOR IN REMOTE
20 CLEAR @2                          ! CLEAR IEEE-488 INTERFACE
25 PRINT @2, "GAL"                   ! SET TO 488.2 LANGUAGE
30 PRINT @2, "*CLS; *RST"            ! CLEAR ERRORS & RESET SIG GEN
40 PRINT @2, "*SRE 0"                ! DON'T GENERATE SRQs
```

If the programmer wishes to use SRQs, the \*SRE, \*ESE, and ISCE commands should be used to enable the desired event. Refer to "Checking the Instrument Status" later in Section 5A for more information.

Programming the Signal Generator involves sending the desired commands to the instrument as shown in the following program.

## REMOTE OPERATION REMOTE PROGRAMMING

```
100 PRINT @2, "FREQ 100 MHZ; AMPL -15 DBM" ! PROGRAM FREQUENCY AND AMPLITUDE
110 PRINT @2, "RFOUT ON" ! TURN RF OUTPUT ON
120 PRINT @2, "FM 1.2 KHZ; EXTAC_FM ON" ! PROGRAM DEVIATION & ENABLE EXTERNAL FM
```

Instrument parameters can be retrieved with a query (programming commands that contain a question mark):

```
200 PRINT @2, "FREQ?" ! RETRIEVE FREQUENCY
210 INPUT LINE @2, A$
220 PRINT "Frequency is: "; A$
230 PRINT @2, "RFOUT?" ! RETRIEVE RF OUTPUT STATE
240 INPUT LINE @2, A$
250 PRINT "RF output is: "; A$
260 PRINT @2, "FM?; EXTAC_FM?" ! RETRIEVE DEVIATION & EXTERNAL FM STATE
270 INPUT LINE @2, A$
280 PRINT "FM info is: "; A$
```

After the program has run, the output is:

```
Frequency is 1.000000000E+08,HZ
RF output is ON
FM info is 1.200E+03,HZ;ON
```

Programming errors may be checked by the following sample programs. The Error Available (EAV) bit in the serial poll register may be checked using a serial poll.

```
300 A = SPL(2) ! CHECK FOR ERRORS
310 IF (A AND 8) THEN PRINT "There was an error"
320 PRINT @2, "*CLS" ! CLEAR ERRORS
```

The error and an explanation can be checked as follows. Since errors are accumulated in a queue, the entire queue must be read to retrieve and clear all the errors.

```
400 PRINT @2, "ERROR? EXPLAIN" ! CHECK FOR ERRORS
410 INPUT @2, A, A$
420 IF (A = 0) THEN GOTO 500 ! NO MORE ERRORS
430 PRINT "Error# :";A, A$ ! PRINT ERROR# AND EXPLANATION
440 GOTO 400
500 END
```

## COMMAND SYNTAX INFORMATION

### 5A-2.

The following syntax rules apply to all the remote commands. (A command consists of a word by itself or a word followed by one or more parameters.) The rules for parameter syntax are provided first (including proper usage of units), followed by the rules for extra spaces, followed by the rules for terminator usage. A description of how the Signal Generator processes incoming characters provides the basis for answering other possible questions about syntax. Information about syntax of response messages is also given.

## Parameter Syntax Rules

### 5A-3.

Many of the remote commands require parameters. Improper use of parameters causes command errors to occur.



General rules for parameter usage are as follows:

1. When a command has more than one parameter, the parameters must be separated by commas.

For example: "MEM\_DIVIDER 1, 25, 30, 48".

2. Numeric parameters may have up to 255 significant digits and their exponents may range from -32000 to +32000. The useful range for Signal Generator programming is  $\pm 2.2 \text{ E-308}$  to  $\pm 1.8 \text{ E308}$ .
3. Specifying more parameters than allowed by a particular command causes a command error.
4. Null parameters cause a command error (e.g., the adjacent commas in "MEM\_DIVIDER 1, 25, , 48").
5. Expressions, for example "(4+2\*13)", are not allowed as parameters.

Units that are accepted in command parameters are listed in Table 5B-1.

### Extra Space Characters

#### 5A-4.

Table 5B-3 and the remote program examples in this section show commands and their parameters separated by spaces. One space after a command is required. All other spaces are optional. They are shown for clarity in the manual and may be left in or omitted as desired. Extra spaces can be inserted between parameters as desired. Extra spaces within a parameter are generally not allowed, except for between a number and its associated unit.

EXAMPLE	EXPLANATION
FREQ 100 MHZ	Equivalent to "FREQ 100MHZ"
MEM_DIVIDER 1, 25, 30, 48	Equivalent to "MEM_DIVIDER 1,25,30,48"
AMPL -1 2.5 DBM	Invalid; no space allowed in a number
AMPL -12.5 DBM	Correct form for above

Table 5B-3 contains examples for commands whose parameters are not self explanatory. Remote program examples for the Fluke 1722A Instrument Controller are provided at the end of this section.

### Terminators

#### 5A-5.

To signify the end of a response sent to the controller, the Signal Generator sends a "terminator." The Signal Generator sends the ASCII character Line Feed (LF) with the EOI control line asserted as the terminator for response messages. The Signal Generator recognizes the following as terminators when encountered in incoming data:

- The ASCII LF character
- Any ASCII character sent with the EOI control line asserted

The terminator used by the Fluke 1722A Instrument Controller for data it sends to instruments on the IEEE-488 bus is programmable, but its default is LF with EOI.

## Incoming Character Processing

5A-6.

The Signal Generator processes all incoming data as follows:

1. All data is taken as 7-bit ASCII, the eighth bit (DIO8) is ignored (except the 8-bit data byte portion of the \*PUD and \*DDT parameters).
2. Lower-case or upper-case characters are accepted.
3. ASCII characters whose decimal equivalent is less than 32 (Space) are discarded, except for characters 10 (LF) and 13 (CR) and in the \*PUD and \*DDT command arguments. The \*PUD and \*DDT commands allow all characters in their arguments, and they terminate in a special way.

## Response Message Syntax

5A-7.

In Table 5B-3, responses from the Signal Generator are described wherever appropriate. In order to know whether to read an integer or a floating-point number, the entry is labeled "(Integer)" or "(Floating)".

Integers for most controllers or computers are decimal numbers in the range -32768 to 32767. Response elements of this type are labeled as "Integer" in the command tables. Floating-point numbers may be in exponential form, i.e., "1.15E-12". Examples in Table 5B-3 show response formats.

## INPUT BUFFER OPERATION

5A-8.

As the Signal Generator receives each data byte from the controller, it places the bytes in a portion of memory called the input buffer. The input buffer holds up to 64 data bytes and operates in a first-in/first-out fashion.

The Signal Generator treats the IEEE-488 EOI control line as a separate data byte and inserts it into the input buffer if it is encountered as part of a message terminator.

The Signal Generator treats the IEEE-488 trigger interface message as a separate byte and inserts it into the input buffer at the time it is received.

Input buffer operation is transparent to the program running on the controller. If the controller sends commands faster than the Signal Generator can process them, the input buffer fills to capacity. When the input buffer is full, the Signal Generator holds off the IEEE-488 bus with the handshake lines. When the Signal Generator has processed a data byte from the full input buffer, it then completes the handshake, allowing the controller to send another data byte.

The Signal Generator clears the input buffer at power-on and on receiving the DCL (Device Clear) or SDC (Selected Device Clear) messages from the controller.

## COMMANDS

5A-9.

Table 5B-1 summarizes the commands by function. Table 5B-3 provides protocol details of the remote commands. The commands duplicate almost all activities that can be initiated from the front panel in local operation. Separate headings for each command in the tables provide the parameters and responses (if any), and an example for cases in which the parameters are not self explanatory.

## Multiple Commands

5A-10.

If the controller on the IEEE-488 bus is a Fluke 1722A, commands are sent one at a time, or combined, in Fluke BASIC PRINT statements. For example if the Signal Generator bus address is 2, use the following BASIC program statements to set the Signal Generator to output 100 MHz and -25 dBm.

```
10 INIT PORT 0 \ REMOTE @2 ! PUT SIGNAL GENERATOR IN THE REMOTE STATE
20 PRINT @2,"FREQ 100 MHZ" ! PROGRAM 100 MHZ
30 PRINT @2,"AMPL -25 DBM" ! PROGRAM -25 DBM
40 PRINT @2,"RFOUT ON" ! TURN THE RF OUTPUT ON
```

The same results can be achieved by combining the three commands in one statement as follows (note that each command is separated by a “;”):

```
10 INIT PORT 0 \ REMOTE @2
20 PRINT @2,"FREQ 100 MHZ ; AMPL -25 DBM ; RFOUT ON"
```

## Command Processing

5A-11.

All commands are processed in the order they are received. Each command is completely processed before the next is processed.

Table 5B-3 lists all the commands processed by the Signal Generator. Commands are received and executed at all times. Some restrictions may apply in certain Signal Generator modes of operation.

## Command Restrictions

5A-12.

During sweep operation, some commands are rejected and some are processed differently. This information is noted in Table 5B-3 with the description of the commands.

In local, all calibration and compensation commands are rejected. (CAL\_AM, CAL\_FM, CAL\_LEVEL, CAL\_REFOSC, CMEM\_FIX, COMP\_ATT, COMP\_COARSE, COMP\_OUT, COMP\_OUTDEF, COMP\_SUBSYN, COMP\_SUM)

During calibration and compensation procedures, only a subset of commands are allowed. Refer to the section “Closed-Case Calibration Adjustments” and the section “Compensation Procedures” in the Service Manual for details.

In listen-only, all calibration and compensation commands and all the queries (those that end with a “?”) are rejected.

## Commands That Require the CAL|COMP Switch To Be Set

5A-13.

### CAUTION

Great care should be exercised in using these commands, as they may alter the Signal Generator calibration/compensation data.

The following commands do not work unless the rear panel CAL|COMP switch is in the 1 (on) position: \*PUD, CMEM\_FIX, and all commands that start with CAL\_, CC\_, and COMP\_. Attempting to use any of these commands with the CAL|COMP switch in the 0 (off) position causes the Signal Generator to log an error into the error queue.

## REMOTE/LOCAL STATE TRANSITIONS

5A-14.

The Signal Generator can be operated using the front panel keys as described in Section 4, "Front Panel Operation", or remotely using a remote controller. In addition, the Signal Generator can be placed in a local lockout condition at any time by command of the controller. When combined, the local, remote, and lockout conditions yield four possible operating states:

- Local

The Signal Generator responds to local (front panel) and remote commands. This is also called "front panel operation." Some remote commands are not allowed in the local state. These are mostly procedural commands such as the calibration and compensation commands.

- Local with Lockout

Local with lockout is identical to local, except the Signal Generator will go into the remote with lockout state instead of the remote state when it receives a remote command. The local with lockout state is entered by executing the Fluke 1722A BASIC "LOCKOUT" statement when using the 1722A as an IEEE-488 controller.

- Remote

When the Remote Enable (REN) line is asserted and a controller addresses the Signal Generator as a listener, it enters the remote state. These conditions are met, for example, when a Fluke 1722A executes the BASIC statement "REMOTE \ PRINT @2 'FREQ 100 MHZ'" if the Signal Generator's address is 2. In the remote state, the REMOTE annunciator is lit.

Front panel operation is restricted to use of the power switch and the CLR|LCL key. Pressing this key returns the Signal Generator to the local state. The controller may also send a Go To Local (GTL) interface message. (When the Fluke 1722A is used, the "LOCAL @2" BASIC statement does this if the Signal Generator's address is 2.)

- Remote with Lockout

The remote with lockout state can be entered from the remote state or from the local with lockout state, but not directly from the local state. Remote with lockout is similar to the remote state, but it is restricted: the CLR|LCL key does not return the Signal Generator to the local state. Instead, the message "Loc out" is displayed in the FREQUENCY display field when the key is pressed.

To return the Signal Generator to the local with lockout state, the controller sends the Go To Local interface message (GTL). (When the Fluke 1722A is used as an IEEE-488 controller, the "LOCAL @2" BASIC statement does this if the Signal Generator's address is 2.)

Table 5A-1 summarizes the possible Remote/Local state transitions.

Table 5A-1. Remote/Local State Transitions

FROM	TO	USE	FLUKE 1722A BASIC COMMAND
Local	Remote	MLA + REN	REMOTE
	Local/Lockout	LLO + REN	LOCKOUT
Remote	Local	GTL, or [CLRILCL] key	LOCAL
	Remote/Lockout	LLO + REN	LOCKOUT
Local/Lockout	Remote/Lockout	MLA + REN	REMOTE, or any Signal Generator command
Remote/Lockout	Local	REN	LOCAL
	Local/Lockout	GTL	LOCAL @

#### CHECKING THE INSTRUMENT STATUS

5A-15.

The programmer has access to status registers, enable registers, and queues in the Signal Generator to indicate various conditions in the Signal Generator as shown in Figure 5A-1. Some of the registers and queues are defined by the IEEE-488.2 standard. The rest are specific to the Signal Generator.

Each status register and queue has a summary bit in the Serial Poll Status Byte. Enable registers are used to mask various bits in the status registers and generate summary bits in the Serial Poll Status Byte. The Service Request Enable Register can be used to assert the IEEE-488 Service Request (SRQ) control line on any one of the status conditions in the instrument.

Queries cause the Signal Generator response to be placed in the output queue. The output queue may contain responses from more than one query. The responses are output on a first-in/first-out basis, one at a time, in response to a controller input program statement. If the output queue is empty, no response will be sent to the controller.

#### Serial Poll Status Byte (STB)

5A-16.

The most important and frequently used register is the serial poll status byte, which the Signal Generator sends when it responds to a serial poll. The status byte can also be retrieved with the \*STB? command. The value of this byte at power-on is determined by the value of the service request enable register (SRE), which is saved in non-volatile memory.

#### BIT ASSIGNMENTS FOR THE STB AND SRE

5A-17.

The bits in the Serial Poll Status Byte (STB) and Service Request Enable Register (SRE) are assigned as shown in Figure 5A-2.

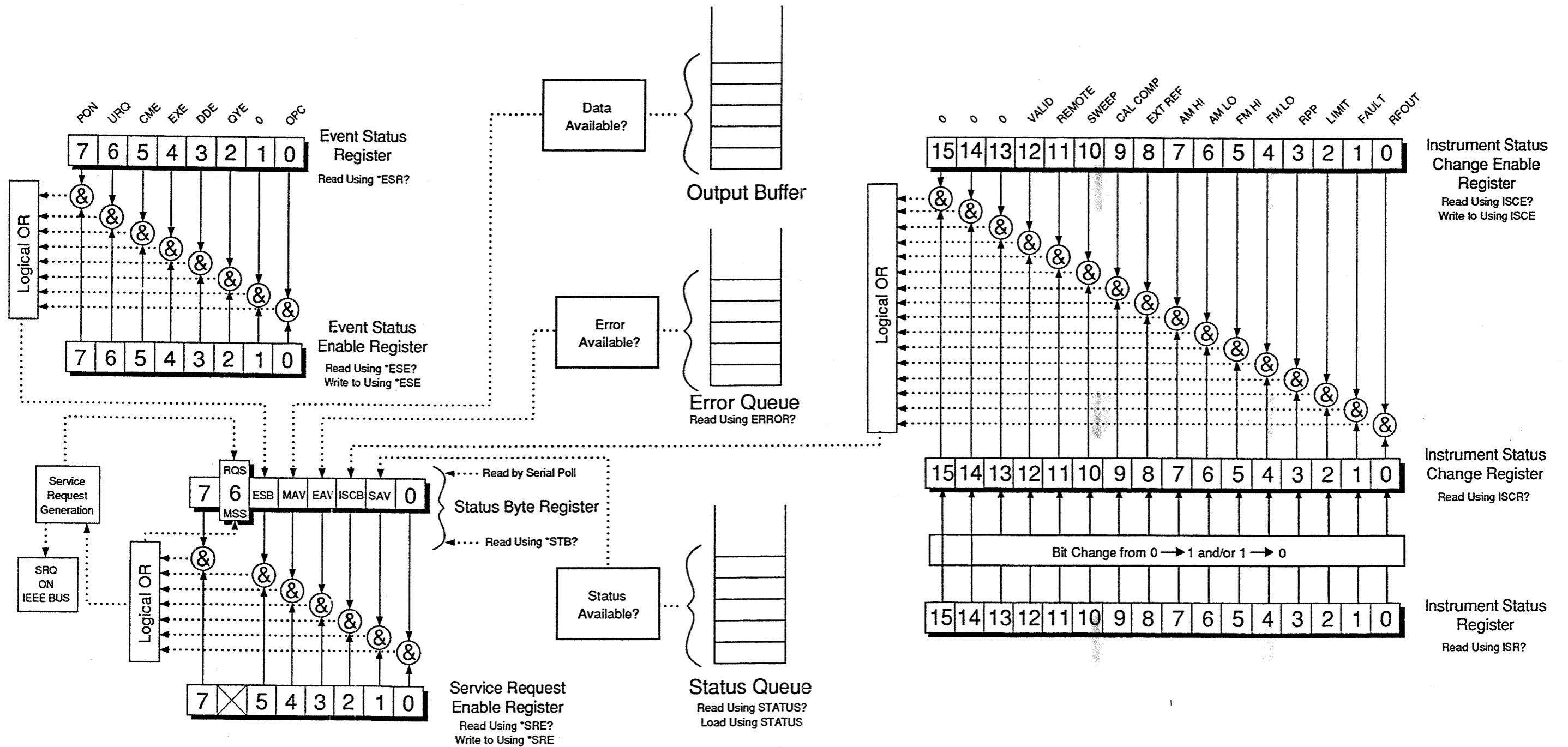

Figure 5A-1. Instrument Status Overview

7	6	5	4	3	2	1	0
0	RQS	ESB	MAV	EAV	ISCB	SAV	0
	MSS						

**RQS** Requesting service. The RQS bit is set to 1 whenever bits ESB, MAV, EAV, ISCB, or SAV change from 0 to 1 and are enabled (1) in the SRE. When RQS is 1, the Signal Generator asserts the SRQ control line on the IEEE-488 interface. You can do a serial poll to read this bit to see if the Signal Generator is the source of an SRQ.

**MSS** Master summary status. Set to 1 whenever bit ESB, MAV, EAV, ISCB, or SAV is 1 and enabled (1) in the SRE. This bit can be read using the \*STB? command.

**ESB** Is set to 1 when one or more enabled ESR bits are 1.

**MAV** Message available. The MAV bit is set to 1 whenever data is available in the Signal Generator's IEEE-488 interface output buffer.

**EAV** Error available. An error has occurred and an error code is available to be read from the error queue using the ERROR? query.

**ISCB** One or more enabled ISCR bits are 1.

**SAV** Status available. Status codes have been loaded into the status queue and are available to be read from the queue using the STATUS? query.

Figure 5A-2. Bit Assignments for the STB and SRE

SERVICE REQUEST LINE (SRQ)

5A-18.

Service Request (SRQ) is an IEEE-488.1 bus control line that the Signal Generator asserts to notify the controller that it requires some type of service. Many instruments can be on the bus, but they all share a single SRQ line. To determine which instrument set SRQ, the controller normally does a serial poll of each instrument. The Signal Generator asserts SRQ whenever the RQS bit in its Serial Poll Status Byte is 1. This bit informs the controller that the Signal Generator was the source of the SRQ. The front panel SRQ annunciator is lit whenever the Signal Generator asserts SRQ.

The Signal Generator clears SRQ and RQS whenever the controller performs a serial poll of the Signal Generator IEEE-488 interface, sends \*CLS, or whenever the MSS bit is cleared. The MSS bit is cleared only when ESB, MAV, EAV, ISCB, and SAV are 0, or when they are disabled by their associated enable bits in the SRE register being set to 0.

SERVICE REQUEST ENABLE REGISTER (SRE)

5A-19.

The Service Request Enable Register (SRE) enables or masks the bits of the Serial Poll Status Byte. The SRE is stored in non-volatile memory and is restored to its power-off value when the power is turned on.

PROGRAMMING THE STB AND SRE

5A-20.

The SRE can be set with the remote command \*SRE and with a front panel special function sequence.

By setting the bits in the SRE, the associated bits in the Serial Poll Status Byte can be enabled. The following sample program enables the Error Available (EAV) bit.

```

10 ! THIS PROGRAM SETS EAV IN THE SRE
20 GOSUB 100 ! GET AND PRINT OLD SRE
30 IF ((A% AND 16%)=0%) THEN A% = A%+16% ! ENABLE EAV (BIT 4)
40 PRINT @2, "*SRE ";A% ! "
50 GOSUB 100 ! GET AND PRINT NEW SRE
60 END
100 PRINT @2, "*SRE?" ! ASK FOR THE SRE CONTENTS
110 INPUT @2, A% ! RETRIEVE THE REGISTER CONTENTS
120 PRINT "SRE = ";A%
130 RETURN

```

The following front panel key sequence sets the SRE to be 16 (EAV enabled).

ENTER:	DISPLAY SHOWS:	EXPLANATION
<div style="display: flex; justify-content: space-around;"> <div style="border: 1px solid black; padding: 2px;">SPCL</div> <div style="border: 1px solid black; padding: 2px;">1</div> <div style="border: 1px solid black; padding: 2px;">3</div> </div>	"SrE 12 ?"	Current value
<div style="display: flex; justify-content: space-around;"> <div style="border: 1px solid black; padding: 2px;">0</div> <div style="border: 1px solid black; padding: 2px;">1</div> <div style="border: 1px solid black; padding: 2px;">6</div> </div>	"SrE 16 "	New value

The following program generates an error, and checks the Serial Poll Status Byte. Enable the EAV bit with the examples above.

```

10 ! THIS PROGRAM GENERATES AN ERROR AND CHECKS IT
20 PRINT @2, "FREQ 100 GHZ" ! CAN'T OUTPUT 100 GHZ
30 A% = SPL(2) ! DO A SERIAL POLL
40 IF ((A% AND 144%)=0%) THEN PRINT "EAV and SRQ should have been set"
50 PRINT @2, "STB?" ! RETRIEVE BYTE
60 INPUT @2, A%
70 IF ((A% AND 16%)=0%) THEN PRINT "EAV should have been set"

```

Event Status Register (ESR)

5A-21.

The Event Status Register is a two-byte register in which the higher eight bits are always 0, and the lower eight bits except bit 1 represent various conditions of the Signal Generator. The ESR is cleared (set to 0) when the power is turned on and every time it is read.

BIT ASSIGNMENTS FOR THE ESR AND ESE

5A-22.

The bits in the Event Status Register (ESR) and Event Status Enable Register (ESE) are assigned as shown in Figure 5A-3.



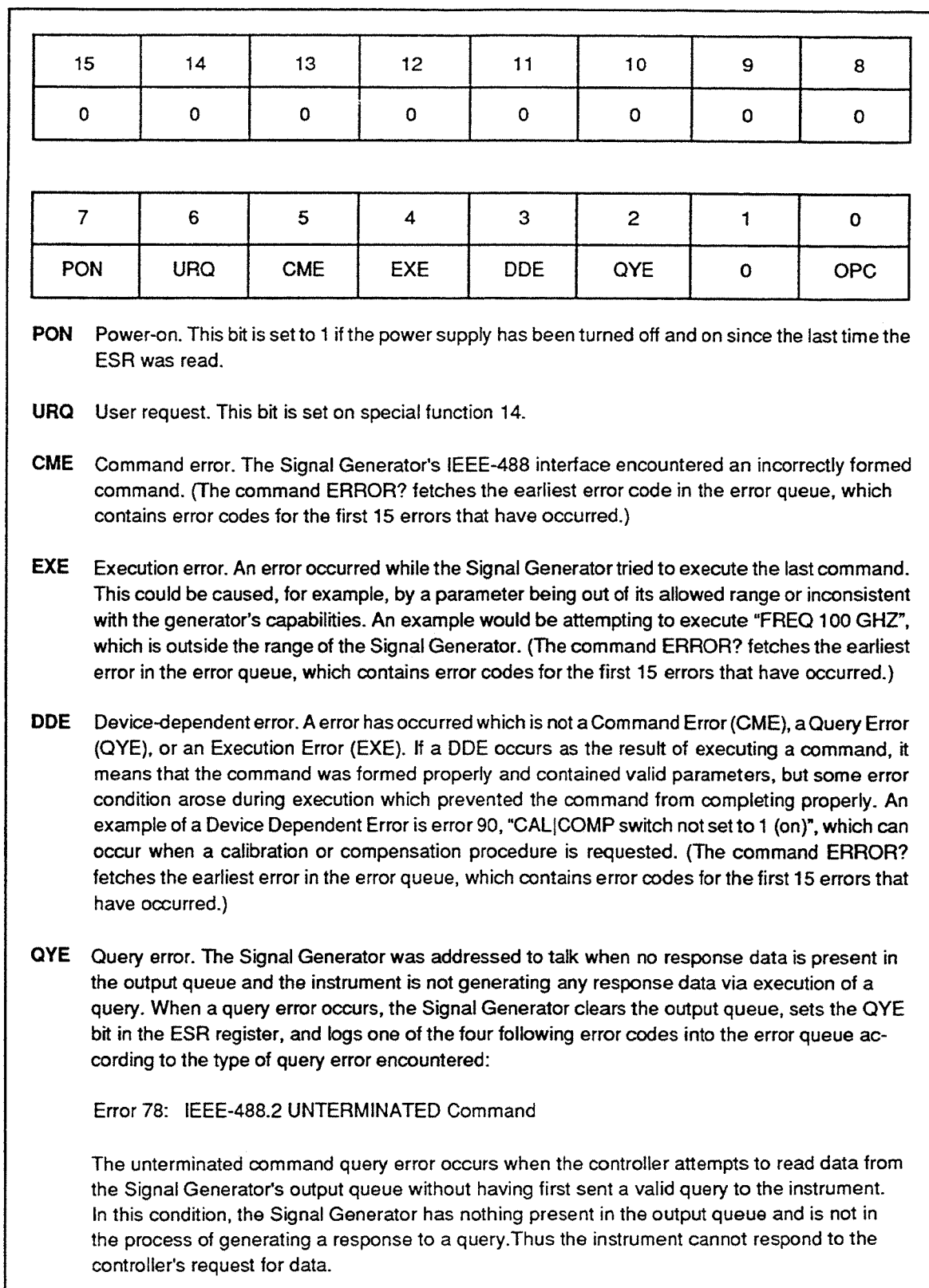

Figure 5A-3. Bit Assignments for ESR and ESE

REMOTE OPERATION  
REMOTE PROGRAMMING

Error 79: IEEE-488.2 INTERRUPTED Query

Interrupted query occurs when the IEEE-488 controller sends a new character to the 6080A and response data is present in the output queue or the 6080A is generating response data by executing a query. After sending a query to the 6080A, the controller should always be sure to read all of the response data which the generator generates.

Error 80: IEEE-488.2 I/O DEADLOCK

This type of query error occurs when the 6080A has been asked to buffer more data than it has room to store in the output buffer. The 6080A logs this error when the 6080A detects the following three conditions simultaneously:

1. The output buffer is full, thus blocking completion the query which is generating response data.
2. The input buffer is full.
3. The controller is attempting to send a new character to the generator.

If these three conditions occur at the same time, the IEEE-488 bus will be blocked (deadlocked) since the controller cannot clear the condition unless it aborts sending the character and begins reading the output buffer.

Error 84: IEEE-488.2 QUERY AFTER INDEFINITE RESPONSE

This error occurs when a query which generates a response of type <arbitrary response data> is followed by another query without first reading the response.

**OPC** Operation complete. All commands previous to reception of a \*OPC command have been executed, and the interface is ready to accept another message.

Figure 5A-3. Bit Assignments for ESR and ESE (cont)

EVENT STATUS ENABLE REGISTER (ESE)

5A-23.

A mask register called the Event Status Enable register (ESE) allows the controller to enable or mask (disable) each bit in the ESR. When a bit in the ESE is 1, the corresponding bit in the ESR is enabled. When any enabled bit in the ESR is 1, the ESB bit in the Serial Poll Status Byte also goes to 1. The ESR bit stays 1 until the controller reads the ESR or does a device clear, a selected device clear, or sends the clear status \*CLS command to the Signal Generator. The ESE is stored in non-volatile memory and is restored when the power is turned on.

PROGRAMMING THE ESR AND ESE

5A-24.

To read the contents of the ESR, send the remote command, \*ESR?. The ESR is cleared (set to 0) every time it is read. To read the contents of the ESE, send the remote command, \*ESE?. The ESE is not cleared when it is read. When either register is read, the Signal Generator responds by sending a decimal number that represents bits 0 through 15.

The following sample program retrieves the contents of the ESR and ESE registers:

```
10 ! THIS PROGRAM READS THE ESR AND THE ESE REGISTERS
20 PRINT @2, "**ESR?"           ! ASK FOR THE ESR CONTENTS
30 INPUT @2, A%                ! RETRIEVE THE REGISTER CONTENTS
40 PRINT @2, "**ESE?"          ! ASK FOR THE ESE CONTENTS
50 INPUT @2, B%                ! RETRIEVE THE REGISTER CONTENTS
60 PRINT "ESR = ";A%           ! DISPLAY THE ESR REGISTER CONTENTS VALUE
70 PRINT "ESE = ";B%           ! DISPLAY THE ESE REGISTER CONTENTS VALUE
80 END
```

The status of the registers can be read by converting the contents of the variables A% and B% into binary. For example if A% is "32", its binary equivalent is: 00000000 00100000. Therefore, bit 5 (Command Error, CME) in the ESR is set (1) and the rest of the bits are reset (0). This means that the Signal Generator tried to execute an incorrectly formed command.

By setting the bits in the ESE, the associated bits in the ESR can be enabled. For example, to prevent the occurrence of a command error from causing bit 5 (ESB) in the Serial Poll Status Byte to go to 1, bit 5 in the ESE register can be reset (to 0).

The following sample program accomplishes this by checking the status of the CME bit, then toggling it if it is 1.

```

10 ! THIS PROGRAM RESETS BIT 5 (CME) IN THE ESE
20 PRINT @2, "*ESE 33"           ! INITIAL ESE IS CME + OPC
30 GOSUB 100                     ! GET AND PRINT INITIAL ESE
40 IF (A% AND 32%) THEN A% = A% - 32% ! CLEAR CME (BIT 5)
50 PRINT @2, "ESE ";A%          ! LOAD THE ESE WITH THE NEW VALUE
60 GOSUB 100                     ! GET AND PRINT NEW ESE
70 END
100 PRINT @2, "ESE?"            ! ASK FOR THE ESE CONTENTS
110 INPUT @2, A%                ! RETRIEVE THE REGISTER CONTENTS
120 PRINT "ESE = ";A%
130 RETURN

```

The ESE may not be loaded from the front panel.

## Output Queue

5A-25.

The output queue is loaded whenever a query is processed. The controller then reads it with a statement such as the Fluke 1722A BASIC INPUT statement. The Message Available (MAV) bit in the Serial Poll Status Byte indicates whether or not the output queue is empty.

If the queue is empty, the Signal Generator will not respond to the input statement from the controller.

The output queue is 64 characters long.

## Error Queue

5A-26.

When a command error, execution error, query error, or device-dependent error occurs, its error code is placed in the error queue, where it can be read by the ERROR? command. All error codes are defined in Appendix C of this manual. ERROR? EXPLAIN will return the error code and a description of the error code.

Reading the first error with the ERROR? command removes that error from the queue. A response of "0" means the error queue is empty. The Error Available (EAV) bit in the Serial Poll Status Byte indicates whether or not the error queue is empty. The error queue is cleared when the Signal Generator is turned on and by the \*CLS command.

The error queue contains up to 16 entries. If many errors occur, only the first 15 errors are kept in the queue. A 16th entry in the queue is always an "error queue overflow" error, and all later errors are discarded until the queue is at least partially read. Since many errors may occur before they are acknowledged and read, the earliest errors are the most likely to point to the problem. Subsequent errors are usually repetitions or consequences of the original problem.

**Instrument Status Register (ISR)**

**5A-27.**

The Instrument Status Register (ISR) gives the controller access to the state of the Signal Generator, including some of the information presented with the display annunciators on the front panel.

**BIT ASSIGNMENTS FOR THE ISR, ISCR, AND ISCE**

**5A-28.**

The bits in the Instrument Status Register (ISR), Instrument Status Change Register (ISCR), and Instrument Status Change Enable Register (ISCE) are assigned as shown in Figure 5A-4.

**INSTRUMENT STATUS CHANGE REGISTER (ISCR)**

**5A-29.**

The Instrument Status Change Register (ISCR) indicates which ISR bits have changed status (from 0 to 1 or from 1 to 0) since the ISCR was last read. The ISCR is cleared (set to 0) when the Signal Generator is turned on and every time it is read.

15	14	13	12	11	10	9	8
0	0	0	VALID	REMOTE	SWEEP	CALCOMP	EXTREF
			↑	↑↓	↓	↑↓	↑↓

7	6	5	4	3	2	1	0
AM HI	AM LO	FM HI	FM LO	RPP	LIMIT	FAULT	RFOUT
↑	↑	↑	↑	↑	↑	↑	↑↓

**VALID** When 1, the RF output is valid

**REMOTE** When 1, the Signal Generator is under remote control (REMOTE annunciator is lit).

**SWEEP** When 1, digital sweep is active.

**CALCOMP** When 1, the CALCOMP switch is in the "1" position.

**EXTREF** When 1, the external reference frequency is being used (EXTREF switch is in the "EXT" position).

**AM HI** When 1, the external AM signal is greater than 1.02V.

**AM LO** When 1, the external AM signal is less than 0.98V.

**FM HI** When 1, the external FM signal is greater than 1.02V.

**FM LO** When 1, the external FM signal is less than .98V.

**RPP** When 1, the RPP circuitry has tripped.

**LIMIT** When 1, the Signal Generator is operating in a hardware limited region.

**FAULT** When 1, the Signal Generator has a hardware fault condition.

**RFOUT** When 1, the RF output is on.

Figure 5A-4. Bit Assignments for the ISR, ISCR, and ISCE

INSTRUMENT STATUS CHANGE ENABLE REGISTER

5A-30.

The Instrument Status Change Enable Register (ISCE) is a mask register for the ISCR. If a bit in the ISCE is enabled (set to 1) and the corresponding bit in the ISCR changes in the proper direction, the ISCB bit in the Serial Poll Status Byte is set to 1. ISCR bits marked ↑ set the change bit when the ISCR bit goes from a 0 to a 1, ISCR bits marked ↓ set the change bit when the ISCR bit goes from a 1 to a 0, and ISCR bits marked ↑ ↓ set the change bit when the ISCR bit changes. If all bits in the ISCE are disabled (set to 0), the ISCB bit in the Serial Poll Status Byte never goes to 1. The ISCE is stored in non-volatile memory and is restored to its power-off value when the power is turned on.

PROGRAMMING THE ISR, ISCR, AND ISCE

5A-31.

To read the contents of the ISR, send the remote command, ISR?. To read the contents of the ISCR, send the remote command, ISCR?. To read the contents of the ISCE, send the remote command, ISCE?. The Signal Generator responds by sending a decimal number that represents bits 0 through 15. Every time the ISCR is read, its contents are zeroed.

The following sample program reads the ISR, ISCR, and ISCE registers:

```

10 ! THIS PROGRAM READS THE ISR, ISCR, AND ISCE REGISTERS
20 ! NOTE THAT THE ICSR? COMMAND ALSO CLEARS THE ISCR CONTENTS
30 PRINT @2, "ISR?"      ! ASK THE ISR CONTENTS
40 INPUT @2,A%          ! RETRIEVE REGISTER CONTENTS FROM SIGNAL GENERATOR
50 PRINT @2, "ISCR?"    ! ASK FOR AND CLEAR THE ISCR CONTENTS
60 INPUT @2, B%        ! RETRIEVE REGISTER CONTENTS FROM SIGNAL GENERATOR
70 PRINT @2, "ISCE?"   ! ASK FOR THE ISCE CONTENTS
80 INPUT @2, C%        ! RETRIEVE REGISTER CONTENTS FROM SIGNAL GENERATOR
90 PRINT "ISR = ";A%   ! DISPLAY THE ISR
100 PRINT "ISCR = ";B% ! DISPLAY THE ISCR
110 PRINT "ISCE = ";C% ! DISPLAY THE ISCE
120 END

```

The status of the instrument can be read by converting the returned variables into binary. For example, if a register contains "4", its binary equivalent is: 00000000 00000100. Therefore, bit 3 (CALCOMP) is set (1), and the rest of the bits are reset (0).

By setting the bits in the ISCE, the associated bits in the ISCR can be enabled. For example, to cause an SRQ interrupt when an the RPP trips, bit 3 (RPP) in the ISCE register must be 1. (The ISCB bit must also be enabled in the SRE.)

The following sample program loads a decimal 8 into the ISCE, which sets bit 3 and resets the other bits:

```

10 ! THIS PROGRAM LOADS 00000000 00001000 BINARY INTO THE ISCE
20 PRINT @2, "ISCE 8"  ! LOAD DECIMAL 8 INTO THE ISCE
30 PRINT @2, "ISCE?"   ! READ BACK THE VALUE
40 INPUT @2, A%        ! "
50 PRINT "ISCE = ";A%  ! PRINT IT, IT SHOULD BE 8
60 END

```

The ISCE cannot be loaded from the front panel.

**Status Queue**

**5A-32.**

The status queue is loaded with the STATUS command. The argument to the STATUS command (UNCAL, SELFTEST, CHECKSUM, or ORIGIN) indicates which status is to be loaded. The previous contents of the status queue are cleared when a new status is loaded with the STATUS command. Once the status queue is loaded, it can be read with successive STATUS? commands. A response of 0 indicates that the status queue is empty. All status codes are defined in Appendix D and E of this manual. STATUS? EXPLAIN will return the status code and a description of the status code.

Reading the first status with the STATUS? command removes that status from the queue. A response of "0" means the status queue is empty. The Status Available (SAV) bit in the Serial Poll Status Byte is "0" when the status queue is empty and "1" when the queue has been loaded with the STATUS command. The status queue is cleared when the Signal Generator is turned on and by the \*CLS command.

**IEEE-488 INTERFACE CONFIGURATION**

**5A-33.**

The Signal Generator IEEE-488 interface supports the IEEE-488 interface function subsets listed in Table 5A-2.

**Table 5A-2. IEEE-488 Interface Function Subsets Supported**

INTERFACE FUNCTION	DESCRIPTION
SH1	Complete source handshake capability
AH1	Complete acceptor handshake capability
T5	Basic talker, serial poll, talk-only mode, Unaddress if MLA
TE0	No extended talker capability
L3	Basic listener operation, listen-only mode, Unaddress if MTA
LE0	No extended listener capabilities
SR1	Full service request capability, with bit-maskable SRQ
RL1	Full remote/local capability, including local lockout
PP0	No parallel poll capability
DC1	Device clear capability
DT1	Device trigger capability
C0	No bus control capability
E2	Tri-state drivers

**BUS COMMUNICATION OVERVIEW**

**5A-34.**

Communication between the controller and the Signal Generator takes place using commands established by IEEE-488 standards and commands specifically related to the Signal Generator. The commands in Tables 5B-1 and 5B-3 are all the remote commands, both common and device-dependent. Definitions of the different types of messages used on the IEEE-488 bus follow.

- Device-Dependent Commands

Device-Dependent commands are messages used to transfer information directly between the Signal Generator and the IEEE-488 controller. Some commands cause an action to take place in the Signal Generator. Others, called queries in the

IEEE standards, ask for information, and always generate a response message from the instrument. While message format is governed by IEEE-488 standards, messages themselves are unique to the Signal Generator. For example, device-dependent commands are used to set the RF frequency and amplitude, and to turn the RF output on.

- Common Commands

The IEEE standard 488.2 defines common commands, which are used for functions common to most bus devices. Examples include the command for resetting a device (\*RST) and the query for device identification (\*IDN?). Common commands and queries can be identified easily because they all begin with an asterisk (\*).

- Interface Messages

The IEEE standards define interface messages, which manage the interface system. Some of the interface messages have their own control lines, and others are sent over the data lines by first asserting the control line ATN (Attention). The IEEE-488 hardware within the controller handles interface messages, not the user or application program. For example, when a programming command is sent to the Signal Generator, the controller automatically sends the interface message MLA (My Listen Address).

### Definition: Queries and Commands

5A-35.

Messages directed to the Signal Generator fall naturally into two categories: commands and queries. Commands (both common commands and device-dependent commands) instruct the Signal Generator to do something or to set a value; no response is expected. Queries generally ask for information from the Signal Generator, and do not set a value or instruct the instrument to do something; a response is always expected. Some queries also require the Signal Generator to take action. For example, the \*TST? query has the Signal Generator do a self test, then send the result to the controller. A query always ends with a question mark. A command never ends with a question mark. Table 5B-3 does not separate commands and queries; they are all called commands and are presented together in one alphabetical list.

All query responses are generated instantly on receipt of the query. In other words, queries generate their output when the Signal Generator executes the query rather than when the controller attempts to read the response. The Signal Generator simply generates the requested message and places it in the output queue. When the controller addresses the Signal Generator as a talker, the contents of the output queue are transmitted to the controller.

Some messages have both query and command forms (e.g., \*PUD and \*PUD?). In such cases, the command generally sets the value of a parameter, and the query generally returns the most recent value of the parameter. Some messages are queries only (e.g., \*IDN?). Some messages are commands only (e.g., \*RST).

### Functional Elements of Commands

5A-36.

Table 5A-3 lists the functional elements of commands described by the IEEE-488.2 standard that are used by the Signal Generator. This table is for those who have a copy of the standard and want to use it to pursue additional information. The standard provides full definitions and syntax diagrams for each element.

**REMOTE OPERATION  
REMOTE PROGRAMMING**

**Table 5A-3. Functional Elements of Commands**

ELEMENT	FUNCTION
PROGRAM MESSAGE	A sequence of zero or more PROGRAM MESSAGE UNIT elements separated by PROGRAM MESSAGE UNIT SEPARATOR elements.
PROGRAM MESSAGE UNIT	A single command, programming data, or query received by the device.
COMMAND MESSAGE UNIT	A single command or programming data received by the device.
QUERY MESSAGE UNIT	A single query sent from the controller to the device.
PROGRAM DATA	Any of the six program data types.
PROGRAM MESSAGE UNIT SEPARATOR	Separates PROGRAM MESSAGE UNIT elements from one another in a PROGRAM MESSAGE.
PROGRAM HEADER SEPARATOR	Separates the header from any associated PROGRAM DATA.
PROGRAM DATA SEPARATOR	Separates sequential PROGRAM DATA elements that are related to the same header.
PROGRAM MESSAGE TERMINATOR	Terminates a PROGRAM MESSAGE.
COMMAND PROGRAM HEADER	Specifies a function or operation. Used with any associated PROGRAM DATA elements.
QUERY PROGRAM HEADER	Similar to a COMMAND PROGRAM HEADER except a query indicator (?) shows that a response is expected from the device.
CHARACTER PROGRAM DATA	A data type suitable for sending short mnemonic data, generally used where a numeric data type is not suitable.
DECIMAL NUMERIC PROGRAM DATA	A data type suitable for sending decimal integers of decimal fractions with or without exponents.
NON-DECIMAL NUMERIC PROGRAM DATA	A data type suitable for sending integer numeric representations in base 16, 8, or 2.
SUFFIX PROGRAM DATA	An optional field following DECIMAL NUMERIC PROGRAM DATA used to indicate associated multipliers and units.
STRING PROGRAM DATA	A data type suitable for sending 7-bit ASCII character strings where the content needs to be "hidden" (by delimiters).
ARBITRARY BLOCK PROGRAM DATA	A data type suitable for sending blocks of arbitrary 8-bit information. Blocks are limited in size to 1024 bytes.



**Interface Messages**

**5A-37.**

Interface messages manage traffic on the bus. Device addressing and clearing, data handshaking, and commands to place status bytes on the bus are all directed by interface messages. Some of the interface messages are communicated by state transitions of dedicated control lines. The rest of the interface messages are sent over the data lines with the ATN signal true. (All device-dependent and common commands are sent over the data lines with the ATN signal false.)

IEEE-488 standards define interface messages. Table 5A-4 lists the interface messages that the Signal Generator accepts. Table 5A-4 also shows the BASIC statement to execute on the 1722A Controller to generate the interface message. Table 5A-5 lists the interface messages that the Signal Generator sends. The mnemonics listed in the tables are not sent in BASIC PRINT statements as commands are; in this way they are different from device-dependent and common commands.

Interface messages are handled automatically in most cases. For example, handshake messages DAV, DAC, and RFD automatically occur under the direction of an instrument's interface itself as each byte is sent over the bus.

**Table 5A-4. Interface Messages that the Signal Generator Accepts**

MNEMONIC	NAME	FUNCTION	RELATED FLUKE 1722A BASIC COMMAND
ATN	Attention	A control line that, when asserted, notifies all instruments on the bus that the next data bytes are an interface message. When ATN is low, the next data bytes are interpreted as device-dependent or common commands addressed to a specific instrument.	(None)
DAC	Data Accepted	Sets the handshake signal line NDAC low.	(None)
DAV	Data Valid	Asserts the handshake signal line DAV.	(None)
DCL	Device Clear	Clears the input/output buffers.	CLEAR
END	End	A message that occurs when the Controller asserts the EOI signal line before sending a byte.	(None)
GET	Group Execute Trigger	Execute the command string predefined with the *DDT command.	TRIG @
GTL	Go To Local	Transfers control of the Signal Generator from one of the remote states to one of the local states. (See Table 5A-5.)	LOCAL @
LLO	Local Lockout	Transfers remote/local control of the Signal Generator. (See Table 5A-5.)	LOCKOUT

Table 5A-4. Interface Messages that the Signal Generator Accepts (cont)

MNEMONIC	NAME	FUNCTION	RELATED FLUKE 1722A BASIC COMMAND
IFC	Interface Clear	A control line that sets the interface to a quiescent state.	INIT
MLA	My Listen Address	Addresses a specific device on the bus as a listener. The controller sends MLA automatically whenever it directs a device-dependent or common command to a specific instrument.	(None)
MTA	My Talk Address	Addresses a specific device on the bus as a talker. The controller sends MTA automatically whenever it directs a device-dependent or common query to a specific instrument.	(None)
REN	Remote Enable	Transfers remote/local control of the Signal Generator. (See Table 5A-5.)	REMOTE
RFD	Ready for Data	Sets the handshake signal line NRFD low.	(None)
SDC	Selected Device Clear	Does the same thing as DCL, but only if the Signal Generator is currently addressed as a listener.	CLEAR @
SPD	Serial Poll Disable	Cancels the effect of a Serial Poll Enable.	(Part of SPL)
SPE	Serial Poll Enable	After the Signal Generator receives this message, it sends the Status Byte the next time it is addressed as a listener, no matter what the command is.	(Part of SPL)
UNL	Unlisten	"Unaddresses" a specific device on the bus as a listener. The controller sends UNL automatically after the device has successfully received a device-dependent or common command.	(None)
UNT	Untalk	"Unaddresses" a specific device on the bus as a listener. The controller sends UNT automatically after it receives the response from a device-dependent or common query.	(None)

Table 5A-5. Interface Messages that the Signal Generator Sends

MNEMONIC	NAME	FUNCTION
END	End	A message that occurs when the Signal Generator asserts the EOI control line. The Signal Generator asserts EOI while it transmits the ASCII character LF for its termination sequence or terminator.
DAC	Data Accepted	Sets the handshake signal line NDAC low.
DAV	Data Valid	Asserts the handshake signal line DAV.
RFD	Ready for Data	Sets the handshake signal line NRFD low.
SRQ	Service Request	A control line that any device on the bus can assert to indicate that it requires attention. Refer to "Checking Signal Generator Status" for details.
STB	Status Byte	The Status Byte is what the Signal Generator sends when it responds to a serial poll (interface message SPE).

## THE IEEE-488 CONNECTOR

5A-38.

The IEEE-488 connector on the rear panel mates with an IEEE-488 Standard cable. The pin assignments of the rear-panel IEEE-488 connector are shown in Figure 5A-5.

The IEEE-488 Interface signal SHIELD (pin 12) can be disconnected (when using an IEEE-488 cable without a metallic hood) from the instrument ground. To do this, use the SHIELD switch.

The following restrictions apply to all IEEE-488 systems:

1. A maximum of 15 devices can be connected in a single IEEE-488 bus system.
2. The maximum length of IEEE-488 cable used in one IEEE-488 system is the lesser of either 20 meters or 2 meters times the number of devices in the system.

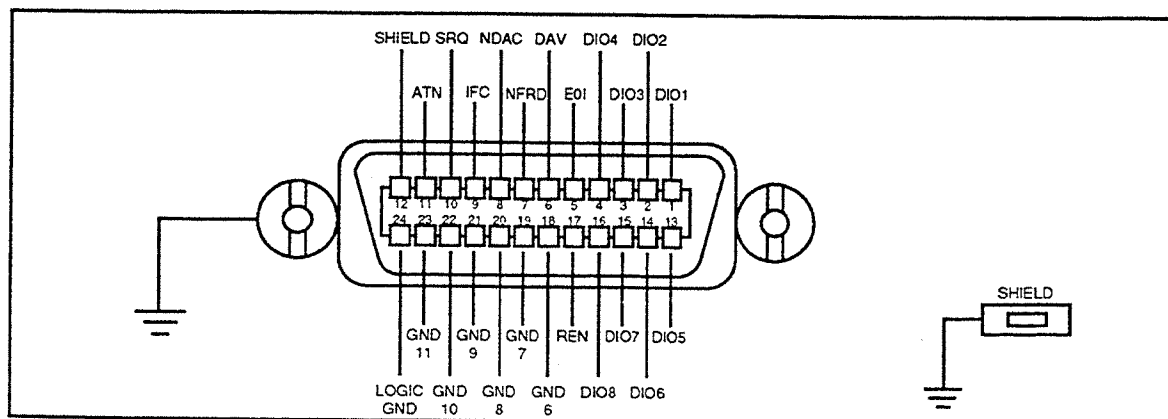

Figure 5A-5. IEEE-488 Connector Pinout (Rear Panel View)

## REMOTE PROGRAM EXAMPLES

5A-39.

The following programs are written in BASIC for the Fluke 1722A Instrument Controller.

### Using the \*OPC?, \*OPC, and \*WAI Commands

5A-40.

The \*OPC?, \*OPC, and \*WAI commands let the programmer maintain control of the order of execution of commands that could otherwise be passed up by subsequent commands.

If a **FREQ** command has been sent, the output can be checked to see if it has settled by sending the query **\*OPC?**. As soon as the **FREQ** command has completed (output settled), a "1" appears in the output queue. The **\*OPC?** command should always be followed with a read command (for example, in Fluke BASIC, "INPUT @2, A"). The read command causes program execution to pause until the addressed instrument responds.

The following sample program shows how **\*OPC?** can be used.

```
10 PRINT @2, "FREQ 100MHZ;*OPC?"      ! SIGNAL GENERATOR ADDRESS IS 2
20 INPUT @2, A                          ! READ "1" FROM SIGNAL GENERATOR
30 !PROGRAM HALTS HERE UNTIL A "1" IS PUT INTO THE OUTPUT QUEUE
40 PRINT "OUTPUT SETTLED"
```

The **\*OPC** command is similar in operation to the **\*OPC?** query, except that it sets bit 0 (OPC for "Operation Complete") in the Event Status Register to 1 rather than sending a "1" to the output queue. One use for **\*OPC** is to include it in a program so that it generates an SRQ (Service Request). Then an SRQ handler written into the program can detect the operation complete condition and respond appropriately. The **\*OPC** command is similar to **\*OPC?**, except the program must read the ESR to detect the completion of all operations.

The following sample program shows how **\*OPC** can be used.

```
10 REMOTE
20 PRINT @2, "FREQ 100MHZ;*OPC"      ! SIGNAL GENERATOR ADDRESS IS 2
30 PRINT @2, "**ESR?"                  ! PUT THE ESR BYTE IN BUFFER
40 INPUT @2, A%                       ! READ THE ESR BYTE
50 IF (A% AND 1%) = 0% GOTO 30         ! TRY AGAIN IF NO OPC
60 PRINT "OUTPUT SETTLED"
70 END
```

The **\*WAI** command causes the Signal Generator to wait until any prior commands have been completed before continuing on to the next command, and takes no other action. Using **\*WAI** is a convenient way to halt controller program execution until the command or commands preceding it have completed.

The following sample program shows how **\*WAI** can be used.

```
10 REMOTE
20 PRINT @2, "FREQ 100MHZ;*WAI"      ! SIGNAL GENERATOR ADDRESS IS 2
30 PRINT @2, "FREQ?"                  ! READ THE OUTPUT VALUE
40 INPUT @2, A$                       ! A$ CONTAINS THE OUTPUT VALUE
50 PRINT "OUTPUT SETTLED"
60 PRINT "OUTPUT IS: ";A$
70 END
```

## Using the \*DDT and \*TRG Commands

5A-41.

The \*DDT command is used to define the device trigger buffer. Once it is loaded, the stored commands may be executed with the \*TRG command or the Group Execute Trigger (GET) interface message (Fluke 1722A BASIC TRIG command).

The use of the trigger buffer will speed up execution of the application program because the contents of the buffer do not need to be transferred on the IEEE-488 bus each time they are executed.

In the following example, the Signal Generator is programmed to step frequency approximately every second.

```
10 REMOTE
20 PRINT @2, "FREQ 210 MHZ"           ! SIGNAL GENERATOR ADDRESS IS 2
30 PRINT @2, "FREQ_STEP 1.25 KHZ"    ! PROGRAM STEP SIZE TO 1.25 KHZ
40 PRINT @2, "*DDT #OSTEP_FREQ UP"   ! LOAD TRIGGER BUFFER
50 PRINT @2, "*DDT?"                 ! VERIFY CONTENTS OF BUFFER
60 INPUT LINE @2, A$ \ PRINT A$       ! A$ SHOULD BE "#213STEP_FREQ UP"
100 TRIG @2                           ! TRIGGER THE SIGNAL GENERATOR
110 WAIT 1000                          ! WAIT ~1 SECOND
120 GOTO 100                          ! DO IT AGAIN
```



## Section 5B

# Remote Command Tables

### **REMOTE COMMAND SUMMARY**

**5B-1.**

Remote commands, organized by function, are summarized in Table 5B-1. Units that are accepted in command parameters are listed in Table 5B-2.

### **REMOTE COMMANDS**

**5B-2.**

The complete list and description of remote commands, arranged in alphabetical order, is provided in Table 5B-3.

REMOTE OPERATION  
REMOTE COMMAND TABLES

Table 5B-1. Remote Command Summary

RF FREQUENCY	
EXTREF_FREQ	Selects the external reference frequency
EXTREF_FREQ?	Retrieves the selected external reference frequency
FREQ	Programs the displayed RF output frequency
FREQ?	Retrieves the displayed RF output frequency
FREQ_ABS?	Retrieves the RF output frequency
FREQ_BASE?	Retrieves the base frequency
FREQ_BLANK	Selects RF output blanking mode
FREQ_BLANK?	Retrieves the state of RF output blanking mode
FREQ_REL	Selects relative frequency mode
FREQ_REL?	Retrieves the state of relative frequency mode
LOWNOISE	Selects low-noise external reference mode
LOWNOISE?	Retrieves the state of low-noise external reference mode
REF	Retrieves the setting of the frequency reference (INT/EXT)
RF OUTPUT AMPLITUDE	
AMPL	Programs the displayed RF output amplitude
AMPL?	Retrieves the displayed RF output amplitude
AMPL_ABS?	Retrieves the RF output level
AMPL_BASE?	Retrieves the base amplitude
AMPL_CMPDAT	Selects alternate output level compensation data
AMPL_CMPDAT?	Retrieves the alternate output level compensation state
AMPL_COMP	Selects the amplitude compensation mode
AMPL_COMP?	Retrieves the state of amplitude compensation mode
AMPL_EMFOUT	Selects EMF display mode
AMPL_EMFOUT?	Retrieves the state of EMF display mode
AMPL_RANGE	Selects amplitude normal/fixed range mode
AMPL_RANGE?	Retrieves the state of amplitude range mode
AMPL_REL	Selects relative amplitude mode
AMPL_REL?	Retrieves the state of relative amplitude mode
AMPL_UNITS	Converts the AMPLITUDE display to specified units
RFOUT	Turns the RF OUTPUT port ON or OFF
RFOUT?	Retrieves the state of the RF OUTPUT port
PHASE ADJUST	
PHASE	Adjusts the phase of the RF carrier
PHASE?	Retrieves the relative phase adjustment
PHASE_CLK	Programs the measured phase adjustment clock frequency
PHASE_CLK?	Retrieves the phase adjustment clock frequency
PHASE_ZERO	Zeros the relative phase adjustment
AMPLITUDE MODULATION	
AM	Programs the AM depth
AM?	Retrieves the AM depth
EXTAC_AM	Turns external ac-coupled AM ON or OFF
EXTAC_AM?	Retrieves the state of external ac-coupled AM
EXTDC_AM	Turns external dc-coupled AM ON or OFF
EXTDC_AM?	Retrieves the state of external dc-coupled AM
INT_AM	Turns internal AM ON or OFF
INT_AM?	Retrieves the state of internal AM



Table 5B-1. Remote Command Summary (cont)

FREQUENCY AND PHASE MODULATION	
EXTAC_FM	Turns external ac-coupled FM/ØM ON or OFF
EXTAC_FM?	Retrieves the state of external ac-coupled FM/ØM
EXTDC_FM	Turns external dc-coupled FM or ØM ON or OFF
EXTDC_FM?	Retrieves the state of external dc-coupled FM or ØM
FM	Programs the FM/ØM deviation
FM?	Retrieves the FM/ØM deviation
FM_RANGE	Selects normal, low-distortion, or fixed-range FM
FM_RANGE?	Retrieves the state of low distortion/fixe range FM
FM_UNITS	Converts the FM display to specified units
HIRATEPM	Turns high rate ØM mode ON or OFF
HIRATEPM?	Retrieves the state of high rate ØM mode
INT_FM	Turns internal FM/ØM ON or OFF
INT_FM?	Retrieves the state of internal FM/ØM
LORATEFM	Turns low rate FM mode ON or OFF
LORATEFM?	Retrieves the state of low rate FM mode
PULSE MODULATION	
EXT_PULSE	Turns external pulse modulation ON or OFF
EXT_PULSE?	Retrieves the state of external pulse modulation
INT_PULSE	Turns internal pulse modulation ON or OFF
INT_PULSE?	Retrieves the state of internal pulse modulation
INTERNAL MODULATION OSCILLATOR	
MOD_WAVE	Selects the modulation oscillator waveform
MOD_WAVE?	Retrieves the modulation oscillator waveform
MODF	Programs the modulation frequency
MODF?	Retrieves the modulation frequency
MODL	Programs the modulation level
MODL?	Retrieves the modulation level
MODOUT	Selects the state of the MOD OUTPUT port
MODOUT?	Retrieves the state of the MOD OUTPUT port
PULSE_WIDTH	Programs the modulation oscillator pulse width
PULSE_WIDTH?	Retrieves the modulation oscillator pulse width
SWEEP	
AMPL_MANUAL	Increments or decrements manual amplitude sweep
AMPL_SINCR	Programs the amplitude sweep increment
AMPL_SINCR?	Retrieves the amplitude sweep increment
AMPL_SWIDTH	Programs the amplitude sweep width
AMPL_SWIDTH?	Retrieves the amplitude sweep width
FREQ_MANUAL	Increments or decrement the manual frequency sweep
FREQ_SINCR	Programs the frequency sweep increment
FREQ_SINCR?	Retrieves the frequency sweep increment
FREQ_SWIDTH	Programs the frequency sweep width

**REMOTE OPERATION  
REMOTE COMMAND TABLES**

**Table 5B-1. Remote Command Summary (cont)**

FREQ_SWIDTH?	Retrieves the frequency sweep width
SWEEP	Selects the sweep mode
SWEEP?	Retrieves the sweep mode
SWEEP_DWELL	Programs the sweep dwell time
SWEEP_DWELL?	Retrieves the sweep dwell time
SWEEP_FIELD	Selects the sweep field
SWEEP_FIELD?	Retrieves the sweep field
SWEEP_SYM	Selects the sweep symmetry
SWEEP_SYM?	Retrieves the sweep symmetry
<b>MISCELLANEOUS</b>	
*DDT	Defines the device trigger buffer
*DDT?	Queries the device trigger buffer
DISPLAY	Selects the display status
DISPLAY?	Retrieves the display status
GAL	Goes to alternate language
KEY_RATE	Selects the repeat rate for the step keys
KEY_RATE?	Retrieves the key repeat rate
KNOB_STEP	Selects the operation of the knob and step up/down keys
KNOB_STEP?	Retrieves the state of the knob and step up/down keys
LOCALERT	Programs mode to generate an SRQ on complete front panel operations
LOCALERT?	Retrieves the state of the local alert (LOCALERT) mode
MOD_DISPLAY	Selects the quantity to be shown in the modulation field
MOD_DISPLAY?	Retrieves the quantity shown in the modulation field
*OPC	Programs bit 0 in the ESR when pending remote operations are complete
*OPC?	Replies with "1" when all pending operations are complete
*OPT?	Retrieves report of installed options
PRESET	Resets instrument to preset state
*PUD	Defines protected user data buffer
*PUD?	Retrieves protected user data buffer
*RST	Resets instrument to default memory location
SECURITY	Selects the secure mode status
SECURITY?	Retrieves the secure mode status
SPCL	Selects a special function by number
*TRG	Triggers device
*WAI	Waits until all pending remote operations are complete
<b>INSTRUMENT STATE MEMORY</b>	
ERASE_RPT	Sets nonvolatile memory erase repeat count
ERASE_RPT?	Retrieves nonvolatile memory erase repeat count
MEM_DIVIDER	Programs memory divider locations
MEM_DIVIDER?	Retrieves memory divider locations
MEM_ERASE	Erases nonvolatile memory
MEM_LOCK	Write-protects instrument state memory
MEM_LOCK?	Retrieves the state of memory lock protection
MEM_RESET	Resets all memory locations to instrument default
*RCL	Recalls a memory location
*SAV	Saves to a memory location
SEQ	Recalls the next or previous memory location

Table 5B-1. Remote Command Summary (cont)

STEP	
AM_STEP	Programs the AM depth step size
AM_STEP?	Retrieves the AM depth step size
AMPL_STEP	Programs the RF output amplitude step size
AMPL_STEP?	Retrieves the RF output amplitude step size
FM_STEP	Programs the FM/ØM deviation step size
FM_STEP?	Retrieves the FM/ØM deviation step size
FREQ_STEP	Programs the output frequency step size
FREQ_STEP?	Retrieves the output frequency step size
MODF_STEP	Programs the modulation frequency step size
MODF_STEP?	Retrieves the modulation frequency step size
MODL_STEP	Programs the modulation level step size
MODL_STEP?	Retrieves the modulation level step size
SD	Steps the active step field down by one step size
STEP_AM	Steps the AM depth up or down by one step size
STEP_AMPL	Steps the output amplitude up or down by one step size
STEP_FIELD	Selects the step field
STEP_FIELD?	Retrieves the step field
STEP_FM	Steps the FM/ØM deviation up or down by one step size
STEP_FREQ	Steps the output frequency up or down by one step size
STEP_MODF	Steps the modulation frequency up or down by one step size
STEP_MODL	Steps the modulation level up or down by one step size
SU	Steps the active step field up by one step size
EDIT	
AM_BRT	Moves bright digit to specified decade in AM field
AM_BRT?	Retrieves decade of AM bright-digit position
AMPL_BRT	Moves bright digit to specified decade in amplitude field
AMPL_BRT?	Retrieves decade of amplitude bright-digit position
BRT_FIELD	Programs bright-digit field
BRT_FIELD?	Retrieves current bright-digit field
EDIT_AM	Selects AM bright-digit field and edits AM
EDIT_AMPL	Selects amplitude bright-digit field and edits amplitude
EDIT_FM	Selects FM/ØM bright-digit field and edits FM/ØM
EDIT_FREQ	Selects frequency bright-digit field and edits frequency
EDIT_MODF	Selects modulation freq bright-digit field and edits modulation freq
EDIT_MODL	Selects modulation level bright-digit field and edits modulation level
FM_BRT	Moves bright digit to specified decade in FM/ØM field
FM_BRT?	Retrieves decade of FM/ØM bright-digit position
FREQ_BRT	Moves bright digit to specified decade in frequency field
FREQ_BRT?	Retrieves decade of frequency bright-digit position
MODF_BRT	Moves bright digit to specified decade in modulation freq field
MODF_BRT?	Retrieves decade of modulation frequency bright-digit position
MODL_BRT	Moves bright digit to specified decade in modulation level field
MODL_BRT?	Retrieves decade of modulation level bright-digit position

REMOTE OPERATION  
REMOTE COMMAND TABLES

Table 5B-1. Remote Command Summary (cont)

STATUS/ERROR	
*CLS	Clears status
ERROR?	Retrieves an error code from the error queue
*ESE	Loads Event Status Enable register
*ESE?	Retrieves Event Status Enable register
*ESR?	Retrieves and clears the Event Status Register
EXPLAIN?	Explains a status/error code
*IDN?	Retrieves instrument identification.
ISCE	Loads instrument Status Change Enable register
ISCE?	Retrieves Instrument Status Change Enable register
ISCR?	Retrieves and clears Instrument Status Change Register
ISR?	Retrieves and clears Instrument Status Register
*SRE	Loads Service Request Enable register
*SRE?	Retrieves Service Request Enable register
STATUS	Loads specified status into the status queue
STATUS?	Retrieves a status code from the status queue
*STB?	Retrieves the status byte
SERVICE	
ATT_LOG?	Retrieves the attenuator log
CAL_AM	Initiates AM calibration procedure
CAL_FM	Initiates FM calibration procedure
CAL_LEVEL	Initiates level calibration procedure
CAL_REFOSC	Initiates reference oscillator calibration procedure
CC_BRKFREQ?	Returns attenuator compensation procedure break frequency
CC_ERRFREQ?	Returns frequency where automatic compensation procedure failed
CC_EXIT	Exits calibration/compensation procedure
CC_FREQ?	Retrieves the RF output frequency during calibration/compensation procedure
CC_RDAM	Reports measured AM depth to calibration procedure
CC_RDDVM	Reports measured voltage to compensation procedure
CC_RDFM	Reports measured FM deviation to calibration procedure
CC_RDFREQ	Reports measured RF output frequency to calibration procedure
CC_RDPOWER	Reports measured power to cal/comp procedure
CC_RESUME	Resumes attenuator compensation procedure
CC_SAVE	Calculates corrections, save new data in cal/comp memory
CC_TARGET?	Returns target value of compensation procedure
CMEM_CLRALT	Clears alternate output compensation data
CMEM_FIX	Repairs compensation memory checksum errors
COMP_ATTPMTR	Initiates attenuator compensation procedure with power meter
COMP_ATT	Initiates attenuator compensation procedure
COMP_COARSE	Initiates automatic coarse loop compensation procedure
COMP_OUT	Initiates output compensation procedure
COMP_OUTDEF	Initiates output compensation procedure with default
COMP_SUBSYN	Initiates subsynthesizer compensation procedure
COMP_SUM	Initiates automatic sum loop compensation procedure
ETIME?	Retrieves the elapsed time
TEST_ATT	Programs alternate attenuator settings
TEST_DISP	Executes display test
*TST?	Executes self-test

Table 5B-2. Units Used with Remote Commands

UNIT	DESCRIPTION
HZ	Frequency, hertz
KHZ	Frequency, kilohertz
MHZ	Frequency, megahertz
MAHZ	Frequency, megahertz
GHZ	Frequency, gigahertz
V	Voltage (amplitude), volts
MV	Voltage (amplitude), millivolts
UV	Voltage (amplitude), microvolts
NV	Voltage (amplitude), nanovolts
DBMV	Voltage (amplitude), decibels referenced to 1 millivolt
DBUV	Voltage (amplitude), decibels referenced to 1 microvolt
DB	Ratio, decibels
DBM	Power (amplitude), decibels referenced to 1 milliwatt
DBMW	Power (amplitude), decibels referenced to 1 milliwatt
DBF	Power (amplitude), decibels referenced to 1 femtowatt
DBFW	Power (amplitude), decibels referenced to 1 femtowatt
PCT	Ratio (AM depth), percent
%	Ratio (AM depth), percent
DEG	Angle (RF Frequency Phase Adjust), degrees
RAD	Angle (ØM phase), radians
S	Time, seconds
MS	Time, milliseconds
US	Time, microseconds

Table 5B-3. Remote Commands

<b>AM</b>	Description:	Programs the AM depth in percent. The default units are PCT.
	Parameter:	AM depth with optional PCT or % units.
	Examples:	AM 63.2 PCT AM 63.2 %
	Restrictions:	Rejected during manual or single sweep.
<b>AM?</b>	Description:	Retrieves the AM depth.
	Parameter:	None
	Responses:	1. (Float) AM depth. 2. (String) PCT
	Example:	6.320E+01,PCT
<b>AM_BRT</b>	Description:	Moves the bright digit to specified decade in AM field. The default units are PCT.
	Parameter:	Bright-digit decade in AM display with optional PCT or % units.
	Examples:	AM_BRT 1 PCT AM_BRT 1 %
	Restrictions:	Rejected during manual or single sweep.
<b>AM_BRT?</b>	Description:	Retrieves the decade of AM bright-digit position.
	Parameter:	None
	Responses:	1. (Float) Bright-digit decade in AM display. 2. (String) PCT
	Example:	1.0E+0,PCT
<b>AM_STEP</b>	Description:	Programs the AM depth step size in percent. The default units are PCT.
	Parameter:	AM depth step size with optional PCT or % units.
	Restrictions:	Rejected during manual or single sweep.
<b>AM_STEP?</b>	Description:	Retrieves the AM depth step size.
	Parameter:	None
	Responses:	1. (Float) AM depth step size. 2. (String) PCT

Table 5B-3. Remote Commands (cont)

<b>AMPL</b>	
Description:	Programs the displayed RF amplitude in dBm, dB $\mu$ V, dBmV, dBf, dB, or V. Default units are DBM. If REL_AMPL is OFF, this is the output RF level. Refer to Section 4B, "RF Amplitude" for more details. If Auto Amplitude Sweep is active, programs the center Amplitude. Refer to Section 4E, "Sweep" for more information.
Parameter:	Displayed RF amplitude with optional power, voltage, or DB units.
Examples:	AMPL 174 MV AMPL -10.0
Restrictions:	Rejected during manual or single sweep.
<b>AMPL?</b>	
Description:	Retrieves the displayed RF amplitude. If REL_AMPL is OFF, this is the output RF level. If Amplitude Sweep is active, returns the center Amplitude. Refer to section 4E, "Sweep" for more information.
Parameter:	None
Responses:	1. (Float) Displayed RF amplitude. 2. (String) DBM, DBUV, DBMV, DBF, DB, V, DBUV-EMF, DBMV-EMF, or V-EMF
Examples:	1.7400E-01,V -1.0000E+01,DBM
<b>AMPL_ABS?</b>	
Description:	Retrieves the RF output level.
Parameter:	None
Responses:	1. (Float) Output RF amplitude. 2. (String) DBM, DBUV, DBMV, DBF, V, DBUV-EMF, DBMV-EMF, or V-EMF
<b>AMPL_BASE?</b>	
Description:	Retrieves the base amplitude. If AMPL_REL is OFF, this value is 0 dB. Refer to Section 4B, "RF Amplitude" for more details.
Parameter:	None
Responses:	1. (Float) Base RF amplitude. 2. (String) DB, V, or V-EMF

Table 5B-3. Remote Commands (cont)

<b>AMPL_BRT</b>	
Description:	Moves the bright digit to specified decade in amplitude field. Note that the units must match the displayed units (e.g. V, MV, UV or NV for Volts; DBM, DBUV, DBMV, or DBF for dB) when specifying the bright-digit position. The default units are DBM.
Parameter:	Bright-digit decade in AMPLITUDE display field with optional power, voltage, or DB units.
Examples:	AMPL_BRT 10 UV AMPL_BRT .1 DBM
Restrictions:	Rejected during manual or single sweep.
<b>AMPL_BRT?</b>	
Description:	Retrieves the decade of amplitude bright-digit position.
Parameter:	None
Responses:	1. (Float) Bright-digit decade in AMPLITUDE display field. 2. (String) DBM, DBUV, DBMV, DB, or V
Example:	1.0E-7,V
<b>AMPL_CMPDAT</b>	
Description:	Selects standard or alternate output level compensation data.
Parameter:	STD or ALT
Restrictions:	Rejected during sweep.
<b>AMPL_CMPDAT?</b>	
Description:	Retrieves the output level compensation state.
Response:	(String) STD or ALT
<b>AMPL_COMP</b>	
Description:	Selects the amplitude compensation mode.
Parameter:	ALL or OUTPUT or NONE
Restrictions:	Rejected during sweep.
<b>AMPL_COMP?</b>	
Description:	Retrieves the state of amplitude compensation mode.
Parameter:	None
Response:	(String) ALL or OUTPUT or NONE
<b>AMPL_EMFOUT</b>	
Description:	Selects EMF output mode.
Parameter:	ON or OFF or 1 or 0
Restrictions:	Rejected during sweep.



Table 5B-3. Remote Commands (cont)

<b>AMPL_EMFOUT?</b>	
Description:	Retrieves the state of EMF output mode.
Parameter:	None
Response:	(String) ON or OFF
<b>AMPL_MANUAL</b>	
Description:	Increments or decrements the active manual amplitude sweep by specified number of counts. Note that the sign of sweep width affects the outcome of this operation.
Parameter:	Number of counts to increment or decrement the active manual amplitude sweep.
Restrictions:	Only allowed during manual amplitude sweep.
<b>AMPL_RANGE</b>	
Description:	Selects amplitude range mode.
Parameter:	NORMAL or FIXED
Restrictions:	Rejected during sweep.
<b>AMPL_RANGE?</b>	
Description:	Retrieves the state of amplitude range mode.
Parameter:	None
Response:	(String) NORMAL or FIXED
<b>AMPL_REL</b>	
Description:	Selects relative amplitude mode. Refer to Section 4B, "RF Amplitude" for more details.
Parameter:	ON or OFF or 1 or 0
Restrictions:	Rejected during sweep.
<b>AMPL_REL?</b>	
Description:	Retrieves the state of relative amplitude mode.
Parameter:	None
Response:	(String) ON or OFF
<b>AMPL_SINCR</b>	
Description:	Programs the amplitude sweep increment in dB or V. The default units are DB.
Parameter:	Increment with optional DB units or voltage units.
Restrictions:	Rejected during manual or single sweep.

Table 5B-3. Remote Commands (cont)

<b>AMPL_SINCR?</b>	Description: Retrieves the amplitude sweep increment.
Parameter:	None
Responses:	1. (Float) Amplitude sweep increment. 2. (String) DB, V, or V-EMF
<b>AMPL_STEP</b>	Description: Programs the amplitude step size in dB or V. The default units are DB.
Parameter:	Amplitude step size with optional DB units or voltage units.
Restrictions:	Rejected during manual or single sweep.
<b>AMPL_STEP?</b>	Description: Retrieves the amplitude step size.
Parameter:	None
Responses:	1. (Float) Amplitude step size. 2. (String) DB, V, or V-EMF
<b>AMPL_SWIDTH</b>	Description: Programs the amplitude sweep width in dB or V. The default units are DB. Note that a negative value will cause a sweep from a higher power level to a lower one.
Parameter:	Sweep width with optional DB units or voltage units.
Example:	AMPL_SWIDTH -1.820E-6 V AMPL_SWIDTH 10.2 DB AMPL_SWIDTH 2
Restrictions:	Rejected during manual or single sweep.
<b>AMPL_SWIDTH?</b>	Description: Retrieves the amplitude sweep width.
Parameter:	None
Responses:	1. (Float) Amplitude sweep width. 2. (String) DB, V, or V-EMF
<b>AMPL_UNITS</b>	Description: Converts the AMPLITUDE display to specified units.
Parameter:	DBM or V
Restrictions:	Rejected during sweep.

Table 5B-3. Remote Commands (cont)

<b>ATT_LOG?</b>	
Description:	Retrieves the attenuator log.
Parameter:	None
Responses:	<ol style="list-style-type: none"> <li>1. (Integer) A6 attenuator count.</li> <li>2. (Integer) A12 attenuator count.</li> <li>3. (Integer) A24A attenuator count.</li> <li>4. (Integer) A24B attenuator count.</li> <li>5. (Integer) A24C attenuator count.</li> <li>6. (Integer) A24D attenuator count.</li> <li>7. (Integer) A24E attenuator count.</li> </ol>
Example:	1470,1180,641,627,607,587,577
<b>BRT_FIELD</b>	
Description:	Moves the bright digit to the specified field.
Parameter:	AM or AMPL or FM or FREQ or MODF or MODL
Restrictions:	Rejected during sweep.
<b>BRT_FIELD?</b>	
Description:	Retrieves the current bright-digit field.
Parameter:	None
Response:	(String) AM or AMPL or FM or FREQ or MODF or MODL
<b>CAL_AM</b>	
Description:	Initiates AM calibration procedure. Note that the rear panel CAL COMP switch must be set to 1 (on).
Parameter:	None
Restrictions:	Rejected during a calibration or compensation procedure, or during sweep.
<b>CAL_FM</b>	
Description:	Initiates FM calibration procedure. Note that the rear panel CAL COMP switch must be set to 1 (on).
Parameter:	None
Restrictions:	Rejected during a calibration or compensation procedure, or during sweep.
<b>CAL_LEVEL</b>	
Description:	Initiates level calibration procedure. Note that the rear panel CAL COMP switch must be set to 1 (on).
Parameter:	None
Restrictions:	Rejected during a calibration or compensation procedure, or during sweep.

Table 5B-3. Remote Commands (cont)

<b>CAL_REFOSC</b>	
Description:	Initiates reference oscillator calibration procedure. Note that the rear panel CAL COMP switch must be set to 1 (on).
Parameter:	None
Restrictions:	Rejected during a calibration or compensation procedure, or during sweep.
<b>CC_BRKFREQ?</b>	
Description:	Returns attenuator compensation procedure break frequency.
Parameter:	None
Responses:	1. (Float) Frequency 2. (String) HZ
<b>CC_ERRFREQ?</b>	
Description:	Returns error code and frequency where automatic comp procedure failed. If no errors were generated, a zero is returned for both the error code and frequency responses.
Parameter:	None
Responses:	1. (Integer) Error Code 2. (Float) Frequency 3. (String) HZ
<b>CC_EXIT</b>	
Description:	Exits calibration/compensation procedure.
Parameter:	None
Restrictions:	Only allowed when performing a calibration or compensation procedure.
<b>CC_FREQ?</b>	
Description:	Retrieves the RF output frequency during calibration/compensation procedure.
Parameter:	None
Responses:	1. (Float) Output frequency 2. (String) HZ
Restrictions:	Only allowed when performing a calibration procedure or attenuator, output, or subsynthesizer compensation procedure.

**Table 5B-3. Remote Commands (cont)**

<b>CC_HETADJ?</b>	
Description:	Returns Het band frequency and level adjustments where Het level adjustment can be made following an unsuccessful output compensation procedure. If no output compensation procedure has been performed since power-on, a zero is returned for both frequency and adjustment responses.
Parameter:	None
Responses:	<ol style="list-style-type: none"> <li>1. (Float) Frequency</li> <li>2. (String) HZ</li> <li>3. (Float) Level Adjustment</li> <li>4. (String) DB</li> </ol>
<b>CC_RDAM</b>	
Description:	Reports measured AM depth to calibration procedure. Default units are PCT.
Parameter:	AM depth with optional PCT or % units.
Restrictions:	Only allowed when performing an AM calibration procedure.
<b>CC_RDDVM</b>	
Description:	Reports measured voltage to compensation procedure. Default units are V.
Parameter:	Voltage with optional voltage units.
Restrictions:	Only allowed when performing a sub-synthesizer compensation procedure.
<b>CC_RDFM</b>	
Description:	Reports measured FM deviation to calibration procedure. Default units are HZ.
Parameter:	FM deviation with optional frequency units.
Restrictions:	Only allowed when performing an FM calibration procedure.
<b>CC_RDFREQ</b>	
Description:	Reports measured RF frequency to calibration procedure. Default units are HZ.
Parameter:	Frequency with optional frequency units.
Restrictions:	Only allowed when performing a reference oscillator calibration procedure.
<b>CC_RDPOWER</b>	
Description:	Reports measured power to calibration/compensation procedure. Default units are DBM.
Parameter:	Output power with optional DBM units.
Restrictions:	Only allowed when performing a level calibration or attenuator or output compensation procedure.
<b>CC_RESUME</b>	
Description:	Resumes attenuator compensation procedure after calibrating level measurement equipment.
Parameter:	None
Restrictions:	Only allowed during remote attenuator compensation procedure.

Table 5B-3. Remote Commands (cont)

<b>CC_SAVE</b>	
Description:	Calculates corrections, save new data in calibration/compensation memory. Note that the rear panel CAL COMP switch must be set to 1 (on).
Parameter:	None
Restrictions:	Only allowed when performing a calibration procedure or attenuator, output, or subsynthesizer compensation procedure.
<b>CC_TARGET?</b>	
Description:	Returns target value of calibration/compensation procedure.
Parameter:	None
Responses:	1. (Float): Target value. 2. (String) PCT, HZ, DBM, or V
Restrictions:	Only allowed when performing a calibration procedure or attenuator, output, or subsynthesizer compensation procedure.
<b>*CLS</b>	
Description:	Clears status. Clears the ESR, the ISCR, and the error and status queues. Terminates a pending operation complete command (*OPC or *OPC?).
Parameter:	None
<b>CMEM_CLRALT</b>	
Description:	Clears alternate output compensation data. Note that the rear panel CAL COMP switch must be set to 1 (on).
Parameter:	None
<b>CMEM_FIX</b>	
Description:	Repairs calibration/compensation memory checksum errors. Note that the rear panel CAL COMP switch must be set to 1 (on).
Parameter:	None
Restrictions:	Rejected during a calibration or compensation procedure, or during sweep.
<b>COMP_ATT</b>	
Description:	Initiates attenuator compensation procedure. Note that the rear panel CAL COMP switch must be set to 1 (on).
Parameter:	None
Restrictions:	Rejected during a calibration or compensation procedure, or during sweep.
<b>COMP_ATTPMTR</b>	
Description:	Initiates attenuator compensation procedure with power meter. Note that the rear panel CAL COMP switch must be set to 1 (on).
Parameter:	None
Restrictions:	Rejected during a calibration or compensation procedure, or during sweep.

Table 5B-3. Remote Commands (cont)

**COMP\_COARSE**

Description: Initiates automatic coarse loop compensation procedure. Note that the rear panel CAL|COMP switch must be set to 1 (on).

Parameter: None

Restrictions: Rejected during a calibration or compensation procedure, or during sweep.

**COMP\_OUT**

Description: Initiates output compensation procedure. Note that the rear panel CAL|COMP switch must be set to 1 (on).

Parameter: None

Restrictions: Rejected during a calibration or compensation procedure, or during sweep.

**COMP\_OUTDEF**

Description: Initiates output compensation procedure with default attenuator through-path corrections applied. Note that the rear panel CAL|COMP switch must be set to 1 (on).

Parameter: None

Restrictions: Rejected during a calibration or compensation procedure, or during sweep.

**COMP\_SUBSYN**

Description: Initiates subsynthesizer compensation procedure. Note that the rear panel CAL|COMP switch must be set to ON.

Parameter: None

Restrictions: Rejected during a calibration or compensation procedure, or during sweep.

**COMP\_SUM**

Description: Initiates automatic sum loop compensation procedure. Note that the rear panel CAL|COMP switch must be set to 1 (on).

Parameter: None

Restrictions: Rejected during a calibration or compensation procedure, or during sweep.

Table 5B-3. Remote Commands (cont)

<b>*DDT</b>	
Description:	Defines device trigger. Used to load commands into the device trigger buffer for subsequent execution when a *TRG common command or the group execute trigger (GET) IEEE-488.1 interface message is received. The syntax of the data loaded is not checked until the trigger command is received. A *TRG command in the trigger buffer will cause an Execution Error when the trigger command is received.
Parameter:	#0<user data><ASCII Line Feed with EOI> or #<non-zero digit><digits><user data>
	For both forms, the bytes received in the <user data> field are stored in non-volatile memory and up to 72 bytes are allowed. The first form accepts data bytes after the #0 until the ASCII Line Feed character is received with an EOI signal.
	In the second form, the non-zero digit specifies the number of characters that will follow in the <digits> field. These characters must be 0 through 9 (ASCII 48 through 57 decimal). The value of the number in the <digits> field defines the number of user data bytes that will follow in the <user data> field.
Examples:	*DDT #0STEP_FREQ UP<Line Feed with EOI> or *DDT #212STEP_FREQ UP
	<b>NOTE</b>
	The 2 indicates that there are two digits to follow (in this case "12"), and the 12 indicates that there are twelve characters in the remainder of the *DDT message (in this case, "STEP_FREQ UP").
<b>*DDT?</b>	
Description:	Retrieves the contents of the *DDT (Define Device Trigger) buffer.
Parameter:	None
Response:	#<non-zero digit><digits><user data>
	The non-zero digit specifies the number of characters that will follow in the <digits> field. These characters are 0 through 9 (ASCII 48 through 57 decimal). The value of the number in the <digits> field defines the number of user data bytes that follow in the <user data> field. The maximum response is 72 characters.
Example:	#212STEP_FREQ UP
<b>DISPLAY</b>	
Description:	Selects the display status.
Parameter:	ON or OFF
Restrictions:	Display ON is rejected in secure mode.



**Table 5B-3. Remote Commands (cont)**

<b>DISPLAY?</b>	
Description:	Retrieves the display status.
Parameter:	None
Response:	(String) ON or OFF
<b>EDIT_AM</b>	
Description:	Selects the AM bright-digit field and edit AM by the specified number of counts.
Parameter:	Number of counts by which bright digit is edited.
Example:	AM_BRT 1 PCT; EDIT_AM -18
Restrictions:	Rejected during manual or single sweep.
<b>EDIT_AMPL</b>	
Description:	Selects the amplitude bright-digit field and edit amplitude by the specified number of counts.
Parameter:	Number of counts by which bright digit is edited.
Example:	EDIT_AMPL 293
Restrictions:	Rejected during manual or single sweep.
<b>EDIT_FM</b>	
Description:	Selects the FM bright-digit field and edit FM by the specified number of counts.
Parameter:	Number of counts by which bright digit is edited.
Restrictions:	Rejected during manual or single sweep.
<b>EDIT_FREQ</b>	
Description:	Selects the frequency bright-digit field and edit frequency by the specified number of counts.
Parameter:	Number of counts by which bright digit is edited.
Example:	FREQ_BRT 1 HZ; EDIT_FREQ 172
Restrictions:	Rejected during manual or single sweep.
<b>EDIT_MODF</b>	
Description:	Selects the modulation frequency bright-digit field and edit modulation frequency by the specified number of counts.
Parameter:	Number of counts by which bright digit is edited.
Restrictions:	Rejected during manual or single sweep.
<b>EDIT_MODL</b>	
Description:	Selects the modulation level bright-digit field and edit modulation level by the specified number of counts.
Parameter:	Number of counts by which bright digit is edited.
Restrictions:	Rejected during manual or single sweep.

Table 5B-3. Remote Commands (cont)

<b>ERASE_RPT</b>	
Description:	Programs the nonvolatile memory erase repeat count for the MEM_ERASE command. The default is 12.
Parameter:	Number of counts for erase operation to repeat (12-99 allowed).
<b>ERASE_RPT?</b>	
Description:	Retrieves the nonvolatile memory erase repeat count for the MEM_ERASE command.
Parameter:	None
Response:	(Integer) Erase operation repeat count.
<b>ERROR?</b>	
Description:	Retrieves earliest error code from the error queue. If no error codes are pending, a zero is returned. If the optional keyword EXPLAIN is specified, a character string containing its explanation is returned with the error code.
Parameter:	(optional) EXPLAIN
Examples:	FREQ 100 GHZ; ERROR? EXPLAIN
	Returns: 1, "Frequency out of range"
	FREQ 100 GHZ; ERROR?
	Returns: 1
Responses:	1. (Integer) The error code. 2. (optional) (String) The explanation of the code.
<b>*ESE</b>	
Description:	Loads a byte into the Event Status Enable Register, described under "Checking the Instrument Status".
Parameter:	The decimal equivalent of the binary number to load into the register (0-255 only).
Example:	*ESE 140
	Enables bits 2 (QYE), 3 (DDE), and 7 (PON), and disables all the other bits. (See "Checking the Instrument Status" for details.)
<b>*ESE?</b>	
Description:	Retrieves the byte from the Event Status Enable register, described under "Checking the Instrument Status".
Parameter:	None
Response:	(Integer) Decimal equivalent of the register byte.
Example:	*ESE?
	Returns: "140" if bits 2 (QYE), 3 (DDE), and 7 (PON) are enabled (1) and the rest of the bits are disabled (0). (See "Checking the Instrument Status" for details.)

Table 5B-3. Remote Commands (cont)

<b>*ESR?</b>	
Description:	Retrieves the byte from the Event Status Register and clears the register. The ESR is described under "Checking the Instrument Status".
Parameter:	None
Response:	(Integer) Decimal equivalent of the register byte.
Example:	*ESR?  Returns: "140" if bits 2 (QYE), 3 (DDE), and 7 (PON) are set (1) and the rest of the bits are reset (0). (See "Checking the Instrument Status" for details.)
<b>ETIME?</b>	
Description:	Retrieves the elapsed time. This gives the time (with tenths-of-hours resolution) that the Signal Generator has been in operation since it was manufactured.
Parameter:	None
Responses:	1. (Float) Total number of hours the instrument has been operating. 2. (String) HRS
Example:	5058.7,HRS
<b>EXPLAIN?</b>	
Description:	Explains a status/error code. This command returns a string which is the explanation of the status or error code furnished as the parameter. The controller will most likely obtain the code via the STATUS? or ERROR? query. Refer to Appendices C, D, and E for a list of status and error codes.
Parameter:	The error/status code to explain.
Response:	(String) The explanation of the code.
Example:	EXPLAIN? 1 Returns: "Frequency out of range"
<b>EXT_PULSE</b>	
Description:	Turns external pulse modulation On or Off.
Parameter:	ON or OFF or 1 or 0
Restrictions:	Rejected during single sweep.
<b>EXT_PULSE?</b>	
Description:	Retrieves the state of external pulse modulation.
Parameter:	None
Response:	(String) ON or OFF
<b>EXTAC_AM</b>	
Description:	Turns external AM (AC coupled) On or Off
Parameter:	ON or OFF or 1 or 0
Restrictions:	Rejected during single sweep.

Table 5B-3. Remote Commands (cont)

<b>EXTAC_AM?</b>	
Description:	Retrieves the state of external AM (AC coupled).
Parameter:	None
Response:	(String) ON or OFF
<b>EXTAC_FM</b>	
Description:	Turns external FM (AC/ØM coupled) On or Off.
Parameter:	ON or OFF or 1 or 0
Restrictions:	Rejected during single sweep.
<b>EXTAC_FM?</b>	
Description:	Retrieves the state of external FM (AC/ØM coupled).
Parameter:	None
Response:	(String) ON or OFF
<b>EXTDC_AM</b>	
Description:	Turns external AM (DC coupled) On or Off.
Parameter:	ON or OFF
Restrictions:	Rejected during single sweep.
<b>EXTDC_AM?</b>	
Description:	Retrieves the state of external AM (DC coupled).
Parameter:	None
Response:	(String) ON or OFF
<b>EXTDC_FM</b>	
Description:	Turns external DCFM/DCØM On or Off.
Parameter:	ON or OFF
Restrictions:	Rejected during single sweep.
<b>EXTDC_FM?</b>	
Description:	Retrieves the state of external DCFM/DCØM.
Parameter:	None
Response:	(String) ON or OFF
<b>EXTREF_FREQ</b>	
Description:	Selects the external reference frequency.
Parameter:	STD (10 MHz) ALT (Refer to Section 4A, "RF Frequency")
Restrictions:	Rejected during sweep.

Table 5B-3. Remote Commands (cont)

<b>EXTREF_FREQ?</b>	
Description:	Retrieves the selected external reference frequency.
Parameter:	None
Response:	(String) STD or ALT
<b>FM</b>	
Description:	Programs the FM/ØM deviation in Hz or radians. The default units are HZ.
Parameter:	FM/ØM deviation with optional frequency or radians units.
Restrictions:	Rejected during manual or single sweep.
<b>FM?</b>	
Description:	Retrieves the FM/ØM deviation.
Parameter:	None
Responses:	1. (Float) FM/ØM deviation. 2. (String) HZ or RAD
<b>FM_BRT</b>	
Description:	Moves the bright digit to the specified decade in FM/ØM field. Note that the unit must match the displayed units (e.g. HZ, KHZ, MHZ, or GHZ for Hz; RAD for Radians) when specifying the bright-digit position. The default units are HZ.
Parameter:	Bright-digit decade in FM/ØM display field with optional frequency or radians units.
Example:	FM_BRT 10.0 KHZ
Restrictions:	Rejected during manual or single sweep.
<b>FM_BRT?</b>	
Description:	Retrieves the decade of FM/ØM bright-digit position.
Parameter:	None
Responses:	1. (Float) Bright-digit decade in FM/ØM display. 2. (String) HZ or RAD
<b>FM_RANGE</b>	
Description:	Selects normal mode or low distortion or fixed range FM.
Parameter:	NORMAL or LOWDISTORT or FIXED
Restrictions:	Rejected during sweep.
<b>FM_RANGE?</b>	
Description:	Retrieves the state of low distortion or fixed range FM.
Parameter:	None
Response:	(String) NORMAL or LOWDISTORT or FIXED

Table 5B-3. Remote Commands (cont)

<b>FM_STEP</b>	
Description:	Programs the FM/ØM deviation step size in Hz or radians. The default units are HZ.
Parameter:	FM/ØM deviation step size with optional frequency or radians units.
Example:	FM_STEP 13.26 KHZ
Restrictions:	Rejected during manual or single sweep.
<b>FM_STEP?</b>	
Description:	Retrieves the FM/ØM deviation step size.
Parameter:	None
Responses:	1. (Float) FM deviation step size. 2. (String) HZ or RAD
<b>FM_UNITS</b>	
Description:	Converts the FM/ØM display to specified units.
Parameter:	HZ or RAD
Restrictions:	Rejected during manual or single sweep.
<b>FREQ</b>	
Description:	Programs the displayed RF frequency in Hz. The default units are HZ. If FREQ_REL is OFF, this is the RF output frequency. Refer to Section 4A, "RF Frequency" for more details. If Auto Frequency Sweep is active, programs the center Frequency. Refer to Section 4E, "Sweep" for more information.
Parameter:	Frequency with frequency units.
Example:	FREQ 183.277281 MHZ
Restrictions:	Rejected during manual or single sweep.
<b>FREQ?</b>	
Description:	Retrieves the displayed RF frequency. If FREQ_REL is OFF, this is the RF output frequency. If Frequency Sweep is active, returns the center Frequency. Refer to Section 4E, "Sweep" for more information.
Parameter:	None
Responses:	1. (Float) Displayed RF frequency. 2. (String) HZ
Example:	1.832772810E+08,HZ
<b>FREQ_ABS?</b>	
Description:	Retrieves the RF output frequency.
Parameter:	None
Responses:	1. (Float) Output RF frequency. 2. (String) HZ

Table 5B-3. Remote Commands (cont)

<b>FREQ_BASE?</b>	
Description:	Retrieves the base frequency. If FREQ_REL is OFF, this value is 0. Refer to Section 4A, "RF Frequency" for more details.
Parameter:	None
Responses:	1. (Float) Base RF frequency. 2. (String) HZ
<b>FREQ_BLANK</b>	
Description:	Selects RF output blanking mode. Refer to Section 4A, "RF Frequency" for more details.
Parameter:	ON or OFF or 1 or 0
Restrictions:	Rejected during sweep.
<b>FREQ_BLANK?</b>	
Description:	Retrieves the state of RF output blanking mode.
Parameter:	ON or OFF or 1 or 0
Restrictions:	Rejected during sweep.
<b>FREQ_BRT</b>	
Description:	Moves the bright digit to specified decade in frequency field. The default units are HZ.
Parameter:	Bright-digit decade in FREQUENCY display field with optional frequency units.
Example:	FREQ_BRT 10.0 KHZ
Restrictions:	Rejected during manual or single sweep.
<b>FREQ_BRT?</b>	
Description:	Retrieves the decade of frequency bright-digit position.
Parameter:	None
Responses:	1. (Float) Bright-digit decade in FREQUENCY display. 2. (String) HZ
<b>FREQ_MANUAL</b>	
Description:	Increments or decrements the active manual frequency sweep by specified number of counts. Note that the sign of sweep width affects the outcome of this operation.
Parameter:	Number of counts to increment or decrement the active manual frequency sweep.
Restrictions:	Only allowed during manual frequency sweep.

Table 5B-3. Remote Commands (cont)

<b>FREQ_REL</b>	
Description:	Selects relative frequency mode. Refer to Section 4A, "RF Frequency" for more details.
Parameter:	ON or OFF or 1 or 0
Restrictions:	Rejected during sweep.
<b>FREQ_REL?</b>	
Description:	Retrieves the state of relative frequency mode.
Parameter:	None
Response:	(String) ON or OFF
<b>FREQ_SINCR</b>	
Description:	Programs the frequency sweep increment in Hz. The default units are HZ.
Parameter:	Sweep increment with optional frequency units.
Example:	FREQ_SINCR 123.322 KHZ
Restrictions:	Rejected during manual or single sweep.
<b>FREQ_SINCR?</b>	
Description:	Retrieves the frequency sweep increment.
Parameter:	None
Responses:	1. (Float) Frequency sweep increment. 2. (String) HZ
Example:	1.233220000E+05,HZ
<b>FREQ_STEP</b>	
Description:	Programs the frequency step size in Hz. The default units are HZ.
Parameter:	Frequency step size with optional frequency units.
Restrictions:	Rejected during manual or single sweep.
<b>FREQ_STEP?</b>	
Description:	Retrieves the frequency step size.
Parameter:	None
Responses:	1. (Float) Frequency step size. 2. (String) HZ
Example:	3.002300000E+08,HZ



Table 5B-3. Remote Commands (cont)

**FREQ\_SWIDTH**

Description: Programs the frequency sweep width in Hz. The default units are HZ. Note that a negative value will cause a sweep from a higher frequency to a lower frequency.

Parameter: Sweep width with optional frequency units.

Example: FREQ\_SWIDTH -9.634 KHZ

Restrictions: Rejected during manual or single sweep.

**FREQ\_SWIDTH?**

Description: Retrieves the frequency sweep width.

Parameter: None

Responses: 1. (Float) Frequency sweep width.  
2. (String) HZ

Example: -9.634000000E+03,HZ

**GAL**

Description: Changes to alternate language (the specified language is "remembered" when the power is turned off). See Section 5D, "Compatibility Languages".

Parameter: L6080 or L6070 or L6060 or L8642

**HIRATEPM**

Description: Turns high rate  $\emptyset$ M mode On or Off.

Parameter: ON or OFF or 1 or 0

Restrictions: Rejected during sweep.

**HIRATEPM?**

Description: Retrieves the state of the high rate  $\emptyset$ M mode.

Parameter: None

Response: (String) ON or OFF

**\*IDN?**

Description: Retrieves instrument identification.

Parameter: None

Responses: 1. (String) FLUKE  
2. (String) Model  
3. (String) Serial Number  
4. (String) Firmware Level

Example: FLUKE,6080A,12345678,V1.0

Table 5B-3. Remote Commands (cont)

<b>INT_AM</b>	
Description:	Turns internal AM On or Off.
Parameter:	ON or OFF or 1 or 0
Restrictions:	Rejected during single sweep.
<b>INT_AM?</b>	
Description:	Retrieves the state of internal AM.
Parameter:	None
Response:	(String) ON or OFF
<b>INT_FM</b>	
Description:	Turns internal FM/ØM On or Off.
Parameter:	ON or OFF or 1 or 0
Restrictions:	Rejected during single sweep.
<b>INT_FM?</b>	
Description:	Retrieves the state of internal FM/ØM.
Parameter:	None
Response:	(String) ON or OFF
<b>INT_PULSE</b>	
Description:	Turns internal pulse modulation On or Off.
Parameter:	ON or OFF or 1 or 0
Restrictions:	Rejected during single sweep.
<b>INT_PULSE?</b>	
Description:	Retrieves the state of internal pulse modulation.
Parameter:	None
Response:	(String) ON or OFF
<b>ISCE</b>	
Description:	Loads a byte into the Instrument Status Change Enable register described under the "Checking the Instrument Status".
Parameter:	The decimal equivalent of the binary number to load into the register.
Example:	ISCE 56  Enables bits 3 (RPP), 4 (FM LO), and 5 (FM HI) in the Service Request Enable register.

Table 5B-3. Remote Commands (cont)

<b>ISCE?</b>	
Description:	Retrieves the byte from the Instrument Status Change Enable register, described under "Checking the Instrument Status".
Parameter:	None
Response:	The decimal equivalent of the register contents byte.
Example:	ISCE?
	Returns: "4" if bit 3 (RPP) is enabled (1) and the rest of the bits are disabled (0). (See "Checking the Instrument Status" for details.)
<b>ISCR?</b>	
Description:	Retrieves and clears the byte from the Instrument Status Change Register, described under "Checking the Instrument Status".
Parameter:	None
Response:	The decimal equivalent of the register contents byte.
Example:	ISCR?
	Returns: "8" if bit 3 (RPP) is set (1) and the rest of the bits are reset (0). (See "Checking the Instrument Status" for details.)
<b>ISR?</b>	
Description:	Retrieves and clears the byte from the Instrument Status Register, described under "Checking the Instrument Status".
Parameter:	None
Response:	The decimal equivalent of the register contents byte.
Example:	ISR?
	Returns: "16" if bit 4 (FM LO) is set (1) and the rest of the bits are reset (0). (See "Checking the Instrument Status" for details.)
<b>KEY_RATE</b>	
Description:	Selects the repeat rate for the step keys.
Parameter:	SLOW or MEDIUM or FAST
Restrictions:	Rejected during sweep.
<b>KEY_RATE?</b>	
Description:	Retrieves the key repeat rate.
Parameter:	None
Response:	(String) SLOW or MEDIUM or FAST

Table 5B-3. Remote Commands (cont)

<b>KNOB_STEP</b>	
Description:	Selects the operation of the knob and step up/down keys. The knob can be turned on (default) or off, the step up/down keys can be configured to perform step up/down function (default) or edit up/down function.
Parameters:	1. ON or OFF (Turns the knob on or off) 2. STEP or EDIT (Configures the step keys)
Example:	KNOB_STEP OFF, EDIT (Knob off, step keys do edits)
Restrictions:	Rejected during sweep.
<b>KNOB_STEP?</b>	
Description:	Retrieves the state of the knob and step up/down keys.
Parameter:	None
Responses:	1. (String) ON or OFF 2. (String) STEP or EDIT
Example:	OFF,EDIT (Knob off, step keys do edits)
<b>LOCALERT</b>	
Description:	Sets mode to generate an SRQ on complete front panel operations.
Parameter:	ON or OFF or 1 or 0
<b>LOCALERT?</b>	
Description:	Retrieves the state of the local alert (LOCALERT) mode.
Parameter:	None
Response:	(String) ON or OFF
<b>LORATEFM</b>	
Description:	Turns low rate FM mode On or Off.
Parameter:	ON or OFF or 1 or 0
Restrictions:	Rejected during sweep.
<b>LORATEFM?</b>	
Description:	Retrieves the state of the low rate FM mode.
Parameter:	None
Response:	(String) ON or OFF
<b>LOWNOISE</b>	
Description:	Selects low-noise external reference mode.
Parameter:	ON or OFF or 1 or 0
Restrictions:	Rejected during sweep.

Table 5B-3. Remote Commands (cont)

**LOWNOISE?**

Description: Retrieves the state of low-noise external reference mode.  
 Response: ON or OFF  
 Restrictions: Rejected during sweep.

**MEM\_DIVIDER**

Description: Programs memory divider locations for sequence operations.  
 Parameter: 1. Memory divider 1 location number  
 2. Memory divider 2 location number  
 3. Memory divider 3 location number  
 4. Memory divider 4 location number  
 Example: MEM\_DIVIDER 5, 23, 45, 30  
 Restrictions: Rejected during sweep.

**MEM\_DIVIDER?**

Description: Retrieves memory divider locations for sequence operations.  
 Parameter: None  
 Responses: 1. (Integer) Memory divider 1 location number  
 2. (Integer) Memory divider 2 location number  
 3. (Integer) Memory divider 3 location number  
 4. (Integer) Memory divider 4 location number  
 Example: 5,23,30,45

**MEM\_ERASE**

Description: Erases and reinitializes portions of nonvolatile memory, including instrument state memory locations. Note that this command turns off an active sweep.  
 Parameter: None

**MEM\_LOCK**

Description: Sets lock protection for memory store.  
 Parameter: ON or OFF or 1 or 0  
 Restrictions: Rejected during sweep.

**MEM\_LOCK?**

Description: Retrieves the state of memory lock protection.  
 Parameter: None  
 Response: (String) ON or OFF

Table 5B-3. Remote Commands (cont)

<b>MEM_RESET</b>	
Description:	Resets all memory locations to the default instrument state (memory location 97).
Parameter:	None
Restrictions:	Rejected during sweep.
<b>MOD_DISPLAY</b>	
Description:	Selects the quantity to be shown in the modulation field of the display. This command does not move the bright digit.
Parameter:	AM or FM or MODF or MODL
Restrictions:	Rejected during manual or single sweep.
<b>MOD_DISPLAY?</b>	
Description:	Retrieves the quantity shown in the modulation field Note that a value will be returned even though the display may be turned off with the DISPLAY command.
Parameter:	None
Response:	(String) AM or FM or MODF or MODL
<b>MOD_WAVE</b>	
Description:	Selects the output waveform for the modulation oscillator.
Parameter:	SINE or TRIANGLE or SQUARE or PULSE
Restrictions:	Rejected during sweep.
<b>MOD_WAVE?</b>	
Description:	Retrieves the modulation oscillator waveform.
Parameter:	None
Response:	(String) SINE or TRIANGLE or SQUARE or PULSE
<b>MODF</b>	
Description:	Programs the modulation frequency in Hz. The modulation frequency may be programmed with 0.1 Hz resolution. The default units are HZ.
Parameter:	Modulation frequency with optional frequency units.
Example:	MODF 100.0001 KHZ
Restrictions:	Rejected during manual or single sweep.
<b>MODF?</b>	
Description:	Retrieves the modulation frequency.
Parameter:	None
Responses:	1. (Float) Modulation frequency. 2. (String) HZ
Example:	1.000001000E+05,HZ

Table 5B-3. Remote Commands (cont)

<b>MODF_BRT</b>	
Description:	Moves the bright digit to specified decade in modulation frequency field. The default units are HZ.
Parameter:	Bright-digit decade in modulation frequency display field with optional frequency units.
Example:	MODF_BRT 1.0 KHZ
Restrictions:	Rejected during manual or single sweep.
<b>MODF_BRT?</b>	
Description:	Retrieves the decade of modulation frequency bright-digit position.
Parameter:	None
Responses:	1. (Float) Bright-digit decade in modulation frequency display. 2. (String) HZ
<b>MODF_STEP</b>	
Description:	Programs the modulation frequency step size in Hz. The default units are HZ.
Parameter:	Modulation frequency step size with optional frequency units.
Restrictions:	Rejected during manual or single sweep.
<b>MODF_STEP?</b>	
Description:	Retrieves the modulation frequency step size.
Parameter:	None
Responses:	1. (Float) Modulation frequency step size. 2. (String) HZ
<b>MODL</b>	
Description:	Programs the modulation level in volts. The default units are V.
Parameter:	Modulation level with optional voltage units.
Examples:	MODL 1 MODL 100 MV
Restrictions:	Rejected during manual or single sweep.
<b>MODL?</b>	
Description:	Retrieves the modulation level.
Parameter:	None
Responses:	1. (Float) Modulation level. 2. (String) V
Example:	1.000E-01,V

Table 5B-3. Remote Commands (cont)

<b>MODL_BRT</b>	
Description:	Moves the bright digit to specified decade in modulation level field. The default units are V.
Parameter:	Bright-digit decade in modulation level display field with optional voltage units.
Example:	MODL_BRT 1.0 V
Restrictions:	Rejected during manual or single sweep.
<b>MODL_BRT?</b>	
Description:	Retrieves the decade of modulation level bright-digit position.
Parameter:	None
Responses:	1. (Float) Bright-digit decade in modulation level display. 2. (String) V
<b>MODL_STEP</b>	
Description:	Programs the modulation level step size in volts. The default units are V.
Parameter:	Modulation level step with optional voltage units.
Restrictions:	Rejected during manual or single sweep.
<b>MODL_STEP?</b>	
Description:	Retrieves the modulation level step size.
Parameter:	None
Responses:	1. (Float) Modulation level step size. 2. (String) V
<b>MODOUT</b>	
Description:	Selects the state of the MOD OUTPUT port.
Parameter:	ON (modulation output always at output port) OFF (modulation output port is off)
Restrictions:	Rejected during sweep.
<b>MODOUT?</b>	
Description:	Retrieves the state of the MOD OUTPUT port.
Parameter:	None
Response:	(String) ON or OFF



Table 5B-3. Remote Commands (cont)

<b>*OPC</b>	<p>Description: Programs bit 0 (OPC for "Operation Complete") in the Event Status Register to 1 when all pending device operations are complete. The Signal Generator considers an operation complete according to the following rules.</p> <ul style="list-style-type: none"> <li>• The operation is complete when the command is processed and output has settled.</li> <li>• For those commands that do not change the output, the operation is complete when the command is processed.</li> <li>• Single sweep is complete when the sweep is complete. The operation is not complete when sweep is turned off before the sweep completes.</li> <li>• Auto and manual sweep command are complete when the starting frequency/amplitude has been programmed and the output has settled.</li> <li>• Automatic calibration/compensation procedures are complete when the procedure is complete. The operation is not complete when the procedure is aborted.</li> <li>• Other calibration/compensation procedures are complete when the first step has been programmed and the output has settled.</li> </ul> <p>Parameter: None</p>
<b>*OPC?</b>	<p>Description: Returns a 1 after all pending operations are complete. This commands causes program execution to pause until all operations are complete. (See also *WAI.)</p> <p>Parameter: None</p> <p>Response: (Integer) "1" after all operations are complete.</p>
<b>*OPT?</b>	<p>Description: Retrieves report of installed options.</p> <p>Parameter: None</p> <p>Responses: (Series of strings) A comma-separated list of the option names. Each option name includes the option number and a description. If the option is not installed, a zero is returned instead of the string.</p> <p>Examples: -130 High Stability Reference,-830 Rear Output 0,-830 Rear Output</p>
<b>PHASE</b>	<p>Description: Adjusts the phase of the RF carrier.</p> <p>Parameter: Phase adjustment with degrees units.</p> <p>Example: PHASE 1 DEG</p> <p>Restrictions: Rejected during sweep.</p>

Table 5B-3. Remote Commands (cont)

<b>PHASE?</b>	
Description:	Retrieves the relative phase adjustment.
Parameter:	None
Response:	1. (Float) Relative phase adjustment. 2. (String) DEG
<b>PHASE_CLK</b>	
Description:	Programs the measured phase adjustment clock frequency. Note that the rear panel CAL COMP switch must be set to 1 (on).
Parameter:	Clock frequency with frequency units.
Restrictions:	Rejected during sweep.
<b>PHASE_CLK?</b>	
Description:	Retrieves the phase adjustment clock frequency.
Parameter:	1. (Float) Clock frequency 2. (String) Hz
<b>PHASE_ZERO</b>	
Description:	Zeros the relative phase adjustment.
Parameter:	None
Restrictions:	Rejected during sweep.
<b>PRESET</b>	
Description:	Resets instrument to preset state. See Appendix A, "Instrument Preset State".
Parameter:	None
<b>*PUD</b>	
Description:	Defines protected user data data. This command allows you to store a string of bytes in non-volatile memory. This command works only when the CAL COMP switch is in the 1 (on) position.
Parameter:	#0 <user data> <ASCII Line Feed with EOI> or #<non-zero digit> <digits> <user data>
<p>For both forms, the bytes received in the &lt;user data&gt; field are stored in non-volatile memory and up to 63 bytes are allowed. The first form accepts data bytes after the #0 until the ASCII Line Feed character is received with an EOI signal.</p> <p>In the second form, the non-zero digit specifies the number of characters that will follow in the &lt;digits&gt; field. These characters must be 0 through 9 (ASCII 48 through 57 decimal). The value of the number in the &lt;digits&gt; field defines the number of user data bytes that will follow in the &lt;user data&gt; field.</p>	

Table 5B-3. Remote Commands (cont)

Examples: Stores the word "FLUKE" in the protected user data area:

\*PUD #0FLUKE<Line Feed with EOI>

or

\*PUD #15FLUKE

**NOTE**

The 1 indicates that there is one digit to follow (in this case, "5"), and the 5 indicates that there are five characters in the remainder of the \*PUD message (in this case, "FLUKE").

**\*PUD?**

Description: Retrieves protected user data buffer.

Parameter: None

Response: #(non-zero digit) (digits) (user data)

The non-zero digit specifies the number of characters that will follow in the <digits> field. These characters are 0 through 9 (ASCII 48 through 57 decimal). The value of the number in the <digits> field defines the number of user data bytes that follow in the <user data> field. The maximum response is 64 characters.

Example: \*PUD?

Returns: "205FLUKE" assuming that this is stored as in the example for PUD\* above.

**PULSE\_WIDTH**

Description: Programs the modulation oscillator pulse width for the variable width pulse waveform in seconds. Default units are S.

Parameter: Pulse width with optional seconds units.

Example: PULSE\_WIDTH 40.0 US

Restrictions: Rejected during sweep.

**PULSE\_WIDTH?**

Description: Retrieves the modulation oscillator pulse width.

Parameter: None

Responses: 1. (Float) Pulse width.  
2. (String) S

Example: 4.000000000E-05,S

**\*RCL**

Description: Recalls a memory location. This command allows the user to recover the programmed instrument state from the specified memory location (contents of which are loaded by the \*SAV command).

Parameter: Memory location.

Restrictions: Rejected during sweep.

Table 5B-3. Remote Commands (cont)

<b>REF?</b>	Description:	Retrieves the state of the frequency reference selection.
	Parameter:	None
	Response:	(String) INT or EXT
<b>RFOUT</b>	Description:	Turns the RF output port On or Off.
	Parameter:	ON or OFF or 1 or 0
<b>RFOUT?</b>	Description:	Retrieves the state of the RF output port.
	Parameter:	None
	Response:	(String) ON or OFF
<b>*RST</b>	Description:	Resets instrument to default memory location. The default memory location is 97 (See Appendix A, "Instrument Preset State").  In addition to the recall of location 97, sweep is turned off, and any current calibration or compensation procedures are aborted. No other actions are performed on the *RST command.
	Parameter:	None
<b>*SAV</b>	Description:	Saves (stores) to a memory location. This command allows a user to store the current instrument programmed state in a specified memory location for later retrieval by the *RCL command.
	Parameter:	Memory location.
	Restrictions:	Rejected during sweep.
<b>SD</b>	Description:	Steps the active step field down by one step size.
	Parameter:	None
	Restrictions:	Rejected during single sweep.
<b>SECURITY</b>	Description:	Turns secure mode on or off. Note that turning secure mode off turns off an active sweep and erases nonvolatile memory.
	Parameter:	ON or OFF or 1 or 0
<b>SECURITY?</b>	Description:	Retrieves the state of the secure mode selection.
	Parameter:	None
	Response:	(String) ON or OFF

**Table 5B-3. Remote Commands (cont)**

<b>SEQ</b>	<b>Description:</b>	Recalls the next or previous memory location.
	<b>Parameter:</b>	UP or DOWN
	<b>Restrictions:</b>	Rejected during sweep.
<b>SPCL</b>	<b>Description:</b>	Selects a special function by number.
	<b>Parameter:</b>	Special function number.
<b>*SRE</b>	<b>Description:</b>	Programs the Service Request Enable register (SRE), described under "Checking the Instrument Status".
	<b>Parameter:</b>	The decimal equivalent of the binary number to load into the register.
	<b>Example:</b>	*SRE 56  Enables bits 3 (IIR), 4 (MAV), and 5 (ESR) in the Service Request Enable register.
<b>*SRE?</b>	<b>Description:</b>	Retrieves Service Request Enable register, described in under the heading "Checking the Instrument Status".
	<b>Parameter:</b>	None
	<b>Response:</b>	(Integer) The decimal equivalent of the register byte.
	<b>Example:</b>	*SRE?  Returns: "56" if bits 3 (IIR), 4 (MAV), and 5 (ESR) are enabled (1) and the rest of the bits are disabled (0). (See "Checking the Instrument Status" for details.)
<b>STATUS</b>	<b>Description:</b>	Loads specified status into the status queue. Uncal, self-test, memory checksum, and memory origin status can be loaded.
	<b>Parameter:</b>	UNCAL or SELFTEST or CHECKSUM or ORIGIN

Table 5B-3. Remote Commands (cont)

<b>STATUS?</b>	
Description:	Retrieves a status code from the status queue. If no status codes have been loaded with the STATUS command or if all the enqueued status codes have been retrieved, a zero is returned. If the optional keyword EXPLAIN is specified, a character string containing its explanation is returned with the status code.
Parameter:	(optional) EXPLAIN
Examples:	STATUS? Returns: 220 (If the RPP has tripped)
	STATUS? EXPLAIN Returns: 220, "RPP tripped" (If the RPP has tripped)
Responses:	1. (Integer) Currently loaded uncal, self-test, or memory status code, or a zero. 2. (optional) (String) The explanation of the code.
<b>*STB?</b>	
Description:	Retrieves the status byte. The status byte is described in under the heading "Checking the Instrument Status".
Parameter:	None
Response:	(Integer) Decimal equivalent of the status byte.
Example:	*STB? Returns: "72" if bits 3 (EAV) and 6 (MSS) are set (1) and the rest of the bits are reset (0).
<b>STEP_AM</b>	
Description:	Steps the AM depth up or down by one step size.
Parameter:	UP or DOWN
Restrictions:	Rejected during single sweep.
<b>STEP_AMPL</b>	
Description:	Steps the output amplitude up or down by one step size.
Parameter:	UP or DOWN
Restrictions:	Rejected during single sweep.
<b>STEP_FIELD</b>	
Description:	Programs the specified field to be used for the step up/down functions.
Parameter:	AM or AMPL or FM or FREQ or MODF or MODL
Restrictions:	Rejected during manual or single sweep.
<b>STEP_FIELD?</b>	
Description:	Retrieves the current step field.
Parameter:	None
Response:	(String) AM or AMPL or FM or FREQ or MODF or MODL

Table 5B-3. Remote Commands (cont)

<b>STEP_FM</b>	
Description:	Steps the FM/ØM deviation up or down by one step size.
Parameter:	UP or DOWN
Restrictions:	Rejected during single sweep.
<b>STEP_FREQ</b>	
Description:	Steps the output frequency up or down by one step size.
Parameter:	UP or DOWN
Restrictions:	Rejected during single sweep.
<b>STEP_MODF</b>	
Description:	Steps the modulation frequency up or down by one step size.
Parameter:	UP or DOWN
Restrictions:	Rejected during single sweep.
<b>STEP_MODL</b>	
Description:	Steps the modulation level up or down by one step size.
Parameter:	UP or DOWN
Restrictions:	Rejected during single sweep.
<b>SU</b>	
Description:	Steps the active step field up by one step size.
Parameter:	None
Restrictions:	Rejected during single sweep.
<b>SWEEP</b>	
Description:	Selects the sweep mode.
Parameter:	OFF or AUTO or MANUAL or SINGLE
<b>SWEEP?</b>	
Description:	Retrieves the sweep mode.
Parameter:	None
Response:	(String) OFF or AUTO or MANUAL or SINGLE
<b>SWEEP_DWELL</b>	
Description:	Programs the sweep dwell time. Default units are S.
Parameter:	Dwell time with optional seconds units.
Example:	SWEEP_DWELL 500 MS

REMOTE OPERATION  
REMOTE COMMAND TABLES

Table 5B-3. Remote Commands (cont)

<b>SWEEP_DWELL?</b>	Description:	Retrieves the sweep dwell time.
	Parameter:	None
	Responses:	1. (Integer) Dwell time. 2. (String) S
<b>SWEEP_FIELD</b>	Description:	Selects the sweep field.
	Parameter:	FREQ (Frequency) AMPL (Amplitude)
	Restrictions:	Rejected during sweep.
<b>SWEEP_FIELD?</b>	Description:	Retrieves the sweep field.
	Parameter:	None
	Response:	(String) FREQ or AMPL
<b>SWEEP_SYM</b>	Description:	Selects the sweep symmetry.
	Parameter:	ASYM (Asymmetrical) SYMM (Symmetrical)
	Restrictions:	Rejected during single sweep.
<b>SWEEP_SYM?</b>	Description:	Retrieves the sweep symmetry.
	Parameter:	None
	Response:	(String) ASYM or SYMM
<b>TEST_ATT</b>	Description:	Programs alternate attenuator settings.
	Parameter:	A24B or A24C or A24D or A24E
	Restrictions:	Rejected during sweep.
<b>TEST_DISP</b>	Description:	Executes display test.
	Parameter:	None
	Restrictions:	Rejected during sweep.



Table 5B-3. Remote Commands (cont)

<b>*TRG</b>	
Description:	Triggers device. Cause the commands defined with the *DDT common command to be executed. If the *DDT has been specified with a zero-length data block, no action will be taken.
Parameter:	None
<b>*TST?</b>	
Description:	Initiates a series of self-tests, then returns a "0" for pass or a "1" for fail. If any tests fail, they can be loaded into the status queue with the STATUS SELF-TEST command. The enqueued status codes can be queried with the STATUS? command. Refer to the Service Manual for a description of tests performed.
Parameter:	None
Response:	(Integer) 0 (for Pass) or 1 (for Fail)
Restrictions:	Turns sweep or calibration or compensation procedure off.
<b>*WAI</b>	
Description:	Waits until all pending remote operations are complete. This command prevents further remote commands from being executed until all previous remote commands have been completely executed.
Parameter:	None

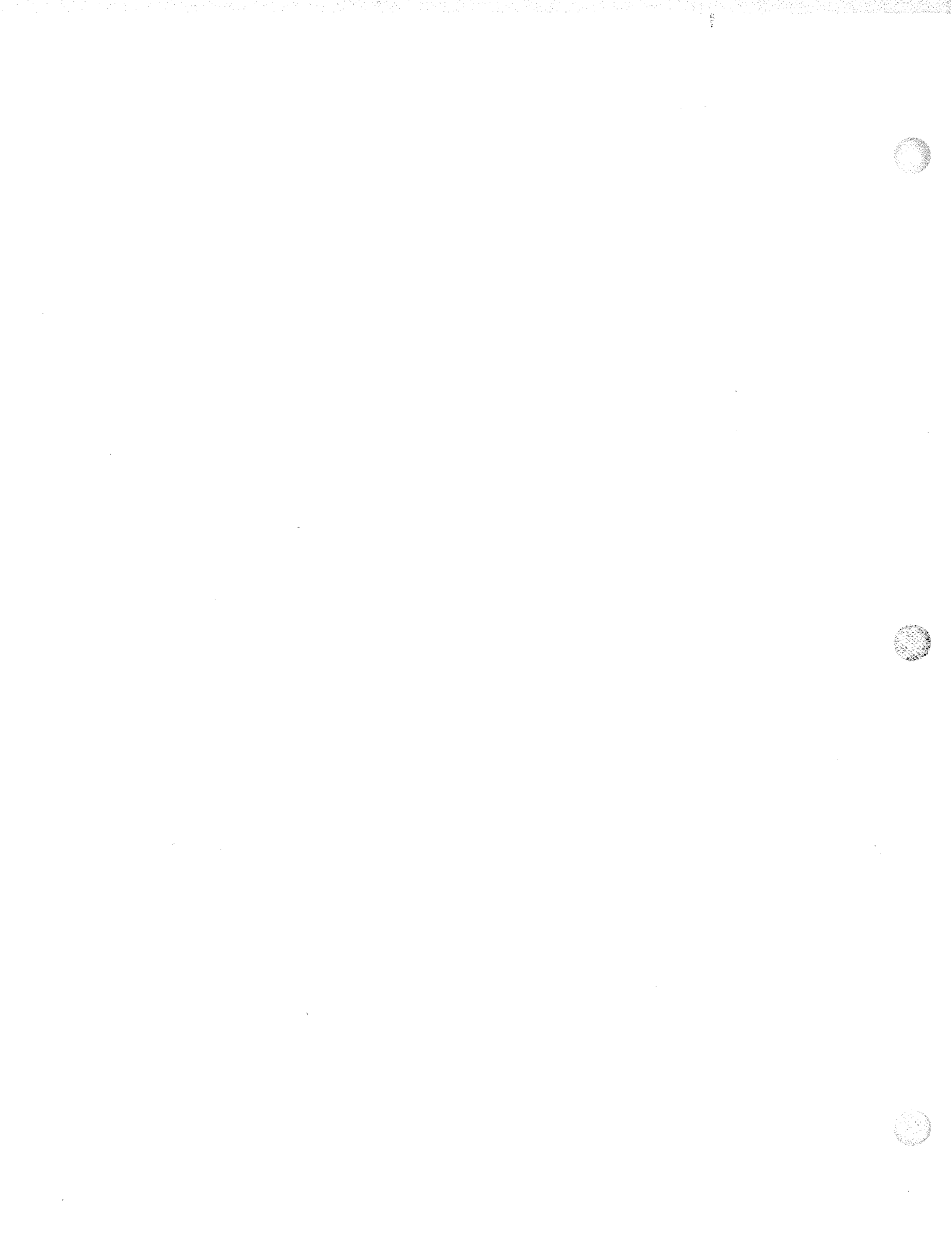

## Section 5C

# Talk-Only/Listen-Only Operation

### INTRODUCTION

5C-1.

The Signal Generator can be used with any IEEE-488 controller in the normal addressed mode. The listen-only and talk-only modes are available for operation without a controller.

In the listen-only mode, the Signal Generator responds to all data messages on the IEEE-488 bus. In the talk-only mode, the Signal Generator sends commands on the IEEE-488 bus to program another Signal Generator.

### TALK-ONLY OPERATION

5C-2.

In talk-only, the Signal Generator outputs the step up (“;SU”) and step down (“;SD”) commands whenever the front panel step up and down entries are made.

Two Signal Generators can be set up to track in frequency with an offset by connecting one Signal Generator in talk-only to another Signal Generator in listen-only. This is done by: programming the two signal generators to the desired frequencies; programming the frequency step value to be the same on both generators; and pressing the step up or step down keys on the generator that is in talk-only mode. Note that if the step sizes are different or if the functions selected to step are different, the signal generators will no longer track with the same offset.

Any of the six functions may be stepped (frequency, amplitude, AM depth, FM deviation, modulation frequency, and modulation level), and the step function of the talker need not match that of the listener.

A Fluke 6060A, 6060B, 6061A, or 6062A may also be used as the listener with the limitation that they cannot step modulation frequency or modulation level. A Fluke 6070A or 6071A may be used as the listener with the limitation that it will always step frequency.

The 6080A and 6082A implement the talk-only (ton) function described in the IEEE-488.1 standard. The IEEE-488.2 standard does not cover talk-only operation.

The talk-only mode is selected by the talker/listener special function described in Section 5, “Remote Operation”. When the mode is changed, the IEEE-488 interface chip is reset, and any current IEEE-488 bus activity is discarded. In talk-only, the signal generator is always in local, and is always addressed as a talker. The ADDR annunciator is always be lit.

**REMOTE OPERATION**  
**TALK-ONLY LISTEN-ONLY OPERATION**

In talk-only, the device clear, trigger, and serial poll messages are ignored.

**LISTEN-ONLY OPERATION**

**5C-3.**

A Fluke 6060A, 6060B, 6061A, or 6062A may be used as a talk-only instrument with a 6080A or 6082A as the listener. They output “,SU” and “,SD” which will cause a command error for the 6080 language. Therefore, if the 6080A or 6082A is to be the listener, it should be configured to one of the compatibility languages as described in Section 5, “Remote Operation”.

The Signal Generator implements the listen-only (lon) function described in the IEEE-488.1 standard. The IEEE-488.2 standard does not cover listen-only operation.

The listen-only mode is selected by the talker/listener special function described in Section 5, “Remote Operation”. When the mode is changed, the IEEE-488 interface chip is reset, and any current IEEE-488 bus activity is discarded. In listen-only, the signal generator is always in local, and is always addressed as a listener. The ADDR annunciator is always lit.

In listen-only, the Signal Generator will respond to all commands that are allowed with the exception of queries and calibration/compensation commands. These commands will be processed with no errors, but nothing will be sent over the bus.

In listen-only, device clear, trigger, and serial poll messages will be ignored.

**LISTEN-ONLY/TALK-ONLY EXAMPLE**

**5C-4.**



The Signal Generator can be connected to another Signal Generator in a master-slave configuration. In the following example, two Signal Generators are configured to track each other in frequency. This configuration may be used to track frequency, amplitude, AM, FM, Modulation Frequency or Modulation Level.

1. Connect two Signal Generators together with an IEEE-488 cable.
2. Set the talker/listener mode of the first Signal Generator (talker) to talk-only by entering    , then entering  in response to the prompt.
3. Set the talker/listener mode of the second Signal Generator (listener) by entering    , then entering  in response to the prompt.
4. Manually program the talker Signal Generator as follows:

FUNCTION	VALUE	KEY SEQUENCE
Frequency	210 MHz	<input type="text" value="FREQ"/> <input type="text" value="2"/> <input type="text" value="1"/> <input type="text" value="0"/> <input type="text" value="MHz V"/>
Step Function	Frequency	<input type="text" value="FREQ"/> <input type="text" value="STEP"/>
Frequency Step	1.25 kHz	<input type="text" value="1"/> <input type="text" value="."/> <input type="text" value="2"/> <input type="text" value="5"/> <input type="text" value="kHz mV"/>

5. Manually program the listener Signal Generator as follows:

FUNCTION	VALUE	KEY SEQUENCE
Frequency	195 MHz	FREQ 1 9 5 MHz
Step Function	Frequency	FREQ STEP
Frequency Step	1.25 kHz	1 . 2 5 kHz

6. On the talker Signal Generator, press the  STEP or  STEP keys. Each time the key is pressed, the frequency of both Signal Generators increases or decreases by 1.25 kHz (the Frequency Step) at frequencies 15 MHz apart.

Different functions on each Signal Generator can be programmed to track in the master-slave configuration. In other words, while the master Signal Generator can be programmed to step increase 25 kHz FM, the slave Signal Generator can be programmed to step 25% AM.

**NOTE**

*To use the step feature for other functions, change the step function on the Signal Generators to the desired functions.*



# Section 5D

## Compatibility Languages

### INTRODUCTION

5D-1.

The previous programming information in Sections 5A through 5C all relates to the default (6080) remote language, which complies with the IEEE-488.2 standard. Use the default language for all new applications.

The Signal Generator can also be configured to respond to commands intended for Fluke Models 6060A, 6060B, 6061A, 6062A, 6070A, or 6071A, or Hewlett Packard Models 8642A or 8642B in an existing program. In this mode, the Signal Generator no longer complies with the IEEE-488.2 standard. The information in this sub-section describes the three compatibility languages built into Models 6080A and 6082A:

- Fluke 6060 family language
- Fluke 6070 family language
- HP8462 family language

The language setting is stored in non-volatile memory and is retained when the power is turned off.

### SELECTING THE ACTIVE LANGUAGE

5D-2.

Enter    to display the current IEEE-488 language in the FREQUENCY display field. The displayed language appears as follows:

- L6080 ?, 6080 (default) language
- L6060 ?, 6060 family language
- L6070 ?, 6070 family language
- L8642 ?, HP8642 family language

Enter  for the 6080 or default language (6080A or 6082A),  for the 6060 (6060A, 6060B, 6061A, or 6062A),  for the 6070 (6070A or 6071A), or  for the 8642 (HP8642A or B) language. Your language selection is displayed for about 2 seconds.

Use the GAL command to select the active language from remote. GAL without arguments will switch to the 6080 language from any language. When in the 6080, language arguments to the GAL command are L6060, L6070, L6080, and L8642. For example, to put the Signal Generator in the 6070 language, send the following programming string: "GAL L6070".

Some commands do not exist in the compatibility languages. To access 6080A/82A functions not supported in a compatibility language, you can intersperse 6080 commands with compatibility commands by inserting appropriate GAL commands.

When you use GAL in an application program, your program must pause approximately 500 ms after sending the GAL command before sending commands in the new language. The 6080A/82A requires this amount of time to reconfigure its character handshake mode to that of the alternate language.

## USING THE 6060 AND 6070 FAMILY LANGUAGES

5D-3.

Once you have set the Signal Generator so that the 6060 or 6070 remote language is active, the Signal Generator is ready to operate in an existing 6060 or 6070 family system, but with some minor restrictions and differences. Read the following text to help you decide whether to make program modifications, and what to modify.

## Incompatibilities

5D-4.

Most of the operations are identical to the 6060 and 6070 signal generators when using the compatibility language. A few minor differences do exist and are described in the following paragraphs.

The instrument limits and specifications are those of the 6080A/82A. For example, the frequency limits are 10 kHz to 1056 MHz for the FR command, even though the 6070A frequency limits are 200 kHz to 520 MHz.

The timing of programming and data transfer on the IEEE-488 bus will not be the same. The 6080A/82A will generally be faster than the 6060 family and slower than the 6070 family of products.

Status, rejected entry, and self-test codes are similar but not exactly the same. Those codes that are the same will be reported as they are in the 6060 or 6070 instruments. Most special functions for the 6060 and 6070 instruments are available in the 6080A/82A and the compatibility language will accept the 6060 or 6070 codes. Tables 5D-1 and 5D-2 list the codes and special functions for the 6060 and 6070 compatibility languages.

Three of the interface modes (record, unbuffered, and valid) have been replaced with the interrogate complete (IP) and wait (WA) commands. Refer to the 6080 language commands \*OPC? and \*WAI for a description of their operation.

The response to the IO command will be the code for the 6080A/82A, not the compatibility instrument. For example, the response "10,0,0" indicates that the instrument is a 6080A with no options.

A single serial poll enable register is maintained for both the 6060 and 6070 compatibility languages. This register is effective whenever the 6080 is operated in either of the two languages. Refer to the 6060 Instruction Manual or the 6070 Operator Manual for information regarding bit assignments for the enable register and the status byte.

The commands available in the 6060 or 6070 compatibility language are listed in Table 5D-3. All compatibility language commands are available in both languages even if that command is not in the instrument being emulated. Also included are commands for features that are new for the 6080A/82A. A few commands that are not commonly used in these instruments have been eliminated from the compatibility languages and are listed in Table 5D-3A.

In the 6060 and 6070 instruments, numeric data can be sent in hexadecimal as well as the default decimal. This feature is not included in the 6060 and 6070 compatibility languages.



Table 5D-1. 6060 Compatibility Language Codes and Special Functions

RETURNED IN 6060 MODE	EQUIVALENT 6080 STATUS	DESCRIPTION
<b>Status (value returned on 6060 IU command)</b>		
000001,000000,000000	222	FM DAC at 0
000002,000000,000000	224	FM out of range for RF frequency band
000004,000000,000000	*	Excess FM Deviation
000010,000000,000000	223	FM DAC at full scale
000020,000000,000000	*	AM depth too high
000200,000000,000000	250	Multiple compensation memory errors
000000,000010,000000	246	Reference unlocked
000000,000000,000001	*	Level DAC below calibrated range
000000,000000,000002	*	Peak (AM) amplitude too high
000000,000000,000004	241	ALC loop unlevelled
000000,000000,000010	220	Level DAC at 0
000000,000000,000020	221	Level DAC at full scale
000000,000000,000040	240	RPP tripped
000000,000000,000100	*	Amplitude too low
000000,000000,000200	201	Level correction disabled
000000,000000,000400	*	RF output off
001000,000000,000000	**	All other codes new for 6082A
<b>Rejected entry (value returned on "IR" command)</b>		
000001,000000,000000	30	FM/ØM deviation out of range
000002,000000,000000	31	FM/ØM step size out of range
000004,000000,000000	20	AM depth out of range
000010,000000,000000	21	AM step size out of range
000020,000000,000000	73	IEEE bad command syntax
000040,000000,000000	74	IEEE bad argument value
000100,000000,000000	98	MEC PROM ID code invalid, or MEC PROM checksum error
000200,000000,000000	71	IEEE invalid edit or step
000400,000000,000000	97	Stored cal/comp data has invalid data point
000000,000001,000000	1	Frequency out of range
000000,000002,000000	90,95	CALCOMP switch not set to 1 (on)
000000,000004,000000	2	Frequency step size out of range
000000,000010,000000	92	Cal/comp procedure incomplete, data cannot be stored
000000,000020,000000	94	Invalid cal/comp command
000000,000040,000000	61	Invalid memory location
000000,000100,000000	62	Memory location data invalid
000000,000200,000000	60	Invalid special function code
000000,000400,000000	93	Cal/comp data range error (too much correction)
000000,000000,000001	10	Amplitude out of range
000000,000000,000002	11	Amplitude unit conversion out of range
000000,000000,000004	12	Units conversion not allowed with voltage reference
000000,000000,000020	13	Amplitude step size out of range
000000,000000,000040	15	Amplitude step units conversion not allowed
000000,000000,000100	14	Amplitude step with mixed units not allowed
000000,000000,000200	91	Cal/comp out of range adjustment
000000,000000,000400	96	Internal cal/comp data transfer error
001000,000000,000000	**	All other rejected entry codes new for 6082A

REMOTE OPERATION  
COMPATIBILITY LANGUAGES

Table 5D-1. 6060 Compatibility Language Codes and Special Functions (cont)

RETURNED IN 6060 MODE	EQUIVALENT 6080 STATUS	DESCRIPTION
<b>Self-test (value returned on 6060 IT command)</b>		
000,000,000,000 777,777,777,777		All tests passed Some tests failed. Go to the 6080 language to query the results.
000,-000,000,000 777,-777,777,777		Tests were aborted. Some tests failed and tests were aborted.
SENT IN 6060 MODE	EQUIVALENT 6080 CODE	DESCRIPTION
<b>Special function (value sent with 6060 SP command)</b>		
00	00	Clears special functions
02	02	Initiates power-on self-tests
03	*	Display test.
04	*	Button test.
07	14	Set front panel SRQ
08	15	Clear front panel SRQ
09	*	Display software revision level
10	*	Display IEEE-488 address and talker/listener mode
11	*	Display self-test results
12,13	770,771	Disable display
14	*	Initialize memory locations
15	*	Latch test.
16	*	Display option loading status
17	*	Initiate self-tests with RF output enabled
20,21	20,21	Relative frequency
30,31	30,31	Relative amplitude.
40,41	740,741	Internal pulse modulation
50-52	840-842	Select amplitude display units
60,61	****	DCAM
70-72	860-862	Select repeat rate for step keys
75	*	Display cal/comp memory checksum status and data origins
76	*	Repair cal/comp memory checksum errors
77-79	*	Transfer MEC Prom Data
80-82	920-922	Apply amplitude compensation
83-86	923-926	Program alternate 24 dB attenuators
90,91	50,51	Amplitude fixed range
95-98	*	Manual compensation procedures
<b>NOTES:</b> *Feature not available for the Signal Generator, rejected for special functions. **Feature new for the Signal Generator, no equivalent code for the 6060. *** Special function rejected, it is only available from the front panel. **** Special function rejected, use "DA1" instead of "SP61, AE1" and "DA0" instead of "SP61, AE0".		

Table 5D-2. 6070 Compatibility Language Codes and Special Functions

RETURNED IN 6070 MODE	EQUIVALENT 6080 STATUS	DESCRIPTION
<b>Status (value returned on 6070 IU command)</b>		
000001,000000,000000,000000	222	FM DAC at 0
000002,000000,000000,000000	224	FM out of range for RF frequency band
000004,000000,000000,000000	247	FM loop unlocked
000010,000000,000000,000000	*	ACFM deviation too high
000020,000000,000000,000000	223	FM DAC at full scale
000040,000000,000000,000000	*	Delay discriminator unlevelled
000100,000000,000000,000000	*	ACFM deviation too high
000200,000000,000000,000000	*	DCFM deviation too high
000000,000001,000000,000000	*	Modulation frequency DAC too low
000000,000002,000000,000000	*	Modulation frequency DAC too high
000000,000004,000000,000000	*	FM deviation too high
000000,000020,000000,000000	*	AM depth too high
000000,000000,000001,000000	*	6071A frequency out of calibrated limits
000000,000000,000002,000000	*	Mod divider filters out of calibrated limits
000000,000000,000004,000000	*	Frequency out of calibrated limits
000000,000000,000010,000000	242	Sub synthesizer unlocked
000000,000000,000020,000000	*	Delay discriminator not ready
000000,000000,000040,000000	*	Excess FM deviation
000000,000000,000100,000000	246	Reference phase detector unlocked
000000,000000,000000,000001	*	Level DAC too low
000000,000000,000000,000002	*	Peak (AM) amplitude too high
000000,000000,000000,000004	241	ALC loop unlevelled
000000,000000,000000,000010	220	Level DAC at 0
000000,000000,000000,000020	221	Level DAC at full scale
000000,000000,000000,000040	240	RPP tripped
000000,000000,000000,000100	*	Amplitude too low
000000,000000,000000,000200	201	Level correction disabled
001000,000000,000000,000000	**	All other status codes new for 6082A
<b>Rejected entry (value returned on 6070 IR command)</b>		
000001,000000,000000,000000	30	FM/ØM deviation out of range
000002,000000,000000,000000	*	DCFM not allowed when phase modulation enabled
000004,000000,000000,000000	*	Radians entry not allowed with DCFM enabled
000010,000000,000000,000000	32	FM/ØM units conversion not allowed when external FM enabled
000020,000000,000000,000000	33	FM/ØM units conversion out of ØM range
000040,000000,000000,000000	61	Invalid memory location
000100,000000,000000,000000	*	Invalid memory location for insert/delete operation
000200,000000,000000,000000	62	Memory location data invalid
000000,000001,000000,000000	20	AM depth out of range
000000,000002,000000,000000	40	Mod frequency out of range
000000,000004,000000,000000	60	Invalid special function code
000000,000010,000000,000000	73	IEEE bad command syntax
000000,000020,000000,000000	74	IEEE bad argument value
000000,000040,000000,000000	71	IEEE invalid edit or step

REMOTE OPERATION  
COMPATIBILITY LANGUAGES

Table 5D-2. 6070 Compatibility Language Codes and Special Functions (cont)

RETURNED IN 6070 MODE	EQUIVALENT 6080 STATUS	DESCRIPTION
000000,000100,000000,000000	*	IEEE invalid bright digit value
000000,000200,000000,000000	*	Bright-digit cannot be enabled during sweep
000000,000000,000001,000000	1	Frequency out of range
000000,000000,000004,000000	2,3,4	Frequency step size/sweep width/sweep increment out of range
000000,000000,000010,000000	52	Entry conflicts with current sweep
000000,000000,000020,000000	51	Cannot enable sweep with current parameters
000000,000000,000000,000001	10	Amplitude out of range
000000,000000,000000,000002	11	Amplitude unit conversion out of range
000000,000000,000000,000004	12	Units conversion not allowed with voltage reference
001000,000000,000000,000000	**	All other rejected entry codes new for 6082A
<b>Self-test (value returned on 6070 IT command)</b>		
000000 777777		All tests passed Some tests failed. Go to the 6080 language to query the results.
-000000 -777777		Tests were aborted. Some tests failed and tests were aborted.
SENT IN 6070 MODE	EQUIVALENT 6080 CODE	DESCRIPTION
<b>Special function (value sent with 6070 SP command)</b>		
00	00	Clears all currently set stored special functions
01	***	Display special function status
02	02	Initiates the power-on self-tests
03	***	Display test.
04	***	Button test.
05	*	Pattern sensitive RAM check
06	*	Non-volatile memory check
07	14	Set SRQ
08	15	Reset SRQ
09	***	Display instrument software revision level.
10,11	****	Forced DCFM
20,21	*	Forced high deviation
30,31	50,51 & 730,732	Fixed range
40	890	Select sweep dwell time of 0 mS
41-44	891-895	Select sweep dwell time
50,51	880,881	Select sweep symmetry
60,61	*	Wideband reference
70,71	40,41	Modulation oscillator output
80,81	920,921	Apply amplitude compensation
<b>NOTES:</b> *Feature not available for the Signal Generator, rejected for special functions. **Feature new for the Signal Generator, no equivalent code for the 6060. *** Special function rejected, it is only available from the front panel. **** Special function rejected, use "DF1" instead of "SP11, FE1" and "DF0" instead of "SP11, AF0".		

Table 5D-3. Compatibility Language Commands

COMPATIBILITY COMMAND	DESCRIPTION	6070 & 6071	6060 & 6061	6062
@	Set up interface modes	.	.	.
AB	Position amplitude bright digit	.	.	.
AE	Disable/enable external AM	.	.	.
AI	Disable/enable internal AM	.	.	.
AM	Program AM depth	.	.	.
AN	Program amplitude sweep incr	.	.	.
AP	Program amplitude	.	.	.
AS	Start (auto) sweep operation	.	.	.
AW	Program amplitude sweep width	.	.	.
CB	Clear IEEE output buffer	.	.	.
CE	Clear error status	.	.	.
CL	Device clear	.	.	.
CT	Configure trigger buffer	.	.	.
DA	Disable/enable external DCAM	.	.	.
DB	Position FM bright digit	.	.	.
DC	Disable/enable DC coupling	.	.	.
DD	Step (down) FM	.	.	.
DF	Disable/enable external DCFM	.	.	.
DI	Blank display	.	.	.
DΩ	Sequence (down) to next mem loc	.	.	.
DS	Program FM step	.	.	.
DU	Step (up) FM	.	.	.
DW	Define RAM/ROM base address	.	.	.
EM	Disable/enable error mode	.	.	.
ER	Display/enter erase repeat count	.	.	.
FB	Position frequency bright digit	.	.	.
FD	Step (down) frequency	.	.	.
FE	Disable/enable external FM	.	.	.
FI	Disable/enable internal FM	.	.	.
FM	Program FM deviation	.	.	.
FR	Program frequency	.	.	.
FS	Program frequency step	.	.	.
FU	Step (up) frequency	.	.	.
GAL	Go to alternate language	.	.	.
IA	Query attenuator log	.	.	.
IB	Input I/O bit	.	.	.
ID	Query instrument ID	.	.	.
IE	Query elapsed time	.	.	.
II	Query interface "@" modes	.	.	.
IM	Query status register enable	.	.	.
IO	Query option loading	.	.	.

REMOTE OPERATION  
COMPATIBILITY LANGUAGES

Table 5D-3. Compatibility Language Commands (cont)

COMPATIBILITY COMMAND	DESCRIPTION	6070 & 6071	6060 & 6061	6062
IP	Query operation complete			
IR	Query rejected entry status	.	.	.
IS	Query instrument serial number	.		
IT	Query self-test status	.	.	.
IU	Query uncal status	.	.	.
IV	Query software version	.	.	.
KA	Edit amplitude	.	.	.
KB	Edit current bright digit field	.	.	.
KD	Edit FM deviation	.	.	.
KF	Edit frequency	.	.	.
KM	Edit modulation frequency	.		
KN	Edit modulation level			
KP	Edit AM depth	.	.	.
LD	Step (down) amplitude	.	.	
LS	Program amplitude step	.	.	
LU	Step (up) amplitude	.	.	
MB	Position mod freq bright digit	.		
MD	Step (down) modulation freq			
ME	Erase nonvolatile memory			
MF	Program modulation frequency	.	.	.
MI	Program modulation freq step			
ML	Program modulation level			
MR	Program mod freq to 400/1000 Hz	.	.	
MS	Start (manual) sweep operation	.		
MU	Step (up) modulation freq			
NB	Position mod level bright digit			
ND	Step (down) modulation level			
NS	Program modulation level step			
NU	Step (up) modulation level			
OD	Output I/O DAC	.	.	.
PB	Position AM bright digit	.	.	.
PD	Step (down) AM depth	.	.	
PE	Disable/enable external pulse	.		
PH	Program carrier phase adjustment			
PI	Disable/enable internal pulse	.		
PK	Program phase clock frequency			
PS	Program AM step	.	.	
PU	Step (up) AM depth	.	.	
PW	Program mod osc pulse width			
PZ	Zero relative phase adjustment			
RA	Disable/enable relative ampli	.	.	.

Table 5D-3. Compatibility Language Commands (cont)

COMPATIBILITY COMMAND	DESCRIPTION	6070 & 6071	6060 & 6061	6062
RB	Query I/O byte	.	.	.
RC	Recall memory location	.	.	.
RF	Disable/enable relative freq	.	.	.
RO	Turn RF output off/on	.	.	.
RW	Query I/O word	.	.	.
SD	Step down	.	.	.
SE	Set secure mode	.	.	.
SF	Select sweep field	.	.	.
SI	Program freq sweep increment	.	.	.
SM	Set service request enable	.	.	.
SO	Stop sweep operation	.	.	.
SP	Program special functions	.	.	.
SQ	Sequence (up) to next mem loc	.	.	.
SS	Start (single) sweep operation	.	.	.
ST	Save (store) memory location	.	.	.
SU	Step up	.	.	.
SW	Program frequency sweep width	.	.	.
TM	Set terminator mode	.	.	.
TR	Trigger device	.	.	.
WA	Wait until operation complete	.	.	.
WB	Set I/O byte	.	.	.
WW	Set I/O word	.	.	.
XA	Query attenuator value	.	.	.
XB	Set attenuator value	.	.	.
XF	Set local alert mode	.	.	.
XR	Fast RF on/off	.	.	.

### Converting 6060 and 6070 Programs to Use the 6080 Language

5D-5.

Users of 6060 and 6070 instruments may wish to convert their programs to use the new features available in the 6080 language. The following paragraphs describe the differences between the compatibility language and the 6080 language to help with the conversion.

In the 6080 language, programming mnemonics are longer and more meaningful than the two-character commands in the compatibility language. Refer to Tables 5D-3 for a list of compatibility language commands and Table 5B-3 for a list of 6080 language commands. In the 6080 language, special functions are accessed mnemonically rather than with special function codes as they are in the compatibility language.

Device clear and the \*RST command are defined by the IEEE-488.2 standard. The 6080 device clear is limited to clearing the input buffer and output queue and turning sweep and cal/comp procedures off. The \*RST does a recall location 97 and clears the trigger buffer. In the compatibility language, the device clear clears the input and output queue and the equivalent of a CL command. The CL command clears the output queue, turns sweep and cal/comp procedures off, clears the trigger buffer,

REMOTE OPERATION  
COMPATIBILITY LANGUAGES

clears errors, turns the RF output on, and initializes the serial poll register enable and memory dividers.

A programming message syntax is defined by the IEEE-488.2 standard. There must be white space between the header and the numeric. This is not the case in the compatibility language. For example, "FM100HZ" is valid in the compatibility language but "FM 100HZ" is required in the 6080 language.

Table 5D-3A. Commands not in 6060 or 6070 Compatibility Language

COMMAND	DESCRIPTION	COMMAND IN INSTRUMENT		
		6070 & 6071	6060 & 6061	6062
BO	Enable/disable bright digit	.		
CF	Compensation, mod meter reading	.		
CM	Compensation commands	.		
CP	Compensation, write level error	.		
DE	Delete memory location	.		
DO	Define port address for output	.		
DT	Define memory top	.		
IC	Compensation interrogate	.		
IH	Compensation, get HET adj.	.		
IL	Interrogate error log	.	.	
IN	Insert memory location	.		
IZ	Compensation, get memory status	.		
LI	Learn interface	.	.	.
LM	Learn memory	.	.	.
OB	Output I/O bit	.	.	
OC	Output count for OM command	.		
OM	Output multiple I/O bits	.		
RM	Set record mode	.	.	
SL	Slow sweep	.		
UM	Set unbuffered interface mode	.	.	
VM	Set valid interface mode	.	.	
XD	Program subsynthesizer freq	.	.	.



In the compatibility language, string terminators are defined to be comma and semicolon and are optional between programming commands. For example, "FM100HZSURO1" is equivalent to "FM100HZ,SU;RO1". In the 6080 language, comma is defined to be a data separator and is required between data elements. The semicolon is defined to be the message unit separator and is required between programming commands. For example, "FM 100 HZ; STEP\_FM UP; RFOUT ON".

Units in the 6080 language are defined by the IEEE-488.2 standard and are not the same as the 6060 and 6070. Table 5D-4 lists the units in both languages.

The 6080 language uses parameters that are mnemonic such as ON and OFF to replace the 1 or 0 used in the compatibility language.

The IEEE-488.2 common command, \*IDN? returns manufacturer, model, serial number, and software version number. This one command replaces the compatibility commands ID, IS, and IV.

A status response in the compatibility language was defined to include the terminator character. For example if the serial poll register enable (SRQ mask) is 134, the command "IM;IM"<terminator> will return "134"<terminator>"134"<terminator>. In the 6080 language, multiple queries within one program message are separated by semicolons, and a terminator is sent at the end. For example, "\*\*SRE?;\*SRE?"<terminator> will return "134;134"<terminator>. In the compatibility language, the terminator is programmable, but in the 6080 language it is always linefeed with EOI asserted.

**Table 5D-4. 6060 and 6070 Compatibility Language Units**

UNIT NAME	COMPATIBILITY LANGUAGE	6080 LANGUAGE
Hertz Kilohertz Megahertz Gigahertz	HZ KZ MZ GZ	HZ KHZ MHZ or MAHZ GHZ
dBm dB dBmV dB $\mu$ V dBf	DB DB - - -	DBM or DBMW DB DBMV DBUV DBF or DBFW
Volt Millivolt Microvolt Nanovolt	V MV UV NV	V MV UV NV
Percent	PC	PCT
Radian	RD	RAD
Second	SC	S

**REMOTE OPERATION  
COMPATIBILITY LANGUAGES**

In the 6080 language, new programming commands cause previous query responses to be flushed from the output queue. In the compatibility language, the output queue is not flushed on new programming commands. For example, “\*SRE?”<terminator> “\*SRE100”<terminator> clears the \*SRE? response, but “IM”<terminator> “SM100”<terminator> does not clear the IM response.

In the 6080 language, if a query but not a terminator is received and the status data is requested to be transferred to the IEEE-488 controller, an error is generated and the output queue is flushed. No error is generated in the compatibility language.

The bit values in the serial poll status byte are different. Refer to the “Checking the Instrument Status” in Section 5A.

After a syntax error, the 6080 language will ignore all characters until a terminator is found. The compatibility language will discard errors until a terminator, comma, or semicolon is found.

The interface modes (@ modes) have been replaced with the IEEE-488.2 common commands \*OPC, \*OPC?, and \*WAI defined in the IEEE-488.2 standard. Refer to the heading “Using the \*OPC?, \*OPC, and \*WAI Commands” in Section 5A for more information.

**USING THE HP 8642 FAMILY LANGUAGE**

**5D-6.**

Once you have set the Signal Generator so that the HP 8642 remote language is active, the Signal Generator is ready to operate in an existing HP 8642 family system, but with some minor restrictions and differences. Use following text to help you decide on whether or not to make program modifications, and what to modify.

**IEEE-488 (GPIB) Address**

**5D-7.**

The HP8642 allows a GPIB address to be set from 0 to 31, with address 31 designated as the “listen-only” state. The 6080A/82A allows any address from 0 to 30 to be set; “listen-only” is set exclusive of the GPIB address.

**IEEE-488 (GPIB) Interface Capabilities**

**5D-8.**

The 6080A/82A differs from the HP8642 in the capabilities listed in Table 5D-5. In the 8642 emulation mode, the 6080A/82A provides the following IEEE Std 488 capabilities consistent with the HP8642: SH1, AH1, TE0, L3, LE0, SR1, RL1, PP0, DC1, DT0, E2.

The HP8642 actions for Device Clear, Selected Device Clear, and Local Lockout are emulated in the 6080. The HP8642 Service Request generation, and clearing/setting of the RQS mask is emulated. A unique copy of the RQS mask is maintained for the 8642 emulation language. The 8642 emulation RQS mask is the same as that for the 8642, with the following exception: bits 0 and 7 of the Status Byte (End of Sweep and Parameter Changed) are always 0; if the corresponding bits of the RQS mask are set in the 8642 emulation language, no SRQ is generated.

**Table 5D-5. IEEE-488 Interface Capabilities/HP8642 Language**

FLUKE 6080A OR 6082A	HP8642
T5 - has talk-only mode C0 - no controller capability	T6 - no talk-only mode C1, C2 - controller C3, C28 capability

## Data Input and Numeric Formatting

5D-9.

The HP8642 and the 6080A/82A in emulation mode handle input data the same way. When processing input, only the characters "a-z", "A-Z", "0-9", "+", ".", "/", and "-" are interpreted. Other characters, including space, line feed, and carriage return are ignored. Numeric data are limited to 10 digits of mantissa and 2 digits of exponent.

The HP8642 ignores data input over the bus while in local (REN unasserted). The Fluke 6080A/82A parses and executes input commands when in local.

## Data Output

5D-10.

When addressed to talk, the HP8642 always has data available to be read. When in local, and unless a query command (OE, OA, etc) has been received, the display contents are presented. This feature is emulated by the 6080.

The HP8642 OC, OE, and OL queries are emulated. Their format consists of 2 fields: a numeric value, followed by an ASCII string. HP8642 syntax errors are reported as they are encountered, and programming errors recognized by the 6080A/82A are mapped to HP8642 message numbers as shown in Table 5D-6.

Since the 6080A/82A does not automatically change parameters based on a user action to change another parameter, the OC (Output Changed Parameter) query always generates a "0" response.

The OL (Output Hi/Low Status) query is fully emulated, as is the OA (Output Active Function) query.

As there are significant hardware differences between the 6080A/82A and the HP8642, the 6080A/82A emulation of the OH (Output Hardware Error) command is as follows: if a 6080A/82A hardware error or out-of-lock condition is detected, a "Fluke-Specific" Error Code is generated. You can then press the front panel  key to determine the specific 6080A/82A hardware problem.

The HP8642 actions for Device Clear, Selected Device Clear, and Local Lockout are emulated in the 6080. The HP8642 Service Request generation, and clearing/setting of the RQS mask is emulated. Bits 0 and 7 of the Status Byte (End of Sweep and Parameter Changed) are always 0; if the corresponding bits of the RQS mask are set, no SRQ is generated.

## HP8642 Commands Not Emulated

5D-11.

In the HP8642 emulation mode, the 6080A/82A interprets the entire HP8642 command set, though some commands are not emulated and cause no change to the 6080A/82A instrument state. When any of the commands in Table 5D-7 are received, error message 4098 - HP.CMD NOT EMULATED is generated.

## RF Output Frequency

5D-12.

The HP8642 RF Frequency Programming capability is emulated except for the commands in Table 5D-8.

REMOTE OPERATION  
COMPATIBILITY LANGUAGES

Table 5D-6. 6080 to HP8642 Error Code Mapping

HP8642 Message	Error Condition Detected in 6080
4001 "NEXT STEP NOT POSSIBLE	.E1" "IEEE invalid edit or step"
4002 "NOT POSSIBLE.ABOVE MAX	.E2" "Freq out of range"
4002 "NOT POSSIBLE.ABOVE MAX	.E2" "Freq step size out of range"
4002 "NOT POSSIBLE.ABOVE MAX	.E2" "Ampl out of range"
4002 "NOT POSSIBLE.ABOVE MAX	.E2" "Ampl units conv out of range"
4002 "NOT POSSIBLE.ABOVE MAX	.E2" "Ampl step size out of range"
4002 "NOT POSSIBLE.ABOVE MAX	.E2" "AM depth out of range"
4002 "NOT POSSIBLE.ABOVE MAX	.E2" "AM step size out of range"
4002 "NOT POSSIBLE.ABOVE MAX	.E2" "FM/PM dev out of range"
4002 "NOT POSSIBLE.ABOVE MAX	.E2" "FM/PM step size out of range"
4002 "NOT POSSIBLE.ABOVE MAX	.E2" "Mod freq out of range"
4002 "NOT POSSIBLE.ABOVE MAX	.E2" "Mod freq step size out of range"
4002 "NOT POSSIBLE.ABOVE MAX	.E2" "Mod level out of range"
4002 "NOT POSSIBLE.ABOVE MAX	.E2" "Mod level step out of range"
4023* "MIXED AMPTD DISALLOWED	.E23" "Ampl units conv not allowed with voltage reference"
4023* "MIXED AMPTD DISALLOWED	.E23" "Ampl step with mixed units not allowed"
4037* "MIXED FM/PM DISALLOWED	.E37" "FM/PM step with mixed units not allowed"
4049 "FREQ.SWP+SWP.TIME LIMIT	.E49" "Sweep cannot be enabled with current sweep parameters"
4052 "AP.SWP PREVENTS FR.SWP	.E52" "Sweep field cannot be changed while sweeping"
4086 "INVALID SPCL FUNCTION	.E86" "Special func code invalid"
4091* "NO SAVE.MEMORY LOCKED	.E91" "Store operation not allowed when Memory Locked"
4092 "SAVE/RECALL MAX = 50	.E92" "Memory loction number invalid"
4093 "RECALL NOT DEFINED	.E93" "Memory location data invalid"
4098* "HP CMD. NOT EMULATED	.E98" -
4099* "FLUKE-SPECIFIC ERROR	.E99" -
*These 4000-series numbers do not exist on the HP8642, but have been added to alert the user that the Signal Generator has detected an error.	

Table 5D-7. HP8642 Commands That Are Not Emulated

COMMAND	DESCRIPTION
AA	Sweep Start Amplitude*
AB	Sweep Stop Amplitude*
BS	Backspace
EM	EMF Mode
EO	Entry Off
HO	Help Off
HP	Help
KH	Knob Hold
KI	Knob Increment
KL	Move Cursor One Decade Left
KR	Move Cursor One Decade Right
MG	Message
RS	Reference Set
SH	Shift

\*Since these are active function codes, their function modifiers are also rejected (IS, UP, DN, ON, OF).

Table 5D-8. HP8642 RF Output Frequency Commands That Are Not Emulated

COMMAND	HP SPECIAL FUNCTION	DESCRIPTION
SP8	8	Prefer HET Band
SP240	240	Decrement Frequency by 0.1 Hz
SP241	241	Increment Frequency by 0.1 Hz
SP250	250	Phase Adjustment from Knob and Step Up and Step Down Keys

**Relative RF Frequency**

**5D-13.**

The following HP8642 Relative RF Frequency commands are emulated:

- RZ (Turn On Relative Frequency Mode)
- RF (Turn Off Relative Frequency Mode)

The following commands are not emulated:

- RS <value> (Set Reference to a Specific Frequency)
- RSON (Set Reference to Last Selected Reference)
- RSOF (Turn Off Reference Frequency)

**RF Frequency Sweep**

**5D-14.**

The 6080A/82A emulates HP8642 Frequency Sweep capability with the exception of commands listed in Table 5D-9.

**Table 5D-9. Frequency Sweep Commands That Are Not Emulated**

COMMAND	DESCRIPTION
FAIS <value> FAUP, FADN	Start Frequency Increment Set Start Frequency Increment Up/Down
FBIS <value> FBUP, FBDN	Stop Frequency Increment Set Stop Frequency Increment Up/Down
STIS <value> STUP, STDN	Sweep Time Increment Set Sweep Time Increment Up/Down
SP121 SP123	Special Function 121 - Sweep Up and Down Special Function 123 - Phase Continuous Sweep

## RF Output Amplitude

5D-15.

The HP8642 Amplitude Programming capability is fully emulated with the exception of the following: the APUP and APDN commands are not allowed unless the Amplitude Increment and the displayed Amplitude are in consistent units (i.e. Volt-unit increment and Volt-unit display, or dB-unit increment and dB-unit display).

The 6080A/82A output ALC loop configuration provides isolation from outside intermodulation. Therefore, the following Special Functions are not emulated, but generate no execution errors:

- SP4 (ALC Off)
- SP204 (ALC On)

## EMF Units

5D-16.

The following HP8642 Amplitude EMF units commands are not emulated:

- EMOF (Turn Off EMF Mode)
- EMON (Turn On EMF Mode)

## Relative Amplitude

5D-17.

The following HP8642 Relative Amplitude commands are emulated:

- RZ (Turn On Relative Amplitude Mode)
- RF (Turn Off Relative Amplitude Mode)

The following commands are not emulated:

- RS <value> (Set Reference to a Specific Amplitude)
- RSON (Set Reference to Last Selected Reference)
- RSOF (Turn Off Reference Amplitude)

## Amplitude Sweep

5D-18.

The 6080A/82A does not emulate the HP8642 Amplitude Sweep capability. Therefore, the commands in Table 5D-10 are not emulated.

## AM/Pulse Modulation

5D-19.

The 6080A/82A fully emulates the HP8642 AM and Pulse modulation functions.

## FM/ $\phi$ M

5D-20.

The 6080A/82A does not support independent instances of  $\phi$ M and FM parameters. As a result, a displayed FM deviation will be converted to its equivalent  $\phi$ M deviation and vice-versa if the complimentary parameter is selected. Apart from this, the 6080A/82A emulates the HP8642 FM and  $\phi$ M modulation functions except the commands in Table 5D-11.

Table 5D-10. Amplitude Sweep Commands That Are Not Emulated

COMMAND	DESCRIPTION
AA <value>	Set Amplitude Sweep Start Point
AAON, AAOF	Turn On/Off Start Amplitude
AAKL, AAKR	Start Amplitude Cursor Left/Right
AAIS <value>	Start Amplitude Increment Set
AAUP, AADN	Start Amplitude Increment Up/Down
AB <value>	Set Amplitude Sweep Stop Point
ABON, ABOF	Turn On/Off Stop Amplitude
ABKL, ABKR	Stop Amplitude Cursor Left/Right
ABIS <value>	Stop Amplitude Increment Set
ABUP, ABDN	Stop Amplitude Increment Up/Down
SP122	Special Function 122 - Linear Amplitude Sweep

Table 5D-11. FM/ØM Commands That Are Not Emulated

COMMAND	SPECIAL FUNCTION	DESCRIPTION
SP6	6	FM Pre-Emphasis On
SP114	114	Negative ØM Polarity
SP115	115	Negative FM Polarity
SP116	116	DC FM Correction Off
SP117	117	DC FM Update Mode On
SP118	118	AC-Coupled DC FM On

### Internal Modulation Oscillator

5D-21.

The 6080A/82A Modulation Oscillator is digitally synthesized, and requires no calibration. Therefore, the following Special Functions are not emulated, but generate no execution errors:

- SP113 (Modulation Frequency Correction Off)
- SP213 (Modulation Frequency Correction On)
- SP248 (Calibrate Modulation Frequency Bands)

#### NOTE

*The 6080A/82A front panel MOD OUTPUT signal is in phase with the internal modulation signal. This is different from the 8642, where the two signals are 180 degrees out of phase.*



### Instrument Preset/Partial Preset

5D-22.

The 6080A/82A emulates the HP8642 Instrument Preset and Partial Preset states with the exception of the following parameters:

- Start/Stop Frequency Increment
- Start/Stop Frequency Knob Increment
- Frequency Reference
- Start Amplitude
- Stop Amplitude
- Start/Stop Amplitude Increment
- Start/Stop Amplitude Knob Increment
- Amplitude Reference
- Amplitude Sweep Mode
- Sweep Time Increment
- Sweep Time Knob Increment

### Knob Control/Entry Off

5D-23.

The 6080A/82A does not emulate the following HP8642 Knob Control commands:

- KI (Set Knob Increment)
- KHON (Knob Hold On)
- KHOF (Knob Hold Off)
- KL (Move Cursor One Decade Left)
- KR (Move Cursor One Decade Right)
- EO (Entry Off)

### Step, Increment Set

5D-24.

The 6080A/82A emulates the 8642 Step and Increment Set functions with the exception of the following function prefixes:

- AA/AB (Start/Stop Amplitude)
- FA/FB (Start/Stop Frequency)
- ST (Sweep Time)

### Save/Recall Register

5D-25.

The 6080A/82A emulates HP8642 recall register commands SV, RC, SVUP, RCUP, SVDN, RCDN, SS, and SQ; but with the following four differences:

1. The contents of recall register 00 are altered by all save, recall, and sequence operations as described in Section 4D. The SVUP, RCUP, and SQ operations skip register 00. The command SS0000 is equivalent to SS0050 (no sequence range).
2. The commands SVUP, RCUP, and SQ all use the same next register number, which is set by the Set Sequence command to the beginning of the sequence range. The SQ command, when used alone, remains inside the sequence range, but a Save or Recall command outside the range causes subsequent sequence commands to operate outside the range.
3. An exclusive sequence range (for example, SS4030, where registers 31 through 39 are skipped), is not fully emulated: SQ remains in one portion of the range, either above or below the hole.

The SP251 (Special Function 251 - Clear Recall Registers) command is implemented differently in the 6080A/82A, in that the Instrument Preset State is stored in each memory location.

**Special Functions**

**5D-26.**

A limited set of HP8642 Special Functions are emulated, as listed in Table 5D-12.

**Messages**

**5D-27.**

The following message/status command is not emulated:

- MG (Load Message Queue)

**Table 5D-12. HP8642 Special Functions Emulated**

COMMAND	DESCRIPTION
SP0	Turn Special Functions 4-9 Off
SP4	ALC Off*
SP5	External Low Rate FM
SP7	Low-Distortion FM
SP100	Turn Off All Specials < 200
SP112	Ext + Int Low Rate FM
SP113	Modulation Frequency Correction Off**
SP119	Disable Setting
SP204	ALC On*
SP205	Turn Off External Low Rate FM
SP207	Turn Off Low-Distortion FM
SP212	Turn Off Ext + Int Low Rate FM
SP213	Modulation Frequency Correction On**
SP219	Re-enable Setting
SP242	Phase Decrement 1 degree
SP243	Phase Increment 1 degree
SP244	Phase Decrement 5 degrees
SP245	Phase Increment 5 degrees
SP248	Calibrate Modulation Frequency Bands**
SP251	Clear All Recall Registers

\* SP4, ALC Off and SP204, ALC On cause no change to the 6080A/82A instrument state, but cause no execution error. The 6080A/82A Output Circuit ALC loop is isolated.

\*\* SP113, Mod Freq Correction Off, SP213 Mod Freq Correction On, and SP248 Calibrate Mod Freq Bands cause no change to the 6080A/82A instrument state, but cause no execution error. The 6080A/82A Modulation Oscillator is digitally synthesized and requires no calibration.

The Special Function Help commands are not emulated:

- HP Help
- HO Help Off

# **Appendix A**

## **Instrument Preset State**

INSTRUMENT PRESET STATE

Appendix A. Instrument Preset State

FUNCTION	SET TO STATES		
	SPCL 00	RCL 97 <sup>1</sup>	SPCL 01 <sup>2</sup> (PRESET)
<b>FREQUENCY</b>			
Output frequency		1000 MHz	1000 MHz
Relative frequency mode (SPCL 20)	Off	Off	Off
<b>AMPLITUDE</b>			
Output amplitude		-140 dBm	-140 dBm
RF output state			On
Relative amplitude mode (SPCL 30)	Off	Off	Off
Fixed range amplitude (SPCL 50)	Normal	Normal	Normal
Amplitude display units (SPCL 840)	dBm	dBm	dBm
EMF-Volts amplitude display mode (SPCL 850)	Off	Off	Off
<b>MODULATION</b>			
AM depth		30 %	30 %
FM/ØM deviation		5 kHz	5 kHz
Modulation frequency		1 kHz	1 kHz
Modulation level		0 V	0 V
Pulse width		500 µs	500 µs
Internal AM		Off	Off
External AC AM		Off	Off
External DC AM		Off	Off
Internal FM/ØM		Off	Off
External AC FM/ØM		Off	Off
External DC FM/ØM		Off	Off
External pulse modulation		Off	Off
Modulation Oscillator output (SPCL 40)	On	On	On
Low-rate FM (SPCL 710)	Off	Off	Off
High-rate ØM (SPCL 720)	Off	Off	Off
Low-distortion/fixed range FM (SPCL 730)	Normal	Normal	Normal
Internal pulse modulation (SPCL 740)	Off	Off	Off
Modulation oscillator waveform (SPCL 750)	Sine	Sine	Sine
<b>SWEEP</b>			
Frequency sweep width		100 MHz	100 MHz
Frequency sweep increment		1 MHz	1 MHz
Amplitude sweep width		10 dB	10 dB
Amplitude sweep increment		.1 dB	.1 dB
Active sweep field		Freq.	Freq.
Sweep dwell time (SPCL 890)	0 s	0 s	0 s
Sweep symmetry (SPCL 880)	Sym.	Sym.	Sym.
Sweep mode			Off
<b>EDIT</b>			
Frequency bright-digit		10 MHz	10 MHz
Amplitude bright-digit		10 dBm	10 dBm
AM bright-digit		10 %	10 %
FM bright-digit		1 kHz	1 kHz

Appendix A. Instrument Preset State (cont)

FUNCTION	SET TO STATES		
	SPCL 00	RCL 98 <sup>1</sup>	SPCL 01 <sup>2</sup> (PRESET)
Modulation frequency bright-digit Modulation level bright-digit Modulation display field Active bright-digit field		1 kHz 100 mV FM Freq.	1 kHz 100 mV FM Freq.
<b>STEP</b>			
Frequency step size Amplitude step size AM depth step size FM/ØM deviation step size Modulation frequency step size Modulation level step size Active step field		10 MHz 10 dB 10% 1 kHz 1 kHz .1 V Freq.	10 MHz 10 dB 10% 1 kHz 1 kHz .1 V Freq.
<b>MISCELLANEOUS</b>			
Display (SPCL 770) Key repeat rate (SPCL 860) Knob and step key operation (SPCL 870) Calibration/compensation procedures Amplitude compensation (SPCL 920)			On Medium On, Step Off All
<b>REMOTE</b>			
Service request enable (SPCL 13) Event status enable Instrument status change enable			0 0 0
<b>NOTES:</b>			
1. Store and recall operations include these parameters.			
2. Power-on State.			
SPCL 00 and RCL 98 are not allowed while the 6080A/AN is sweeping.			
The following instrument parameters are only set from the Fluke factory or with their associated commands:			
<i>External reference frequency (SPCL 760)</i>		<i>Standard</i>	
<i>Memory dividers (SPCL 802)</i>		<i>0,0,0,0</i>	
<i>Memory lock state (SPCL 810)</i>		<i>Off</i>	
<i>Output compensation data (SPCL 930)</i>		<i>Standard</i>	
<i>IEEE-488 address (SPCL 10)</i>		<i>2</i>	
<i>IEEE-488 addressed/listen-only/talk-only (SPCL 11)</i>		<i>Addressed</i>	
<i>IEEE-488 language (SPCL 12)</i>		<i>6080 Language</i>	
<i>Secure mode (SPCL 820)</i>		<i>Off</i>	
<i>RF Output Blanking (SPCL 780)</i>		<i>Off</i>	
<i>Low noise external reference (SPCL 950)</i>		<i>Off</i>	
<i>Nonvolatile memory erase repeat count (SPCL 828)</i>		<i>12</i>	



**Appendix B**  
**Special Function Table**

**SPECIAL FUNCTION TABLE**

**Appendix B. Special Function Table**

SPECIAL FUNCTION	DESCRIPTION
00	Clear special functions
01	Restore Instrument Preset State
02	Initiate power-on self tests
03	Display self test results
04	Display cal/comp memory checksum status
05	Display cal/comp memory data origins
06	Self tests with RF and pulse
08	Display option loading status
09	Display software revision level
10	Display/Set IEEE-488 address
11	Display/Set IEEE-488 address mode
12	Display/Set IEEE-488 language
13	Display/Enter service request mask
14	Set user request SRQ
15	Clear SRQ
20	Disable relative frequency mode
21	Enable relative frequency mode
30	Disable relative amplitude mode
31	Enable relative amplitude mode
40	Enable modulation oscillator output
41	Disable modulation oscillator output
42	Enter modulation frequency with 0.1 Hz resolution
50	Disable fixed range amplitude
51	Enable fixed range amplitude
701	Enable phase adjust mode
702	Zero phase adjust indicator
710	Disable low-rate FM
711	Enable low-rate FM
720	Disable high-rate $\emptyset M$
721	Enable high-rate $\emptyset M$
730	Select normal range FM
731	Select low-distortion range FM
732	Select fixed range FM
740	Disable internal pulse modulation
741	Enable internal pulse modulation
750	Select sine oscillator waveform
751	Select triangle oscillator waveform
752	Select square oscillator waveform



## Appendix B. Special Function Table (cont)

SPECIAL FUNCTION	DESCRIPTION
758	Select pulse waveform
759	Enter pulse width
760	Use 10 MHz external reference input frequency
761	Use alternate external reference input frequency
770	Enable display
771	Disable display
780	Disable RF output blanking
781	Enable RF output blanking
801	Reset memory locations
802	Display/Set memory sequence dividers
808	Continuous memory sequence (860-862 select rate)
810	Unlock memory store operations
811	Lock memory store operations
820	Disable secure mode
821	Enable secure mode
828	Nonvolatile memory erase repeat count
829	Erase nonvolatile memory
840	Select dBm amplitude display units
841	Select dBmV amplitude display units
842	Select dBuV amplitude display units
843	Select dBf amplitude display units
850	Disable EMF-Volts amplitude display mode
851	Enable EMF-Volts amplitude display mode
860	Select medium key repeat rate
861	Select fast key repeat rate
862	Select slow key repeat rate
870	Normal knob and step key operation
871	Knob disabled, normal step key operation
872	Normal knob, step keys operate as EDIT up/down
873	Knob disabled, step keys operate as EDIT up/down
880	Select symmetrical sweep symmetry
881	Select asymmetrical sweep symmetry
882	Initiate single sweep
890	Select sweep dwell time of 0 ms
891	Select sweep dwell time of 20 ms
892	Select sweep dwell time of 50 ms
893	Select sweep dwell time of 100 ms
894	Select sweep dwell time of 200 ms
895	Select sweep dwell time of 500 ms
896	Select sweep dwell time of 1s

SPECIAL FUNCTION TABLE

Appendix B. Special Function Table (cont)

SPECIAL FUNCTION	DESCRIPTION
897	Select sweep dwell time of 2s
898	Select sweep dwell time of 5s
899	Select sweep dwell time of 10s
901	Display test
902	Button test
903	Latch test
904	Initiate self tests with RF output enabled
905	Display operating time since manufacture in hours
907	Repair cal/comp memory checksum errors
909	Diagnostic preset state
910	Rear output option (-830) installed
920	Enable amplitude compensation
921	Disable all amplitude compensation
922	Disable attenuator amplitude compensation
923	Program alternate A24b attenuator
924	Program alternate A24c attenuator
925	Program alternate A24d attenuator
926	Program alternate A24e attenuator
930	Use normal output compensation data
931	Use alternate output compensation data
941	Set all internal DACs to zero
942	Set all internal DACs to half scale
943	Set all internal DACs to full scale
945	Display sum loop frequency
946	Display coarse loop frequency
947	Display subsynthesizer frequency
950	Disable low noise external reference mode
951	Enable low noise external reference mode
961	Transfer output MEC prom data
962	Transfer attenuator MEC prom data
963	Transfer subsynthesizer MEC prom data
971	Automatic coarse loop compensation procedure
972	Automatic sum loop compensation procedure
981	Front panel output compensation procedure
982	Front panel output compensation w/default attenuator procedure
983	Front panel attenuator compensation procedure
984	Front panel subsynthesizer compensation procedure
988	Front panel attenuator comp procedure (power meter)
989	Display Het offset adjustment following output comp procedure
991	Front panel AM calibration procedure
992	Front panel FM calibration procedure
993	Front panel level calibration procedure
994	Front panel reference oscillator calibration procedure

# **Appendix C**

## **Rejected Entry Error Codes**

# REJECTED ENTRY ERROR CODES

## Appendix C. Rejected Entry Error Codes

ERROR CODE	DESCRIPTION
<b>FREQUENCY</b>	
1 2 3 4	Frequency out of range Frequency step size out of range Frequency sweep width out of range Frequency sweep increment out of range
<b>AMPLITUDE</b>	
10 11 12 13 14 15 16 17	Amplitude out of range Amplitude units conversion out of range Amplitude units conversion not allowed with voltage reference Amplitude step size out of range Amplitude step with mixed units not allowed Amplitude step/sweep width/sweep increment units conversion not allowed Amplitude sweep width out of range Amplitude sweep increment out of range
<b>AM</b>	
20 21	AM depth out of range AM step size out of range
<b>FM/øM DEVIATION</b>	
30 31 32 33 34 35	FM/øM deviation out of range FM/øM step size out of range FM/øM units conversion not allowed when external FM enabled FM/øM units conversion out of range FM/øM step with mixed units not allowed FM/øM step units conversion not allowed
<b>MOD FREQUENCY / MOD LEVEL</b>	
40 41 42 43 44	Mod frequency out of range Mod frequency step size out of range Mod level out of range Mod level step size out of range Pulse width out of range
<b>SWEEP</b>	
50 51 52 53 54 55	Sweep field (Freq/Ampl) cannot be changed while sweeping Sweep cannot be enabled with current sweep parameters Entry conflicts with active sweep Selected function not allowed while sweep is active Amplitude sweep with mixed units not allowed Selected function not allowed unless sweep is active

## Appendix C. Rejected Entry Error Codes (cont)

ERROR CODE	DESCRIPTION
<b>SPECIAL FUNCTION AND MEMORY</b>	
60	Special function code invalid
61	Memory location number invalid
62	Memory location data invalid
63	Store operation not allowed when memory locked
64	Display ON not allowed when Secure ON
65	Nonvolatile memory erase failed
<b>REMOTE</b>	
70	IEEE address must be $\leq 30$
71	IEEE invalid edit or step
72	IEEE invalid command
73	IEEE bad command syntax
74	IEEE bad argument value
75	IEEE bad argument type
76	IEEE bad argument count
77	IEEE invalid keyword
78	IEEE 488.2 unterminated command
79	IEEE 488.2 interrupted query
80	IEEE 488.2 I/O deadlock
81	IEEE error/status queue overflow
82	IEEE recursive trigger buffer not allowed
83	IEEE command not allowed in local mode or listen-only mode
84	IEEE query after indefinite response
<b>CALIBRATION/COMPENSATION</b>	
90	CAL COMP switch not set to 1 (on)
91	Cal/comp adjustment out of range
92	Cal/comp procedure incomplete, data cannot be stored
93	Cal/comp data range error (too much correction)
94	Command not allowed during current cal/comp procedure
95	Command only allowed with appropriate cal/comp procedure
96	Internal cal/comp data transfer error
97	Stored cal/comp memory contains invalid data
98	MEC PROM ID code invalid, or MEC PROM checksum error
99	Sum loop compensation procedure failed
100	Coarse loop compensation procedure failed



## Appendix D Overrange/Uncal Status Codes

Appendix D. Overage/Uncal Status Codes

STATUS CODE	DESCRIPTION
<b>UNSPECIFIED OPERATION</b>	
201 202	Level correction disabled High-stability reference oven cold
<b>HARDWARE LIMITED</b>	
220* 221* 222* 223* 224* 225* 226*	Level DAC at 0(Amplitude fixed range) Level DAC at max(Amplitude fixed range) FM DAC at 0 (FM fixed range) FM DAC at max (FM fixed range) FM out of range for RF frequency band Mod frequency too low for pulse mode Pulse width $\geq 1/\text{mod frequency}$
<b>HARDWARE FAULT</b>	
240* 241* 242* 243* 244* 245* 246* 247* 248* 249* 250*	RPP tripped ALC loop unlevelled or AM overmodulation Sub synthesizer unlocked Coarse loop unlocked Sum loop unlocked Sum loop unlevelled Reference unlocked FM loop unlocked or FM overmodulation DCFM DAC at 0 DCFM DAC at max Multiple calibration/compensation memory errors
<b>NOTE:</b>	
<p><i>Flashing codes (denoted by *) indicate abnormal operation or aberrated output. Non-flashing codes indicate operation outside specified range.</i></p>	





## Appendix E

# Self-Test Status Codes

**Appendix E. Self-Test Status Codes**

STATUS CODE	DESCRIPTION
00	No self test errors
301	Self tests aborted
302	Calibration/compensation memory checksum test failed
303	Ram test failed
304	EPROM test failed
305	Non-volatile memory test failed
306	IEEE interface test failed
307-309	AM tests (See Service Manual)
310-317	FM tests (See Service Manual)
318-319	DCFM tests (See Service Manual)
320-323	Coarse loop tests (See Service Manual)
324-326	Subsynthesizer tests (See Service Manual)
327-333	Sum loop tests (See Service Manual)
334-336	RF output tests (See Service Manual)
337-338	Pulse modulator tests (See Service Manual)
339-356	Filter tests (See Service Manual)



## Appendix F

# Rear Panel AUX Connector Pinout

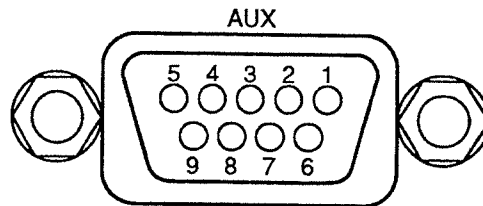

**REAR PANEL VIEW**

PIN	DIRECTION	FUNCTION
1	Input	Sequence down memory location
2	Input	Sequence up memory location
3	--	Ground
4	Output	Pen Lift/Blanking, TTL
5	Output	Sweep DAC, 0-10V
6	--	--
7	--	--
8	--	--
9	Input	Toggle bright digit between frequency and amplitude fields.

**NOTE:** This connector is for foot-pedal or other external switch control. The input lines are active when taken to ground (pin 3). The inputs lines do not repeat if held at ground. The pin 5 output, Sweep DAC, is a 0-10v dc analog signal for driving a plotter. See Section 4E in the Operator manual for more information.

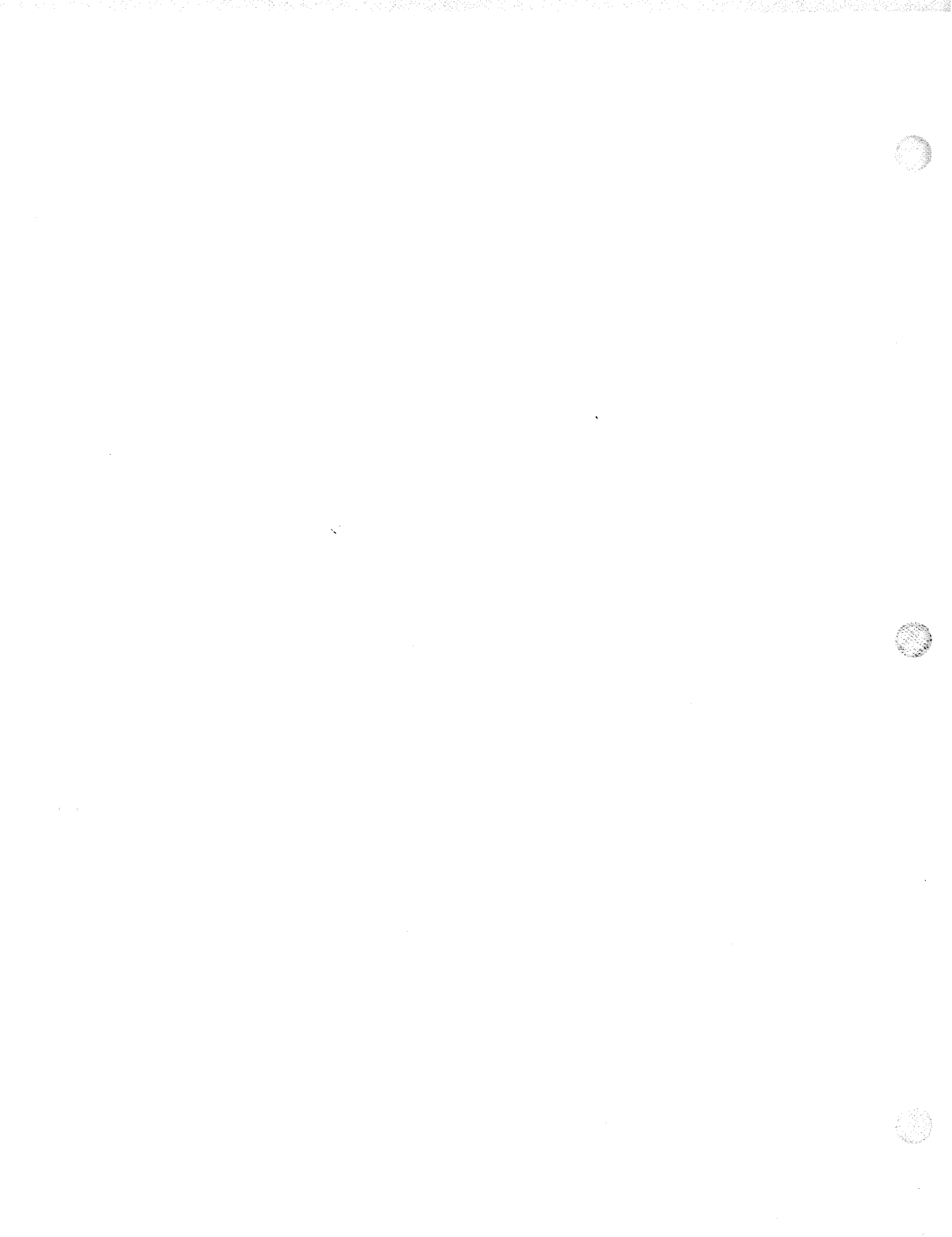

# Index

- 400/1000 key, 3-6
- AC INPUT (line power cord) module, 3-12
- Accessories, 2-3
- Address selection procedure, 5-2
- AM (see amplitude modulation)
- AM\_BRT remote command, 5B-8
- AM\_BRT? remote command, 5B-8
- AMPL key, 3-7
- AMPL remote command, 5B-9
- AMPL? remote command, 5B-9
- AMPL\_ABS? remote command, 5B-9
- AMPL\_BASE? remote command, 5B-9
- AMPL\_BRT remote command, 5B-10
- AMPL\_BRT? remote command, 5B-10
- AMPL\_CMPDAT remote command, 5B-10
- AMPL\_CMPDAT? remote command, 5B-10
- AMPL\_COMP remote command, 5B-10
- AMPL\_COMP? remote command, 5B-10
- AMPL\_EMFOUT remote command, 5B-10
- AMPL\_EMFOUT? remote command, 5B-11
- Amplitude modulation (AM), 4C-5
  - AM remote command, 5B-8
  - AM? remote command, 5B-8
  - Connector, 3-7
  - Depth and depth step size, 4C-5
  - External ac coupled, 4C-6
  - External dc coupled, 4C-7
  - Key, 3-7
  - Internal, 4C-6
- Amplitude sweep, 4E-6
  - Increment, 4E-8
  - Width, 4E-8
- AMPL\_MANUAL remote command, 5B-11
- AMPL\_RANGE remote command, 5B-11
- AMPL\_RANGE? remote command, 5B-11
- AMPL\_REL remote command, 5B-11
- AMPL\_REL? remote command, 5B-11
- AMPL\_SINCR remote command, 5B-11
- AMPL\_SINCR? remote command, 5B-12
- AMPL\_STEP remote command, 5B-12
- AMPL\_STEP? remote command, 5B-12
- AMPL\_SWIDTH remote command, 5B-12
- AMPL\_SWIDTH? remote command, 5B-12
- AMPL\_UNITS remote command, 5B-12
- AM\_STEP remote command, 5B-8
- AM\_STEP? remote command, 5B-8
- Analog frequency sweep, 4E-10
- Annunciators, display, 3-5
- Arrow keys, 3-9
- ATT\_LOG? remote command, 5B-13
- AUTO key, 3-9
- AUX connector, 3-12
  - Pinout, F-1
- Blanking
  - The front panel display, 4F-5
  - Output during frequency changes, 4A-4
- BRT\_FIELD remote command, 5B-13
- BRT\_FIELD? remote command, 5B-13
- Bus communication overview, 5A-16
- CAL\_AM remote command, 5B-13
- CAL|COMP switch, 3-12
- CAL\_FM remote command, 5B-13
- Calibration/compensation data, displaying, 4G-2
- CAL\_LEVEL remote command, 5B-13
- CAL\_REFOSC remote command, 5B-14
- CC\_BRKFREQ? remote command, 5B-14
- CC\_ERRFREQ? remote command, 5B-15
- CC\_EXIT remote command, 5B-14
- CC\_FREQ? remote command, 5B-14
- CC\_HETADJ? remote command, 5B-15
- CC\_RDAM remote command, 5B-15
- CC\_RDDVM remote command, 5B-15
- CC\_RDFM remote command, 5B-15
- CC\_RDFREQ remote command, 5B-15
- CC\_RDPOWER remote command, 5B-15
- CC\_RESUME, 5B-15
- CC\_SAVE remote command, 5B-16
- CC\_TARGET? remote command, 5B-16
- CLR|LCL key, 3-9
- \*CLS remote command, 5B-16

- CMEM\_CLRALT remote command, 5B-16
- CMEM\_FIX remote command, 5B-16
- Command
  - Processing, 5A-5
  - Restrictions, 5A-5
  - Syntax information, 5A-2
- Commands (see remote commands)
- Compatibility languages, 5D-1 (also see HP 8642, Fluke 6060 and 6070)
- COMP\_ATT remote command, 5B-16
- COMP\_ATTPMTR remote command, 5B-16
- COMP\_COARSE remote command, 5B-17
- Compensation modes, using alternate, 4B-8
- COMP\_OUT remote command, 5B-17
- COMP\_OUTDEF remote command, 5B-17
- COMP\_SUBSYN remote command, 5B-17
- COMP\_SUM remote command, 5B-17
- Converting 6060 and 6070 programs to use the 6080 language, 5D-9
- Converting FM/phase modulation units, 4C-9
- DATA Keys, 3-8
- dB(m) key, 3-9
- \*DDT command, using the 5A-23
- \*DDT remote command, 5B-18
- \*DDT? remote command, 5B-18
- Disabling special functions, 4F-4
- Display
  - Calibration/compensation data, 4G-2
  - DISPLAY remote command, 5B-18
  - DISPLAY? remote command, 5B-19
  - Instrument ID, 4F-4
  - Loaded options, 4F-4
  - Self-test status, 4G-2
  - Software revision level, 4F-4
- Display features
  - Amplitude field, 3-4
  - Frequency field, 3-4
  - Modulation field, 3-3
- Display, status annunciators, 3-5
- Down-arrow key, 3-9
- Edit
  - EDIT\_AM remote command, 5B-19
  - EDIT\_AMPL remote command, 5B-19
  - EDIT\_FM remote command, 5B-19
  - EDIT\_FREQ remote command, 5B-19
  - EDIT\_MODF remote command, 5B-19
  - EDIT\_MODL remote command, 5B-19
  - Edit knob, configuring, 4F-5
  - Edit knob special functions, 4F-5
  - Keys, 3-9
  - Knob, 3-9
- EMF units, 4B-3
- Enabling
  - And disabling modulation output, 4C-4
  - Special functions, 4F-3
- Entering parameters, 4-1
  - Bright digit editing, 4-2
  - Directly, 4-2
  - Incrementing and decrementing by step, 4-3
- Erasing instrument state memory, 4A-8
- ERASE\_RPT remote command, 5B-20
- ERASE\_RPT? remote command, 5B-20
- Error
  - Status reporting, 4G-1
  - ERROR? remote command, 5B-20
  - Queue, 5A-13
- ESE (see Event Status Enable register)
- \*ESE remote command, 5B-19
- \*ESE? remote command, 5B-19
- ESR (see Event Status Register)
- \*ESR? remote command, 5B-19
- ETIME? remote command, 5B-21
- Event Status Enable register (ESE), 5A-12
  - Bit assignments, 5A-10
  - \*ESE remote command, 5B-20
  - \*ESE? remote command, 5B-20
  - Programming, 5A-12
- Event Status Register (ESR), 5A-10
  - Bit assignments, 5A-10
  - \*ESR? remote command, 5B-21
- EXPLAIN? remote command, 5B-21
- EXT AC AM key, 3-6
- EXT AC FM| $\phi$ M key, 3-6
- EXT DC AM key, 3-6
- EXT DC FM| $\phi$ M key, 3-6
- EXT pulse key, 3-7
- EXTAC\_AM remote command, 5B-21
- EXTAC\_AM? remote command, 5B-22
- EXTAC\_FM remote command, 5B-22
- EXTAC\_FM? remote command, 5B-22
- EXTDC\_AM remote command, 5B-22
- EXTDC\_AM? remote command, 5B-22
- EXTDC\_FM remote command, 5B-22
- EXTDC\_FM? remote command, 5B-22
- External frequency reference, 2-4, 4A-3
- EXT\_PULSE remote command, 5B-21
- EXT\_PULSE? remote command, 5B-21
- EXTREF\_FREQ, 5B-22
- EXTREF\_FREQ? remote command, 5B-23
- Features, 3-1
- Fixed-range mode, RF output amplitude, 4B-7
- Fluke sales and service centers, G-1
- Fluke 6060 and 6070 compatibility language, 5D-3
  - Commands emulated, 5D-7
  - Incompatibilities, 5D-2
  - Programs, converting to use the 6080 language, 5D-9
  - Remote commands, 5D-7
  - Units, 5D-10

- FM (see frequency and phase modulation)
- FREQ key, 3-7
- FREQ remote command, 5B-24
- FREQ? remote command, 5B-24
- FREQ\_ABS? remote command, 5B-24
- FREQ\_BASE? remote command, 5B-25
- FREQ\_BLANK remote command, 5B-25
- FREQ\_BLANK? remote command, 5B-25
- FREQ\_BRT remote command, 5B-25
- FREQ\_BRT? remote command, 5B-25
- FREQ\_MANUAL remote command, 5B-25
- FREQ\_REL remote command, 5B-26
- FREQ\_REL? remote command, 5B-26
- FREQ\_SINCR remote command, 5B-26
- FREQ\_SINCR? remote command, 5B-26
- FREQ\_STEP remote command, 5B-26
- FREQ\_STEP? remote command, 5B-26
- FREQ\_SWIDTH remote command, 5B-27
- FREQ\_SWIDTH? remote command, 5B-27
- Frequency and phase modulation (FM/ $\phi$ M), 4C-7
  - Band limits, 4C-11
  - Band limits, low-distortion mode, 4C-12
  - Bands, 4C-11
  - External dc coupled, 4C-10
  - External FM/ $\phi$ M ac coupled, 4C-10
  - FM remote command, 5B-23
  - FM? remote command, 5B-23
  - FM\_BRT remote command, 5B-23
  - FM\_BRT? remote command, 5B-23
  - FM/ $\phi$ M connector, 3-7
  - FM/ $\phi$ M deviation and FM/ $\phi$ M step size, 4C-7
  - FM/ $\phi$ M deviation limits (FM/ $\phi$ M enabled), 4C-9
  - FM| $\phi$ M key, 3-7
  - FM/ $\phi$ M units, converting 4C-9
  - FM\_RANGE remote command, 5B-23
  - FM\_RANGE? remote command, 5B-23
  - FM\_STEP remote command, 5B-24
  - FM\_STEP? remote command, 5B-24
  - FM\_UNITS remote command, 5B-24
  - Internal FM/ $\phi$ M, 4C-10
- Frequency
  - Bands, 4A-4
  - Sweep, 4E-4
  - Sweep increment, 4E-5
  - Sweep width, 4E-5
- Function keys, 3-7
- Fuse, 2-4
- GAL remote command, 5B-27
- High rate phase modulation mode, 4C-13
- HIRATEPM remote command, 5B-27
- HIRATEPM? remote command, 5B-27
- HP 8462 compatibility language
  - Amplitude sweep, 5D-17
  - AM/pulse modulation, 5D-17
  - Commands not emulated, 5D-15
  - Error code mapping, 5D-14
  - FM/ $\phi$ M, 5D-17
  - IEEE-488 interface capabilities, 5D-12
  - Special functions emulated, 5D-20
- Hz| $\mu$ V key, 3-8
- \*IDN? remote command, 5B-27
- IEEE-488 interface, 5-1
  - Configuration, 5A-16
- Connector, 3-12, 5A-16
- IEEE-488 remote control (see remote control, IEEE-488)
- Inspection, incoming, 2-1
- Installation, 2-1
- Instrument ID, display of, 4F-4
- Instrument preset state, A-1
- Instrument preset state
  - Defined, A-1
  - Reverting to, 4F-4
- Instrument state memory, 4D-1
  - Dividing into partitions, 4D-4
  - Erasing, 4D-6
  - Non-storable/recallable parameters, 4D-2
  - Nonvolatile memory locations, 4D-2
  - Secure mode, 4D-7
  - Write-protecting, 4D-6
- Instrument Status Register (ISR), 5A-14
  - Bit assignments for the ISR, ISCR, and ISCE, 5A-14
  - Instrument Status Change Enable Register (ISCE), 5A-15
  - Instrument Status Change Register (ISCR), 5A-14
- INT AM key, 3-6
- INT FM| $\phi$ M key, 3-6
- INT\_AM remote command, 5B-28
- INT\_AM? remote command, 5B-28
- Interface messages, 5A-16
- Internal modulation oscillator, 4C-1 (also see modulation)
- Internal/external frequency reference, 2-4
- INT\_FM remote command, 5B-28
- INT\_FM? remote command, 5B-28
- INT\_PULSE remote command, 5B-28
- INT\_PULSE? remote command, 5B-28
- ISR (see Instrument Status Register)
- ISCE remote command, 5B-27
- ISCE? remote command, 5B-27
- ISCR? remote command, 5B-27
- ISR? remote command, 5B-28
- ISCE (see Instrument Status Register)
- ISCR (see Instrument Status Register)
- KEY\_RATE remote command, 5B-29
- KEY\_RATE? remote command, 5B-29
- kHz|mV key, 3-8
- KNOB\_STEP remote command, 5B-30
- KNOB\_STEP? remote command, 5B-30
- Left-arrow key, 3-9

## INDEX

- Line power
  - Connecting to, 2-4
  - Power cords available, 2-2
  - Voltage selection, 2-4
- Listen-only operation, 5C-2
- Listen-only/talk-only example, 5C-2
- Local vs remote operation, 2-5
- LOCALERT remote command, 5B-30
- LOCALERT? remote command, 5B-30
- LORATEFM remote command, 5B-30
- LORATEFM? remote command, 5B-90
- Low distortion and fixed-range FM modes, 4C-12
- Low rate FM mode, 4C-13
- LOWNOISE remote command, 5B-30
- LOWNOISE? remote command, 5B-31
- MANUAL key, 3-9
- Manuals
  - Operator Reference Guide, 1-2
  - Remote Programming Reference Guide, 1-2
  - 6080A and 6082A service, 1-3
- MEM\_DIVIDER remote command, 5B-31
- MEM\_DIVIDER? remote command, 5B-31
- MEM\_ERASE remote command, 5B-31
- MEM\_LOCK remote command, 5B-31
- MEM\_LOCK? remote command, 5B-31
- Memory (see instrument state memory)
- MEM\_RESET remote command, 5B-32
- MHz|V key, 3-8
- MOD\_FREQ key, 3-7
- MOD\_LEV key, 3-7
- MOD\_OUTPUT connector, 3-9
- MOD\_DISPLAY remote command, 5B-32
- MOD\_DISPLAY? remote command, 5B-32
- MODF remote command, 5B-32
- MODF? remote command, 5B-32
- MODF\_BRT remote command, 5B-33
- MODF\_BRT? remote command, 5B-33
- MODF\_STEP remote command, 5B-33
- MODF\_STEP? remote command, 5B-33
- MODL remote command, 5B-33
- MODL? remote command, 5B-33
- MODL\_BRT remote command, 5B-34
- MODL\_BRT? remote command, 5B-34
- MODL\_STEP remote command, 5B-34
- MODL\_STEP? remote command, 5B-34
- MODOUT remote command, 5B-34
- MODOUT? remote command, 5B-34
- Modulation, 4C-1
  - Frequency and step size, 4C-2
  - Level and step size, 4C-3
  - Oscillator, 4C-1
  - Selecting the waveform, 4C-4
- MOD\_WAVE remote command, 5B-32
- MOD\_WAVE? remote command, 5B-32
- Mounting, rack, 2-1
- Nonvolatile memory (see instrument state memory)
- Numeric
  - Formatting for data input, HP 8642 language, 5D-13
  - Keypad, 3-8
- \*OPC remote command
  - Defined, 5B-35
  - How to use, 5A-22
- \*OPC? remote command
  - Defined, 5B-35
  - How to use, 5A-22
- Operation
  - Front panel, 4-1
  - Remote, 5-1
- \*OPT? remote command, 5B-35
- Options, 1-3
- Organization of instrument state memory, 4D-1
- Output queue, IEEE-488, 5A-13
- Overrange/uncal status codes, D-1
- Parameters
  - Entering and modifying (front panel), 4-1
  - Remote command syntax rules, 5A-2
- %|rad key, 3-9
- PHASE remote command, 5B-35
- PHASE? remote command, 5B-36
- PHASE\_CLK remote command, 5B-36
- PHASE\_CLK? remote command, 5B-36
- PHASE\_ZERO remote command, 5B-36
- Power
  - Requirements, 2-1
  - Switch, 3-10
  - Power-on sequence, 2-5
  - Recalling previous instrument settings at power-up, 4-1
- PRESET remote command, 5B-36
- Preset state, A-1
- Programming (also see remote control, IEEE-488)
  - The ESR and ESE, 5A-12
  - The ISR, ISCR, and ISCE, 5A-15
  - The STB and SRE, 5A-10
- \*PUD remote command, 5B-36
- \*PUD? remote command, 5B-37
- Pulse modulation
  - External, 4C-14
  - Internal, 4C-14
  - Input connector, 3-7
  - Width, rate, and period, 4C-15
- PULSE\_WIDTH remote command, 5B-37
- PULSE\_WIDTH? remote command, 5B-37
- Queue, error, 5A-16
- Queue, status, 5A-16
- Rack mounting, 2-1
- RCL key, 3-8
- \*RCL remote command, 5B-37



- Recalling
  - A sequence of instrument states, 4D-4
  - Instrument states, 4D-3
  - Previous instrument settings at power-up, 4-1
  - Single parameters, 4D-6
- Recorder, calibrating, 4E-10
- REF IN connector, 3-12
- REF INT/EXT switch, 3-12
- REF? remote command, 5B-38
- Rejected entry codes, C-1
- Relative amplitude unit combinations, 4B-5
- Remote commands, 5A-4
  - Command processing, 5A-5
  - Compatibility languages (see Fluke 6060 and HP 8642)
  - Extra space characters, 5A-3
  - Functional elements, 5A-18
  - Incoming character processing, 5A-4
  - Input buffer operation, 5A-4
  - Multiple, 5A-5
  - Requiring the CAL|COMP switch to be set, 5A-5
  - Response message syntax, 5A-4
  - Restrictions, 5A-5
  - Syntax information, 5A-2
  - Table, summary, 5B-2
  - Table, comprehensive, 5B-8
  - Terminators, 5A-3
- Remote control, IEEE-488, 5-1
  - Address selection, 5-2
  - And local operation, 2-5
  - Interface messages accepted, 5A-19
  - Interface messages sent, 5A-20
  - Language selection, 5D-1
  - Local state, 5A-6
  - Local with lockout state, 5A-6
  - Program examples (see Remote programming examples)
  - Remote/local state transitions, 5A-6
  - Remote state, 5A-6
  - Remote with lockout state, 5A-6
  - Setup procedures, 5-2
  - Talker/listener operation, 5-2
  - Talk-only/listen-only operation, 5C-1
- Remote programming examples, 5A-22
  - \*DDT, using, 5A-23
  - \*OPC, using, 5A-22
  - \*OPC?, using, 5A-22
  - \*TRG, using, 5A-23
  - \*WAI, using, 5A-22
- Repeat count, nonvolatile memory erase operation, 4D-9
- Resetting all memory locations to factory default, 4D-6
- Response message syntax, 5A-4
- RF output
  - Blanking during frequency changes, 4A-4
  - Connector, 3-10
  - ON/OFF key, 3-10
  - RF output amplitude, 4B-1
    - Bands, 4B-6
    - Converting RF output amplitude units, 4B-2
    - Enabling and disabling RF output, 4B-6
    - Selecting alternate dB reference units, 4B-2
    - Setting, 4B-1
    - Setting RF output amplitude step size, 4B-4
    - Using RF amplitude relative mode, 4B-4
    - Using unterminated output (EMF) mode, 4B-3
  - RF output frequency, 4A-1
    - Adjusting the phase of the RF carrier, 4A-3
    - RF output frequency bands, 4A-4
    - Setting RF output frequency, 4A-1
    - Setting RF output frequency step size, 4A-2
    - Using RF output frequency relative mode, 4A-2
  - RFOUT remote command, 5B-38
  - RFOUT? remote command, 5B-38
  - Right-arrow key, 3-9
  - RQS/SRQ, IEEE-488, 5A-9
  - \*RST remote command, 5B-38
  - \*SAV remote command, 5B-38
  - Save/recall register, HP 8462 language, 5D-19
  - SD remote command, 5B-38
  - Secure mode, 4D-7
  - SECURITY remote command, 5B-38
  - SECURITY? remote command, 5B-38
  - Self test, execute and display results, 4F-4
    - Status codes, E-1
    - Status, displaying, 4G-2
  - SEQ key, 3-8
  - SEQ remote command, 5B-39
  - Serial poll status byte (STB)
    - Bit assignments, 5A-7
    - \*STB? remote command, 5B-40
- Service
  - Centers, G-1
  - Information, 1-3
  - Service Request Enable register (SRE), 5A-9
    - Bit assignments, 5A-7
    - Programming, 5A-10
  - Service request line (SRQ), IEEE-488, 5A-9
  - SHIELD switch, 3-12
  - Software revision level, display of, 4F-4
  - Space characters, extra, 5A-3
  - SPCL annunciator, 4F-4
  - SPCL key, 3-7
  - SPCL remote command, 5B-39
- Special functions, 4F-1
  - Codes, 4F-2
  - Table, B-1
  - Decal, 1-2
  - Knob, 4F-5
  - Miscellaneous, 4F-4
  - Viewing enabled, 4F-3

# INDEX

- Specifications
  - For Model 6080A, 1-5
  - For Model 6082A, 1-12
- SRE (see Service Request Enable register)
- \*SRE remote command, 5B-37
- \*SRE? remote command, 5B-37
- SRQ, IEEE-488, 5A-9
- Standard equipment, 2-2
- State transitions, remote/local, 5A-7
- Status (also see status, checking remote)
  - Codes, 4G-2
  - Data structure, overview, 5A-8
  - Key, 3-9
  - Status keys, configuring, 4F-5
  - Queue, 5A-16
- STATUS remote command, 5B-39
- STATUS? remote command, 5B-40
- Status, checking remote, 5A-7
  - Bit assignments for the STB and SRE, 5A-7
  - Event status register, 5A-10
  - Instrument status register, 5A-14
  - Serial poll status byte, 5A-7
- STB (see serial poll status byte)
- \*STB? remote command, 5B-38
- Step
  - Key, 3-7
  - Key special functions, 4F-5
  - Size defaults, 4-3
  - STEP\_AM remote command, 5B-40
  - STEP\_AMPL remote command, 5B-40
  - STEP\_FIELD remote command, 5B-40
  - STEP\_FIELD? remote command, 5B-40
  - STEP\_FM remote command, 5B-41
  - STEP\_FREQ remote command, 5B-41
  - STEP\_MODF remote command, 5B-41
  - STEP\_MODL remote command, 5B-41
- STO key, 3-8
- Storing
  - Instrument states, 4D-3
  - Single parameters, 4D-6
- SU remote command, 5B-41
- Sweep, 4E-1
  - Digital amplitude sweep example, 4E-9
  - Digital frequency sweep example, 4E-6
  - Dwell time, 4E-3
  - Modes, summary, 4E-2
  - Selecting frequency or amplitude, 4E-2
  - Selecting symmetric or asymmetric, 4E-3
  - SWEEP INCR key, 3-8
  - SWEEP ON/OFF keys, 3-9
  - SWEEP remote command, 5B-41
  - SWEEP? remote command, 5B-41
  - SWEEP WIDTH key, 3-7
  - SWEEP\_DWELL remote command, 5B-41
  - SWEEP\_DWELL? remote command, 5B-42
  - SWEEP\_FIELD remote command, 5B-42
  - SWEEP\_FIELD? remote command, 5B-42
  - SWEEP\_SYM remote command, 5B-42
  - SWEEP\_SYM? remote command, 5B-42
- Syntax rules for remote commands, 5A-2
- Talker/listener operation, 5-2
- Talk-only/listen-only operation, 5C-1
- 10 MHz OUT connector, 3-12
- Terminators, 5A-3
- TEST\_ATT remote command, 5B-42
- TEST\_DISP remote command, 5B-42
- \*TRG remote command
  - Defined, 5B-43
  - How to use, 5A-23
- \*TST? remote command, 5B-43
- UNITS keys, 3-8
- Unpacking, 2-1
- Up-arrow key, 3-9
- \*WAI remote command
  - Defined, 5B-41
  - How to use, 5A-22
- Warranty information, 1-3
- Warranty, reverse of Title Page
- Write-protecting memory locations, 4D-6