

# 721A

## Lead Compensator

Instruction Manual

P/N 294066  
October 1968



# WARRANTY

Notwithstanding any provision of any agreement the following warranty is exclusive:

The JOHN FLUKE MFG. CO., INC., warrants each instrument it manufactures to be free from defects in material and workmanship under normal use and service for the period of 1-year from date of purchase. This warranty extends only to the original purchaser. This warranty shall not apply to fuses, disposable batteries (rechargeable type batteries are warranted for 90-days), or any product or parts which have been subject to misuse, neglect, accident, or abnormal conditions of operations.

In the event of failure of a product covered by this warranty, John Fluke Mfg. Co., Inc., will repair and calibrate an instrument returned to an authorized Service Facility within 1 year of the original purchase; provided the warrantor's examination discloses to its satisfaction that the product was defective. The warrantor may, at its option, replace the product in lieu of repair. With regard to any instrument returned within 1 year of the original purchase, said repairs or replacement will be made without charge. If the failure has been caused by misuse, neglect, accident, or abnormal conditions of operations, repairs will be billed at a nominal cost. In such case, an estimate will be submitted before work is started, if requested.

THE FOREGOING WARRANTY IS IN LIEU OF ALL OTHER WARRANTIES, EXPRESS OR IMPLIED, INCLUDING BUT NOT LIMITED TO ANY IMPLIED WARRANTY OF MERCHANTABILITY, FITNESS, OR ADEQUACY FOR ANY PARTICULAR PURPOSE OR USE. JOHN FLUKE MFG. CO., INC., SHALL NOT BE LIABLE FOR ANY SPECIAL, INCIDENTAL, OR CONSEQUENTIAL DAMAGES, WHETHER IN CONTRACT, TORT, OR OTHERWISE.

**If any failure occurs, the following steps should be taken:**

1. Notify the JOHN FLUKE MFG. CO., INC., or nearest Service facility, giving full details of the difficulty, and include the model number, type number, and serial number. On receipt of this information, service data, or shipping instructions will be forwarded to you.
2. On receipt of the shipping instructions, forward the instrument, transportation prepaid. Repairs will be made at the Service Facility and the instrument returned, transportation prepaid.

## **SHIPPING TO MANUFACTURER FOR REPAIR OR ADJUSTMENT**

All shipments of JOHN FLUKE MFG. CO., INC., instruments should be made via United Parcel Service or "Best Way" prepaid. The instrument should be shipped in the original packing carton; or if it is not available, use any suitable container that is rigid and of adequate size. If a substitute container is used, the instrument should be wrapped in paper and surrounded with at least four inches of excelsior or similar shock-absorbing material.

## **CLAIM FOR DAMAGE IN SHIPMENT TO ORIGINAL PURCHASER**

The instrument should be thoroughly inspected immediately upon original delivery to purchaser. All material in the container should be checked against the enclosed packing list. The manufacturer will not be responsible for shortages against the packing sheet unless notified immediately. If the instrument is damaged in any way, a claim should be filed with the carrier immediately. (To obtain a quotation to repair shipment damage, contact the nearest Fluke Technical Center.) Final claim and negotiations with the carrier must be completed by the customer.

The JOHN FLUKE MFG. CO., INC., will be happy to answer all applications or use questions, which will enhance your use of this instrument. Please address your requests or correspondence to: JOHN FLUKE MFG. CO., INC., P.O. BOX C9090, EVERETT, WASHINGTON 98206, ATTN: Sales Dept. For European Customers: Fluke (Holland) B.V., P.O. Box 5053, 5004 EB, Tilburg, The Netherlands.

\*For European customers, Air Freight prepaid.

**John Fluke Mfg. Co., Inc., P.O. Box C9090, Everett, Washington 98206**



MODEL 721A LEAD COMPENSATOR

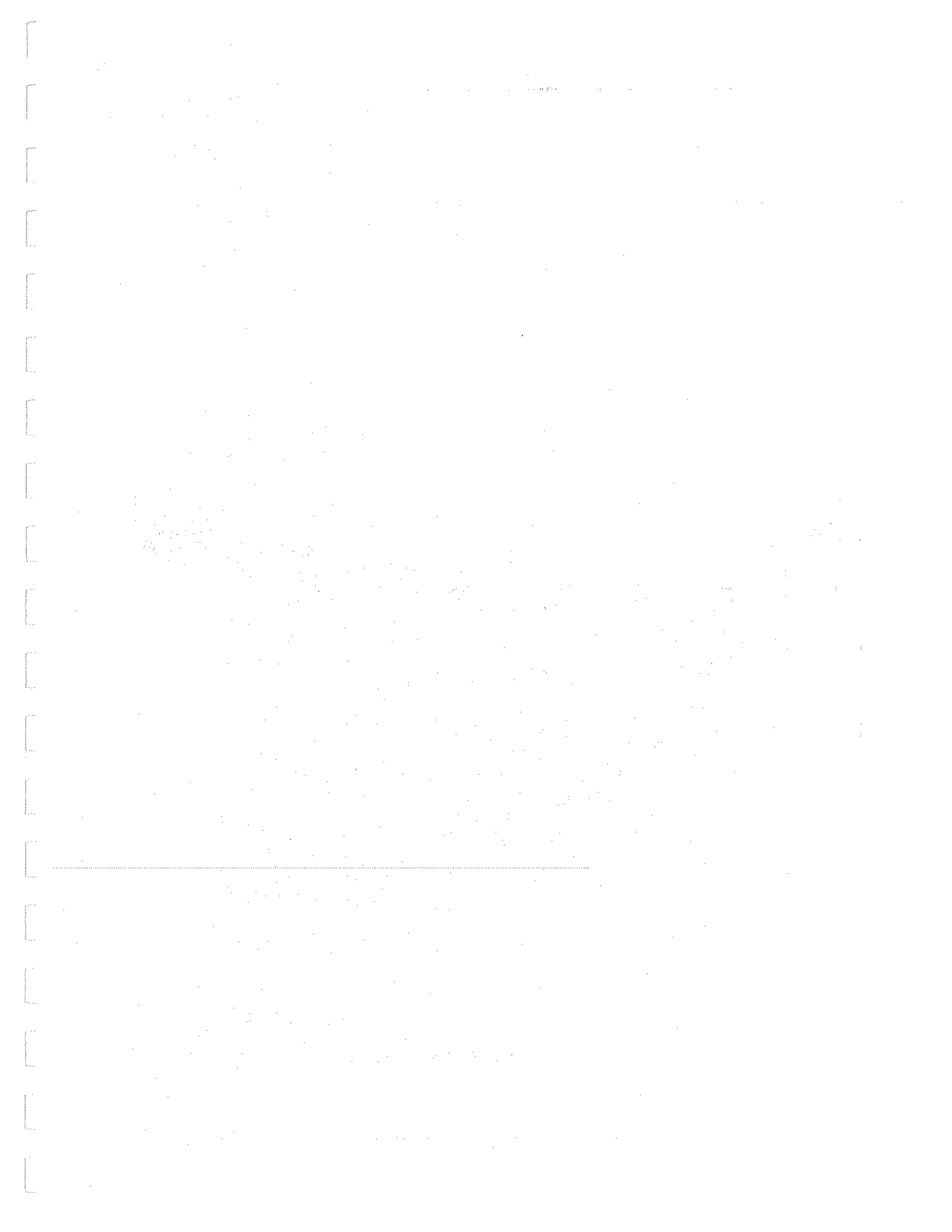

# SECTION I

## INTRODUCTION AND SPECIFICATIONS

### 1-1. INTRODUCTION

1-2. The Model 721A Lead Compensator is a device designed to compensate for the effects of lead and contact resistance in voltage-divider measurement circuits. It is particularly useful in those situations demanding the utmost in accuracy. It is a useful operational accessory for such high-accuracy voltage dividers as the John Fluke Model 720A and Model 725A.

### 1-3. SPECIFICATIONS

#### 1-4. ELECTRICAL

**RESOLUTION OF RESISTANCE COMPENSATION**  
0.1 milliohm.

**MAXIMUM RATIO BETWEEN DIVIDER RESISTANCES**  
4000 to 1.

**MAXIMUM ALLOWABLE LEAD RESISTANCE**  
150 milliohms.

**MAXIMUM DIVIDER VOLTAGE**  
1500 volts, dc or peak ac.

### 1-5. MECHANICAL

**FINE CONTROL**  
10-turn, 150-milliohm, slide-wire potentiometer.

**COARSE CONTROL**  
18-position rotary switch.

**BINDING POSTS**  
Gold plated copper.

**VOLTAGE SWITCH**  
Grounds input voltage terminals to permit compensation for thermal voltages.

**DIMENSIONS**  
3-1/2 high x 19" wide x 6" deep.

### 1-6. OUTLINE DRAWING

1-7. Figure 1-1 is an outline drawing of the Model 721A presenting the information necessary for installation.

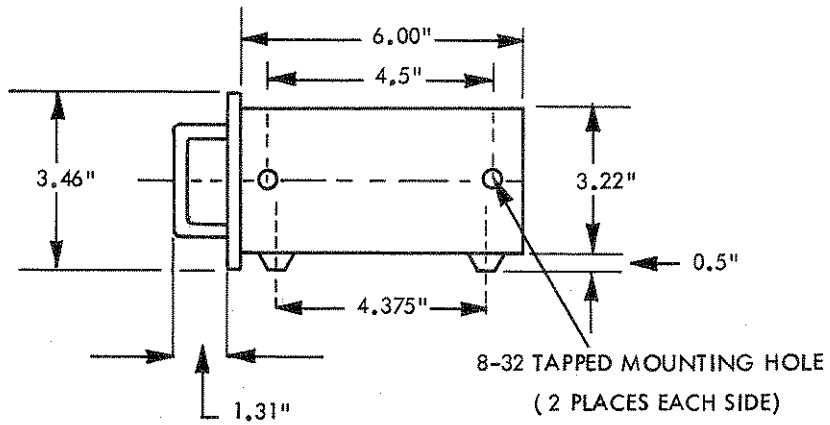
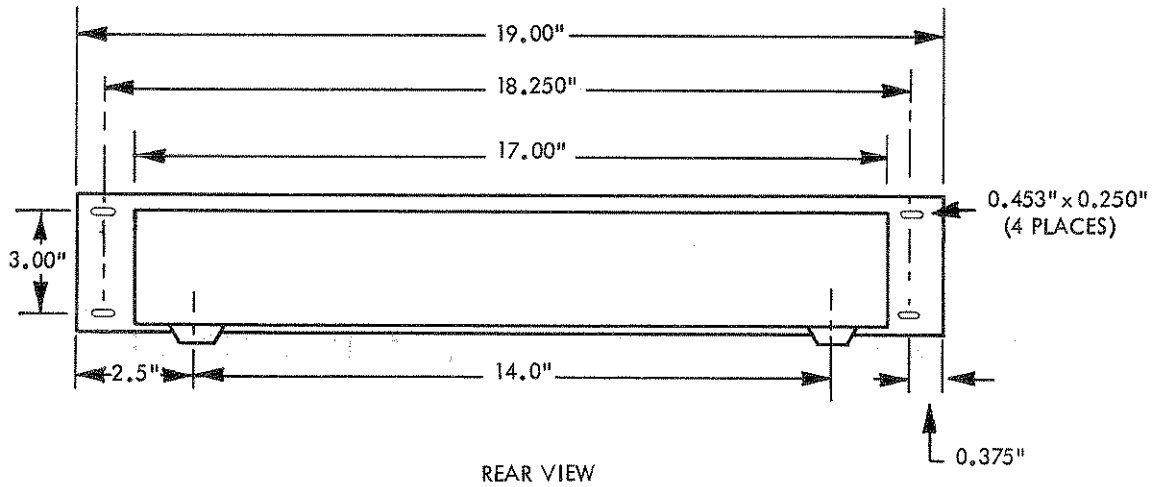

Figure 1-1. MODEL 721A OUTLINE DRAWING.



# static awareness



A Message From  
**John Fluke Mfg. Co., Inc.**

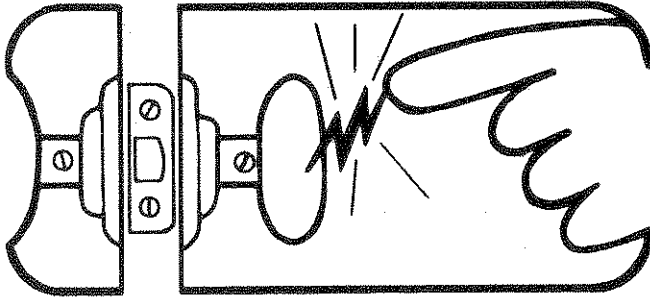

Some semiconductors and custom IC's can be damaged by electrostatic discharge during handling. This notice explains how you can minimize the chances of destroying such devices by:

1. Knowing that there is a problem.
2. Learning the guidelines for handling them.
3. Using the procedures, and packaging and bench techniques that are recommended.

The Static Sensitive (S.S.) devices are identified in the Fluke technical manual parts list with the symbol



The following practices should be followed to minimize damage to S.S. devices.

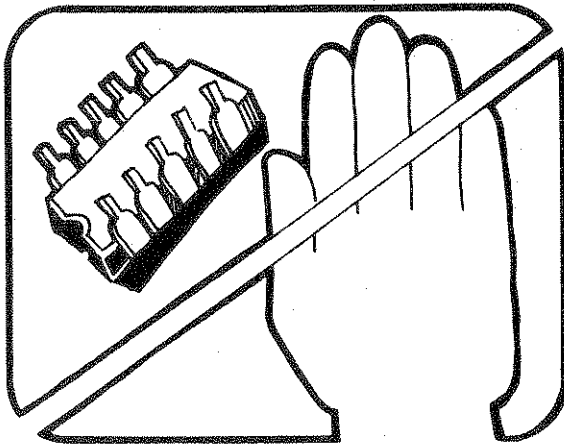

1. MINIMIZE HANDLING

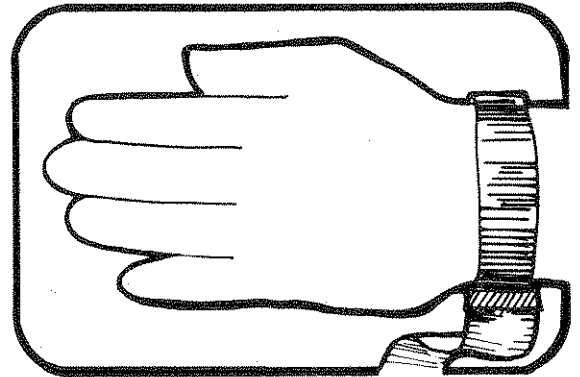

3. DISCHARGE PERSONAL STATIC BEFORE HANDLING DEVICES

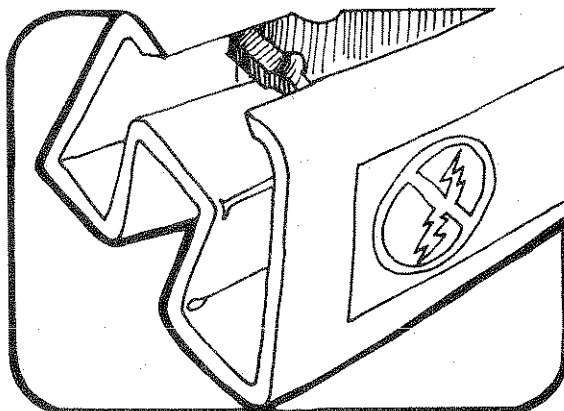

2. KEEP PARTS IN ORIGINAL CONTAINERS UNTIL READY FOR USE.

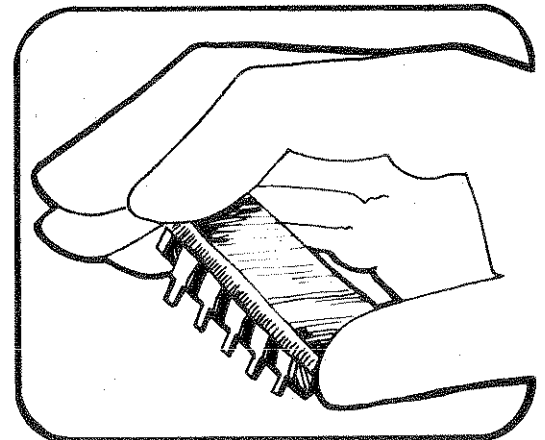

4. HANDLE S.S. DEVICES BY THE BODY

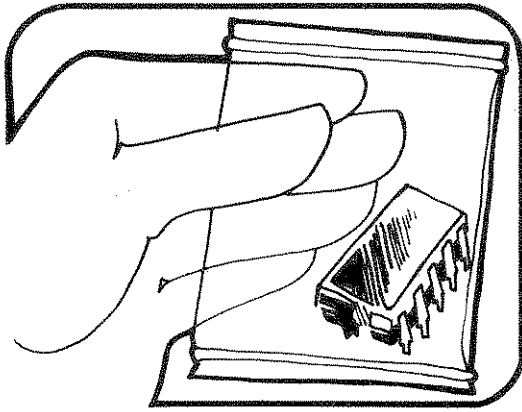

5. USE ANTI-STATIC CONTAINERS FOR HANDLING AND TRANSPORT

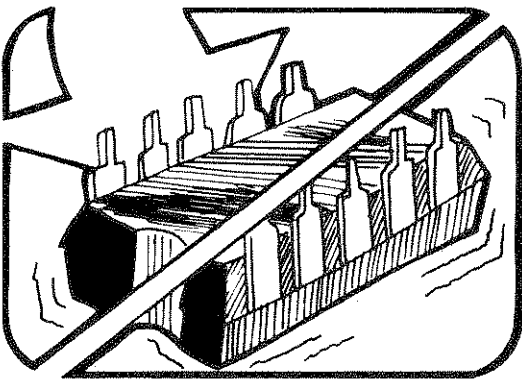

6. DO NOT SLIDE S.S. DEVICES OVER ANY SURFACE

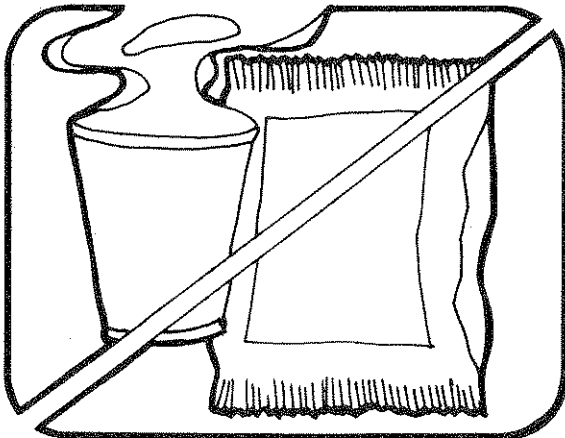

7. AVOID PLASTIC, VINYL AND STYROFOAM® IN WORK AREA

PORTIONS REPRINTED  
WITH PERMISSION FROM TEKTRONIX, INC.  
AND GENERAL DYNAMICS, POMONA DIV.

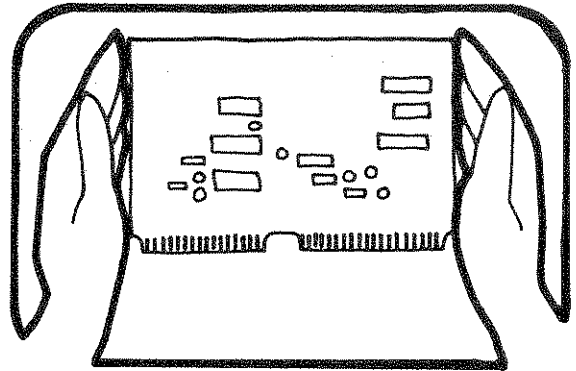

8. WHEN REMOVING PLUG-IN ASSEMBLIES, HANDLE ONLY BY NON-CONDUCTIVE EDGES AND NEVER TOUCH OPEN EDGE CONNECTOR EXCEPT AT STATIC-FREE WORK STATION. PLACING SHORTING STRIPS ON EDGE CONNECTOR USUALLY PROVIDES COMPLETE PROTECTION TO INSTALLED SS DEVICES.

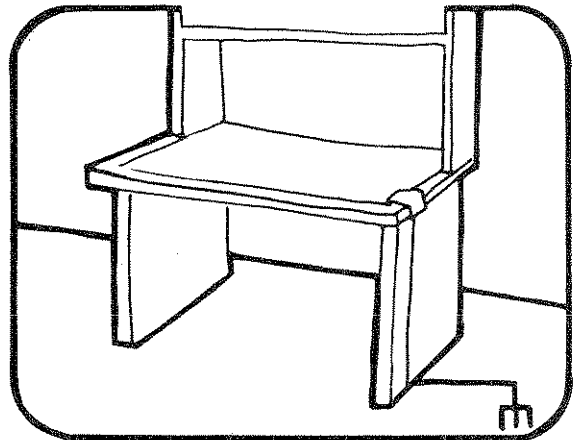

- 9. HANDLE S.S. DEVICES ONLY AT A STATIC-FREE WORK STATION
- 10. ONLY ANTI-STATIC TYPE SOLDER-SUCKERS SHOULD BE USED.
- 11. ONLY GROUNDED TIP SOLDERING IRONS SHOULD BE USED.

Anti-static bags, for storing S.S. devices or pcbs with these devices on them, can be ordered from the John Fluke Mfg. Co., Inc.. See section 5 in any Fluke technical manual for ordering instructions. Use the following part numbers when ordering these special bags.

John Fluke Part No.	Description
453522	6" X 8" Bag
453530	8" X 12" Bag
453548	16" X 24" Bag
454025	12" X 15" Bag
Pink Poly Sheet	Wrist Strap
30"x60"x60 Mil	P/N TL6-60
P/N RC-AS-1200	\$7.00
\$20.00	



## SECTION II

# OPERATING INSTRUCTIONS

### 2-1. INTRODUCTION

2-2. In most resistance measurement setups, the resistance of test leads, switch contacts, etc. is difficult if not impossible to determine with high accuracy. In high-accuracy ratio measurements, these resistances can contribute a significant portion of the total error. A resistance measurement setup is a proportional bridge circuit in which the ratio of one divider is compared to the ratio of another divider. The undesired resistance of test leads and contacts causes an unbalance in the bridge circuit which may be seen easily when making both the low end and the high end comparisons with a null detector. The Model 721A is designed to compensate for this unbalance at both ends permitting linear comparison of the divider ratios. With the Model 721A used correctly to balance the circuit, the accuracy of ratio measurement is limited primarily by the accuracy of the standard voltage divider.

### 2-3. CONTROLS AND TERMINALS

#### 2-4. STANDARD DIVIDER TERMINALS

2-5. The three STANDARD DIVIDER terminals are used for making the connections to the standard resistive divider. The bottom terminal is a ground terminal. It is electrically connected to the similar terminals for the TEST DIVIDER and the VOLTAGE INPUT.

#### 2-6. VOLTAGE SWITCH

2-7. When the VOLTAGE switch is in the ON position, voltage is applied to the test circuit. When it is in the OFF position, the voltage is removed from the test circuit and the wipers of the fine adjust potentiometers are grounded to permit monitoring the circuit for thermal voltages.

#### 2-8. MODE SWITCH

2-9. The MODE switch controls the placement in the circuit of the coarse balance resistance. With the switch in the R STD < R TEST position, the coarse balance resistance is placed in series with the test di-

vider; with the switch in the R STD > R TEST position, the coarse balance resistance is placed in series with the standard divider.

#### 2-10. LOW BALANCE CONTROLS

2-11. The COARSE control, an 18-position switch, controls application of the relatively large amounts of resistance in series with the low (black) terminal for either the standard divider or the test divider, required to compensate for differences in divider input resistance. The FINE control potentiometer provides high-resolution balance (centering) adjustment over a narrow range.

#### 2-12. HIGH BALANCE CONTROLS

2-13. The COARSE control, an 18-position switch, controls application of the relatively large amounts of resistance in series with the high (red) terminal for either the standard divider or the test divider, required to compensate for differences in divider input resistance. The FINE control potentiometer provides high-resolution balance (centering) adjustment over a narrow range.

#### 2-14. TEST DIVIDER TERMINALS

2-15. The three TEST DIVIDER terminals are used for making the connections to the test divider. The bottom terminal is a ground terminal. It is electrically connected to the similar terminals for the STANDARD DIVIDER and the VOLTAGE INPUT.

#### 2-16. VOLTAGE INPUT TERMINALS

2-17. The three VOLTAGE INPUT terminals are used for connecting the voltage source to the test circuit. The upper (red) terminal is normally connected to the positive (+) terminal of the power supply and the middle (black) terminal is normally connected to the negative (-) terminal of the power supply. The bottom terminal is used for grounding the circuit. It is electrically connected to the similar terminals for the STANDARD DIVIDER and the TEST DIVIDER.

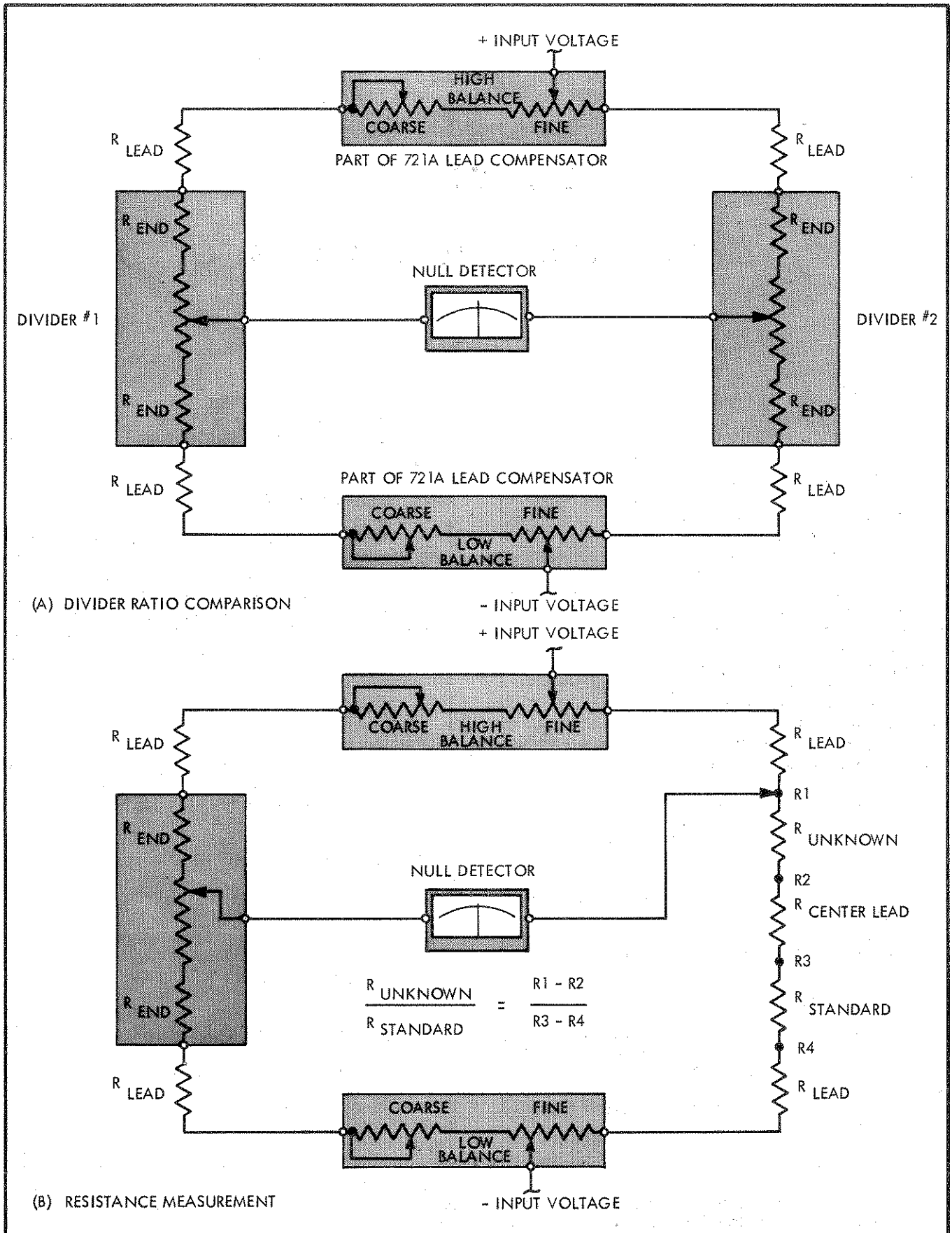

Figure 2-1. RATIO SYSTEM CONFIGURATION

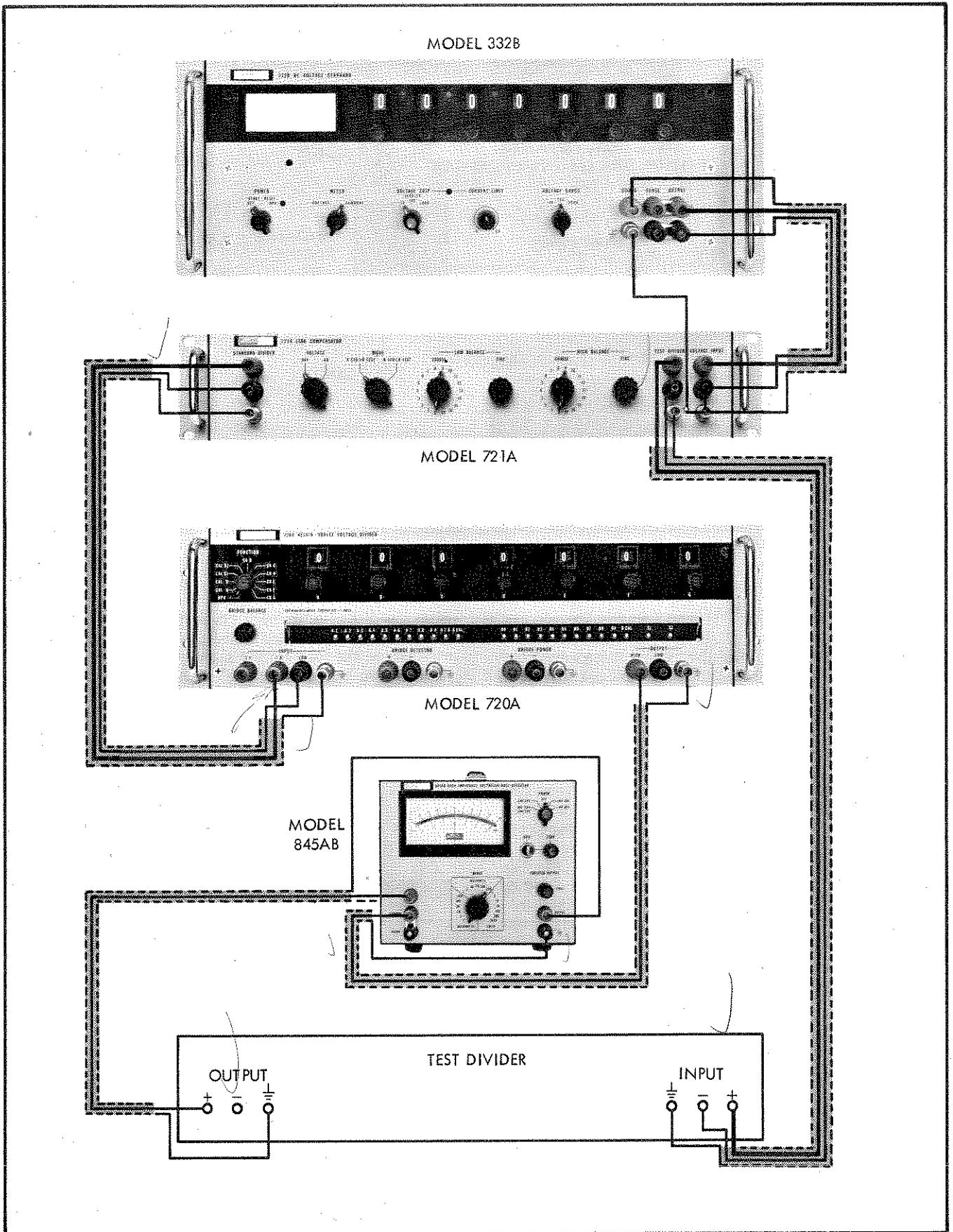

Figure 2-2. INTERCONNECTION OF UNITS FOR RATIO COMPARISON

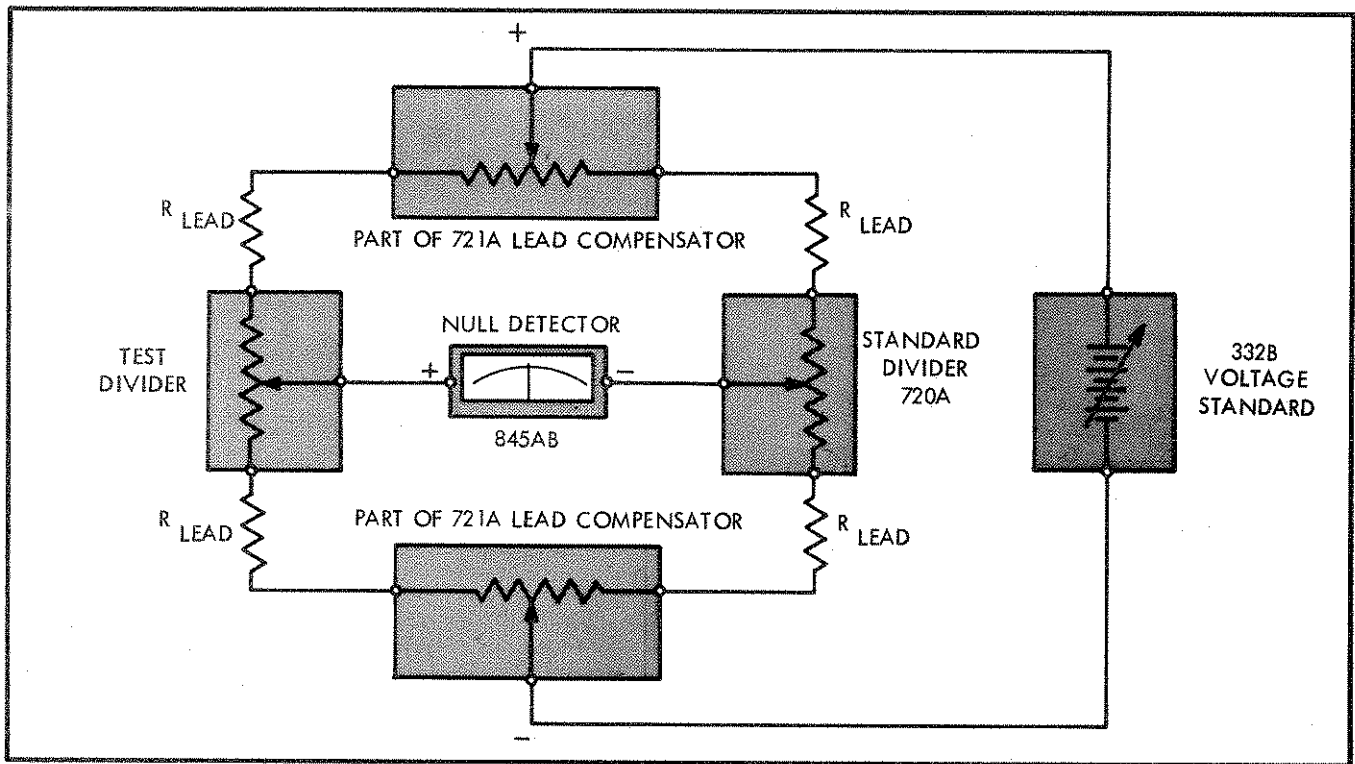

Figure 2-3. SCHEMATIC DIAGRAM OF EQUIPMENT CONNECTIONS

## 2-18. APPLICATIONS

2-19. The Model 721A Lead Compensator was designed to compensate for lead resistance and end resistance in a high-accuracy ratio system. Figure 2-1 shows the two basic configurations of such a system. Lead compensation is essential to accuracy of measurement in both. In Figure 2-1 (A), the ratios of two resistive dividers are compared. This is the typical setup used for divider calibration. The coarse compensation is added in series with the standard divider indicating that it has a higher input resistance than the test divider. If the input resistance of the test divider were higher, the coarse compensation would be switched to the other side. In Figure 2-1 (B), an unknown resistance is measured by using a standard divider to compare it to a standard resistor. Notice that the standard resistance and the unknown resistance form a voltage divider. For this type of measurement, the lead compensator is used to set point  $R_4$  equal to zero setting on the standard divider and to set point  $R_1$  equal to 1.0 setting on the standard divider. The standard divider settings at points  $R_2$  and  $R_3$  at null are then determined and used to compute the unknown resistance from the formula:

$$\frac{R_{\text{unknown}}}{R_{\text{standard}}} = \frac{1 - R_2}{R_3}$$

## 2-20. LEAD RESISTANCE COMPENSATION

2-21. To use the Model 721A for lead compensation, it must be connected into the ratio comparison system as shown in Figure 2-2. Figure 2-3 illustrates a schematic

diagram of the equipment connections. The equipment should be turned on and allowed to warm up for 30 minutes before the lead compensating adjustments are made. After warm-up perform the following steps to compensate for lead resistance.

- Set the power supply to the desired output voltage.
- Set the MODE switch of the Model 721A to R STD < R TEST or R STD > R TEST as appropriate.
- Set both dividers to zero and turn the VOLTAGE switch of the Model 721A to OFF.
- Place the null detector in the zero mode of operation and adjust it for zero meter deflection.
- Return the null detector to the operating mode and set it to the desired sensitivity.
- Note the meter deflection. It is caused by the thermal voltages in the circuit.

*Note!*

To avoid overloading the null detector amplifier during initial balance steps it is advisable to reduce sensitivity before turning the VOLTAGE switch to ON.

- Turn the VOLTAGE switch to ON and adjust the LOW BALANCE controls while increasing sensitivity until the deflection noted in step f is obtained at the desired sensitivity.

- h. Set the HIGH BALANCE COARSE control to the same setting as the LOW BALANCE COARSE control. If the meter deflection changes, readjust the LOW BALANCE FINE control to obtain the meter deflection noted in step f.
- i. Turn the VOLTAGE switch to OFF, reverse power supply polarity, and turn the VOLTAGE switch to ON.
- j. Observe the meter. If meter deflection changes, repeat steps d through j until the null detector reading remains constant for both polarities of applied voltage.
- k. Turn the VOLTAGE switch to OFF and set both dividers to full scale.
- l. Place the null detector in the zero mode of operation and adjust it for zero meter deflection.
- m. Return the null detector to the operating mode and set it to the desired sensitivity.
- n. Note the meter deflection caused by the thermal voltages in the circuit.

*Note!*

The thermal voltages, and meter deflection, may be different at different points in the circuit.

- o. Turn the VOLTAGE switch to ON and adjust the HIGH BALANCE FINE control to obtain the meter deflection noted in step n.
- p. Turn the VOLTAGE switch to OFF, reverse power supply polarity, and turn the VOLTAGE switch to ON.
- q. Observe the meter. If meter deflection changes, readjust the HIGH BALANCE FINE control to find a setting which will cause the same deflection for either supply polarity. The Model 721A now compensates for the lead resistances at the high and low ends of the circuit.

## 2-22. COMPENSATION FOR THERMAL VOLTAGES AT CALIBRATION POINTS

2-23. The technique used for measurement at calibration points must compensate for thermal voltages if optimum accuracy is to be obtained. Adjustment of the Model 721A compensates only for voltage drops at the high and low ends of the circuit caused by end and lead resistance; it can not compensate for thermal voltages at calibration points because they may vary from one calibration point to the next. To make thermal compensated measurements at calibration points, proceed as follows:

- a. Turn the VOLTAGE switch to OFF and set both dividers to the desired calibration point.
- b. Place the null detector in the zero mode of operation and adjust it for zero meter deflection.
- c. Return the null detector to the operating mode.
- d. Turn the VOLTAGE switch to ON and note the meter deflection.
- e. Turn the VOLTAGE switch to OFF, reverse power supply polarity, turn the VOLTAGE switch to ON, and observe meter deflection.

*Note!*

The object of this procedure is to obtain the same meter deflection with normal and reversed power supply polarity.

- f. Adjust the setting of the standard divider to bring the meter needle one half the distance toward the deflection noted in step d and note the deflection.
- g. Turn the VOLTAGE switch to OFF, return power supply polarity to normal, turn the VOLTAGE switch to ON, and note meter deflection. If it is the same as the deflection noted in step f, the measurement is complete.
- h. Continue reversing power supply polarity and adjusting the standard divider setting until the meter deflection is unchanged when polarity is reversed. The setting of the standard divider is now the true ratio of the test divider.

1  
2  
3  
4  
5  
6  
7  
8  
9  
10  
11  
12  
13  
14  
15  
16  
17  
18  
19  
20  
21  
22  
23  
24  
25  
26  
27  
28  
29  
30  
31  
32  
33  
34  
35  
36  
37  
38  
39  
40  
41  
42  
43  
44  
45  
46  
47  
48  
49  
50  
51  
52  
53  
54  
55  
56  
57  
58  
59  
60  
61  
62  
63  
64  
65  
66  
67  
68  
69  
70  
71  
72  
73  
74  
75  
76  
77  
78  
79  
80  
81  
82  
83  
84  
85  
86  
87  
88  
89  
90  
91  
92  
93  
94  
95  
96  
97  
98  
99  
100