

Analog Oscilloscope™

PM3082-PM3084-PM3092-PM3094

Users Manual

941101

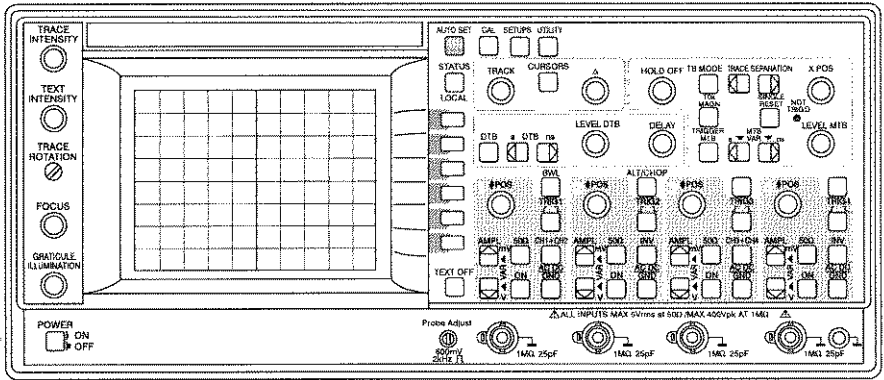

FLUKE.

IMPORTANT

In correspondence concerning this instrument please give the model number and serial number as located on the type plate on the rear of the instrument.

NOTE: The design of this instrument is subject to continuous development and improvement. Consequently, this instrument may incorporate minor changes in detail from the information provided in this manual.

Copyright © 1994 Fluke Corporation

All rights reserved. No part of this manual may be reproduced by any means or in any form without written permission of the copyright owner.

Printed in the Netherlands

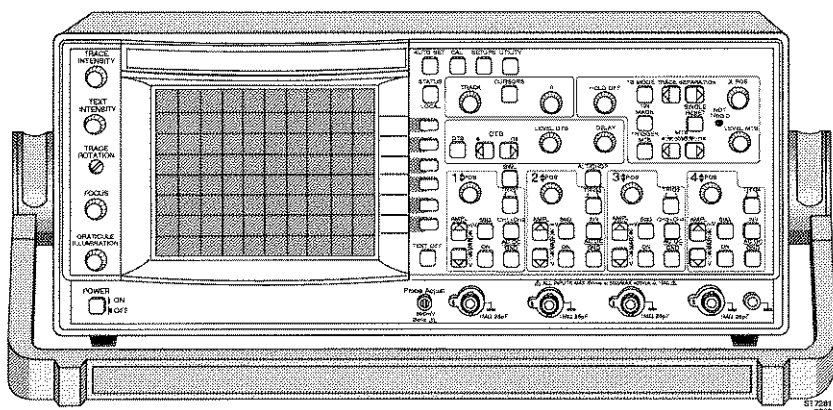

Thank you for purchasing this FLUKE oscilloscope. It has been designed and manufactured to the highest quality standards to give you many years of trouble free and accurate measurements.

The powerful measuring functions listed below have been combined with an easy and logical operation to let you use the full power of this instrument each and every day.

If you have any comments on how this product could be improved, please contact your local FLUKE organization. FLUKE addresses are listed in the back of the REFERENCE MANUAL.

The REFERENCE MANUAL also contains:

- CHARACTERISTICS AND SPECIFICATIONS
- PRINCIPLES OF OPERATION
- BRIEF CHECKING PROCEDURE
- PERFORMANCE TEST PROCEDURES
- PREVENTIVE MAINTENANCE PROCEDURES

MAIN FEATURES

- 200 MHz bandwidth in PM3092/PM3094 for many advanced applications. PM3082 and PM3084 offer 100 MHz bandwidth.
- Four channels with four full attenuators for a wide range of input sensitivities up to 2 mV/div. Channels 3 and 4 in PM3092 and PM3082 offer the most commonly used input sensitivities (0.1 and 0.5 V/div).
- 1% voltage and timing accuracy. The autocal function makes automatic fine adjustments to assure this accuracy even in extreme environmental conditions.
- Autoset function provides automatic setup of an optimized display of the input signals. Works on all channels. Adjusts triggering, time, and amplitude.
- On-screen displays include ground and trigger level indicators.
- Cursors give an extensive set of measurement possibilities including fully automated voltmeter functions.
- Delayed Time Base.
- Wide range of trigger possibilities including HDTV triggering.
- RS-232 interface offers a full remote control possibility (CPL protocol). An IEEE 488.2 interface is offered as an option (SCPI protocol).

	PM3092	PM3094	PM3082	PM3084
Bandwidth	200 MHz	200 MHz	100 MHz	100 MHz
Number of channels	4 CH	true 4 CH	4 CH	true 4 CH
Input impedance	1 M Ω /50 Ω	1 M Ω /50 Ω	1M Ω	1 M Ω

INITIAL INSPECTION

Check the contents of the shipment for completeness and note whether any damage has occurred during transport. When the contents are incomplete or there is damage, file a claim with the carrier immediately. Then notify the FLUKE Sales or Service organization to arrange for the repair or replacement of the instrument or other parts. FLUKE addresses are listed in the back of the REFERENCE MANUAL.

The following parts should be included in the shipment:

	Service ordering number or model number
1 Oscilloscope	PM3094, PM3092, PM3084 or PM3082
1 Front cover	5322 447 70121
1 Users Manual or	
1 Bedienungs-Handbuch or	
1 Mode d'Emploi	
1 Reference Manual	
1 Line cord (European type) or	5322 321 21616
1 Line cord (North American type) or	5322 321 10446
1 Line cord (British type) or	5322 321 21617
1 Line cord (Swiss type) or	5322 321 21618
1 Line cord (Australian type) or	5322 321 30387
1 Line Cord (South Africa)	5322 321 30386
2 Probes 10:1	
2 Batteries	AA (LR6)
1 Spare fuse 1.6 AT (located inside fuse holder)	4822 253 30024

The performance of the instrument can be tested by using the PERFORMANCE TESTS in the REFERENCE MANUAL.

INSIDE THIS MANUAL

This operating guide contains information on all of the oscilloscope's features. It starts with a general introduction, a summary of main capabilities, initial inspection note and a front and rear view.

Operators safety	Chapter 1 should be read before unpacking, installing, and operating the instrument.
Installation instructions	Chapter 2 describes grounding, line cord, fuses, and backup batteries.
Getting started	Chapter 3 provides a 10-minute tutorial intended for those who are not familiar with Fluke oscilloscopes.
How to use the instrument	Chapter 4 provides the more experienced user with a detailed explanation of the major functions of the oscilloscope.
Function reference	Chapter 5 contains an alphabetized description of each function. Each description includes an explanation of local and remote control functions.
Index	The overall index contains all function names and reference words in alphabetical order. It includes the relevant chapter and page number where more detailed information can be found.
Function index	The Function Index lists all implemented functions in alphabetical order.

CONTENTS	Page
1 OPERATORS SAFETY	1-1
1.1 INTRODUCTION	1-1
1.2 SAFETY PRECAUTIONS	1-1
1.3 CAUTION AND WARNING STATEMENTS	1-1
1.4 SYMBOLS	1-1
1.5 IMPAIRED SAFETY PROTECTION	1-2
2 INSTALLATION INSTRUCTIONS	2-1
2.1 SAFETY INSTRUCTIONS	2-1
2.1.1 Grounding	2-1
2.1.2 Mainsvoltage cord, mains voltage range and fuses	2-1
2.2 MEMORY BACK-UP BATTERIES	2-3
2.2.1 General information	2-3
2.2.2 Installation of batteries	2-3
2.3 THE FRONT COVER	2-3
2.4 HANDLE ADJUSTMENT AND OPERATING POSITIONS OF THE INSTRUMENT	2-4
2.5 IEEE 488.2/IEC 625 BUS INTERFACE OPTION	2-4
2.6 RS-232-C SERIAL INTERFACE	2-5
2.7 RACK MOUNTING	2-5
2.8 PM3092, PM3094, PM3082, PM3084 VERSIONS	2-5
3 GETTING STARTED	3-1
3.1 FRONT-PANEL LAYOUT	3-1
3.2 TURNING ON THE INSTRUMENT	3-2
3.3 SCREEN CONTROLS	3-3
3.4 AUTO SETUP	3-4
3.5 VERTICAL SETUP	3-6
3.6 TIMEBASE SETUP	3-8

- 3.7 DIRECT TRIGGER SETUP3-9
- 3.8 MORE ADVANCED FEATURES3-11
- 3.9 CURSOR OPERATION3-12
- 3.10 MORE ADVANCED TRIGGER FUNCTIONS3-14
- 3.11 MORE SIGNAL DETAIL WITH THE DELAYED TIMEBASE3-15

- 4 HOW TO USE THE INSTRUMENT 4-1
 - 4.1 INTRODUCTION4-2
 - 4.2 DISPLAY AND PROBE ADJUSTMENTS4-5
 - 4.3 VERTICAL DEFLECTION4-8
 - 4.4 HORIZONTAL DEFLECTION4-16
 - 4.5 ADVANCED HORIZONTAL AND TRIGGER FUNCTIONS.....4-21
 - 4.6 DELAYED TIMEBASE.....4-30
 - 4.7 CURSOR FUNCTIONS4-37
 - 4.8 AUTOSET AND SET-UP UTILITIES4-48

- 5 FUNCTION REFERENCE 5-1

Appendix A	Cursor menu structure X-DEFL off	A-1
Appendix B	Cursor menu structure X-DEFL on	B-1
Appendix C	Setups menu structure	C-1
Appendix D	UTILITY menustructure	D-1
Appendix E	The CPL protocol	E-1
1	Introduction	E-1
2	Example Program Frame	E-3
3	Commands in functional order	E-4
4	Commands in alphabetical order	E-4
5	Command Reference	E-5
6	ACKNOWLEDGE	E-32
7	STATUS	E-33
8	SETUP	E-35
9	RS-232	E-37
FUNCTION INDEX		I-1
INDEX		I-2

FRONT VIEW

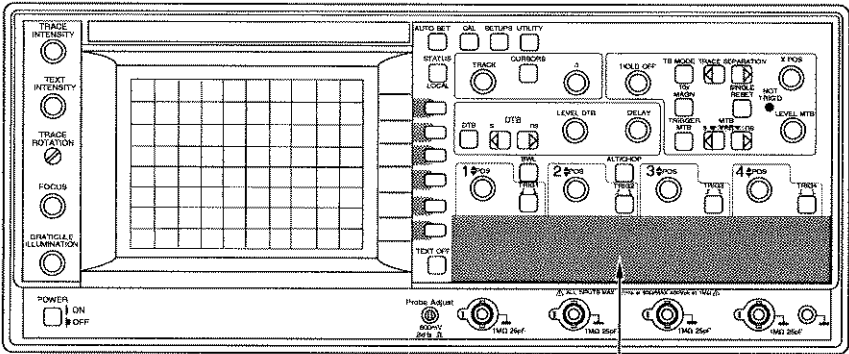

PM3094-200MHz-TRUE 4 CHANNEL

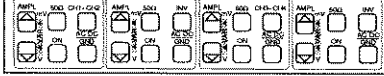

PM3092-200MHz-4 CHANNEL

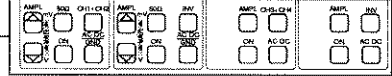

PM3094-100MHz-TRUE 4 CHANNEL

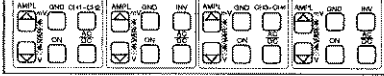

PM3092-100MHz-4 CHANNEL

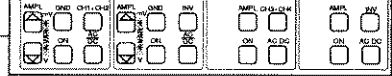

REAR VIEW

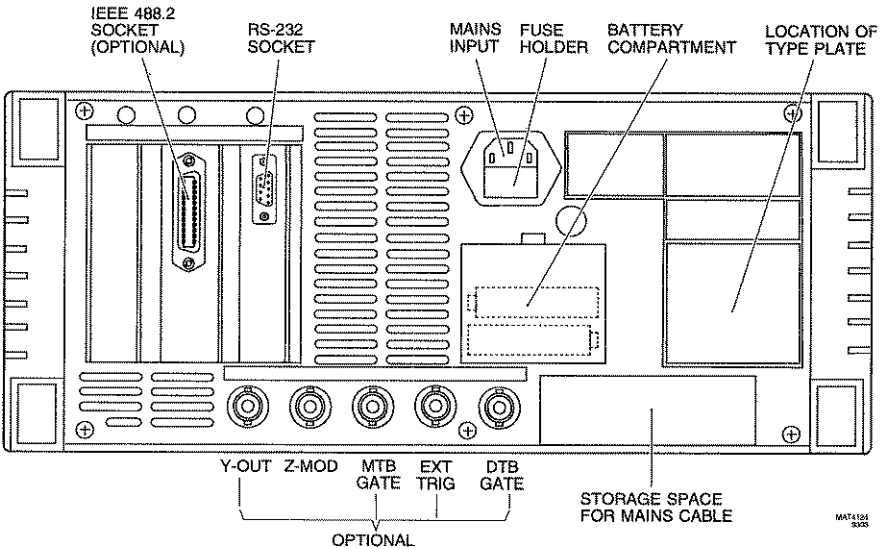

PANEL CONNECTIONS



PROBE ADJUST

Squarewave output signal for e.g. probe calibration. Amplitude is calibrated.

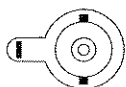

CH1

BNC input socket for vertical channel 1 with probe indication contact.

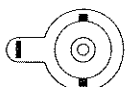

CH2

BNC input socket for vertical channel 2 with probe indication contact.

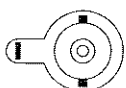

CH3

BNC input socket for vertical channel 3 with probe indication contact.

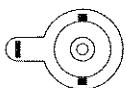

CH4

BNC input socket for vertical channel 4 with probe indication contact.



Ground socket (banana): same potential as safety ground.

REAR PANEL CONNECTIONS



Z-MOD

BNC input socket for external intensity-modulation of the CRT trace.

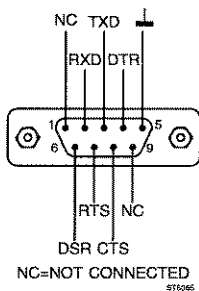

RS-232 BUS

Input/output socket to connect the oscilloscope to an RS-232 Interface.

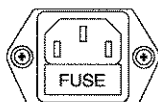

LINE IN

Line input socket. Fuse holder is built in.

OPTIONAL REAR PANEL CONNECTIONS



CH1 Y-OUT

BNC output socket with a signal derived from the Channel 1 input signal.



MTB GATE

BNC output socket with a signal that is "high" when the Main Timebase (MTB) is running and "low" for the other conditions.



DTB GATE

BNC output socket with a signal that is "high" when the Delayed Timebase (DTB) is running and "low" for the other conditions.



EXT TRIG

BNC input socket used as an extra external trigger input for the Main Timebase.

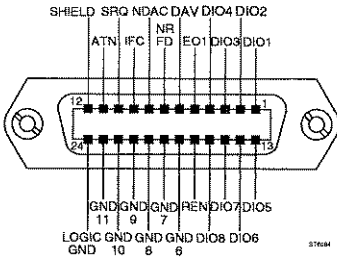

IEEE 488.2 BUS OPTION

If installed you will find here the input/output socket to connect the oscilloscope to an IEEE 488 interface.

1 OPERATORS SAFETY

Read this page carefully before installation and use of the instrument.

1.1 INTRODUCTION

The instrument described in this manual is designed to be used by properly-trained personnel only. Adjustment, maintenance and repair of the exposed equipment shall be carried out only by qualified personnel.

1.2 SAFETY PRECAUTIONS

For the correct and safe use of this instrument it is essential that both operating and service personnel follow generally-accepted safety procedures in addition to the safety precautions specified in this manual. Specific warning and caution statements, where they apply, will be found throughout the manual. Where necessary, the warning and caution statements and/or symbols are marked on the apparatus.

1.3 CAUTION AND WARNING STATEMENTS

CAUTION: Is used to indicate correct operating or maintenance procedures in order to prevent damage to or destruction of the equipment or other property.

WARNING: Calls attention to a potential danger that requires correct procedures or practices in order to prevent personal injury.

1.4 SYMBOLS



Read the operating instructions



Protective earth (black)
(grounding) terminal

1.5 IMPAIRED SAFETY PROTECTION

Whenever it is likely that safety-protection has been impaired, the instrument must be made inoperative and be secured against any unintended operation. The matter should then be referred to qualified technicians. Safety protection is likely to be impaired when, for example, the instrument fails to perform the intended measurements or shows visible damage.

2 INSTALLATION INSTRUCTIONS

Attention: You are strongly advised to read this chapter thoroughly before installing your oscilloscope.

2.1 SAFETY INSTRUCTIONS

2.1.1 Grounding

Before any connection to the input connectors is made, the instrument shall be connected to a protective earth conductor via the three-core mains cable; the mains plug shall be inserted only into a socket outlet provided with a protective earth contact. The protective action shall not be negated by the use of an extension cord without protective conductor.

WARNING: Any interruption of the protective conductor inside or outside the instrument is likely to make the instrument dangerous. Intentional interruption is prohibited.

When an instrument is brought from a cold into a warm environment, condensation may cause a hazardous condition. Therefore, make sure that the grounding requirements are strictly adhered to.

2.1.2 Mains voltage cord, mains voltage range and fuses

Before inserting the mains plug into the mains socket, make sure that the instrument is suitable for the local mains voltage.

NOTE: When the mains plug has to be adapted to the local situation, such adaptation should be done by a qualified technician only.

WARNING: The instrument shall be disconnected from all voltage sources when a fuse is to be renewed.

The oscilloscope has a tapless switched-mode power supply that covers most nominal voltage ranges in use: ac voltages from 100 ... 240 V (r.m.s.). This obviates the need to adapt to the local mains (line) voltage. The nominal mains (line) frequency range is 50 Hz ... 400 Hz.



Line fuse rating: 1.6 AT delayed action, 250 V (for ordering code see "shipment note").

The mains (line) fuseholder is located on the rear panel in the mains (line) input socket. When the mains (line) fuse needs replacing, proceed as follows:

- disconnect the oscilloscope from the mains (line).
- remove the cover of the fuseholder by means of a small screwdriver.
- fit a new fuse of the correct rating and refit the cover of the fuseholder.

WARNING: Make sure that only fuses with the required rated current and of the specified type are used for replacement. The use of makeshift fuses and the short-circuiting of fuse holders are prohibited.



REAR VIEW

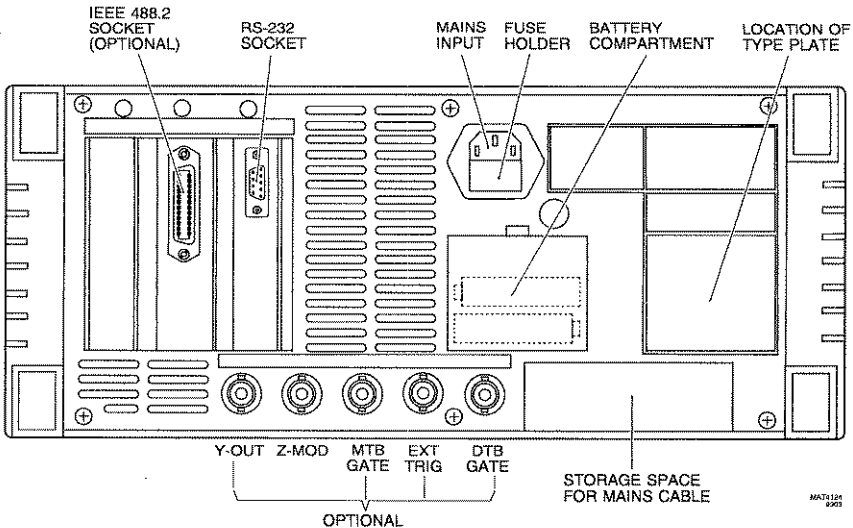

Figure 2.1 Rear view of the instrument showing the mains input/fuse-holder and back-up battery compartment.

When the apparatus is connected to its supply, terminals may be live, and the opening of covers or removal of parts (except those to which access can be gained by hand) is likely to expose live parts.

The apparatus shall be disconnected from all voltage sources before it is opened for any replacement, maintenance or repair.

Capacitors inside the apparatus may still be charged even when the apparatus has been disconnected from all voltage sources.

Any maintenance and repair of the opened apparatus under voltage shall be avoided as far as possible and, when inevitable, shall be carried out only by a skilled person who is aware of the hazard involved.

2.2 MEMORY BACK-UP BATTERIES

2.2.1 General information

Memory backup is provided to store the oscilloscope's settings when switched off so that the instrument returns to the same settings when turned on. Two AA (LR6) Alkaline batteries are used.

Note: The batteries are not factory installed and must be installed at the customer's site.

Note: This instrument contains batteries. Do not dispose of these batteries with other solid waste. Used batteries should be disposed of by a qualified recycler or hazardous materials handler. Contact your authorized Fluke Service Center for recycling information.



2.2.2 Installation of batteries

Proceed as follows:

- Disconnect the instrument line power.
- Remove the plastic cover of the battery compartment so that the battery holder becomes accessible.
- Install two penlight batteries (AA) in the battery holder as indicated on the battery holder.
- Reinstall the cover of the battery compartment.

Note: Front settings and autocalibration data disappear after exchange of the batteries with the instrument disconnected from the line power. After battery exchange, it is necessary to press the CAL key after the recommended warming up time.

CAUTION: Never leave the batteries in the oscilloscope at ambient temperatures outside the rated range of the battery specifications because of possible damage that may be caused to the instrument. To avoid battery damage, do not leave the batteries in the oscilloscope when it is stored longer than 30 days.

2.3 THE FRONT COVER

For ease of removal and reinstallation, the front cover has been designed to snap on to the front of the instrument.

The front can be removed as follows:

- Fold the carrying handle down so that the oscilloscope occupies a sloping position (refer to Chapter 2.4 for how to proceed).
- Pull the clamping lip at the top side of the cover slightly outwards.
- Lift the cover off the instrument.

2.4 HANDLE ADJUSTMENT AND OPERATING POSITIONS OF THE INSTRUMENT

By pulling both handle ends outwards away from the instrument, the handle can be rotated to allow the following instrument positions:

- vertical position on its rear feet;
- horizontal position on its bottom feet;
- in three sloping positions on its handle.

The characteristics mentioned in the REFERENCE MANUAL are guaranteed for the specified positions or when the handle is folded down.

CAUTION: To avoid overheating, ensure that the ventilation holes in the covers are free of obstruction. Do not position the instrument in direct sunlight or on any surface that produces or radiates heat.

In the rear panel of the instrument there is storage space for the mains cable. There is also a clamping device to fix the end of the mains cable to the rear panel. The mains plug then fits in the area where the RS232 connector is present. In this way the instrument can also stand on its rear feet.

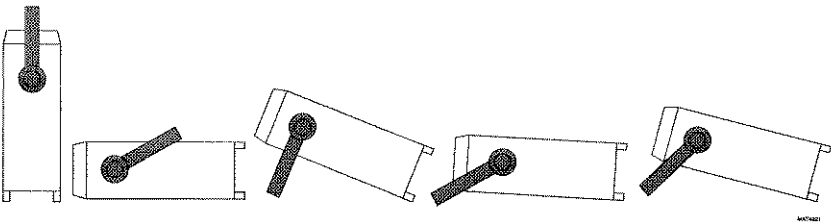

Figure 2.2 Instrument positions

2.5 IEEE 488.2/IEC 625 BUS INTERFACE OPTION

If your oscilloscope is equipped with the IEEE 488.2 interface, it can be used in a bus system configuration. The protocol used is SCPI (Standard Commands for Programmable Instruments). For setup information, refer to the function REMOTE CONTROL IEEE 488.2 in Chapter 5.

The IEEE 488.2 interface is a factory-installed option.

2.6 RS-232-C SERIAL INTERFACE

Your oscilloscope is equipped with an RS-232-C interface as standard. The interface can be used in a system for serial communication. The protocol used is CPL (Compact Programming Language). CPL is a small set of very powerful commands that can be used for full remote control. Detailed information about this interface and the CPL protocol is given in Appendix E in this manual. For setup information, refer to the REMOTE CONTROL RS-232 function in Chapter 5 'Function Reference'.

2.7 RACK MOUNTING

The rackmount kit (PM 8960/04) allows you to install the oscilloscope in a standard 19 inch rack.

It is not necessary to open the oscilloscope itself to mount the rackmount kit. Installation can be done easily by the user.

2.8 PM3092, PM3094, PM3082, PM3084 VERSIONS

The model number of your oscilloscope (e.g. PM3094) is indicated on the text strip above the CRT. This model number is also represented by the digits 6, 7, 8 and 9 of the 12- digit code on the type plate on the rear panel.

The instrument's serial number is also given on the type plate. This number consists of a six digit code preceeded by the characters 'DM'.

The instrument version can also be displayed on the CRT after having pressed menu key UTILITY and then softkey MAINTENANCE.



3 GETTING STARTED

This chapter gives a 10 minute tutorial intended for those who are NOT familiar with Fluke oscilloscopes. Those who are already familiar can skip this chapter and continue to Chapter 4.

3.1 FRONT-PANEL LAYOUT

The oscilloscope front panel is organized into functional areas. The areas are discussed in order of typical operation.

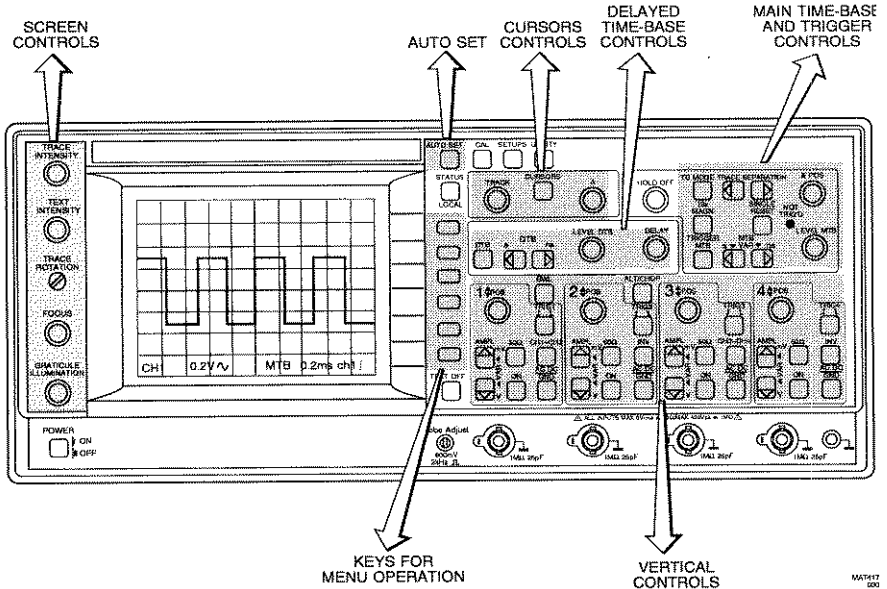

Figure 3.1 Front-panel layout PM3094

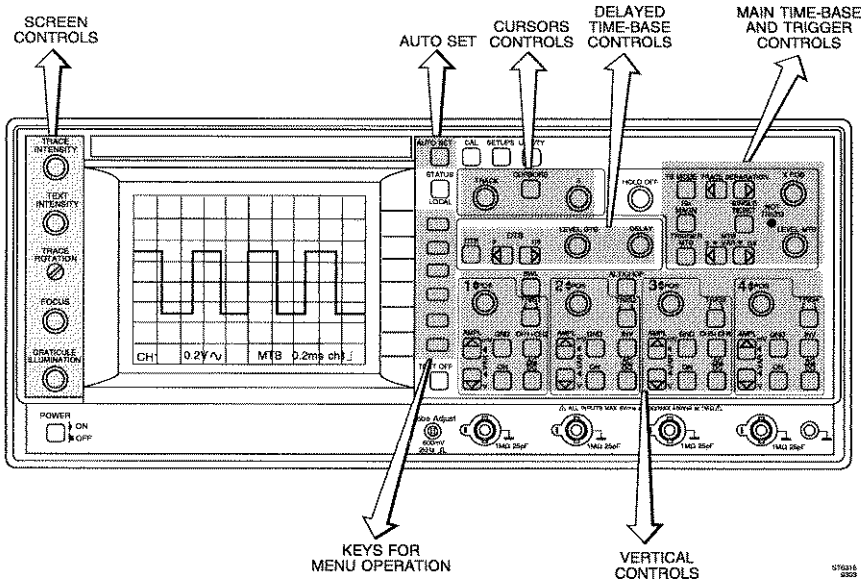

Figure 3.2 Front-panel layout PM3084

Note that the front-panel shown is the most complete version of this range of oscilloscopes. Some controls may not be present in more simplified versions within this range. For differences, see Section 4.1. For the "getting started" procedure, however, only CH1 and CH2 are used. These are almost identical for all models; differences are indicated in the text as necessary.

Typical operation of your instrument will be:

- Turning on the instrument (see Section 3.2)
- Initial standard setup (see Section 3.2)
- Screen controls (see Section 3.3)
- Auto setup (see Section 3.4)
- Vertical setup (see Section 3.5)
- Timebase setup (see Section 3.6)
- Direct trigger setup (see Section 3.7)
- Cursor operation (see Section 3.9)
- Advanced trigger functions (see Section 3.10)
- More signal detail with DTB (see Section 3.11)

3.2 TURNING ON THE INSTRUMENT

Connect the power cord and set the front panel power switch to ON. As long as the line power is between 100V to 240V nominal, 50/60 Hz, the instrument **automatically** turns on and after performing the built-in power-up routine, it is immediately ready for use. The instrument's settings will be identical to those when the oscilloscope was switched off (with the batteries installed).

STANDARD SETTING

To ensure that you will get the same setup in all cases, press the **STATUS** key and **TEXT OFF** key simultaneously. This will set the instrument in a predefined default condition (STANDARD SETUP) and a trace will appear on the screen. Text is also displayed at the bottom of the screen.

3.3 SCREEN CONTROLS

The screen controls can be adjusted for optimum trace, text and spot quality by the controls to the left of the screen.

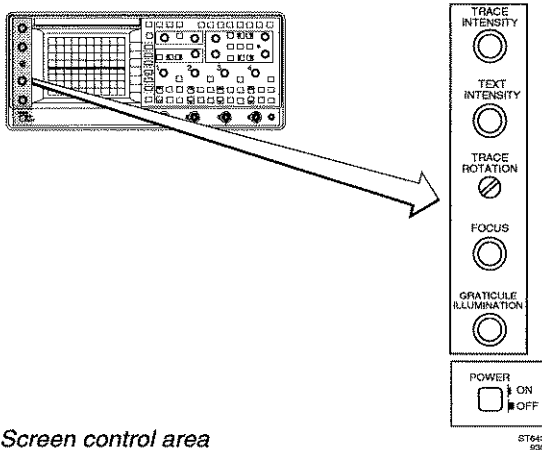

Figure 3.3 Screen control area

The brightness on the screen is adjusted by two controls, one for the trace and one for the text.

- Turn the **TRACE INTENSITY** control clockwise and check that only the brightness of the trace increases.
- Turn the **TEXT INTENSITY** control clockwise and check that only the brightness of the text increases.

The sharpness of the trace and text is optimized by the **FOCUS** control.

When you are making photographs or are in a dark environment, you can use the **GRATICULE ILLUMINATION** control to illuminate the graticule of the screen.

The trace is set parallel to the horizontal graticule lines by the **TRACE ROTATION** control, which is screw driver controlled.

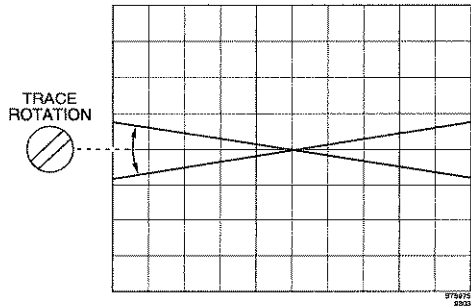

3.4 AUTO SETUP

The best way to start each measurement is by using the **AUTOSET** key. This **automatically** finds and scales all relevant parameters on all channels.

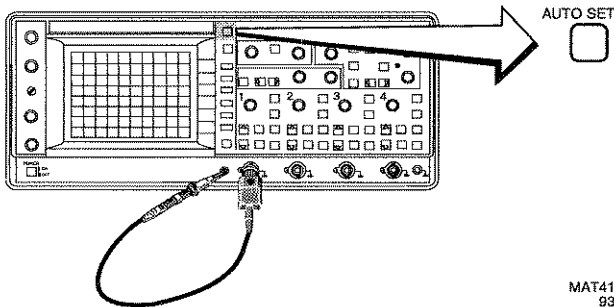

Figure 3.4 Measuring setup

Step 1 Connect the probe as shown in figure 3.4.

NOTE: The **AUTOSET** is programmable. Because you have set the instrument in the "standard setup" before (see Section 3.2), all programmable features are set to a predefined condition. Programming of the **AUTOSET** is explained in Chapters 4 and 5.

Step 2 Press the **AUTOSET** key.
The scope flashes the message 'AUTO SETTING....' on the screen. In a few seconds the front-panel settings are adjusted for an optimized display of the applied signal.

Step 3 The calibration signal Probe Adjust is clearly displayed. The parameters of the channel and the timebase settings are displayed at the bottom of the screen.

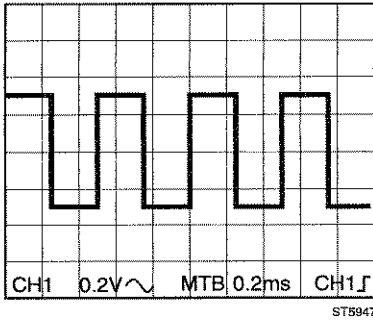

Step 4 Check the pulse response before doing any measurement. If the pulse shows overshoot or undershoot, you can correct this by using the trimmer in the probe's body. This prevents measurement errors! Chapter 4 describes how to adjust the pulse response.

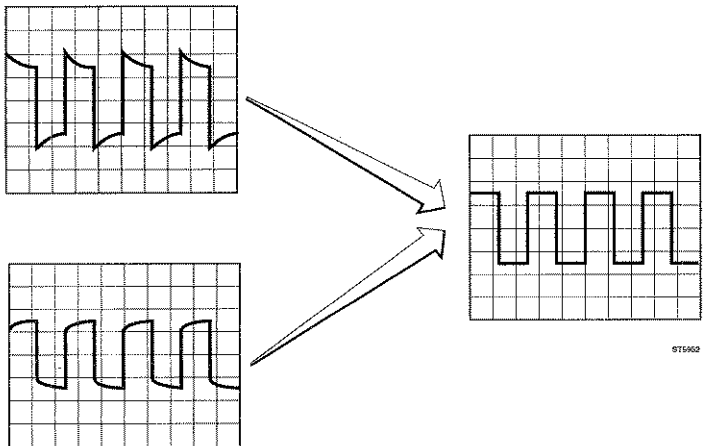

In most cases, using the AUTO SETUP is sufficient for a good screen display. However, for display optimization or studying the signal in more detail, continue with the paragraphs below.

NOTE: If you get lost when adjusting your instrument, just press **AUTOSET**.

3.5 VERTICAL SETUP

This section deals with the setting of the input circuits of the four channels. The main adjustments are **AMPL**itude, **POS**ition, and the channel input coupling keys for **GND**, **DC**, and **AC**.

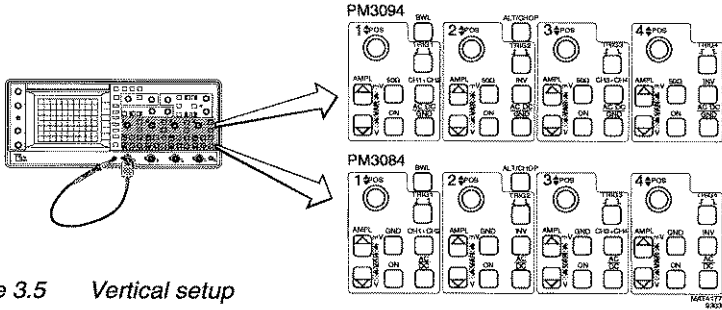
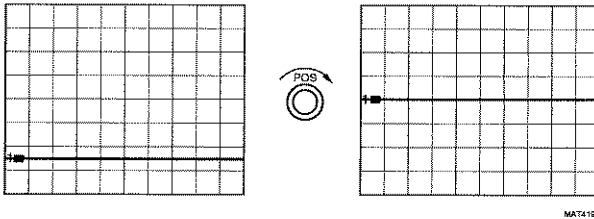

Figure 3.5 Vertical setup

Step 1 Press the **AUTOSET** key.

Step 2 Adjust the absolute zero level. Disconnect the signal and use the **POS** control to set the trace in the middle of the screen. A marker with the channel number ('1-') at the left of the screen indicates the ground reference.



MAT4121

Step 3 Reconnect the probe to the Probe Adjust signal for display.

Step 4 You can decrease or increase the amplitude of the signal in a 1, 2, 5 sequence by pressing the **AMPL** key pair. Note that the bottom of the screen shows the **AMPL/DIV** setting of CH1.

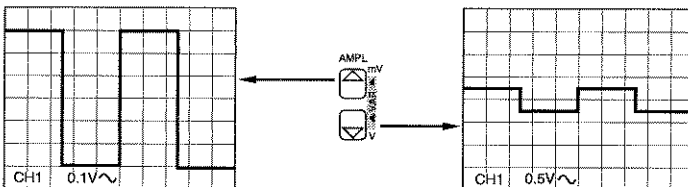

MAT4123
2009

Step 5 Press the **ON** key of CH2 and notice that a second trace is now visible. The position and amplitude of this channel can be adjusted in a similar manner as in CH1. The channel settings are also displayed in the bottom of the screen.

Press the **ON** key of CH2 once again to turn this channel off.

Step 6 Press the **AC/DC/GND** or **GND** key of CH1 until a 'L' sign is displayed on the bottom text line. This interrupts the input signal and connects the input to the ground. In this case, only the 'base' line is visible.

Press the **AC/DC/GND** or **GND** key once again for ac input coupling; the bottom text line now displays ' \sim '.

Step 7 In most cases, dc input coupling is used to show ac as well as dc components of the signal. However, in some cases where a small ac signal is superimposed on a large dc voltage, ac input coupling must be used. Then only the ac component is visible on the screen. The text line shows a '=' or ' \sim ' sign for these input coupling conditions. Because the calibration signal is a square wave with a low level of 0 V and a high level of +600 mV, the screen shows the following two displays:

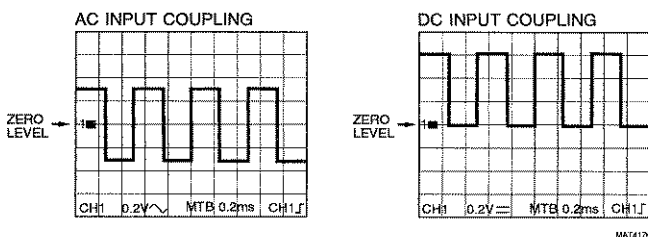

NOTE: Refer to Chapter 4 for an explanation of the CH1+CH2, BWL, ALT/CHOP, TRIG1 and 50 Ω keys.

3.6 TIMEBASE SETUP

The next step is the adjustment of the timebase controls (**MTB** time/div, **X POS**ition, and **10X MAG**nifier).

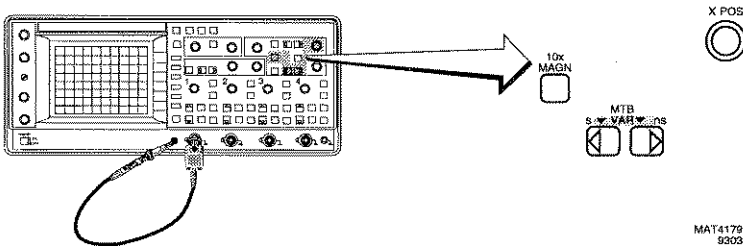
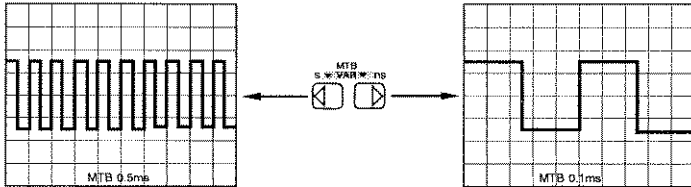

Figure 3.6 Timebase setup

- Step 1 Press the **AUTOSET** key.
- Step 2 Use the **MTB** time/div key pair to decrease or increase the number of periods of the signal on the screen.



MAT4194
5003

- Step 3 Turn the **X POS** control to shift the signal horizontally (left or right) across the screen.

Step 4 When necessary, you can use the 10X MAGN key to expand the signal 10x on the screen. The 'MGN' indication and the corrected MTB setting are displayed in the text line.

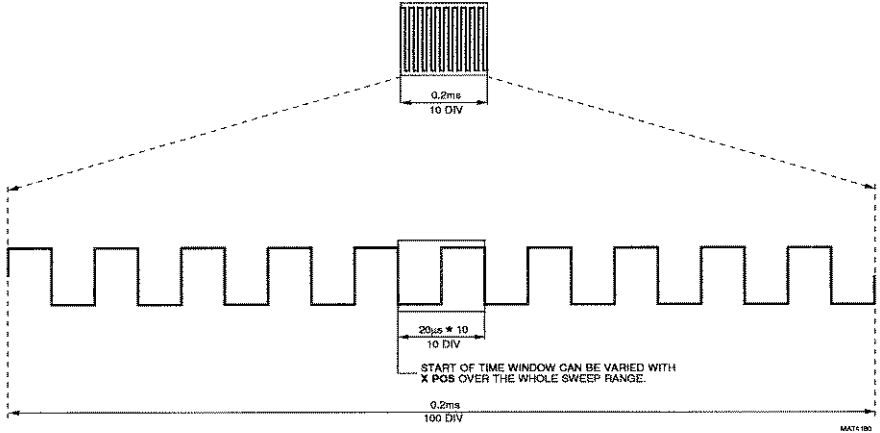

3.7 DIRECT TRIGGER SETUP

Now you are ready to set your trigger conditions. You will use one of the channel selection keys (TRIG1, TRIG2, TRIG3, TRIG4) and the LEVEL MTB control.

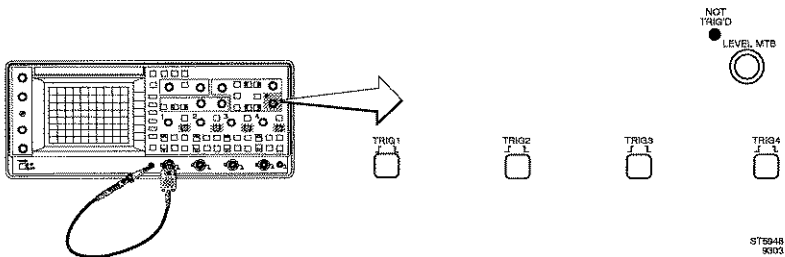
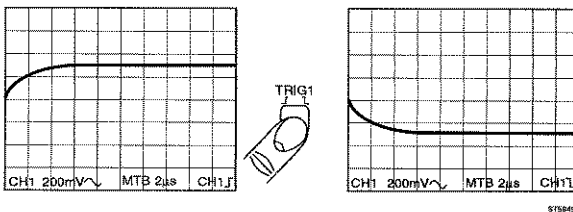

Figure 3.7 Direct trigger setup

Step 1 Press the **AUTOSET** key. The square-wave signal of channel 1 is now displayed. Turn channel 2 on to display a second horizontal trace (channel 2 has no input signal!).

- Step 2 Press the **TRIG2** key so that channel 2 is selected as the trigger source instead of channel 1. The result is that the signal on channel 1 is no longer triggered (not stable). The trigger indication lamp (**NOT TRIG'D**) lights as a warning that the scope is not triggered. Check also that the right side of the bottom text line indicates the trigger source ('ch2').
- Step 3 Press the **TRIG1** key. Channel 1 is selected as the trigger source. The 'ch1' symbol is displayed in the bottom text line. Triggering resumes.
- Step 4 Press the **ns** key of the **MTB** time/div key pair until the timebase is set to '2 μ s'.
- Step 5 The next choice is the trigger slope on the positive or negative edge of the signal. The same **TRIG1** key that was used to select the trigger source is also used to select the trigger slope. Note that the slope is also displayed in the bottom text line.
- Step 6 Press the **TRIG1** key a few times. This key acts as a toggle key between the positive slope and negative slope.



- Step 7 For repetitive signals, you can obtain a stable, jitter-free display when each timebase sweep is triggered at a stable level of the signal. The level is adjusted with the **LEVEL MTB** control. Turn the control. The precise position in relation with the ground reference (between +100 % and -100 %) is then displayed on the screen. When turning the control, the position is displayed on the screen ('Level= +29 %').

The previous steps covered the **basic adjustments**. Now you are ready to look at the special features of the oscilloscope. This includes the use of the cursors, advanced trigger functions and using the second (delayed) timebase for signal details.

3.8 MORE ADVANCED FEATURES

On the front panel, some keys have **blue** text. Pressing one of these keys (= **menu keys**) means that a menu is displayed on the right side of the screen. This menu gives you access to the more advanced functions of the oscilloscope. You can select the desired functions with the blue softkeys at the right side of the screen; the highlighted text is the active function at that moment.

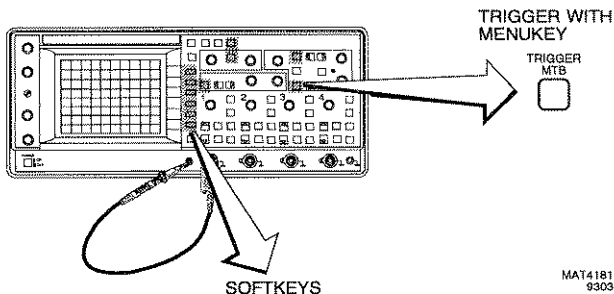

MAT4181
9303

Figure 3.8 Menu keys and softkeys

Step 1 Press the **TRIGGER MTB** key. Check that the 'TRIGGER MAIN TB' menu is displayed at the right side of the screen.

After changing the setting, you can deactivate the menu again to use the full screen for the signal.

There are two way's to do this:

- Press the **TRIGGER MTB** key once again.
- Press the **TEXT OFF** key.

The **TEXT OFF** key operates in a 1-2-3 cycle and allows you to suppress the bottom text line.

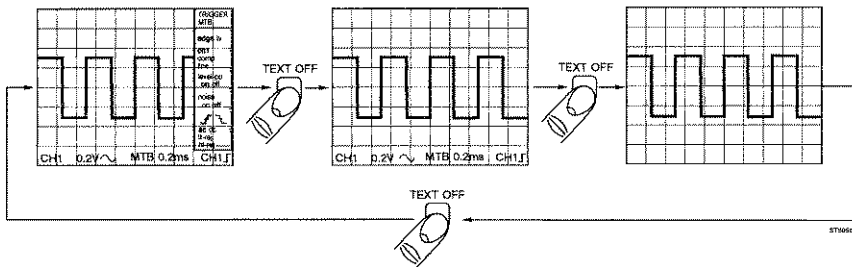

Step 2 Use both methods to get acquainted with turning the menus and the bottom text line on and off.

3.9 CURSOR OPERATION

Cursors are used to perform accurate amplitude or time measurements of the signal.

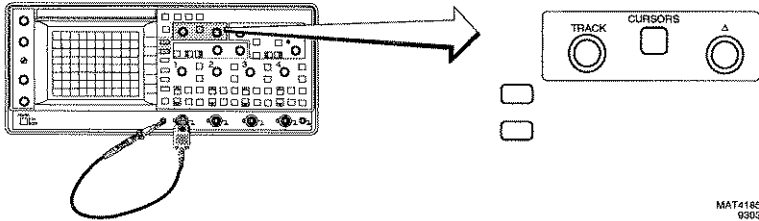

MAT4185
9303

Figure 3.9 Cursor setup

- Step 1 Press the **AUTOSET** key.
- Step 2 Press the **CURSORS** key to enter the cursors menu. The menu is now displayed on the screen and the cursors are on.



MAT4186

- Step 3 Use the first blue softkey to turn the cursors **on** or **off**. When the cursors are turned **on**, a cursor menu is displayed on the screen.

NOTE: The selection is done in a closed cycle ('off' 'on' 'Vpp'). The Vpp mode is explained in Chapter 4.

- Step 4 Use the second blue softkey to select one of the three cursor modes:
- vertical cursor measurements, indicated by '=' for measuring voltage.
 - horizontal cursor measurements, indicated by '||' for measuring time or frequency.
 - both vertical and horizontal measurements, indicated by '#'. The top text line displays the result of the measurements (ΔV or ΔT).

- Step 5 Press the second blue softkey until '||' is highlighted.
- Step 6 The **TRACK** control moves both cursors simultaneously. For example, to measure the period time of the input signal, set the left (|) reference) cursor to a rising edge of the signal; ignore the right (| Δ) cursor.
- Step 7 The Δ control moves the right cursor only. Set this cursor to the next rising edge of the signal.
- Step 8 The top text line now shows the pulse repetition time of the signal (e.g. ch1: ΔT= 500 μs).

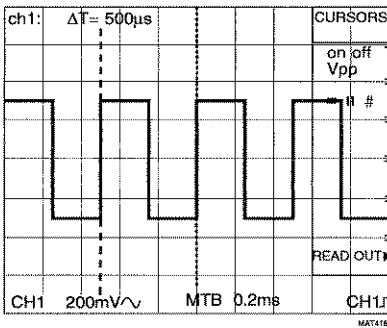

- Step 9 Press the second blue softkey two more times until '=' is highlighted. Now perform a peak-to-peak measurement and check that the amplitude of the signal ('ΔV') is 600 mV.

NOTE: When you select '#', the fifth blue softkey is automatically activated so that you can choose between using the controls for positioning the vertical cursors ('||') and the horizontal cursors ('=').

The 'READOUT' submenu is explained in Chapter 4.

3.10 MORE ADVANCED TRIGGER FUNCTIONS

You have already seen that the most important trigger functions (source, slope, and level) can be controlled directly (see Section 3.7). For more advanced trigger functions, a CRT menu is used.

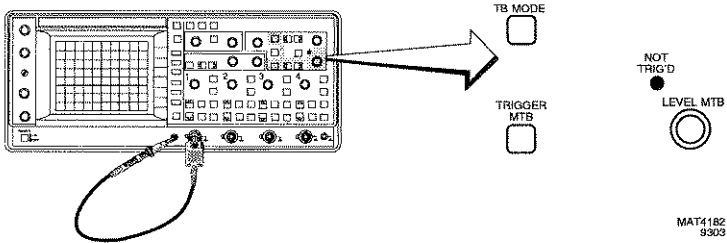

Figure 3.10 More advanced trigger setup

Press the menu key **TRIGGER MTB**. This turns the menu on. An extensive set of functions is now displayed.

TRIGGER MAIN TB edge tv ch1 comp line level-pp on off noise on off ac dc lf-rej hf-rej
--

MAT4183

All functions are explained in Chapter 4. For the majority of applications, this menu is not needed.

3.11 MORE SIGNAL DETAIL WITH THE DELAYED TIMEBASE.

When you need to look at a part of a signal in more detail, a second (delayed) timebase is available. This timebase has its own timebase keys and trigger level adjustment. Additional selections are made in the menu under menu key DTB.

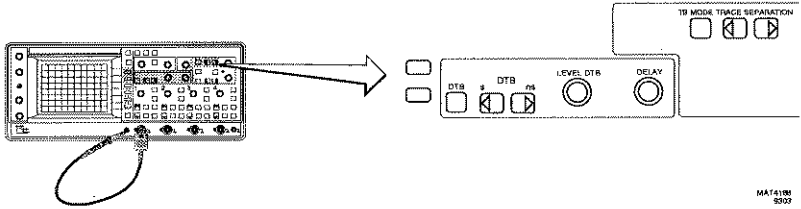

Figure 3.11 Delayed timebase setup

Step 1 To come to an easy default setting for this part of the getting started tutorial, select the STANDARD SETUP. To do this, press the STATUS and TEXT OFF keys simultaneously. Then shift the trace to the upper half of the screen as indicated in the figure.

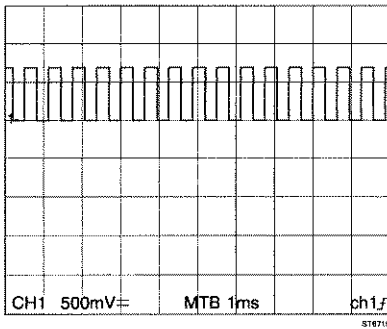

Figure 3.12 Setup to start this section of the getting started tutorial

- Step 2 Now press the DTB key. The DELAYED TIMEBASE menu is now displayed on screen. Press the first softkey to activate the delayed timebase.

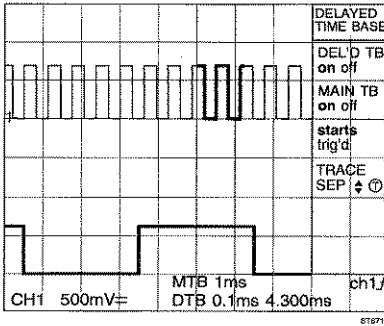

Figure 3.13 The main timebase trace and the delayed timebase trace displayed simultaneously

The first trace is the main timebase trace. This first trace shows an intensified part. If it is difficult to see the intensified part, use the TRACE INTENSITY control to adjust the trace intensity. The second trace is the delayed timebase trace, and it is an expanded representation of the intensified part on the first trace.

- Step 3 Use the DELAY control to shift the intensified part and to select what part of the main timebase you want to magnify.
- Step 4 The delayed timebase 'DTB s ns' keys can be used to select the magnification factor. Notice the changing delayed timebase TIME/DIV readout at the bottom of the screen.
- Step 5 The 'T' symbol at the fourth softkey indicates that the cursor TRACK control can be used to make adjustments. In the menu the cursor TRACK control can be used to change the TRACE SEPARATION. This is the distance between the main timebase and the delayed timebase display. This distance can also be adjusted with the TRACE SEPERATION keys.

The delayed timebase can be used in the triggered mode. The triggered mode can be selected with the starts/trig'd softkey. The triggered mode will be explained in chapter 4; so remain in the starts mode.

Step 6 Press the TEXT OFF key to turn off the menu. Notice that the delayed timebase is still active and that the most important controls DELAY and 'DTB s ns' still allow you to operate the delayed timebase. Press the TRACE SEPARATION keys to operate the TRACE SEParation.

NOTE: *You are now able to operate nearly all the oscilloscope's functions in most routine applications. Please continue on to Chapter 4 for a more detailed discussion of the oscilloscope's advanced features.*



4 HOW TO USE THE INSTRUMENT

This chapter allows the more experienced oscilloscope user to learn more about the advanced features of this instrument and how to use them. Examples are given in a step by step sequence.

Inexperienced oscilloscope users should read chapter 3 before beginning this chapter.

4.1 INTRODUCTION.

FRONT PANEL LAYOUT

This family of analog oscilloscopes consists of four-channel and two-channel instruments.

Features described in the following section may not be available in all channels. The differences are described below.

PM3094 200 MHz True 4 Channel Oscilloscope.

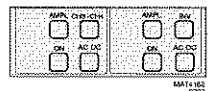
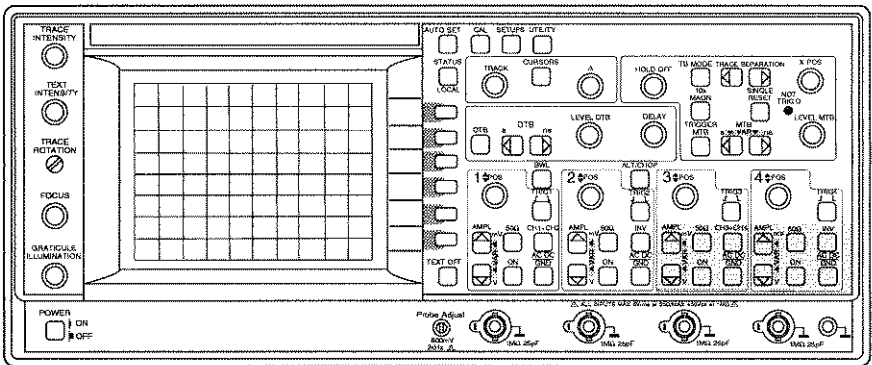

MAT 1163
6003

PM3092 200 MHz 4 (2+2) Channel Oscilloscope.

The PM3092 has the same capabilities as the PM3094 except for channels 3 and 4 (shaded area).

The differences between the full channels CH1 and CH2, and the two other channels CH3 and CH4 are:

- The attenuator has two settings (0.1 V/div and 0.5 V/div) and is controlled by a single toggle key.
- The 50Ω input impedance is not present in channels CH3 and CH4 of the PM3092.
- The inputs of CH3 and CH4 of the PM3092 can be ac or dc coupled, but cannot be connected to ground.

PM3084 100 MHz True 4 Channel Oscilloscope.

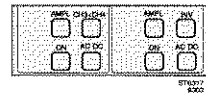
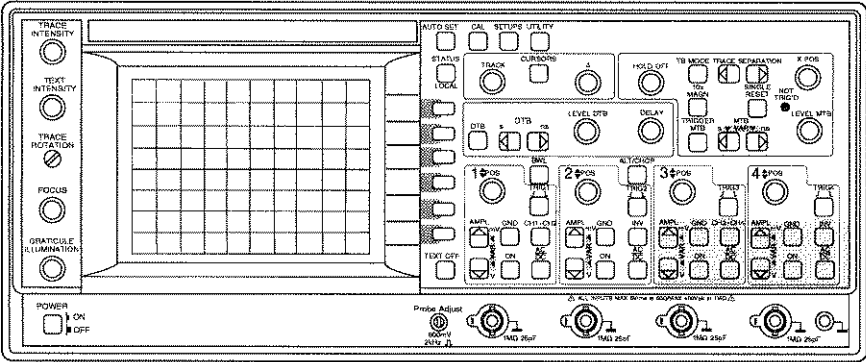

PM3082 100 MHz 4 (2+2) Channel Oscilloscope.

The PM3082 has the same capabilities as the PM3084 except for channels 3 and 4 (shaded area).

The differences between the full channels CH1 and CH2, and the two other channels CH3 and CH4 are:

- The attenuator has two settings (0.1 V/div and 0.5 V/div) and is controlled by a single toggle key.
- The inputs of CH3 and CH4 of the PM3082 can be ac or dc coupled, but cannot be connected to ground.

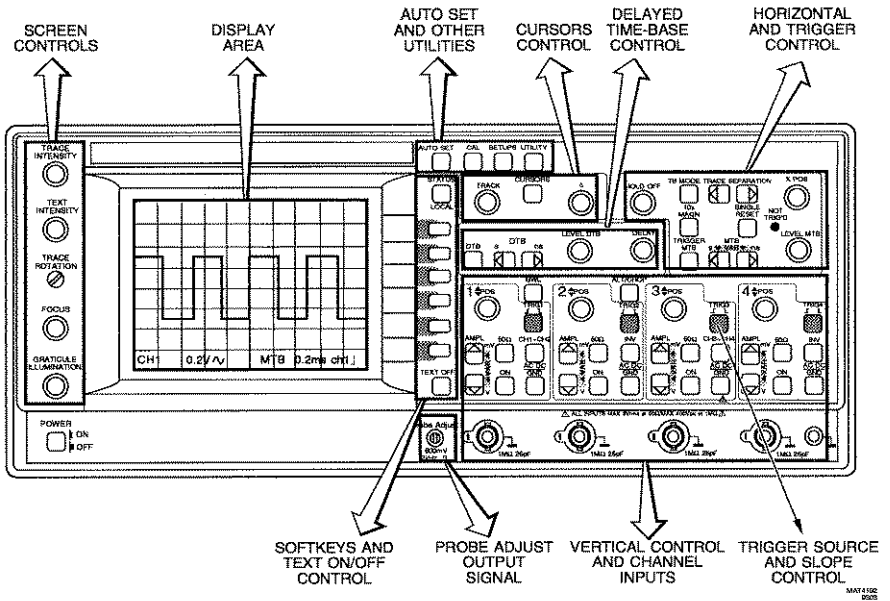

The controls on the front are grouped by function. In this chapter, a description for each group of controls is given in the following sequence:

- | Section | Group |
|---------|--|
| 4.2 | Display and Probe adjustment.
(also includes Screen controls and Probe Adjust signal) |
| 4.3 | Vertical control and channel inputs |
| 4.4 | Horizontal and Trigger control |
| 4.5 | Advanced Horizontal and Trigger functions
(including Menu and softkeys) |
| 4.6 | Delayed timebase |
| 4.7 | Cursor functions |
| 4.8 | AUTOSET and other utilities |

MAY 2002

Observe the keys on the front of your oscilloscope to see what kind of function they perform. The key functions are as follows:



Direct function key. These keys provide direct access to a function. Press to directly select a function, such as MAGN to switch the Magnifier on or off. Other examples include AUTOSET for automatic setting up the oscilloscope, AC DC GND for selection of the instrument's input coupling, and ALT/CHOP to select the multiple channel display mode.



Menu initialization key with blue text. Press to produce a menu on the screen from which functions can be selected that are related to the function name of this key.



Key pair. Press to select a value from a range.



Rotary control. Used for continuously variable control of a function.



Softkey. Press to select a function from the menu that has been initialized by pressing one of the menu initialization keys.

4.2 DISPLAY AND PROBE ADJUSTMENTS

To help you follow the step-by-step descriptions, each section begins by recalling the standard setting.

If you get lost you can return to the beginning of the section, because all functions are set to a predefined state to create a correct start situation.

RECALL STANDARD SETTING

- Press the **STATUS** and **TEXT OFF** keys simultaneously

Recalling the standard setting always results in a trace on the display, even with no signal applied to the oscilloscope inputs.

DISPLAY ADJUSTMENT

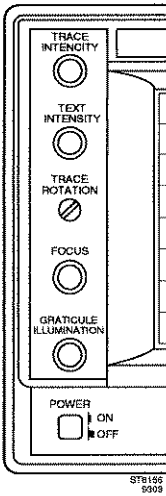

Before going through the examples that introduce you to features of this oscilloscope you can adjust the display as follows:

- Turn the **TRACE INTENSITY** control for optimum trace brightness.
- Turn the **TEXT INTENSITY** control for optimum display brightness of the text.
- Adjust trace alignment with the graticule with the screwdriver control **TRACE ROTATION**.
- Turn the **FOCUS** control until a sharp trace is obtained.
- Finally you can turn the **GRATICULE ILLUMINATION** control to illuminate the graticule as desired.

DISPLAY LAYOUT

The following illustration shows the layout of the display with a maximum amount of text.

Most text is active only when specific functions are activated.

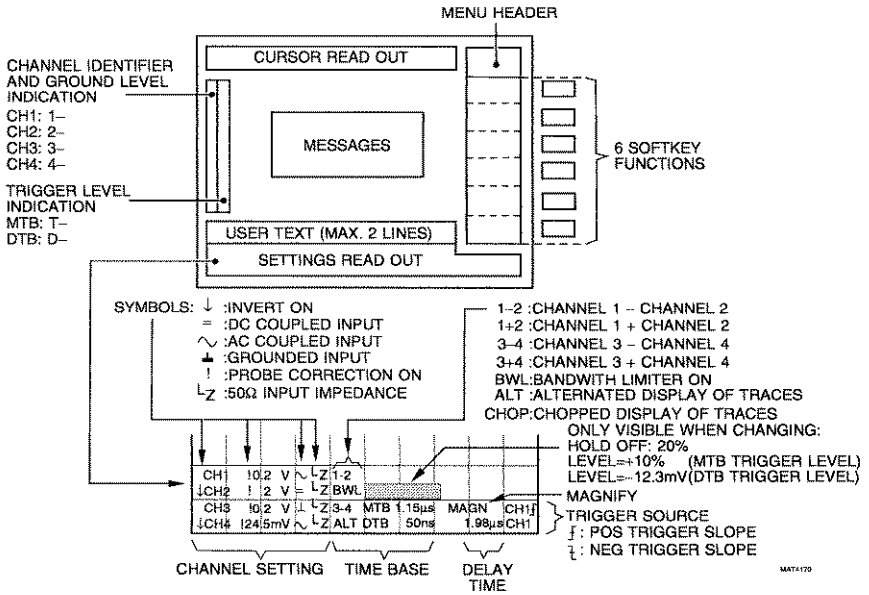

SIGNAL FOR PROBE ADJUSTMENT

The measuring probe has been adjusted and checked before delivery. However, to match the probe to your oscilloscope, you must perform the following procedures to optimize the pulse response of the combination of oscilloscope and probes.

- **Connect the probe body to channel 1**
- **Connect the probe tip to the Probe Adjust output of the oscilloscope.**
- **Press the AUTASET key**

If the display looks like one of the two displays shown on the left, you must adjust your probe to get the display shown on the right.

A trimmer can be adjusted through a hole in the compensation box of the probe, to obtain optimum pulse response. See the following figure.

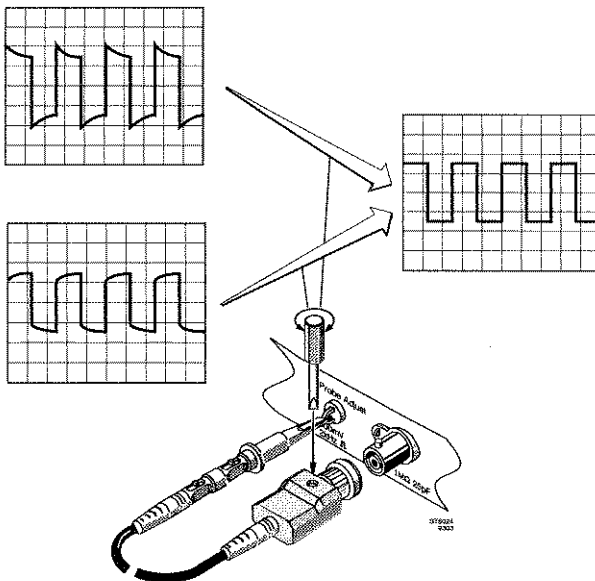

- **Adjust the probe until the screen shows the correct compensation.**

The probe is now adjusted for optimum pulse response with this oscilloscope. If you connect the probe to another oscilloscope, it must be adjusted again to that oscilloscope.

- **Repeat this adjustment for the second probe.**

4.3 VERTICAL DEFLECTION.

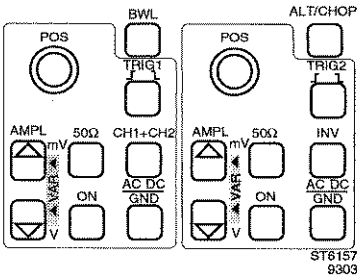

The CH1 and CH2 section of the PM3094 is shown on the left.

Refer to section 4.1 for the differences between model numbers PM3092/PM3094.

To start this section with the settings in a predefined state, you must recall the standard setting.

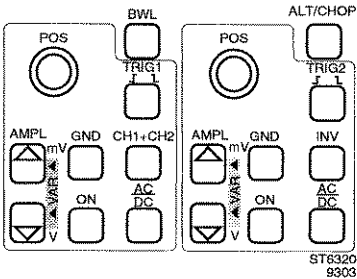

The CH1 and CH2 section of the PM3084 is shown on the left.

Refer to section 4.1 for the differences between model numbers PM3082/PM3084.

To start this section with the settings in a predefined state, you must recall the standard setting.

STANDARD SETTING

- Press the **STATUS** and **TEXT OFF** keys simultaneously.
- Connect the Probe Adjust signal to channel 1.

The Probe Adjust signal, now supplied to the input, is a square wave with a lower level of 0 V and a top level of 600 mV.

- Press the **AUTOSET** key

VERTICAL COUPLING

AC, DC, GND

The input coupling after AUTOSSET is ac. The vertical position is adjusted so that the displayed waveform is around the vertical center of the screen.

ac coupling can be used to examine small ac parts that are superimposed on large dc voltages.

- Press the **AC DC (GND)** key once so that **DC input coupling is obtained.**

The result is an upward shift of the square-wave voltage on the screen. This is caused by the dc component in the CAL signal that was filtered out in ac coupling. The coupling sign on the screen also changes from ac to dc.

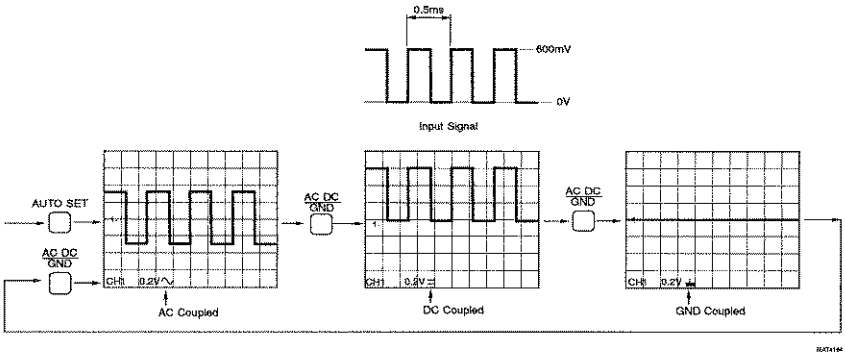

- Press the **(AC DC) GND** key to obtain ground coupling

A straight line is now displayed. This is the 0 V (ground) level of the input signal. This level is the 0 Volt reference for amplitude measurements. The coupling sign now indicates ground coupling.

VERTICAL**POSITION**

POS



576156

Use the POS control to adjust the ground level to any desired vertical position on the screen.

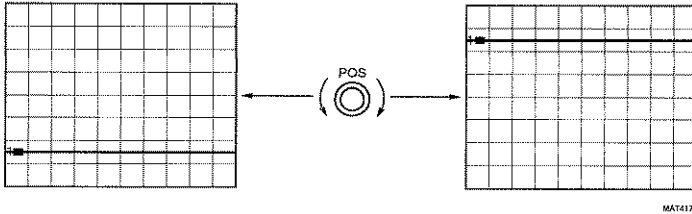

MAT4171

- Use the position control to position the line in the middle of the screen.
- Press AC DC (GND) once.

The Probe Adjust signal is now displayed around the central graticule line. This is because the input coupling is ac and you just adjusted the 0 Volt level to the center of the screen.

VERTICAL

AMPLITUDE

- Press the upper key of the AMPL key pair



This increases the amplitude of the displayed waveform. As the amplitude of the displayed waveform changes, the screen readout of the input sensitivity changes as well. The result is a waveform with an amplitude of six divisions. This equals an amplitude of six div x 100mV/div = 600 mV.

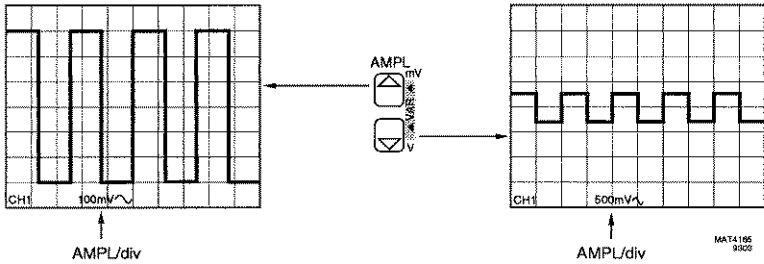

Try other sensitivity settings as follows :

- Press each key of the AMPL key pair to step through the attenuator range.

Observe that the sensitivity readout changes in steps that have a 1, 2, 5 sequence. The AMPL key pair allows you to step up and down through the sensitivities from 5 V/div to 2 mV/div and vice-versa. This sequence enables a quick selection between the oscilloscope's sensitivity positions and are such that almost every input signal can be made visible with sufficient amplitude.

- Adjust AMPL to 100mV again.

A waveform with an amplitude of six divisions is displayed.

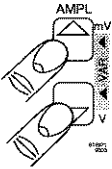
VERTICAL**VAR AMPLITUDE**

Use the VAR key pair to make fine adjustments between the 1-2-5 steps of the input amplitude settings.

When the VARiable mode is switched off, the oscilloscope selects the nearest '1-2-5' value.

- **Activate the VAR function by pressing the AMPL key pair simultaneously.**
- **Adjust amplitude with either key of the AMPL key pair**

Observe that the sensitivity steps that can be selected are much finer than before and that the displayed amplitude is slowly getting bigger or smaller.

Notice: The VAR values serve as calibrated amplitude settings as well.

This enables you to make accurate measurements and readouts even when intermediate settings are used.

- **Adjust AMPL to 220 mV.**
- **Press the VAR key pair to turn the VARiable mode off.**

VERTICAL**CH1+CH2**

- **Connect channel 2 to the Probe Adjust signal, using the second probe.**
- **Press the AUTOSET key.**
- **Adjust POS and AMPL to get the left picture below.**
- **Press the CH1+CH2 key.**

A third trace will appear on the screen. This trace has double the amplitude of the Probe Adjust signal. The position is the sum of the CH1 and CH2 positions.

- The active function is displayed as '1+2'.

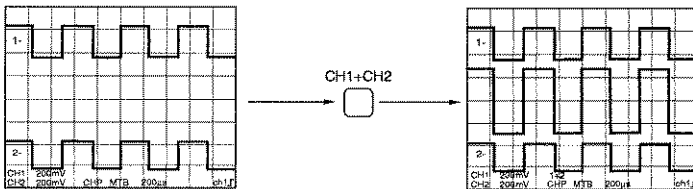

VERTICAL

INVERT

- Press the INV key of the channel 2.

The square wave with double amplitude will change into a straight line at ground level. Since channel 2 is inverted before it is added to channel 1, the result will be CH1-CH2. This is indicated as '1-2' on the screen.

(If the line is not straight, it may be that the probes are not correctly adjusted, causing the input signals at the input connectors of the oscilloscope to be unequal).

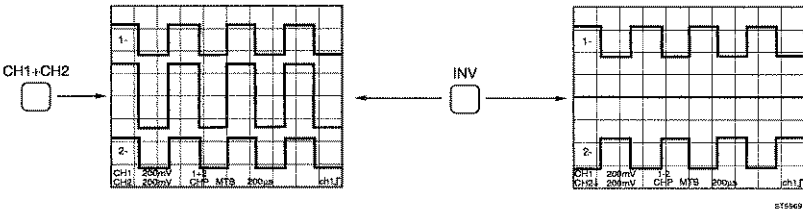

VERTICAL

BANDWIDTH LIMITER



The Bandwidth Limiter reduces the bandwidth of the vertical channels to 20 MHz. This is done by a filter that is added in the vertical channels. This feature can be used to suppress noise.

- Disconnect the probe from channel 2.
- Press the AUTOSSET key.
- Press the BWL key.

Observe that the displayed line becomes thinner as an indication that the amount of noise is reduced.

The text BWL appears on the screen to indicate that the function is active.

- Press the BWL key again to switch the function off.

VERTICAL**50Ω**

The PM3092 offers the selection of an input impedance of 50Ω for channels 1 and 2. The PM3094 offers this selection for all channels.

The 50Ω input impedance is used to obtain a correct impedance to match signal sources of the same impedance. For interconnection, a coaxial 50Ω cable must be used. The 50Ω position is indicated on the display with the L_Z sign (Low Z = Low Impedance).

- **Disconnect all signals from the inputs.**
- **Using a 50Ω coaxial cable, connect a 4 V_{pp}, 2 kHz signal from a generator with 50Ω output to channel 1.**
- **Press the AUTOSET key.**
- **Press the 50Ω key.**

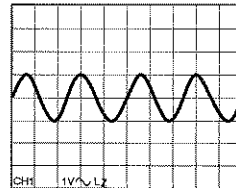
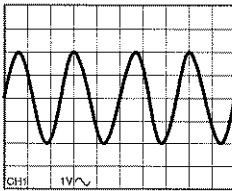

5T8966

Observe that the displayed signal amplitude changes to half of the original amplitude. This is caused by the change of the input impedance to 50Ω, which results in a voltage division between the 50Ω output of the generator and the 50Ω input of the oscilloscope.

- **Remove the input signal from CH1.**

VERTICAL**PROBE RANGE INDICATOR**

- **Connect the probe again**

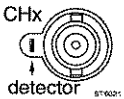

Observe that the 50Ω termination is automatically turned off. The probe is a high-impedance 10:1 attenuator probe. This is recognized by the oscilloscope causing the oscilloscope to switch to the high impedance setting.

At the same time, the sensitivity readout is adjusted automatically when a 10:1 or 100:1 probe is used. This way you don't have to multiply the displayed amplitude by 10 or 100 when you use a Fluke probe with range indication.

VERTICAL

ALT/CHOP

- Connect Channel 1 to the Probe Adjust output via a probe.
- Switch on channel 2 without connecting a signal to it.

The screen displays a square wave (CH1) and a straight line (CH2).

- Press the left (s) side of the MTB key pair until the timebase is 0.1 s.

In CHOP mode the square wave and the line seem to be written simultaneously (three dots moving from left to right). The display is continuously switching very rapidly between the images of CH1 and CH2. This gives the appearance of two uninterrupted displays.

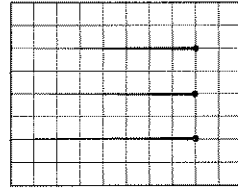
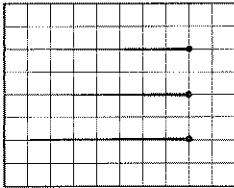

MA14201

- Press the ALT/CHOP key.

In ALT mode you now see that the square wave (two dots moving left to right) alternates with the line (one dot). This illustrates that the CH1 and CH2 traces are not displayed at the same time; they are written on the screen one after the other.

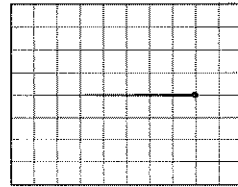
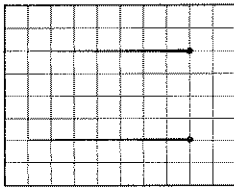

MA14200

When you want to look at time relations of the input signals at slow time base speeds, it is easier to view in CHOP mode, which gives a more stable display (less flicker). At faster time base speeds, the ALT mode is better because the intensity of the signals is higher.

4.4 HORIZONTAL DEFLECTION.

Before starting with the horizontal deflection functions, you must set the instrument to a predefined state to create a correct start situation.

STANDARD SETTING

- Press the **STATUS** and **TEXT OFF** keys simultaneously.
- Connect the **Probe Adjust** signal to channel 1.

The Probe Adjust signal, now supplied to the input, is a square wave with a lower level of 0 V and a top level of 600 mV.

- Press the **AUTOSET** key

HORIZONTAL

TIMEBASE

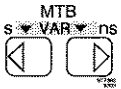

Now 4 periods of the square wave are visible on the screen.

- Press the **'s'** (left) key of the **MTB** key pair several times

The more you press the left ('s') key, the slower the timebase will run. This results in the number of displayed periods of the input signal to increase.

- Press the **'ns'** (right) key of the **MTB** key pair a few times

The number of displayed periods decreases (displayed pulse width gets larger) as the time base speed increases.

Observe that the time base speeds are adjustable in steps following a 1-2-5 sequence.

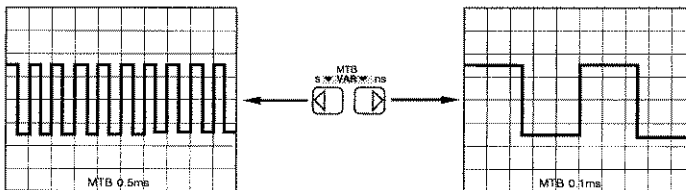

- Set the timebase to **0.2 ms/div**.

The signal is displayed with 4 periods on the screen.

HORIZONTAL

MTB VAR

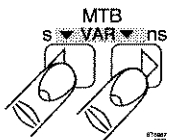

Fine adjustment of time base speeds between the 1-2-5 steps of the can be made by pressing the MTB key pair for MTB VAR. In the VARIable MTB mode the timebase readout gets a higher resolution.

- **Activate the VAR function by pressing the MTB key pair simultaneously.**
- **Press one key of the MTB VAR key pair.**

Observe that the timebase indication is now changing continuously instead of following the 1-2-5 step sequence.

The VAR time base readout values are calibrated values.

This enables accurate timing measurements using VAR timebase settings.

- **Adjust MTB VAR to 850 μ s/div.**
- **Turn off the VAR function by pressing the MTB key pair simultaneously.**

Observe that the timebase is set to the nearest step value (1ms/div).

HORIZONTAL

10 x MAGN



The displayed signal can be expanded horizontally so that more signal detail becomes visible. In the MAGNified mode, all of the signal can be made visible by turning the X POS control.

- **Press the 10 x MAGN key.**

Observe that the timebase indication is changed into 0.1 ms/div.

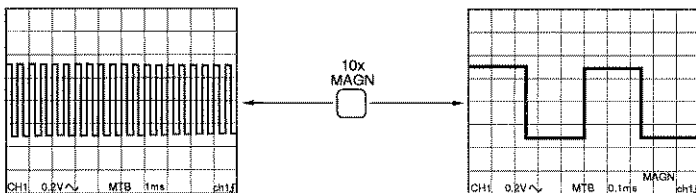

078007

- **Press the 10 x MAGN key to turn off the magnify function.**

HORIZONTAL**X POS**

X POS



With X POS the displayed signal is shifted horizontally across the display.

- Turn the X POS control.

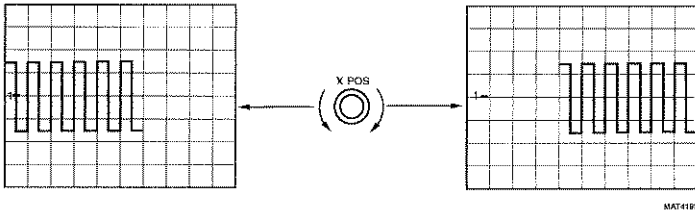

This concludes the section on the use of the Main Time Base (MTB), MAGNifier, and X POSition.

TRIGGERING

- Press the **AUTOSET** key.

TRIGGER

SOURCE

- Press the **TRIG 2** key in the **CH2** section of the front panel.

The indication in the readout area of the screen now displays 'ch2'. Observe that the signal is not triggered. The NOT TRIG'D LED is on.

- Press the **TRIG 1** key in the **CH1** section of the front panel.

Observe that the indication has now changed into 'ch1' and the signal is triggered again.

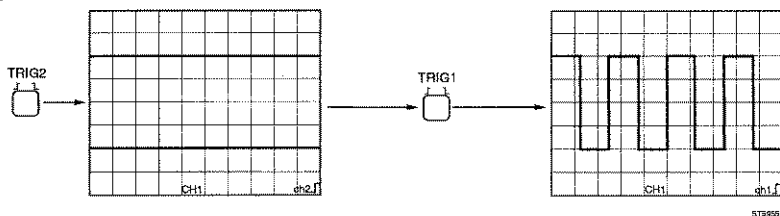

TRIGGER

SLOPE



The same key you used to select the trigger source is also used to toggle the trigger slope.

- Press the **TRIG 1** key in the **CH1** section of the front panel again.

Observe that the signal appears to be inverted now. This is not true: The trigger slope is changed to the negative slope as indicated by the symbol \sphericalangle in the readout area.

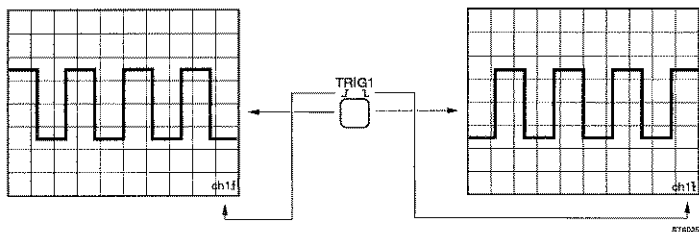

TRIGGER**LEVEL**

LEVEL MTB



After an AUTOSET, the trigger level is always clamped within the signal amplitude range to assure stable triggering. The trigger level is then limited between the minimum (-100%) and the maximum (+100%) of the signal.

- Turn the **LEVEL MTB control**.

In the bottom of the screen the trigger level readout shows the trigger level, relative to the signal amplitude. For example, it may appear as 'Level=+ 14%'.

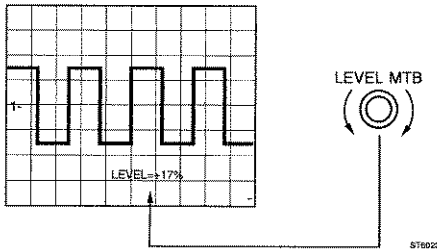

Observe that the primary trigger functions (source, slope and level) have direct access keys. For most day to day applications, menus are not needed.

4.5 ADVANCED HORIZONTAL AND TRIGGER FUNCTIONS.

All basic functions of the oscilloscope are accessible via direct action front panel keys.

More advanced functions are easily accessible via the menus behind the menu initialization keys (keys with a blue bar on the right side).

STANDARD SETTING

Before continuing with the advanced functions, you must set the instrument to a predefined state to ensure a correct start situation.

- **Press STATUS and TEXT OFF simultaneously.**
- **Connect the Probe Adjust signal to channel 1.**
- **Press the AUTOSET key.**

MENUS**TEXT OFF**

The menu functions can be selected by pressing the blue softkeys to the right of the screen.

- **Press the TB MODE key.**

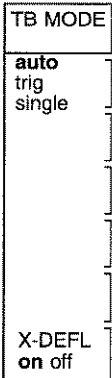

ST6718

Each menu starts with a menu name, which complies with the key that initialized the menu. This is sometimes followed by a second name of a softkey that initialized a sub-menu.

In this menu the top 2 softkeys have an up-down function as indicated with the arrows. They allow you to scroll through a number of functions from which just one can be selected. In this case it allows you to select one of the three timebase modes.

The bottom softkey turns the X-DEFL (X-Y mode) on or off.

You can turn off the text by pressing the TEXT OFF key. This can be done to free up the display area.

- **Press the TEXT OFF key three times.**

Observe that the text mode follows the following sequence: menu off, settings off, both on.

TRIGGER MTB

LEVEL

- Press the **TRIGGER MTB** key.
- Press the 'level-pp' softkey to turn it off and select 'dc' trigger coupling.

Now the trigger level is no longer clamped within the peak-peak range of the signal. You must adjust for the proper trigger level. To help you do this, an 'T-' is displayed in the left hand side of the screen to indicate the trigger level. The trigger level can be positioned anywhere on the screen.

The indicator 'T-' is not displayed when the combination of trigger coupling and input coupling is not usefull.

When the 'T-' is within the signal range, a stable display of the signal is obtained. When this is the case, the NOT TRIG'D LED is off, which means the signal is now triggered correctly.

Use the LEVEL MTB control to move the indicator (T-) vertically over the display.

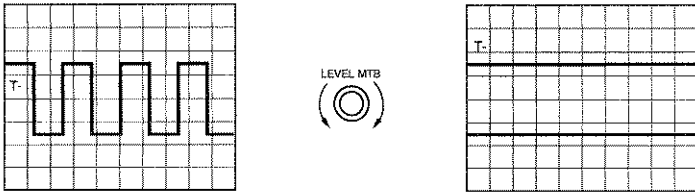

575803

When the trigger level indicator (T-) is outside the signal range only two lines are drawn. The time base is not properly triggered, and the NOT TRIG'D LED is on. So, as long as the Main Time Base is in the Auto mode, there is always a signal visible on the display.

Note: T- is an indicator only and its position can differ slightly from the actual trigger level.

TRIGGER MTB**COMPOSITE**

- Connect a signal of 300 Hz, 4 V to channel 2.
- Turn on channel 2.
- Use the AMPL key pair to adjust channel 2 to 1 V/div.

The signal on channel 2 is not synchronized with the signal on channel 1 from which the trigger is derived. As a result, the signal on channel 2 is unstable and running.

- Press the TRIG 2 key.

Now the channel 2 signal has a stable display, but channel 1 is running.

- Press the softkey next to the function 'ch2 comp line'

When the 'comp' function is selected, the trigger source is said to be in the "composite" mode: The trigger source actually follows the vertical display mode so that when CH1 is going to be displayed, CH1 is selected as trigger source and when CH2 is going to be displayed, CH2 also serves as the source for the trigger signal.

When the scope is in a multiple trace mode (ALT), this function permits the stable display of two or more signals that are not time correlated, or synchronized.

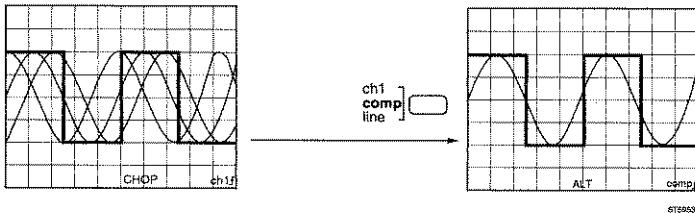

TRIGGER MTB

LINE

- **Turn off channel 1 to only display the sinewave of channel 2.**
- **Select a timebase of 1 ms/div.**
- **Press the softkey next to the function 'ch2 comp line'**

When 'line' is selected, this function is intensified. The line voltage frequency is used as the trigger source.

- **Slowly vary the frequency of the sine wave input signal.**

Observe that whenever the input frequency is close to an integer multiple of the line frequency, the running of the sine wave slows down or even stands still. Line triggering can be used to display signals or signal components that are related to the line frequency (e.g. hum or power supply ripple).

HORIZONTAL MODE**TRIG**

- **Disconnect the signals from all inputs.**
- **Connect the Probe Adjust signal to channel 1.**
- **Press the AUTOSET key.**
- **Press the TRIGGER MTB key**
- **Press the 'level-pp' softkey to turn it off**
- **Press the TB MODE key.**

In the screen, the horizontal mode menu appears, and 'auto' is intensified.

- **Press the softkey next to the 'auto trig single' function.**

The 'trig' function is now intensified. In the 'trig' mode, a signal is visible only when the trigger level is found.

- **Move the indicator (T-) in and out of the signal range.**

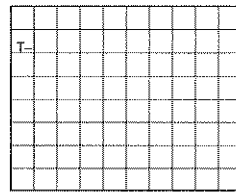
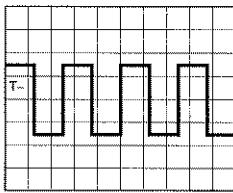

6TS864

The result is a triggered signal when the indicator is inside the signal range, and no signal on the screen when the indicator is outside the signal range. Disabling the auto-restart function by selecting 'trig' can be useful for displaying very low frequency signals.

HORIZONTAL MODE**SINGLE**

- Press the 'auto trig single' softkey again so that 'single' is intensified.
- Set the level indicator (T-) just above the ground level (indicated by 1-).
- Press the SINGLE RESET key.

Each time the SINGLE RESET key is pressed, a single sweep displaying the signal once appears on the screen.

- Remove the probe tip from the Probe Adjust output.
- Press the SINGLE RESET key.

Observe that no signal appears on the screen and the NOT TRIG'D LED is on, indicating that the scope is armed and waiting for a trigger.

- Look at the screen and touch the Probe Adjust output with the probe tip.

Observe that the oscilloscope 'sweeps' once. A signal appears on the screen for a very short instant and the NOT TRIG'D LED is off again. The oscilloscope is no longer armed. (So NOT TRIG'D LED is used for NOT ARMED indication).

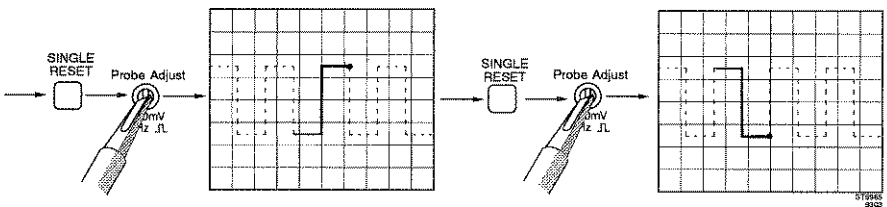

HORIZONTAL MODE

X-DEFL

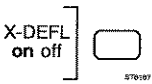

When X-deflection is selected, horizontal deflection is obtained from one of the input signals. The built-in time base generator is turned off. In this mode 'XY' displays are obtained for direct comparisons of two or more signals, one as a function of the other.

Vertical deflection is selected in the same way as for 'normal' displays using the time base. Horizontal deflection is obtained by selecting one of the sources in the TB MODE menu on the screen. This menu appears after X-DEFL has been turned on.

- **Connect the probe on channel 1 to the Probe Adjust socket.**
- **Connect a sine wave of approx 300 Hz to channel 2.**
- **Press the AUTOSET key.**
- **Press the TB MODE key.**
- **Press the X-DEFL softkey so that 'on' is intensified.**

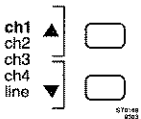

Two vertical lines appear on the screen.

The menu now displays the source for the X-axis intensified ('ch1').

The signal on channel 1 is a square wave. Consequently, there will be only two horizontal positions on the display.

The signal on channel 2 is a sinewave, which is now displayed as a function of the square wave on channel 1. This results in two vertical lines for channel 2 against channel 1.

- **Press the softkey next to the arrow pointing down so that 'ch2' is intensified**

Now two horizontal lines (ch1 against ch2) will be displayed and one diagonal line from bottom left to top right (ch2 against ch2).

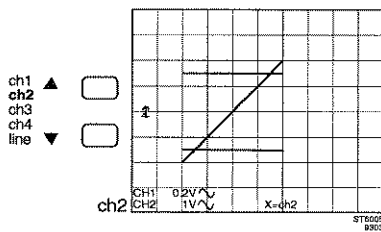
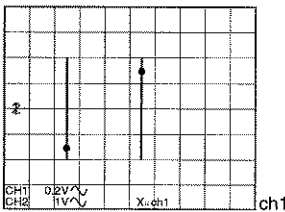

The diagonal line (ch2 against ch2) is the result of XY display of two equal signals without phase shift. Phase shift will result in an elips or even (90° phase) in a circle.

- Press the softkey next to the arrow pointing down so that 'line' is intensified
- Turn off channel 1

Horizontal deflection is now obtained from the line voltage. On the screen channel 2 (sine-wave) is displayed against the line voltage. The signals on the horizontal deflection (line) and the vertical deflection (ch2) have different frequency.

- Variate the frequency of the generator to get an almost stable picture

The displayed figure is called a lissajous figure. This lissajous figure has 5 (60 Hz line) or 6 (50 Hz line) tops depending on the line frequency. The number tops multiplied by the horizontal (line) frequency results in the frequency of the vertical signal.

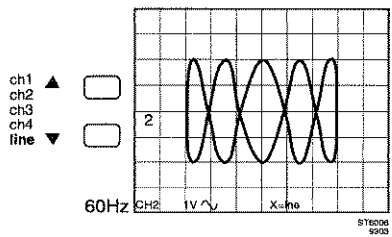
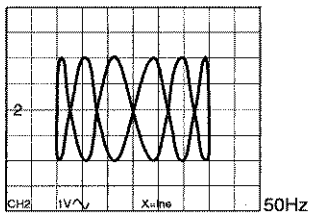

- Disconnect the signals from all the inputs

4.6 DELAYED TIMEBASE.

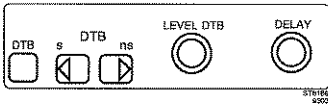

The Delayed Time Base (DTB) has two basic functions:

One is to magnify and look at any detail of the signal displayed with the main timebase.

The other is to permit more accurate timing measurements.

STANDARD SETTING

To start from a predefined state, you must recall the standard front setting.

- **Disconnect the signals from all inputs.**
- **Press the STATUS and TEXT OFF keys simultaneously.**
- **Connect the Probe Adjust signal to channel 1.**
- **Shift the trace to the upper half of the screen as indicated.**

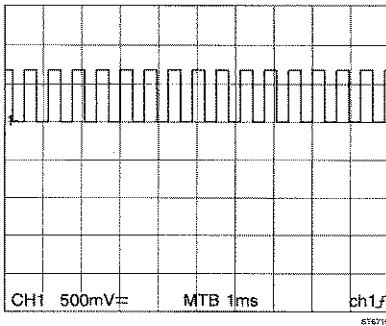

DELAYED TIME BASE

MTB AND DTB

- Press the DTB key to initialise the DTB menu.
- Switch the delayed timebase on using the 'DEL'D TB 'on off' softkey.

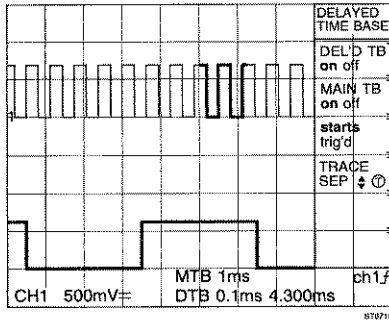

The main timebase trace and delayed timebase trace are displayed simultaneously.

The first trace is the main timebase trace. This first trace shows an intensified part. If it is difficult to see the intensified part, adjust the trace intensity with the TRACE INTENSITY control left of the screen. The second trace is the delayed timebase trace and is an expanded representation of the intensified part of the first trace.

Since all important controls have dedicated keys and controls on the front panel, the menu can be switched off

- Press the TEXT OFF key to switch off the menu.

DELAYED TIMEBASE

DELAY

Use the DELAY control to select the start of intensified part of the signal. The intensified part moves to the left or to the right, depending on which way you turn. This acts like a window over the MTB trace. The DTB trace looks as if it is shifted in the opposite direction.

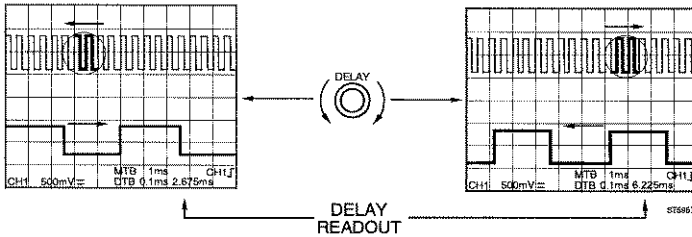

DELAYED TIMEBASE

TIMEBASE

- Press either key of the DTB key pair.

If you press the left key, the intensified part gets larger and more periods of the DTB signal are displayed. If you press the right key, the intensified part gets smaller and fewer periods of the DTB signal are displayed. This way you can select a small area of a signal and look at it with a higher resolution.

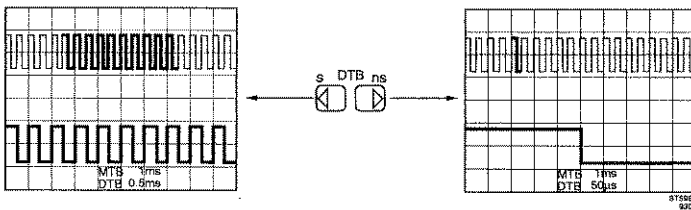

DELAYED TIMEBASE

TRACE SEPARATION

The traces displayed by the MTB and DTB can be separated with TRACE SEPARATION.

- Press the up softkey to select MAIN TB on and DEL'D TB on.
- Press either key of the TRACE SEPARATION key pair.

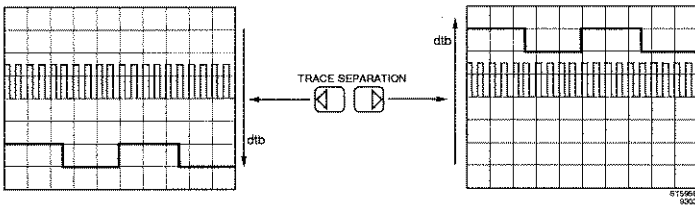

NOTE: There is a second way to operate the trace separation. If the DELAYED TIMEBASE menu is activated you will see the 'T' symbol next to the TRACE SEP text. The 'T' indicates that the cursor TRACK control can be used to adjust the trace separation.

DELAYED TIMEBASE**TRIGGER**

Using the Delayed Time Base (DTB) to select and display a small portion of the Main Time Base display results in a magnification of the intensified part. Depending on the ration between the MTB and DTB settings, this magnification can be very significant.

If the input signal contains jitter or any other form of timing instability, then this jitter will be magnified in the same ratio. This can be so much, that the display becomes unusable. To address such a problem, the Delayed Time Base (DTB) can be made to trigger on the input signal after the delay time has passed.

To avoid confusion we will begin again with the STANDARD SETUP.

- Press the **STATUS** and **TEXT OFF** keys simultaneously to recall the **STANDARD SETUP**.
- Shift the trace to the center upper half of the screen.
- Initialize the **DELAYED TIMEBASE (DTB)** menu
- Press the **DEL'D TB** on off key to turn on the delayed timebase.

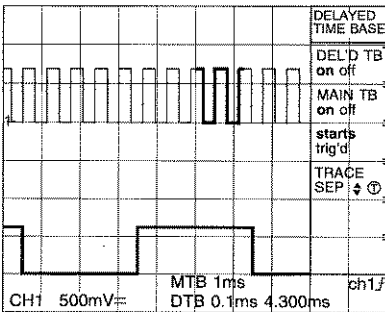

In the menu you will find a 'starts/trig'd' softkey. Starts is highlighted indicating that the delayed timebase is operating in the starts mode instead of the triggered mode.

For most signals, 'starts' can be used. This means that the dtb is started immediately after the delay time.

- Press the starts/trig'd softkey to select the trig'd mode.

When a trigger source is selected for the DTB, the start of the DTB is postponed until the first trigger occurs after the delay time. The occurrence of a valid trigger also depends on the proper setting of the trigger source, slope and level. The delayed timebase trigger source and slope can be selected with the same TRIG1, TRIG2, TRIG3 and TRIG4 pushbuttons as used for main timebase triggering. So when the DELAYED TIMEBASE is active, operation is similar to that for the main timebase source and slope. The delayed timebase trigger readout is located in the lower right corner of the screen just under the main timebase trigger readout.

- Press the TRIG1 key in the CH1 section a few times and observe what happens.

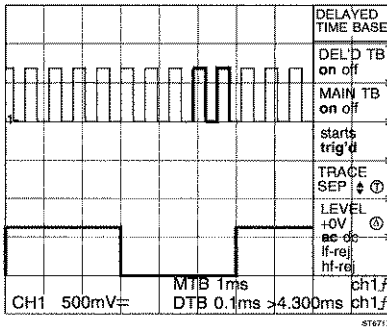

DELAYED TIMEBASE**LEVEL DTB**

Just as is the case for Main Time Base triggering, proper triggering of the Delayed Time Base depends on the selection of the proper trigger level. A separate control LEVEL DTB is provided for this function.

NOTE: The Δ symbol in the menu indicates that the Δ cursor control can also be used to adjust the DTB trigger level.

If the channel and trigger coupling are the same (which is presently the case, since both couplings are set to ac), a trigger level indicator is visible (D-).

If you have set up for triggered operation of the DTB, as described in the previous section, and the DTB trace is not displayed, you have to adjust the LEVEL DTB control until the DTB signal is visible.

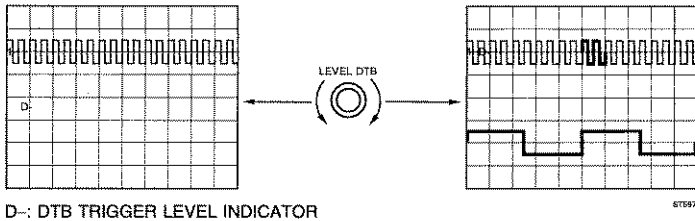
**DELAYED TIMEBASE****COUPLING**

The DTB permits the same trigger coupling selection as for the MTB (ac, dc, lf-rej, hf-rej.). The level indication 'D-' (for DTB) is only present when the combination of the dtb trigger coupling and the input coupling is useful.

4.7 CURSOR FUNCTIONS

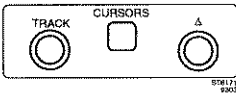

Cursors are provided to make fast and accurate amplitude and time measurements.

STANDARD SETTING

Before beginning to use the cursor functions, the instrument must be set to a predefined setting. The following steps must be performed.

- **Disconnect the signals from all inputs.**
- **Press the STATUS and TEXT OFF keys simultaneously.**
- **Connect the Probe Adjust signal to channel 1.**
- **Press the AUTOSET key.**

CURSORS

ON/OFF

There are two sets of cursors. Voltage cursors are two horizontal lines and Time cursors are two vertical lines. The dashed lines are referred to as Reference cursors and the dotted lines are referred to as Delta cursors. Volt and Time cursors can be displayed at the same time.

- **Press the CURSORS key.**
- **Now the cursor menu is activated and the cursors are switched on.**

The cursors normally return to the screen in the state they were before they were turned off. However, after a standard setting has been recalled, time cursors ('II') are selected by default and they are set to predefined positions.

CURSORS**TIME**

When 'on' is selected, you can adjust the position of the cursors. Measurement readouts related to the time cursors are selected via the 'READOUT' softkey.

- Turn the **TRACK** control and observe that both cursors move.
- Turn the **Delta (Δ)** control and observe that only the Delta cursor moves.

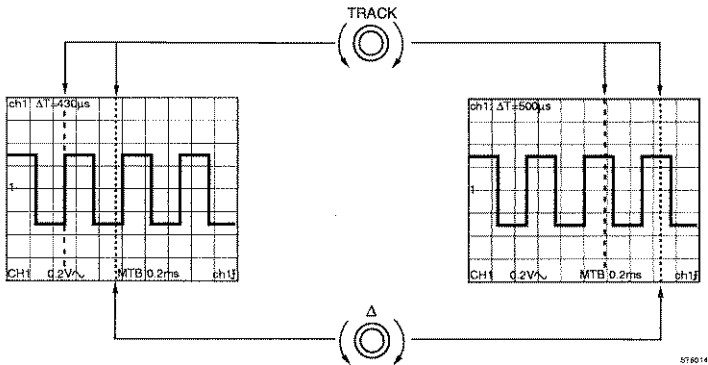

At the top of the screen, the time distance between (ΔT) is displayed. This is used for timing measurements.

CURSORS TIME

READOUT

- Press the softkey next to 'READOUT'.

The measurement readout selection menu is now displayed. The following alternatives for ΔT measurement results can be selected from this menu.

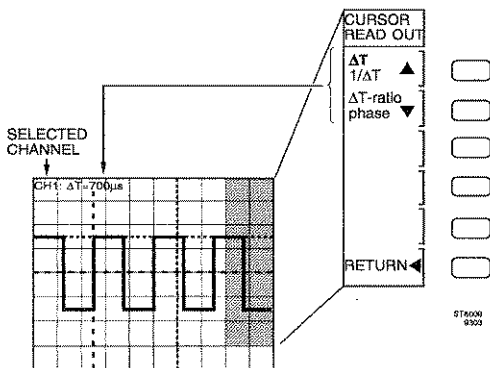

ΔT is the time difference between the time cursors. The readout is in seconds (s), or fractions thereof.

$1/\Delta T$ results in the inverted value of the time difference, and is displayed in Hz. When the time cursors are set exactly one period apart this represents the frequency of the signal.

ΔT -ratio allows for a relative measurement of two cursor readings. It is displayed as a percentage.

First, the reference distance between the two cursors is set. This then is set to 100 % by pressing the $\Delta T=100\%$ softkey. Changing the distance between the cursors now results in a % reading of the reference.

- Press the softkey next to ΔT until ΔT -ratio is intensified.
- Set the time cursors to one signal period apart.
- Press the softkey next to $\Delta T=100\%$.

In the cursor readout line of the screen, the value for ΔT is now ' $\Delta T=100\%$ '

Observe that the 100% reference does not change when the TRACK control is rotated.

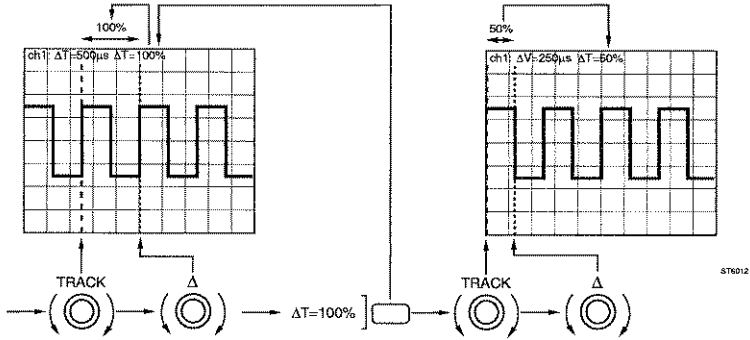

ST6012

- **Adjust the cursors to a distance of half a signal period.**

Now the ΔT in the readout area will read ' $\Delta T= 50\%$ '

This is the way to use the cursors for duty cycle measurements.

Phase is used to measure a phase difference between two signals, or to determine the phase of a detail within one signal.

Phase is measured in a way similar to the ΔT -ratio measurement. At first, the 360° must be defined, followed by the phase measurement by re-positioning the distance between the cursors.

- **Set the cursors to one signal period.**
- **Press the softkey next to ' $\Delta T=360^\circ$ '**

Observe that when the TRACK control is rotated, the phase readout is not changing.

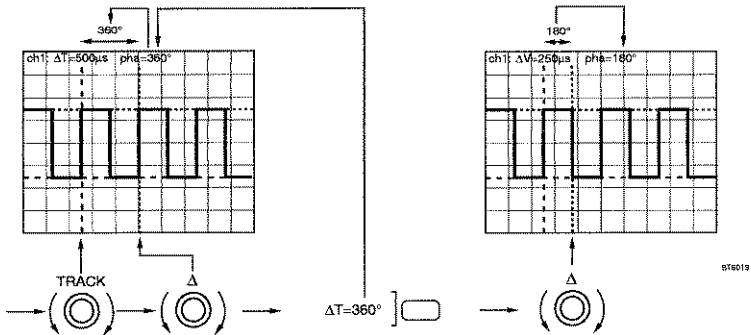

- **Readjust the distance between the cursors to half a period.**

The Phase readout will now read 'pha= 180°', which is equivalent with half a period.

- **Press the RETURN softkey to return to the cursor main menu.**

CURSORS

VOLT

- Use the softkeys, to select the voltage cursors ('=' intensified).

Two voltage cursors will appear in the display.

The menu permits the channel to be selected for which the voltage cursors apply.

When channel 1 is the only channel displayed, 'ch1' is the only selection visible.

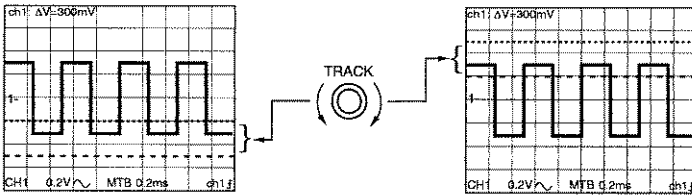

876014

- Turn the TRACK control and observe that both cursors move in the same direction.
- Turn the Delta (Δ) control and observe that only the Delta cursor moves.

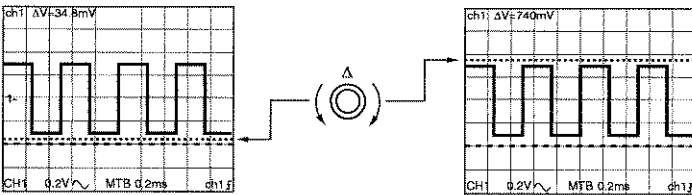

876016

CURSORS VOLT

READOUT

- Press the **READOUT** softkey.

The Voltage measurement readout selection menu is now displayed. You can select the following alternatives for the ΔV readout.

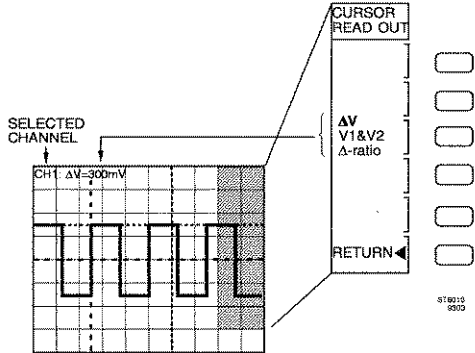

ΔV is the voltage difference between the voltage cursors (readout: $\Delta V=...V$).

V1&V2 displays the absolute voltages for each voltage cursor in relation to ground (readout: $V_{reference}...0V, V_{delta}...0V$).

ΔV -ratio allows for a relative measurement of two cursor readings. It is displayed as a percentage.

First, the reference distance between the two cursors is set. This then is set to 100 % by pressing the $\Delta V=100\%$ softkey. Changing the distance between the cursors now results in a % reading of the reference.

- Press the softkey next to ΔV so that ΔV -ratio is intensified.
- Position the cursors at the minimum and maximum of the signal.
- Press the softkey next to $\Delta V=100\%$.

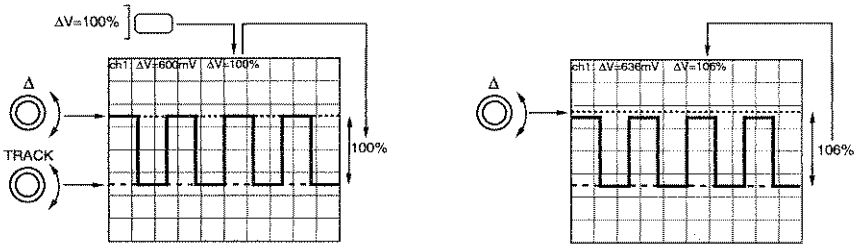

- **Set the Delta cursor a little higher than the signal**

Observe that $\Delta V=100\%$ changes to $\Delta V=106\%$.

This mode can be used for measuring signal overshoot, or modulation depth of an Amplitude Modulated (AM) signal.

- **Press the RETURN softkey to return to the cursor main menu.**

CURSORS

VOLT & TIME

Voltage and Timing cursors can be displayed at the same time. When both time and voltage cursors are displayed, you have to select which cursors are affected by the TRACK and Δ controls. This selection is made by toggling the softkey 'CONTROL'.

Channel selection only applies to the Voltage cursors. The Time cursor always apply to all channels.

To use both types of cursors at the same time :

- **Press the softkey next to '= || #' so that '#' is intensified.**
- **Press the CONTROL softkey so that '=' is intensified.**
- **Turn the TRACK control and observe that only the voltage cursors move.**
- **Press the CONTROL softkey so that '||' is intensified.**
- **Turn the TRACK control and observe that only the time cursors move.**

CURSORS VOLT & TIME

READOUT

- Press the READOUT softkey.

When both types of cursors are displayed, the readout menu is equal to the sum of the two separate menus described before. The displayed results at the top of the screen follow the measurements that have been selected with the softkeys.

The reference selection can be displayed as:

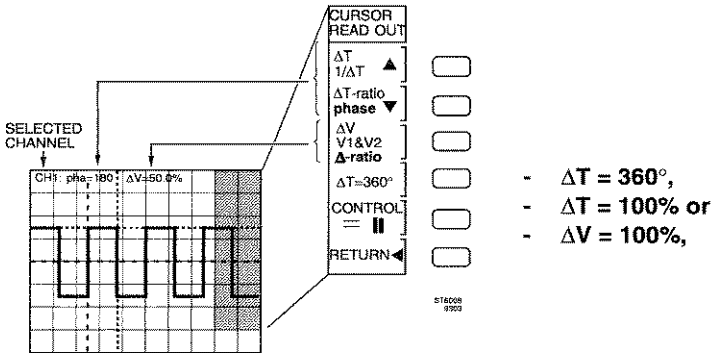

depending on the selection of READOUT and CONTROL

The CONTROL selection is the same as in the main menu.

CURSORS**Vpp**

- Remove the probe from Ch1.
- Connect a sine wave of 300 Hz, 3 V to Ch1.
- Press the **AUTOSET** key.
- Press the **CURSORS** key.
- Press the 'off on Vpp' softkey so that 'Vpp' is intensified.

When Vpp is selected, the voltage cursors are automatically set to the minimum and maximum signal level for immediate and fully automated peak-peak Voltage measurements.

In the bottom of the menu, ' ΔV_{pp} ' is displayed and intensified. The peak-peak value ($V_{pp}=3.00V$) is displayed in the cursor readout line at the top of the screen .

- Press the softkey next to 'Vpp Vp-&Vp+' so that 'Vp-&Vp+' is intensified.

When you select 'Vp-&Vp+' at the bottom of the menu, the absolute values of the cursor positions with respect to ground are displayed in the cursor readout line ($V=V_{reference}...0V$, $V_{\Delta}...0V$).

- Press the softkey 'Vpp Vp-&Vp+ Vdc' so that Vdc is intensified.

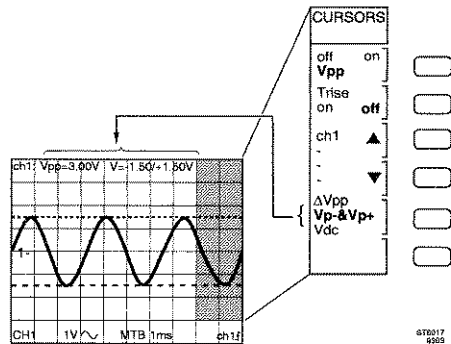

Vdc results in the average value of Vp- and Vp+ being displayed in

the top of the screen. This mode can be used to measure dc components of symmetrical signals and to measure real dc signals.

- Press the softkey next to **Trise** to turn the function on.

When 'Trise' is turned on, the time cursors appear on the screen.

The voltage cursors are automatically set to 10-90% or 20-80%. This depends on which has been selected at the bottom of the menu by softkey.

The rise time can be measured by positioning the time cursors on the intersections of the signal and the voltage cursors.

- Position the time cursors.

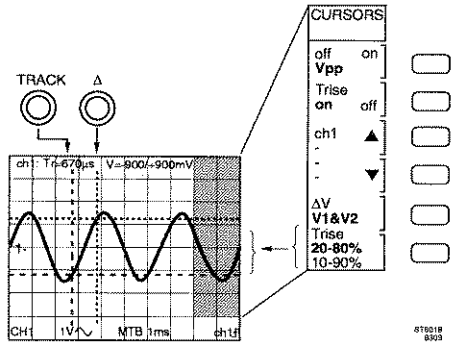

The risetime is now displayed in the top line on the screen as 'Tr=...ms'.
 When 'ΔV' is selected, 'ΔV=...V 20-80%' is displayed at the same time.
 When 'V1 & V2' is selected, 'V=-.../+...V' is displayed.

CURSORS

X-DEFL

When the X-DEFL (XY) mode is selected, the cursors react the same and are selected in the same way as for normal timebase operation.
 The 'Vpp' and READOUT selections are not available.

The readouts of the cursor differences (ΔX and ΔY) are both voltages.

4.8 AUTOSET AND SET-UP UTILITIES

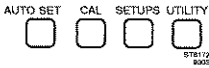

This oscilloscope has a number of utilities that assist you to quickly get to the set-up you need.

One utility is the SET STANDARD utility.

The most frequently used utility will be AUTOSET. AUTOSET is user programmable as outlined below.

SET STANDARD

- Press the STATUS and TEXT OFF keys simultaneously.

The standard setting feature resets all functions to a predefined state. At this time it must be used to ensure that standard setup condition apply before proceeding. SET STANDARD also resets the autoset function to the standard autoset condition.

AUTOSET

STANDARD

AUTO SET



The AUTOSET function automatically sets all relevant functions of the oscilloscope as they apply to the input signal. This includes the selection of channels, input sensitivity, time base setting, trigger source, trigger slope and trigger level for an optimum trace.

- Connect the Probe Adjust output to channel 1.
- Press the AUTOSET key.

The result is a stable display with a number of signal periods. The amplitude is well within the display range. In this example the Probe Adjust signal is displayed with four periods on the screen and an amplitude of three divisions. This operating mode is referred to as AUTOSET after the SET STANDARD.

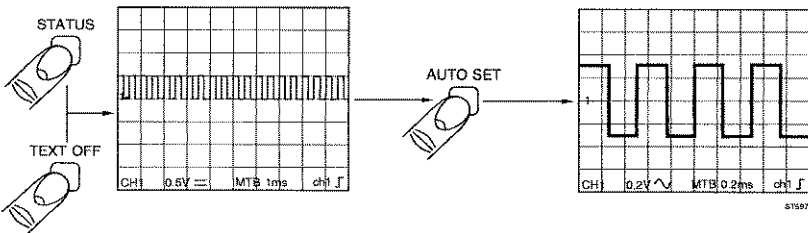

AUTOSET**USER PROGRAMMABLE**

The AUTOSET function can also be programmed so that certain functions switch to a predefined position after an AUTOSET.

USERPROG allows the user to customize the AUTOSET function for applications.

Example: To program the AUTOSET function for dc coupling of the inputs :

- **Press the UTILITY key.**
- **Press the softkey to select AUTOSET and then press 'userprog'.**
- **Press the 'VERT >' softkey, select 'dc' and press RETURN.**
- **Press the AUTOSET key.**

The Probe Adjust signal is now displayed as dc coupled, instead of ac coupled as would be the case after a STANDARD AUTOSET.

SETUPS

SETUPS

The complete setting of all the functions at this moment is called a front.

The SETUPS key is used to store and recall previously defined instrument settings. This is very useful for the frequent use of routine measurements.

Example: Set the attenuator to 0.5 V/div, and set the time base to 0.5 ms/div.

- **Position the trace in the bottom of the screen.**

This front can be saved in memory as follows:

- **Press the SETUPS key.**
- **Press CLEAR & PROTECT.**
- **Press the softkeys 'clear all' and yes.**
(This clears all previously stored front settings).
- **Rotate the TRACK control until memory location 's7' is selected.**

- Press the softkey next to 'save'.

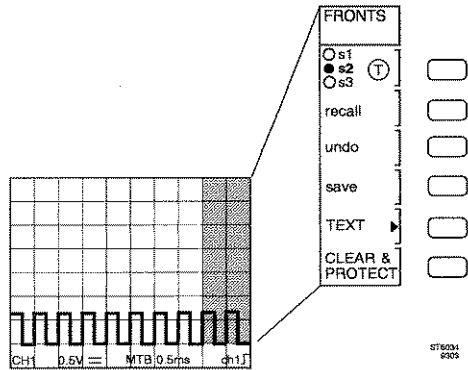
576031
©2002

The actual setting of the front is now stored in memory location 's7'. The indication in front of memory location 's7' changes from 'o' to '●'.
To recall a previously stored setting :

- Press **AUTOSET** key.

The signal is displayed again with an amplitude of three divisions and with four periods above the center line.

- Press the **SETUPS** key.
- Use the **TRACK** control to select the same front number 's7' as in the previous example.
- Press the softkey next to 'recall'.

If you wish, you can tag each front with a user text label. This is done in the **TEXT** submenu. Operation is similar to that for **USERTEXT**.

The stored settings are recalled and the trace is displayed in the same way as when the setup was stored.

A **STANDARD SETUP** can be recalled at any time by pressing the **STATUS** and **TEXT OFF** keys simultaneously. This setup is also available in the **SETUPS** selection menu.

RECALL OF A SEQUENCE OF FRONT PANEL SETTINGS

If, for instance, front panel settings are stored in the memory locations s1 to s5 while s6 is cleared, then s1 to s5 are recalled in sequence. This sequence can be used as a step by step testing procedure in manufacturing. It is also possible to step through such a sequence without using menus in the following two ways:

1. By programming the AUTOSSET key to be used as the 'recall next set up' key. This selection can be done via the key sequence UTILITY >> AUTOSSET >> setups.
2. By using a special probe with a 'probe command switch'. This mode can be selected via the key sequence UTILITY >> PROBE >> setups.

To return to the 'normal' oscilloscope mode recall the STANDARD SETUP by pressing the STATUS and TEXT OFF keys simultaneously.

AUTOCAL

The AUTOCAL function is used for fine adjustment of the oscilloscope's input, trigger, and timebase circuitry. This allows you to achieve the high accuracies specified for this instrument, even under extreme environmental conditions like very high or very low temperatures.

When the oscilloscope is always kept under the same environmental conditions (e.g. in a workshop or lab.), it is sufficient to perform this AUTOCAL once every month.

It is recommended to perform an AUTOCAL after the instrument has warmed up. To perform an AUTOCAL :

- **Press the CAL key for at least 2 seconds.**

The calibration is fully automatic and takes about 1 minute.

For purposes of full traceability, an official calibration in a fully equipped and traceable calibration laboratory should be done once a year or after every 2000 hours of use.

OTHER FEATURES

You are now an experienced user of this Fluke oscilloscope.

There are some additional features that were not covered by this step by step introduction.

- TV trigger modes
- Trigger filters
- User text
- Intensity ratio
- Probe correction
- Beep and click signals
- Noisy signal triggering
- Confidence check

Most of these functions can be operated via the UTILITY menu.

For further information on all of these features, refer to the cross reference index and chapter 5. This chapter describes all oscilloscope functions in alphabetical order.

This oscilloscope has been designed to give you many years of dependable service. We are sure that you will feel confident with your Fluke oscilloscope.

Fluke is in the process of constantly improving products and documentation. For any problems or suggestions, please contact the Fluke Service Center nearest you.

A complete listing of addresses for the Fluke T&M equipment Service Centers can be found in the Reference manual.

5 FUNCTION REFERENCE

This chapter contains an alphabetized description of each oscilloscope function. For easy reference, the functions are organized in the following order:

1. The Function description

Explanation and detailed information about the function.

2. Key sequence

Tells the operator which keys/controls to use to select the desired function. The first key/control mentioned is always one of the front panel menu selection keys, and the other keys are the softkeys.

3. Remote commands

Gives information about the command to be programmed for the operation of the relevant function via a remote control interface. For more detailed programming information, see appendix E.

Note 1: Finding your way through the menus.

Some functions are attained via successive steps through a tree structure of menus. An example is how to activate the key CLICK function:

- Press the UTILITY menu key.
- Press the SCREEN & SOUND softkey.
- Press the SOUND softkey.
- Press the CLICK softkey to activate 'on'.

The shortform annotation for these steps is 'UTILITY >> SCREEN & SOUND >> SOUND >> CLICK on'.

Note 2: A complete function index is part of this Operating Manual. This function index contains all function names and reference words in alphabetical order including the relevant chapter and page number where more detailed information can be found.

ADD INVERT SUBTRACT

Description:

The CH1 + CH2 and the CH3 + CH4 keys in the control sections for CH1 and CH3 can be used to display additional traces of the sums of these channels.

The invert keys (INV) in the control sections for CH2 and CH4 can be used for signal inversion.

A differential mode is provided by adding CH1 and 'Inv' CH2 together. The same mode is available for CH3 and CH4 so that a dual-trace differential mode is obtained.

Suppression of common mode components in two signals using the differential mode.

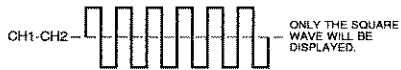
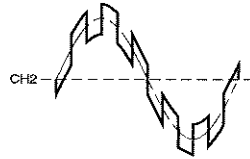
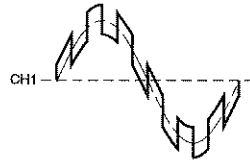

MAT1202

Key sequence:

CH... + CH...



Toggle key to switch the addition of CH1 and CH2 or CH3 and CH4 on/off

INV



Toggle key to switch the inverted display of CH2 or CH4 on/off

ALT/CHOP

Description:

When two or more channels are selected, the oscilloscope can work in either of two modes. When Alternated or Chopped, use the ALT/CHOP key to select the mode. ALT/CHOP selection not available with single trace display.

Alternate mode: The traces are displayed one after another. For fast timebase speeds the mode assures maximum intensity. For slow timebase speeds, alternate is less suitable because it results in a flickering display.

Chopped mode: This mode is recommended for slow timebase speeds (typically 1 ms/div or lower). The display switches rapidly between the channels. The result is that it looks as if the channels are displayed simultaneously.

The Alternate and Chopped modes are shown in the figure below.

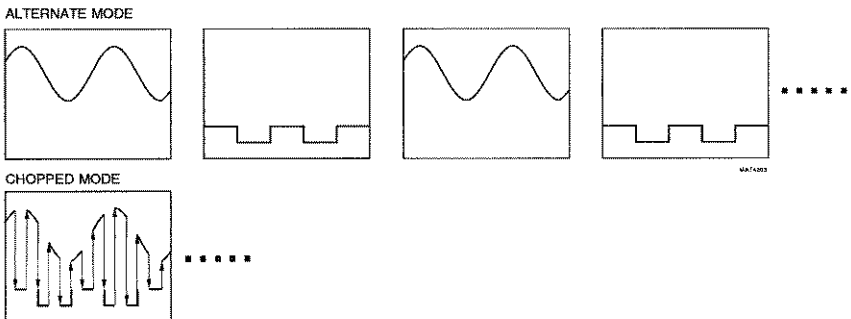

Alternate and chopped display of two traces

Key sequence:

ALT/CHOP



Toggle key to select the ALTErnated or CHOPped mode

AUTOSET

Description:

The AUTOSET function sets the oscilloscope so that an optimum display of the input signals is obtained. Operating the AUTOSET key results in:

- Channels with an input signal are switched on; others are switched off.
- Input coupling is set to ac; because of this autosest does not function at very low signal frequencies.
- Input impedance is set to 1 M Ω .
- Input attenuator settings are optimized; VAR function off.
- Bandwidth limiter and INVert are switched off.
- ALT or CHOP mode selected to most optimal display.
- Vertical POS selection in center screen.
- Edge triggering on positive slope is activated.
- Trigger source is the channel with the lowest frequency; at equal frequency the lower channel number is selected.
- Trigger coupling is set to ac and level-pp on.
- Horizontal mode is switched to MTB only.
- Cursors and usertext are switched off; settings display is switched on.

These settings are suitable for most signal conditions. You can also customize AUTOSET to your own application or preference. For information about AUTOSET programming, refer to AUTOSET USERPROG on the next page.

Key sequence:

AUTOSET



Key to start the autosest

Remote commands:

CPL: AS (Refer to appendix E for full details)

AUTOSET USERPROG

Description:

A number of instrument settings after AUTOSET can be customized to your special needs when the standard default settings do not fit on your application.

The selections are reached via the key sequence 'UTILITY >> AUTOSET >> userprog'. This gives access to VERT, TRIG and PROBE & SCALE submenus where the selections are made. The following table shows possible selections. Unaffected means that existing selections are not overruled by AUTOSET.

Description	Standard AUTOSET	Userprog alternatives	Menu UTILITY>>AUTOSET >>userprog>> ..
Channel selection	volt/div, on/off	unaffected	VERT
Input coupling	ac	dc, unaffected	VERT
Input impedance (*)	1 MΩ	50 Ω, unaffected	VERT
Bandwidth limiter	off	on, unaffected	VERT
Triggering	edge, ac, level-pp on, auto, LEVEL MTB center	unaffected	TRIG
Probe	manual probe selection set to 1:1	unaffected manual probe selections	PROBE

(*) : only in PM3092 and PM3094

Key sequence:

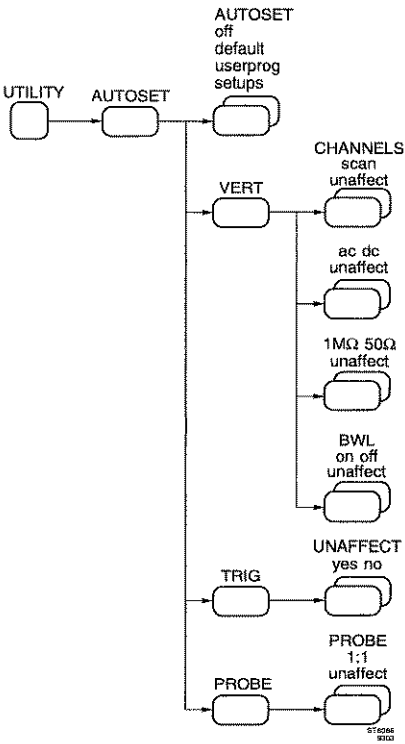

Toggle softkey to activate userprog

Toggle softkey to preset channels on/off and input attenuator after AUTOSET.

Toggle softkey to preset input coupling after AUTOSET

Toggle softkey to preset input impedance after AUTOSET. (only in PM3094 and PM3092)

Toggle softkey to preset reaction of bandwidth limiter after AUTOSET.

Toggle softkey to preset trigger settings after AUTOSET.

Toggle softkey to preset probe attenuation factor (for probes without indication ring) after AUTOSET.

Remote commands:

CPL: AS (Refer to appendix E for full details)

BANDWIDTH LIMITER

Description:

The bandwidth limiter cuts the vertical bandwidth of all vertical channels to 20 MHz and makes noisy input signals look smoother. The bandwidth limiter does not affect triggering. The following figure shows the effect of the bandwidth limiter.

Effect of bandwidth limiter

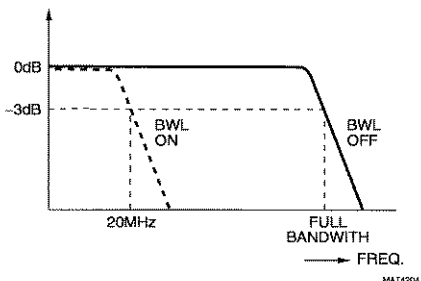

Key sequence:

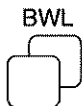

Toggle key to switch the vertical bandwidth limiter on/off

CALIBRATION AUTOCAL

Description:

The CAL key is used to make a fine adjustment of the oscilloscope's input, trigger, and timebase circuitry to achieve high accuracy even under extreme environmental conditions such as very high or very low temperatures. In a workshop or laboratory environment, a fine adjustment once a week or even every month is sufficient.

It is recommended that you do the fine adjustment after the instrument has warmed up. For a complete calibration (advised once a year or every 2000 service hours), a special submenu is available in the maintenance menu. Calibration data are protected by a keyword and a seal. Calibration should be done by qualified personnel only. For details, refer to the chapter 'Calibration Adjustment Procedure' in the service manual.

Attention: Calibration autocal data disappears after having removed back up batteries while the oscilloscope is not powered by line.

Key sequence:

CAL



Key to start the fine adjustment procedure. Press this key for at least 2 seconds to start the procedure.

Remote commands:

CPL: CL (Refer to appendix E for full details)

CONFIDENCE CHECK

Description:

After turning the oscilloscope on, a confidence check starts automatically. The following is tested in sequence:

- The instrument's internal control bus.
- The communication between front panel and internal microprocessor.
- The settings in the memory (with backup batteries installed only).

The selftest takes less than a second. A message appears on the screen when errors are found.

The settings stored in memory become active with backup batteries installed. These are the same settings present when the instrument was last switched off. With no batteries present, the standard default setting 'std' is activated. Refer to STANDARD FRONT for details.

Key sequence:

POWER ON OFF



Toggle key to switch the oscilloscope on/off. Starts confidence check

CURSORS

Description:

Cursors are on-screen sets of measuring lines. They can be moved using the TRACK and Δ controls. Cursors can be positioned on signal details of interest and can be used for accurate measurements.

Basically there are two types of cursors: vertical lines (||) called time cursors and horizontal lines (=) called volt cursors. A simultaneous display of both cursor types (#) is possible.

The readout of the delta between the cursor lines is shown in the cursor display area (upper part of the CRT viewing area). The display can be in voltage or time. In this way cursors can be used for accurate on-screen measurements without using the graticule. Additional readout information can be selected under the READOUT softkey. For details see the CURSOR READOUT function.

The cursors are activated via the menus under the CURSORS menu key. The structure of the menus is shown in Appendix A and B. The menu structure when X-DEFL is 'on' is given under function CURSORS X-DEFLECTION.

Activating the cursors is done with softkey 'off on Vpp'. In the Vpp mode, the volt cursors automatically locate the top and bottom of the signal. For details see the CURSOR MODE Vpp function.

CURSORS

TIME

The time cursors are used for time measurements. The example shows the required softkey settings for period measurements. The cursor positioning with the TRACK and Δ controls is also shown.

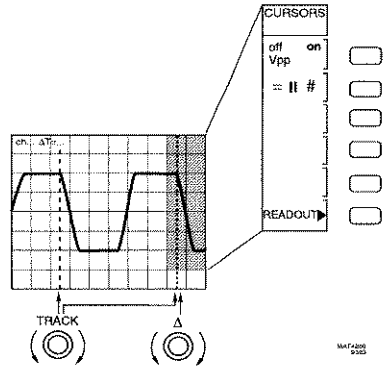

CURSORS

VOLT

The volt cursors are used for voltage measurements. When more than one channel is on, the desired channel for voltage readout must be selected with the ch1 ... ch4 pair of softkeys. The figure shows the required settings. The cursor positioning with the TRACK and Δ controls is also shown. The example shows how peak-peak voltage measurement is done.

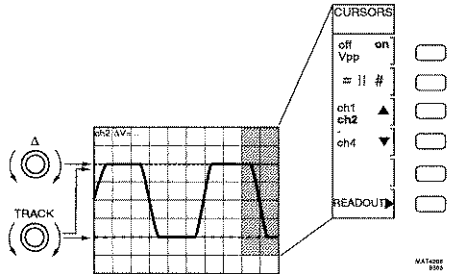

CURSORS

BOTH

In this mode, both voltage and time cursors are active. The TRACK and Δ controls operate as in VOLT or TIME mode, as selected with the CONTROL key.

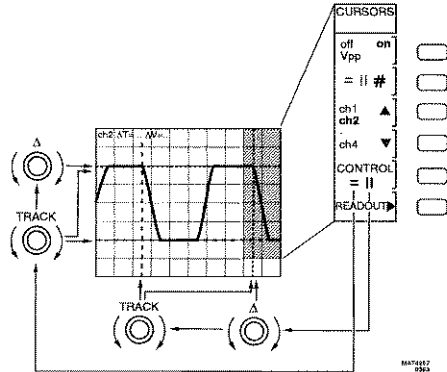

Key sequence:

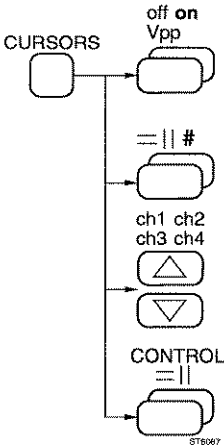

Toggle function softkey to switch between cursors on, off or Vpp mode.

Toggle function softkey to switch between volt, time or both cursors.

Softkey pair to select CH1, CH2, CH3, CH4 for voltage measurements. This selection is possible only for VOLT cursors.

Toggle function softkey to switch between volt and time cursors for positioning. This selection is usable only in the 'both' cursor mode.

TRACK



Control to shift both cursors simultaneously.

Δ



Control to shift the Δ cursor.

Remote commands:

CPL: QM (command to query measured values)

Refer to appendix E for full details.

CURSOR MODE Vpp

Description:

In the Vpp mode the cursors are automatically positioned at the top and bottom of the signal for fully automatic peak-peak measurements. The figure shows the required settings. The selection menu is reached via the CURSORS menu key. When more than one channel is on, the desired channel must be selected with the softkeys ch1 ... ch4. The TRACK and Δ controls are deactivated. The volt peak-peak value is indicated in the readout area. Refer to the CURSOR READOUT function for more information concerning readout data. Cursor mode Vpp does not function in 2 and 5 mV/div.

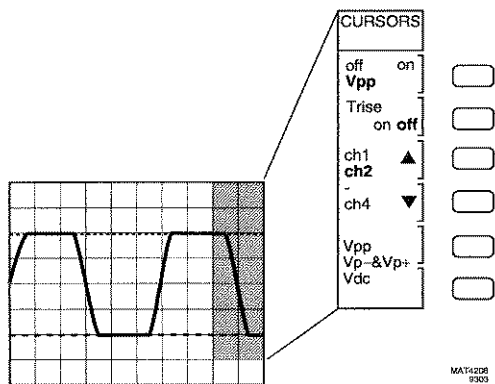

Risetime (Trise) measurements are easily made using the Vpp mode. The measurement assumes that the bottom and top of the signal are 0 and 100%. Trise 'on' in the CURSORS menu activates the function. The volt cursors move towards the risetime levels selected by the user. These levels are selectable between 20% and 80% or 10% and 90%. The time cursors must be positioned with TRACK and Δ as shown in the figure. The delta between the time cursors is the risetime and can be read in the cursor readout area.

Note: it is not possible to combine Vpp cursor mode with DTB.

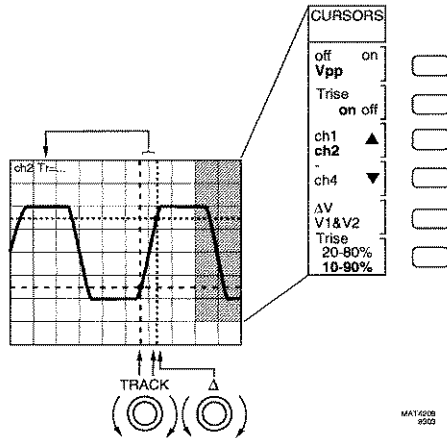

Key sequence:

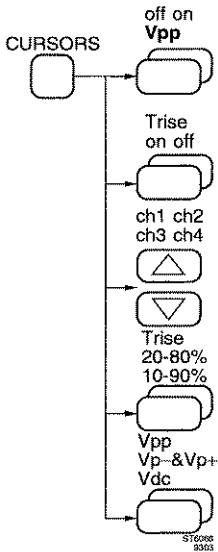

Toggle function softkey to switch cursors on and CURSORS off or to select the Vpp mode.

Toggle function softkey to activate the risetime measurement.

Softkey pair to select CH1, CH2, CH3, CH4 for voltage measurements. This selection is possible only for VOLT cursors.

Toggle function softkey to switch between 20-80% or 10-90% based risetime measurements.

Key to select the readout mode:

- Vpp = V peak to peak
- Vp-&Vp+ = Vmin peak and Vmax peak
- Vdc = average value of max and min peak

The average value of the measured maximum and minimum peak is displayed in the Vdc mode. This readout mode can be used to measure dc components of symmetrical signals and true dc signals.

CURSOR READOUT

Description:

The cursors offer a wide variety of voltage and time readouts. For comparison of signal details the ratio mode is very suitable. The time cursor readout can be set to phase and frequency. The various readout selections for time, volt and 'both' are reached via the key sequence 'CURSORS >> READOUT'.

CURSOR READOUT

TIME

Four time interval readouts can be selected:

- ΔT : Gives the time between the cursors.
- $1/\Delta T$: This results is a frequency readout. The readout is correct when the distance between the cursors equals one signal period.
- ΔT -ratio: The readout is a percentage that can be reset by using the ' $\Delta T=100\%$ ' softkey. This mode can be used for time comparisons. The figure shows an example of a duty cycle measurement. First the cursors are positioned at the period and the readout is set to 100%. Then the pulse width is measured.
- Phase: The readout is a number of degrees that can be reset using the ' $\Delta T=360^\circ$ ' softkey.

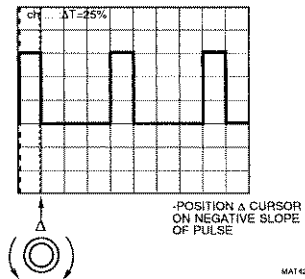
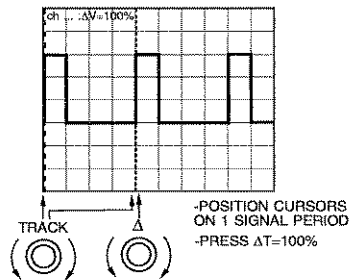

CURSOR READOUT

VOLT

Three readouts can be selected:

- ΔV : Gives the voltage difference between the cursors.
- V1&V2: Gives the absolute voltage with respect to ground for each cursor.
- ΔV -ratio: The readout is a percentage that can be reset using the ' $\Delta=100\%$ ' softkey. This can be used for amplitude comparisons. The figure shows an example: the percentage of overshoot compared with 100% pulse amplitude is determined.

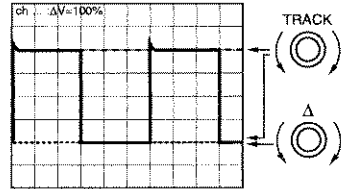

-POSITION CURSORS ON TOP/BOTTOM OF SIGNAL
-PRESS $\Delta V=100\%$

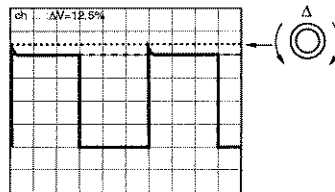

-POSITION Δ CURSOR ON TOP OF OVERSHOOT

MAT4211

CURSOR READOUT

BOTH

In this mode, time and volt cursors are active. A new softkey function is 'CONTROL = II'. It selects the TRACK and Δ control for time or volt cursors. Once the CONTROL mode (time or volt) is selected, the appropriate reset softkeys (100% or 360°) become available.

Key sequence:

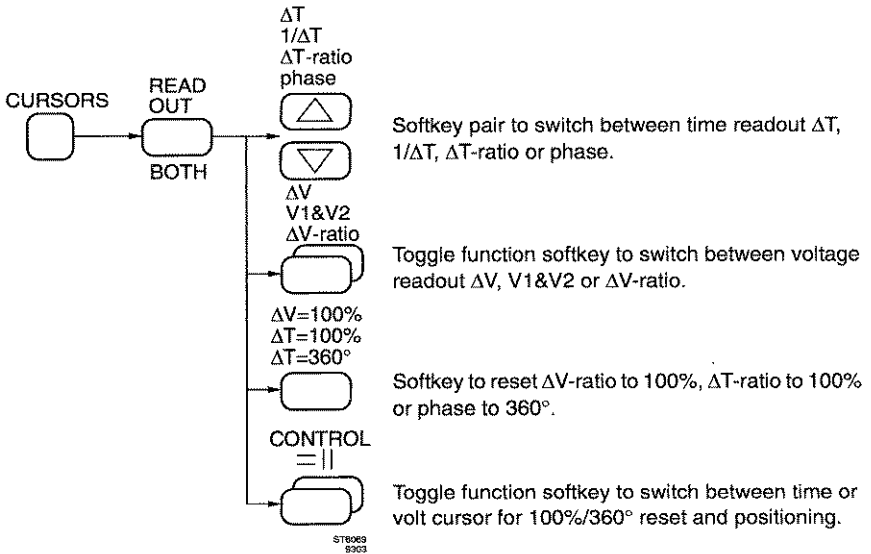

Remote commands:

CPL: QM (command to query measured values)

Refer to appendix E for full details.

CURSORS X-DEFLECTION

Description:

When X-DEFL is 'on', an XY display is active with horizontal deflection by CH1 ... CH4 or ac power line. This is explained under the X-DEFLECTION function. The horizontal and the vertical readouts are now given in volts. The cursor menu is reached via the CURSORS menu key and is shown in Appendix B.

Possible selections are:

- Cursors on/off.
- Volt cursors (=) only, time cursors (||) only, both cursors (#) at a time.
- When both volt and time cursors are (#) active, the softkey 'CONTROL = ||' selects which cursors are positioned.

Key sequence:

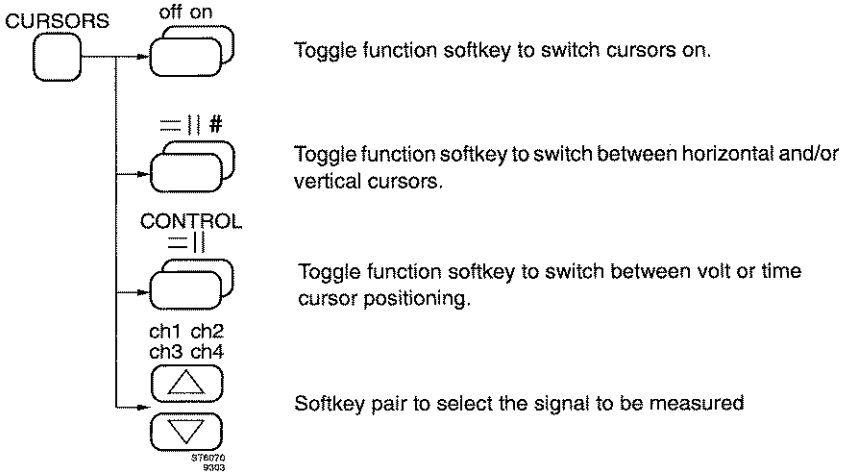

DTB

Description:

The Delayed Timebase (DTB) is used to examine signal details of interest. The detail is indicated as an intensified part of the MTB trace and is displayed on the full screen width (= DTB time scale).

The DELAY control adjusts the delay between the start of MTB and DTB sweep. Refer to the TRIGGER DTB function for more details.

The DTB time scale is adjusted in steps with the DTB keys.

The delayed timebase can be switched on in the DELAYED TIMEBASE menu, which can be initialized by pressing the DTB key. This is done with the first softkey called 'DEL'D TB on/off'.

Once the delayed timebase trace is activated, you can press the MAIN TB on/off softkey to turn off the main timebase trace. This, however, is usually not necessary. It is usually preferable to display the MTB and DTB traces simultaneously.

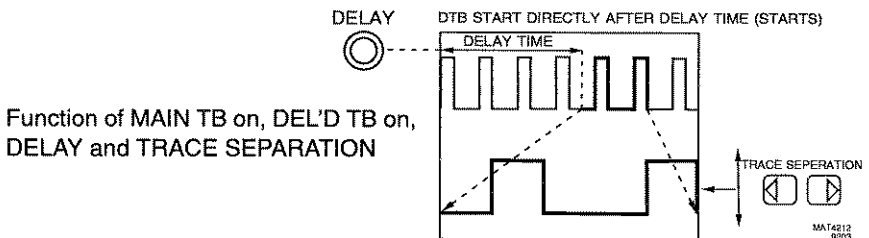

Key sequence:

DTB



Key pair to adjust the DTB time scale.

DELAY



Control to adjust delay time between start of MTB and DTB sweeps

TRACE SEPARATION



Key pair to adjust vertical distance between MTB and DTB traces

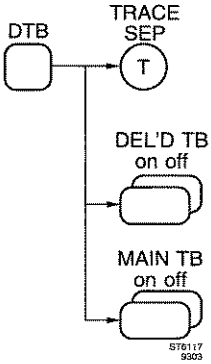

The 'T' symbol in the menu indicates that the TRACK cursor control can also be used for adjusting the TRACE SEParation when the menu is displayed.

Toggle softkey to switch the delayed timebase on and off.

Toggle softkey to switch the main timebase on and off.

INPUT ATTENUATOR

Description:

The oscilloscope's input has a wide range of sensitivities. This enables signals of different amplitudes to be displayed on the available screen area. Sensitivity adjustment is done with key pair AMPL/VAR (for full channels only) or a single AMPL toggle key (on CH3 and CH4 of PM3092, PM3082 only).

Input sensitivity increases when the top key (mV) is pressed; it decreases when the lower key (V) is pressed. The sensitivity adjustment can be done in steps or continuously; switching between these modes is done by pressing both keys simultaneously. The CRT readout resolution correspondingly changes. The amplitude of a signal can be determined as described under the 'SCREEN CONTROLS AND GRATICULE' function.

For CH3 and CH4 on the PM3092, PM3082 the input sensitivity can be adjusted to the two most commonly used settings (0.1 and 0.5 V/div). Selection is done with a single toggle key AMPL.

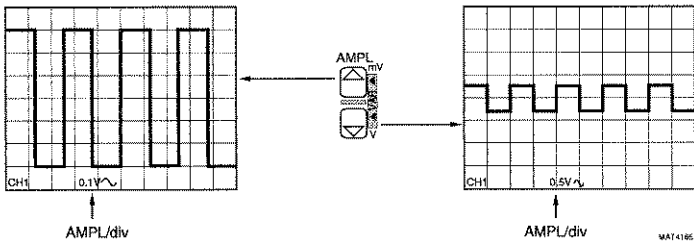

Function of key pair AMPL/VAR

Key sequence:

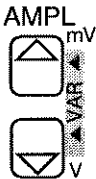

Key pair to adjust the vertical input sensitivity in coarse or fine steps. Used for channel 1, 2, 3 and 4 in PM3094, PM3084. Used for channel 1 and 2 in PM3092, PM3082.

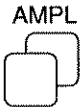

Toggle key to switch between two vertical input sensitivities. Used for channel 3 and 4 in the PM3092, PM3082.

INPUT COUPLING

Description:

The characteristics of the oscilloscope's inputs can be selected for each channel. A channel can be switched on/off with the toggle key ON. CH1 is always switched on when CH2, CH3 or CH4 is the last channel to be switched off.

In the dc coupled mode the complete signal including dc components and extremely low frequencies (<10 Hz) are displayed. In the ac coupled mode, dc components are suppressed. This results in a display of the ac components (≥ 10 Hz).

Ground coupling (GND) interrupts the input signal. The position of the trace at is the 0 volt level. A continuous ground level indication for each channel can also be activated. Refer to the description of the UTILITY SCREEN & SOUND function.

The selections are made with the toggle keys AC/DC or AC/DC/GND. The presence of these keys can differ depending on the type of channel.

The type of coupling is given in the readout area using the symbols \sim (ac), = (dc) and \perp (GND).

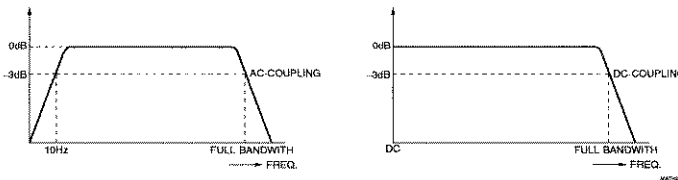

Effect of ac/dc input coupling

Key sequence:

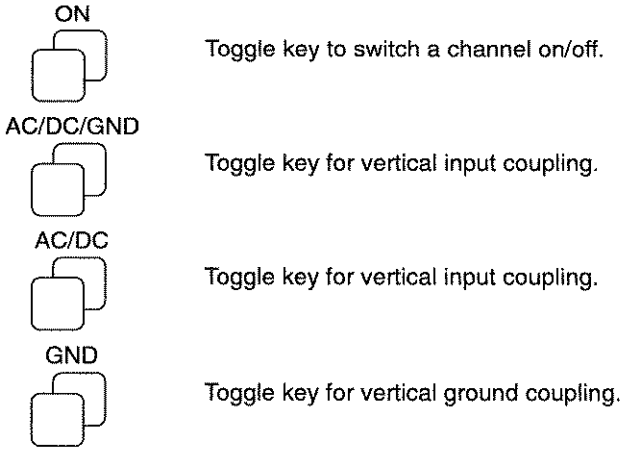

INPUT IMPEDANCE

Description:

For high-frequency measurements the input impedance in PM3092, PM3094 can be switched from 1 M Ω to 50 Ω . Input impedance is automatically adapted to the type of probe. Manual switching is done with the toggle key 50 Ω and a confirm menu.

The input is protected in the 1 M Ω as well as the 50 Ω setting:

- 1 M Ω : protected for signals up to 400 V.
- 50 Ω : protected for peak voltages up to 50 V or up to 5 V rms.

For details, refer to the Reference Manual.

Key sequence:

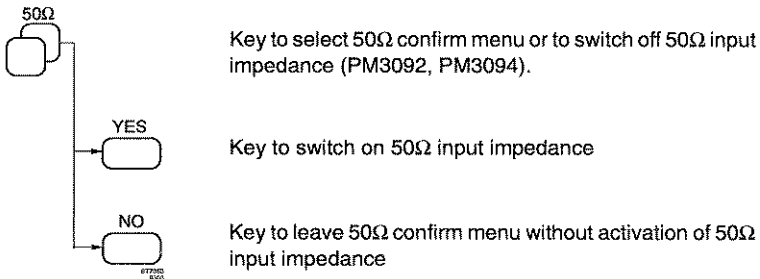

MAGN

Description:

The magnify key (10x MAGN) is used for horizontal expansion of the trace by a factor of 10. The timebase range is then expanded from 20 ns/div to 2 ns/div in PM3092, PM3094 and from 50ns/div to 5ns/div in PM3082, PM3084. The X POS control can be used to move the trace and to display the signal part of special interest.

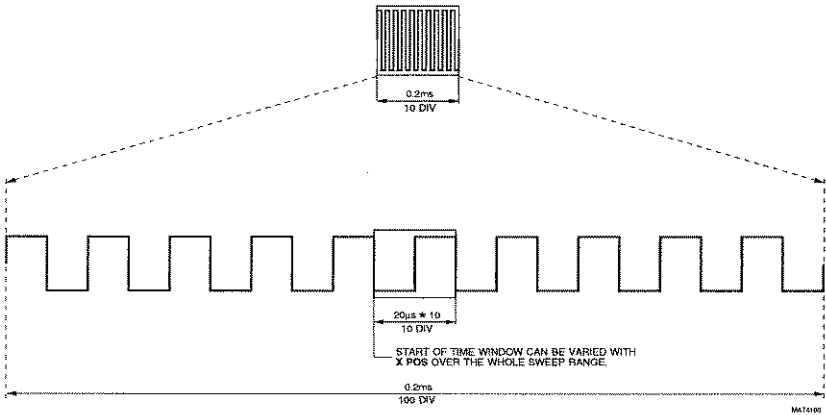

Function of timebase magnifier and X POS control

Key sequence:

10x MAGN



Toggle key to switch the 10 times expansion of the time base

MTB TIME/DIV

Description:

The Main Timebase (MTB) has a wide range of time/div settings. This enables the display of signals of various frequencies to be displayed with optimum resolution. The time scale is adjusted with the key pair MTB/VAR. Adjustment can be done in steps or in a continuous range (VAR). Switching between these modes is done by pressing both keys simultaneously. For low frequency signals, the MTB speed must be slow; this is obtained by pressing the 's' side of MTB/VAR. For high frequency signals, the 'ns' side is pressed. Time values of a signal can be determined as described under the 'screen controls and graticule' function.

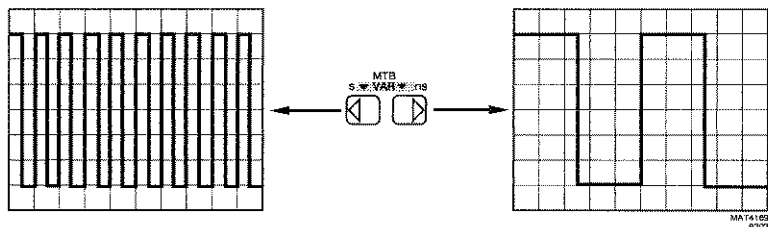

Function of key pair MTB/VAR

Key sequence:

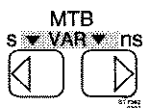

Key pair to adjust the MTB time scale for fine or coarse steps

POSITION

Description:

Position controls allow the signals to be shifted across the screen to align signals with the measuring graticule to make time and voltage measurements.

Vertical positioning is done for each channel with the POS controls.

Horizontal positioning of all signals is done with the X POS control.

Key sequence:

POS



Control to adjust vertical position of a channel.

X POS



Control to adjust the horizontal position of all the channels

POWER SUPPLY

Description:

The instrument can be used at any nominal line voltage between 100 Vac and 240 Vac, with no switching and no fuse changes. After the instrument is turned on by pressing the POWER ON/OFF switch, an automatic power-up test is started. For detailed information, refer to the 'CONFIDENCE CHECK' function.

The oscilloscope starts up with its previous settings when backup batteries are installed. In the absence of batteries, the standard default setting 'std' becomes active. Refer to STANDARD FRONT for details.

Key sequence:

POWER ON OFF



Toggle key to switch the oscilloscope on/off.

PROBE UTILITIES

Description:

The 'PROBE SWITCH' setting of the 'UTILITY >> PROBE' menu determines the instrument's reaction when you press the push button on the probe. You can select between a grounded input or the start of AUTOSET.

For non-Fluke probes or probes without an indication ring, the attenuation factor can be programmed. As a result, the combined input sensitivity of the probe and oscilloscope is given in the readout area. The selections in the UTILITY PROBE CORR menu are reached via the key sequence 'UTILITY >> PROBE >> PROBE CORR'. Attenuation factors 1:1, 10:1, 20:1, 50:1 and 100:1 can be selected. This can be done for each channel individually (ch1, ch2, ch3, ch4).

Key sequence:

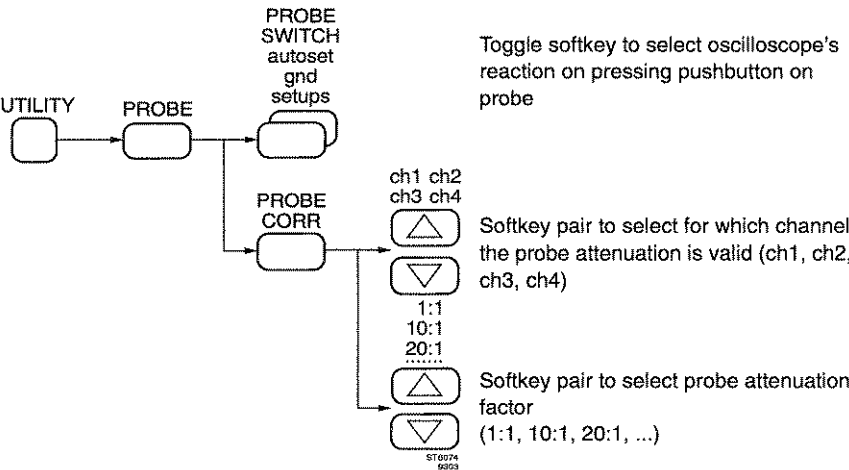

REMOTE CONTROL IEEE 488.2

Description:

An IEEE 488.2 Interface is available as an option. This interface can be used to control oscilloscope functions by an external computer. All of the oscilloscope's current settings can be read by the computer.

The programming language is called SCPI (Standard Commands for Programmable Instruments). SCPI is an IEEE standardized language designed for remote control of programmable test and measuring equipment. General information for SCPI and the instructions are located in a separate programming manual. The 24-pole connector and its connections are shown in the figure below.

For correct functioning in a IEEE 488 environment, the oscilloscope's device address must be selected. This is done in the UTIL REMOTE CONTRL menu with the TRACK control. This menu is reached via the key sequence 'UTILITY >> REMOTE CONTRL'. To change the IEEE settings, first select IEEE with the 'RS-232 IEEE' softkey.

Operation of front key STATUS LOCAL passes the control of the oscilloscope from the interface (remote) to the front keys (local).

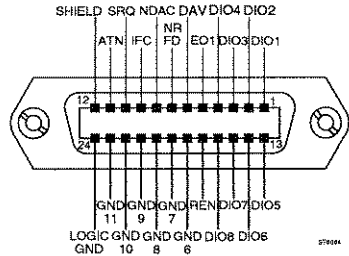

Key sequence:

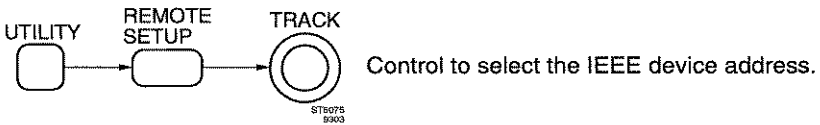

STATUS



LOCAL

Key to switch from remote to local

REMOTE CONTROL RS-232

Description:

The oscilloscope is equipped with an RS-232 Interface as standard. This can be used for remote control or for setting the readout using an external controller or PC.

The language used is called CPL (Compact Programming Language) and is described in Appendix E. CPL is a small set of very powerful commands for full remote control of all oscilloscope functions. The male 9-pin connector and its connections are shown in the figure below.

For correct functioning Communication parameters must be adjusted. This is done in the menu UTILITY RS-232 SETUP. This menu is reached via the key sequence 'UTILITY >> RS-232 SETUP >>'. Possible Selections are:

- Baud rate. To be selected with the TRACK control.
- Number of DATAbits and PARITY. Combinations are
 dataBITS: 7 7 8 8 8
 PARITY: Odd Even Odd Even No
 There is always one stopbit.
- Hardware handshake is selected with '3-wire/7-wire'. In the 7 wire position the hardware handshake signals DSR/DTR and CTS/RTS are active.
- Software handshake is selected with 'XON-XOFF on off'.

Operation of the front panel key STATUS LOCAL passes the control of the oscilloscope from the interface (remote) to the front panel keys (local).

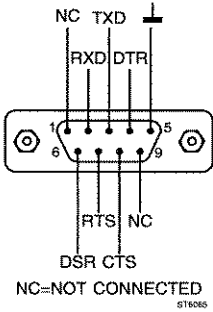

Key sequence:

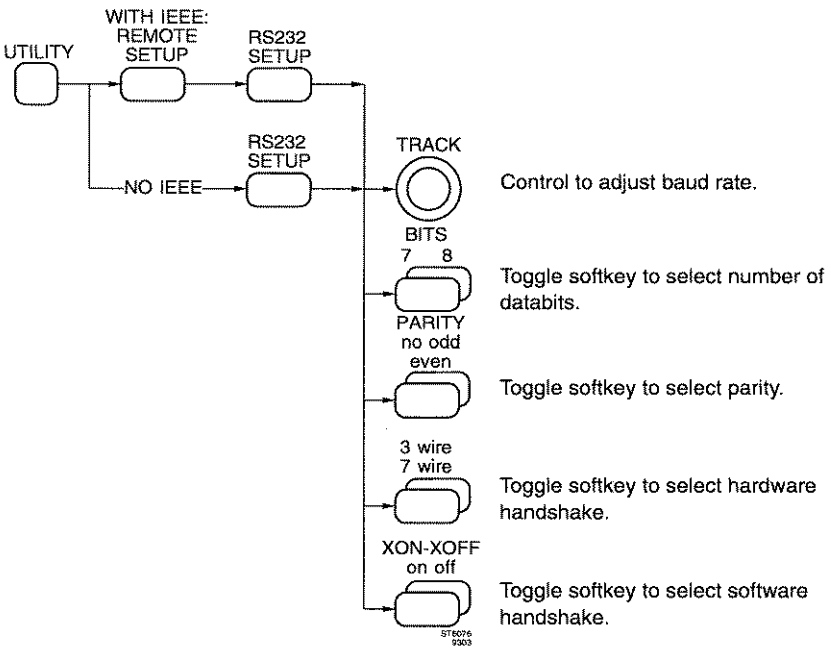

STATUS



LOCAL

Key to switch from remote to local.

Remote commands:

- CPL: PC (Command to program communication parameters)
- GL (Has same result as operation of STATUS LOCAL key)
- LL (Inhibits front key STATUS LOCAL)

Refer to appendix E for full details.

SCREEN CONTROLS AND GRATICULE

Description:

The screen controls are located to the left of the CRT viewing area.

Brightness of trace(s) and text can be adjusted separately with the TRACE INTENSITY and TEXT INTENSITY controls. Intensity of the trace(s) can also be determined by a voltage applied to the rear panel socket Z MOD. Refer to 'Characteristics' Chapter 1 of the Reference Manual for input amplitudes.

The FOCUS control is used to optimize display sharpness.

A graticule is provided with 1cm x 1cm divisions. Each vertical centimeter equals the indicated channel sensitivity. A horizontal centimeter equals the indicated timebase setting. The graticule has 0, 10, 90, and 100 % lines that can be used for risetime measurements. For these, the signal peaks are exactly positioned on the 0 and 100 % lines. The risetime of the pulse is readout between the 10 and 90 % lines as shown in the following figure. Intensity of graticule illumination is controlled with the GRATICULE ILLUMINATION control.

Trace alignment is done with the screwdriver operated TRACE ROTATION control.

Screen controls and function of TRACE ROTATION.

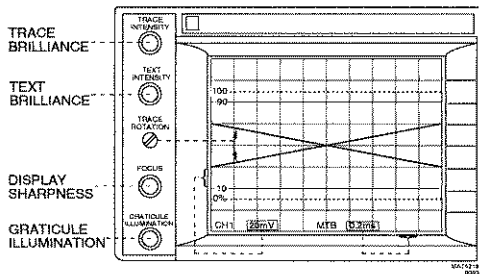

Rise time measurement using the graticule.

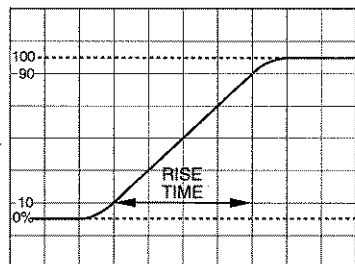

Key sequence:

TRACE INTENSITY



Control for trace intensity.

TEXT INTENSITY



Control for text intensity.

TRACE ROTATION



Screwdriver operated control to align the trace with the graticule

FOCUS



Control for focusing of trace, text and cursors.

GRATICULE
ILLUMINATION



Control for illumination intensity of measuring graticule

SCREEN MESSAGES

Description:

User messages show up in the center of the CRT viewing area. Messages warn of incorrect settings and error conditions. The following table shows the important messages.

Message	Meaning Refer to function '...'
ALWAYS PARITY IF 7 BITS	No parity possible in case of 7 bits. Function 'REMOTE CONTROL RS-232'.
NO CHOP IF COMPOSITE	CHOPped and COMPOSITE modes cannot be combined. Function 'TRIGGER MTB'.
FRONT PROTECTED	Settings cannot be saved in protected memory location. Function 'FRONT SAVE/RECALL'.
FRONT EMPTY	Recalling settings from an empty memory location is not possible. Protection of an empty front is impossible. Function 'FRONT SAVE/RECALL'.
PROTECT WILL BE OVERRULED	Shows up when protected fronts are cleared using the 'clear all' key. Function 'FRONT SAVE/RECALL'.
CALIBRATION COMPLETED	Autocalibration is completed. Function 'CALIBRATION AUTOCAL'.
PROBE DETECTED, NO CHANGE	The automatic probe detection overrules manual selection when a probe with indication ring is used. Function 'PROBE UTILITIES'.
VPP SWITCHED OFF	Vpp cursors disabled when DTB is selected. Functions 'CURSORS' and 'DTB'.

PRESS 2 SEC FOR AUTO CAL	CAL key must be pressed for more than 2 sec to start autocalibration. Function 'CALIBRATION AUTO CAL'.
AUTO CAL	Indicates that autocalibration has started. Function 'CALIBRATION AUTO CAL'.
CH.. 50Ω OVERLOAD	Input voltage at 50Ω input impedance is too high (in PM3092, PM3094). Function 'INPUT IMPEDANCE' .
CALIBRATION ERROR ...	Autocal not successfully completed. Function 'CALIBRATION AUTO CAL'
STD FRONT = RECALL ONLY	Saving settings in the 'std' front is impossible. Function 'FRONT SAVE/RECALL'.

SETUPS

Description:

Ten complete front panel settings can be saved into a battery backed-up memory. This feature is useful for routine measurements. Setups are stored in memory location labeled s1 s10. These memories are accessible under the menu key **SETUPS**. The menu structure is shown in Appendix C.

Selection of the memories s1 ... s10 is done with the TRACK control. Memory location 'std' is a factory-stored set of standard settings that can be used to put the instrument in a defined state. For a detailed specification, refer to the STANDARD SETUP function.

save: The actual set of settings is saved in the selected memory location.

recall: The settings saved in the selected memory location become the actual settings.

undo: The settings previous to the last recall action become active again.

CLEAR & PROTECT: in the CLEAR & PROTECT SETUPS submenu 'PROTECT on off' can be used to protect a memory location by prohibiting save actions to this location.

clear all: in the CLEAR & PROTECT SETUPS submenu 'clear all' leads to a confirm menu. The memory locations s1 to s10 are emptied altogether when 'yes' is selected. Selecting 'no' stops the clear action.

TEXT: this key gives access to a submenu which allows you to add user text and a label or tag to a stored front panel setting. Text editing is similar to that explained under the USERTEXT function.

Note: Screen messages are given in the CRT viewing area when incorrect commands are given and the action is prohibited. Example: When one attempts to save settings to a protected memory location.

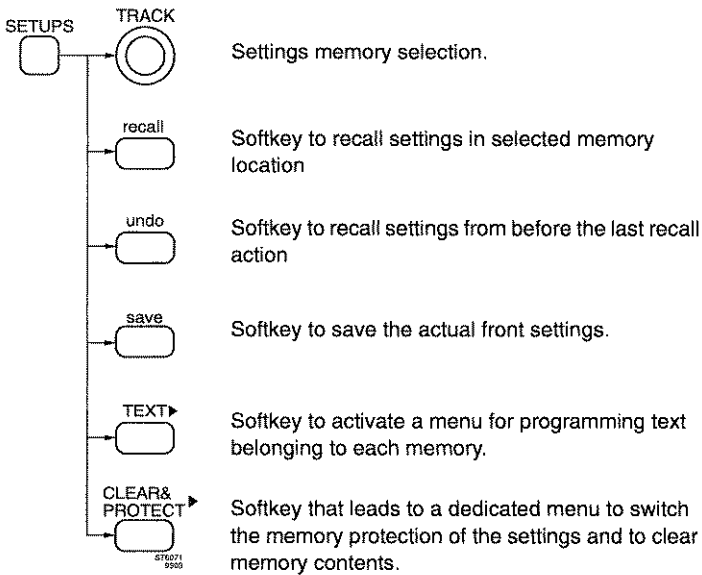
Key sequence:**Remote commands:**

- CPL: SS (To save a front in a desired memory)
 RS (To recall a front from a desired memory)
 PT (To program text into a setup register)
 QT (To query text from a setup register)

Refer to appendix E for details

SETUPS**SEQUENCE**

Description:

If, for instance, front panel settings are stored in the memory locations s1 to s5 while s6 is cleared, then s1 to s5 are recalled in sequence. This sequence can be used as a step by step testing procedure in manufacturing. It is also possible to step through such a sequence without using menus in the following two ways:

1. By programming the AUTOSET key to be used as the 'recall next set up' key. This selection can be done via the key sequence UTILITY >> AUTOSET >> setups.
2. By using a special probe with a 'probe command switch'. This mode can be selected via the key sequence UTILITY >> PROBE >> setups.

STANDARD SETUP / FRONT PANEL RESET

Description:

A factory-programmed set of default settings is available to put the instrument in a defined state. The default settings (std) are reached in the menu under the SETUPS menu key. Another method to perform a front panel reset is by pressing the STATUS and TEXT OFF keys simultaneously.

The TRACK control is used to Select 'std' and the memories s1 ... s10 (refer to SETUPS). The settings saved in 'std' become the actual settings when the 'recall' softkey is pressed.

The most important 'std' settings are:

- AUTOSET USERPROG is set to 'off'.
- Setting readout is switched on.
- Ground indicator is set to 'on'.
- Usertext is set to 'off'.
- Cursors are 'off'.
- Input is dc coupled and input impedance is 1 M Ω .
- Input sensitivity is set to 50mV and VAR off.
- CH1 is on. CH2, CH3 and CH4 are off.
- Vertical POS is set to center of screen.
- MTB on and X-DEFL 'off'.
- MTB in 1 ms and auto mode. VAR and 10x MAGN are off.
- MTB triggering in edge, level-pp on, positive slope, ac coupled and trigger source CH1.

Note: Error messages appear in the CRT viewing area when incorrect commands are given.

Key sequence:

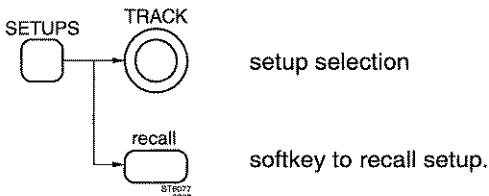

Remote commands:

CPL: DS

Refer to appendix E for full details

STATUS SCREEN

Description:

Normally a maximum of four lines of setting information are given in the lower screen area. More extensive setting information can also be displayed. The STATUS toggle key switches between normal and extensive settings information.

The status screen gives the following additional setting readouts:

- Channel input coupling is indicated by AC, DC, or GND instead of symbols.
- Settings of inactive channels are given in addition to the active channels.
- Channel off or on is displayed.
- The probe type is given for each channel.
- A continuous indication of HOLD OFF, LEVEL MTB and LEVEL DTB is given.
- MTB and DTB trigger coupling are indicated.
- TV mode settings are displayed.

Note: The STATUS key has a second function when the oscilloscope is under remote control. This second function is called 'go to LOCAL' and is indicated in small text below the STATUS key. For more information, refer to the 'REMOTE CONTROL RS-232' and 'REMOTE CONTROL IEEE 488.2' functions.

Key sequence:

STATUS



LOCAL

Toggle key to select amount of settings information on screen

TB MODE MTB

Description:

The Main Timebase (MTB) can function in the auto, trig and single modes. The related SINGLE RESET key, NOT TRIG'D indicator and HOLD OFF control are explained below.

In 'auto' mode, MTB becomes free running in the absence of a trigger signal. This always gives a display, even when no signal is present. This mode is used most often except for signal frequencies lower than 10 Hz.

In triggered (trig) mode, traces are displayed only as long as the MTB is triggered. This mode is recommended for frequencies lower than 10 Hz.

The NOT TRIG'D indicator lights when MTB is not triggered.

In 'single' mode (after operation of the SINGLE RESET key), MTB runs only once after the first trigger. The NOT TRIG'D indicator lights when MTB is waiting for a trigger (MTB armed). The single mode is used to observe (and often photograph) events that happen only once.

Auto, trig and single can be chosen in the menu under the TB MODE menu key.

The HOLD OFF control determines the hold off time. This is the 'dead' time after the run of MTB. During this time, the MTB cannot be triggered. Under normal conditions the hold off time must be minimal (0%). Turning the HOLD OFF control clockwise increases the hold off time. This can suppress unstable triggering on complex pulse signals. The figure gives an example.

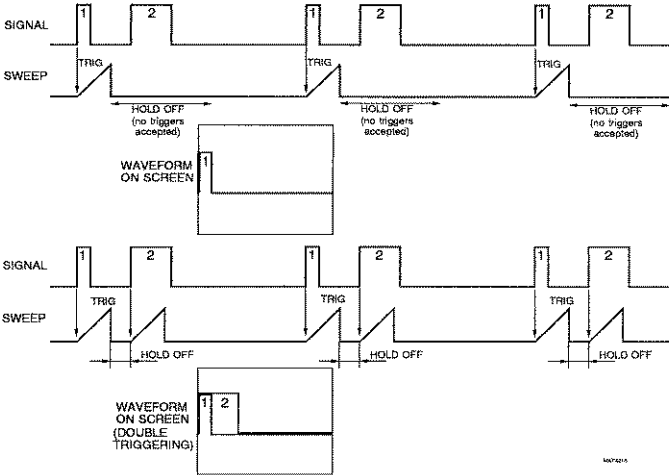

Using HOLD OFF to suppress double triggering

Key sequence:

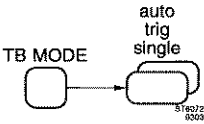

Toggle softkey to select between auto, trig and single



Not trig'd indicator

SINGLE RESET



Key to reset MTB in single shot mode

HOLD OFF



Control to adjust MTB hold off time

Remote commands:

CPL: AT (Has same result as operation of SINGLE RESET key)

Refer to appendix E for full details.

TEXT OFF

Description:

Toggle key to select information in the CRT viewing area. This way, more space is available on screen for trace display. There are three steps in the cycle:

- Softkey menu turned off.
- Instrument settings turned off.
- Both softkey menu and instrument settings turned on again.

Key sequence:

TEXT OFF



Toggle key to cycle through three states of information given in CRT viewing area.

TRIGGER COUPLING

Description:

Trigger coupling is used to optimize the trigger stability for different signal types.

The filter modes ac and dc are identical to those of the vertical inputs. Refer to function INPUT COUPLING.

Lf-reject cuts off lower frequencies; triggering occurs on signals between 30 kHz and full bandwidth.

Hf-reject cuts off higher frequencies; triggering occurs on signal frequencies lower than 30 kHz. The following figure explains ac, lf-reject, and hf-reject.

Noise 'on' improves trigger stability for noisy signals. By enlarging the trigger gap (of MTB and DTB) the triggering becomes less sensitive to noise.

The MTB trigger coupling can be selected in the menu under the TRIGGER MTB menu key. For DTB, the menu under DTB menu key is used; the selection is possible in 'triggered' mode (ch1 ... ch4) only.

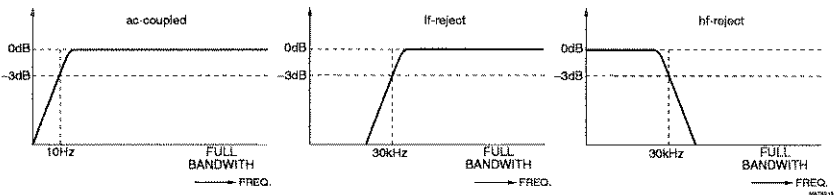

Effect of trigger coupling modes

Presence of trigger level indicators (T-, D-) as a function of trigger coupling and other oscilloscope settings:

Trigger coupling	Vertical input coupling	Trigger level indicator
ac dc lf-rej hf-rej	dc	off on off on
all settings	ac	on
if level-pp is on		off

Key Sequence:

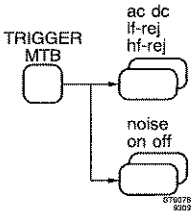

Toggle softkey to select MTB trigger coupling modes ac, dc, lf-reject, and hf-reject.

Toggle softkey to switch 'noise' mode for MTB/DTB.

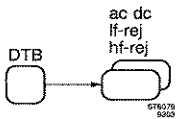

Toggle softkey to select DTB trigger coupling modes ac, dc, lf-reject and hf-reject. Not selectable when 'starts' is active in the menu under the DTB key.

TRIGGER DTB

Description:

In the "STARTS" mode, the DTB starts immediately after DELAY time. This is explained under DTB. When signal jitter is present, the effect will be magnified by using the DTB. The jitter is eliminated by changing from 'starts' to triggered mode. The start of the DTB sweep is then 'postponed' to the first DTB trigger after the delay time.

The triggered mode is activated in the DTB menu by selecting trig'd. For stable triggering, the DTB trigger LEVEL must be adjusted to a proper level. The figure shows the difference between 'starts' and triggered.

For more explanation of general trigger functions, refer to 'TRIGGER MTB' function. For details about trigger coupling, see the appropriate section.

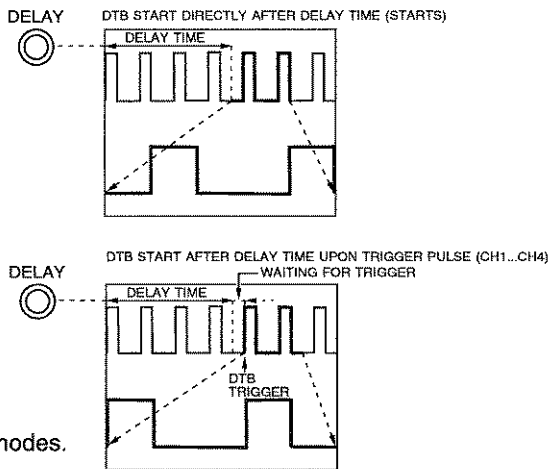

DTB 'starts' and triggered modes.

MMT4214

The DTB trigger source and slope can be selected under the following conditions:

- 1 - The menu is active
- 2 - The trig'd mode is selected.

Source and slope are selected with the same TRIG1, TRIG2, TRIG3 and TRIG4 keys that are used for the main timebase trigger source and slope selection. The DELAYED TIMEBASE source and slope have their own readout. This readout can be found at the bottom right corner just under the main timebase source and slope readout.

If the channel and trigger coupling are the same (e.g., both are ac or both are dc), the trigger level is indicated on the screen by: D-. For more details refer to the DTB section of this FUNCTION REFERENCE.

key sequence:

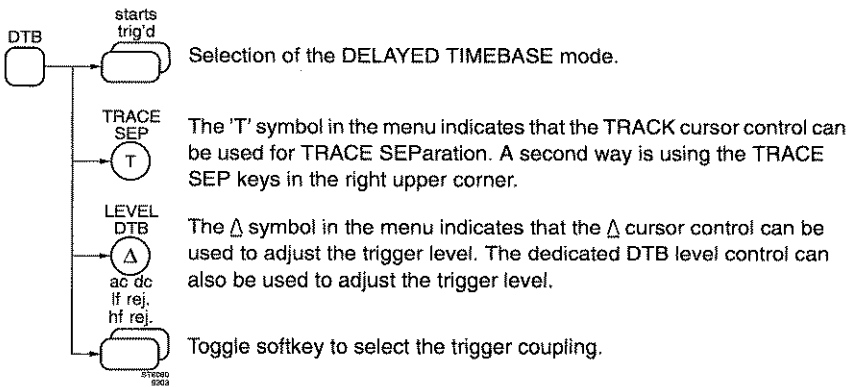

TRIGGER LEVEL

Description:

LEVEL selects the signal level at which the timebase will trigger. For triggering, the level must be within the peaks of the signal.

LEVEL MTB sets the trigger level for the main timebase. In level-pp 'on' mode, the level range is clamped within the peak-peak values of the signal. Then the MTB will always be triggered as shown in the following figure. When level-pp is 'off', the level range is from -8 ... +8 divisions.

The DTB has its own LEVEL control. It is activated in the triggered DTB mode. The range is from -8 ... +8 divisions.

Trigger levels for MTB and DTB can be displayed. Refer to the description of the UTILITY SCREEN & SOUND function.

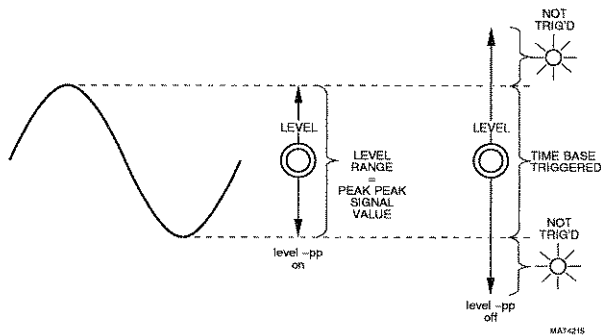

MTB LEVEL control ranges in level-pp on and off

Key sequence:

LEVEL MTB



Control for MTB trigger level.

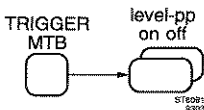

Toggle softkey to switch MTB level-pp on and off.

LEVEL DTB



Control for DTB trigger level.

TRIGGER MTB

Description:

This section deals only with 'edge' triggering of the MTB. For TV triggering or DTB triggering refer to the TV triggering or DTB triggering functions.

Triggering determines the start point of the MTB sweep. The sweep starts at the moment the signal crosses the trigger level in positive or negative direction. The slope is selectable ($f\setminus$), as is shown in the figure below.

Any of the four input signals can be used as trigger source. The source is selected with the four keys 'TRIG1 ... TRIG4' in the corresponding channel control sections. The same keys are used to toggle between the positive (f) and negative (\setminus) slope.

In the ALternate mode, two or more signals are on the screen. In this mode, it is possible to get a stable display even when the signals have no time relation (e.g. different frequencies). This is called the composite (comp) mode. In composite mode the trigger source is switched at the same time as the alternating display of the vertical channels. The composite mode is selected with a softkey under the TRIGGER MTB menu key.

For line frequency related signals, a Line trigger source is available. The Line source is selected with a softkey under the TRIGGER MTB menukey.

For noisy signals, trigger filters can be used. For this, lf-rej or hf-rej can be selected. Refer to TRIGGER COUPLING and TRIGGER LEVEL for details.

The MTB trigger settings are selected in the menu under the TRIGGER MTB menu key. The toggle softkey 'ch.. comp line' selects the trigger source in combination with the keys TRIG1 ... TRIG4 that give direct front panel access to trigger source CH1 ... CH4. This is combined with ($f\setminus$) slope selection.

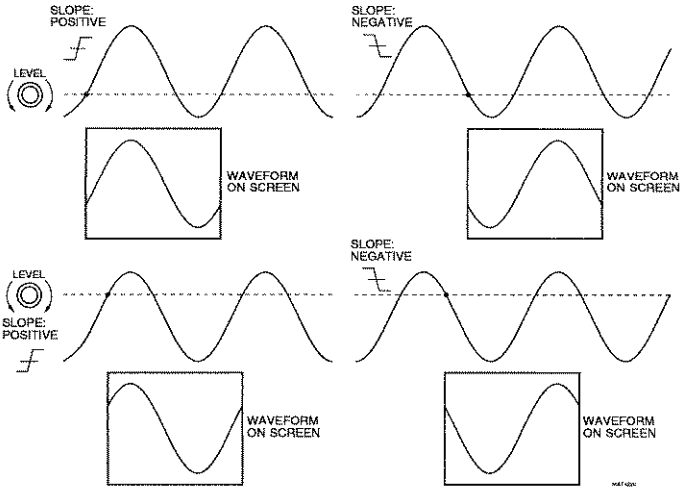

Function of LEVEL and slope

Key sequence:

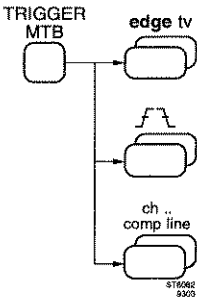

Toggle softkey to select edge or TV triggering.

Toggle softkey to switch positive and negative trigger edge (slope).

Toggle softkey to select MTB trigger source. CH1 ... CH4 to be selected with TRIG1 ... TRIG4.



Toggle key to select CH1, CH2, CH3 or CH4 as MTB trigger source. Subsequent key presses cause the trigger slope to change between positive and negative trigger edge.

TV TRIGGER MTB/DTB

Description:

In addition to the ability to trigger on edges (explained under TRIGGER MTB), there is a video trigger mode. This allows stable triggering on TV frames and lines. There is no need to adjust the trigger level.

Triggering is possible on video signals with positive (pos) as well as negative (neg) signal polarity. Supported video standards include NTSC, PAL, SECAM and HDTV.

The MTB can be triggered on a TV line (all lines are superimposed), field 1 and field 2 of any of the four channels. In addition the DTB can also be triggered on TV line pulses for individual line display.

The MTB TV trigger settings are selected in the menu under the TRIGGER MTB menu key. In this menu, selection of edge/tv and polarity is combined for MTB and DTB. Selection of DTB triggering on TV line pulses is done in the menu under the DTB menu key.

Key sequence:

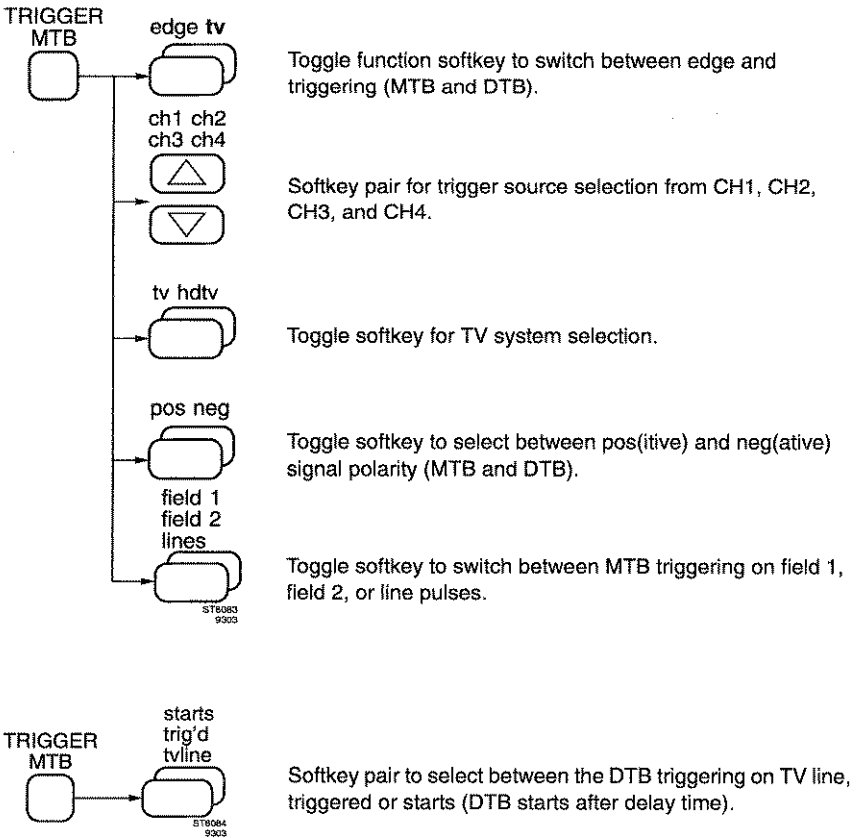

USERTEXT

Description:

Two lines of user-definable text can be displayed in the CRT viewing area. The text may be useful as additional information when taking photographs. The selections are reached via the key sequence 'UTILITY >> SCREEN & SOUND >> USERTEXT >> on'.

The EDIT USER TEXT menu gives the following editing modes:

- The TRACK control determines the position where text has to be edited. The position is indicated by a flashing cursor.
- The Δ control is used for character selection.
- Softkey 'space' changes the character under the cursor into a space.
- Softkey 'delete' erases text under the cursor.
- Softkey 'insert' adds a space under the cursor.

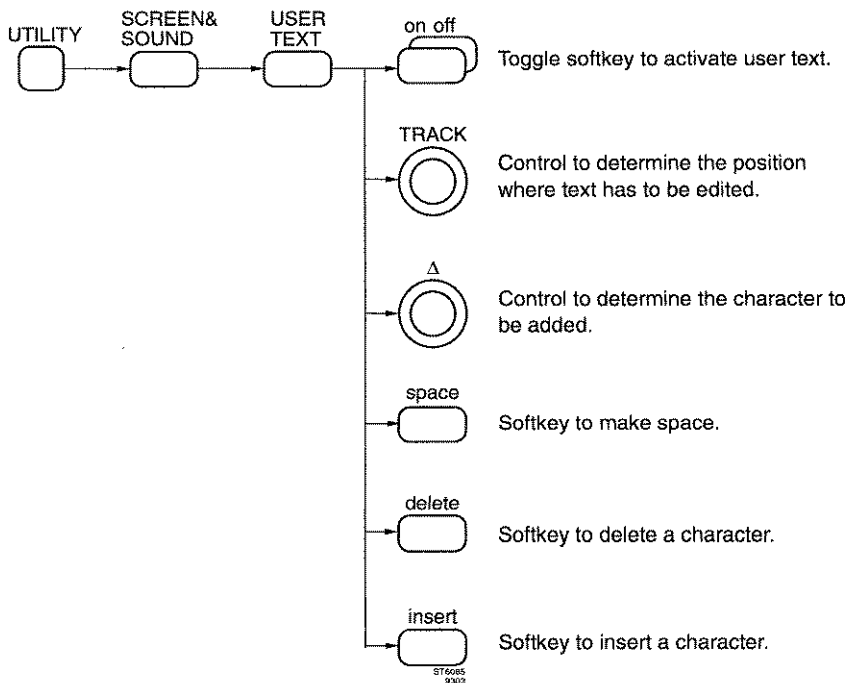
Key sequence:

Remote commands:

- CPL: PT (command to program user text)
- QT (command to query user text)

Refer to appendix E for full details.

UTILITY MENU

Description:

The UTILITY menu is used to make presettings for instrument settings that do not need to be changed frequently:

- The operation of the AUTOSET key. For a description, refer to the AUTOSET and AUTOSET USERPROG functions.
- Selections in relation to probes. Refer to PROBE UTILITIES function for details.
- Amount of information in CRT viewing area and audio signals. Refer to the UTILITY SCREEN & SOUND function. The UTILITY SCREEN & SOUND menu has a dedicated submenu for usertext. See the USERTEXT function for more information.
- Presettings for the remote control interfaces. Refer to REMOTE CONTROL RS-232 and REMOTE CONTROL IEEE 488.2
- Settings for maintenance and repair such as tests and calibration data. Data affecting the instrument's accuracy can only be changed by entering a password. This is explained in detail in the Service Manual.

The UTILITY menu is reached via the UTILITY menu key. The following figure shows the structure of the UTILITY menu related to instrument operation.

Key sequence:

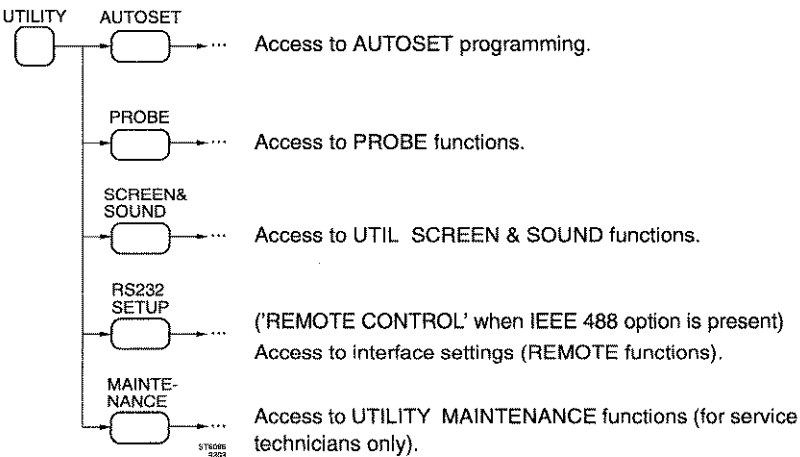

UTILITY SCREEN & SOUND

Description:

The UTILITY SCREEN & SOUND menu is used to select on-screen text, trigger and ground level indicators, and user text. Settings for acoustic feedback (beep and click) are set in this menu. The menu can be reached with the key sequence 'UTILITY >> SCREEN & SOUND'.

The following selections are possible:

- Trigger level indicators (TRIG IND) for MTB and DTB. Level-pp and TV mode must be off. The horizontal marker is the level position.
- Ground level indicators (GND IND) for each channel are visible only when channel is on. The horizontal line is the ground level position.
- MTB-int contrast between MTB trace and intensified part is adjusted with the TRACK control.
- USERTEXT leads to a submenu for usertext. Refer to the function USERTEXT for more information.

The following audio signals are activated with the key sequence 'UTILITY >> SCREEN & SOUND >> SOUND':

- BEEP on off, the signal sounds to indicate messages or AUTOSSET.
- CLICK on of, the signal indicates operation of keys and rotary controls.

Key sequence:

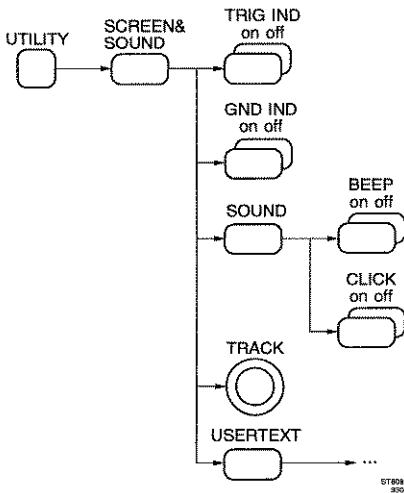

Toggle softkey to display trigger level indication.

Toggle softkey to display ground level indication.

Toggle softkey to select warning signal.

Toggle softkey to select rotary control/key operation signal.

Control to adjust the intensity ratio in 'mtb' mode.

Access to editing menu for USERTEXT.

UTILITY MAINTENANCE

Description:

The UTILITY MAINTENANCE menu is used to calibrate the oscilloscope and for repair and testing. Calibration data is protected by a password and by operation of a pinhole switch that can be sealed. Calibration is of vital importance for the instrument's high accuracy. The menu is meant for calibration and for use by service technicians, and is therefore not explained in this Operating Guide. An extensive description can be found in the Service Manual.

X-DEFLECTION

Description:

When X-DEFL in the TB MODE menu is switched to 'off', the timebase is displayed. The horizontal scale is then expressed in time units per division. For details on horizontal deflection using the MTB and DTB, refer to the MTB TIME/DIV and DTB functions.

When X-DEFL is 'on', horizontal deflection is caused by the signal of one from the four input channels. Also the line voltage can be used for X-deflection.

The selections are done in the menu under the TB MODE menu key. After selection of X-DEFL 'on', the source selection becomes visible.

Key sequence:

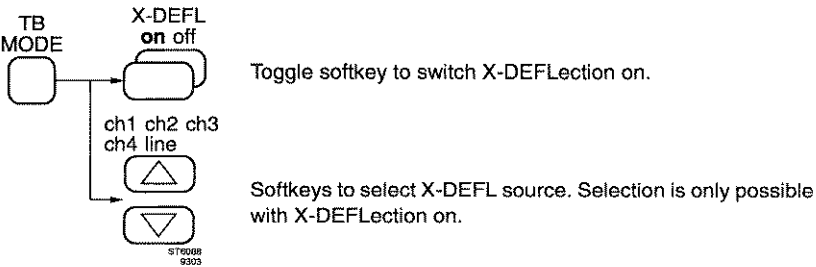



Appendix A

Cursor menu structure X-DEFL off

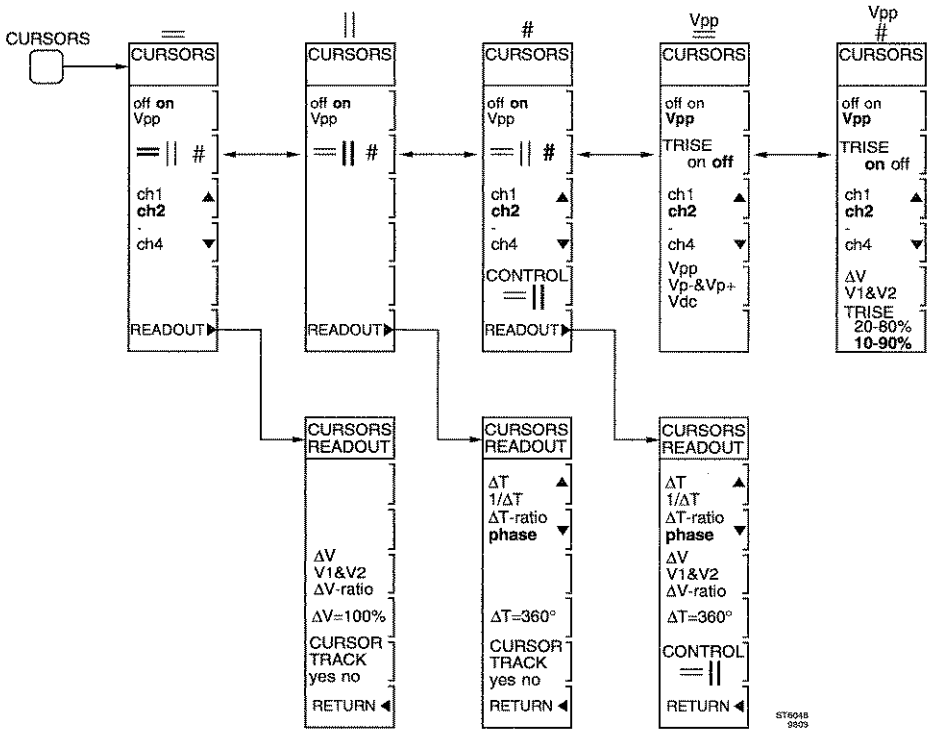

Appendix B

Cursor menu structure X-DEFL on

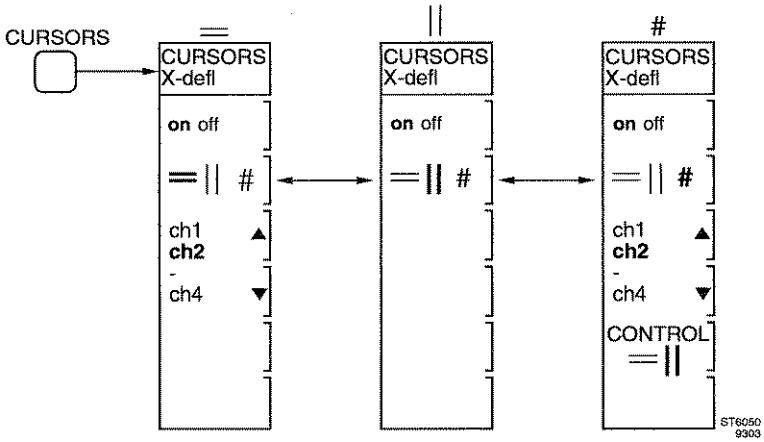

Appendix D

UTILITY menu structure

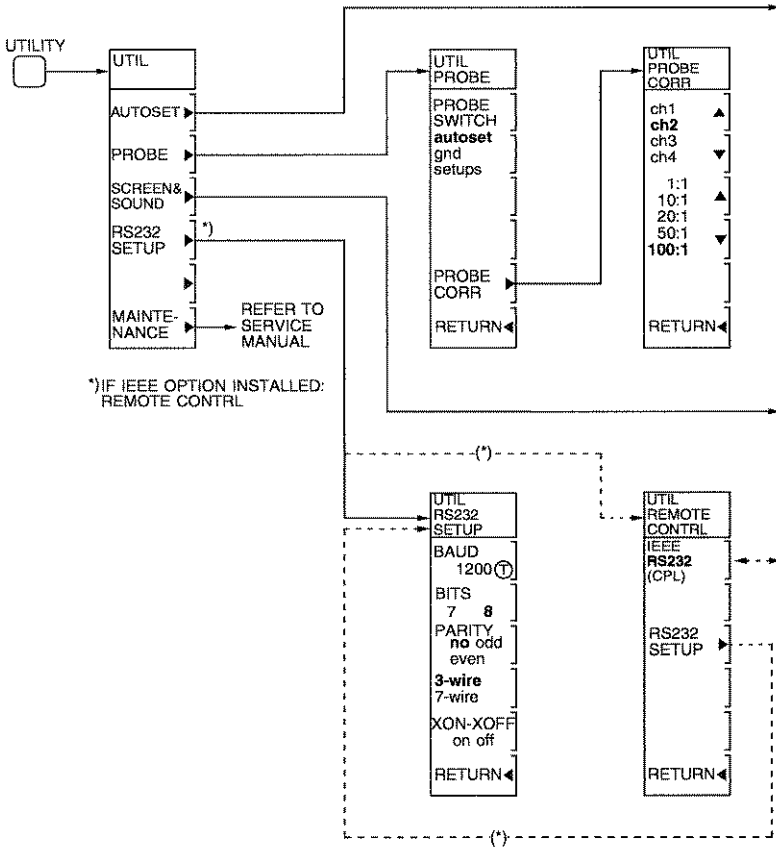

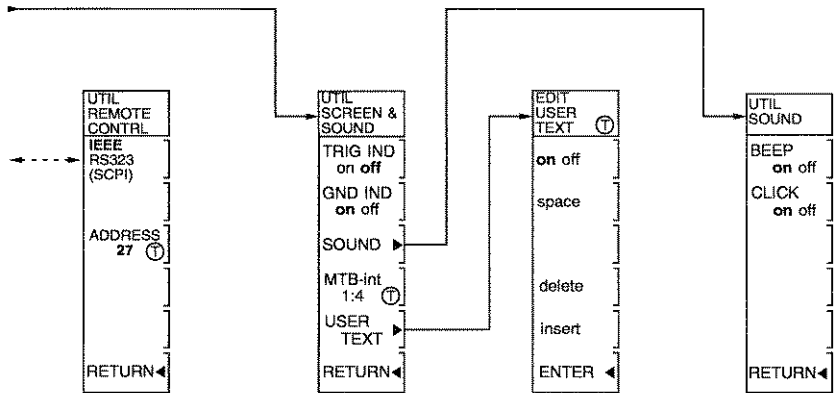
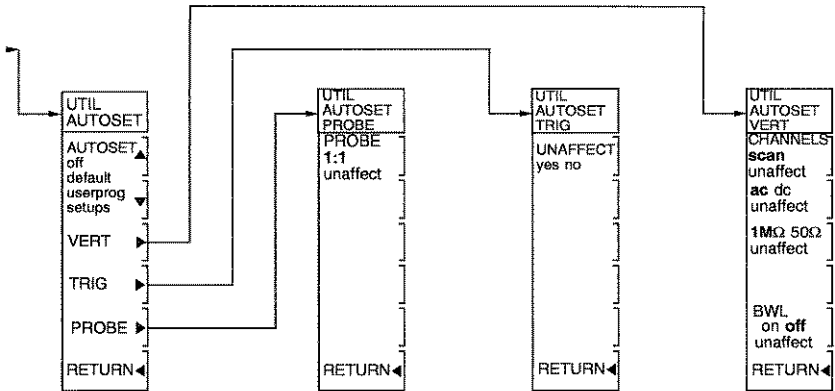



APPENDIX E

The CPL protocol

1 Introduction

The oscilloscope can be controlled via the RS-232 serial interface using the Compact Programming Language (CPL) protocol. In this protocol a small but very powerful set of commands is defined.

The main characteristics of the CPL protocol:

It is kept simple and straightforward and is fully tailored to use simple communication facilities like those of BASIC.

Special emphasis is put on the ease of programming:

- easy input format with a 'forgiving' syntax:
 - Commands always consist of two characters that can be **upper or lower** case.
 - Parameters that sometimes follow the command may be separated from it by **one or more** separation characters.
- strict and consistent output format:
 - Alpha character responses are always in UPPERCASE.
 - Parameters are always separated by only one comma ("," = ASCII 44).
 - Responses always end with a carriage return (CR = ASCII 13).
- synchronization between input and output
 - After receipt of every command, CPL returns an acknowledge character and a carriage return (CR = ASCII 13), to indicate reception and/or execution of the command.

Commands

All commands consist of a header of two alpha characters. Some of the commands are followed by parameters to give the oscilloscope more information. The parameters are separated from one another by a PROGRAM DATA SEPARATOR <pds>. At the end of the complete command (i.e., header and parameters) comes the PROGRAM MESSAGE TERMINATOR CR. After the CR is recognized by the oscilloscope, the command will be executed. Then an <acknowledge> and CR is sent to signal the end of the command processing.

- Notes:*
- *Literal characters are placed between double quotes, e.g. "AS".*
 - *Literal characters may be specified in upper and lower case.*

There are several IMPLICIT QUERY commands, which means that the oscilloscope will send data back (i.e., respond) to the computer after receiving and executing the command.

Acknowledge

The <acknowledge> is an automatic response from the oscilloscope to let the computer know that the received command has been executed. The <acknowledge> also contains information about how the command was executed.

An <acknowledge> is always followed by a CR. For more information, see section 6 ACKNOWLEDGE.

Responses

The format of the response data depends on the command which invoked the response. When several values or strings are returned they are always separated with a RESPONSE DATA SEPARATOR which is a comma ("," = ASCII 44). To signal the end of the response a RESPONSE MESSAGE TERMINATOR CR (ASCII 13) is sent.

Data Separators

Data Separators are used between parameters sent to the oscilloscope and between values and strings received back from the oscilloscope. The following list gives the possibilities for data separators:

program data separator

space SP (ASCII 32) *)
tab HT (ASCII 9) *)
comma , (ASCII 44)

*) more than one space or more than one tab can be used as a separator

response data separator

comma , (ASCII 44)

Message Terminators:

At the end of a command or response a terminator must be sent. For both programming and response messages the terminator has been defined as:

program message terminator

carriage return CR (ASCII 13)

response message terminator

carriage return CR (ASCII 13)

2 Example Program Frame

In the COMMAND REFERENCE SECTION a very short programming example is given for each command. All examples are written in GW-Basic and able to run on an IBM-compatible PC. The example program expects the oscilloscope to be connected via COM1 port (RS-232) with a RS-232 null modem cable (refer to section 9 [RS-232](#)) and to be setup at 9600 baud, 8 databits, no parity, 3 wire, xon/xoff = off (Menu UTIL).

The following program lines are an example frame work. The frame work lets you embed any of the example programs shown in the COMMAND REFERENCE SECTION.

Program frame:

```
10 OPEN "COM1:9600,N,8,1, CS0, DS0, CD0" AS #1:'open serial
port *)
```

... Insert Example Programs Here

```
999 END
1000 '- synchronize on acknowledge & handle error:
1010 INPUT#1,ACK
1020 IF (ACK=0) THEN GOTO 1110
1030 IF (ACK<0) OR (ACK>4) THEN GOTO 1100
1040 PRINT "ERROR: ";ACK;
1050 ON ACK GOTO 1060,1070,1080,1090
1060 PRINT "SYNTAX ERROR" : END
1070 PRINT "EXECUTION ERROR" : END
1080 PRINT "SYNCHRONISATION ERROR" : END
1090 PRINT "COMMUNICATION ERROR" : END
1100 PRINT "UNKNOWN ACKNOWLEDGE" : END
1110 RETURN
```

First the serial port of the PC is opened (line 10) with the settings of the oscilloscope communication parameters **)

Following that, the example program lines from the COMMAND REFERENCE SECTION can be executed.

The subroutine to synchronize on the <acknowledge> returned from the oscilloscope starts at line 1000.

*) The oscilloscope communication parameters are stored in battery backup memory when the oscilloscope is turned off. On power-up the parameters are restored.

3 Commands in functional order

group	name	command
Communication	Program Communication	PC
Setup	Auto Setup	AS
	Default Setup	DS
	Program Setup	PS
	Program text	PT
	Query Setup	QS
	Query text	QT
	Recall Setup	RS
	Save Setup	SS
	Calibrate	CL
States	Go to Local	GL
	Go to Remote	GR
	Local Lockout	LL
Measurement	Arm Trigger	AT
Miscellaneous	IDentification	ID
	Query measurement	QM
	Reset Instrument	RI
	SStatus query	ST

4 Commands in alphabetical order

command	name
AS	Auto Setup
AT	Arm Trigger
CL	Calibrate
DS	Default Setup
GL	Go to Local
GR	Go to Remote
ID	IDentification
LL	Local Lockout
PC	Program Communication
PS	Program Setup
PT	Program text
QS	Query Setup

QM	Query measurement
QT	Query text
RI	Reset Instrument
RS	Recall Setup (internal)
SS	Save Setup (internal)
ST	SStatus query

5 Command Reference

In this section all commands of the CPL protocol available in the oscilloscope are described in alphabetical order.

All command descriptions have the same layout:

NAME	NM
-------------	-----------

Purpose:

Explains the command, its parameters and limitations.

Command:

Shows the syntax for the programming command. The parameters are separated by one or more PROGRAM DATA SEPARATORS <pds>. Commands are terminated by a Carriage Return (CR).

Response:

Shows the format of the response coming from the oscilloscope. Responses are terminated by a Carriage Return (CR).

The oscilloscope will <acknowledge> after the receipt of each programmed command. This acknowledgment indicates the status of the oscilloscope after command execution. For more information refer to section 6 (ACKNOWLEDGE).

To obtain a more detailed status description, the status can be fetched with the ST command.

Example:

Example lines of programming code are used to demonstrate the function of the CPL commands. The examples as shown can be embedded in the Program Frame mentioned in section 2.

AUTOSET

AS**Purpose:**

To start the AUTOSET function. With this command the oscilloscope will select the optimum settings (volts, time base, trigger mode, etc.) for the connected signal(s).

The AutoSet (AS) command performs the same function as pressing the front panel AUTOSET button.

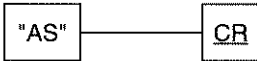
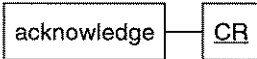
Command:**Response:**

Note: The <acknowledge> will be sent after the AUTOSET has been fully completed.

Example:

```
100 PRINT #1, "AS"      : 'Send command
110 GOSUB 1000          : 'Sync on acknowledge
```

ARM TRIGGER

AT**Purpose:**

Will reset the timebase and rearm the triggering for a new timebase trigger. Issuing this command during a time base sweep will immediately stop the sweep, reset the timebase and rearm the triggering.

The Arm Trigger (AT) command performs the same function as pressing the frontpanel SINGLE RESET button.

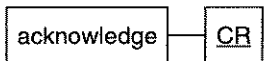
Command:**Response:****Example:**

```
100 PRINT #1,"AT"   :'Send command
110 GOSUB 1000      :'Sync on acknowledge
```

CALIBRATE

CL**Purpose:**

To start the internal Auto-Calibration procedure. This procedure optimizes the input, trigger and time base circuitry of the oscilloscope. This calibration takes approximately one minute and completion is signalled by the acknowledge.

The Calibrate (CL) command performs the same function as pressing the front panel CAL button for more than 2 seconds.

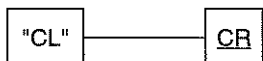
Command:**Response:**

Note: The <acknowledge> will be sent after the calibration has been fully completed. A detailed error report may be queried for using the ST command (only if acknowledge is not zero).

Example:

```
100 PRINT #1, "CL"      : 'Send command
110 GOSUB 1000          : 'Sync on acknowledge
```

DEFAULT SETUP

DS**Purpose:**

Sets the oscilloscope to the default setup conditions.

The Default Setup (DS) command performs the same function as pressing the TEXT OFF and STATUS/LOCAL buttons simultaneously.

The communication interface parameters will not be changed.

Command:**Response:**

Note: The <acknowledge> is sent after the completion of the change to the default setups.

Example:

```
100 PRINT #1, "DS"      : 'Send command
110 GOSUB 1000          : 'Sync on acknowledge
```

GO to LOCAL**GL****Purpose:**

Puts the oscilloscope in the Local State. In the Local State, all oscilloscope functions are accessible via the front panel buttons and knobs.

The Go to Local (GL) command performs the same function as pressing the STATUS/LOCAL key on the front panel of the oscilloscope, when the oscilloscope is in the Remote State (Refer also to "Go to Remote" and "Local Lockout").

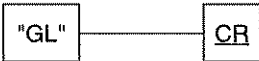
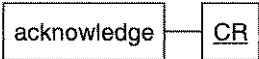
Command:**Response:****Example:**

```
100 PRINT #1, "GL"      : 'Send command
110 GOSUB 1000          : 'Sync on acknowledge
```

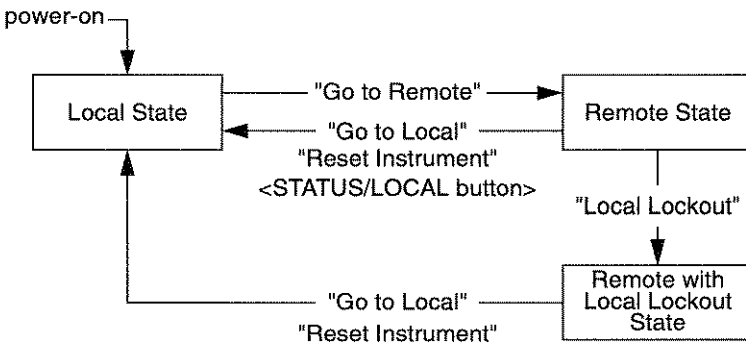
Local, Remote, Remote+Local Lockout States

GO to REMOTE

GR

Purpose:

Puts the oscilloscope in the Remote State. In the Remote State none of the oscilloscope functions are accessible via the front panel buttons and knobs.

Going back to the Local State is achieved by sending the Go to Local (GL) command or by pressing the STATUS/LOCAL key on the frontpanel (Refer also to "Local Lockout" and "Go to Local").

Command:



Response:

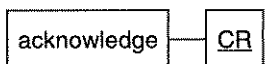

Example:

```

100 PRINT #1, "GR"      : 'Send command
110 INPUT #1, ACK      : 'Sync on acknowledge
    
```

Local, Remote, Remote+Local Lockout States

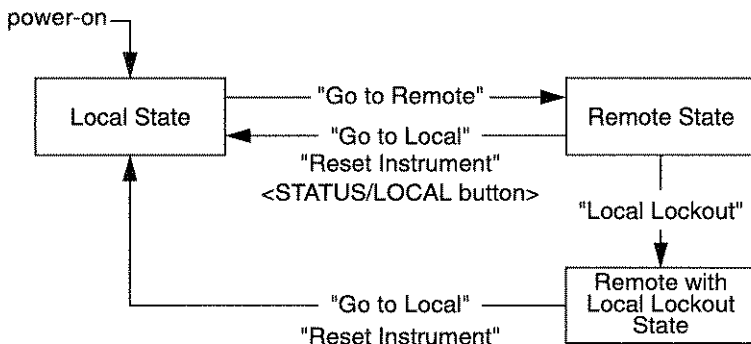

IDENTIFICATION**ID****Purpose:**

Returns the identification of the oscilloscope. It gives information about the model number (e.g. PM3094), the version numbers of all software modules and the installed options.

This Identification (ID) command gives the same information as can be read from the oscilloscope screen after pressing the frontpanel knob UTILITY and the softkey MAINTENANCE.

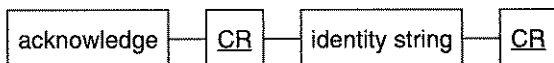
Command:**Response:**

Note: The items in the identity string are separated by a ';' (ASCII 59)

Example:

```

100 PRINT #1,"ID"      : 'Send command
110 GOSUB 1000         : 'Sync on acknowledge
120 INPUT #1,ID$      : 'Input Identity string
  
```

example response:

```

FLUKE; PM3094; 0; SW3094I V1.0 1991-12-05; MSK V1.0; UFO V2.0; IEEE;
EXT CR
  1           2           3           4           5
  
```

- 1 - manufacturer
- 2 - model number of the oscilloscope
- 3 - information about the oscilloscope software
- 4 - information about the micro-controller software
- 5 - information about the frontpanel control software
- 6 - information about installed options

LOCAL LOCKOUT

LL

Purpose:

This instruction will inhibit the Go to Local function of the STATUS/LOCAL key on the frontpanel.

Once activated, the Local Lockout State is disabled by sending the Go to Local (GL), the Reset Instrument (RI) command or by cycling power OFF and ON.

(Refer also to "Go to Remote" and "Go to Local").

There is no front panel equivalent for this command.

Command:



Response:

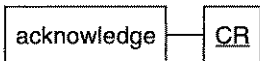

Example:

```

100 PRINT #1, "LL"      : 'Send Command
110 GOSUB 1000          : 'Sync on acknowledge
    
```

Local, Remote, Remote+Local Lockout States

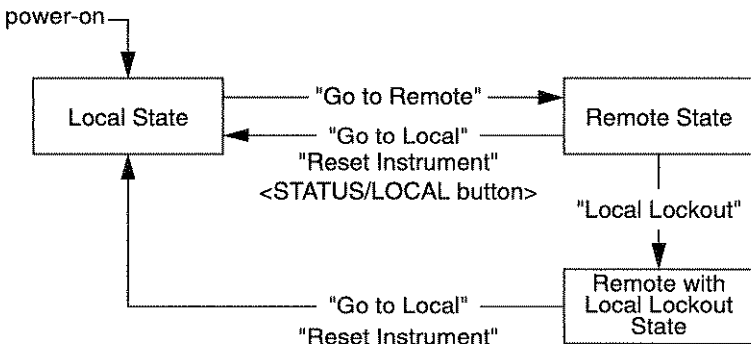

PROGRAM COMMUNICATION**PC****Purpose:**

To program baudrate, parity mode, number of data and stopbits and the handshake method for computer communication.

After the command is sent, an <acknowledge> will be returned with the old communication parameters still active.

If the <acknowledge> = 0, the new communication parameters will be valid approximately 0.5 seconds later. The communication parameters are stored in battery backup memory and restored on power-up.

This command performs the same function as the UTILITY + RS232 SETUP menu.

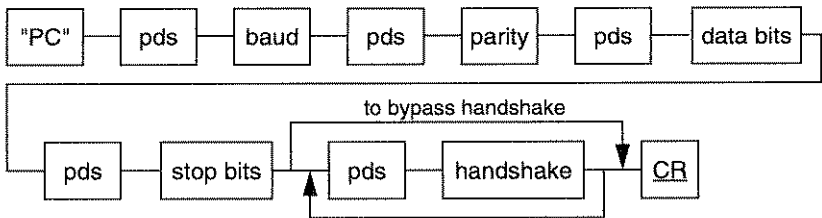
Command:

- <baud> = 75, 110, 150, 300, 600, 1200, 2400, 4800, 9600, 19200, 38400
- <parity> = O, E or N
- <data bits> = 7 or 8
- <stopbits> = 1
- <handshake> = XONXOFF to enable Xon/Xoff handshake
 HWL to enable hardwareline handshake
 none to disable both handshake methods

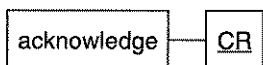
Response:

Note: approx. 0.5 sec after an <acknowledge> = 0 is received, the communication parameters are changed to the new values.

Example:

```
100 PAR$="2400,N,8,1"           : 'comm parameters
110 CTL$="XONXOFF"             : 'XONXOFF handshake
120 PRINT #1,"PC",PAR$,CTL$    : 'Send command
130 GOSUB 1000                 : 'Sync on acknowledge
140 CLOSE #1                   : 'Close the COM Port,
150 WT=TIMER                   :
160 WHILE (TIMER-WT) < .5 : WEND : 'Wait 0.5 second
170 OPEN "COM1:";PAR$ AS #1    : 'Reprogram COM Port
```

PROGRAM SETUP**PS****Purpose:**

To configure the oscilloscope using compact setup strings. This Program Setup (PS) command and the Query Setup (QS) command can be used together to restore and retrieve a complete setup or partial of the oscilloscope.

The format of the programming strings must be the same as the format of the received setup strings. Each setup string describes a "node" in the oscilloscope setup.

It is possible to send back partial setups because the setup nodes can be send individually.

(Refer to "Query Setup" and section 8 SETUP)

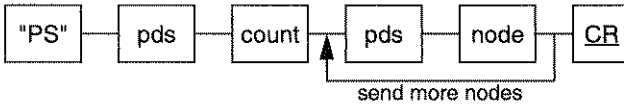
Command:

<count> number of node strings to follow.
 <node> string of hexadecimal characters (0..9,A..F) representing a
 setup node in the oscilloscope.

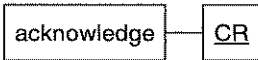
Response:

Note: the <acknowledge> is sent after the setup has been completed.

Example:

```

100 PRINT #1, "PS";                    : 'Setup command
110 PRINT #1, N;                        : '# of strings
120 FOR I=1 TO N
130 PRINT #1, SETUP$(I); " ";        : 'Send strings sep'd by SP **)
140 NEXT I
150 PRINT #1, ""                        : 'Send CR to end the setup
160 GOSUB 1000                         : 'Sync on acknowledge
  
```

****)** These are the strings that are received after a Query Setup (QS) command

PROGRAM TEXT**PT****Purpose:**

To program text to an oscilloscope.

If the **S** parameter is specified, setup text is programmed. The text will be set into one of the setup registers of the oscilloscope. The parameter **n** specifies the setup register. A maximum number of 22 characters is allowed. The remainder of the text field is set to 'spaces'.

If the **S** parameter is not specified, user text is programmed. The text will be displayed on the screen of the oscilloscope. A maximum number of 64 characters is allowed. The remainder of the text field is set to 'spaces'. The parameter **n** may not be used.

The programmed text can be read with the Query Text (QT) command.

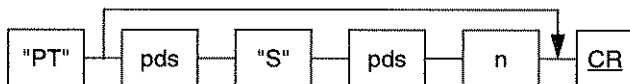
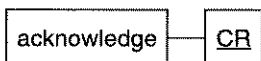
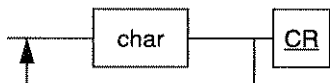
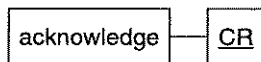
Command 1:**Response 1:****Command 2:****Response 2:**

- "S" setup text will be specified for register n; if "S" and n are left out, user text is specified
- n one of the setup registers, ranging from 0 to 10; n=0 selects the current setup
- char a character byte; range = 0 to 12, 14 to 255 (refer to character code table E.1)

The following table contains the decimal codes of the character set for the screen of an oscilloscope:

CHAR	CHARACTER DESCRIPTION
0 .. 12	Control up/down character (conform char. 127)
13	Command terminator ASCII <u>CR</u> (may not be used)
14	Control up/down character (conform char. 127)
15 and 16	Positive and negative slope characters
17 and 18	Positive and negative pulse characters
19	Dual slope character
20	Special marker (X)
21, 22, 23	Delta, degrees, micro characters
24 and 25	Low impedance (low_z) and omega (Ohm) characters
26 and 27	Arrow up and down (char. 27 is also ESC character)
28 and 29	AC and ground (channel coupling) characters
30	Register off (but filled) character
31	Filled o character
32	ASCII space character
33 .. 39	ASCII characters ! " # \$ % & '
40 .. 47	ASCII characters () * + , - . /
48 .. 57	ASCII characters 0 1 2 3 4 5 6 7 8 9
58 .. 64	ASCII characters : ; < = > ? @
65 .. 77	ASCII characters A B C D E F G H I J K L M
78 .. 90	ASCII characters N O P Q R S T U V W X Y Z
91 .. 95	ASCII characters [\] ^ _
96	Menu selection indication
97 .. 109	ASCII characters a b c d e f g h i j k l m
110 .. 122	ASCII characters n o p q r s t u v w x y z
123	Menu return indication
124	l character
125 and 126	Menu rocker key up and down characters
127	Control up/down character ()
128 .. 255	Control up/down character (conform char. 127)

Table E.1 Character code table for oscilloscopes.

Examples: (of user text)

- 1) Program the following user text to be displayed on the screen of the oscilloscope: **Measurement 15**

```

100 PRINT #1,"PT"           : 'Program user Text command
110 GOSUB 1000              : 'Sync on acknowledge
120 PRINT #1,"Measurement 15": 'Send user text
130 GOSUB 1000              : 'Sync on acknowledge

```

- 2) In the next example user text, containing non-keyboard characters ($\Omega=25$ decimal and $\blacktriangle=125$ decimal), is programmed to be displayed on the screen of the oscilloscope, e.g.: **Ohm(Ω),Up(\blacktriangle).**

```

100 PRINT #1,"PT"           : 'Program user Text command
110 GOSUB 1000              : 'Sync on acknowledge
120 PRINT #1,"Ohm(";CHR$(25);"),Up(";CHR$(125);")."
                             : 'Send user text
130 GOSUB 1000              : 'Sync on acknowledge

```

Example: (of setup text)

Program the following text to set up register 7 of the oscilloscope: **1.25 k Ω (CH1)**

```

100 PRINT #1,"SS 7"         : 'Save Setup command
110 GOSUB 1000              : 'Sync on acknowledge
120 PRINT #1,"PT S 7"       : 'Program setup Text command
130 GOSUB 1000              : 'Sync on acknowledge
140 PRINT #1,"1.25 k";CHR$(25);" (CH1)"
                             : 'Send setup text
150 GOSUB 1000              : 'Sync on acknowledge

```

QUERY MEASUREMENT**QM****Purpose:**

To obtain measurement data from an oscilloscope.

If the **V** (Value) parameter is specified, one measured value will be returned.

If the **L** (Logging) parameter is specified, an infinite number of measured values will be returned. Cancelling is possible by sending the ASCII character ESC.

If no **V** or **L** parameter is specified, one measured value is returned, preceded by its type, and concluded by its suffix.

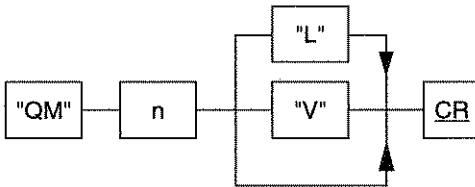
Command:

"V" only the numerical value of the measurement result is returned

"L" the numerical values of an infinite number of measurement results is returned; cancelling is possible by sending ASCII character ESC (= 27 decimal)

n decimal number, specifying the type of measurement to perform

n	meas_type	suffix_unit	Note:
10	dV	V	delta Voltage between cursors
11	V1	V	Volt cursor 1
12	V2	V	Volt cursor 2
13	Vdc	V	Volt dc
20	dT	s	delta Time between cursors
21	F	Hz	Frequency (1/dT)
30	dX	V	delta X

Note: Delta T can only be obtained, if X-Deflection is off. Delta X can only be obtained, if X-Deflection is on.

Response 1:

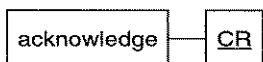

Response 2:

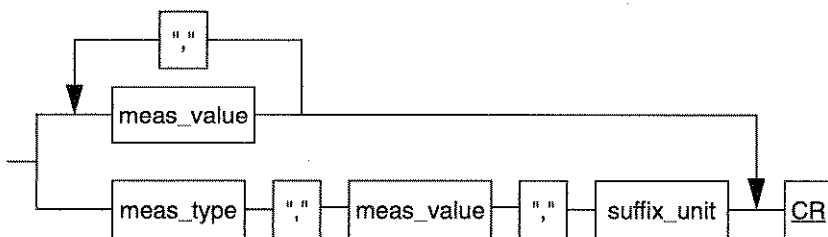

Response 2:	Condition:
type,value,unit	No V or L parameter
value	V parameter specified
value{,value}	L parameter specified

- meas_type string of characters, specifying the type of the measured value, e.g. "Tr"
- meas_value string of characters, specifying the measured value in floating point notation, e.g. "98934E-09"
- suffix_unit string of characters, specifying the unit of the measured value: "V", "s" or "Hz"

Example: (of a single measurement)

```

100 PRINT #1,"QM",21           : 'Query for frequency mea-
                               : surement
110 GOSUB 1000                 : 'Sync on acknowledge
120 INPUT #1,TYPE$,MEAS$,SUFFIX$ : 'Read measured frequency
130 PRINT "Measurement: ";TYPE$;MEAS$;SUFFIX$
                               : 'Print measured frequency

```

Example: (of multiple measurements)

```

100 PRINT #1,"QM",10,"L"      : 'Query for delta-voltage
                               : measurement
110 GOSUB 1000                 : 'Sync on acknowledge
120 INPUT #1,MEAS$            : 'Read measured delta-
                               : voltage
130 PRINT "Measurement: ";MEAS$ : 'Print measured delta-
                               : voltage
140 IF INKEY$="" THEN GOTO 120 : 'Do next measurement un-
                               : til a key is pressed
150 PRINT #1,CHR$(27)         : 'Send ESC character

```

QUERY SETUP

QS

Purpose:

To query the oscilloscope for its current setup.

This Query Setup (QS) command and the Program Setup (PS) command can be used together in order to retrieve and restore a complete or partial setup of the oscilloscope. Optionally a parameter can be added to the command to query a particular part of the setup. When this parameter is omitted, the complete setup is returned.

The response can be stored as an array of strings in the computer to be sent back later using the PS command. Each string that is received describes a setup node in the oscilloscope.

(Refer to Program Setup (PS) and section 8 SETUP)

Command:

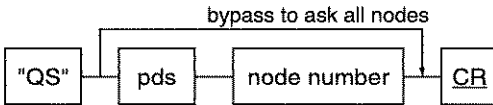

<node number> optional parameter, in decimal ASCII, to query only one setup node. Refer to section 8 SETUP for the setup node numbers.

Response:

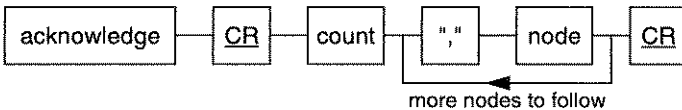

<count> number of strings to follow
 <node> string of hexadecimal characters representing a setup node in the oscilloscope.

Example:

(Complete setup query)

```

90 DIM SETUP$(11)           : 'Reserve space
100 PRINT #1, "QS"          : 'Send command
110 GOSUB 1000              : 'Sync on acknowledge
120 INPUT #1, N              : 'Read number of node strings
130 FOR I=1 TO N
140     INPUT #1, SETUP$(I)  : 'Read all node strings
150 NEXT I

```

example response: (PM3094)

```
11,0106hlhl.....,0206hlhl.....,0306hlhl.....CR **)
```

**) These SETUP\$ array elements can be stored and sent back later to the oscilloscope with the "PS" command.

(Optional setup query to read only one setup node)

```

100 PRINT #1, "QS";4        : 'Query setup node 4
110 GOSUB 1000              : 'Sync on acknowledge
120 INPUT #1, N              : 'Read number of setup nodes
130 INPUT #1, SETUP$        : 'Read the setup node

```

QUERY TEXT

QT

Purpose:

To query text from an oscilloscope.

If the **S** parameter is specified, setup text is returned. The text will be queried from one of the setup registers of the oscilloscope. The parameter **n** specifies the setup register. A text field of 22 characters is returned.

If the **S** parameter is not specified, user text is returned. The text will be queried from the screen of the oscilloscope. A text field of 64 characters is returned. The parameter **n** may not be used.

The queried text can be programmed again with the Program Text (PT) command.

Command:

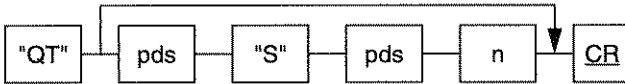

- "S" setup text of register n will be returned; if "S" and n are left out, user text is returned
- n one of the setup registers, ranging from 0 to 10; n=0 selects the current setup

Response:



char a character byte; range = 15 to 127 (refer to character code table E.1)

Example: (of user text)

Read the user text from the screen of an oscilloscope:

```
90 DIM USERTXT$ (64)
100 PRINT #1, "QT"           : 'Query user Text command
110 GOSUB 1000               : 'Sync on acknowledge
120 LINE INPUT #1, USERTXT$ : 'Read text characters
130 PRINT USERTXT$          : 'Print user text
```

The text on the screen of the oscilloscope will be printed, e.g.:
Measurement 15

Example: (of setup text)

Read the text from setup register 7 of an oscilloscope:

```
90 DIM SETUP$ (22)
100 PRINT #1, "QT S 7"      : 'Query setup Text command
110 GOSUB 1000               : 'Sync on acknowledge
120 LINE INPUT #1, SETUP$   : 'Read text characters
130 PRINT SETUP$            : 'Print setup text
```

The text in setup register 7 of the oscilloscope will be printed, e.g.:
1.25 k Ω (CH1)

RESET INSTRUMENT

RI

Purpose:

Resets all of the software of the oscilloscope, including the CPL protocol handler and all of the input and output buffers. Oscilloscope settings remain the same. Interface parameters are not changed in order to keep the communication alive.

When the Reset has been completed the oscilloscope responds with an <acknowledge>.

There is no frontpanel equivalent for this command.

Command:



Response:

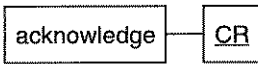

Note: <acknowledge> will be sent after the Reset has been completed

Example:

```

100 PRINT #1, "RI"      : 'Send command
110 GOSUB 1000          : 'Sync on acknowledge
  
```

RECALL SETUP

RS

Purpose:

To recall an internally stored setup from one of 10 setup registers. This setup must have been stored in the oscilloscope manually or with the Save Setup (SS) command.

The command performs the same as the frontpanel key SETUPS together with the softkey RECALL.

Command:

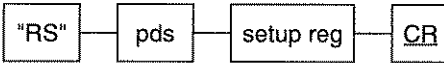

<setup reg> represents the setup register number ranging from 1...10

Response:

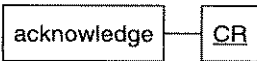

Note: <acknowledge> will be sent after the internal setup has been completed.

Example:

```

100 PRINT #1,"RS";5      : 'Recall setting 5
110 GOSUB 1000           : 'Sync on acknowledge
  
```

SAVE SETUP**SS****Purpose:**

To save the current oscilloscope setup in one of 10 internal setup registers. This setup can be recalled manually or by sending the Recall Setup (RS) command.

The command performs the same as the frontpanel key SETUPS together with the softkey SAVE. An execution error will be returned if the setup register is write protected.

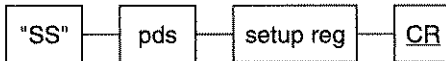
Command:

<setup reg> represents the setup register number, ranging from 1 ... 10

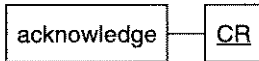
Response:**Example:**

```

100 PRINT #1,"SS";3      : 'Save setup in reg 3
110 INPUT#1,ACK         : Sync on acknowledge
  
```

STATUS

ST

Purpose:

To obtain a more detailed status report. The response gives more information about the conditions, causing a wrong acknowledge.

The status is returned as one or more signed decimal integers. Each bit of the equivalent 16-bit binary status word represents a status condition. If a bit is set, the corresponding status event has occurred. The 16-th (sign) bit of a status word indicates that another status word follows.

After the reply, the value of the status is reset to zero. The complete description of the status word can be found in section 7 (STATUS).

The function of the front panel key STATUS has no relation with this ST command.

Command:

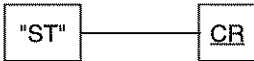

Response:

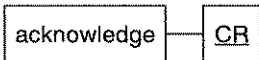

when acknowledge=0 followed by:

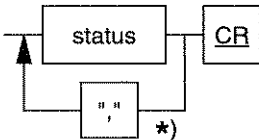

<status> = signed integer,
between -32768 ... 32767

*) when status is negative

Example:

```
100 PRINT #1, "ST"           : 'Send command
110 GOSUB 1000                : 'Sync on acknowledge
120 INPUT #1, STATUS         : 'Read Status word
130 GOSUB 2000               : 'Display Status *)
140 IF STATUS < 0 THEN GOTO 120 : 'Fetch next status
```

example status:

6CR (= 00000000000000110 in binary)

which means: (because bit 2 and bit 1 are set)

- data out of range and
- data format of the body is wrong

*) See section 7 (STATUS) for program example.

6 ACKNOWLEDGE

The <acknowledge> is a synchronization reply that is returned after each command sent to the oscilloscope, signalling correct or incorrect operation:

"0"	Ok, normal situation
"1"	Syntax error (ST query may give more info)
"2"	Execution error (ST query may give more info)
"3"	Synchronization error
"4"	Communication error

Explanation and examples of the errors:

Syntax Error:

returned when the command is not understood by the oscilloscope for one of the following reasons:

- * Unknown header, wrong instructions
- * Data format of body is wrong, e.g. alpha characters when decimal data expected

Execution Error:

returned when internal processing is not possible:

- * Data out of (internal) range
- * Conflicting oscilloscope settings

Synchronization Error:

returned when the oscilloscope receives a new command while it is still executing the previous one:

- * a new command is sent without waiting for the <acknowledge> synchronization.

Communication Error:

returned when any framing, parity or overrun error occurs in the received data.

When an error is detected during the execution of the command:

- the oscilloscope sends an <acknowledge>,
- the oscilloscope terminates further execution of the command and returns to the idle state,
- the oscilloscope is then ready for a new command.

7 STATUS

The Status word gives more information when the acknowledge is non- zero. A certain bit in the word can be found by performing a logical AND of the status word with the mask defined below.

(Logical AND: the words are compared bitwise and only when both bits are 1, the result bit is 1)

Example:

Status = 38 and must be checked for 'data out of range' (4)

```

38   = 0000 0000 0010 0110
4    = 0000 0000 0000 0100
logical AND 0000 0000 0000 0100

```

Bit Position	Mask hex	Value dec	Meaning
0	&H0001	1	Unknown header
1	&H0002	2	Data format of body is wrong
2	&H0004	4	Data out of range
3	&H0008	8	-- reserved, normally zero
4	&H0010	16	-- reserved, normally zero
5	&H0020	32	Invalid number of parameters
6	&H0040	64	Wrong number of databits
7	&H0080	128	-- reserved, normally zero
8	&H0100	256	-- reserved, normally zero
9	&H0200	512	Conflicting oscilloscope settings
10	&H0400	1024	User request, front panel key pressed
11	&H0800	2048	-- reserved, normally zero
12	&H1000	4096	-- reserved, normally zero
13	&H2000	8192	-- reserved, normally zero
14	&H4000	16384	-- reserved, normally zero
15	&H8000	32768	Next status available

Example program to investigate status:

```
2000 PRINT "STATUS IS: ";STATUS
2010 PRINT "MEANING: ";
2020 IF (STATUS AND 0x0001) > 0 THEN PRINT "UNKNOWN HEADER"
2030 IF (STATUS AND 0x0002) > 0 THEN PRINT "WRONG DATA FORMAT"
2040 IF (STATUS AND 0x0004) > 0 THEN PRINT "DATA OUT OF RANGE"
2050 IF (STATUS AND 0x0020) > 0 THEN PRINT "INVALID # PARAMS"
2060 IF (STATUS AND 0x0040) > 0 THEN PRINT "WRONG # DATABITS"
2070 IF (STATUS AND 0x0200) > 0 THEN PRINT "CONFLICT SETTING"
2080 IF (STATUS AND 0x0400) > 0 THEN PRINT "USER REQUEST"
2090 IF (STATUS AND 0x8000) > 0 THEN PRINT "MORE STATUS"
2100 RETURN
```

8 SETUP

The Query Setup (QS) and Program Setup (PS) commands can be used together in order to retrieve and restore a complete or partial setup of the oscilloscope.

When a setup is requested from the oscilloscope, it will send its setup as a sequence of strings. Each separate string describes a setup node. By adding a parameter to the QS command a particular setup node can be queried.

So the query program could be:

```
PRINT #1,"QS"      Complete setup
PRINT #1,"QS",4   Only node 4 (channel 4 settings)
PRINT #1,"QS",S   Only node S, where S must be one of the
                  values specified below.
```

Node numbers can have the following values:

hex	dec	meaning
01	1	Channel 1 settings
02	2	Channel 2 settings
03	3	Channel 3 settings
04	4	Channel 4 settings
		(nodes above: attenuator, display on/off, coupling DC/AC, GND, invert, 50ohm/1Mohm, continuous(var)/discrete, position control)
0F	15	Common vertical settings (add 1+2, add 3+4, alt/chop, bandwidth limiter on/off)
10	16	Common horizontal settings (X-deflection on/off, mode auto/trig/single, X-deflection source, magnify *10/*1, X-position.
11	17	Main Timebase settings (timebase speed, triggering edge/TV, MTBI on/off, MTB on/off, trigger slope pos/neg, TV trigger F1/F2/line, noise suppression on/off, continuous(var)/discrete, level-pp on/off, trigger source, trigger coupling, TV trigger normal/hdtv)
12	18	Delayed Timebase settings (timebase speed, trigger mode edge/tv, DTB on/off, edge trigger slope pos/neg, edge trigger source, trigger coupling)

20	32	Cursor settings (V cursors on/off, T cursors on/off, rise time on/off, control V/T, Vpp on/off, rise time 10-90/20-80, readout Vpp/V+V-, cursors on/off, V readout delta/absolute/ratio, T readout delta/1/delta/ratio/phase, channel)
50	80	Display settings (settings display on/off, ground level indicator on/off, trigger level indicator on/off, status view on/off)
51	81	Trace intensity settings
60	96	Setup label test
F0	240	Special node for service purposes

It is NOT necessary to send all strings to the oscilloscope, when a setting must be changed.

Applications: the setup nodes for different timebase settings can be stored separately. They can be used afterwards as fixed 'templates' to change only the oscilloscope timebase setup.

The layout of each setup node string is:

```
nnllxxxxxx.....xx
```

where all characters are in the hexadecimal range (0..9,A..F).

Each pair forms the hexa-decimal representation of a byte, in high-low order (eg. hex:2A = bin:00101010 = dec:42)

nn the setup node number
 ll the number of bytes in the setup node
 (each byte is represented by two characters)
 xx the actual setup node

9 RS-232

The Null-modem cable used between the oscilloscope and the computer may have the following connections:

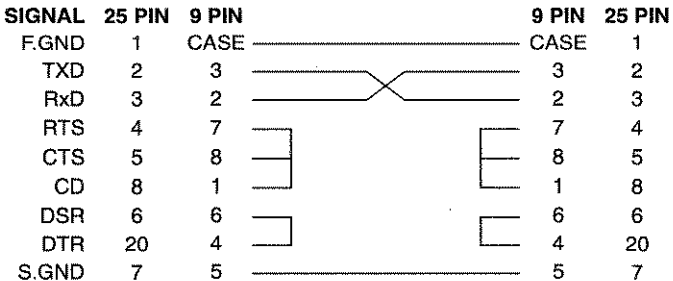
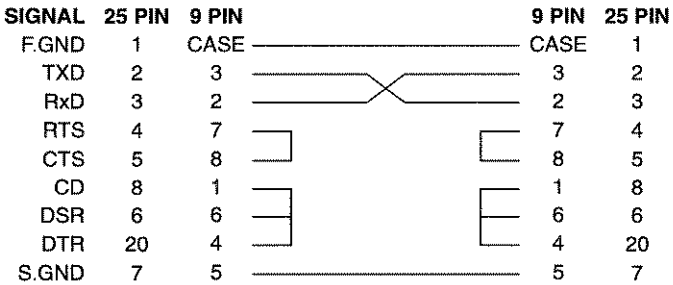
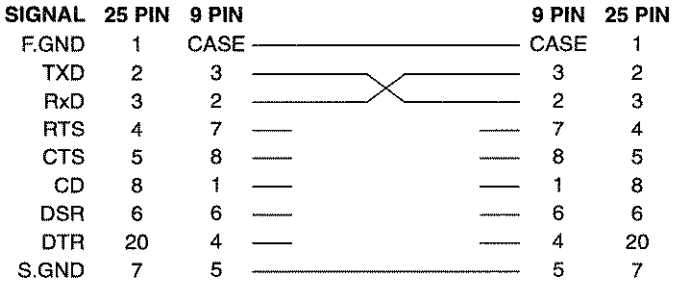

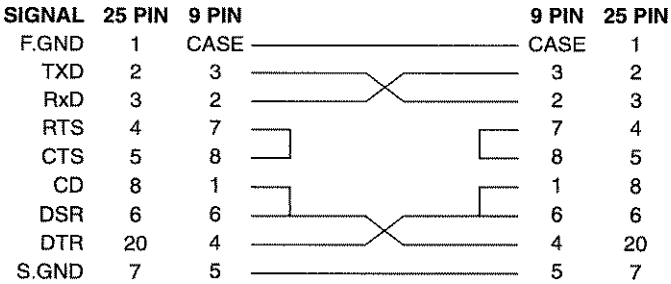
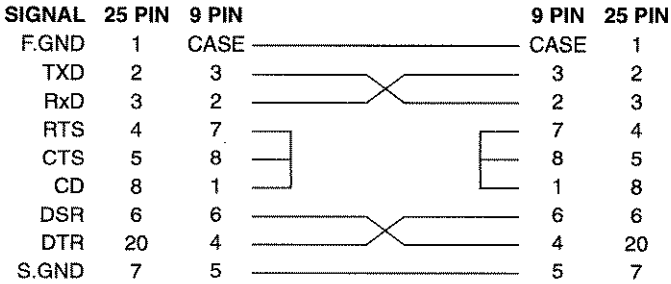

FUNCTION INDEX

ADD INVERT SUBTRACT
ALT CHOP
AUTOSET
AUTOSET USERPROG

BANDWIDTH LIMITER

CALIBRATION AUTOCAL
CONFIDENCE CHECK
CURSORS TIME/VOLT/BOTH
CURSOR MODE V_{pp}
CURSOR READOUT
 TIME/VOLT/BOTH/ V_{pp}
CURSORS X-DEFLECTION

DTB

INPUT ATTENUATOR
INPUT COUPLING
INPUT IMPEDANCE

MAGN
MTB TIME/DIV

POSITION
POWER SUPPLY

PROBE UTILITIES

REMOTE CONTROL IEEE 488.2
REMOTE CONTROL RS-232

SCREEN CONTROLS & GRATICULE
SCREEN MESSAGES
SETUPS
SETUPS SEQUENCE
STANDARD SETUP
STATUS SCREEN

TB MODE MTB
TEXT OFF
TRIGGER COUPLING
TRIGGER DTB
TRIGGER LEVEL
TRIGGER MTB
TV TRIGGER MTB/DTB

USERTEXT
UTILITY MENU
UTILITY SCREEN & SOUND
UTILITY MAINTENANCE

X-DEFLECTION

Entry	Refer to chapter/function	Page
1 M Ω	5 / INPUT IMPEDANCE	5-23
10x MAGN	5 / MAGN.	5-24
3-wire 7-wire	5 / REMOTE CONTROL RS-232	5-29
50 Ω	5 / INPUT IMPEDANCE	5-23
ac	5 / INPUT COUPLING	5-22
Accessories	INITIAL INSPECTION	V
Add	5 / ADD INVERT SUBTRACT	5-2
Address IEEE 488.2	5 / REMOTE CONTROL IEEE 488.2	5-28
ALT	5 / ALT/CHOP	5-3
Alternate	5 / ALT/CHOP	5-3
Ampl/div	5 / INPUT ATTENUATOR	5-21
AMPL/VAR	5 / INPUT ATTENUATOR	5-21
Attenuator	5 / INPUT ATTENUATOR	5-21
auto level	5 / TRIGGER LEVEL	5-47
Auto	5 / TB MODE MTB.	5-40
Autocalibration	5 / CALIBRATION AUTOCAL	5-8
AUTOSET	5 / AUTOSET	5-4
AUTOSET	5 / AUTOSET USERPROG	5-5
Autoset Userprog	5 / AUTOSET	5-4
Bandwidth limit	5 / BANDWIDTH LIMITER	5-7
Battery backup	5 / POWER SUPPLY	5-26
Beep	5 / UTILITY SCREEN & SOUND	5-55
BWL	5 / BANDWIDTH LIMITER	5-7
CAL signal	4.2	4-7
CAL-key	5 / CALIBRATION AUTOCAL	5-8
CH1 ... CH4	5 / INPUT ATTENUATOR	5-21
CH1+CH2	5 / ADD INVERT SUBTRACT	5-2
CH3+CH4	5 / ADD INVERT SUBTRACT	5-2
Channel selection	5 / INPUT COUPLING	5-22
Characteristics	1. REFERENCE MANUAL	
CHOP	5 / ALT/CHOP	5-3
Chopped	5 / ALT/CHOP	5-3
Clear setups	5 / SETUPS	5-35
Click	5 / UTILITY SCREEN & SOUND	5-55
COMP trig	5 / TRIGGER MTB.	5-48
Coupling	5 / INPUT COUPLING	5-22
Cover	2.3	2-3
CPL prog language	5 / REMOTE CONTROL RS-232	5-29
CRT control	5 / SCREEN CONTROLS AND GRATICULE	5-31
Cursor readout	5 / CURSORS READOUT	5-15
Cursor control	5 / CURSORS	5-10
Cursors general	5 / CURSORS	5-10
Cursors X-deflection mode	5 / CURSORS X-DEFL	5-18

CURSORS	5 / CURSORS	5-10
Data	5 / REMOTE CONTROL RS-232	5-29
dc	5 / INPUT COUPLING	5-22
Delay time	5 / DTB	5-19
DELAY	5 / DTB	5-19
Differential mode	5 / ADD INVERT SUBTRACT	5-2
Display control	5 / SCREEN CONTROLS AND GRATICULE	5-31
Display Layout	4.2	4-6
Display mode	5 / ALT/CHOP	5-3
DTB delay	5 / DTB	5-19
DTB intensity	5 / UTILITY SCREEN & SOUND	5-55
dtb	5 / DTB	5-19
DTB Time/div	5 / DTB	5-19
DTB triggering	5 / TRIGGER DTB	5-45
DTB	5 / DTB	5-19
Edge triggering	5 / TRIGGER MTB	5-48
Edit user text	5 / USERTEXT	5-52
Error	5 / SCREEN MESSAGES	5-33
F1	5 / TV TRIGGER MTB/DTB	5-50
F2	5 / TV TRIGGER MTB/DTB	5-50
Field 2	5 / TV TRIGGER MTB/DTB	5-50
Field 1	5 / TV TRIGGER MTB/DTB	5-50
FOCUS	5 / SCREEN CONTROLS AND GRATICULE	5-31
Frequency	5 / CURSORS READOUT	5-15
Front panel layout	4.1	4-2
Front cover	2.3	2-3
Front setups	5 / SETUPS SEQUENCE	5-37
GND Level indicators	5 / INPUT COUPLING	5-22
GND	5 / INPUT COUPLING	5-22
GND IND	5 / UTILITY SCREEN & SOUND	5-55
GRATICULE ILLUMINATION	5 / SCREEN CONTROLS AND GRATICULE	5-31
Graticule	5 / SCREEN CONTROLS AND GRATICULE	5-31
Ground level indicators	5 / UTILITY SCREEN & SOUND	5-55
Handle adjustment	2.4	2-4
HDTV	5 / TV TRIGGER MTB/DTB	5-50
hf-rej(ect)	5 / TRIGGER COUPLING	5-43
Hint	5 / SCREEN MESSAGES	5-33
HOLD OFF	5 / TB MODE MTB	5-40
HOR MODE	5 / TB MODE MTB	5-40
Horizontal mode	5 / TB MODE MTB	5-40
Horizontal deflection	5 / MTB TIME/DIV	5-25
Horizontal Mode DTB	5 / DTB	5-19

IEEE 488.2 programming	5 / REMOTE CONTROL IEEE 488.2	5-28
IEEE 488.2 connector	5 / REMOTE CONTROL IEEE 488.2	5-28
ILLUMination	5 / SCREEN CONTROLS AND GRATICULE	5-31
Incoming inspection	3, 4, REFERENCE MANUAL	
Initialization	5 / STANDARD SETUP	5-38
input	5 / INPUT ATTENUATOR	5-21
Input coupling	5 / INPUT COUPLING	5-22
Input impedance	5 / INPUT IMPEDANCE	5-23
Instrument positions	2.4	2-4
Intensified Mode	5 / DTB	5-19
Intensity ratio MTB/DTB	5 / UTILITY SCREEN & SOUND	5-55
Intensity modulation	5 / SCREEN CONTROLS AND GRATICULE	5-31
Intensity	5 / SCREEN CONTROLS AND GRATICULE	5-31
INV	5 / ADD INVERT SUBTRACT	5-2
Invert	5 / ADD INVERT SUBTRACT	5-2
Key click	5 / UTILITY SCREEN & SOUND	5-55
LEVEL DTB	5 / TRIGGER LEVEL	5-47
LEVEL MTB	5 / TRIGGER LEVEL	5-47
level-pp	5 / TRIGGER LEVEL	5-47
lf-rej(ect)	5 / TRIGGER COUPLING	5-43
Line connection	5 / POWER SUPPLY	5-26
Line trig	5 / TRIGGER MTB	5-48
line	5 / TV TRIGGER MTB/DTB	5-50
Local	5 / REMOTE CONTROL RS-232	5-29
Local	5 / REMOTE CONTROL IEEE 488.2	5-28
Mains triggering	5 / TRIGGER MTB	5-48
MANUAL CALIBRation	5 / UTILITY MAINTENANCE	5-56
Measuring grid	5 / SCREEN CONTROLS AND GRATICULE	5-31
Messages	5 / SCREEN MESSAGES	5-33
mtb	5 / DTB	5-19
MTB time/div	5 / MTB TIME/DIV	5-25
MTB intensify	5 / UTILITY SCREEN & SOUND	5-55
MTB/VAR	5 / MTB TIME/DIV	5-25
mtbi	5 / DTB	5-19
mtbi+dtb	5 / DTB	5-19
Multi-channel display	5 / ALT/CHOP	5-3
neg	5 / TV TRIGGER MTB/DTB	5-50
noise	5 / TRIGGER COUPLING	5-22
Noise suppression	5 / BANDWIDTH LIMITER	5-7
Noisy input signal	5 / BANDWIDTH LIMITER	5-7
NOT TRIG'D	5 / TB MODE MTB	5-40
NTSC	5 / TV TRIGGER MTB/DTB	5-50

on off Vpp	5 / CURSORS	5-10
ON	5 / INPUT COUPLING	5-22
Packing list	INITIAL INSPECTION	V
PAL	5 / TV TRIGGER MTB/DTB	5-50
Parity	5 / REMOTE CONTROL RS-232	5-29
Password	5 / UTILITY MAINTENANCE	5-56
Peak-peak level	5 / TRIGGER LEVEL	5-47
peak-peak measurement	5 / CURSOR MODE Vpp	5-13
Phase 360°	5 / CURSORS READOUT	5-15
Pin hole	5 / UTILITY MAINTENANCE	5-56
POS	5 / POSITION	5-26
pos	5 / TV TRIGGER MTB/DTB	5-50
Position	5 / POSITION	5-26
Power triggering	5 / TRIGGER MTB	5-48
Power connection	5 / POWER SUPPLY	5-26
POWER ON/OFF	5 / POWER SUPPLY	5-26
Power-on test	5 / CONFIDENCE CHECK	5-9
Probe calibration	4.2	4-7
Probe attenuation	5 / PROBE UTILITIES	5-27
Probe adjustment	4.2	4-7
Probe switch	5 / PROBE UTILITIES	5-27
Probe correction	5 / PROBE UTILITIES	5-27
Probe	5 / PROBE UTILITIES	5-27
Protect setups	5 / SETUPS	5-35
Ratio 100 %	5 / CURSORS READOUT	5-15
Readout settings	5 / TEXT OFF	5-42
Readout	5 / STATUS SCREEN	5-39
Readout cursors	5 / CURSORS READOUT	5-15
Recall setups	5 / SETUPS	5-35
Remote control	5 / REMOTE CONTROL IEEE 488.2	5-28
Remote control	5 / REMOTE CONTROL RS-232	5-29
REPAIR TOOLS	5 / UTILITY MAINTENANCE	5-56
Rise time	5 / CURSOR MODE Vpp	5-13
Risetime measurement	5 / SCREEN CONTROLS AND GRATICULE	5-31
RS-232 connector	5 / REMOTE CONTROL RS-232	5-29
RS-232 programming	5 / REMOTE CONTROL RS-232	5-29
Save setups	5 / SETUPS	5-35
SCPI prog language	5 / REMOTE CONTROL IEEE 488.2	5-29
Screen layout	4.2	4-6
Screen information	5 / STATUS SCREEN	5-39
SCREEN CALIBRation	5 / UTILITY MAINTENANCE	5-56
Screen text	5 / USERTEXT	5-52
Screen messages	5 / SCREEN MESSAGES	5-33
SECAM	5 / TV TRIGGER MTB/DTB	5-50

SELFTEST	5 / UTILITY MAINTENANCE	5-56
Sensitivity	5 / INPUT ATTENUATOR	5-21
Sequence	5 / SETUPS SEQUENCE	5-37
Setting readout	4.2	4-6
Settings information	5 / STATUS SCREEN	5-39
SETUPS	5 / SETUPS	5-35
	5 / SETUPS SEQUENCE	5-37
	5 / STANDARD SETUP	5-38
Shift	5 / POSITION	5-26
Single	5 / TB MODE MTB	5-40
SINGLE RESET	5 / TB MODE MTB	5-40
Softkey menu off	5 / TEXT OFF	5-42
Sound	5 / UTILITY SCREEN & SOUND	5-55
Specifications	1	REFERENCE MANUAL
Standard settings	5 / STANDARD SETUP	5-38
Standard setting	5 / SETUPS	5-35
Starts	5 / TRIGGER DTB	5-45
STATUS	5 / STATUS SCREEN	5-39
Std	5 / STANDARD SETUP	5-38
Std	5 / SETUPS	5-35
Subtract	5 / ADD INVERT SUBTRACT	5-2
TEXT INTENSITY	5 / SCREEN CONTROLS AND GRATICULE	5-31
TEXT OFF	5 / TEXT OFF	5-42
Text on screen	5 / USERTEXT	5-52
Time cursors	5 / CURSORS	5-10
Time/div MTB	5 / MTB TIME/DIV	5-25
Time/div DTB	5 / DTB	5-19
Timebase selection	5 / MTB TIME/DIV	5-25
Timebase expansion	5 / MAGN.	5-24
Timebase magnifier	5 / MAGN.	5-24
Trace alignment	5 / SCREEN CONTROLS AND GRATICULE	5-31
TRACE INTENSITY	5 / SCREEN CONTROLS AND GRATICULE	5-31
TRACE ROTATION	5 / SCREEN CONTROLS AND GRATICULE	5-31
TRACE SEPARATION	5 / DTB	5-19
TRACK and Δ	5 / CURSORS	5-10
TRIG IND	5 / UTILITY SCREEN & SOUND	5-55
	5 / TRIGGER COUPLING	5-43
Trig	5 / TB MODE MTB	5-40
TRIG1 ... TRIG4	5 / TRIGGER MTB	5-48
Trigger level	5 / TRIGGER LEVEL	5-47
Trigger level indicators	5 / TRIGGER LEVEL	5-47
Trigger source	5 / TRIGGER MTB	5-48
Trigger Mode	5 / TRIGGER MTB	5-48
Trigger slope	5 / TRIGGER MTB	5-48
TRIGGER MTB	5 / TRIGGER MTB	5-48
Trigger level indicators	5 / UTILITY SCREEN & SOUND	5-55

Trigger coupling	5 / TRIGGER COUPLING	5-43
Trigger DTB	5 / TRIGGER DTB	5-45
Trise	5 / CURSOR MODE Vpp	5-13
TV triggering	5 / TV TRIGGER MTB/DTB	5-50
TV line	5 / TV TRIGGER MTB/DTB	5-50
Unaffected	5 / AUTOSET USERPROG.	5-5
Undo	5 / SETUPS	5-35
Unstable triggering	5 / TB MODE MTB	5-40
Unstable triggering	5 / TRIGGER COUPLING	5-43
Userprog	5 / AUTOSET USERPROG.	5-5
USERTEXT	5 / USERTEXT	5-52
Util autose	5 / AUTOSET USERPROG.	5-5
Util autose	5 / AUTOSET	5-4
Util autose menu	5 / AUTOSET USERPROG.	5-5
Util maintenance	5 / UTILITY MAINTENANCE.	5-56
Util probe	5 / PROBE UTILITIES.	5-27
UTIL SCREEN SETUP	5 / UTILITY SCREEN & SOUND	5-55
UTIL menu general	5 / UTILITY MENU	5-54
V1&V2	5 / CURSORS READOUT.	5-15
VAR	5 / INPUT ATTENUATOR	5-21
VAR (MTB)	5 / MTB TIME/DIV	5-25
Vdc	5 / CURSOR MODE Vpp	5-13
Vertical display	5 / ALT/CHOP	5-3
Volt cursors	5 / CURSORS.	5-10
Vp-&Vp+	5 / CURSORS READOUT.	5-15
Vpp cursors	5 / CURSOR MODE Vpp	5-13
Warning	5 / SCREEN MESSAGES	5-33
X POS	5 / POSITION	5-26
X-DEFL	5 / X-DEFLECTION.	5-57
X-deflection cursors	5 / CURSORS X-DEFL	5-18
XON-XOFF	5 / REMOTE CONTROL RS-232	5-29
Z-MOD	5 / SCREEN CONTROLS AND GRATICULE	5-31
Z-modulation	5 / SCREEN CONTROLS AND GRATICULE	5-31

