

Programmable Automatic RCL Meter

PM6306

Users Manual

4822 872 10141

May 1996, Rev. 2, 02/99

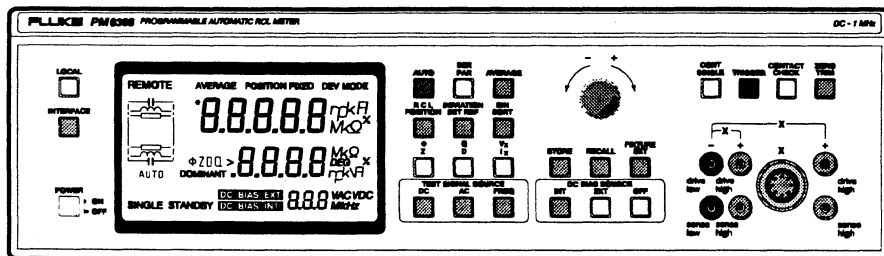

FLUKE®

Please note

In correspondence concerning this instrument, please quote the type number and serial number as given on the type plate.

Bitte beachten

Bei Schriftwechsel über dieses Gerät wird gebeten, die Typennummer und die Gerätenummer anzugeben. Diese befinden sich auf dem Typenschild an der Rückseite des Gerätes.

Noter s.v.p.

Dans votre correspondance et dans vos réclamations se rapportant à cet appareil, veuillez toujours indiquer le numéro de type et le numéro de série qui sont marqués sur la plaquette de caractéristiques.

Important

As the instrument is an electrical apparatus, it may be operated only by trained personnel. Maintenance and repairs may also be carried out only by qualified personnel.

Wichtig

Da das Gerät ein elektrisches Betriebsmittel ist, darf die Bedienung nur durch eingewiesenes Personal erfolgen. Wartung und Reparatur dürfen nur von geschultem, fach- und sachkundigem Personal durchgeführt werden.

Important

Comme l'instrument est un équipement électrique, le service doit être assuré par du personnel qualifié. De même, l'entretien et les réparations sont à confier aux personnes suffisamment qualifiées.

INSIDE THIS MANUAL

This USERS MANUAL contains information on all features of the PM6306 instrument.

It starts with a shipment note and an initial inspection.

The manual is organized into the following chapters:

Chapter 1 Installation and Safety Instructions

This chapter should be read before unpacking, installing, and operating the instrument. It describes grounding, power cables, and line voltage settings.

Chapter 2 Main Features

This chapter describes the main features of the instrument, its functions, operation modes, measurement possibilities and its options.

Chapter 3 Getting Started

This chapter starts with general procedures and precautions necessary for operation followed by a short functional test. It contains a description of the display, a summary of controls and connectors on the front and rear panels, and a description of accessories and measurement setups.

Chapter 4 How to Use the Instrument

This chapter provides the user with detailed explanations of the measurement principle and the measurement of different components.

Chapter 5 Function Reference

This chapter contains a description of each function in alphabetical order. Each description includes an explanation of local and remote control functions.

Chapter 6 Appendix

- A Characteristics
- B Performance Test
- C Preventive Maintenance / Self Diagnostic
- D Figures

Chapter 7 Installation and Safety Instructions in Foreign Languages

- Instrucciones de instalación y de seguridad (E)
- Istruzioni per la messa in funzione e norme di sicurezza (I)
- Instructies met betrekking tot de installatie en veiligheid (NL)
- Inledande anvisningar och säkerhetsanvisningar (S)

Chapter 8 Index

Limited Warranty & Limitation of Liability

Declaration of Conformity

Service Centres

CONTENTS

	Page
SHIPMENT NOTE AND INITIAL INSPECTION	
1 INSTALLATION AND SAFETY INSTRUCTIONS	1 – 1
1.1 SAFETY INSTRUCTIONS	1 – 1
1.1.1 Maintenance and Repair	1 – 1
1.1.2 Grounding (Earthing)	1 – 2
1.1.3 Connections	1 – 2
1.1.4 Line Voltage Setting and Fuses	1 – 3
1.2 OPERATING POSITION OF THE INSTRUMENT	1 – 4
1.3 RADIO INTERFERENCE SUPPRESSION	1 – 4
2 MAIN FEATURES	2 – 1
3 GETTING STARTED	3 – 1
3.1 GENERAL INFORMATION	3 – 1
3.2 TURNING THE INSTRUMENT ON	3 – 1
3.3 SELF-TEST ROUTINE	3 – 2
3.4 BRIEF CHECKING PROCEDURE	3 – 2
3.5 OPERATION AND APPLICATION	3 – 7
3.5.1 Control Elements, Display, and Connections	3 – 7
3.5.2 Measurement Setup and Accessories	3 – 16
4 HOW TO USE THE INSTRUMENT	4 – 1
4.1 THE PRINCIPLE OF MEASUREMENT	4 – 1
4.2 MEASURING COMPONENTS	4 – 10
4.2.1 Test Signal Frequency and Voltage	4 – 10
4.2.2 Resistors	4 – 11
4.2.3 Capacitors	4 – 12
4.2.4 Inductances	4 – 14
4.3 AUTOMATIC ZERO TRIM	4 – 15
4.4 CONTACT CHECK	4 – 22

4.5	MEASURING MODES	4 - 23
4.5.1	Automatic (AUTO)	4 - 23
4.5.2	Manual	4 - 25
4.5.3	Combination of Measuring Modes	4 - 31
4.6	MEASUREMENT ACCURACY	4 - 32
4.7	OUT-OF-RANGE AND ERROR MESSAGES	4 - 38
4.8	STORE/RECALL INSTRUMENT SETTINGS	4 - 40
4.9	BIN SORT (BINNING)	4 - 41
4.10	HANDLER INTERFACE, PM 9566	4 - 46
5	FUNCTION REFERENCE	5 - 1

APPENDICES

6A	CHARACTERISTICS	6A - 1
6A.1	SAFETY AND EMC REQUIREMENTS	6A - 1
6A.2	PERFORMANCE SPECIFICATION	6A - 2
6A.3	POWER SUPPLY	6A - 16
6A.4	ENVIRONMENTAL CONDITIONS	6A - 17
6A.5	SAFETY & QUALITY DATA; CABINET	6A - 19
6A.6	OPTIONS, ACCESSORIES	6A - 20
6B	PERFORMANCE TEST	6B - 1
6B.1	INTRODUCTION	6B - 1
6B.2	RECOMMENDED TEST EQUIPMENT	6B - 1
6B.3	SELF-TEST ROUTINE	6B - 3
6B.4	PERFORMANCE VERIFICATION	6B - 3
6B.4.1	Test Signal Voltage	6B - 3
6B.4.2	Internal DC Bias Voltage	6B - 4
6B.4.3	Test Signal Frequency	6B - 5
6B.4.4	AC Measurements	6B - 5
6B.4.5	DC Measurements	6B - 10

6C	PREVENTIVE MAINTENANCE / SELF DIAGNOSTIC	6C - 1
6C.1	GENERAL INFORMATION	6C - 1
6C.2	SELF DIAGNOSTIC	6C - 1
6C.3	RECALIBRATION	6C - 9
6D	FIGURES	6D - 1
Fig. 1	Front view	6D - 1
Fig. 2	Rear view	6D - 1
Fig. 3	PM 9540/TWE, SMD Tweezers	6D - 2
Fig. 4	PM 9541A, 4-wire test cable	6D - 2
Fig. 5	Single and double test posts	6D - 2
Fig. 6	PM 9542SMD, SMD Adapter	6D - 2
Fig. 7	PM 9542A, RCL Adapter	6D - 2

INSTALLATION AND SAFETY INSTRUCTIONS IN FOREIGN LANGUAGES

7	INSTRUCCIONES DE INSTALACION Y DE SEGURIDAD	(E)
7.1	INSTRUCCIONES DE SEGURIDAD	7 - 1
7.1.1	Reparación y mantenimiento	7 - 1
7.1.2	Puesta a tierra	7 - 2
7.1.3	Contactos y conexiones	7 - 2
7.1.4	Ajuste de la tensión de la red y fusibles	7 - 3
7.2	POSICION DE FUNCIONAMIENTO DEL APARATO	7 - 4
7.3	SUPRESION DE INTERFERENCIAS	7 - 4
7	ISTRUZIONI PER LA MESSA IN FUNZIONE E NORME DI SICUREZZA	(I)
7.1	NORME DI SICUREZZA	7 - 5
7.1.1	Riparazione e manutenzione	7 - 5
7.1.2	Messa a terra	7 - 6
7.1.3	Contatti e collegamenti	7 - 6
7.1.4	Predisposizione della tensione di aliment. e fusibili	7 - 7
7.2	POSIZIONE DI FUNZIONAM. DELL'APPARECCHIO	7 - 8
7.3	INTERFERENZE	7 - 8

7	INSTRUCTIES MET BETREKKING TOT DE INSTALLATIE EN VEILIGHEID	(NL)
7.1	VEILIGHEIDSINSTRUCTIES	7 - 9
7.1.1	Reparatie en onderhoud	7 - 9
7.1.2	Aarding	7 - 10
7.1.3	Aansluitingen en verbindingen	7 - 10
7.1.4	Netspanningsinstelling en zekeringen	7 - 11
7.2	GEBRUIKSPPOSITIE VAN HET APPARAAT	7 - 12
7.3	RADIO-ONTSTORING	7 - 12
7	INSTALLATIONSANVISNINGAR OCH SÄKERHETSFÖRESKRIFTER	(S)
7.1	SÄKERHETSFÖRESKRIFTER	7 - 13
7.1.1	Reparation och underhåll	7 - 13
7.1.2	Skyddsjordning	7 - 14
7.1.3	Anslutningar	7 - 14
7.1.4	Nätspänningsomkoppling och säkringar	7 - 15
7.2	DRIFTSLÄGE	7 - 16
7.3	RADIOAVSTÖRNING	7 - 16
8	INDEX	8 - 1

LIMITED WARRANTY & LIMITATION OF LIABILITY

DECLARATION OF CONFORMITY

SERVICE CENTRES

SHIPMENT NOTE

The following parts should be included in the shipment:

- 1 Fluke PM6306 Programmable Automatic RCL Meter DC – 1 MHz
- 1 Users Manual
- 1 Programmers Manual
- 1 Power Cable
- 2 Fuses
- 2 Single Test Posts

For built-in options, see the type plate on the rear panel:

Type plate

Type number
Code number
Serial number

FLUKE.		
TYPE :	PM6306/xxx	44VA
NC :	9452 063 06xxx	
NO :	LO	50-60Hz

Code number:
9452 063 06XXX

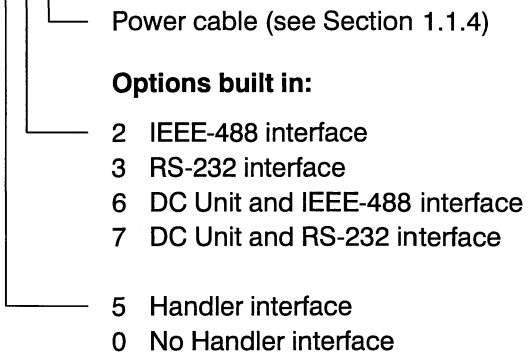

INITIAL INSPECTION

Check that the shipment is complete and note whether any damage has occurred during transport. If the contents are incomplete or there is damage, file a claim with the carrier immediately, and notify the Fluke Sales or Service organization to facilitate the repair or replacement of the instrument. The addresses are listed in the back of this manual.

The performance of the instrument can be tested by using the Performance Test in the Appendix of this manual.

Chapter **1**

INSTALLATION AND SAFETY INSTRUCTIONS

1 **INSTALLATION AND SAFETY INSTRUCTIONS**

1.1 **SAFETY INSTRUCTIONS**

Upon delivery from the factory the instrument complies with the required safety regulations (see Appendix, Section 6A). To maintain this condition and to ensure safe operation, carefully follow the instructions below.

1.1.1 **Maintenance and Repair**

Failure and excessive stress:

If the instrument is suspected of being unsafe, remove it from operation immediately and secure it against any unintended operation. The instrument is considered to be unsafe when any of the following conditions exist:

- It shows physical damage.
- It does not function.
- It is stressed beyond the tolerable limits (e.g., during storage and transportation).

Disassembling the Instrument:

WARNING

Calibration, maintenance, and repair of the instrument must be performed only by trained personnel who are aware of the hazards involved. To avoid electric shock, do not remove the cover unless you are qualified to do so.

Before removing the cover, disconnect the instrument from all power sources. The capacitors in the instrument may remain charged for several seconds after all power has been disconnected.

1.1.2 Grounding (Earthing)

Before any other connection is made, the instrument must be connected to a protective earth conductor via the three-wire power cable.

The power plug shall be inserted only into a grounded outlet.

Do not defeat the protective action by using an extension cord without a grounded conductor.

Do not connect a protective ground conductor into the measurement contacts on the front panel, the four contacts of the connector to which the circuit ground is applied, the external contact of the connector plug, or the connectors on the rear panel.

WARNING

Any interruption of the protective ground conductor inside or outside the instrument or disconnection of the protective ground terminal is likely to make the instrument dangerous. Intentional interruption is prohibited.

1.1.3 Connections

The circuit ground potential is applied to four of the eight contacts of the front panel connector and to the DC Bias (–) connector. It also is connected to the instrument case via parallel-connected capacitors and a resistor. The external contact of the front panel connector is connected to the instrument case. This avoids ac ground loops while providing good RF grounding.

If the circuit ground potential in a measurement setup is different from the protective ground potential, make sure that the contacts of the connectors are not live.

1.1.4 Line Voltage Setting and Fuses

Before plugging in the power cable, make sure that the instrument is set to the correct line voltage.

WARNING

To avoid injury or death, changing fuses and modifying power cables to local power must be done by qualified service personnel who are aware of the hazards involved.

On delivery from the factory, the instrument is set to one of the following line voltages:

Type	Code No.	Line Voltage	Delivered Power Cable
PM6306	9452 063 06xx1	220 V	Universal Europe
PM6306	9452 063 06xx3	120 V	North America
PM6306	9452 063 06xx4	240 V	England (U.K.)
PM6306	9452 063 06xx5	220 V	Switzerland
PM6306	9452 063 06xx8	240 V	Australia

The line voltage setting and the corresponding fuse specification are indicated on the rear panel.

Make sure that replacement fuses are of the type and current rating specified. The use of repaired fuses and/or the short-circuiting of fuse holders are prohibited. Do not defeat this important safety feature.

The instrument can be set to the following line voltages: 100 V, 120 V, 220 V and 240 V ac. These nominal voltages can be selected by means of the voltage selector, located on the rear panel next to the line voltage connector. The fuse is located in a holder at the same place. For line voltage selection or replacement of the fuse, remove the power cable and pry open the compartment with a small screwdriver (see illustration).

Turn the selector to select the appropriate voltage range. If necessary, insert the specified fuse (T250mA or T500mA according to IEC127 or CSA/UL198G) that matches the line voltage setting into the fuse holder.

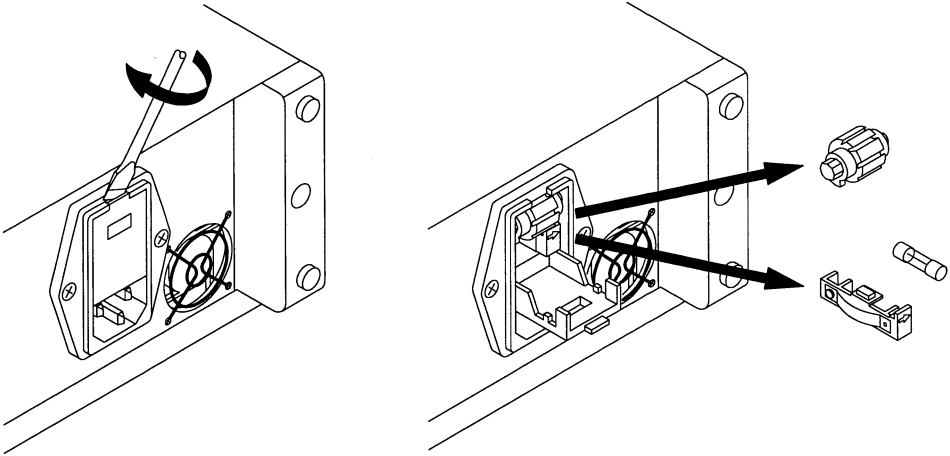

1.2 OPERATING POSITION OF THE INSTRUMENT

The instrument can be operated on a horizontal surface in a flat position or with the tilt bale extended. Ensure that the ventilation holes are free of obstruction. Do not position the instrument in direct sunlight or on any surface that produces or radiates heat.

1.3 RADIO INTERFERENCE SUPPRESSION

Radio interference of the instrument is suppressed and checked carefully. If radio frequency interferences occur in connection with other deficient suppressed instruments, further suppression actions may be required.

Chapter **2**

MAIN FEATURES

2 MAIN FEATURES

The **PM6306 Programmable Automatic RCL Meter** is used for precise measurements of resistance, capacitance, and inductance. Its basic accuracy is 0.1 %. The instrument provides an autofunction and autoranging feature. It allows fast and high precision measurements and diagnostic of passive components over a wide range.

The component to be measured is connected to the instrument via front panel test posts, the PM 9541A four-wire test cable, or the PM 9542A four-terminal test adapter. The Adapter PM 9542SMD or the PM 9540/TWE SMD Tweezers for surface-mounted components are also available.

Measurements are performed using a four-wire system.

The test frequency is selectable in the range from 50 Hz to 1 MHz.

The test voltage is selectable from 50 mV to 2 V rms.

The measurement result, the numerical value, dimension, and the equivalent circuit symbol, are all displayed on the large five-digit liquid-crystal display (LCD), which is updated at a rate of approximately two measurements per second.

A microprocessor controls the measurement process, computes the measurement value, and transfers the result to the display.

In the AUTO mode the dominant and the secondary parameter, either R, C, or L of the component under test is automatically selected for display.

For example, for an inductance with a quality factor Q between 1 and 1000, the instrument indicates the measurement value of the series inductance and the series resistance and as the equivalent-circuit symbol, the series connection of an inductance and a resistance.

In addition to AUTO mode, the following modes can be selected:

- Series respectively parallel components
- Impedance Z
- Phase angle Φ
- Quality factor Q, dissipation factor D
- Component voltage V_x , component current I_x

An internal DC BIAS voltage up to 10 V can be added to the measurement voltage for electrolytic capacitors.

An external DC BIAS voltage can also be selected, up to 40 V dc.

DC resistance measurements without an ac test signal can be made by using the optional PM 9565 DC Unit.

The instrument can be programmed and can transfer its measurement data via the PM 9548 Interface for the IEEE-488, or via the PM 9549 Interface for RS-232. Ten measurements per second are also possible. The RS-232 Interface also allows output of measurement results directly to a printer with no controller needed.

For sorting and binning of components, an optional PM 9566 Handler Interface is available.

Nine complete instrument settings can be stored and recalled for fast and convenient setup.

Chapter **3**

GETTING STARTED

3 GETTING STARTED

3.1 GENERAL INFORMATION

This section outlines the procedure and precautions necessary for operation. It identifies and briefly describes the functions of the front and rear panel controls and the display.

3.2 TURNING THE INSTRUMENT ON

WARNING

Before turning the instrument on, ensure that it has been installed in accordance with the instructions in Chapter 1.

After the instrument has been connected to the line voltage in accordance with Section 1.1.4, it can be turned on by setting the **POWER** switch on the front panel to **ON**.

The characteristics given in the Appendix of this manual are valid when the instrument is installed in accordance with the instructions in Chapter 1 of this manual and a warm-up period of 30 minutes is allowed.

After turning the power off, wait at least 5 seconds before turning it on again. This allows all power to completely discharge and the instrument to reset.

3.3 SELF-TEST ROUTINE

After power on, the instrument performs a self-test of the PROM, processor RAM, and external RAM. After this, the software version is indicated in the upper line of the display for approximately 1 second. All segments of the display field are shown for approximately 2 seconds, and the instrument automatically recalls its instrument state before power off.

If a fault is found during self-test, this fault is indicated as follows,

for example: `Err 2`

For detailed information see Section 4.7.

3.4 BRIEF CHECKING PROCEDURE

This procedure checks the instrument functions with a minimum of steps. It is assumed that the operator doing the test is familiar with the instrument and its characteristics.

Insert the test posts supplied into the connector on the front panel (Logos face to face).

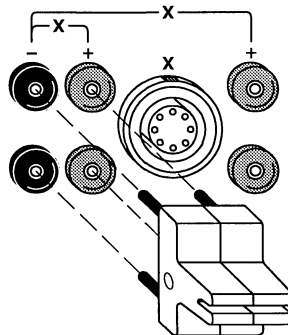

Press the **AC** key.



The display shows the current test signal level, for example,

1.50 VAC

Select an appropriate level via the rotary knob, for example, 1.00 V.

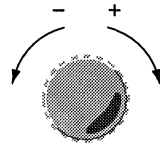

Press the **AC** key again to confirm your setting.



The display shows the current test signal frequency, for example,

10.0 kHz

Press the **FREQ** key.



Select an appropriate test signal frequency via the rotary knob, for example, 1 kHz.

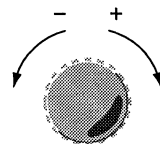

Press the **FREQ** key again to confirm your setting.



Press the **FIXTURE SET** key and select via the rotary knob "0".

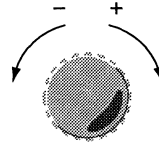

Press the **FIXTURE SET** key again to confirm your setting.



Press the green **AUTO** key.



The display shows:

AUTO

Press the **ZERO TRIM** key.



The display shows:

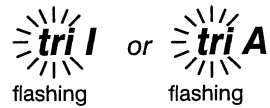

Select **tri I** via the rotary knob.

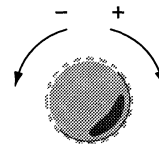

Press the **ZERO TRIM** key again.



The instrument checks the contacts and measures the open-circuit impedance.

The display shows:

bUSY
Oct

After about 5 seconds the display shows:



Short-circuit the test posts with a short wire or similar object.

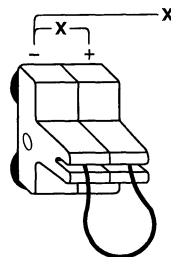

Press the **ZERO TRIM** key.



The instrument checks the contacts and measures the short-circuit impedance.

The display shows:

bUSY
Sct

If the ZERO TRIM operation was unsuccessful,
the display shows:
Refer to Section 4.3 and 4.4.

FAIL

If the ZERO TRIM operation was successful,
the display shows:

PASS

Insert the component into the test posts,
e.g., a 1 k Ω resistor.

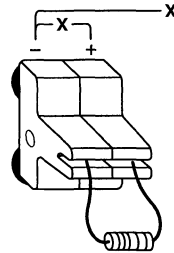

The display shows:

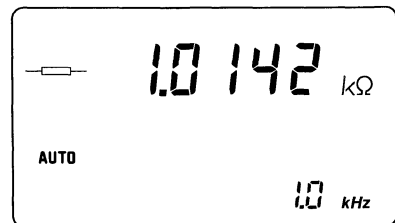

The test is finished.

See Chapter 4 for detailed information about measurement of components and measurement principles.

3.5 OPERATION AND APPLICATION

3.5.1 Control Elements, Display and Connections

There are two kind of keys:

- Keys such as the following that have a direct effect on the function of the instrument:

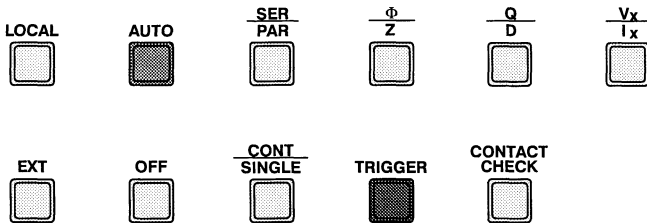

- Keys such as the following that have a 'pre-selection' character:

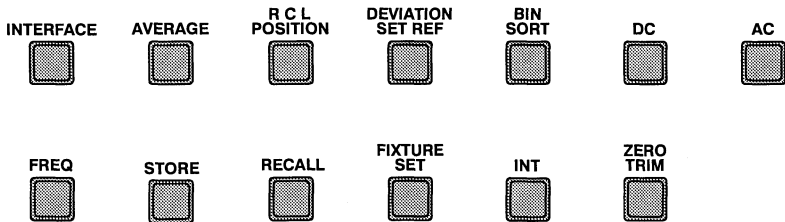

Pressing the key prepares the instrument for data input. The corresponding sign in the display flashes and the current setting can be altered via the rotary knob. Pressing the key again executes the setting. If you do not press the key again the instrument returns to its last setting after approximately 3 seconds (timeout).

Pressing the FREQ key for more than 2 seconds changes the frequency step-wise: ... 100 Hz, 1 kHz, 10 kHz, 100 kHz, 1 MHz, 100 Hz, 1 kHz ...

Keyboard:

LOCAL



Key used to switch from remote control to keyboard operation.

INTERFACE



Key used to display and to select:

- Instrument address for remote control via IEEE-488 Interface.
- Setup for remote control via RS-232 Interface.

POWER

ON
OFF

Power switch

AUTO



Key used to select automatic measurement mode: the dominant and secondary parameters are automatically determined.

SER
PAR

Key used to select series or parallel mode.

AVERAGE



Key used to display and to select the factor for the averaging function to reduce fluctuation of measured value.

R C L
POSITION

Key used to fix requested parameter value in the upper display row.

DEVIATION
SET REF

Key used to set an R, C, or L reference value. You can alter the reference value via rotary knob. The display shows the measurement result and the relative deviation in percent.



Key used to select a bin set. A bin set and the assigned limits are defined via the IEEE-488 or RS-232 Interface. For the commands, see the Programmers Manual.



Key used to display phase angle or impedance (complex impedance).



Key used to display quality factor ($\tan \Phi$; $Q = 1/D$) or dissipation factor ($\tan \delta$; $D = 1/Q$).



Key used to display test voltage or current at the component terminals.



Key used to display and select the DC measurement source voltage, 50 mV to 2 V (optional).



Key used to display and select the AC measurement source voltage, 50 mV to 2 V ac rms.



Key used to display and select the AC test signal frequency 50 Hz to 1 MHz.

STORE

Key used to store instrument settings (9 registers).

RECALL

Key used to recall instrument settings (9 registers).

Key used to display and select a number via the rotary knob corresponding to the capacitance of the connected test cable:

FIXTURE SET

0 for capacitances <50 pF

1 for 50 to 150 pF

6 for 550 to 650 pF

2 for 150 to 250 pF

7 for 650 to 750 pF

3 for 250 to 350 pF

8 for 750 to 850 pF

4 for 350 to 450 pF

9 for 850 to 950 pF

5 for 450 to 550 pF

10 for 950 to 1050 pF

The original PM 9541A, PM 9542A, PM 9540/TWE, and the PM 9540/BAN test cables have a capacitance of about 300 pF.

So you should select number 3.

For the test posts select 0.

INT

Key used to display and to select an internal dc bias voltage up to 10 V, e.g., to measure electrolytic capacitors.

EXT

Key used to select an external dc bias voltage (maximum 40 V dc).

OFF

Key used to switch the dc bias voltage off.



Key used to select single or continuous measurement.



Key used to trigger a single measurement.



Key used to check the reliability of the used four-wire connection.



Key used for automatic trimming of

- Open-circuit impedance
(> 100 k Ω , test frequency \leq 100 kHz;
> 10 k Ω at 1 MHz).
- Short-circuit impedance (< 10 Ω).

Rotary knob to set

- Test signal voltage
- Test signal frequency
- DC bias internal
- Storage registers
- IEEE-488/RS-232 settings
- Averaging factor
- Fixture set
- Reference value
- ZERO TRIM Routine

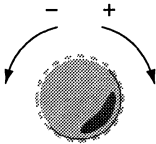

Display:**REMOTE**

Instrument in remote control via RS-232 or IEEE-488 Interface.

AVERAGE

Increased time factor for averaging to reduce fluctuation of measured value.

POSITION FIXED

The value of the selected parameter R, C, or L is shown in the upper row.

DEV MODE

The display shows the measured value in the upper row and the relative deviation in percent of a selected R, C, or L reference value in the second row.

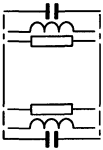

Equivalent circuit symbols:

In AUTO mode the dominant parameter is shown in the upper section; the secondary parameter is shown in the lower section.

* 8.8.8.8.8

Maximum of five digits for the measured value of the dominant parameter or of the selected parameter via RCL POSITION key.

The asterisk indicates that the component is outside the basic accuracy range of the instrument.

*n***k****F**
*M***k****Ω****%**

Units for:
nF, pF, μF, mF for capacitances
μH, mH, H, kH for inductances
MΩ, kΩ, Ω for resistances

Φ **Z****D****Q**

Display of selected Parameter
Φ Phase angle
Z Impedance
D Dissipation factor
Q Quality factor

.8.8.8.8

Maximum of four digits for the measured value of the selected parameter or of the series/parallel parameter in AUTO mode. Display of the relative offset in percent in DEVIATION mode. Internal dc bias voltage.

*M***k****Ω**
*DEG***%**
*n***p****k****F**

Units for:
MΩ, kΩ, Ω for resistance
DEG (Degree) for phase angle
nF, pF, μF, mF for capacitance
μH, mH, H, kH for inductance
V, mV for voltage
mA, μA for current
% for relative deviation

AUTO

Auto mode enabled:
 Automatic selection of dominant and series/parallel parameter.

DOMINANT

When RCL POSITION FIXED has been selected, this 'DOMINANT' lights up if the parameter in the second row is the dominant one.

SINGLE STANDBY

Ready for single measurement.

DC BIAS EXT

External dc bias voltage enabled.

DC BIAS INT

Internal dc bias voltage enabled.

8.8.8

Maximum of three digits for:

- AC test signal voltage
- DC test signal voltage
- Test signal frequency

Unit for:

VAC
VDC
MkHz

VAC ac test signal voltage
VDC dc test signal voltage
M Hz, kHz, Hz test signal frequency

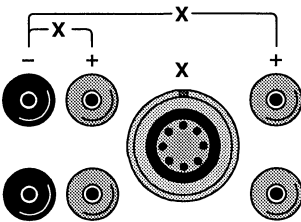
Connector on the front panel:

Connectors for:

- Test posts for four-wire measurements
- PM 9540/TWE, SMD TWEEZERS
- PM 9540/BAN, 4-WIRE TEST CABLE with banana plugs
- PM 9541A, 4-WIRE TEST CABLE (Kelvin Clip)
- PM 9542A, RCL ADAPTER
- PM 9542SMD, SMD ADAPTER

Rear panel:

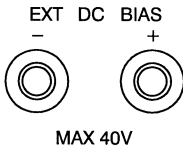

External dc bias voltage input (maximum 40 V dc).

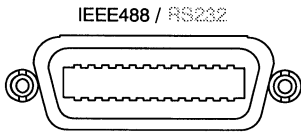

IEEE-488 bus connector for remote control.

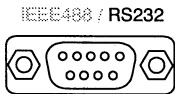

RS-232 connector.

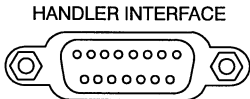

Component handler interface connector.

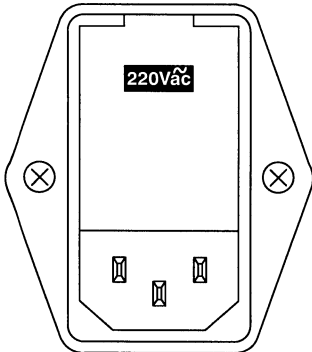

Input power module with fuse and voltage selector.

~ ac (alternating current).

For details, see Section 1.1.4:

Line Voltage Setting and Fuses.

3.5.2 Measurement Setup and Accessories

For best accuracy, you should perform ZERO TRIM (see Section 4.3) when you change the measurement setup or the test signal frequency.

You should not change the setup after trimming if you use test signal frequencies ≥ 10 kHz with the PM 9541A Test Cable with Kelvin Clips, the PM 9542A RCL Adapter, the PM 9540/TWE SMD Tweezers, or the PM 9540/BAN Test Cable.

To avoid measurement errors due to the capacitance to ground of the used test cable, press the FIXTURE SET key and select the appropriate setting via the rotary knob (a number from 0 to 10, see table on Page 3 – 10).

When you have connected the component you want to measure and you are not sure that the connection is correct, press the CONTACT CHECK key. The instrument automatically checks the reliability of the four-wire connection.

Test posts

Most common components can be measured with the supplied test posts plugged into the front panel connectors.

Press the FIXTURE SET key and select number 0 via rotary knob.
Press the FIXTURE SET key again.

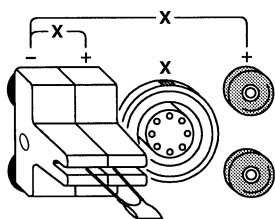

Radial-Lead Component

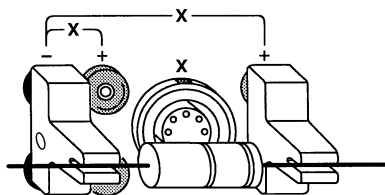

Axial-Lead Component

PM 9541A Test Cable with Kelvin Clips ★

Use the test cable to measure in-circuit components or components of large size.

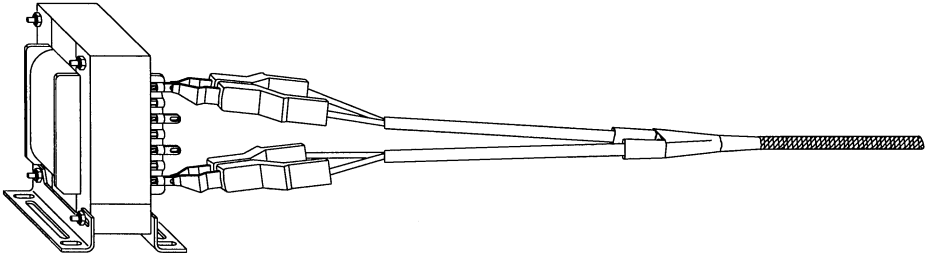

The test cable is connected to the instrument via the round plug (red markings face to face). The plug locks automatically. To unlock the plug, pull on the ridged part.

Press the FIXTURE SET key and select number 3 via rotary knob.

Press the FIXTURE SET key again.

PM 9542A RCL Adapter ★

The RCL adapter allows you to make component measurements away from the front panel of the instrument. The RCL adapter can also handle larger components than the front panel connector can.

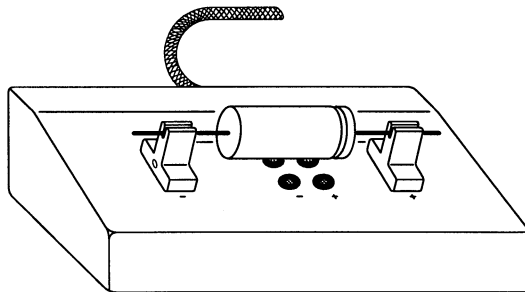

★ see next page

The RCL adapter is connected to the instrument via the round plug on the front panel (red markings face to face).

Press the FIXTURE SET key and select number 3 via the rotary knob.

Press the FIXTURE SET key again.

The supplied single test posts and the double test post can also be directly inserted into the front panel connector of the instrument.

For this select FIXTURE SET number 0.

Note: For accurate measurements you should insert only the test posts, cable, or adapter that you need for the actual measurement.

★ **The PM 9541A Test Cable and the PM 9542A RCL Adapter have an improved cable from fall 1995 onwards (black cable jacket). If you have already a cable or an adapter with a grey cable you should not use it at test frequencies > 100 kHz if the ambient temperature is unstable during measurement.**

SMD Adapter PM 9542SMD

The SMD adapter can be used to measure SMD components with a length of 2 to 10 mm, depth >1 mm, height >0.5 mm, or a diameter >1 mm.

For easy and quick insertion and removal of components, insert the SMD Adapter into the PM 9542 RCL Adapter.

Press the FIXTURE SET key and select number 3 via the rotary knob.

Press the FIXTURE SET key again.

You can also insert the SMD adapter directly into the front panel connector of the instrument. To ease insertion of components, set the instrument in a sloping position (handle folded down).

Select the FIXTURE SET number 0 via the rotary knob.

Press the FIXTURE SET key again.

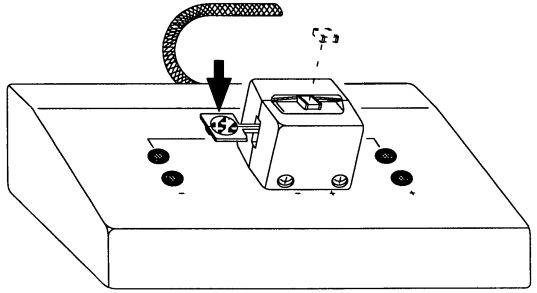
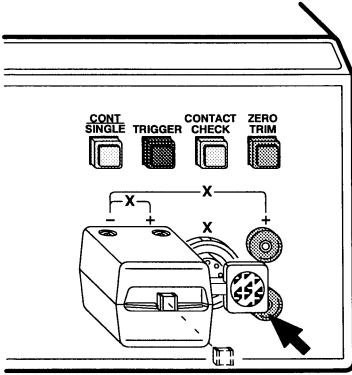

When you use the SMD adapter to measure very small capacitances especially below 100 pF, you must take into account the alteration of the stray fixture capacitances, depending on the separation of the contacts.

Fixture Capacitance (pF)

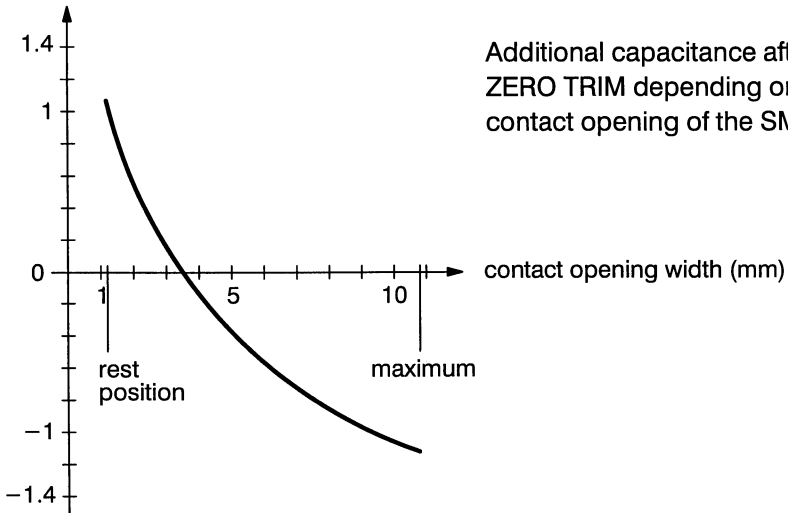

Additional capacitance after ZERO TRIM depending on contact opening of the SMD adapter.

PM 9540/TWE SMD Tweezers

Use the SMD Tweezers to measure single SMD components or in-circuit SMD components.

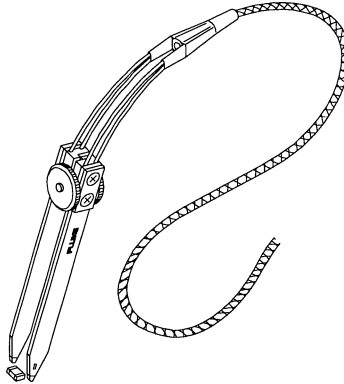

The SMD Tweezers are connected to the instrument via the round plug on the front panel (red marking face to face).

Press the FIXTURE SET key and select number 3 via the rotary knob.

Press the FIXTURE SET key again.

For open-circuit trimming when you are measuring small capacitances, set the opening of the tweezers to the size of the component.

The two-wire measuring technique and the pressure applied by the tips of the tweezers can cause a measuring error in addition to the basic error of the RCL Meter, due to the additional serial resistance (typical 0.02Ω). The presence of dirt or contaminants on the tips of the tweezers can also affect measurements. The tips may be periodically cleaned with alcohol and a non-abrasive cloth.

PM 9540/BAN Test Cable with Banana Plugs

Use the test cable if you need banana plugs for your own special applications.

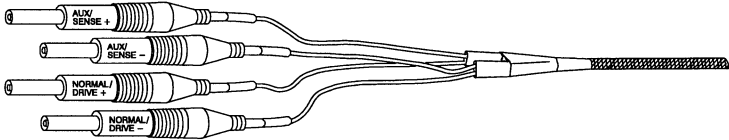

The test cable is connected to the instrument via the round plug on the front panel (red marking face to face).

Press the FIXTURE SET key and select number 3 via the rotary knob.

Press the FIXTURE SET key again.

When you perform ZERO TRIM short-circuit DRIVE+ with SENSE+ and DRIVE– with SENSE– for the open-circuit trimming. Short-circuit all four plugs for the short-circuit trimming.

Two-Wire Measurements

You can measure components with two test leads in two-wire mode by using the plus and minus connectors. For this, it is necessary to short-circuit the drive and sense lines at the instrument. To reduce stray capacitances and interferences, use short leads.

You also can use the eight-pole round connector.

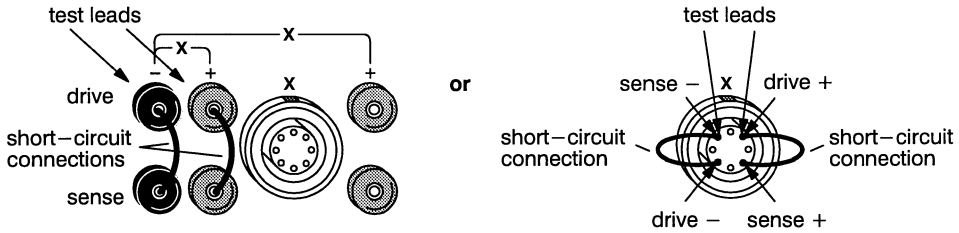

The characteristics given in the Appendix of this manual are valid for four-wire measurements. Four-wire measurements are particularly important for high impedance components at high test signal frequencies and for low impedance components.

Chapter **4**

HOW TO USE THE INSTRUMENT

4 HOW TO USE THE INSTRUMENT

4.1 THE PRINCIPLE OF MEASUREMENT

The component measurement is based on the current and voltage technique. The component voltage and the component current are measured and converted into binary values. From these values the CPU calculates the electrical parameters of the component. According to the front panel parameter selection different parameters are displayed. Via AUTO mode or by pressing the SER/PAR key when AUTO mode was selected, the dominant and secondary parameters (resistance, capacitance, or inductance) are displayed. In addition manually selected parameter can be displayed (Q, D, Z, Φ , V_x , or I_x).

Each measurement cycle lasts approximately 0.5 seconds. For AC measurements one cycle consists of seven single measurements, the results of which are stored and arithmetically evaluated. Finally the result is transferred to the display. The seven single measurements are as follows:

1. Voltage Measurement: 0°
and internal gain factor setting
2. Voltage Measurement: 90°
3. Reference Measurement: 0°

- Gain factor > 1**
4. Reference Measurement: 90°
 5. Current Measurement: 0°
 6. Current Measurement: 90°
 7. Reference Measurement: 0°

- Gain factor = 1**
- Current Measurement: 0°
 - Current Measurement: 90°
 - Reference Measurement: 0°
 - Reference Measurement: 90°

The seven measured values are stored at the end of the single measurements. The microprocessor uses the measured values to calculate the equivalent series resistance R_s , the equivalent series reactance X_s , and the quality factor $Q = X_s/R_s$ of the component. In AUTO mode, the microprocessor determines the dominant and secondary parameter, calculates its value, and displays it together with the equivalent circuit symbol. If one of the other parameters is manually selected, this parameter is calculated and displayed. After that the next measurement cycle starts with the seven single measurements.

The display shows:

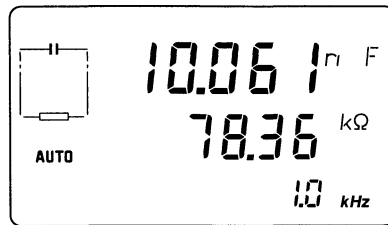

The following phase diagrams and formulas show the mathematic basics for internal calculation of the component value.

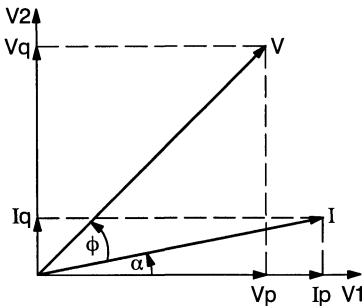

V: voltage
 I: current
 V1, V2: 0°-voltage, 90°-voltage

The phase angle between I and V is ϕ .
 The phase angle between I and V1 is α .

In the diagram the phase relation between I and V happens to be a lossy inductance.

In each measurement cycle, the following components are determined:

V_p , V_q , I_p , I_q .

The series resistance and reactance are calculated from these components.

$$R_s = \frac{V_p I_p + V_q I_q}{I_p^2 + I_q^2} \quad (1)$$

$$X_s = \frac{V_q I_p - V_p I_q}{I_p^2 + I_q^2} \quad (2)$$

The following equivalent circuit is valid:

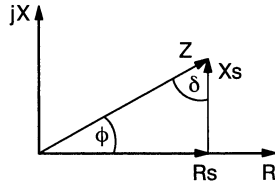
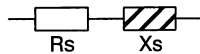

Quality factor: $Q = \tan \phi = 1/D = \frac{|X_s|}{R_s} \quad (3)$

Dissipation factor: $D = \tan \delta = 1/Q = \frac{|R_s|}{X_s} \quad (4)$

The magnitude of Q and the sign of X_s determine which parameter of the component is dominant.

- X_s positive = inductive
- X_s negative = capacitive

The formulas for the various parameters are as follows:

$Q = \frac{|X_s|}{R_s}$ see equation (3)

$Z = \sqrt{R_s^2 + X_s^2}$

$D = \frac{1}{Q}$

$C_p = \frac{1}{\omega(1 + 1/Q^2)|X_s|}$ if $X_s < 0$

$R_p = (1 + Q^2) \times R_s$

$L_p = \frac{(1 + 1/Q^2)|X_s|}{\omega}$ if $X_s > 0$

R_s see equation (1)

$C_s = \frac{1}{\omega|X_s|}$ if $X_s < 0$

$L_s = \frac{|X_s|}{\omega}$ if $X_s > 0$

Impedance $Z = R + jX$

Admittance $Y = 1/Z$

Example:

By using the seven measurements, the instrument has calculated R_s and X_s in accordance with formulas 1 and 2, for example,

$$R_s = 3.068 \text{ k}\Omega$$

$$X_s = -15.199 \text{ k}\Omega$$

From this the instrument calculated:

$$Q = \frac{|X_s|}{R_s} = 4.954$$

The instrument displays the corresponding equivalent circuit symbol with the dominant and the secondary parameter, according to the criteria of the Auto Mode Decision Diagram (see Section 4.5.1); in this case, as X_s is negative and $1 < Q < 1000$:

The display shows:

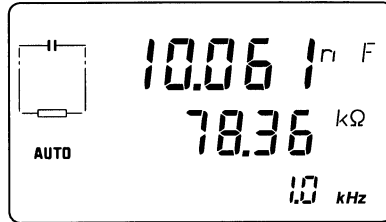

The calculation of the dominant parameter C_p was done according to the following formula:

$$C_p = \frac{1}{\omega(1 + 1/Q^2)|X_s|}$$

$$C_p = \frac{1}{2\pi \times 1 \text{ kHz} (1 + 1/4.954^2) \times 15.199 \text{ k}\Omega} = 10.061 \text{ nF}$$

The maximum display is five digits ± 1 digit tolerance.

Calculation of the other selectable parameters are performed as follows:

$$D = \frac{1}{Q} = \frac{1}{4.954} = 0.202$$

$$R_p = (1 + Q^2) \times R_s = (1 + 4.954^2) \times 3.068 \text{ k}\Omega = 78.36 \text{ k}\Omega$$

$R_s = 3.068 \text{ k}\Omega$ (calculated by the instrument according to formula 1)

$$Z = \sqrt{R_s^2 + X_s^2} = \sqrt{(3.068 \text{ k}\Omega)^2 + (15.199 \text{ k}\Omega)^2} = 15.51 \text{ k}\Omega$$

$$C_s = \frac{1}{\omega |X_s|} = \frac{1}{2\pi \times 1 \text{ kHz} \times 15.199 \text{ k}\Omega} = 10.471 \text{ nF}$$

Φ : The instrument calculates

$$\tan \Phi = \frac{|X_s|}{R_s} = \frac{15.199 \text{ k}\Omega}{3.068 \text{ k}\Omega} = 4.954$$

and gets Φ from an internal tangent table similar to a calculator

$$\Phi = - 78.6 \text{ DEG}$$

For accurate measurement you should select an appropriate test signal frequency; see Section 4.2.

If you measure the same component mentioned in the preceding example, with a test signal frequency that is too low, the resistive part of the capacitive component dominates.

So the instrument determines a resistor as the dominant parameter.

Example: Test signal frequency 100 Hz

The display shows:

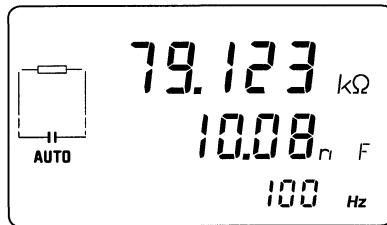

The instrument determined:

$$R_s = 63.248 \text{ k}\Omega$$

$$X_s = -31.680 \text{ k}\Omega$$

and calculated:

$$Q = \frac{|X_s|}{R_s} = 0.501$$

Because $Q < 1$, the display shows a resistor as the dominant parameter.

Calculation of the other parameter is performed by the same formulas:

$$D = \frac{1}{Q} = 2.00$$

$$R_p = (1 + Q^2) \times R_s = 79.123 \text{ k}\Omega$$

$$C_p = \frac{1}{\omega(1 + 1/Q^2)|X_s|} = 10.08 \text{ nF}$$

$$R_s = 63.248 \text{ k}\Omega \text{ (calculated according to formula 1)}$$

$$C_s = \frac{1}{\omega|X_s|} = 50.23 \text{ nF}$$

$$Z = \sqrt{R_s^2 + X_s^2} = 70.74 \text{ k}\Omega$$

$$\tan \Phi = \frac{|X_s|}{R_s} = 0.501$$

$$\Phi = - 26.6 \text{ DEG}$$

If you are interested in mathematics, the following two pages show the phasor diagrams and formulas for the various components.

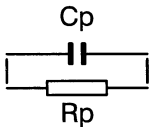

$$Y = \frac{1}{R_p} + j\omega C_p$$

$$Z = \frac{R_p (1 - j\omega C_p R_p)}{1 + (\omega C_p R_p)^2}$$

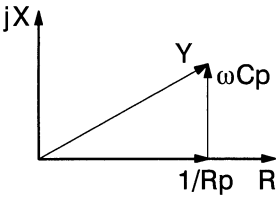

$$D = \frac{1}{\omega C_p R_p}$$

$$C_s = (1 + D^2) \times C_p \quad R_s = \frac{D^2}{1 + D^2} \times R_p$$

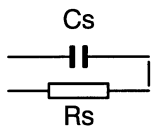

$$Z = R_s - j \frac{1}{\omega C_s}$$

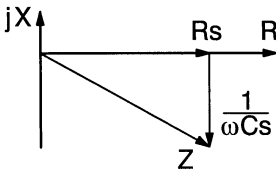

$$D = \omega C_s R_s$$

$$C_p = \frac{1}{1 + D^2} \times C_s \quad R_p = \frac{1 + D^2}{D^2} \times R_s$$

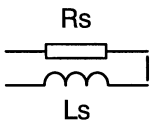

$$Z = R_s + j\omega L_s$$

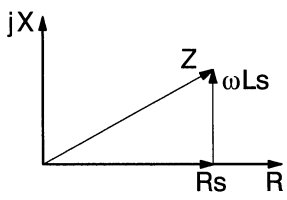

$$D = \frac{R_s}{\omega L_s}$$

$$L_p = (1 + D^2) \times L_s \quad R_p = \frac{1 + D^2}{D^2} \times R_s$$

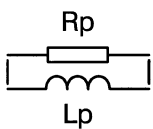

$$Y = \frac{1}{R_p} - j\frac{1}{\omega L_p} \quad Z = \frac{R_p (1 + jR_p/\omega L_p)}{1 + (R_p/\omega L_p)^2}$$

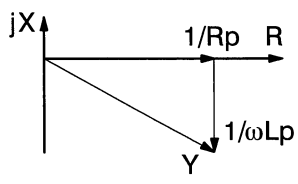

$$D = \frac{\omega L_p}{R_p}$$

$$L_s = \frac{1}{1 + D^2} \times L_p \quad R_s = \frac{D^2}{1 + D^2} \times R_p$$

4.2 MEASURING COMPONENTS

4.2.1 Test Signal Frequency and Voltage

Resistors, inductors, and capacitors are not ideal electrical components. They all have secondary effects that limit their performance. Understanding the effects is important in understanding the results displayed on the RCL meter. For example, a resistor has shunt capacitance and lead inductance. Inductors have shunt capacitance and resistance in their windings.

The differing reaction of these components, which depends on the frequency and test signal voltage, requires methods of measurement adapted to each situation.

To this end, the PM6306 has a frequency range from 50 Hz to 1 MHz.

Resolution: 50, 60, 100, 120 Hz

200 Hz to 20 kHz in 100 Hz steps

21 kHz to 1 MHz in 1 kHz steps.

The analog-to-digital converter (ADC), used for digitizing the measured values, is basically insensitive to hum interfered into the measurement setup. Hum interference may degrade measurement accuracy using test frequencies of 60 Hz or 120 Hz at 50 Hz AC power or 50 Hz test frequency at 60 Hz AC power.

The following can be selected as the test signal voltage:

- AC voltage
 - 50 mV to 2 V, resolution 10 mV
 - 100 Ω internal resistance
- DC voltage (option)
 - 50 mV to 2 V, resolution 10 mV
 - 100 Ω internal resistance

An internal dc bias voltage up to 10 V or an external bias of maximum 40 V dc can be added to the AC voltage signal. The external voltage must be free of hums, particularly if test signal frequency is 50 Hz or 60 Hz (line frequencies).

If you measure components with $Z > 10 \text{ k}\Omega$ and if you use an external bias source with an impedance $> 50 \text{ }\Omega$, perform open-circuit trimming with bias voltage applied.

WARNING

A 40 volt external bias can charge a capacitor to a high enough voltage that it can cause injury if it is accidentally discharged. Verify that polarized capacitors are installed with the correct polarity before applying a bias voltage.

4.2.2 Resistors

In principle in addition to its purely resistive component, a resistor has capacitive and inductive components.

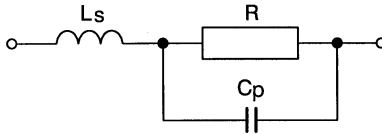

R = DC resistance.

L_S = Inductance of any winding/coiling and of the components leads.

C_P = Shunt capacitance across the resistive component.

In the case of wire-wound resistors, C and L are relatively high due to the winding. In the case of film resistors, these values are considerably smaller.

With low-valued resistors ($<1\text{ k}\Omega$), the series inductive component dominates.

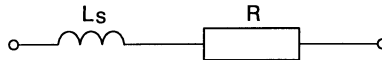

With high-valued resistors ($>1\text{ k}\Omega$), C predominates.

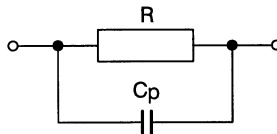

The effect of C and L limits the high frequency performance of the component.

Measurement Conditions:

Select a low test signal frequency, i.e., 1 kHz or measure with DC voltage (option). In the case of resistors in the megohm range, the instrument might recognize the shunt capacitor as the dominant component if the measurement frequency is too high.

4.2.3 Capacitors

Several components, which depend on the type of capacitor, determine the electrical characteristics of a capacitor.

Foil Capacitor:

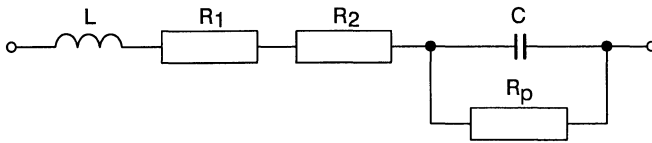

- L = Inductance of the lead wires, the bonding and the winding (mainly in the nH area).
- R_1 = Resistance of the bonding (5 to 10 ohms in unfavorable cases).
- R_2 = Resistance of the foils, which increases as frequency increases.
- R_p = Dissipation in dielectric, which can be ignored as frequency increases.
- C = Capacitance.

Electrolytic Capacitors:

With AC voltage

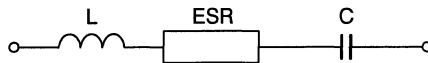

- L = Inductance of the connections and of the winding.
- ESR = Equivalent series resistance:
Resistance of the electrolytes, the dielectric, DC resistance of the mechanical structure. The ESR depends on the frequency.
- C = Overall capacitance.

With DC voltage

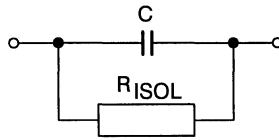

C = Overall capacitance.

R_{ISOL} = insulating resistance, it determines the leakage current of the component.

Electrolytic capacitors operate at lower frequencies (usually < 10 kHz).

Measurement Conditions:

The frequency for the test signal should not be selected too high; otherwise, a capacitance that is too high is measured when the resonant frequency is approached.

$$f_o = \frac{1}{2\pi\sqrt{LC}} \quad f_o = \text{self-resonant frequency}$$

If the frequency is too low, the ohmic and inductive components falsify the result. A test frequency lower than $f_o/30$ should be taken as the approximate value.

For example:

Typical self-resonant frequency for a 100 μ F capacitor is 50 kHz; select test signal frequency less than 1.6 kHz.

Electrolytic capacitors used for smoothing in power supplies should be measured at their operating frequency (100 Hz or 120 Hz).

In order to determine the real dissipation components, a high test frequency is selected for the serial losses and a low one for the parallel losses.

Use DC voltage for measuring the insulating resistance.

4.2.4 Inductances

Coil with iron core

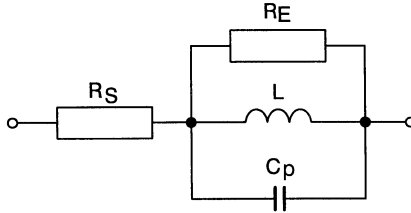

R_S = DC resistance of the copper winding

R_E = Core loss

C_p = Capacitance of the winding

L = Inductance

Measurement Conditions:

As in the case of the capacitor, the test frequency (f_{TEST}) should lie far below the self-resonant frequency (f_0). The f_0 frequency can be very low because of the relatively high capacitance of the winding.

$$f_0 = \frac{1}{2\pi\sqrt{LC}} \quad f_0 = \text{self-resonant frequency}$$

Approximate value: $f_{TEST} = f_0/30$

It is advisable to measure the coil close to its operating frequency if the reaction of the coil under operating conditions is to be determined.

A voltage level that is not too high must be selected for coils because of the saturation effect caused by the iron core. For this purpose, the PM6306 offers a selectable voltage from 50 mV to 2 V.

Use DC voltage to measure the resistance of the winding.

4.3 AUTOMATIC ZERO TRIM

To ensure best measurement accuracy you should perform the automatic ZERO TRIM after you have selected your measurement setup and the appropriate setting for FIXTURE SET, see page 3 – 10. The instrument determines the open-circuit and the short-circuit impedances of the measurement setup and takes the results into consideration for all following measurements.

You can select different ZERO TRIM procedures: TRIM 1 or TRIM A (all).

TRIM 1:

If you measure components with a **certain test signal frequency** select **TRIM 1**. The instrument performs an open-circuit and a short-circuit measurement at the selected test signal frequency or at DC if a DC-Unit is built in. The procedure takes less than 10 seconds.

You should perform the trim procedure again, if you select a different test signal frequency, if you change the measurement setup, or if the temperature difference between ZERO TRIM and measurement is $>10\text{ }^{\circ}\text{C}$.

TRIM A:

If you measure components at **different test signal frequencies** select **TRIM A**. The instrument performs an open-circuit and a short-circuit measurement at the selected test frequency, at 15 additional frequencies, and at DC, if a DC-Unit is built-in. The instrument interpolates, based on measured results, the open-circuit and short-circuit impedances for the complete frequency range. The procedure takes about one minute.

You should perform the trim procedure again, if you select a different measurement setup or if the temperature difference between ZERO TRIM and measurement is $>10\text{ }^{\circ}\text{C}$.

- Press the **ZERO TRIM** key.
- The display shows *tri 1* or *tri A*.
- Select the required trimming procedure via the rotary knob.
- Press the **ZERO TRIM** key again.
- The instrument first performs a CONTACT CHECK.
- The display shows **bUSY** in the upper row.
The contacts Drive+ and Sense+ as well as Drive– and Sense– must be connected. As far as the adapters available from Fluke are concerned, this is normally ensured automatically, except for the PM 9542SMD, SMD Adapter and the PM 9540/BAN Test Cable with banana plugs.

If you use the PM 9540/BAN cable in your own special application short-circuit DRIVE+ with SENSE+ and DRIVE– with SENSE– for the open-circuit trimming. Short-circuit all four plugs for the short-circuit trimming.

For further information about the SMD Adapter please read the last paragraph of this section.

- If the transition resistances are too high so that they could affect the accuracy of the measuring result of the components you want to measure, the display shows **CC-HI** (Contact Check High) and **FAIL** or **CC-LO** (Contact Check Low) and **FAIL**.
Press the **AUTO** key to abort the procedure. Check your setup and repeat the trimming procedure. If you cannot eliminate the transition resistances press the **ZERO TRIM** key to continue. Note that the measurement result could be falsified.

At the beginning of the trimming process the instrument verifies at a test frequency of 10 kHz whether the adapter is short-circuited or open.

- An impedance >100 k Ω means open-circuit. The display shows **bUSY** and **Oct** (open-circuit). During TRIM A the display additionally shows the number of remaining measurements.

- The instrument determines the open-circuit impedance, stores the values determined, and takes them into consideration for all following measurements.
- The display shows the flashing signs **bUSY** and **Sct** (short-circuit).
- Short-circuit the adapter (impedance $< 10 \Omega$).
- Press the **ZERO TRIM** key once more.
- Once again the instrument performs a CONTACT CHECK.
- The display shows **bUSY** and **Sct**. During TRIM A the display additionally shows the number of remaining measurements.
- The short circuit impedance is measured, stored, and taken into consideration for all further measurements.
- At the end of a successful trimming process the display shows **PASS** and the instrument returns to its last setting.

Whenever the trimming process was started with short-circuited adapters, the flashing signs **bUSY** and **Oct** are shown after the end of the first trimming step (short-circuit impedance).

- Remove the short-circuit and press the **ZERO TRIM** key.
- The display shows **bUSY** and **Oct**.
- The open-circuit impedance is measured, stored, and taken into consideration for all further measurements.
- Both trimming steps being completed successfully, the display shows **PASS**. The instrument returns to its last setting.

In case of a too low open-circuit impedance or a too high short-circuit impedance, the display shows **FAIL** and the trimming process is aborted. In this case please check the measurement setup and repeat the trimming process.

Open-Circuit Impedance:

> 100 k Ω at test frequencies \leq 100 kHz

> 100 k Ω \times $\frac{100 \text{ kHz}}{\text{test frequency}}$ at test frequencies > 100 kHz

Short-Circuit Impedance: < 10 Ω

If you perform **ZERO TRIM** with a component connected with an impedance <10 Ω or, for instance, >100 k Ω for test frequencies of <100 kHz or >10 k Ω at a test frequency of 1 MHz, the value of the component will be taken into consideration. The instrument now indicates, for example, a negative resistance value at open or short-circuited contacts of the measurement setup, or an inductance in case of a connected capacitor, or a capacitance in case of an inductance.

Perform **ZERO TRIM** once again without any component connected in order to obtain correct values.

The ZERO TRIM data are stored in a memory and will persist in the memory even if the instrument is switched off.

You may also perform the measurements independently from each other.

Short-Circuit Trim

Use this for measuring low impedances, especially below 100 Ω .

- Short-circuit the contacts of the measurement setup.
- Press the **ZERO TRIM** key.
- Select TRIM 1 or TRIM A via the rotary knob.
- Press the **ZERO TRIM** key again.
- The instrument performs a CONTACT CHECK.
- The display shows **bUSY** and **Sct** (short-circuit). The instrument performs a measurement and stores the value determined, which is the short-circuit impedance. This value, the line and contact impedances included, is taken into consideration for all further measurements.
- The display shows the flashing signs **bUSY** and **Oct**.
- Press the **AUTO** key or wait about 5 seconds until the instrument returns to its last setting.

If the impedance is $>10 \Omega$, during the short-circuit trimming process the display shows **FAIL** and the trimming process is aborted.

Open-Circuit Trim

Use this for measuring smaller capacitances or when measuring with high test signal frequencies to avoid having the open-circuit impedance of the measurement setup affect the result.

- Remove any component connected.
- Press the **ZERO TRIM** key.
- Select TRIM 1 or TRIM A via the rotary knob.
- Press the **ZERO TRIM** key again.
- The instrument performs a CONTACT CHECK.
- The display shows **bUSY** and **Oct** (open-circuit). The instrument performs a measurement and takes the value determined, which is the open-circuit impedance, into consideration for all further measurements.
- The display shows the flashing signs **bUSY** and **Sct**.
- Press the **AUTO** key or wait about 5 seconds until the instrument returns to its last setting.

If the impedance is too low during the trimming process, the display shows **FAIL** and the trimming process is aborted.

Note: If you use the test cable with PM 9541A Kelvin Clips, the PM 9542A RCL Adapter, or the PM 9540/TWE, SMD Tweezer for test signal frequencies ≥ 10 kHz, you should not change the setup after trimming.

To avoid measurement errors, do not touch the contacts during measuring.

ZERO TRIM with the PM 9542SMD, SMD Adapter

As far as the SMD Adapter is concerned the contacts Drive+ and Drive- are insulated from the contacts Sense+ and Sense-. The contacts are only closed when a component is inserted for measurement.

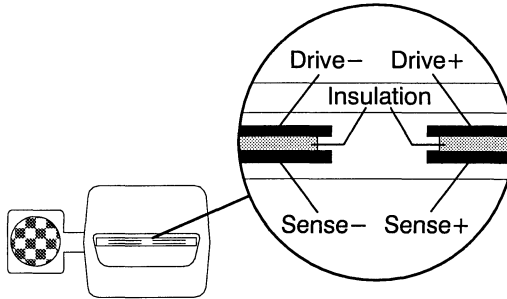

Contacts of the PM 9542SMD, SMD Adapter.

To perform a CONTACT CHECK at an open adapter, as required for the automatic ZERO TRIM, the SMD Adapter is equipped with SMD components with an impedance of $Z \rightarrow \infty$. Please use this component for the open-circuit trimming process and perform the trimming process as described. For short-circuit trimming you can use one of the attached components with an impedance of $Z \rightarrow 0 \Omega$. These components have a real resistance of typical 4 m Ω . You should take into account this value if you measure low impedances.

If you need spare sets you can order them via your Service Organization with the following order number: 5322 310 32275.

$Z \rightarrow 0 \Omega$

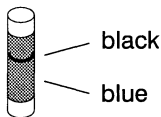

$Z \rightarrow \infty$

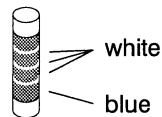

4.4 CONTACT CHECK

After you have connected the component you want to measure but are not sure whether the resistance of the contact is sufficiently low, you can perform a CONTACT CHECK. The instrument then automatically checks whether the transition resistances affect the measuring accuracy in an inadmissible way.

- Press the **CONTACT CHECK** key.
- The instrument checks – in two steps – the transition resistances between the Drive+ contact and the component and between the component and the Sense+ contact (high).
- If the test is satisfactory, the instrument checks the transition resistance between the contacts Drive– and Sense– (low).
- If this test is also satisfactory, the display shows **PASS**, and the instrument returns to its last setting.
- If the resistances are too high, the display shows **CC - HI** (Contact Check High) and **FAIL** or **CC - LO** (Contact Check Low) and **FAIL**. In this case check the measurement setup as well as the contacts and repeat the CONTACT CHECK.

When you perform the CONTACT CHECK at the SMD Tweezers, the test measures the resistances between Drive and Sense, i.e., the lines and contacts within the tweezers. Because the SMD Tweezers operate in accordance with the two-wire measuring technique, the resistance between the tips and the component cannot be verified.

4.5 MEASURING MODES

After power on, the instrument automatically recalls the mode that was set before power off.

- Select a suitable measurement setup.
- Select the matching test signal frequency and voltage (refer to Sections 3.5.2 and 4.2).
- Execute ZERO TRIM if necessary.
- Insert the component.

Galvanic nonconducting components, e.g., electrolytic capacitors, should be measured with the internal bias voltage activated. To do this

- Press the INT key.
- The display shows DC BIAS INT and the current value.
- Select the appropriate value via the rotary knob.
- Press the INT key again to confirm your setting.

4.5.1 Automatic (AUTO)

In most cases, you will be interested in the dominant parameter of the component. This is automatically determined and displayed in the AUTO mode. Press the green **AUTO** key. The display shows **AUTO**, the value of the dominant parameter in the upper line, the value of the secondary parameter in the lower line, and the appropriate equivalent circuit symbol.

Function and Key Operation



Display

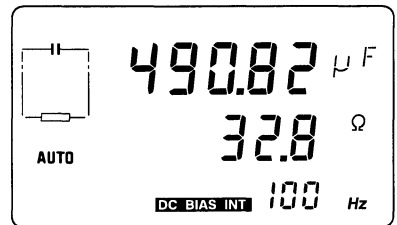

The decision criterion for selecting the dominant parameter is $Q = D = 1$. Refer to Section 4.1. The values Q and D not only depend on the component but also on the test signal frequency used.

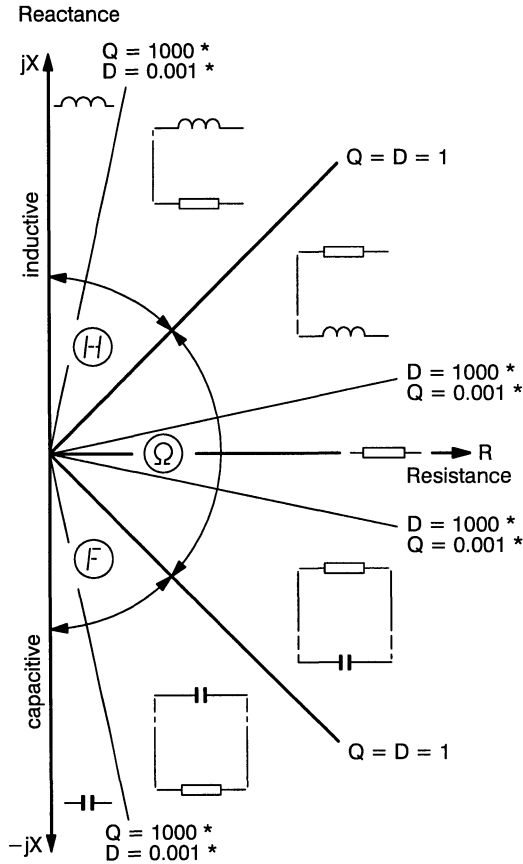

* For test signal voltages ≤ 0.25 V, the decision criterion is $Q = 200$, $D = 0.05$, or $Q = 0.05$, $D = 200$.

AUTO MODE DECISION DIAGRAM

4.5.2 Manual

If you want to determine a parameter that differs from the one automatically calculated by the instrument, press the appropriate function key:

Function and Key Operation

Display

Series or parallel parameter

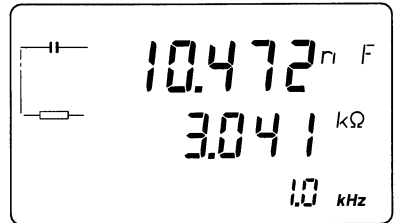
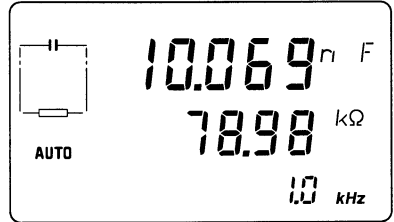

Impedance

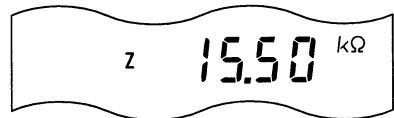

Phase angle

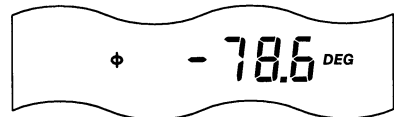

Function and Key Operation**Display**

Dissipation factor

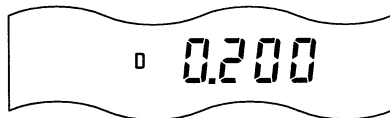

Quality factor

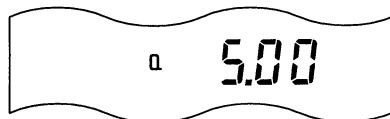

Current measured ★



Voltage measured ★

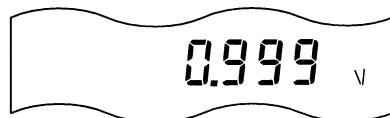

★ Current or voltage is displayed for approximately 3 seconds. The instrument then returns automatically to the parameter you selected beforehand.

The values displayed for the selected parameter are calculated by the instrument. They are based on the values measured for the series reactance and the series resistance (refer to Section 4.1).





Fixing of a Parameter in a Defined Display Position

If you want to measure a series of components with the decision criterion for the dominant parameter near the limit ($Q = D = 1$), you can define in which position of the display the parameters shall be displayed. The display shows the selected combination and the corresponding equivalent circuit symbol:

- R in the upper row and C or L in the middle or
- R in the middle and C or L in the upper row

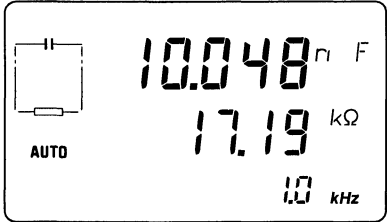
Function and Key Operation

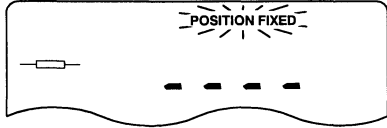
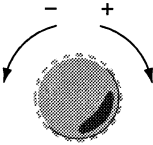
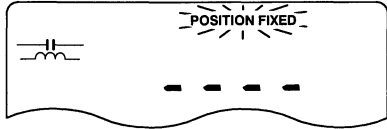
Display

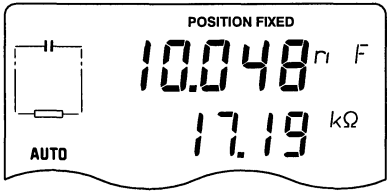
<p>AUTO</p> 	
<p>RCL POSITION</p> 	
	
<p>RCL POSITION</p> 	

If the parameter shown in the middle row is or becomes the dominant one, for example, after CUT exchanging the position of the parameters in the display and the equivalent circuit symbol remain unchanged.

The sign **DOMINANT** is displayed in front of the digits in the middle row to indicate that the parameter shown is now the dominant one.

DOMINANT is not displayed if the parameter shown has been selected manually, for example, SER/PAR, Φ/Z , Q/D, or V_x/I_x .

Function and Key Operation

Display

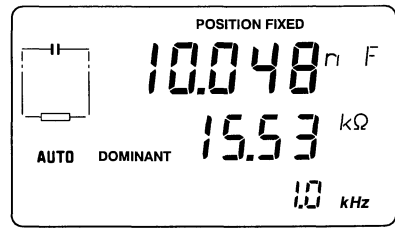

To leave this measuring mode press the **AUTO** key.

Measurement in the Deviation Mode

During measurements the display can simultaneously show the absolute measurement value and the deviation in percent of a previously selected reference value. For this, select DEVIATION SET REF.

Function and Key Operation

Connect a component and select the required measurement mode, for example, AUTO.



Set the reference value.

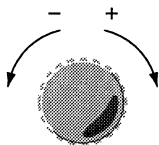

You can set the reference value within a range from half to twice the displayed value.

Display

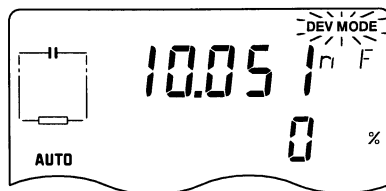
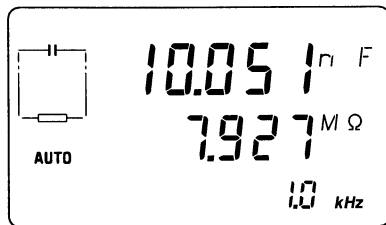

Function and Key Operation

Display

Confirm your setting.

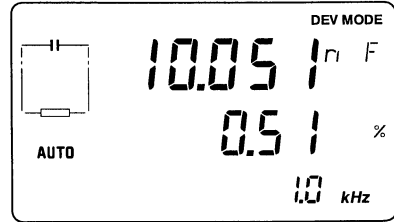

Connect the next component.

The display shows the measured value and the deviation of the previously selected reference in percent.

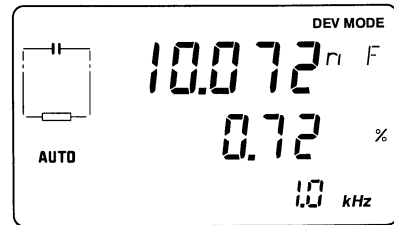

To leave this measuring mode, press the **AUTO** key.

You also can perform relative measurements in the RCL POSITION Mode.

Select the parameter you want to fix in the upper row **at first**;
then select DEVIATION SET REF.

4.5.3 Combination of Measuring Modes

Measuring Mode	AUT	S/P	AVE	POS	DEV	BIN	CON	SGL	AC	DC
AUT (AUTO)		–	○	–	–	–	○	○	○	–
S/P (SERIES/PARALLEL)	–		○	○	○	○	○	○	○	–
AVE (AVERAGE)	○	○		○	○	–	●	–	○	○
POS (POSITION FIXED)	–	△	○		○	–	○	○	○	–
DEV (DEVIATION)	–	△	○	–		–	○	○	○	○
BIN (BIN SORT)	–	△	○	–	–		○	○	○	○
CON (CONTINUOUS)	○	○	□	○	○	○		–	○	○
SGL (SINGLE)	○	○	–	○	○	○	–		○	○
AC (AC MODE)	□	□	○	□	○	○	○	○		–
DC (DC MODE)	–	–	○	–	○	○	○	○	–	

First select the measuring mode shown in the first column; then select the combination shown in the first row.

● = Combination must be selected.

○ = Combination can be selected.

– = Combination not possible.

△ = Combination is automatically switched on.

□ = Mode shown in the first column **must** be switched on when selecting mode shown in the first row.

4.6 MEASUREMENT ACCURACY

The instrument has a **basic accuracy of $\pm 0.1\% \pm 1$ digit.**

This basic accuracy is valid for the dominant parameter for measurements at DC voltages or test signal frequencies (f) up to 50 kHz.

For frequencies >50 kHz the basic accuracy is $\pm 0.1\% \times (f/50 \text{ kHz}) \pm 1$ digit.

The effective measuring accuracy, however, depends on additional factors.

- Measuring speed factor K_S
- Test signal voltage (V_T) factor K_V
- Measuring range limits (Z_{min} and Z_{LIMIT}) factor K_Z

The diagram below shows the measuring accuracy dependent on the impedance of the component and the test signal frequency at normal measuring speed and at 1 V test signal voltage:

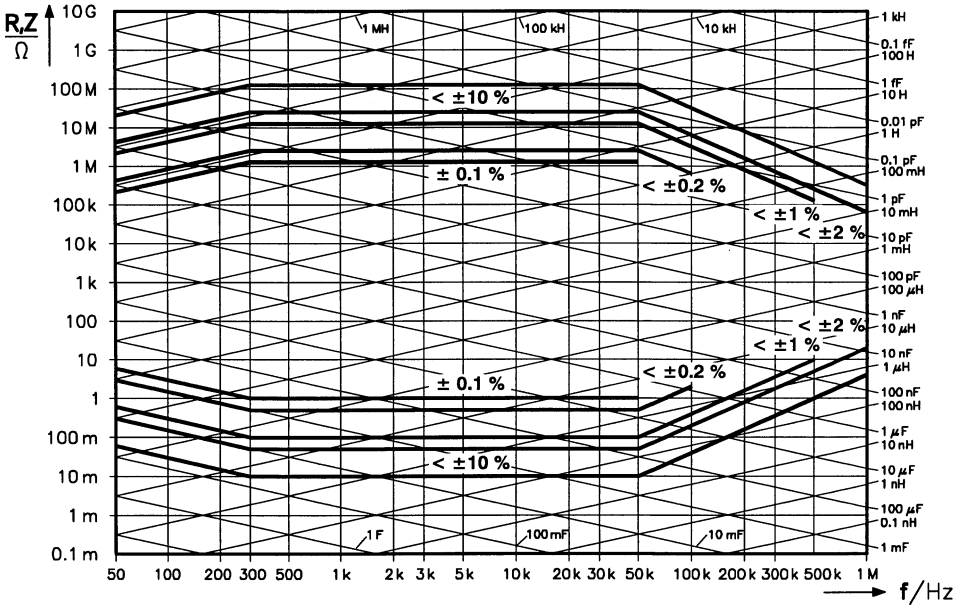

In most cases this diagram will be sufficient for reading the measuring accuracy.

If you want to precisely calculate the effective measuring accuracy for your **measurement with AC**, you can do so by using the following formula:

$$\text{Measuring accuracy} = \pm K_S \times K_V \times K_Z \times \varepsilon_B \pm 1 \text{ digit}$$

$K_S = 1$	at normal measuring speed
$K_S = 10$	at increased measuring speed (FAST)
$K_V = 1$	at test signal voltages of $V_T \geq 0.25 \text{ V}$
$K_V = 0.25 \text{ V}/V_T$	at test signal voltages of $V_T < 0.25 \text{ V}$
$K_Z = Z/Z_{\text{LIMIT}}$	at impedances of $Z > Z_{\text{LIMIT}}$
$K_Z = 1$	at impedances Z within Z_{min} and Z_{LIMIT}
$K_Z = Z_{\text{min}}/Z$	at impedances of $Z < Z_{\text{min}}$
$\varepsilon_B = 0.1 \%$	at test signal frequencies $\leq 50 \text{ kHz}$
$\varepsilon_B = 0.1\% \times (f/50 \text{ kHz})$	at test signal frequencies $> 50 \text{ kHz}$

Take the measuring range limits of the basic accuracy for **dominant components** (Z_{\min} and Z_{LIMIT}) from the following diagram or calculate them for the upper and lower limits by using the following formulas:

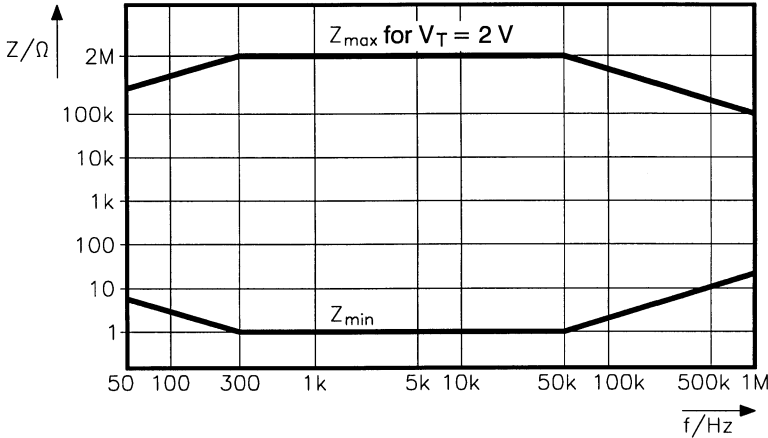

Calculation of Z_{\min} , Z_{\max} , and Z_{LIMIT}

$$Z_{\min} = 1 \Omega \times 300 \text{ Hz}/f \quad \text{at test frequencies of } f < 300 \text{ Hz}$$

$$Z_{\min} = 1 \Omega \times f/50 \text{ kHz} \quad \text{at test frequencies of } f > 50 \text{ kHz}$$

$$Z_{\max} = 2 \text{ M}\Omega \times f/300 \text{ Hz} \quad \text{at test frequencies of } f < 300 \text{ Hz}$$

$$Z_{\max} = 2 \text{ M}\Omega \times 50 \text{ kHz}/f \quad \text{at test frequencies of } f > 50 \text{ kHz}$$

For test signal voltages $< 2\text{ V}$ use Z_{LIMIT}

$$Z_{\text{LIMIT}} = Z_{\max} (0.18 + 0.32 \times V_T/2V)$$

This is also applicable to calculate the values for R, C, or L:

For R and Z Z_{\min} to Z_{LIMIT}

For C $1/(\omega \times Z_{\text{LIMIT}})$ to $1/(\omega \times Z_{\min})$

For L Z_{\min}/ω to Z_{LIMIT}/ω

For calculating the **measuring accuracy for the secondary parameters**, use the formula for AC measurement and multiply by **Factor S**.

$S = D$ (dissipation factor) for secondary L or C if $D > 1$

$S = Q$ (quality factor) for secondary R if $Q > 1$

For **measurements with DC**, use the following formula for your calculations:

$$\text{Measuring accuracy} = \pm K_S \times K_V \times K_R \times \varepsilon_B \pm 1 \text{ digit}$$

$$\begin{aligned} K_R &= R/R_{\max} && \text{at resistances of } R > R_{\max} \\ K_R &= 1 && \text{at resistances within } R_{\min} \text{ to } R_{\max} \\ K_R &= R_{\min}/R && \text{at resistances of } R < R_{\min} \end{aligned}$$

$$\begin{aligned} R_{\min} &= 2 \Omega \times 2 V/V_T \\ R_{\max} &= 1 \text{ M}\Omega \times V_T/2 V \end{aligned}$$

$$\varepsilon_B = 0.1 \%$$

The factors K_S and K_V are the same as for measurements with AC.

Examples for Calculating the Measuring Accuracy:**Example 1**

You wish to measure a resistance of 1 M Ω with a test signal voltage of 2 V AC and a test signal frequency of 1 kHz.

Use the following formula for your calculation:

$$\text{Measuring accuracy} = \pm K_S \times K_V \times K_Z \times \varepsilon_B \pm 1 \text{ digit}$$

wherein are

$K_S = 1$	for normal measuring speed
$K_V = 1$	as the test signal voltage is ≥ 0.25 V
$K_Z = 1$	as there is 1 M Ω within Z_{\min} and Z_{LIMIT}
$\varepsilon_B = 0.1 \%$	as the test signal frequency is < 50 kHz

Consequently the measuring accuracy is as follows:

$$\text{Measuring accuracy} = \pm 1 \times 1 \times 1 \times 0.1 \pm 1 \text{ digit}$$

$$\text{Measuring accuracy} = \pm 0.1 \% \pm 1 \text{ digit}$$

Example 2

You wish to measure a capacitor with a capacity of 0.5 pF, a test signal voltage of 1 V AC, and a test signal frequency of 100 kHz.

The best way to determine the value Z of the capacitor is by a measurement, i.e., key Φ/Z on the instrument. A 0.5 pF capacitor with negligible losses indicates the value $Z = 3.18 \text{ M}\Omega$.

Use the following formula for calculating:

$$\text{Measuring accuracy} = \pm K_S \times K_V \times K_Z \times \varepsilon_B \pm 1 \text{ digit}$$

wherein are

$$\begin{aligned} K_S &= 1 && \text{for normal measuring speed} \\ K_V &= 1 && \text{as test signal voltage } > 0.25 \text{ V} \\ K_Z &= Z/Z_{\text{LIMIT}} = 3.18 \text{ M}\Omega / 0.59 \text{ M}\Omega = 5.38 && \text{as } Z = 3.18 \text{ M}\Omega > Z_{\text{LIMIT}} = 0.59 \text{ M}\Omega \end{aligned}$$

whereby:

$$Z_{\text{LIMIT}} = Z_{\text{max}} (0.18 + 0.82 V_T/2V) = 0.59 \text{ M}\Omega$$

$$Z_{\text{max}} = 2 \text{ M}\Omega \times 50 \text{ kHz}/f = 1 \text{ M}\Omega$$

$$\varepsilon_B = 0.1 \% \times (f/50 \text{ kHz}) = 0.2 \% \quad \text{as test signal frequency } > 50 \text{ kHz}$$

Consequently the measuring accuracy is:

$$\text{Measuring accuracy} = \pm 1 \times 1 \times 5.38 \times 0.2 \pm 1 \text{ digit}$$

$$\text{Measuring accuracy} = \pm 1.076 \% \pm 1 \text{ digit}$$

For detailed information about the measuring range limits and the measuring accuracy, see the Performance Specification in Appendix A, Section 6A.2.

4.7 OUT-OF-RANGE AND ERROR MESSAGES

The middle segments of the digits are displayed when the following limits of measuring ranges are exceeded:

- Resistance >200 M Ω at AC,
> 50 M Ω at DC
- Capacitance > 32 F at 50 Hz, >160 μ F at 1 MHz
- Inductance >637 kH at 50 Hz, >31.8 H at 1 MHz

The asterisk in front of the upper digits indicates that the measured component is outside the measurement range of the basic accuracy limit.

Select a different appropriate test signal and check that the measurement is within the basic accuracy; see Section 4.6.

Other parameter values displayed by the digits in the lower row are secondary parameters and generally not within the basic accuracy range of 0.1 %; see Section 4.6.

After power on, the instrument checks the PROM, the processor RAM, and the external RAM. Additionally the instrument generates error messages if there are faults during measurements or trimming or if there is a fault during data transfer to a printer.

Errors are indicated as follows:

- | | |
|--------------|--|
| Err 1 | Program memory checksum error |
| Err 2 | Processor RAM defective |
| Err 3 | External RAM defective |
| Err 4 | External RAM, backup (current instrument settings) destroyed |
| Err 5 | External RAM, stored instrument settings 1 to 9 destroyed |
| Err 6 | External RAM, stored TRIM or Binning data destroyed |

Err 7	EEPROM defective
Err 8	Error in adjustment data (EEPROM)
Err 9	Error in calibration data (EEPROM)
Err 10	Error during analog to digital conversion of the test signal or during line frequency detection
Err 14	Test signal out of limits during trimming
Err 48	Communication error to the printer (time-out)

Error messages not listed are relevant for the service technician for troubleshooting and recalibration. A detailed description is given in the Service Manual.

During measurement with the bias voltage activated, the display shows **oVEr** if there is excessive DC current flow from the bias source.

The display shows **FAIL** if the short-circuit or open-circuit impedance of the measurement setup is out of range during ZERO TRIM or if the instrument detects defective contacts during ZERO TRIM or CONTACT CHECK.

4.8 STORE/RECALL INSTRUMENT SETTINGS

Nine complete instrument settings including trim data can be stored in memory registers 1 to 9. The current mode is automatically saved separately. The memories are buffered by battery so that the data are retained even after the instrument is turned off.

After power on, the instrument runs through its start routine, and then goes to the mode that was last set.

Store

Data are stored by pressing the STORE key. The display shows the flashing sign **Sto** and a digit from 1 to 9 for the memory register number. This number under which the settings are to be stored can now be selected by using the rotary knob; the measured values are not stored.

Pressing STORE once again saves the settings under the register number selected. Any values that may exist there already are overwritten and lost in the process.

When the instrument is in BIN SORT mode, only the instrument settings will be stored, not the values and tolerances of the bin sets. These values remain unchanged in the memory registers for binning. They can only be changed via remote control.

Recall

Stored settings are called up by pressing the RECALL key. The display shows the flashing sign **rCL**, a memory register number, and the settings stored in the memory. The settings are only displayed but not yet called up.

You can use the rotary knob to select memory register numbers 1 to 9 to display their contents. When you press the RECALL key again, the stored setting displayed is called up.

In BIN SORT mode the instrument settings are called up. The selected values and tolerances for binning remain unchanged.

4.9 BIN SORT (BINNING)

BIN SORT (binning) means sorting components by their measured value into boxes or similar containers.

During the binning process with the PM6306, similar component values are allocated to defined sorting fields known as bins to obtain better tolerances, closer matching or pass/fail sorting.

You can define a maximum of 10 bins. For this purpose, you can use an interface for remote control with a pc (IEEE-488 or RS-232). The Programmers Manual describes the instructions for programming with the pc.

You call up the binning function by pressing the BIN SORT key, selecting a bin set via the rotary knob, and pressing the BIN SORT key again.

The PM6306 checks the component according to the criteria of bins 1 to 9, last of all according to bin 0, and displays the bin the component is allocated to. If none of these requirements are met, the display shows **FAIL**.

Values and limits (tolerances) for 10 complete bin records, each record for a maximum of ten bins (bins 0 to 9), including the selected instrument settings can be stored in registers of the PM6306. These registers are independent of those that contain the instrument settings typed in at the front panel.

A factory programmed default bin set is stored in the memory register 9. For values and tolerances, see table on page 4 – 45.

The limits of the bins can be defined in the following ways according to the various demands:

- Binning components can be defined with a certain value according to different tolerance classes, for example, for quality control or incoming inspection.

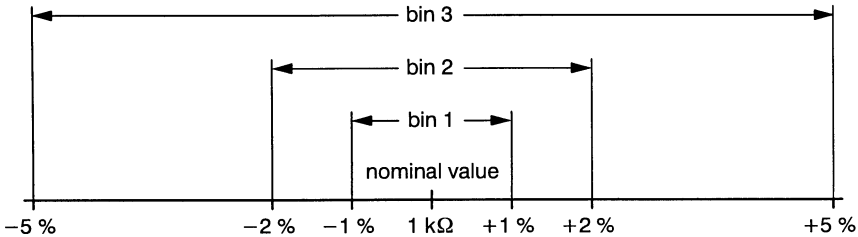

Nested limits with reference to a nominal value.

The instrument checks in the sequence bin 1, bin 2 ... to bin 9 and then bin 0. If the greatest tolerance is programmed for bin 1, then **all components** lying within this tolerance are immediately allocated to bin 1.

A different parameter than that for bin 1 to 9 can be defined for bin 0.

For example, bins 1 to 9 check the tolerance of a capacitor and bin 0 checks at last the quality factor of the capacitor.

The display is as follows:

Component meets tolerance defined in:		Display
bin 1 to 9	bin 0	
YES	YES	bin 1 to 9
NO	do not care	FAIL
YES	NO	bin 0

- Binning components can be defined according to certain values, e.g., resistors according to the series E12, here with $\pm 5\%$.

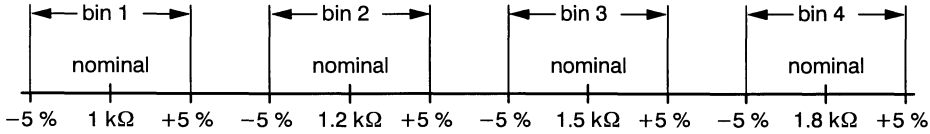

Sequential limits with reference to nominal values.

If limits overlap, a component lying within this overlapping area is always allocated to the bin with the lower number.

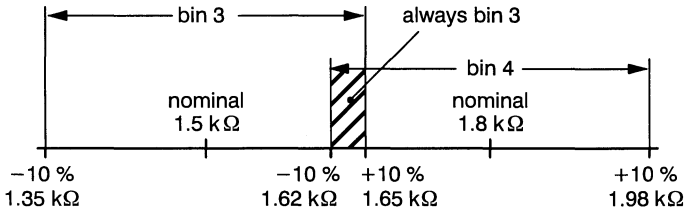

- Nested and sequential limits can be combined.

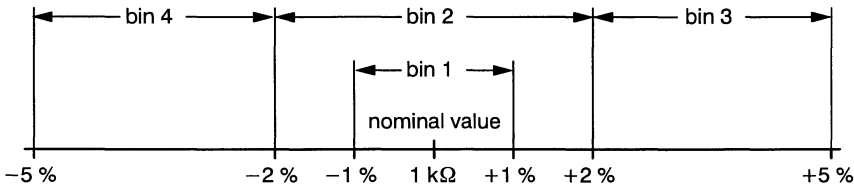

Sequential and nested limits.

The limits can be programmed directly as absolute values instead of a nominal value with an upper and lower limit in percent:

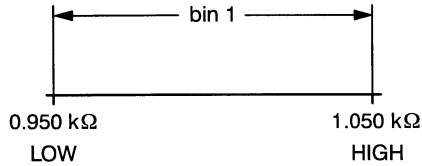

The instrument checks the values programmed for plausibility. A nominal value with an upper limit of +5 % and a lower limit of +5% or a value without limits would not be accepted.

No check is made whether the tolerances selected lie in the accuracy range of the instrument. This accuracy depends on the type and the value of the component to be measured and on the test signal frequency and voltage. Refer to Section 4.6.

Default Bin Record in Memory Register 9

Value and tolerances

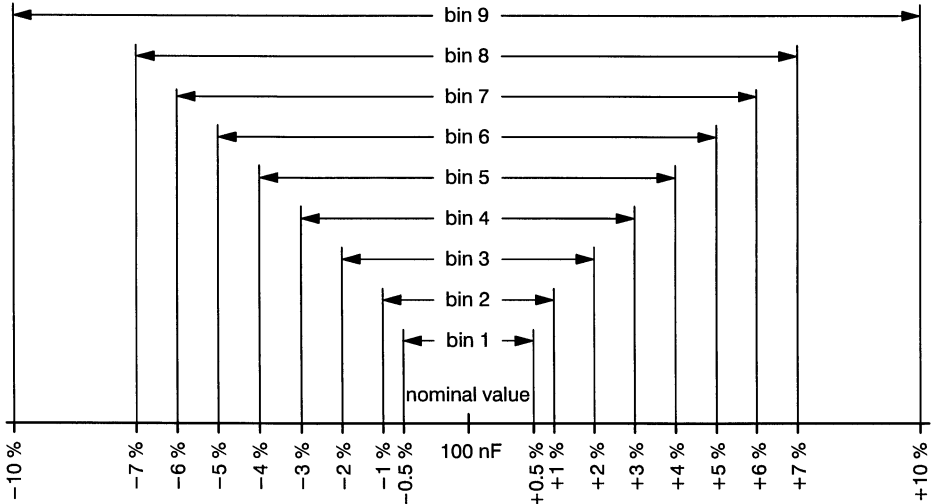

Bin 0: Quality factor between 300 and 600.

Instrument settings:

- Measuring mode PAR (parallel)
- Measurement SINGLE
- Test signal AC
- Test signal level 1 V rms
- Test signal frequency 1 kHz
- DC bias voltage OFF
- RCL POSITION fixed OFF
- AVERAGE OFF
- FIXTURE SET 0

Chapter **5**

FUNCTION REFERENCE

5 FUNCTION REFERENCE

In this section, all functions of the instrument that can be called up at the key panel are described in alphabetical order. Each function description contains:

- A detailed explanation of the function.
- The key sequence for setting or calling up via the keyboard and the relevant display.
- The commands for remote control.

The Programmers Manual contains detailed information about the interfaces for the remote control, the program message syntax, and the complete set of remote control commands.

FUNCTIONS OF THE INSTRUMENT

AC AC Test Signal

Press the AC key to show the current AC test signal voltage. You can change the value from 0.05 V to 2.00 V by turning the rotary knob. Press the key again to confirm and execute the setting. The instrument switches to AC test signal if DC test signal was selected. The display shows the current test signal frequency.



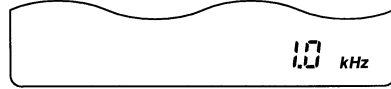
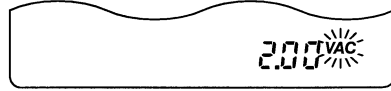
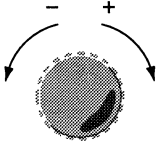

Remote control commands:

Selecting the AC test signal:

TEST_SIG AC

Selecting the value:

AC_LEVEL x x = 0.05 to 2.00

Query for the signal:

TEST_SIG?

Query for the value:

AC_LEVEL?

AUTO Mode

In this mode, the instrument automatically determines the dominant parameter of the component measured and displays the appropriate equivalent circuit symbol. The value of the dominant component is displayed in the upper line, and the value of the secondary parameter is displayed in the line below.

The decision criterion for defining the dominant component is $Q = D = 1$, with Q and D not only dependent on the features of the component but also on the test signal frequency used (see Section 4.2).

Decision criteria for defining the dominant parameter and for the equivalent circuit symbol in the sectors of the phase plane are as follows:

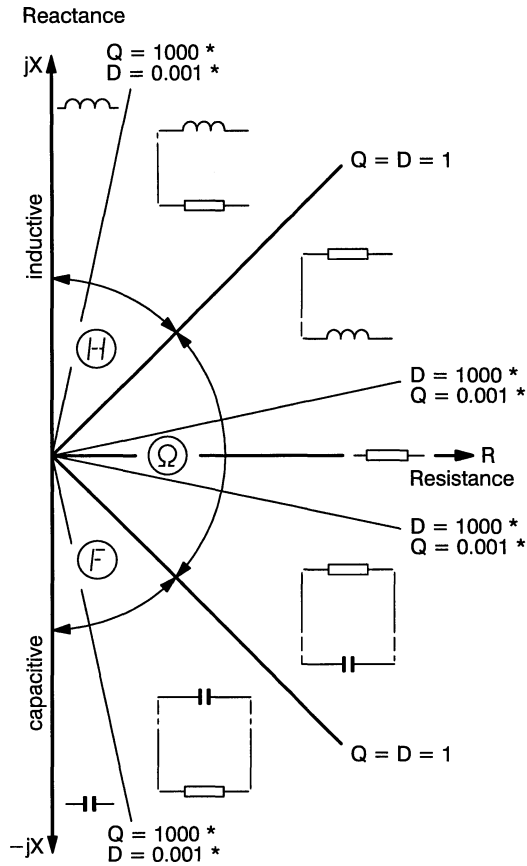

* For test signal voltages ≤ 0.25 V, the decision criterion is $Q = 200$, $D = 0.05$, or $Q = 0.05$, $D = 200$.

AUTO MODE DECISION DIAGRAM



e.g.

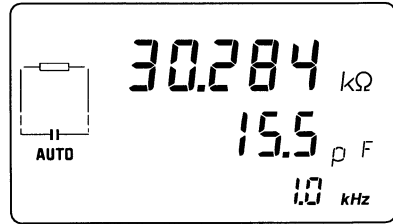

Remote control commands:

Setting:	AUTO
Query for setting:	MODE?
Query for dominant and secondary component, respectively for fixed parameters if RCL POSITION has been selected:	COM?

AVERAGE

With continuous measurement, the instrument performs an exponential average from the individual measurements before the value is shown in the display. This reduces fluctuations in the display. You can select four settings:

OFF

- 1 Low-degree averaging.
- 2 Medium-degree averaging.
- 3 High-degree averaging.

AVERAGE

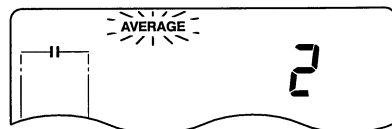

The display shows the flashing sign **AVERAGE** and the current setting. During flashing you can select a different setting via the rotary knob.

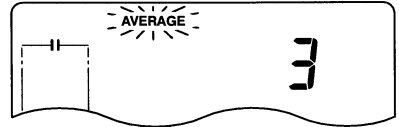
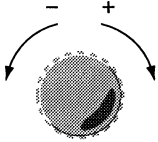

Press the **AVERAGE** key again to confirm the selected setting; otherwise, the instrument returns to the last setting.

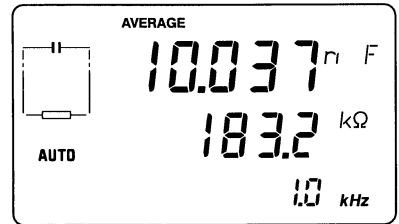

The sign **AVERAGE** remains in the display and works as a reminder that an increased average factor has been selected. For **AVERAGE OFF**, no sign is displayed.

Remote control commands:

Activate: **AVG x** x = 1, 2, or 3

Deactivate: **AVG OFF**

Query: **AVG?**

BIN SORT Binning

Press this key to call up a previously programmed set of bins and to start binning. Programming is only possible via the IEEE-488 or RS-232 Interface. For criterion and tolerances of the bin sets, see Section 4.9.

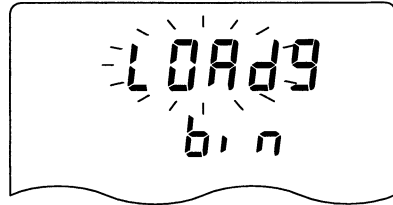

Select a bin set:

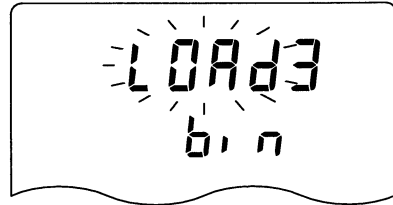
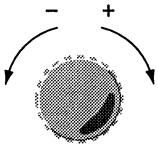

Confirm your setting:

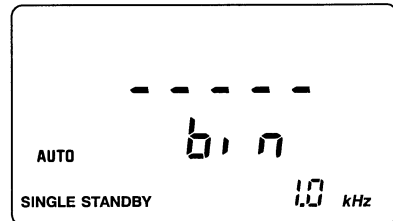

Insert the component.

Start the first single measurement:

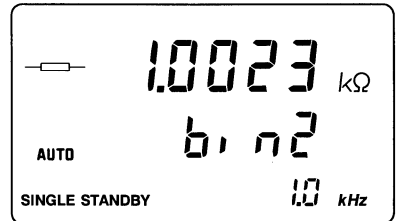

Press the **AUTO** key to switch back to normal mode.

Remote control commands:

Binning on:

BIN ON

Binning off:

BIN OFF

Selecting a bin set:

BIN_RCL x x = 1 to 9

Query for the mode:

BIN?

Query for the data:

BIN_SET?

For the commands to program a set of bins, see the Programmers Manual.

CONT/SINGLE

Continuous/Single Measurement

Press this key to select either continuous or single measurements. For single measurement, the instrument is in a standby status. Press the TRIGGER key to start the measurement. This function is mainly used for binning in the BIN SORT mode. In this way, components can be inserted or removed without the instrument executing a measurement.

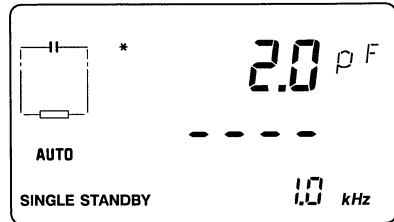

Insert component and take a measurement:

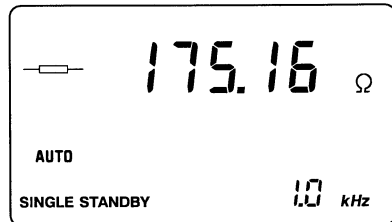
**Remote control commands:**

Setting:

CONTI or SIN

Start of a single measurement:

TRIG

Query:

TRIG?

CONTACT CHECK Checking the Reliability of the Connection

When you press the CONTACT CHECK key, the instrument automatically checks whether the transition impedances between contacts and the component under test are low enough not to affect the measuring accuracy in an inadmissible way.

If the transition impedances between Drive+ and Sense+ are too high, the display shows **CC-HI** and **FAIL**. If the impedances between Drive- and Sense- are too high, the display shows **CC-Lo** and **FAIL**. If the impedances are low enough, the display shows **PASS**.

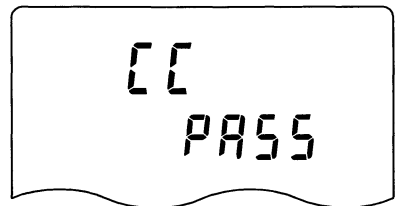
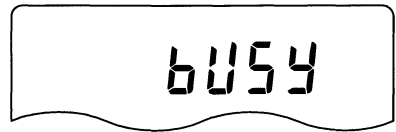

Remote control commands:

CONTA_CHE

D Dissipation Factor

See Q/D

DC DC-Test Signal (Option)

Press the DC key to show the current DC voltage. You can alter the value from 0.05 V to 2.00 V by turning the rotary knob. Press the key again to confirm and execute the setting. The instrument switches to DC voltage if AC voltage was previously selected. The display shows **dc**.

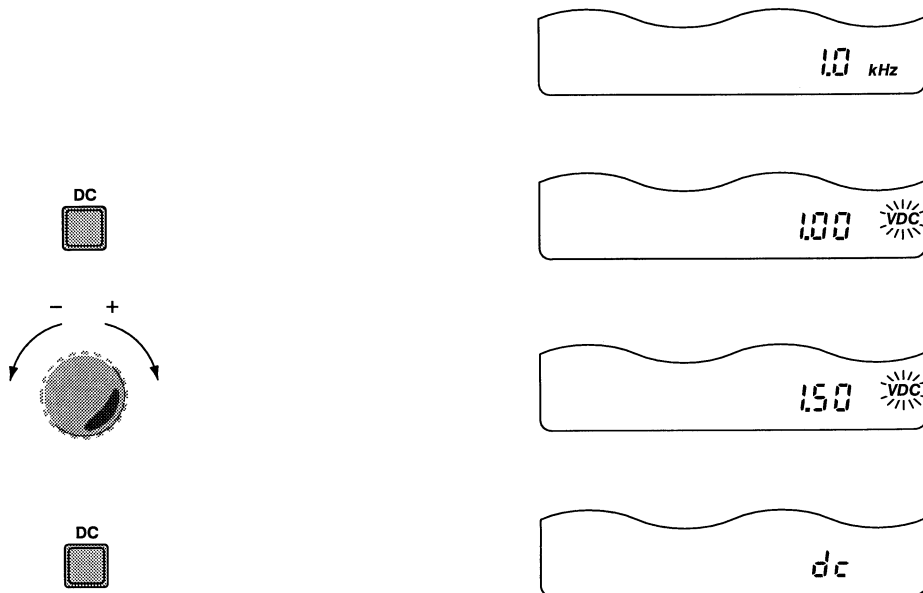
**Remote control commands:**

Selecting the signal:

Setting of the value:

TEST_SIG DC

DC_LEVEL x x = 0.05 to 2.00

Query for the signal:

Query for the value:

TEST_SIG?

DC_LEVEL?

DEVIATION SET REF Relative Offset in Percent

In this mode the current value of the component under test and the deviation in percent of a previously defined reference value is shown simultaneously.

Connect a component to be measured and select the requested measuring mode, for example, AUTO:

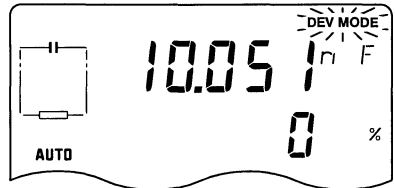
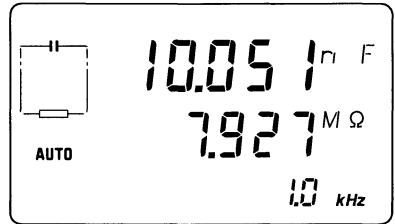

The parameter displayed in the upper row is the reference parameter.

Select the required reference value:

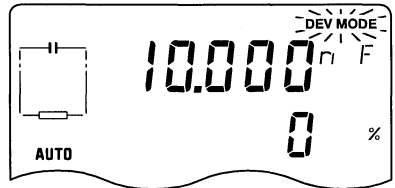
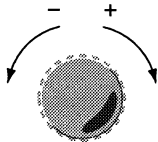

Confirm your setting:

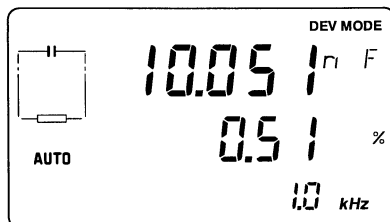

Connect the next component
to be measured:

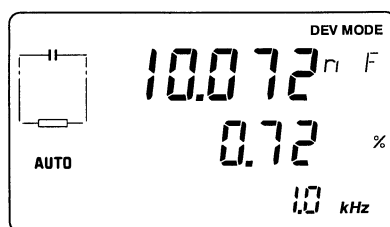

Remote control commands:

Mode on:

DEV ON

Mode off:

DEV OFF

Resistance as reference:

REF_RESI x

Capacitance as reference:

REF_CAP x

Inductance as reference:

REF_INDU x

x = value in Ω , F, or H within the
specified measuring ranges

Current value as reference:

SET_REF

Query for the mode:

DEV?

Query for the reference:

REF?

EXT External DC Bias Voltage

See INT

FIXTURE SET Compensation of the Load capacitance

If you use measuring leads for your setup, an additional capacitance between the LOW contacts and the circuit ground potential can influence the measurement accuracy, especially at test signal frequencies >20 kHz.

Select a setting between 0 and 10 to ensure that the instrument compensates the load impedance.

- 0 for capacitances <50 pF
- 1 for capacitances from 50 to 150 pF
- 2 for capacitances from 150 to 250 pF
- 3 for capacitances from 250 to 350 pF
- 4 for capacitances from 350 to 450 pF
- 5 for capacitances from 450 to 550 pF
- 6 for capacitances from 550 to 650 pF
- 7 for capacitances from 650 to 750 pF
- 8 for capacitances from 750 to 850 pF
- 9 for capacitances from 850 to 950 pF
- 10 for capacitances from 950 to 1050 pF

The test leads supplied from Fluke have a load capacitance of approximately 300 pF. For these select number 3.

For the test posts select number 0.

Select the appropriate setting for FIXTURE SET **before** you perform ZERO TRIM.

FIXTURE
SET

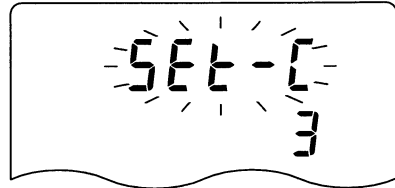
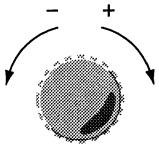
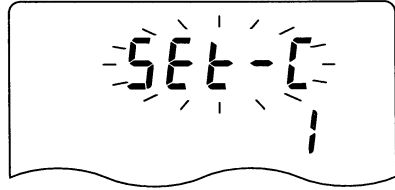

Confirm your setting:

FIXTURE
SET

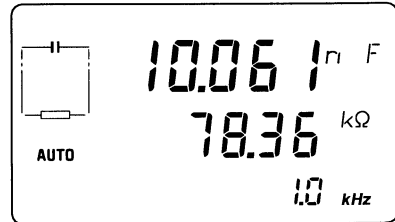

Remote control commands:

Setting:

SET_FIX x x = 0 to 10

Query:

SET_FIX?

FREQ Test Signal Frequency

After you press the FREQ key, the unit of the test signal frequency starts to flash. You can now alter the value by turning the rotary knob. Press the key again to confirm the setting.

Frequency settings:

50 Hz, 60 Hz, 100 Hz, 120 Hz,

200 Hz to 100 kHz

100 kHz to 1 MHz.

in 100 Hz steps,

in 1 kHz steps.

Press the FREQ key longer (>2 seconds) to alter the frequency stepwise:

... ,100 Hz, 1.0 kHz, 10.0 kHz, 100 kHz, 1.00 MHz, 100 Hz, 1.0 kHz, ...

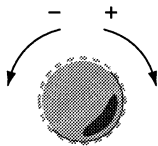
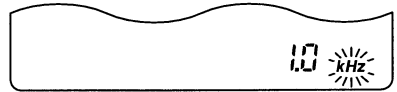

Stepwise alteration:



Keep key pressed.

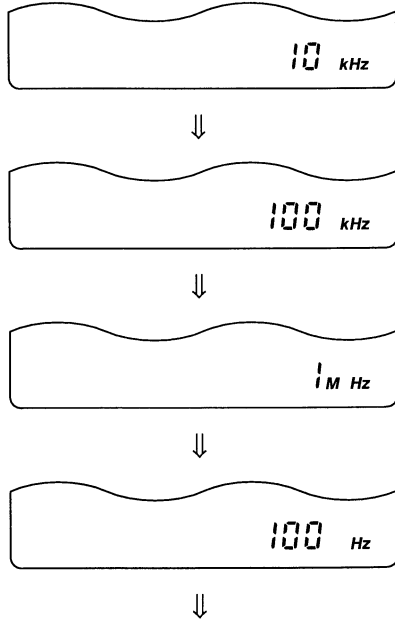

Remote control commands:

Frequency setting:

FREQ x x = frequency value
 in Hz, resolution
 same as for
 manual input

Query for the value:

FREQ?

INT Internal DC Bias Voltage

For measuring electrolytic capacitors, a DC voltage should be supplied to the AC test signal. You may select an internal voltage from 0.0 V to 10.0 V or an external voltage up to 40 V. The external DC voltage is supplied via the sockets at the rear plate of the instrument.

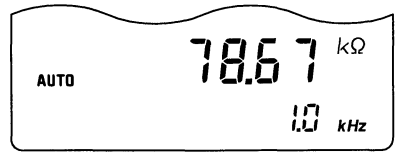

Select internal DC bias voltage:

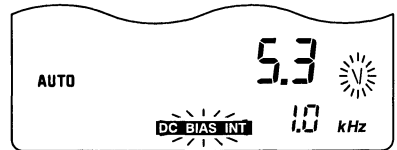

Select the value:

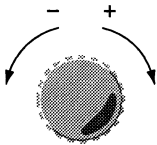

Confirm your setting:

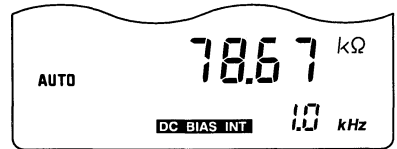

Select external DC bias voltage:

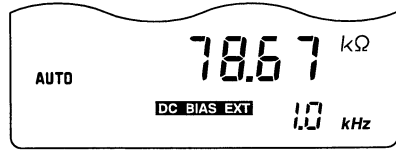

DC bias off:



Remote control commands:

DC bias internal:

DC_BIAS INT

DC bias external:

DC_BIAS EXT

DC bias off:

DC_BIAS OFF

Value for internal DC Bias:

BIAS_VOLT x x = 0.1 to 10.0

Query for the setting:

DC_BIAS?

Query for the value:

BIAS_VOLT?

INTERFACE

Depending on the internal interface, the instrument address (IEEE-488 Interface) is displayed when you press the INTERFACE. Turn the rotary knob to select a different address. With a built-in RS-232 Interface, the display shows **Co** or **Pr** (Communication Mode or Printer Mode) and then the current configuration. Press the INTERFACE key again to step through a menu to select mode of transmission, baud rate, data bits, parity, and handshake via the rotary knob. If more than 3 seconds pass and no key has been pressed, the instrument returns to normal display; altered settings are not stored. To store the settings, press the **INTER-
FACE** key several times until the normal display appears.

INTERFACE

**Display with IEEE-488:**

Address 20

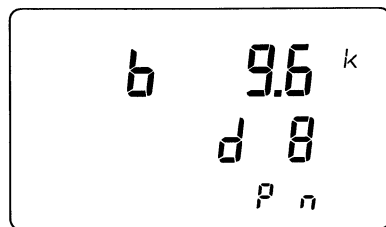
Display with RS-232:Baud rate 9600, data bits 8,
parity none.

The Programmers Manual contains a detailed description about the configuration setting.

I_x Current Measured

Refer to **V_x/I_x** (Voltage/Current).

LOCAL

Press this key to switch back from remote control to keyboard operation. You can lock the key with a remote control command to prevent inadvertent or unauthorized use.



LOCAL

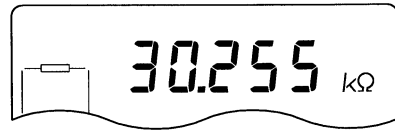

Remote control commands:

No device-specific message

Common commands, e.g., with the PM 2201 interface:

Reset to local:

IOLOCAL

Lock key:

IOLOCKOUT

OFF DC Bias Voltage off

See **INT**

PAR Parallel Parameter

Refer to **SER/PAR**.

Q/D Quality/Dissipation Factor

Press this key to display the quality factor Q or dissipation factor D calculated by the instrument for the component up to 1000 or 0.001, which is 200 or 0.01 for test voltage <0.25 V.

Q and D not only depend on the features of the component but also on the test signal frequency used; refer to Chapter 4.

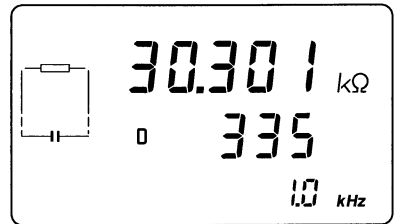
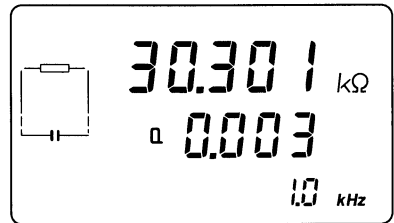

Remote control commands:

- Setting: PARAM QUA or PARAM DISS
- Query for setting: PARAM?
- Query for value: QUAL? or DISS?

RCL POSITION

Fixing a Parameter in a Defined Display Position

With this key you can determine which parameter shall be displayed in the upper row of the display, R or C/L. The corresponding second parameter is displayed in the middle row. If this parameter becomes the dominant one the sign **DOMINANT** appears in the middle row in front of the digits.

AUTO

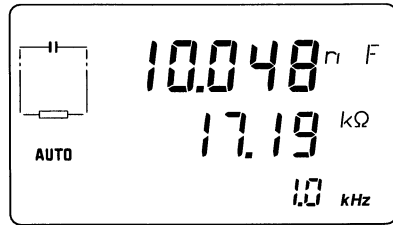

RCL
POSITION

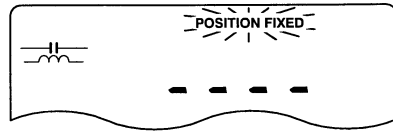
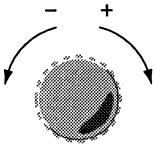
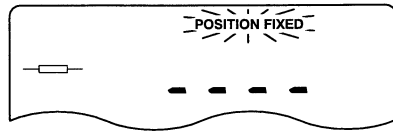

RCL
POSITION

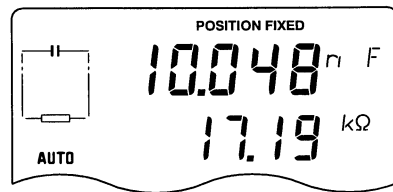

If the parameter in the middle row is the dominant one:

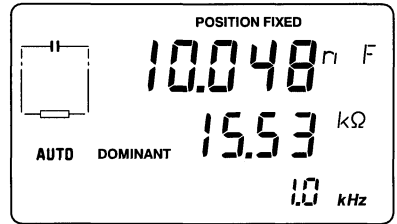

Remote control commands:

- R in the upper row: POS_FIX R
- C in the upper row: POS_FIX C
- L in the upper row: POS_FIX L
- C or L in the upper row: POS_FIX CL

- Mode on: POS_FIX ON
- Mode off: POS_FIX OFF

- Query: POS_FIX?

After the query COM? the response shows the fixed parameter at first in the string, regardless whether it is the dominant one or not.

RECALL

Press the RECALL key. The display shows *rCL*, the present storage register number and the stored instrument settings. Turn the rotary knob to select registers 1 to 9. Press the RECALL key again to load the setting displayed including trim data.

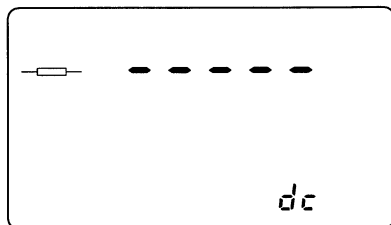
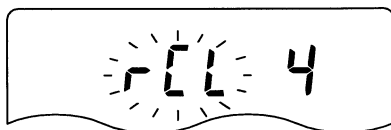
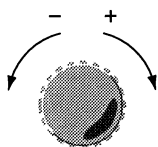
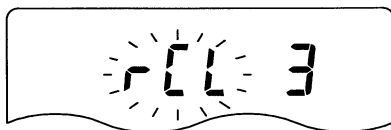

Remote control commands:

*RCL x

x = Storage registers 1 to 9

SER/PAR Series or Parallel Parameter

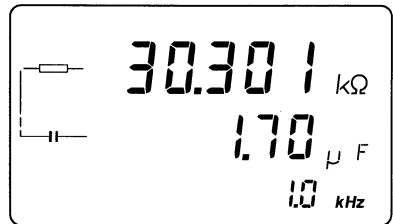
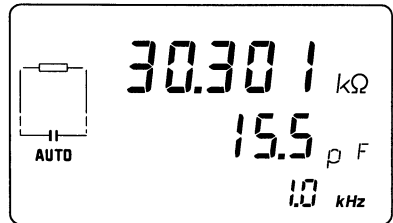
In the AUTO mode when the instrument has determined a resistance as the dominant parameter with a shunt capacitance and when it displays the relevant equivalent circuit symbol, you can display the calculated series resistance and capacitance of the component by pressing the SER/PAR key; the sign **AUTO** is switched off. Press the key once again to display the shunt parallel parameters again. This function applies to all components whose equivalent circuit symbols are shown under the keyword for AUTO mode. The instrument uses the phase diagrams and formulas listed in Section 4.1 as the basis for the calculations.



Remote control commands:

Setting:

SER or PARAL

Query for the setting:

MODE?

Query for the value of the serial/parallel parameter:

CAP? or RESI? or INDU?

SINGLE Single Measurement

Refer to **CONT/SINGLE**.

STORE

You can store nine different instrument settings including trim data of the measurement setup by means of this function. The settings are retained even after power off of the instrument.

Select the mode desired and press the **STORE** key. The display shows **Sto** with the present storage register number. Turn the rotary knob to select a location between 1 and 9. Press the STORE key again to save the instrument settings (not the measuring results). The last setting prior to power-off of the instrument is automatically stored in register 0.

To recall the settings, refer to **RECALL**.

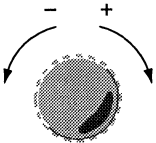
STORE

STORE**Remote control commands:**

*SAV x

x = Storage register 1 to 9

TRIGGER Starting a Single Measurement

Refer to **CONT/SINGLE** (continuous/single measurement).

 V_x/I_x Voltage/Current

Press this key to display the voltage V or current I measured at the component. After approximately 3 seconds, the display jumps back to the parameter selected beforehand (not in remote control operation).

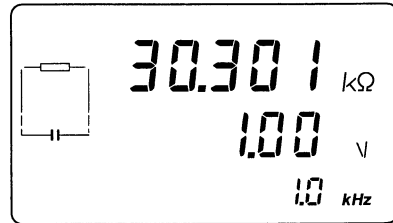
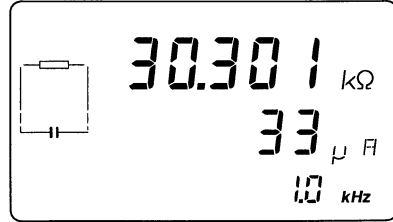
Remote control commands:

Setting:

PARAM VOL or PARAM CUR

Query for setting:

PARAM?

Query for value:

VOL? or CUR?

Z Impedance

 Refer to Φ/Z at the end of this list.

ZERO TRIM Automatic Zero Trimming

When you are measuring components of low impedances, line and contact impedances can falsify the measuring result. When you are measuring high impedances, this can also be the case due to the parallel impedance of the measurement setup.

Before you press the ZERO TRIM key select the required measurement setup and the appropriate setting for FIXTURE SET, see page 3 – 10.

When you press the key you can select TRIM 1 or TRIM A (all) via the rotary knob. Press the key again and the instrument measures the short-circuit impedance and the open-circuit impedance of the measurement setup. The values are stored and taken into account for each following measurement.

If you select TRIM A, the instrument measures with the test frequency selected, with 15 additional frequencies, and with DC, if an DC Unit is built-in. The instrument interpolates the impedances for the complete frequency range. If you change the measurement setup for subsequent measurements or if the temperature difference between ZERO TRIM and measurement is $>10\text{ }^{\circ}\text{C}$, you should perform ZERO TRIM again.

If you select TRIM 1, the instrument only measures with the test frequency selected. You should perform ZERO TRIM again if you change the measurement setup, if you select different test frequencies for subsequent measurements, or if the temperature difference between ZERO TRIM and measurement is $>10\text{ }^{\circ}\text{C}$.

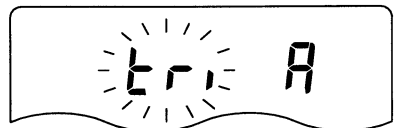
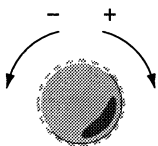

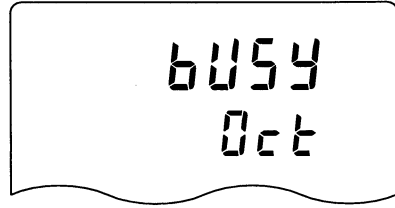
ZERO
TRIM

After open-circuit measurements:

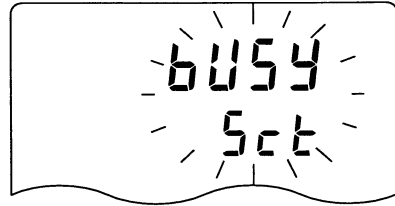

Short-circuit the contacts:

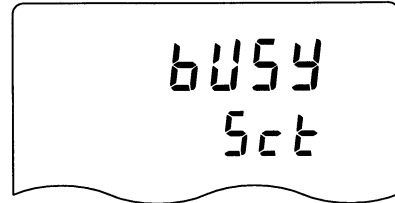
ZERO
TRIM

After short-circuit measurements:



If the short-circuit impedance is too high or if the open-circuit impedance is too low to be trimmed by the instrument, the display shows **FAIL**.

For more details, see Section 4.3.

Remote control commands: TRIM, TRIM SINGLE or TRIM ALL

Short-circuit and open-circuit trimming are not automatically performed in a sequence. If you short-circuit the contacts after open-circuit trim or if you open the contacts after short-circuit trim, send the TRIM command again to start the second step of the trimming procedure.

Φ/Z Phase Angle Phi / Impedance

Press this key to display the impedance of the component. Press it again to display the phase angle between the current and the voltage measured at the component.

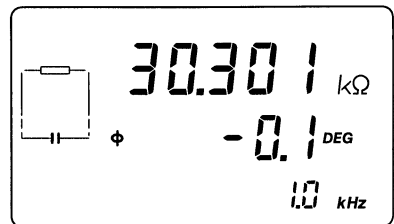
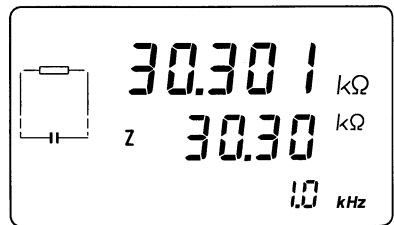

Remote control commands:

Setting: PARAM IMP or PARAM PHA

Query for setting: PARAM?

Query for value: IMP? or PHA?

Chapter **6A**

CHARACTERISTICS

6A CHARACTERISTICS

6A.1 SAFETY AND EMC REQUIREMENTS

The PM6306 Programmable Automatic RCL Meter DC – 1 MHz is

in accordance with EN 61010-1 (safety requirements),

an electrical instrument for measurement and test including accessories

- intended for professional, industrial process, and educational use.
- Overvoltage Category II, Pollution Degree 2.

in accordance with EN 55011 (radio interference suppression),

an ISM equipment (industrial, scientific, and medical RF-equipment)

- of Group I,
which intentionally generates and/or uses conductively coupled radio frequency energy which is necessary for the internal functioning of the equipment itself.
- of Class B,
suitable for use in domestic establishments and in establishments directly connected to a low voltage power supply network which supplies buildings used for domestic purposes.

in accordance with EN 50082-1 (radio frequency immunity)

an instrument for use in all locations which

- are characterized by being supplied directly at low voltage from the public mains.
- are considered to be residential, commercial or light-industrial, both indoor and outdoor.

6A.2 PERFORMANCE SPECIFICATION

Properties expressed in numerical values with stated tolerance are guaranteed by the manufacturer. Specified non-tolerance values indicate those that could be nominally expected from the mean of a range of identical instruments. This specification is valid after the instrument has warmed up for 30 minutes and for reference conditions; see Section 6A.4.

MEASURED CUT PARAMETERS

(CUT = Component Under Test)

R Resistance

C Capacitance

L Inductance

Q Quality factor

D Dissipation factor

Z Impedance

Φ Phase angle

% Deviation If DEVIATION is selected.

V_x CUT voltage drop { V_x and I_x are calculated from source voltage, source

I_x Current through CUT { resistance, and measured CUT properties.

CIRCUIT MODES

Series or parallel selectable

TEST FREQUENCY	DC, 50, 60, 100, 120 Hz, 200 Hz to 100 kHz, 101 kHz to 1 MHz; selectable by rotary knob or via interface	Instruments with DC UNIT. In 100 Hz steps. In 1 kHz steps.
▪ Step mode frequencies	100 Hz, 1 kHz, 10 kHz, 100 kHz, 1 MHz	Manual frequency stepping by using the FREQ key.
Frequencies for FAST mode	200 Hz to 100 kHz 101 kHz to 1 MHz	In 200 Hz steps. In 1 kHz steps.
▪ Error limits	$\pm 0.01\%$	Not for: 10.9 kHz 20.5 kHz 48.1 kHz 51.4 kHz 53.5 kHz 74.9 kHz 77.1 kHz 96.2 kHz 367.0 kHz 734.0 kHz 801.0 kHz 874.0 kHz 983.0 kHz For these frequencies, the error limit is 0.023 % $\pm 0.01\%$.

AC TEST SIGNAL SOURCE

▪ Voltage rms	0.05 V to 2.00 V; selectable by rotary knob	In 0.01 V steps.
▪ Voltage error limits	$\pm 2\% \pm 5\text{ mV}$ $\pm 5\% \pm 5\text{ mV}$ $\pm 10\% \pm 10\text{ mV}$	For $f \leq 20\text{ kHz}$ For $f \leq 100\text{ kHz}$ For $f > 100\text{ kHz}$
▪ Output resistance	100 Ω	

DC TEST SIGNAL SOURCE

- Voltage 0.05 V to 2.00 V; In 0.01 V steps.
selectable by rotary knob
- Voltage error limits $\pm 2\% \pm 5$ mV
- Output resistance 100 Ω

DC BIAS INTERNAL

For capacitors or other non-conductive CUTs.

- Voltage 0 V to 10.0 V; In 0.1 V steps.
selectable by rotary knob
- Voltage error limits $\pm 2\% \pm 10$ mV
- Capacitor-charge time $< 0.03 \text{ ms} \times (C/\mu\text{F}) \times (V/\text{Volt})$ Capacitor-leakage < 1 mA,
C = CUT capacitance,
V = bias voltage.

DC BIAS EXTERNAL

For capacitors or other non-conductive CUTs.

- Voltage 0 to 40 V Via internal 2 k Ω resistor.

DISPLAY

Backlit LCD with simultaneous display of:

- Dominant parameter In the upper section.
- Secondary parameter In the middle section.
- Deviation in % In the middle section.
- Bin number In the middle section.
- Equivalent circuit diagram On the left side.
- Test frequency In the bottom section.
- CUT voltage drop V_x , if selected instead of a secondary parameter In the middle section.
- CUT current I_x , if selected instead of a secondary parameter In the middle section.
- DC bias voltage if INT is selected In the middle section.
- Test source voltage, if selected In the bottom section.
- Status indications, e.g., SINGLE STANDBY In various LCD locations.

OPERATIONAL MODES**RCL AUTO**

Automatic measurement and display of the dominant and the secondary CUT parameter; parallel circuit mode for capacitive CUTs, series circuit mode for inductive CUTs.

Secondary parameter selected

Automatic measurement and display of the dominant and the preselected secondary CUT parameter, e.g., Q.

SER/PAR circuit mode

Selectable display of the series or parallel equivalent circuit and the corresponding CUT parameters.

BIN SORT	Measurement and numerical display of the selected parameter and the corresponding programmed bin number in the presentation bin x with $x = 0, 1, 2, \dots, \text{or } 9$. Programming of the bins can only be performed via IEEE-488 or RS-232 interface. After programming, BIN SORT mode can be started via interface or front panel BIN SORT key.
AVERAGE	Exponential averaging in CONTInuous mode of the displayed measuring values with increased time constant; the degree of averaging can be selected by rotary knob: OFF (LCD segment AVERAGE is off). 1 = low-degree averaging. 2 = medium-degree averaging. 3 = high-degree averaging.
CONTInuous mode	Repetitive measurements and display updates.
SINGLE mode	One measurement and display update after triggering.
RANGE HOLD	Fixed measuring range after RANGE HOLD command via IEEE-488 or RS-232 interface. No LCD indication.
FAST mode	High-speed SINGLE mode for high data rates inclusive for bin sorting via IEEE-488 or RS-232 interface. Restrictions: <ul style="list-style-type: none">▪ Restricted test frequency range (see TEST FREQUENCY).▪ No measuring-result display.▪ Error limits are larger than those specified for normal speed (see MEASURING ACCURACY section).▪ FAST mode can only be activated via IEEE-488 or RS-232 interface.

- DEVIATION mode** Display of the relative (percentage) deviation from a reference value; the reference parameter R, C, or L and its value are fixed by pressing the DEVIATION SET REF key; numerical changes of this reference value can be achieved by using the rotary knob.
- RCL POSITION mode** The parameter R or C respectively L of a CUT can be fixed to the upper numerical display section of the LCD by using the RCL POSITION key and the rotary knob. If the selected parameter is or becomes a secondary one (e.g., by CUT exchange) it still will be displayed in the upper LCD section. This is indicated by the segment DOMINANT in the display in front of the middle section if R, C, or L is displayed.
- CONTACT CHECK** If the CONTACT CHECK key is pressed, the instrument performs measurements on the Kelvin contacts. If the Kelvin contacts are below 3Ω the check will pass.
Duration: approximately 140 ms, $f \geq 400$ Hz
approximately 604 ms, $f < 400$ Hz
- ZERO TRIM FUNCTION** Automatically performed after the ZERO TRIM key has been pressed and TRIM 1 or TRIM A has been selected for compensation of
- The open-circuit adapter impedance if it is
 $> 100 \text{ k}\Omega$ for $f \leq 100 \text{ kHz}$
 $> 100 \text{ k}\Omega \times 100 \text{ kHz}/f$ for $f > 100 \text{ kHz}$
 - The short-circuit adapter impedance if it is $< 10 \Omega$.
- Total trim time: ≤ 10 s for TRIM 1
 ≤ 60 s for TRIM A.

FIXTURE SET

The instrument is programmed by the FIXTURE SET routine to consider the LOW-to-ground capacity C_G of the test fixture for best measuring accuracy. After you press the FIXTURE SET key, the display shows the digit 'n', representing $C_G/100$ pF whereby $n = 0, 1, 2, \dots, \text{or } 10$.

The digit 'n' can be altered by turning the rotary knob, e.g., for PM 9541A $n = 3$ should be selected.

DISPLAY UPDATE RATE

Typical 2 per second for CONTinuous mode.

MEASURING PERIOD

- Typical display-update period for CONT mode after 1st display

for AC	$(1 + 10/f_{[Hz]}) \times 450$ ms
for DC	490 ms

- Typical display-update period for RANGE HOLD in SINGLE MODE

	$(1 + 10/f_{[Hz]}) \times 450$ ms
--	-----------------------------------

- Additional time for SINGLE mode (without RANGE HOLD) or 1st CONT mode display

	240 ms for $Z > 1 \text{ k}\Omega$ and $f \leq 300$ Hz
	40 ms else

- | | | |
|---|-------|--|
| <ul style="list-style-type: none"> ▪ Additional time for 60 Hz power and for test frequencies
60 Hz and 120 Hz | 70 ms | |
|---|-------|--|

- | | | |
|--|----------------------|--|
| <ul style="list-style-type: none"> ▪ Measuring period for FAST mode | 90 ms + 10 ms/f[kHz] | |
|--|----------------------|--|

- | | | |
|--|-------|--|
| <ul style="list-style-type: none"> ▪ Typical additional time for communication via IEEE-488 bus | | |
| for FAST mode | 14 ms | Including trigger, status interrogation, data transfer, data storage; using a PC 486DX-66. |
| for SINGLE mode | 60 ms | Additionally including clear status, parameter query, and display on the monitor. |

COMPONENT (CUT) CONNECTION

- 4-wire connection by Kelvin clips via:
- Test posts, inserted into the front panel banana sockets.
 - PM 9541A, 4-WIRE TEST CABLE
 - PM 9542A, RCL ADAPTER
 - PM 9542SMD, SMD ADAPTER
- PM 9540/BAN, 4-WIRE TEST CABLE with banana plugs.
- 2-wire connection by PM 9540/TWE, SMD TWEEZERS.

MAXIMUM CONSTANT EXTERNAL DC VOLTAGE/CURRENT

- | | |
|--------------------------------------|------------|
| ▪ Between HI and LO or HI and ground | 50 V/50 mA |
|--------------------------------------|------------|

- | | |
|-------------------------|-------------|
| ▪ Between LO and ground | 0.5V/500 mA |
|-------------------------|-------------|

MAXIMUM CHARGED-CAPACITOR DC VOLTAGE

- For $C \leq 2 \mu\text{F}$ 200 V
- For $2 \mu\text{F} < C < 2 \text{mF}$ $47 \times (C/\text{mF})^{-0.234}$
- For $C \geq 2 \text{mF}$ 40 V

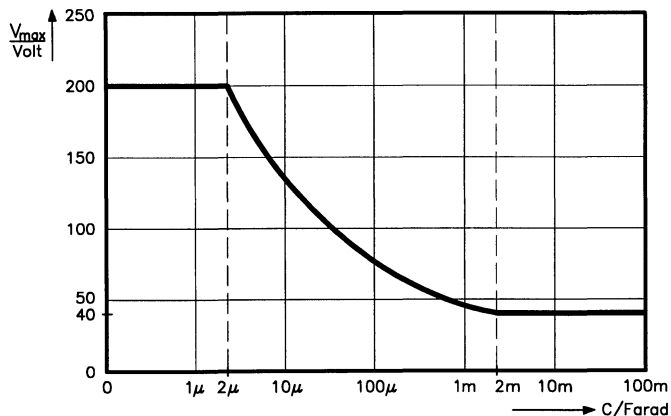

Figure 6A.1 Maximum Charged-Capacitor Voltage

MEASURING RANGES

For R and Z in AC mode	0.0000 Ω to 200 MΩ	Max. resol. 0.1 mΩ
For R in DC mode	0.0000 Ω to 50 MΩ	Max. resol. 0.1 mΩ
For C	0.00 pF to $1/(\omega \times 0.1 \text{ m}\Omega)$, $f \leq 50 \text{ kHz}$	Max. resol. 0.01 pF
	0.00 pF to $1/(\omega \times 1 \text{ m}\Omega)$, $f > 50 \text{ kHz}$	Max. resol. 0.01 pF
For L	0.00 μH to 200 MΩ/ω	Max. resol. 0.01 μH
For Q, D and test voltage > 0.25 V	0.000 to 1000	Max. resol. 0.001
For Q, D and test voltage ≤ 0.25 V	0.00 to 200	Max. resol. 0.01
For Φ	-179 to -100, -99.9 to 0 to 99.9, 100 to 180 deg	
For deviation	-100 % to 500 %	Max. resol. 0.01 %
For V _x	0.1 μV to 2.00 V	Max. resol. 0.1 μV
For I _x	0.005 μA to 20.0 mA	Max. resol. 0.001 μA

MEASURING ACCURACY

Basic error limits in AC mode $\pm \epsilon_B \pm 1$ digit
with

- $\epsilon_B = 0.1\%$ for $f \leq 50$ kHz
- $\epsilon_B = 0.1\% \times (f/50 \text{ kHz})$ for $f > 50$ kHz

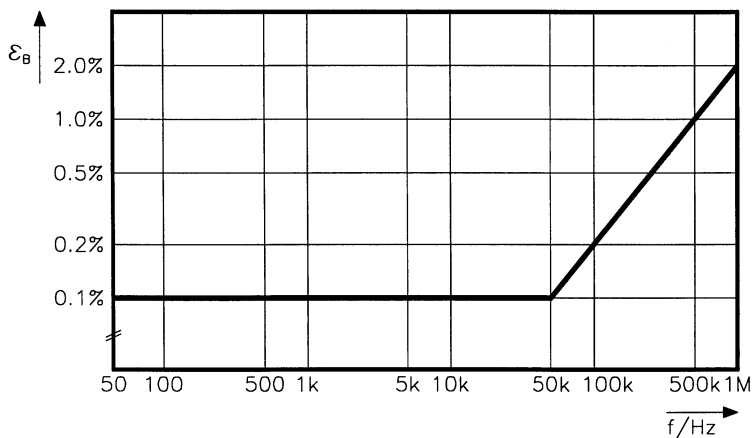

Figure 6A.2 Basic Accuracy ϵ_B versus Test Frequency f

Basic error limits in DC mode $\pm \epsilon_B \pm 1$ digit
with

- $\epsilon_B = 0.1\%$.

Conditions for measuring error limits (basic error limits)

- Measured parameter is dominant for AC mode measurements:
 - D > 1 for R,
 - Q > 1 for C and L.
- Test signal voltage ≥ 0.25 V, according to Figure 6A.3.
- Impedance between Z_{\min} and Z_{LIMIT} , according to Figure 6A.4.
- Normal measuring speed (not FAST mode).
- ZERO TRIM is performed with the actually used test fixture.
- FIXTURE SET is performed considering the actually used test fixture.
- 4-wire test fixtures (see Section CUT CONNECTION) are used.
- Instrument calibration performed within the calibration period.
- Frequency
 - not 60 Hz or 120 Hz at 50 Hz mains or
 - not 50 Hz at 60 Hz mains.For these test frequencies external hum interference may degrade measurement accuracy.

GENERAL MEASURING ERROR LIMITS IN AC MODE

- for R, C, L, or Z $\pm K_S \times K_V \times K_Z \times \epsilon_B \times S \pm 1$ digit

$K_S = 1$	For normal speed
$K_S = 10$	For FAST mode
$K_V = 1$	For $V_T \geq 0.25$ V
$K_V = 0.25 V/V_T$	For $V_T < 0.25$ V
According to Figure 6A.3, V_T = test source voltage.	
$K_Z = Z/Z_{LIMIT}$	For $Z > Z_{LIMIT}$
$K_Z = 1$	For $Z_{min} \leq Z \leq Z_{LIMIT}$
$K_Z = Z_{min}/Z$	For $Z < Z_{min}$
According to Figure 6A.4.	
$\epsilon_B = 0.1 \%$	For $f \leq 50$ kHz
$\epsilon_B = 0.1 \% \times (f/50 \text{ kHz})$	For $f > 50$ kHz
$S = Q$	For L or C, $Q > 1$
$S = 1$	For dominant parameter
$S = D$	For R, $D > 1$

- for $Q \geq 1$ $\pm E \times (1 + Q) \pm 1$ digit E = C or L error limit

- for $D \geq 1$ $\pm E \times (1 + D) \pm 1$ digit E = R error limit

- for Φ $\pm 1.2 \times E \pm 1$ digit E = dominant parameter error limit

- for V_x

50 Hz to 200 Hz	$\pm 15 \% \pm E_s \pm 1$ digit $\pm E$	E _s = error for source voltage
300 Hz to 20 kHz	$\pm 3 \% \pm E_s \pm 1$ digit $\pm E$	E = Z error, E = 0 for $Z > 10 \text{ k}\Omega$
20.1 kHz to 100 kHz	$\pm 10 \% \pm E_s \pm 1$ digit $\pm E$	
101 kHz to 1 MHz	$\pm 15 \% \pm E_s \pm 1$ digit $\pm E$	

- for I_x

50 Hz to 200 Hz	$\pm 15 \% \pm E_s \pm 1 \text{ digit} \pm E$	$E_s = \text{error for source voltage}$
300 Hz to 20 kHz	$\pm 3 \% \pm E_s \pm 1 \text{ digit} \pm E$	$E = Z \text{ error}, E = 0 \text{ for } Z < 10 \text{ k}\Omega$
20.1 kHz to 100 kHz	$\pm 10 \% \pm E_s \pm 1 \text{ digit} \pm E$	
101 kHz to 1 MHz	$\pm 15 \% \pm E_s \pm 1 \text{ digit} \pm E$	

GENERAL MEASURING ERROR LIMITS IN DC MODE

- for R

$$\pm K_S \times K_V \times K_R \times \varepsilon_B \pm 1 \text{ digit}$$

$$K_S = 1 \quad \text{For normal speed}$$

$$K_S = 10 \quad \text{For FAST mode}$$

$$K_V = 1 \quad \text{For } V_T \geq 0.25 \text{ V}$$

$$K_V = 0.25 V/V_T \quad \text{For } V_T < 0.25 \text{ V}$$

According to Figure 6A.3,

$V_T = \text{test source voltage.}$

$$K_R = R/R_{\max} \quad \text{For } R > R_{\max}$$

$$K_R = 1 \quad \text{For } R_{\min} \leq R \leq R_{\max}$$

$$K_R = R_{\min}/R \quad \text{For } R < R_{\min}$$

$$R_{\min} = 2 \Omega \cdot 2 V/V_T$$

$$R_{\max} = 1 \text{ M}\Omega \cdot V_T/2V$$

$$\varepsilon_B = 0.1 \%$$

- for V_x

$$\pm 3 \% \pm E_s \pm 1 \text{ digit} \pm E \quad \begin{array}{l} E_s = \text{error for source voltage} \\ E = R \text{ error}, E = 0 \text{ for } R > 10 \text{ k}\Omega \end{array}$$

- for I_x

$$\pm 3 \% \pm E_s \pm 1 \text{ digit} \pm E \quad \begin{array}{l} E_s = \text{error for source voltage} \\ E = R \text{ error}, E = 0 \text{ for } R < 10 \text{ k}\Omega \end{array}$$

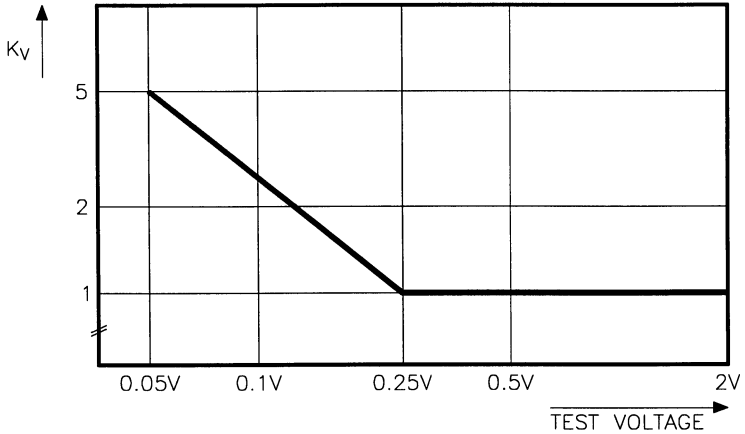
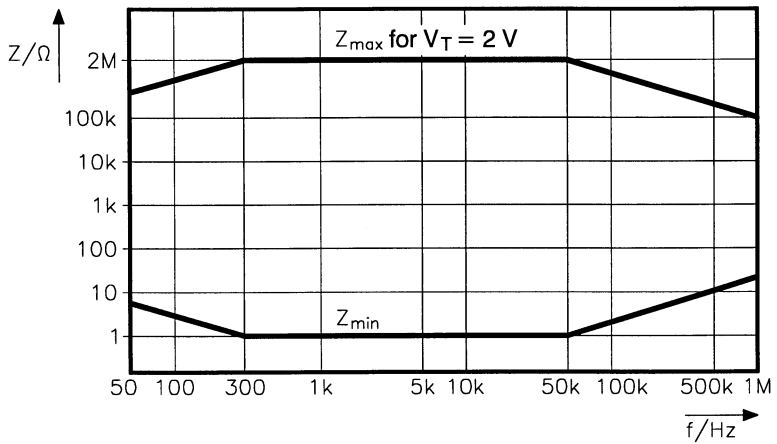

Figure 6A.3 Accuracy Degradation Factor K_V versus Test Voltage



$$Z_{\text{LIMIT}} = Z_{\text{max}} \times (0.18 + 0.82 \times V_T/2V)$$

Figure 6A.4 Z_{min} and Z_{LIMIT} used for K_Z calculation.

CALIBRATION PERIOD 1 year

BIN SORT

- Total number of programmable bins 10, bin 0 to bin 9.
- Bin limits Absolute or relative.
- Relative bin location Sequential or nested.
- Bin programming Via IEEE-488 or RS-232 interface.
- Activating of BIN SORT mode Via interface or BIN SORT key.

STORAGE REGISTERS 10 for complete instrument settings independent of the registers for the bin sets; register 0 is used for the actual settings and is automatically updated.
All storage registers are nonvolatile.

10 for maximum 10 bin sets; in register 0 the actually programmed bin set is saved when switching over to bin sort mode or normal mode.
All storage registers are nonvolatile.

6A.3 POWER SUPPLY

AC power

- Nominal voltage rms 100 V, 120 V, 220 V, or 240 V selectable at power input connector.
- Reference voltage 220 V ± 2 %
- Operating limits nominal voltage ± 10 %

- Nominal frequency range 50 Hz to 60 Hz
- Operating limit frequency range 47.5 Hz to 63 Hz
- Power consumption 44 VA
- Power cable versions Alternatively supplied for
 - Universal Europe
 - North America
 - England (U.K.)
 - Switzerland
 - Australia

6A.4 ENVIRONMENTAL CONDITIONS

Ambient temperature

- Reference and nominal operating range 0 °C to 50 °C
- Storage and transport range -40 °C to 70 °C

Relative humidity

- Reference range 45 % to 75 %
- Nominal operating range 20 % to 80 %
- Limit range for use 10 % to 90 %
- Storage and transport range 0 % to 90 %

Air pressure

- | | | |
|---------------------------------|---------------------|--------------------------------------|
| ▪ Reference and operating range | 690 hPa to 1060 hPa | 3,050 to 360 m relative to sea level |
| ▪ Storage and transport range | 570 hPa to 1060 hPa | 4,570 to 360 m relative to sea level |

Air speed

- | | |
|---------------------------|--------------|
| ▪ Reference range | 0 to 0.2 m/s |
| ▪ Nominal operating range | 0 to 0.5 m/s |

Heat radiation

Direct sunlight radiation not allowed.

Vibration

- | | |
|------------------------------------|--|
| ▪ Limits for storage and transport | Max. amplitude 0.35 mm, max. acceleration 5 g (10 to 150 Hz) |
|------------------------------------|--|

Functional shock

MIL-T-28800D

- | | |
|----------------|------|
| ▪ Acceleration | 20 g |
|----------------|------|

Operating position

Normally upright or flat with bow fold down.

Warm-up time

30 minutes

6A.5 SAFETY & QUALITY DATA; CABINET

Safety	According to Low Voltage Directive 73/23/EEC, EN 61010–1 CAT II Pollution Degree 2 CSA 22.2 no.1010-1.
Protection type	IP 20 (IEC 529)
EMC	According to Electromagnetic Compatibility Directive 89/336/EEC. Emission according to EN 55 011, Group 1, Class B. Immunity according to EN 50 082-1, inclusive EN 61000–4–2, –3 and –4.
Call rate	< 0.2 units per year
MTBF (calculated)	20,000 hours
Cabinet dimensions	<ul style="list-style-type: none">▪ Width 315 mm (12.4")▪ Height 105 mm (4.13")▪ Depth 405 mm (15.9")▪ Weight 5.3 kg (11.7 lb)

6A.6 OPTIONS, ACCESSORIES

OPTIONS

PM 9548 IEEE-488 INTERFACE

Interface functions	AH1, SH1, L4, T6, RL1, SR1, C0, DC1, DT1, PP0, E2.
Galvanical isolation	Opto-electronically
Instrument command set	See Chapter 5 or Programmers Manual.

PM 9549 RS-232 INTERFACE

Galvanical isolation	Opto-electronically
Instrument command set	Same as for PM 9548, see Chapter 5 or Programmers Manual.
Pre-setting parameters	
▪ Operating mode	Communication or printer mode.
▪ Transmission rate	110, 150, 300, 600, 1200, 2400, 4800, 9600, or 19200 Baud.
▪ Data bits	7 or 8
▪ Stop bits	1, 2 for 110 Baud
▪ Parity check	Odd, even or none (none for 8 data bits only).
▪ X _{ON} /X _{OFF} handshake	On or off

PM 9565 DC UNIT For DC resistance (R_{DC}) measurements; specifications see Section 6A.2.

PM 9566 HANDLER INTERFACE

Connection 15-pin connector at instrument rear side.

Galvanical isolation Opto-electronically

Input

- Function Trigger input for single measurements, especially for binning and FAST mode.
- Signal Active-low TTL or short-circuit to ground;
pulse width > 0.5 ms,
for FAST mode > 0.11 ms.

Outputs 11, for bin 0 to bin 9 and fail bin.

- Configuration Open collector
- Switchable current ≤ 200 mA
- Switchable voltage ≤ 24 V (positive voltage)

The output bin 0 provides a timing signal in FAST measurement mode.

Timing Signal Bin 0 in FAST Mode

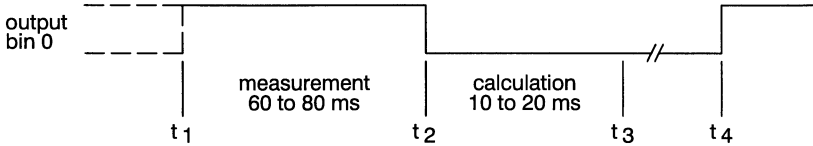

- t_1 : Trigger starts measurement. Measurement time depends on test signal frequency and CUT; 60 to 80 ms at 1 kHz.
- t_2 : End of measurement; CUT can be removed.
- t_3 : Measurement result available.
- t_4 : Trigger starts next measurement.

Timing Signal Bin 0 in FAST Mode during BIN SORT

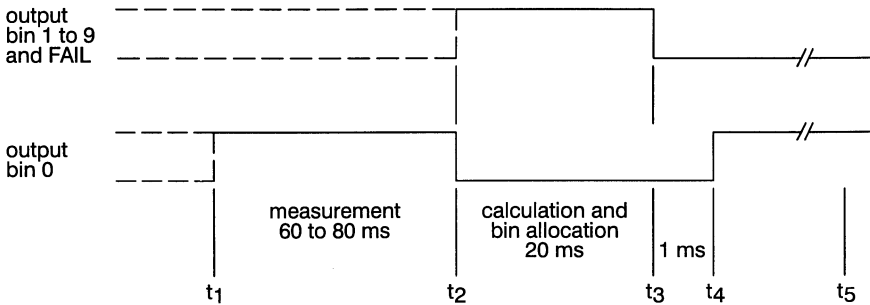

- t_1 : Trigger starts measurement. Measurement time depends on test signal frequency and CUT; 60 to 80 ms at 1 kHz.
- t_2 : End of measurement; CUT can be removed.
- t_3 : Outputs bin 1 to 9 or FAIL are set.
- t_4 : Outputs are valid; CUT can be handled according to the set bin.
- t_5 : Trigger starts next measurement.

ACCESSORIES**STANDARD
ACCESSORIES**

- Power cable
- Fuses
- Test post red 5322 264 30351
- Test post black 5322 264 30352
- Users Manual 4822 872 10141
- Programmers Manual 4822 872 10145

**OPTIONAL
ACCESSORIES**

- PM 9540/BAN, 4-WIRE TEST CABLE with banana plugs
- PM 9540/TWE, SMD TWEEZERS
- PM 9541A, 4-WIRE TEST CABLE ★
- PM 9542A, RCL ADAPTER ★
with 2 single test posts and 1 double test post
- PM 9542SMD, SMD ADAPTER
- PM 9536/041, 3 m RS-232 cable
- PM 2295/10, 1 m IEEE-488 BUS CABLE
- PM 2295/20, 2 m IEEE-488 BUS CABLE
- PM 9563, RACK MOUNT KIT (3E high)
- PM 9564, RACK MOUNT KIT (2E high)
- Service Manual 4822 872 15147
- Test Set 5322 310 32273
- Recalibration Set 5322 310 32274
- SW63W ComponentView PC Software

★ The PM 9541A Test Cable and the PM 9542A RCL Adapter have an improved cable from fall 1995 onwards (black cable jacket). If you have already a cable or an adapter with a grey cable you should not use it at test frequencies > 100 kHz if the ambient temperature is unstable during measurement.

Chapter **6B**

PERFORMANCE TEST

6B.3 SELF-TEST ROUTINE

After power on, the instrument checks the PROM, the processor RAM, and the external RAM. After that, it displays the current software version (Vx.x) and automatically recalls its settings before power off. The instrument also generates error messages if there are faults during measurements or trimming or if there is a fault during data transfer to a printer.

A possible fault is indicated as follows,

for example: **Err 2**

For detailed description see Chapter 4.7.

6B.4 PERFORMANCE VERIFICATION

6B.4.1 Test Signal Voltage

Conditions: No component connected to PM6306.

Test equipment: AC rms Voltmeter, DC Voltmeter

- Set PM6306 to AUTO and to DC BIAS OFF.
- Connect AC rms Voltmeter with tips to pin 8 (HIGH terminal) and pin 1 (circuit ground) of the round connector.
Pin 1 must be connected to the outer part (ground) of the BNC connector of the AC rms Voltmeter.
Use short measurement leads.

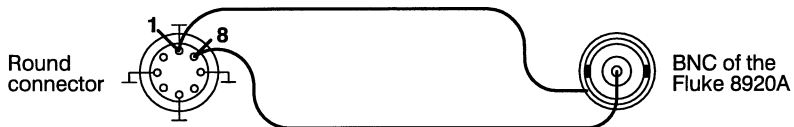

Test Signal Frequency	Test Signal Voltage	Test Result Requirement
1 kHz	2.00 V	1.955 to 2.045 V
	1.00 V	0.975 to 1.025 V
	0.25 V	0.240 to 0.260 V
	0.05 V	0.044 to 0.056 V
100 kHz	1.00 V	0.945 to 1.055 V
1 MHz	1.00 V	0.895 to 1.105 V

- Connect DC Voltmeter to pin 8 and pin 1.

Test Signal	Test Signal Voltage	Test Result Requirement
DC	2.00 V	1.955 to 2.045 V
	1.00 V	0.975 to 1.025 V
	0.25 V	0.240 to 0.260 V
	0.05 V	0.044 to 0.056 V

6B.4.2 Internal DC Bias Voltage

- Set the PM6306 to AC 0.05 V.
- Set the PM6306 to 1 kHz.
- Set the PM6306 to DC BIAS INTERNAL.

DC Bias Voltage	Test Result Requirement
10.0 V	9.80 to 10.20 V
2.0 V	1.95 to 2.05 V

6B.4.3 Test Signal Frequency

Test equipment: Counter

- Set the counter to 1s gate time.
- Set the PM6306 to 100 kHz test signal frequency.
- Set the PM6306 to 2.00 V AC test signal voltage.
- Connect the counter with tips to pin 8 and pin 1 of the round connector.

Test result: 99.990 to 100.010 kHz

6B.4.4 AC Measurements

- Insert the two single test posts into the two left connectors.
- Perform complete **Automatic Zero Trim** according to the trim procedure in Section 3.4. Use TRIM ALL (triA).
- For short-circuit trimming, short the test posts by a clean wire, diameter approximately 1 mm.
- For all measurements use FIXTURE SET 0.
- Insert the leads of the 1 Ω , 4 Ω , and 100 Ω resistors completely into the test posts.

The **test result requirement** must be calculated in accordance with the instrument tolerance and the resolution of the display, ± 1 **digit** in general.

Example:

Test signal frequency: 100 Hz

Test signal voltage: 1.00 V

CUT: 500 k Ω (CV7 = 500.04 k Ω)

Instrument accuracy: 0.1 % (basic accuracy) ± 1 digit

Test result requirement:

$500.04 \text{ k}\Omega \pm 0.1 \% = 500.04 \text{ k}\Omega \pm 0.50004 \text{ k}\Omega = 499.53996 \text{ to } 500.54004 \text{ k}\Omega$

The display rounds to 5 digit resolution: 499.54 to 500.54 k Ω

± 1 digit: **499.53 to 500.55 k Ω**

Test Signal Frequency	Test Signal Voltage	Test Component	Test Result Requirement
100 Hz	2.00 V	4 Ω	CV2 ± 0.1 %
	1.00 V		CV2 ± 0.1 %
	0.25 V		CV2 ± 0.1 %
	0.05 V		CV2 ± 0.5 %
	2.00 V	500 k Ω	CV7 ± 0.10 %
	1.00 V		CV7 ± 0.13 %
	0.25 V		CV7 ± 0.27 %
	0.05 V		CV7 ± 1.87 %
1 kHz	2.00 V	1 Ω	CV1 ± 0.1 %
	1.00 V		CV1 ± 0.1 %
	0.25 V		CV1 ± 0.1 %
	0.05 V		CV1 ± 0.5 %
	2.00 V	100 Ω	CV3 ± 0.1 %
	1.00 V		CV3 ± 0.1 %
	0.25 V		CV3 ± 0.1 %
	0.05 V		CV3 ± 0.5 %
	2.00 V	1 k Ω	CV4 ± 0.1 %
	1.00 V		CV4 ± 0.1 %
	0.25 V		CV4 ± 0.1 %
	0.05 V		CV4 ± 0.5 %
	2.00 V	10 k Ω	CV5 ± 0.1 %
	1.00 V		CV5 ± 0.1 %
	0.25 V		CV5 ± 0.1 %
	0.05 V		CV5 ± 0.5 %

Test Signal Frequency	Test Signal Voltage	Test Component	Test Result Requirement	
1 kHz	2.00 V	2 M Ω ¹⁾	CV8 \pm 0.10 %	
	1.00 V		CV8 \pm 0.17 %	
	0.25 V		CV8 \pm 0.35 %	
	0.05 V		CV8 \pm 2.50 %	
	2.00 V	100 M Ω	CV9 \pm 5.00 %	
	1.00 V		CV9 \pm 8.48 %	
	2.00 V	10 nF ²⁾	CV10 \pm 0.1 %	
	1.00 V		CV10 \pm 0.1 %	
	0.25 V		CV10 \pm 0.1 %	
	0.05 V		CV10 \pm 0.5 %	
	50 kHz	2.00 V	1 Ω	CV1 \pm 0.1 %
		1.00 V		CV1 \pm 0.1 %
0.25 V		CV1 \pm 0.1 %		
0.05 V		CV1 \pm 0.5 %		
2.00 V		100 Ω	CV3 \pm 0.1 %	
1.00 V			CV3 \pm 0.1 %	
0.25 V			CV3 \pm 0.1 %	
0.05 V			CV3 \pm 0.5 %	
2.00 V		1 k Ω	CV4 \pm 0.1 %	
1.00 V			CV4 \pm 0.1 %	
0.25 V			CV4 \pm 0.1 %	
0.05 V			CV4 \pm 0.5 %	
2.00 V	10 k Ω	CV5 \pm 0.1 %		
1.00 V		CV5 \pm 0.1 %		
0.25 V		CV5 \pm 0.1 %		
0.05 V		CV5 \pm 0.5 %		

Test Signal Frequency	Test Signal Voltage	Test Component	Test Result Requirement
50 kHz	2.00 V	2 M Ω ¹⁾	CV8 \pm 0.10 %
	1.00 V		CV8 \pm 0.17 %
	0.25 V		CV8 \pm 0.35 %
	0.05 V		CV8 \pm 2.50 %
	2.00 V	10 nF ²⁾	CV10 \pm 0.1 %
	1.00 V		CV10 \pm 0.1 %
	0.25 V		CV10 \pm 0.1 %
	0.05 V		CV10 \pm 0.5 %
200 kHz	2.00 V	4 Ω	CV2 \pm 0.4 %
	1.00 V		CV2 \pm 0.4 %
	0.25 V		CV2 \pm 0.4 %
	0.05 V		CV2 \pm 2.0 %
	2.00 V	500 k Ω	CV7 \pm 0.40 %
	1.00 V		CV7 \pm 0.68 %
	0.25 V		CV7 \pm 1.42 %
	0.05 V		CV7 \pm 10.0 %

- 1) If you cannot meet the test results for the 2 M Ω resistor it might be that the test resistor has drifted from its calibrated value. The resistor has a drift of max. <0.04 % in 3 years. Please check whether the resistor should be measured again.
- 2) If you cannot meet the test results for the 10 nF capacitor it might be that the test capacitor has drifted from its labeled original value. Please check whether the capacitor should be measured again.
 The measurement uncertainty must be <0.02 %.
 You can also order a new capacitor; code number 5322 126 13738.
 The original measurement date is indicated on the bag for the capacitor.
 The capacitance drift is specified to <0.2 % in 3 years.
 According to our experience the drift is much lower: <0.04 % in 3 years.
 There are no capacitors with lower drift at the low price of this capacitor on the market.
 If you have access to a low-drift standard capacitor in your calibration laboratory or elsewhere, please make use of.

Test Signal Frequency	Test Signal Voltage	Test Component	Test Result Requirement
1 MHz	2.00 V	100 Ω	CV3 \pm 2.0 %
	1.00 V		CV3 \pm 2.0 %
	0.25 V		CV3 \pm 2.0 %
	0.05 V		CV3 \pm 10.0 %
	2.00 V	1 k Ω	CV4 \pm 2.0 %
	1.00 V		CV4 \pm 2.0 %
	0.25 V		CV4 \pm 2.0 %
	0.05 V		CV4 \pm 10.0 %
	2.00 V	10 k Ω	CV5 \pm 2.0 %
	1.00 V		CV5 \pm 2.0 %
	0.25 V		CV5 \pm 2.0 %
	0.05 V		CV5 \pm 10.0 %
	2.00 V	10 nF	CV10 \pm 2.0 %
	1.00 V		CV10 \pm 2.0 %
	0.25 V		CV10 \pm 2.0 %
	0.05 V		CV10 \pm 10.0 %

6B.4.5 DC Measurements

(for instruments with DC Unit 5 only).

Test Signal	Test Signal Voltage	Test Component	Test Result Requirement
DC	2.00 V	1 Ω	CV1 ± 0.2 %
	1.00 V		CV1 ± 0.4 %
	0.25 V		CV1 ± 1.6 %
	2.00 V	4 Ω	CV2 ± 0.1 %
	1.00 V		CV2 ± 0.1 %
	0.25 V		CV2 ± 0.4 %
	0.05 V		CV2 ± 2.0 %
	2.00 V	10 k Ω	CV5 ± 0.1 %
	1.00 V		CV5 ± 0.1 %
	0.25 V		CV5 ± 0.1 %
	0.05 V		CV5 ± 0.5 %
	2.00 V	500 k Ω	CV7 ± 0.1 %
	1.00 V		CV7 ± 0.1 %
	0.25 V		CV7 ± 0.1 %
	0.05 V		CV7 ± 0.5 %
	2.00 V	2 M Ω	CV8 ± 0.2 %
	1.00 V		CV8 ± 0.4 %
	0.25 V		CV8 ± 1.6 %

Chapter **6C**

PREVENTIVE MAINTENANCE / SELF DIAGNOSTIC

6C PREVENTIVE MAINTENANCE / SELF DIAGNOSTIC

6C.5 GENERAL INFORMATION

This instrument normally requires no maintenance, since none of its components are subject to wear.

However, to ensure reliable and trouble-free operation, the instrument should not be exposed to moisture, heat, corrosive elements or excessive dust.

6C.6 SELF DIAGNOSTIC

In addition to the test during power on a test program is installed which checks the communication from the keyboard, the rotary knob, the remote control interface, and the data transfer to the internal memories.

The test program contains the following 11 subprograms:

- Pro. 1** Display Test
- Pro. 2** Keyboard Test
- Pro. 3** Rotary KnobTest
- Pro. 4** Storage Register Test
- Pro. 5** EEPROM Test
- Pro. 6** Internal C-Bus Test
- Pro. 7** Measurement Data Test for Troubleshooting
- Pro. 8** Measurements without Calibration- and Trim-data
- Pro. 9** Calibration Data Test
- Pro.10** Interface Test
- Pro.11** Auto Adjust Routine

Tests 6, 7, 8, 9, and 11 serve as an aid to the Service Technician for troubleshooting and adjustments. In-circuit measurements with an open instrument are necessary; therefore, those tests are described in the Service Manual.

Press the **LOCAL** key, while turning the instrument on. After the power-on routine the letters **tESt** are shown in the display, then the menu of the test program **Pro. I** to **Pro.II** appears. Press the **LOCAL** key briefly to select and carry out the test required. Press the **LOCAL** key again for about 1 second to return to the menu of the test program. You can use any key, except **LOCAL**, to speed up stepping through the menu of the test program. To leave the test program, turn off the instrument.

PROGRAM 1: DISPLAY TEST

The display test checks the liquid crystal display and the respective decoders/drivers.

When the text **Pro. I** appears in the subprogram menu, press the **LOCAL** key. The text **REMOTE** appears. Press any key. All segments of the display are switched on one after the other. You can stop and release the test with any key. The instrument then waits with the total display lit up until you press the **LOCAL** key to return to the menu of the test program or until you leave the test program by switching the instrument off.

PROGRAM 2: KEYBOARD TEST

This test checks the function of each key as well as those of the keyboard encoder. Press the **LOCAL** key when the text **Pro. 2** appears in the submenu; the display shows **bCodE**. If you press any key in random, the current number of this key appears in the display alone with a control number, for example, **3-00** when the **AVERAGE** key is pressed. This control number is generated by the keyboard encoder and can be changed to **0I, 10, 11, 00** by pressing this key again. The keys are numbered row by row from left to right. For example, the **ZERO TRIM** key has the number 7 and the **STORE** key has number 15.

To return to the menu of the test program, press the **LOCAL** key.

To leave the test program, turn off the instrument.

PROGRAM 3: ROTARY KNOB TEST

This test checks the function of the bit generator and whether the direction of rotation is recognized.

Press the **LOCAL** key when the text **Pro. 3** appears in the menu of the test program. The display shows **InCrE**.

Turn the rotary knob.

The display shows **r** (right) or **L** (left) and the number of pulses generated by the bit generator, depending on the speed of rotation, for example:

r- 24 clockwise rotation
InCr

L- 18 counter clockwise rotation
InCr

If an error is detected, the display shows **Error**.

To return to the menu of the test program, press the **LOCAL** key.

To leave the test program, turn off the instrument.

PROGRAM 4: MEMORY REGISTER TEST

This test checks the memory for the storage of instrument settings and trim data (**ZERO TRIM**). The contents of this memory are not written over or deleted during the test and can be used as usual when the test has been completed.

Press the **LOCAL** key when the text **Pro. 4** appears in the menu of the test program. The test runs automatically. The display shows **rEG 0**, **rEG 1**, **rEG 2**, ... , **rEG 8**, and **PASS** at the end of the test. If the test finds an error, the display shows **Error**.

Press the **LOCAL** key to return to the menu of the test program.

To leave the test program, turn off the instrument.

PROGRAM 5: EEPROM TEST

This test checks the function of the EEPROM for the storage of calibration and adjustment data.

Press the **LOCAL** key when the text **Pro. 5** appears. The test runs automatically. The contents of the memory is not overwritten or deleted during the test. The display shows **EEPro** and **PASS** at the end of the test. If the test finds an error the display shows **Error**.

Press the **LOCAL** key to return to the menu of the test program.

To leave the test program, turn off the instrument.

Programs 6, 7, 8, and 9 serve as an aid to the Service Technician; they are described in the Service Manual.

Note: If you select **Pro. 9** and press the **AUTO** key the instrument switches to a special measurement mode. **Depending on the settings in test 9 the instrument does not take the calibration and/or the trimming data into account anymore.** Switch the instrument off and on again to return to the normal measurement mode.

PROGRAM 10: INTERFACE TEST (RS-232 or IEEE-488)

This test checks the built-in interface, its inputs and output buffers, and the correct coding and decoding of the data transferred.

Press the **LOCAL** key when the text **Pro.10** appears. The test automatically checks which interface is built-in; if none, **noBUS** appears in the display and the instrument automatically returns to the menu of the test program. In instruments with interface, there is a choice between an input test (**IdAtA**), an output test (**OdAtA**), and a read-out of the device status (**StAt**). Selection is done by pressing any key (except **LOCAL**). For the IEEE-488 Interface the device address is set to 20. The configuration for the RS-232 interface is: Baud rate 9600, data bits 8, parity no. Using the RS-232 Interface the instrument must be set to remote with ESC 2.

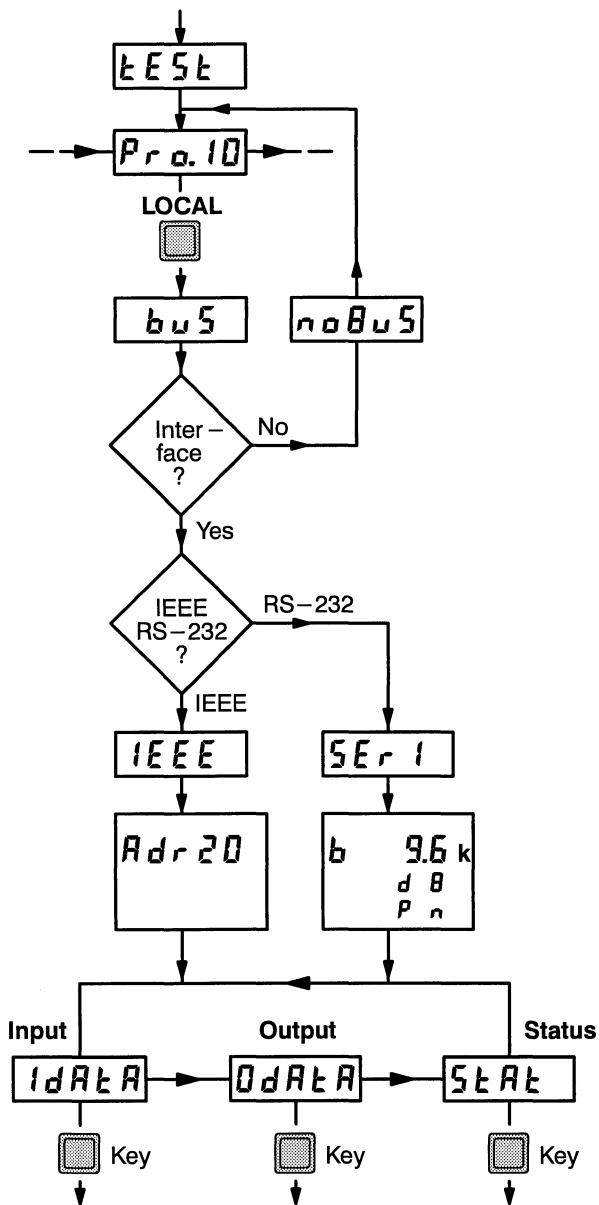

INPUT TEST

When the instrument received data via interface the display shows **dAtA**. The first eight figures of the string can be displayed individually in hexadecimal form by pressing any key (except **LOCAL**). The data input can be repeated as often as desired.

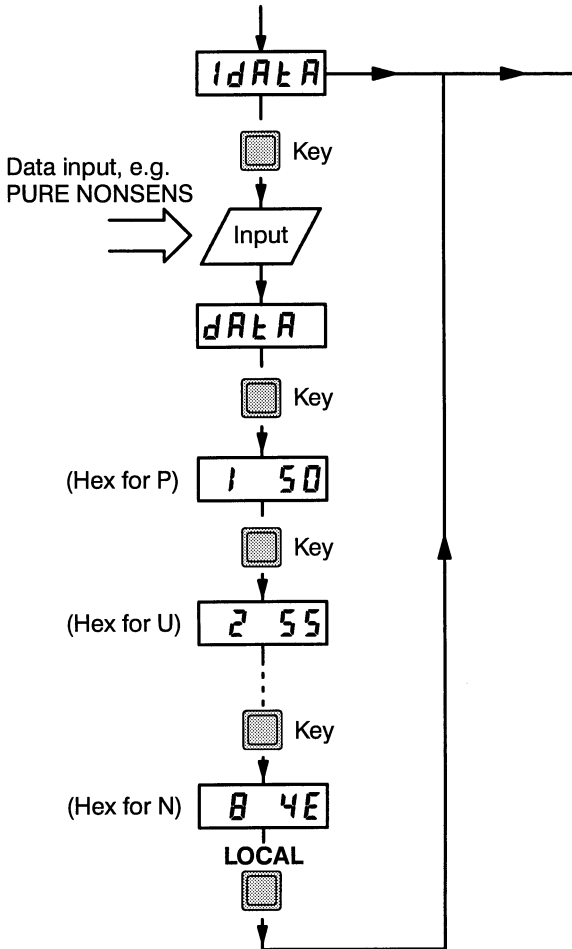

Press the **LOCAL** key to return to the selection between input, output, and status.
Press the key again to return to the menu of the test program.

To leave the test program, turn off the instrument.

OUTPUT TEST

When the output test is selected the display shows **dAtA** and the identification string

'FLUKE, PM6306, 0, Vx.x'

can be read out by a controller. This test can be repeated so often as desired by pressing any key (except **LOCAL**).

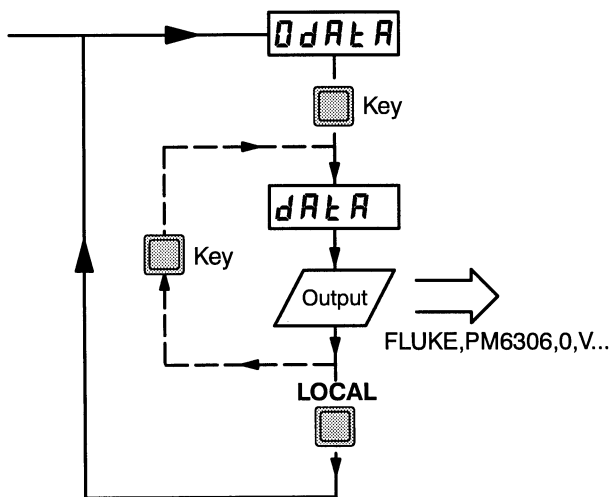

Press the **LOCAL** key to return to the selection between input, output, and status.
Press the key again to return to the menu of the test program.

To leave the test program, turn off the instrument.

DEVICE-STATUS TEST

This test checks the data transfer from the instrument to the Standard Event Status Register and to the Status Byte Register.

Pressing any key (except **LOCAL**) when the display shows **Stat** sets the bits of the Standard Event Status Register (ESR) to 1 or 0. The display shows **Stat 0** or **Stat 1**. If the bits of the Standard Event Status Enable Register (ESE) was set to 1 with the command \star ESE 255 the controller can read out the Status Byte Register with serial poll or with the query \star STB? (IEEE-488) respectively with ESC 7 for the RS-232 Interface. The result is 0 or 32 decimal, see Programmers Manual. The Standard Event Status Register also can be read out by a controller with the query \star ESR?.

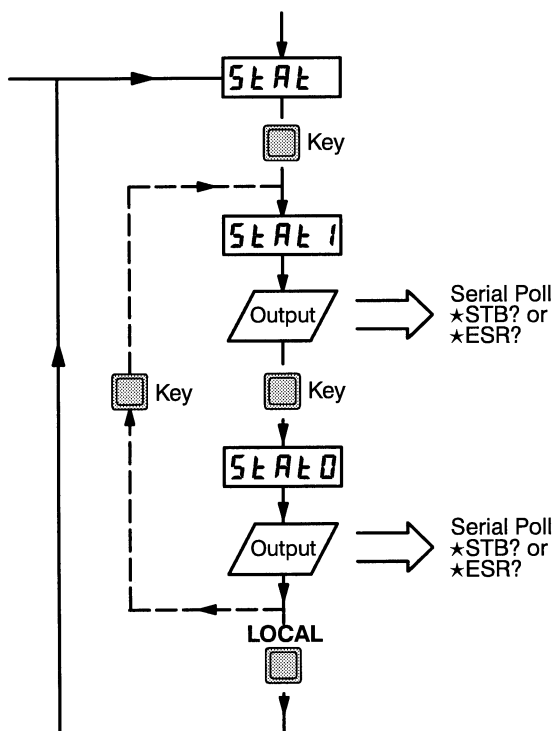

Press the **LOCAL** key to return to the selection between input, output, and status. Press the key again to return to the menu of the test program.

To leave the test program, turn off the instrument.

Program 11 is a part of the Check and Adjustment Procedure described in the Service Manual. It contains seven adjustment steps which can be started by pressing any key. **It should only be performed by qualified Service Technicians.**

Note: **Depending on the setup and the used test fixtures the stored adjustment data could be overwritten by wrong values.** If you have unintended selected *Pro.II*, press the **LOCAL** key to leave the menu of the test program or switch the instrument off.

6C.7 RECALIBRATION

The instrument was calibrated in the factory prior to shipment. The calibrating data are stored in an EEPROM and are taken into account during every measurement.

It is necessary to calibrate again after loss of data (replacing the EEPROM), after changing components during repair which might influence the measuring result, or when the instrument does not meet the Technical Specifications. In normal operation, recalibration once a year is sufficient. For more details about this, see the SERVICE MANUAL.

Chapter **6D**

FIGURES

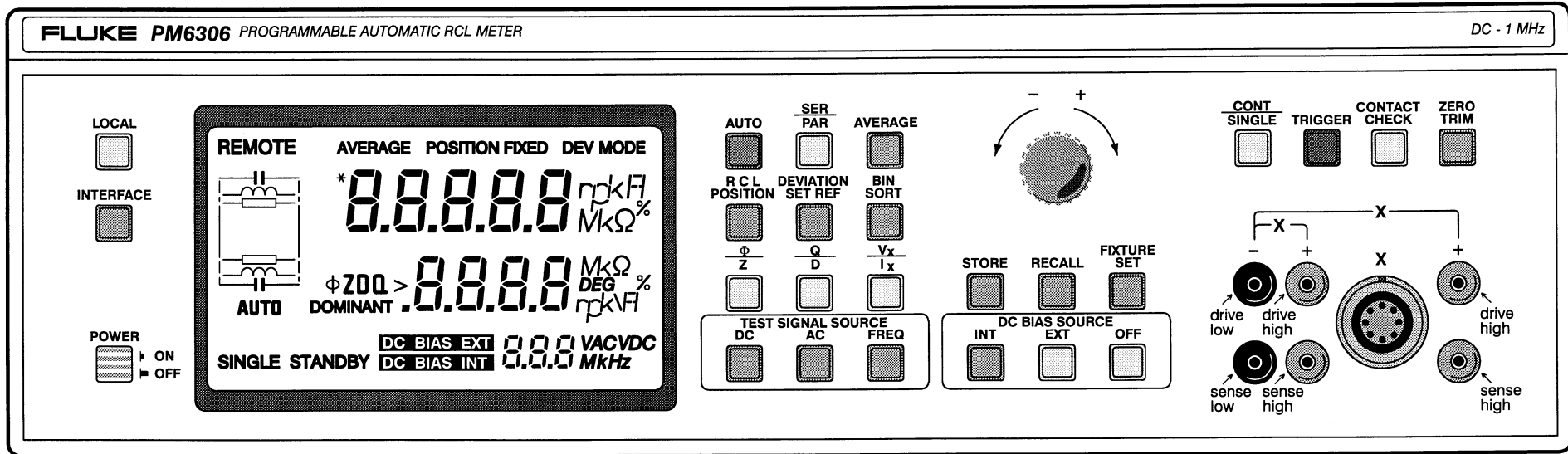

Fig. 1
Front view
Frontansicht
Face avant

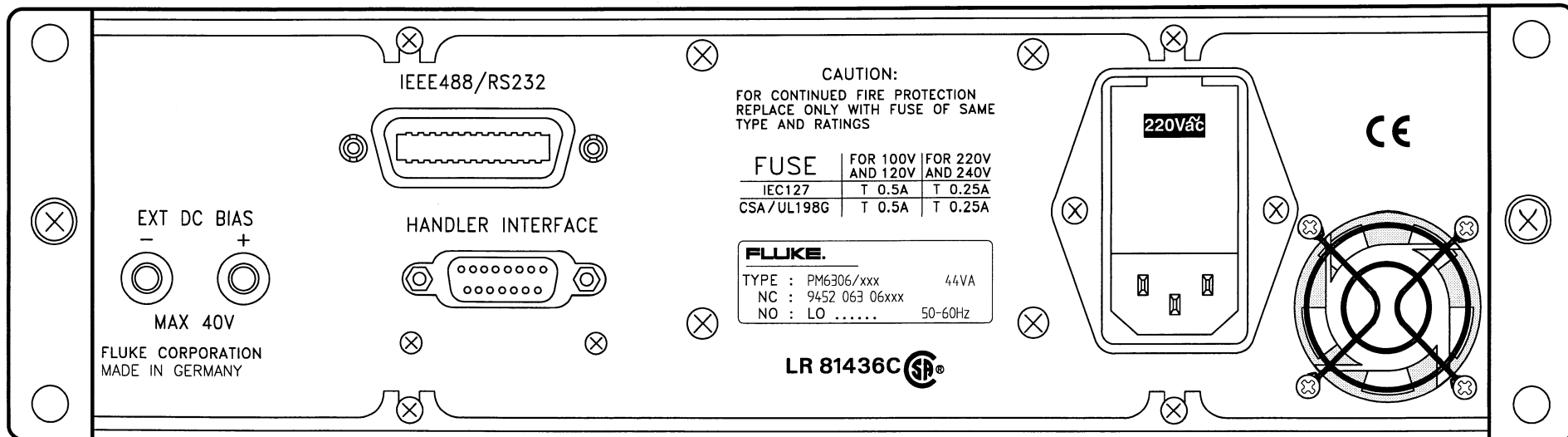

Fig. 2
Rear view
Rückansicht
Face arrière

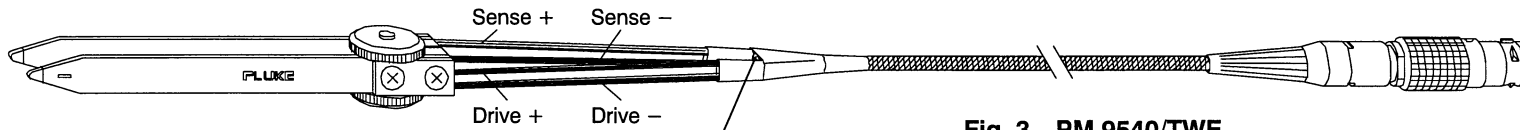

Fig. 3 PM 9540/TWE
SMD Tweezers
SMD Meßpinzette
Pincette SMD

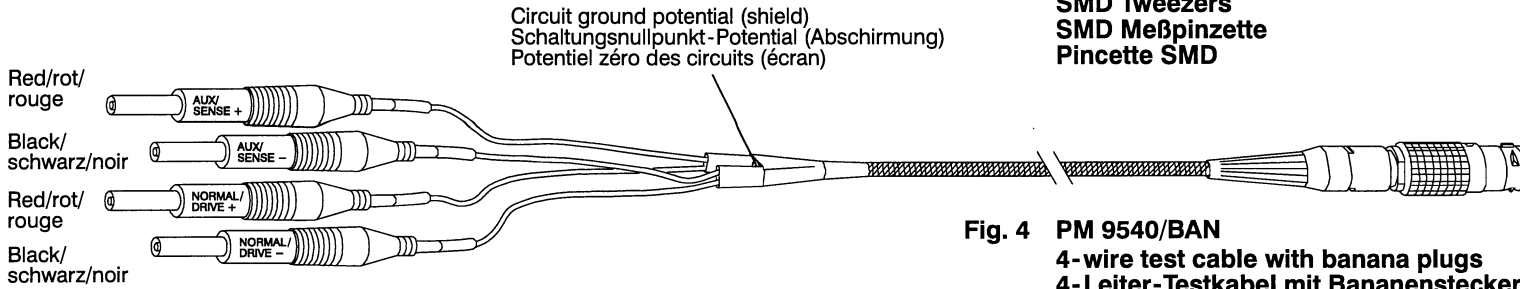

Fig. 4 PM 9540/BAN
4-wire test cable with banana plugs
4-Leiter-Testkabel mit Bananensteckern
Cable de test à 4 conducteurs avec fiches banane

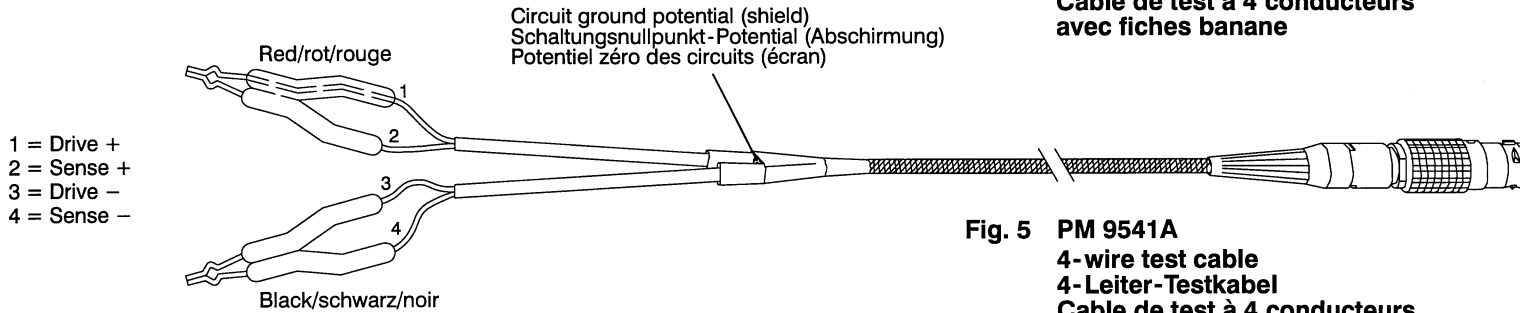
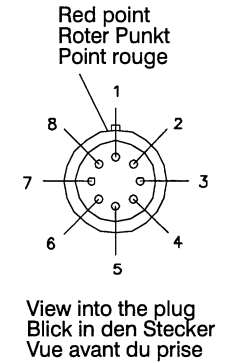

Fig. 5 PM 9541A
4-wire test cable
4-Leiter-Testkabel
Cable de test à 4 conducteurs

- Pin 1 = Shield of sense - / circuit ground
- Pin 2 = Sense -
- Pin 3 = Shield of drive -
- Pin 4 = Drive -
- Pin 5 = Shield of Sense +
- Pin 6 = Sense +
- Pin 7 = Shield of Drive +
- Pin 8 = Drive +

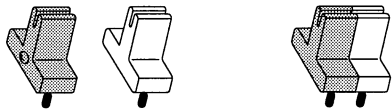

Fig. 6 Single and double test posts
Einzel- und Doppeltestsäulen
Portiques simples et portique double



Fig. 7 PM 9542SMD
SMD Adapter
SMD Adapter
SMD adaptateur

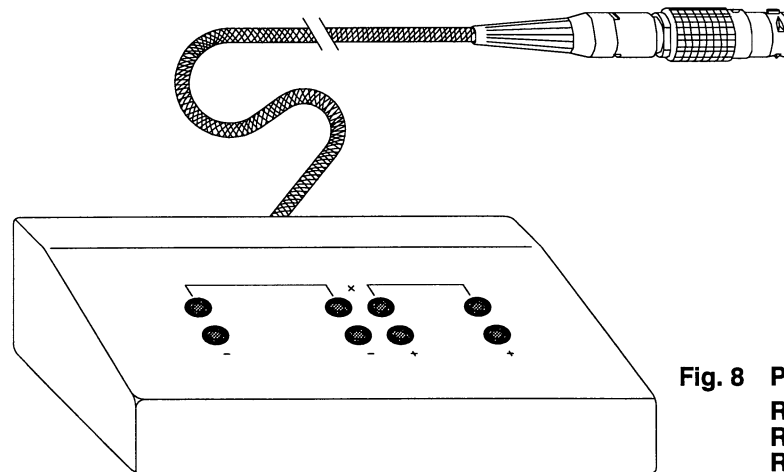

Fig. 8 PM 9542A
RCL Adapter
RCL Adapter
RCL adaptateur

Chapter 7

INSTALLATION AND SAFETY INSTRUCTIONS IN FOREIGN LANGUAGES

INSTRUCCIONES DE INSTALACION Y DE SEGURIDAD (E)

ISTRUZIONI PER LA MESSA IN FUNZIONE E NORME DI SICUREZZA (I)

INSTRUCTIES MET BETREKKING TOT DE INSTALLATIE EN VEILIGHEID (NL)

INSTALLATIONSANVISNINGAR OCH SÄKERHETSFÖRESKRIFTER (S)

7 INSTRUCCIONES DE INSTALACION Y DE SEGURIDAD

7.1 INSTRUCCIONES DE SEGURIDAD

El aparato sale de fábrica, técnicamente, en perfectas condiciones de seguridad (ver 'Appendix', cap. 6A). Para que se conserven estas condiciones, y para evitar riesgos en el uso, hay que seguir cuidadosamente las indicaciones siguientes.

7.1.1 Reparación y mantenimiento

Defectos y esfuerzos extraordinarios:

Si se piensa que el aparato ya no puede funcionar sin riesgo, hay que apagarlo y asegurarse de que no se ponga en funcionamiento inadvertidamente. Este es el caso:

- cuando el aparato presenta daños visibles,
- cuando el aparato ya no funciona,
- luego de haber sido sometido a esfuerzos excesivos de cualquier tipo (p.e. en el almacenaje o el transporte) que sobrepasan los límites permitidos.

Abrir el aparato:

Al abrir algunas tapas o al desmontar piezas con herramientas pueden quedar al descubierto partes bajo tensión eléctrica. También puede haber tensión en los puntos de conexión. Antes de abrir el aparato hay que desconectarlo de todas las fuentes de alimentación.

Si es inevitable realizar un **calibrado, mantenimiento o reparación con el aparato abierto** que se encuentra bajo tensión, sólo debe hacerlo un técnico cualificado que conozca los riesgos que existen. Los condensadores del aparato pueden seguir estando cargados aún cuando esté haya sido desconectado de todas las fuentes de alimentación.

7.1.2 Puesta a tierra

Antes de hacer alguna conexión hay que conectar el aparato a un contactor de protección mediante el cable de alimentación de tres conductores.

El enchufe de la red debe ser insertado sólo en tomacorrientes con contacto de seguridad de tierra.

No se deben anular estas medidas de seguridad, p.e. usando un cable de extensión sin contactor de protección.

La puesta protectora a tierra a través de los contactos de medición en la placa frontal, a través de los 4 contactos de la toma a la cual se aplica el potencial de tierra del circuito o a través del contacto exterior de la toma o de la clavija es inadmisibles.

ADVERTENCIA: Toda interrupción del contactor de protección dentro o fuera del aparato, o la separación de la conexión de la puesta protectora a tierra es peligrosa.
Se prohíbe hacer la interrupción expresamente.

7.1.3 Contactos y conexiones

El potencial de tierra del circuito se aplica a 4 de los 8 contactos de la toma, estando éste conectado en paralelo a la carcasa del aparato por medio de condensadores y resistencia; el contacto exterior de la toma está unido a la carcasa del aparato. De esta forma se evitan zumbidos y se obtiene una clara puesta a tierra de HF.

Si al efectuar una medición se observa que el potencial de tierra del circuito eléctrico difiere del potencial de tierra de protección, se ha de tener en cuenta que los 4 contactos de la toma no deban estar conectados a tensiones que sean peligrosas al menor contacto.

7.1.4 Ajuste de la tensión de la red y fusibles

Antes de enchufar el aparato a la red hay que verificar si éste está ajustado a la tensión de la red local.

ADVERTENCIA: Si hay que adaptar el enchufe de la red a las circunstancias del lugar, este trabajo debe realizarlo sólo un técnico cualificado.

Al salir de fábrica el aparato está ajustado a una de las tensiones de red siguientes:

Tipo de aparato	Nro. de código	Tensión de red	Cable suministrado
PM6306	9452 063 06xx1	220 V	Europa
PM6306	9452 063 06xx3	120 V	Norteamérica
PM6306	9452 063 06xx4	240 V	Inglaterra (U.K.)
PM6306	9452 063 06xx5	220 V	Suiza
PM6306	9452 063 06xx8	240 V	Australia

En la parte trasera del aparato se indica la tensión de red ajustada y el valor del fusible correspondiente.

Hay que tener en cuenta de emplear solamente fusibles con la tensión nominal indicada y del tipo especificado para recambio. Se prohíbe el empleo de fusibles reparados o cortocircuitar el porta-fusibles. El cambio del fusible sólo deberá realizarlo un técnico cualificado, que conozca los riesgos que existen.

ADVERTENCIA: Cuando se cambia un fusible y cuando se ajusta el aparato a otra tensión, éste debe ser desconectado de todas las fuentes de alimentación.

El aparato se puede ajustar a las tensiones de red siguientes: 100 V, 120 V, 220 V y 240 V en corriente alterna. Se puede hacer la regulación de estas tensiones nominales con el selector de tensión (combinado con el enchufe en la pared trasera del aparato).

El fusible se encuentra en un soporte en el mismo sitio. Para ajustar la tensión de la red o para sustituir el fusible hay que desconectar el aparato de la red y abrir con un destornillador la tapa (ver dibujo).

La tensión adecuada se elige girando el selector de tensión. Si hace falta, se debe montar el fusible correspondiente en lugar del que está instalado en el soporte del fusible – T250mA o T500mA (IEC127 o CSA/UL198G).

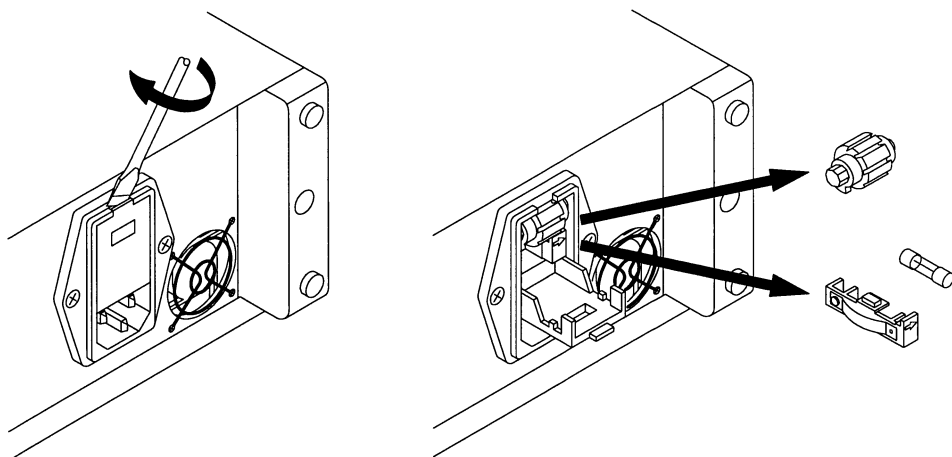

7.2 POSICION DE FUNCIONAMIENTO DEL APARATO

El aparato puede funcionar en las posiciones indicadas en el capítulo 6A. Si la horquilla de soporte está cerrada, el aparato puede utilizarse en posición inclinada. Los datos técnicos del capítulo 6A se refieren a las posiciones indicadas. Se ha de tener cuidado de no cubrir las aberturas de ventilación del aparato. El aparato no se debe colocar nunca sobre una superficie que produzca o irradie calor ni exponerlo a los rayos directos del sol.

7.3 SUPRESION DE INTERFERENCIAS

En el aparato se han suprimido cuidadosamente todas las interferencias, habiéndose sometido éste también a prueba. Al conectarlo a unidades básicas o a otras unidades periféricas cuyas interferencias no se han suprimido correctamente, pueden generarse interferencias que en algunos casos exigirán medidas adicionales para suprimirlas.

7 ISTRUZIONI PER LA MESSA IN FUNZIONE E NORME DI SICUREZZA

7.1 NORME DI SICUREZZA

L'apparecchio viene fornito dalla fabbrica perfettamente sicuro e funzionante dal punto di vista tecnico (vedi 'Appendix', Cap. 6A). Per preservarlo in condizioni ottimali e garantirne un corretto funzionamento, attenersi scrupolosamente alle seguenti istruzioni.

7.1.1 Riparazione e manutenzione

Funzionamento anomalo e sollecitazioni eccessive:

Qualora il funzionamento non risultasse regolare, spegnere subito l'apparecchio e prevenirne ogni accensione accidentale.

Le precauzioni di cui sopra vanno adottate nei seguenti casi:

- se l'apparecchio mostra dei danni visibili,
- se l'apparecchio non funziona più,
- se l'apparecchio è stato sottoposto a sollecitazioni (ad esempio durante il magazzinaggio, il trasporto, ecc.) oltre i limiti di tolleranza ammessi.

Apertura dell'apparecchio:

Se i coperchi o alcune parti dell'apparecchio vengono rimossi con appositi attrezzi, può darsi che risultino esposti dei componenti sotto tensione. Anche i punti di connessione possono essere sotto tensione. Prima di aprire l'apparecchio occorre quindi disinnestarlo dalle relative prese di corrente.

Se fosse necessario eseguire interventi di **calibrazione, manutenzione o riparazione con l'apparecchio aperto** e sotto tensione, rivolgersi a personale specializzato che conosca bene i probabili rischi nelle procedure da adottare. Potrebbe darsi che i condensatori dentro all'apparecchio siano ancora carichi anche se l'apparecchio è stato disinnestato dalle relative prese di corrente.

7.1.2 Messa a terra

Prima di eseguire un qualsiasi collegamento, mediante il cavo di alimentazione tripolare l'apparecchio deve essere allacciato ad un conduttore di protezione.

La spina del cavo di alimentazione deve essere inserita soltanto in una presa munita di contatto di messa a terra.

Questa norma resta comunque valida, anche se si utilizza un cavo di prolunga senza conduttore di protezione.

I contatti di misura sulla piastra anteriore o i quattro contatti della presa su cui viene applicato il potenziale di terra del circuito di alimentazione, o il contatto esterno della presa/spina, o le prese alla piastra posteriore non devono essere utilizzati per collegare un conduttore di terra protettivo.

ATTENZIONE: E' estremamente pericoloso interrompere il conduttore di protezione interno o esterno all'apparecchio o i contatti di messa a terra. Evitare quindi di farlo intenzionalmente.

7.1.3 Contatti e collegamenti

Il potenziale di terra del circuito di alimentazione viene applicato a quattro degli otto contatti della presa e condotto alla carcassa dell'apparecchio tramite condensatori e una resistenza collegati in parallelo; il contatto esterno della presa viene collegato alla carcassa dell'apparecchio. In tal modo, viene realizzato un collegamento di messa a terra RF univoco esente da interferenze.

Se il potenziale di terra del circuito all'interno di una determinata configurazione fosse differenziato dal potenziale di messa a terra di protezione, occorre accertarsi che i quattro contatti della presa non siano sotto tensione.

7.1.4 Predisposizione della tensione di alimentazione e fusibili

Prima di collegare la spina di alimentazione alla presa, controllare che l'apparecchio sia predisposto per la tensione di rete locale.

ATTENZIONE: L'eventuale adattamento della spina di alimentazione alle condizioni locali va effettuata esclusivamente da personale specializzato.

L'apparecchio fornito dalla fabbrica è predisposto per uno dei seguenti valori di tensione di rete:

Tipo de apparecchio	No di codice	Tensione	Cavo di alimentazione fornito in dotazione
PM6306	9452 063 06xx1	220 V	Europa
PM6306	9452 063 06xx3	120 V	Nord Amerika
PM6306	9452 063 06xx4	240 V	Inghilterra (U.K.)
PM6306	9452 063 06xx5	220 V	Svizzera
PM6306	9452 063 06xx8	240 V	Australia

Il valore della tensione di rete predisposto e la portata del fusibile sono indicati sul retro dell'apparecchio.

Si un fusibile deve essere sostituito, fare attenzione a utilizzarne uno caratterizzato dalla portata nominale prescritta e di tipo idoneo. Non è consentito utilizzare fusibili riparati e/o cortocircuitare il porta-fusibile. Il fusibile può essere sostituito solo da personale specializzato che conosca bene i potenziali rischi esistenti negli interventi di questo tipo.

ATTENZIONE: Per sostituire un fusibile o predisporre un diverso valore della tensione di alimentazione occorre disinserire l'apparecchio dalle relative presa di corrente.

L'apparecchio può essere predisposto per i seguenti valori della tensione di alimentazione: 100 V, 120 V, 220 V e 240 Vca. Questi valori nominali di tensione possono essere predisposti con il selettore della tensione (in corrispondenza della presa di alimentazione sul retro dell'apparecchio).

Il fusibile è collocato in un supporto nello stesso posto. Per impostare il valore della tensione di rete o per sostituire il fusibile, occorre disinnestare il cavo di alimentazione e aprire con un cacciavite l'aletta di chiusura (vedere il disegno).

Selezionare il valore di tensione richiesto girando la rotella di regolazione. Se necessario, sostituire il vecchio fusibile con uno nuovo – T250mA oppure T500mA (IEC127 oppure CSA/UL198G).

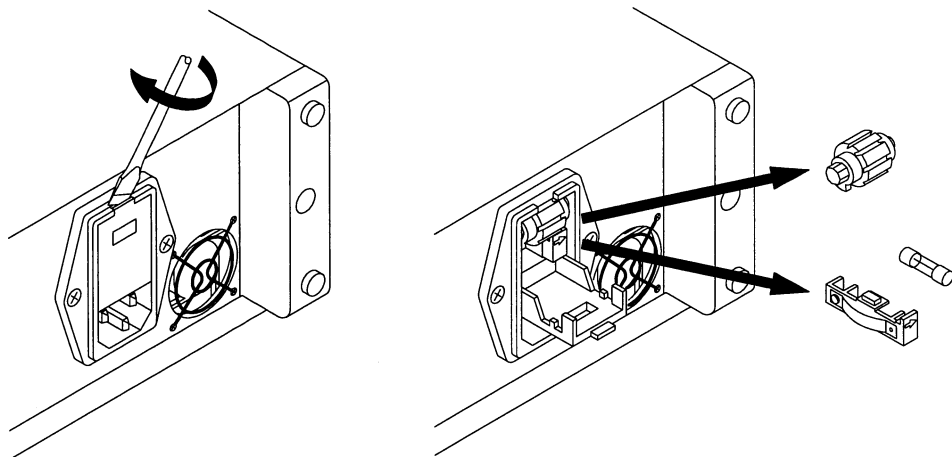

7.2 POSIZIONE DI FUNZIONAMENTO DELL'APPARECCHIO

L'apparecchio può essere installato nelle posizioni indicate nel Capitolo 6A. Abbassando la squadretta di supporto, l'apparecchio può essere usato in posizione inclinata. I dati tecnici riportati nel Capitolo 6A valgono per le posizioni indicate. Attenzione che le aperture di ventilazione dell'apparecchio non vengano coperte. L'apparecchio non deve essere mai collocato su una superficie surriscaldabile o che produca irradiazioni, né essere esposto ai raggi diretti del sole.

7.3 INTERFERENZE

L'apparecchio è stato realizzato per garantire un funzionamento esente da interferenze. Se viene utilizzato congiuntamente a unità base e a unità periferiche non dotate delle stesse protezioni, ne possono derivare interferenze che richiederanno ulteriori interventi.

7 INSTRUCTIES MET BETREKKING TOT DE INSTALLATIE EN VEILIGHEID

7.1 VEILIGHEIDSINSTRUCTIES

Het apparaat heeft de fabriek in een onberispelijke veiligheidstechnische toestand verlaten (zie 'Appendix', hoofdstuk 6A). Voor het behoud van deze toestand en het risicoloze gebruik dienen de onderstaande instructies nauwkeurig te worden opgevolgd.

7.1.1 Reparatie en onderhoud

Storingen en uitzonderlijke omstandigheden

Wanneer verondersteld moet worden dat een risicoloos gebruik niet meer mogelijk is, dient het apparaat buiten gebruik gesteld en tegen een ongewenst gebruik beveiligd te worden. Deze situatie doet zich voor

- wanneer het apparaat zichtbare beschadigingen vertoont,
- wanneer het apparaat niet meer functioneert,
- na blootstelling aan excessieve omstandigheden van welke aard dan ook (bij voorbeeld bij opslag, transport) die de toelaatbare grenzen overschrijden.

Openen van het apparaat

Bij het openen van afdekkingen of bij het met behulp van gereedschap verwijderen van onderdelen, kan het risico van contact met spanningvoerende delen ontstaan. Ook kan er spanning op aansluitpunten aanwezig zijn. Het apparaat mag pas geopend worden nadat het van alle spanningsbronnen losgenomen is.

Wanneer **ijk-, onderhouds- of herstelwerkzaamheden aan een open en onder spanning staand apparaat** onvermijdelijk zijn, mogen deze slechts worden uitgevoerd door een vakman die weet met welke gevaren dit gepaard gaat. In het apparaat aanwezige condensators kunnen nog geladen zijn, ook wanneer het apparaat van alle spanningsbronnen is losgenomen.

7.1.2 Aarding

Alvorens men een verbinding tot stand brengt, dient men het apparaat met behulp van een drieadrige kabel met een veiligheidsaarddraad te verbinden.

De netstekker mag slechts op een stopcontact met randaarde worden aangesloten.

Deze veiligheidsmaatregel mag niet onwerkzaam gemaakt worden, bij voorbeeld door het gebruik van een verlengsnoer dat niet van een veiligheidsaarddraad voorzien is.

Een beschermde aarde aansluiting via de meetansluitingen aan de voorkant, over de 4 stekker contacten welke op schakelnulpunt-potentiaal liggen, via het externe contact van de stekker (stekkerhuis) of van de stekker, of via de stekkers aan de achterkant is niet toegestaan.

WAARSCHUWING: Elke onderbreking van de beschermende aardleiding, hetzij binnen of buiten het apparaat, of de scheiding ten opzichte van de aardleiding zijn gevaarlijk. Een opzettelijke onderbreking is verboden.

7.1.3 Aansluitingen en verbindingen

Het aardpotentiaal van de stroomkringen wordt aan 4 van de 8 contacten van de stekker verbonden, en is met het huis verbonden via parallel aangesloten condensators en weerstand; het externe contact van de stekker (stekkerhuis) is met de behuizing verbonden.

Op deze manier wordt een duidelijke bromvrije HF-aarding tot stand gebracht.

Wanneer in een meetopstelling het schakelnulpunt-potentiaal van een stroomkring afwijkt van het beschermde aardpotentiaal, dan dient men er op bedacht te zijn, dat de 4 contacten van de stekker geen gevaarlijke spanningen mogen voeren!

7.1.4 Netspanningsinstelling en zekeringen

Alvorens men de netstekker op het lichtnet aansluit, dient men zich ervan te vergewissen dat het apparaat op de plaatselijke netspanning is afgesteld.

WAARSCHUWING: Wanneer de netstekker aan de plaatselijke situatie moet worden aangepast, mag deze aanpassing slechts door een vakman worden uitgevoerd.

Bij het verlaten van de fabriek is het apparaat op een van de volgende netspanningen afgesteld:

Type apparaat	Codenummer	Netspanning	Meegedeleverde netkabel
PM6306	9452 063 06xx1	220 V	Europa
PM6306	9452 063 06xx3	120 V	Noord-Amerika
PM6306	9452 063 06xx4	240 V	Engeland (U.K.)
PM6306	9452 063 06xx5	220 V	Zwitserland
PM6306	9452 063 06xx8	240 V	Australië

Op de achterwand van het apparaat zijn de netspanning waarop het apparaat is afgesteld en de hierbij behorende zekering vermeld.

Men dient erop te letten dat men bij het vervangen van een zekering slechts een exemplaar met de gespecificeerde nominale stroomsterkte en van het gespecificeerde type mag gebruiken. Het gebruik van gerepareerde zekeringen en/of het kortsluiten van de zekeringhouder zijn verboden. De zekering mag slechts vervangen worden door een vakman die weet met welke gevaren dit gepaard gaat.

WAARSCHUWING: Bij het vervangen van een zekering en bij het instellen op een andere netspanning moet het apparaat van alle spanningsbronnen worden losgenomen.

Het apparaat kan op de volgende netspanningen worden ingesteld: 100 volt, 120 volt, 220 volt en 240 volt wisselspanning. Deze nominale spanningen kunnen met de spanningskiezer (die gecombineerd is met de netaansluitbus op de achterwand) worden ingesteld.

De zekering bevindt zich in een houder op dezelfde plaats. Voor het instellen van de netspanning of het vervangen van een zekering moet de voedingskabel losgenomen worden en het afdekplaatje met een schroevendraaier worden verwijderd. (zie tekening).

Men kiest de juiste spanning door het verdraaien van het instelwiel. Indien nodig moet de bijbehorende zekering in plaats van de reeds aanwezige zekering worden aangebracht – T250mA of T500mA (IEC127 of CSA/UL198G).

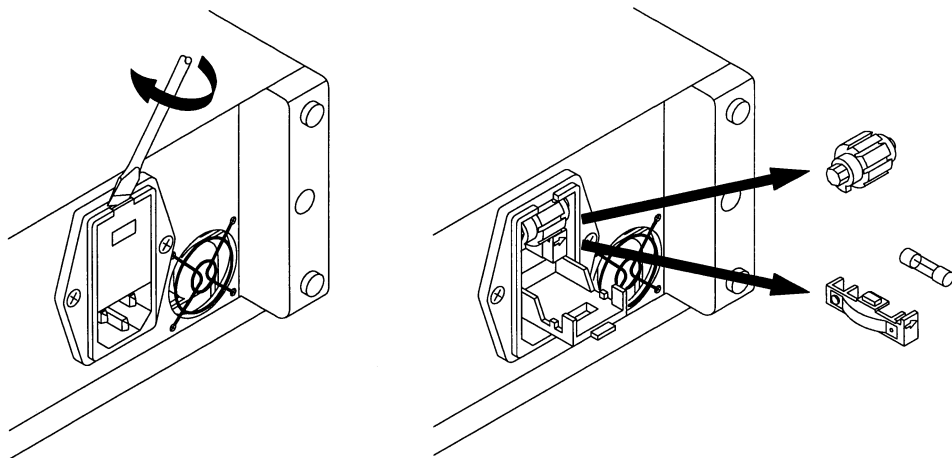

7.2 GEBRUIKSPOSITIE VAN HET APPARAAT

Het apparaat mag in de in hoofdstuk 6A beschreven posities gebruikt worden. Wanneer de stelvoet naar beneden geklapt is, kan het apparaat in een schuingeplaatste positie gebruikt worden. De technische specificatie in hoofdstuk 6A is van toepassing op de gespecificeerde gebruiksposities. Het erop dat de ventilatieopeningen van het apparaat niet afgedekt worden. Het apparaat nooit installeren op een oppervlak dat warmte genereert of uitstraalt, en het evenmin aan rechtstreekse zonnestraling blootstellen.

7.3 RADIO-ONTSTORING

Wat radio-ontstoring betreft is het apparaat zorgvuldig ontstoord en gecontroleerd. Bij het schakelen in combinatie met basisunits die niet correct onstoord zijn en met andere perifere apparatuur, kan radiostoring optreden. In de desbetreffende gevallen maakt dit aanvullende maatregelen op radio-ontstoringsgebied noodzakelijk.

7 INSTALLATIONSANVISNINGAR OCH SÄKERHETSFÖRESKRIFTER

7.1 SÄKERHETSFÖRESKRIFTER

Detta instrument uppfyllde gällande säkerhetsföreskrifter (se 'Appendix', kapitel 6A) när det lämnade fabriken. Följ nedanstående säkerhetsföreskrifter så förblir instrumentet säkert under normal drift.

7.1.1 Reparation och underhåll

Är instrumentet är trasigt eller har utsatts för onormal förhållanden?

Om du misstänker att det inte går att använda instrumentet på ett säkert sätt, sluta använda det och förhindra även andra att använda det.

Detta skall göras då:

- det finns synliga skador på instrumentet
- instrumentet inte längre fungerar
- när instrumentet utsatts för förhållanden som går utanför specifikationen, till exempel. vid lagring eller transport.

Öppning av instrumentet

Om du tar av kåpan på instrumentet eller tar bort delar som måste demonteras med verktyg, så blir spänningsförändringar direkt åtkomliga. Drag alltid ur nätsladden och koppla bort alla andra spänningskällor innan du öppnar instrumentet.

När det är nödvändigt att **kalibrera, underhålla eller reparera ett instrument** med spänningen inkopplad, måste detta göras av behörig personal som känner till riskerna med arbetet. Kom ihåg att även om du kopplat ifrån alla spänningskällor så kan kondensatorer i instrumentet behålla sin laddning i några sekunder.

7.1.2 Skyddsjordning

Innan du ansluter några andra kablar till instrumentet, jorda det genom att ansluta den trepoliga nätkabeln till en jordad nätkontakt. Instrumentet får aldrig anslutas till en ojordad kontakt! Bryt inte heller jordningen genom att använda ojordade skarvsladdar. Skyddsjorden får endast anslutas via nätkabeln som är ansluten till nätbrunnens jordstift.

WARNING: Om du bryter skyddsjorden i eller utanför instrumentet blir det farligt att använda. Att avsiktligt bryta skyddsjorden är absolut förbjudet.

7.1.3 Anslutningar

Signaljorden är ansluten till fyra stift i den åttapoliga kontakten. Dessa stift är anslutna till kåpan via parallellkopplade kondensatorer och motstånd. Kontaktdonets ytterhölje är direktanslutet till kåpan. På detta sätt undviks brum och instrumentet får god RF-jordning.

Om mätobjektets signaljord inte är på samma potential som skyddsjorden, måste du se till att det inte finns någon spänning mellan de fyra signaljordsstiften och skyddsjorden, till exempel genom att använda skyddstransformator.

7.1.4 Nätspänningsomkoppling och säkringar

Innan du ansluter nätsladden till vägguttaget måste du kontrollera att instrumentet är inställt för rätt nätspänning.

WARNING: Om kontakt på nätsladden måste bytas, överlåt detta till behörig elektriker.

När instrumentet lämnar fabriken är spänningsomkopplaren inställd enligt följande:

Typ-nummer	Beställnings-nummer	Nät-spänning	Medlevererad nätkabel
PM6306	9452 063 06xx1	220 V	Europeisk
PM6306	9452 063 06xx3	120 V	Nordamerikansk
PM6306	9452 063 06xx4	240 V	Brittisk (U.K.)
PM6306	9452 063 06xx5	220 V	Schweizisk
PM6306	9452 063 06xx8	240 V	Australiensisk

Du kan se inställd nätspänning och säkringsvärde på bakpanelen.

Om säkringen måste bytas, använd endast säkringar av specificerad typ och med rätt strömstyrka. Det är absolut förbjudet att reparera säkringen eller att kortsluta säkringshållaren. Säkringsbyte får endast utföras av kvalificerad personal som är medveten om riskerna.

WARNING: Koppla alltid ur nätsladden och alla andra spänningskällor innan du ändrar nätspänningsomkopplaren eller byter säkring.

Instrumentet kan ställas in för 100 V, 120 V, 220 V och 240 V växelström. Både spänningsomkopplaren och säkringshållaren sitter i nätbrunnen på bakpanelen.

Om du skall ändra spänningsområde eller byta säkring, så drar du ur nätkabeln ur nätbrunnen och öppnar sedan skyddslocket med en skruvmejsel (se bild).

Välj rätt nätspänning genom att ta ut rullen, vända den så att den spänning du vill ha visas utåt och sedan sätta in den igen. Du kan vara tvungen att byta säkring vid val av ny spänning. Drag ut säkringshållaren och byt till rekommenderad säkring – T250mA trög för 220 V och 240 V områdena eller T500mA trög för 100 V och 120 V områdena (IEC127 och CSA/UL198G).

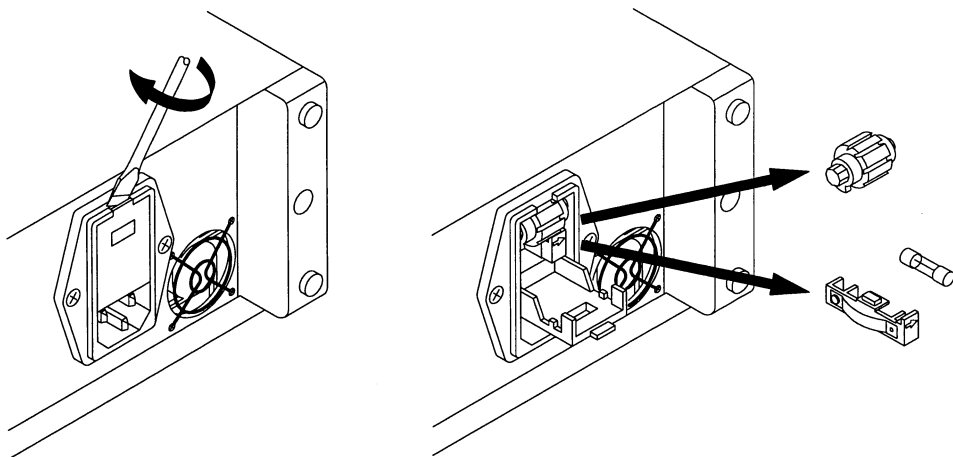

7.2 DRIFTSLÄGE

I kapitel 6A kan du se vilka lägen instrumentet får användas i. Instrumentet kan vinklas upp till en bekväm betraktningvinkel genom att handtaget fälls ned. Specifikationspunkterna i kapitel 6A garanteras i alla godkända driftslägen. Se till att ventilations hållen inte är blockerade. Ställ aldrig instrumentet på en yta som avger värme, inte heller i direkt solljus.

7.3 RADIOAVSTÖRNING

Radiostörningar som genereras av instrumentet är noggrant dämpade och avstörningen är noggrant kontrollerad. Om instrumentet kopplas samman med dåligt avstörda basenheter eller andra enheter, kan det genereras radiostörningar som behöver yttre avstörning.

Chapter 8

INDEX

8 INDEX

A

AC voltage	4-10, 6A-3
Accessories	3-16, 6A-20, 6A-23
Accuracy	4-32, 6A-11
Asterisk (in the display)	4-38
Automatic measurements	4-23
Automatic Zero Trim	3-4, 4-15

B

Banana plugs	3-14, 3-21
Bias voltage	4-10, 6A-4

C

Cables	6A-17, 6A-23
Calculation of measurement results	4-3
Calibration	6A-16
Capacitors	4-12
Coil (iron core)	4-14
Component connection	3-16, 6A-9
Components (to be measured)	4-10
Connectors	3-14
Contact check	4-22
Contact resistance	4-16, 4-22

D

DC bias voltage	4-10, 6A-4
DC resistance	4-12
DC voltage	4-10, 6A-4
Display	3-12
Dissipation factor	4-24, 4-26
Dominant parameter	4-24

E

Electrolytic capacitors	4–10, 4–12
EMC requirements	6A–1, 6A–19
Equivalent circuit symbol	3–12, 5–3
Equivalent series resistance	4–12
Error messages	4–38
External DC bias voltage	4–10, 6A–4
External voltage	6A–9

F

Fail (in the display)	4–39
Faults	4–38
Foil capacitor	4–12
Four wire measurements	3–16
Frequency	4–10, 6A–3
Fuses	1–4

H

Handler interface	4–26, 6A–21
-------------------------	-------------

I

IEEE–488 interface	6A–20
Impedance	4–25
Impedance (open-circuit)	4–18
Impedance (short-circuit)	4–18
Inductance of windings	4–11
Inductances	4–14
Input (via keyboard)	3–7, 5–1
Input (via remote control)	see Programmers Manual
Insulation resistance	4–13
Interface	6A–20
Internal DC bias voltage	4–10, 6A–4

K

Kelvin clips	3-17
Keyboard	3-7

L

Line voltage	1-3
--------------------	-----

M

Mains voltage	1-3
Maintenance	1-1, 6B-1
Manual measurement	4-24
Measurement conditions	4-11
Measurement setups	3-16
Measurements	3-16, 4-10
Measurements (automatic)	4-23
Measurements (manual)	4-25
Measurements (of components)	4-10
Measuring accuracy	4-32, 6A-11
Measuring ranges	4-38, 6A-10

O

Open-circuit trim	4-20
Options	6A-20
Out of range messages	4-38
Over (in the display)	4-39

P

Parallel capacitance (resistor)	4–11
Parallel parameter	4–24, 4–25
Parameter (of a CUT)	4–10
Phase angle	4–25
Power cable	1–3
Power input module	1–4
Power Supply	6A–16
Principle of measurement	4–1

Q

Quality factor	4–24, 4–26
----------------------	------------

R

Range (test signal)	6A–3, 6A–4
RCL Adapter	3–17
Recalibration	6A–16
Recall (of instrument settings)	4–40
Reference voltage	6A–17
Resistance of windings	4–14
Resistors	4–11
Resolution (test signal)	6A–3, 6A–4
RS-232 interface	6A–20

S

Safety	1–1, 6A–19
Secondary parameter	4–24
Self-resonant frequency	4–13, 4–14
Self-tets	3–2
Series parameter	4–24, 4–25
Service	1–1, 6B–1
Setups	3–16, 4–10

S continuation

Short-circuit trim	4-19
Shunt capacitance (resistor)	4-11
SMD Adapter	3-19
SMD Tweezers	3-20
Store (of instrument settings)	4-40

T

Temperature	6A-17
Test cables	3-17, 6A-23
Test posts	3-2, 3-16, 6A-23
Test signal	4-10, 6A-3
Test signal frequency	4-10, 6A-3
Test signal voltage	4-10, 6A-3
Testprogram	6C-1
Timing	6A-22, 6A-8
Tolerances	6A-13
Trim procedure	3-4, 4-15
Two-wire measurements	3-22

U

Update (display)	6A-8
------------------------	------

V

Voltage	4-10, 6A-4
Voltage (mains) setting	1-3, 1-4
Voltage selector	1-4

Z

Zero Trim	3-4, 4-15
-----------------	-----------

LIMITED WARRANTY & LIMITATION OF LIABILITY

DECLARATION OF CONFORMITY

SERVICE CENTRES

LIMITED WARRANTY & LIMITATION OF LIABILITY

Each Fluke product is warranted to be free from defects in material and workmanship under normal use and service. The warranty period is one year and begins on the date of shipment. Parts, product repairs and services are warranted for 90 days. This warranty extends only to the original buyer or end-user customer of a Fluke authorized reseller, and does not apply to fuses, disposable batteries or to any product which, in Fluke's opinion, has been misused, altered, neglected or damaged by accident or abnormal conditions of operation or handling. Fluke warrants that software will operate substantially in accordance with its functional specifications for 90 days and that it has been properly recorded on non-defective media. Fluke does not warrant that software will be error free or operate without interruption.

Fluke authorized resellers shall extend this warranty on new and unused products to end-user customers only but have no authority to extend a greater or different warranty on behalf of Fluke. Warranty support is available if product is purchased through a Fluke authorized sales outlet or Buyer has paid the applicable international price. Fluke reserves the right to invoice Buyer for importation costs of repair/replacement parts when product purchased in one country is submitted for repair in another country.

Fluke's warranty obligation is limited, at Fluke's opinion, to refund of the purchase price, free of charge repair, or replacement of a defective product which is returned to an Fluke authorized service center within the warranty period.

To obtain warranty service, contact your nearest Fluke authorized service center or send the product, with a description of the difficulty, postage and insurance prepaid (FOB Destination), to the nearest Fluke authorized service center. Fluke assumes no risk for damage in transit. Following warranty repair, the product will be returned to Buyer, transportation prepaid (FOB Destination). If Fluke determines that the failure was caused by misuse, alteration, accident or abnormal condition of operation or handling, Fluke will provide an estimate of repair costs and obtain authorization before commencing the work. Following repair, the product will be returned to the Buyer transportation prepaid and the Buyer will be billed for the repair and return transportation charges (FOB Shipping Point).

THIS WARRANTY IS BUYER'S SOLE AND EXCLUSIVE REMEDY AND IS IN LIEU OF ALL OTHER WARRANTIES, EXPRESS OR IMPLIED, INCLUDING BUT NOT LIMITED TO ANY IMPLIED WARRANTY OF MERCHANTABILITY OR FITNESS FOR A PARTICULAR PURPOSE. FLUKE SHALL NOT BE LIABLE FOR ANY SPECIAL, INDIRECT, INCIDENTAL OR CONSEQUENTIAL DAMAGES OR LOSSES, INCLUDING LOSS OF DATA, WHETHER ARISING FROM BREACH OF WARRANTY OR BASED ON CONTRACT, TORT, RELIANCE OR ANY OTHER THEORY.

Since some countries or states do not allow limitation of the term of an implied warranty, or exclusion or limitation of incidental or consequential damages, the limitations and exclusions of this warranty may not apply to every buyer. If any provision of this Warranty is held invalid or unenforceable by a court of competent jurisdiction, such holding will not affect the validity or enforceability of any other provision.

product32994rjm

Fluke Corporation
P.O. Box 9090
Everett, WA
98206-9090
USA

or

Fluke Industrial B.V.
P.O. Box 680
7600 AR
Almelo
The Netherlands



DECLARATION OF CONFORMITY
for

FLUKE
Programmable Automatic RCL Meter
PM 6306

Manufacturer
Fluke Industrial B.V.
Lelyweg 1
7602 EA Almelo
The Netherlands

Statement of Conformity

Based on test results using appropriate standards, the product is in conformity with
Electromagnetic Compatibility Directive 89/336/EEC
Low Voltage Directive 73/23/EEC

Sample tests

Standards used:

EN 50081-1 (1992)
Electromagnetic Compatibility Generic Emission Standard:
EN 55011 Group I Class B

EN 50082-1 (1992)
Electromagnetic Compatibility Generic Immunity Standard:
EN 61000-4-2, -3 and -4

EN 61010-1 (1994) CAT II Pollution Degree 2
Safety Requirements for Electrical Equipment for Measurement,
Control, and Laboratory Use.

The tests have been performed in a typical configuration.

This Conformity is indicated by the symbol , i.e. "Conformité européenne".

Argentina

Coasin S.A.
Service Center
Virrey del Pino 4071
1430 Capital Federal
Buenos Aires
Phone: +54-1-552-3485
Fax: +54-1-555-3321

Viditec S.A.

Service Center
Lacarra 234
Buenos Aires CP 1407
Phone: +54-1-636-1200
Fax: +54-1-636-2185

Australia

Philips Scientific & Industrial,
Pty., Ltd. Service Center
34 Waterloo Road
North Ryde, N.S.W. 2113
Phone: +61-2-888-8222
Fax: +61-2-888-0440

Austria

Fluke Vertriebsges GmbH
General Management
Südstrandstraße 7
P.O. Box 10
A 1232 Wien
Phone: +43-1-61410-30
Fax: +43-1-61410-10

Belgium

N.V. Fluke Belgium S.A.
Sales & Service Department
Langeveldpark - Unit 5 & 7
P. Basteleusstraat 2 - 4 - 6
1600 St. Pieters-Leeuw
Phone: +32-2-331-2777
[Ext 218]
Fax: +32-2-331-1489

Bolivia

Coasin Bolivia S.R.L.
Casilla 7295
Calle Ayacucho No. 208
Edificio Flores, 5to. Piso
La Paz
Phone: +591-2-317531
Fax: +591-2-317545

Brazil

Sistest
Av. Ataulfo De Paiva
135 S/ 1117 - Leblon
22.449-900 - Rio De Janeiro
Rj
Phone: +55-21-259-5755
Fax: +55-21-259-5743

Sigtron Instrumentos E.

Servicos Ltda
Rua Alvaro Rodrigues
269 - Brooklin
Sao Paulo
Sp
Phone: +55-11-240-7359
Fax: +55-11-533-3749

*Philips Medical Systems,
Ltda.*

Service Center
Av. Interlagos North
3493 - Campo Grande
04661-200 Sao Paulo S.P.
Phone: +55-11-523-4811
Fax: +55-11-524-4873
(ID2148)

Bulgaria

Ac Sophilco
Customer Support Services
P.O. Box 42
1309 Sofia
Phone: +359-2-200785
Fax: +359-2-220910

C.S.F.R.

ELSO
NA. Berance 2
16200 Praha 6
Phone: +42-2-316-4810
Fax: +42-2-364986

Canada

Fluke Electronics Canada,
Inc.
Service Center
400 Britannia Road East,
Unit #1
Mississauga, Ontario
L4Z 1X9
Phone: +1-905-890-7600
Fax: +1-905-890-6866

Chile

Intronica
Service Center
Instrumentacion Electronica
S.A.C.I
Guardia Vieja 181 Of. 503
Casilla 16500
Santiago 9
Phone: +56-2-232-3888
Fax: +56-2-231-6700

China

Fluke Int'l Corporation
Service Center
Room 2111 Scite Tower
Jianguomenwai Dajie
Beijing 100004, Prc
Phone: +86-10-512-3436
Fax: +86-10-512-3437

Colombia

Sistemas E Instrumentacion,
Ltda. Service Center
Calle 83, No. 37-07
Ap. Aereo 29583
Bogota
Phone: +57-1-256-9023
Fax: +57-1-218-2660

Costa Rica

Electronic Engineering, S.A.
Service Center
Carretera De Circunvalacion
Sabanilla Av. Novena
P.O. Box 4300-1000
San Jose
Phone: +506-*-253-3759
Fax: +506-*-225-1286

Croatia

Kaltim - Zagreb
Fluke Sales & Service
Draga 8
41425 Sveta Jana
Phone: +385-41-837115
Fax: +385-41-837237

Denmark

Fluke Danmark A/S
Customer Support Services
Ejby Industrivej 40
DK 2600 Glostrup
Phone: +45-43-44-1900
Fax: +45-43-43-9192

Ecuador

Proteco Coasin Cia., Ltda.
Service Center
Av. 12 de Octubre 2449 y
Orellana
P.O. Box 17-03-228-A
Quito
Phone: +593-2-230283
Fax: +593-2-561980

Egypt

EEMCO
9 Hassan Mazher St.
P.O. Box 2009
St. Heliopolis 11361
Cairo
Phone: +20-2-4178296
Fax: +20-2-4178296

Finland

Fluke Finland Oy
Customer Support Services
Sinikalliontie 3
P.L. 151
SF 02631 Espoo
Phone: +358-0-61525-620
Fax: +358-0-61525-630

France

Fluke France S.A.
Customer Support Services
37, rue Voltaire
B.P. 112
93700 Drancy
Phone: +33-1-4896-6310
Fax: +33-1-4896-6330

Germany

Fluke Deutschland GmbH
Customer Support Services
Oskar Messter Straße 18
85737 Ismaning
München
Phone: +49-89-99611-260
Fax: +49-89-99611-270

Fluke Deutschland GmbH
Customer Support Services
Meiendorfer Straße 205
P.O. Box 730 370
22145 Hamburg
Phone: +49-40-67960-434
Fax: +49-40-67960-421

Greece

Philips S.A. Hellenique
Fluke Sales & Service
Manager
15, 25th March Street
P.O. Box 3153
177 78 Tavros Athens
Phone: +30-1-4894911
Fax: +30-1-4818594

Hong Kong

Schmidt & Co., Ltd.
Service Center
1st Floor
323 Jaffe Road
Wanchai
Phone: +852-2223-5623
Fax: +852-2834-1848

Hungary

MTA-MMSZ Kft.
Service / General Manager
Etele Ut. 59 - 61
P.O. Box 58
H 1502 Budapest
Phone: +361-186-9589
Fax: +361-161-1021

Iceland

Taeknival Hf
P.O. Box 8294
Skeifunni 17
128 Reykjavik
Phone: +354-1-681665
Fax: +354-1-680664

India

Hinditron Services Pvt., Ltd.
Service Center
204-206 Hemkunt Tower
98 Nehru Place
New Delhi 110 019
Phone: +91-11-641-3675
Fax: +91-11-642-9118

Hinditron Services Pvt., Ltd.
Service Center
Emerald House, 5th Floor
114 Sarojini Devi Road
Secunderabad 500 003
Phone: +91-40-844033
Fax: +91-40-847585

Hinditron Services Pvt., Ltd.

Service Center
Castle House, 5th Floor
5/1 A, Hungerford Street
Calcutta 700 017
Phone: +91-33-247-9094
Fax: +91-33-400-194

Hinditron Services Pvt., Ltd.

Service Center
Hinditron House, 23-B
Mahal Industrial Estate
Mahakali Caves Road,
Andheri East
Bombay 400 093
Phone: +91-22-836-4560
Fax: +91-22-836-4682

Hinditron Services Pvt., Inc.

Service Center
33/44A 8th Main Road
Raj Mahal Vilas Extension
Bangalore 560 080
Phone: +91-80-334-8266
Fax: +91-80-334-5022

Indonesia

P.T. Daeng Brothers
Service Center
Philips House
J/n H.R. Rasuna Said
Kav. 3-4
Jakarta 12950
Phone: +62-21-520-1122
Fax: +62-21-520-5189

Israel

R.D.T Electronics Engineer.
Ltd. Service Center
P.O. Box 58072
Tel Aviv 61580
Phone: +972-3-645-0745
Fax: +972-3-647-8908

Italy

Fluke Italia S.R.L.
Customer Support Services
Viale Delle Industrie, 11
20090 Vimodrone (MI)
Phone: +39-2-268-434-203
Fax: +39-2-250-1645

Japan

Fluke Corporation Japan
Service Center
Sumitomo Higashi Shinbashi
Bldg.
1-1-11 Hamamatsucho
Minato-ku, Tokyo 105
Phone: +81-3-3434-0181
Fax: +81-3-3434-0170

Korea

Il Myoung, Inc.
Service Center
Youngdong P.O. Box 1486
780-46, Yeogsam-Dong
Kangnam-Ku
Seoul
Phone: +82-2-552-8582-4
Fax: +82-2-553-0388

B & P International Co., Ltd.
Service Center
Geopyung Town A-303
203-1 Nonhyun-Dong
Kangnam-ku
Seoul 135-010
Phone: +82-02-546-1457
Fax: +82-2-546-1458

Kuwait

Yusuf A. Alghanim & Sons
W.L.L.
P.O. Box 223 Safat
Alghanim Industries
Airport Road Shuwaikh
13003 Kuwait
Phone: +965-4842988
[Ext 2079]
Fax: +965-4847244

Malaysia

Cnn Sdn. Bhd.
Service Center
17D, 2nd Floor
Lebuhraya Batu Lancang
Taman Seri Damai
11600 Jelutong Penang
Phone: +60-4-657-9584
Fax: +60-4-657-0835

Mexico

Metrologia Y Calibraciones
Ind. , S.A. De C.V.
Industrial S.A. De C.V.
Diagonal No. 27-3o Piso
Colonia Del Valle
Mexico C.P. 03100
Phone: +52-5-682-8040
Fax: +52-5-687-8695

Netherlands

Fluke Nederland B.V.
Customer Support Services
Science Park Eindhoven 5108
5692 EC Son
Phone: +31-402-678 310
Fax: +31-402-678 321
E-MAIL:
wheijden@son.nl.fluke.nl

New Zealand

Philips Scientific & Industrial,
Pty., Ltd.
Service Center
Private Bag 41904
St. Lukes, 2 Wagener Place
Mt. Albert
Auckland 3
Phone: +64-9-849-4160
Fax: +64-9-849-7814

Norway

Fluke Norge A/S
Customer Support Services
P.O. Box 6054
Etterstad
N 0601 Oslo
Phone: +47-22-65-3400
Fax: +47-22-65-3407

Pakistan

Philips Electrical Industries Of
Pakistan Ltd.
Islamic Chamber of
Commerce
St-2/A, Block 9
KDA Scheme 5, Clifton
Karachi 75600
Phone: +92-21-587-4641
Fax: +92-21-577-0348

Peru

Importaciones &
Representaciones
Service Center
Jr. Pumacahua 955
Lima 11
Phone: +51-14-235099
Fax: +51-14-310707

Philippines

Spark Electronics Corporation
P.O. Box 610, Greenhills
Metro Manila 1502
Phone: +63-2-700621
Fax: +63-2-721-0491

Poland

Electronic Instrument Service
(E.I.S.)
Philips Consumer Service
UL. Malechowska 6
60 188 Poznan
Phone: +48-61-681998
Fax: +48-61-682256

Portugal

Fluke Ibérica S.L.
Sales & Services Department
Campo Grande 35 - 7ºb
1700 Lisboa
Phone: +351-1-795-1712
Fax: +351-1-795-1713

Romania

RONEXPRIM S.R.L.
Customer Support Services
Str. Transilvaniei Nr. 24
70778 Bucharest - I
Phone: +40-1-6143597
Fax: +40-1-6594468

Russia C.I.S.

Infomedia
UL. Petrovsko Razumovsky
Proezd. 29
103287 Moscow
Phone: +7-095-2123833
Fax: +7-095-2123838

Saudi Arabia

A. Rajab & Silsilah Co.
Sales & Service Department
P.O. Box 203
21411 Jeddah
Phone: +966-2-6610006
Fax: +966-2-6610558

Singapore

Fluke Singapore Pte., Ltd.
Service Center
#27-03 PSA Building
460 Alexandra Road
Singapore 119963
Phone: +65*-276-5161
Fax: +65*-276-5929

South Africa

Spescom Measuregraph Pty.,
Ltd.
Service Center
SPESCOM Park
Crn. Alexandra Rd. &
Second St.
Halfway House
Midrand 1685
Phone: +27-11-315-0757
Fax: +27-11-805-1192

Spain

Fluke Ibérica S.L.
Customer Support Services
Centro Empresarial Euronova
C/Ronda De Poniente, 8
28760 - Tres Cantos
Madrid
Phone: +34-1-804-2301
Fax: +34-1-804-2496

Sweden

Fluke Sverige AB
Customer Support Services
P.O. Box 61
S 164 94 Kista
Phone: +46-8-751-0235
Fax: +46-8-751-0480

Switzerland

Fluke Switzerland A.G.
Customer Support Services
Rütistrasse 28
CH 8952 Schlieren
Phone: +41-1-730-3310
Fax: +41-1-730-3720

Taiwan, R.O.C.

Schmidt Scientific Taiwan,
Ltd. Service Center
6f, No. 109, Tung Hsing St.
Taipei
Phone: +886-2-767-8890
Fax: +886-2-767-8820

Thailand

Measuretronix Ltd.
Service Center
2102/31 Ramkamhang Road
Bangkok 10240
Phone: +66-2-375-2733
Fax: +66-2-374-9965

Turkey

Pestas Prof. Elektr. Sistemler
Tic. ve San. A.S.
Selcuklar Caddesi
Meydan Apt. No. 49
Daire 23
Akatlar 80630 Istanbul
Phone: +90-212-2827838
Fax: +90-212-2827839

U.A.E.

Haris Al-Afaq Ltd.
P.O. Box 8141
Dubai
Phone: +971-4-283623
Fax: +971-4-281285

U.S.A.

Fluke Corporation
Service Center - Palatine
1150 W. Euclid Avenue
Palatine, IL 60067
Phone: +1-708-705-0500
Fax: +1-708-705-9989
E-Mail: larry@wz.fluke.com

Fluke Corporation
Service Center - Paramus
W. 75 Century Road
Paramus, NJ 07652-0930
Phone: +1-201-599-9500
Fax: +1-201-599-2093
E-Mail:
gleckler@wz.fluke.com

Fluke Corporation
Service Center - Everett
Building #4
1420 - 75th St. S.W.
Everett, WA 98203
Phone: +1-206-356-5560
Fax: +1-206-356-6390
E-Mail: ed@wz.fluke.com

Flw
Fluke Calibration Center
C/o Flw Service Corporation
3505 Cadillac Ave., Bldg E.
Costa Mesa, Ca 92626
Phone: +1-714-863-9031
Fax: +1-714-751-0213

Fluke Corporation
Service Center
46610 Landing Parkway
Fremont, CA 94538
Phone: +1-510-651-5112
Fax: +1-510-651-4962
E-Mail: gbondy@wz.fluke.com

Fluke Corporation
Service Center - Dallas
2104 Hutton Drive
Suite 112
Carrollton, TX 75006
Phone: +1-214-406-1000
Fax: +1-214-406-1072
E-Mail:
oldman@wz.fluke.com

United Kingdom

Fluke United Kingdom Ltd.
Customer Support Services
Colonial Way
Watford
Hertfordshire WD2 4TT
Phone: +44-1923-240511
Fax: +44-1923-212157
E-Mail: kgarner@uk.fluke.nl

Uruguay

Coasin Instrumentos S.A.
Service Center
Acevedo Diaz 1161
11200 Montevideo
Phone: +598-2-492-436
Fax: +598-2-492-199

Venezuela

Coasin C.A.
Service Center
Calle 9 Con Calle 4,
Edif Edinurbi
Piso - 3
La Urbina
Caracas 1070-A
Phone: +58-2-242-7466
Fax: +58-2-241-1939

Vietnam

Schmidt-Vietnam Co., Ltd.
6/FI. Pedagogical College
Bldg.
Dich Vong, KM 8 Highway 32
Tu Liem
Hanoi
Phone: +84-4-346186
Fax: +84-4-346-188

Countries not listed

For Eastern Europe and
Middle East
Export Sales
Science Park Eindhoven
5110
5692 EC Son
The Netherlands
Phone: +31-402-678 265
Fax: +31-402-678 260
E-Mail:
aotten@ehv.nl.fluke.nl

All other countries

Fluke Corporation
P.O. Box 9090
Mail Stop 268C
Everett, WA 98206-9090
USA

PLACING ORDERS AND GETTING ASSISTANCE

To locate an authorized service center, visit us on the World Wide Web:

<http://www.fluke.com>

or call Fluke using any of the phone numbers listed below:

+1-888-993-5853 in U.S.A. and Canada

+31-402-678-200 in Europe

+1-425-356-5500 from other countries

AUFTRÄGE VERGEBEN UND ASSISTENZ ANFORDERN

Wenn Sie die Adresse eines autorisierten Fluke-Servicezentrums brauchen, besuchen Sie uns doch bitte auf dem World Wide Web:

<http://www.fluke.com>

oder rufen Sie uns unter einer der nachstehenden Telefonnummern an:

+1-888-993-5853 in den USA und Canada

+31-402-678-200 in Europa

+1-425-356-5500 von anderen Ländern aus

COMMANDES ET ASSISTANCE

Pour localiser un centre de service, visitez-nous sur le World Wide Web:

<http://www.fluke.com>

ou téléphonez à Fluke:

+1-888-993-5853 aux U.S.A. et au Canada

+31-402-678-200 en Europe

1-425-356-5500 pour les autres pays

