

VOLTAGE PROBE

1123A



HEWLETT  PACKARD



OPERATING AND SERVICE MANUAL

MODEL 1123A
VOLTAGE PROBE

SERIALS PREFIXED: 842

See Section VII for Instruments With Other Serial Prefixes

Copyright HEWLETT-PACKARD COMPANY/COLORADO SPRINGS DIVISION 1968
1900 GARDEN OF THE GODS ROAD, COLORADO SPRINGS, COLORADO, U. S. A.

TABLE OF CONTENTS

Section	Title	Page	Section	Title	Page
I	GENERAL INFORMATION	1-1	V	PERFORMANCE CHECK AND ADJUSTMENTS	5-1
	1-1. Introduction	1-1	5-1.	Introduction	5-1
	1-5. Warranty	1-1	5-3.	Test Equipment	5-1
	1-7. Accessories Supplied	1-1	5-5.	Simplified Performance Check	5-1
	1-9. Instrument Identification	1-1	5-7.	Performance Check	5-1
	1-11. Scope of Manual	1-1	5-11.	Preliminary Set-up	5-1
II	INSTALLATION	2-1	5-13.	Input Balance Check	5-1
	2-1. General	2-1	5-14.	DC Offset Check	5-1
	2-3. Initial Inspection	2-1	5-15.	Gain Check	5-1
	2-4. Mechanical Check	2-1	5-16.	Sine Wave Compression Check	5-2
	2-6. Electrical Check	2-1	5-17.	Pulse Compression Check	5-2
	2-8. Claims	2-1	5-18.	Input Capacitance Check	5-3
	2-10. Repackaging for Shipment	2-1	5-19.	Pulse Response Check	5-3
	2-13. Installation	2-1	5-20.	Bandwidth Check	5-3
III	OPERATION	3-1	5-21.	Noise Check	5-4
	3-1. General	3-1	5-22.	Adjustments	5-4
	3-3. Connectors and Accessories	3-1	5-26.	Preliminary Set-up	5-4
	3-5. Output Connector	3-1	5-28.	Input Balance Adjust	5-4
	3-7. Blocking Capacitor Tips	3-1	5-29.	DC Offset Adjust	5-4
	3-9. Divider Tips	3-1	5-30.	Gain Adjustment	5-4
	3-13. Accessories	3-1	5-31.	Pulse Response Adjustment	5-5
	3-16. Operating Procedures	3-1	VI	REPLACEABLE PARTS	6-1
IV	PRINCIPLES OF OPERATION	4-1	6-1.	Introduction	6-1
	4-1. Introduction	4-1	6-4.	Ordering Information	6-1
	4-3. Simplified Circuit Theory	4-1	VII	MANUAL CHANGES AND OPTIONS	7-1
	4-5. Attenuator Probe	4-1	7-1.	Manual Changes	7-1
	4-8. Impedance Converter	4-1	7-3.	Older Instruments	7-1
	4-11. Constant Voltage Source	4-1	7-5.	Newer Instruments	7-1
	4-14. Constant Current Source	4-2	7-7.	Options	7-1
	4-17. Miller Effect	4-2	7-9.	Special Instruments	7-1
	4-20. Differential Amplifier	4-2	VIII	SCHEMATICS AND TROUBLESHOOTING	8-1
	4-24. Functional Description	4-3	8-1.	Introduction	8-1
	4-28. Detailed Theory of Operation	4-3	8-3.	Schematic Diagrams	8-1
	4-30. Source Follower	4-3	8-6.	Component Identification	8-1
	4-32. Constant Current Source	4-3	8-8.	Reference Designation	8-1
	4-34. Emitter Follower	4-4	8-13.	Troubleshooting	8-1
	4-36. Differential Amplifier	4-4	8-17.	Waveforms	8-2
	4-39. Intermediate Amplifier	4-4	8-19.	DC Voltages	8-2
	4-41. Intermediate Amplifier Gain	4-4	8-21.	Repair and Replacement	8-2
	4-43. Constant Voltage Source	4-4	8-23.	Servicing Printed Circuit Boards	8-2
	4-45. Temperature Compensation	4-4			
	4-47. Output Amplifier	4-4			
	4-49. Feedback to Minimize DC Temperature Drift	4-4			
	4-55. DC Gain and Offset Adjustment	4-5			
	APPENDIX I	IA-1			
	Model 10214A	IA-1			
	Model 10215A	IA-3			
	Model 10217A	IA-5			
	Model 10228A	IA-7			

LIST OF ILLUSTRATIONS

Figure	Title	Page	Figure	Title	Page
1-1.	Model 1123A Voltage Probe	1-1	4-6.	Differential Amplifier	4-3
3-1.	Model 1123A Voltage Probe and Accessories	3-0	4-7.	Functional Block Diagram	4-5
3-2.	Installation and Zero Adjustment	3-2	5-1.	Gain Check Test Set-up	5-1
3-3.	Remote Operation	3-3	5-2.	DC Blocking Assembly Schematic	5-2
3-4.	High Impedance Loads	3-4	5-3.	Compression Test Set-up	5-2
3-5.	100:1 Divider Compensation	3-5	5-4.	Pulse Compression Test Set-up	5-2
3-6.	Model 1123A used as Buffer Amplifier for Sync or Trigger Signals	3-6	5-5.	Input Capacitance Test Set-up	5-3
3-7.	Using DC Offset	3-7	5-6.	Pulse Response Test Set-up	5-3
4-1.	Attenuator Probe (100:1)	4-1	5-7.	Bandwidth Test Set-up	5-4
4-2.	Impedance Converter	4-1	5-8.	Noise Test Set-up	5-4
4-3.	Constant Voltage Source	4-2	5-9.	Adjustment Location	5-5/5-6
4-4.	Constant Current Source	4-2	8-1.	Unit System Reference Designation	8-1
4-5.	Miller Effect	4-2	8-2.	Component Identification, Assy A1	8-3
			8-3.	Model 1123A Waveforms	8-4
			8-4.	Component Identification, Assy A2	8-5
			8-5.	Model 1123A Schematic Diagram	8-5

LIST OF TABLES

Table	Title	Page
1-1.	Specifications	1-0
2-1.	Shipping Carton Test Strength	2-1
5-1.	Required Test Equipment	5-0
5-2.	Pulse Response Adjustments	5-5
6-1.	Reference Designators and Abbreviations	6-1
6-2.	Replaceable Parts	6-2
7-1.	Manual Changes	7-1
8-1.	Schematic Symbols and Conventions	8-0
8-2.	Waveforms and DC Voltage Measurement Conditions	8-4

Table 1-1. Specifications

BANDWIDTH

DC to greater than 220 MHz (3 dB down).

PULSE RESPONSE

RISETIME

Less than 1.6 ns (10% to 90%), over full dynamic range.

OVERSHOOT, RINGING, PERTURBATIONS

4% pk-pk with Model 1802A (dc to 100 MHz); 6% pk-pk with 1 GHz system (probe must be properly terminated in 50 ohms).

GAIN

Adjustable to X1 into 50-ohm load.

DYNAMIC RANGE

OUTPUT: ± 0.5 V peak.

INPUT: ± 0.5 V peak around a reference voltage which can be offset with variable control from 0 to ± 0.5 Vdc.

NOISE

Increases noise level by less than 300 μ V pk-pk when used with Model 1802A (dc to 100 MHz).

DRIFT

PROBE TIP ASSEMBLY: Less than 100 μ V/ $^{\circ}$ C.

AMPLIFIER ASSEMBLY: Less than 1 mV/ $^{\circ}$ C.

INPUT IMPEDANCE

100k ohms shunted by approximately 3.5 pF.

OUTPUT IMPEDANCE

50 ohms.

MAXIMUM INPUT

± 50 V (dc + peak ac).

GENERAL

WEIGHT

Net, 2 1/4 pounds (1,0 kg); shipping 4 1/4 pounds (1,9 kg).

POWER

Supplied by Model 1802A plug-in. HP Model 1122A Power Supply may be used to power up to four Model 1123A Active Probes.

LENGTH

Over-all length is approximately 4 1/2 feet.

ACCESSORIES FURNISHED

MODEL 10214A 10:1 DIVIDER

Increases input impedance to 1 megohm shunted by approximately 3 pF. Increases input dynamic range to ± 5 V and maximum input voltage to ± 350 V (dc + peak ac). Divider accuracy, $\pm 5\%$.

MODEL 10215A 100:1 DIVIDER

Increases input impedance to 1 megohm shunted by approximately 3 pF. Increases input dynamic range to ± 50 V and maximum input voltage to ± 500 V (dc + peak ac). Divider accuracy, $\pm 5\%$.

MODEL 10217A BLOCKING CAPACITOR

Provides 0.001 μ F, ac-coupling with lower cut-off of 1.6 kHz, or 160 Hz when using divider. Adds less than 3 pF shunt capacitance; maximum input voltage ± 50 V (dc + peak ac), or ± 200 V (dc + peak ac) when using divider.

MODEL 10228A BLOCKING CAPACITOR

Provides 0.18 μ F, ac-coupling with lower cut-off of 12 Hz, or 1.2 Hz when using divider. Adds less than 25 pF shunt capacitance; maximum input voltage ± 50 V (dc + peak ac), or ± 200 V (dc + peak ac) when using divider.

MODEL 10229A HOOK TIP

May be used for circuit probing directly or with dividers and blocking capacitors.

SECTION I GENERAL INFORMATION

1-1. INTRODUCTION.

1-2. The HP Model 1123A Voltage Probe is shown in Figure 1-1. The probe provides low input capacitance, high input impedance, high current gain, and wide bandpass. It is designed to operate with oscilloscopes or other measuring devices having 50-ohm inputs; however, when used with a 50-ohm feed-through termination, it can be used with an instrument having a high input impedance.

1-3. During operation, the Model 1123A allows the operator to probe circuits operating at relatively high frequencies without significant loading effects. High input impedance is maintained by a field effect transistor (FET) mounted close to the probe tip.

1-4. Power for the probe is provided by a connector on the front panel of the HP Model 1802A Dual Channel Vertical Amplifier plug-in or the HP Model 676A Phase/Amplitude Tracking Detector. When operated with other instruments, the Model 1122A Power Supply must be used to obtain power. Refer to Table 1-1 for complete specifications on the Model 1123A Probe.

1-5. WARRANTY.

1-6. This instrument is certified and warranted as stated on the inside front cover of this manual. Should a failure occur within the time stated on the warranty, contact your nearest HP Sales/Service Office immediately.

1-7. ACCESSORIES SUPPLIED.

1-8. The standard Model 1123A Voltage Probe is supplied with the following tips: Model 10217A, High

Frequency Blocking Capacitor, Model 10228A, Low Frequency Blocking Capacitor; Model 10214A, 10:1 Divider; Model 10215A, 100:1 Divider; and the Model 10229A, Hook Tip.

1-9. INSTRUMENT IDENTIFICATION.

1-10. Hewlett-Packard uses a two-section, eight-digit serial number to identify instruments. The first 3 digits (preceeding the dash) are the serial prefix which identifies a series of instruments; the last five digits identify a particular instrument within a series. The serial number appears on a plate on the rear panel. All correspondence with Hewlett-Packard in regard to an instrument should reference the complete eight-digit serial number.

1-11. SCOPE OF MANUAL.

1-12. This manual provides operating and service information for the HP Model 1123A Voltage Probe. Information in this manual applies directly to the instrument (as manufactured) with serial numbers prefixed by the three digits indicated on title page. If the serial prefix of the instrument is different from that on the title page, a "Manual Changes" sheet is supplied. Technical corrections (if any) to this manual, due to known errors in print, are called "Errata" and are shown on the change sheet. For information on manual coverage of any HP instrument, contact the nearest HP Sales/Service Office (addresses are listed at the rear of this manual).

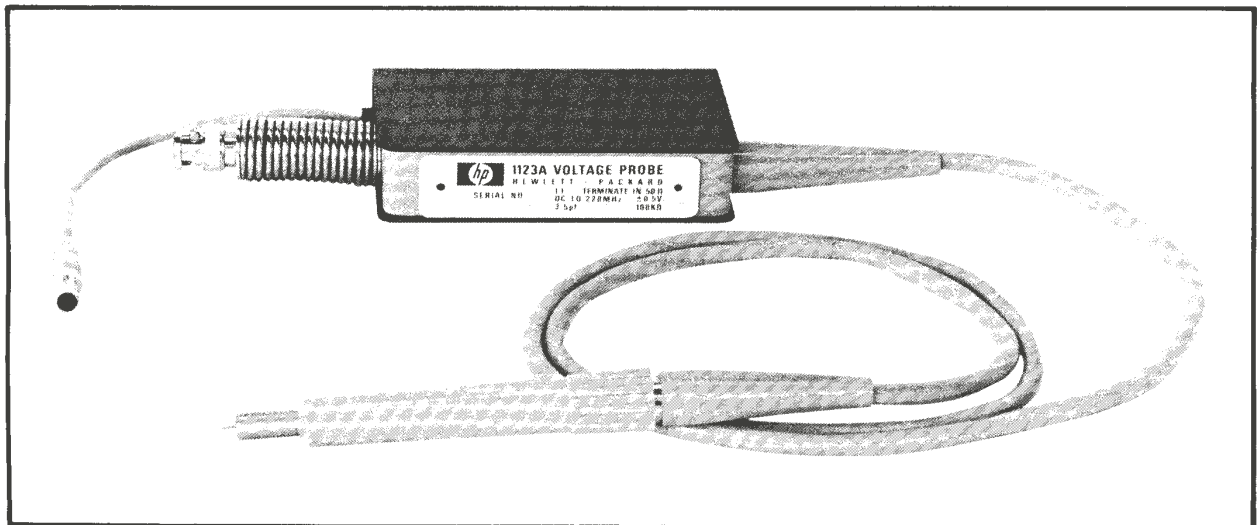

Figure 1-1. Model 1123A Voltage Probe

SECTION II INSTALLATION

2-1. GENERAL.

2-2. This section contains preliminary inspection, and installation procedures for the HP Model 1123A Voltage Probe. In addition, unpacking and claims procedures are discussed in the event damage to the instrument occurs during transit.

2-3. INITIAL INSPECTION.

2-4. MECHANICAL CHECK.

2-5. Upon receipt of this instrument, a complete visual inspection of the shipping carton should be performed. If there is evidence of rough handling or damage to the carton, do not unpack the instrument until the carrier's agent is present. Inspect the Model 1123A for damage such as bent or broken parts. If damage is found refer to Paragraph 2-8 for recommended claims procedure. If no physical damage is apparent, perform the electrical checks in Section V. Retain all packaging material for possible future use.

2-6. ELECTRICAL CHECK.

2-7. This check will determine if the instrument is still operating within the specifications listed in Table 1-1. The performance and accuracy are certified as stated in the warranty on the inside front cover of this manual. If the instrument does not operate as specified, refer to Paragraph 2-8 for recommended claim procedure.

2-8. CLAIMS.

2-9. If physical damage is found or the Model 1123A does not operate as specified, notify the carrier and the nearest HP Sales/Service Office immediately. The Sales/Service Office will arrange for repair or replacement without waiting for a claim to be settled with the carrier.

2-10. REPACKAGING FOR SHIPMENT.

2-11. If the instrument is to be shipped to a Sales/Service Office for repairs, attach a tag showing own-

er's name and address, instrument model number and complete eight digit serial number, and a description of service required.

2-12. The original shipping carton may be used except for any accordion pleated pads. If original carton and packaging material are not available, the following materials should be used:

a. A double-walled carton (refer to Table 2-1 for test strengths required).

Table 2-1. Shipping Carton Test Strengths

Gross Weight (lbs.)	Carton Test Strength (lbs.)
Up to 10	200
10 to 30	275
30 to 120	350
120 to 140	500
140 to 160	600

b. Heavy paper or sheets of cardboard to protect all instrument surfaces (use a non-abrasive material such as polyurethane or a cushioned paper around all projecting parts).

c. At least 4 inches of tightly packed, industry approved shock absorbing material, such as an extra firm polyurethane foam.

d. Heavy duty shipping tape to secure outside of the carton.

2-13. INSTALLATION.

2-14. The Model 1123A Voltage Probe should be connected as shown in Section III. There are two connectors to attach; a BNC at the input of the Vertical Amplifier plug-in and a power connector for operating voltages. Before use, do the performance check in Section V to insure that the instrument is operating according to the specifications given in Table 1-1.

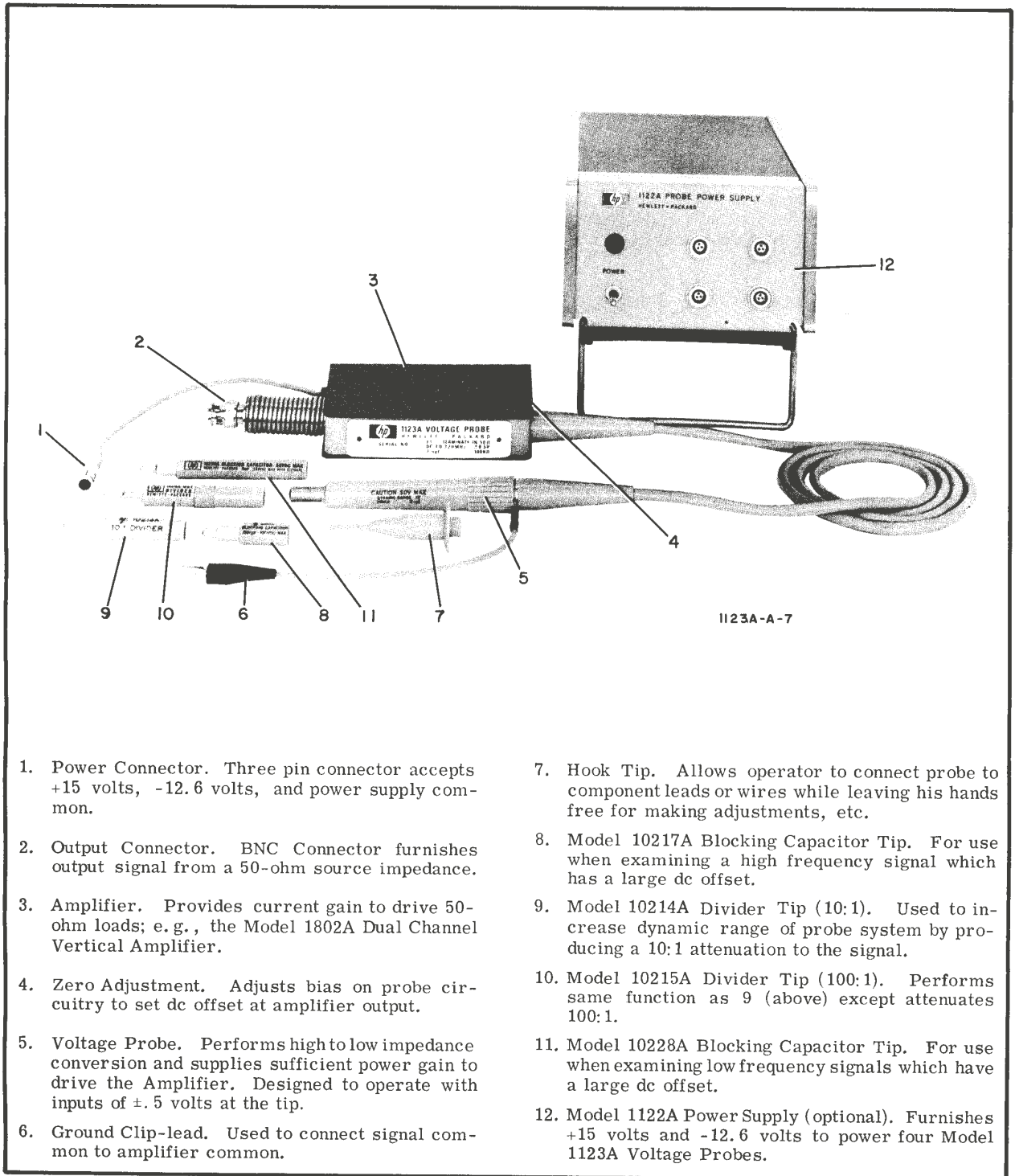

1. Power Connector. Three pin connector accepts +15 volts, -12.6 volts, and power supply common.
2. Output Connector. BNC Connector furnishes output signal from a 50-ohm source impedance.
3. Amplifier. Provides current gain to drive 50-ohm loads; e. g., the Model 1802A Dual Channel Vertical Amplifier.
4. Zero Adjustment. Adjusts bias on probe circuitry to set dc offset at amplifier output.
5. Voltage Probe. Performs high to low impedance conversion and supplies sufficient power gain to drive the Amplifier. Designed to operate with inputs of ± 5 volts at the tip.
6. Ground Clip-lead. Used to connect signal common to amplifier common.
7. Hook Tip. Allows operator to connect probe to component leads or wires while leaving his hands free for making adjustments, etc.
8. Model 10217A Blocking Capacitor Tip. For use when examining a high frequency signal which has a large dc offset.
9. Model 10214A Divider Tip (10:1). Used to increase dynamic range of probe system by producing a 10:1 attenuation to the signal.
10. Model 10215A Divider Tip (100:1). Performs same function as 9 (above) except attenuates 100:1.
11. Model 10228A Blocking Capacitor Tip. For use when examining low frequency signals which have a large dc offset.
12. Model 1122A Power Supply (optional). Furnishes +15 volts and -12.6 volts to power four Model 1123A Voltage Probes.

Figure 3-1. Model 1123A Voltage Probe and Accessories.

SECTION III OPERATION

3-1. GENERAL.

3-2. This section furnishes the information necessary to operate the Model 1123A Voltage Probe. Each connector, adjustment, and accessory is explained briefly in Figure 3-1. Several operating set-ups are given to show equipment versatility and to familiarize the operator with typical measurement operations.

3-3. CONNECTORS AND ACCESSORIES.

3-4. Although the functional descriptions in Figure 3-1 are brief, they provide a quick reference for the operator. Some of the functional areas are explained here in more detail to ensure a thorough understanding of their operation.

3-5. OUTPUT CONNECTOR.

3-6. Output signals from the Probe Amplifier are transferred to the BNC output connector from an emitter-follower stage whose output impedance is maintained at 50 ohms. Due to the high frequency capability of this instrument, it is important to keep this output matched with a 50-ohm load; e. g., the Model 1802A Dual Channel Vertical Amplifier.

3-7. BLOCKING CAPACITOR TIPS.

3-8. The Model 1123A Voltage Probe is dc coupled; therefore, when measuring small ac signals riding on large offset levels, it is necessary to use a dc blocking capacitor. Both Models, 10217A (for high frequencies) and 10228A (for low frequencies), can be used with the Model 1123A Voltage Probe.



Do not apply steps or ac voltages larger than 50 volts peak as they will damage the input FET in the probe.

3-9. DIVIDER TIPS.

3-10. A 900k ohm resistor in series with the input produces a 10:1 attenuation in the Model 10214A Divider

Tip, since the input resistance of the probe is 100k ohms. This tip contains a parallel capacitor for compensation.

3-11. The Model 10215A Divider Tip produces 100:1 attenuation, and contains a manual compensation adjustment. (For theory of operation refer to Simplified Circuit Theory in Section IV.)

3-12. When divider tips are used in conjunction with the probe, maximum input voltage is increased with each divider. With the Model 10214A the maximum input voltage is $\pm 350V$ and with the Model 10215A it is $\pm 500V$.

3-13. ACCESSORIES.

3-14. All probe adapter tips are designed to fit snugly over the end of the Voltage Probe. Combinations can be used to produce a desired result; e. g., both a divider tip and dc blocking tip can be used together. When used together, however, the blocking capacitor must be used in front of the divider tip. The hook tip can also be used with any of these combinations.

3-15. The Model 1122A Power Supply produces sufficient power to operate four HP Model 1123A Voltage Probes. By using this supply, it is possible to operate up to four active probes at remote locations. Connect a 50-ohm coaxial cable from the oscilloscope input to the remote Voltage Probe and turn on the power supply.

3-16. OPERATING PROCEDURES.

3-17. To familiarize the operator with the versatility of the Model 1123A Voltage Probe, Figures 3-2 through 3-7 have been added. All figures contain an instrument picture and required written steps to obtain proper operating conditions. Each control has a callout which corresponds to the step number of the procedure. It is assumed that the operator is familiar with the Model 180-Series Oscilloscope and knows how to obtain proper vertical and horizontal sweep settings. For some of the following operations it is necessary to use AUTO SWEEP MODE and INT synchronization.

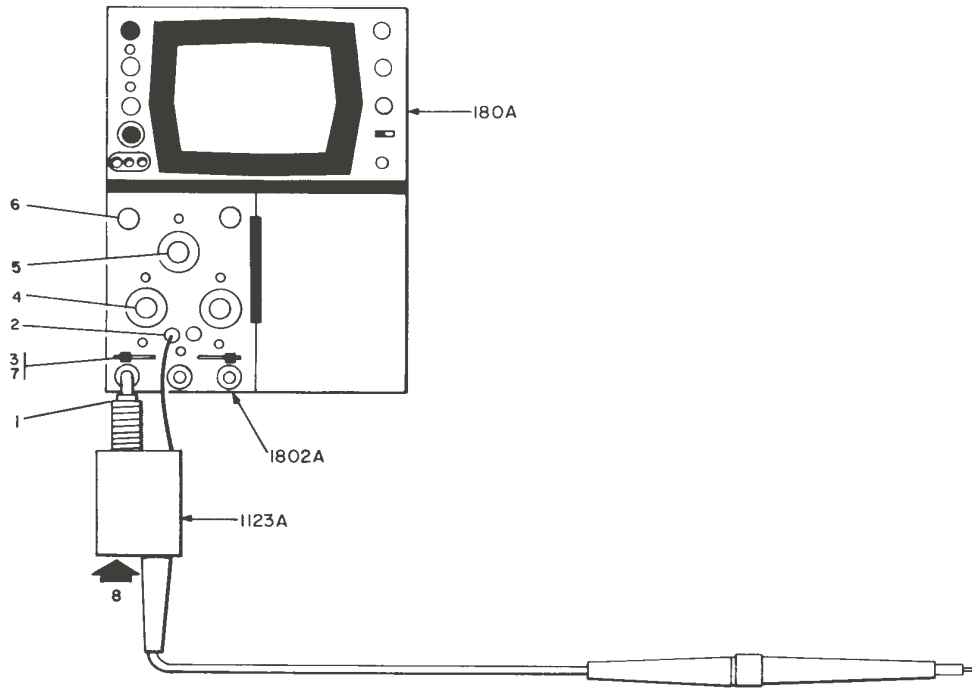

1123A-B-6

1. Connect the Model 1123A Voltage Probe in INPUT A of Model 1802A Dual Channel Vertical Amplifier.
2. Attach HP Model 1123A power connector to appropriate power jack.
3. Set Polarity switch to OFF.
4. Set VOLTS/DIV selector to .01 (Vernier in CAL position).
5. Set DISPLAY to A.
6. Position A trace on center horizontal graticule line.
7. Set Polarity switch to +.
8. Adjust ZERO ADJ potentiometer until trace is on center horizontal graticule line.

Figure 3-2. Installation and Zero Adjustment

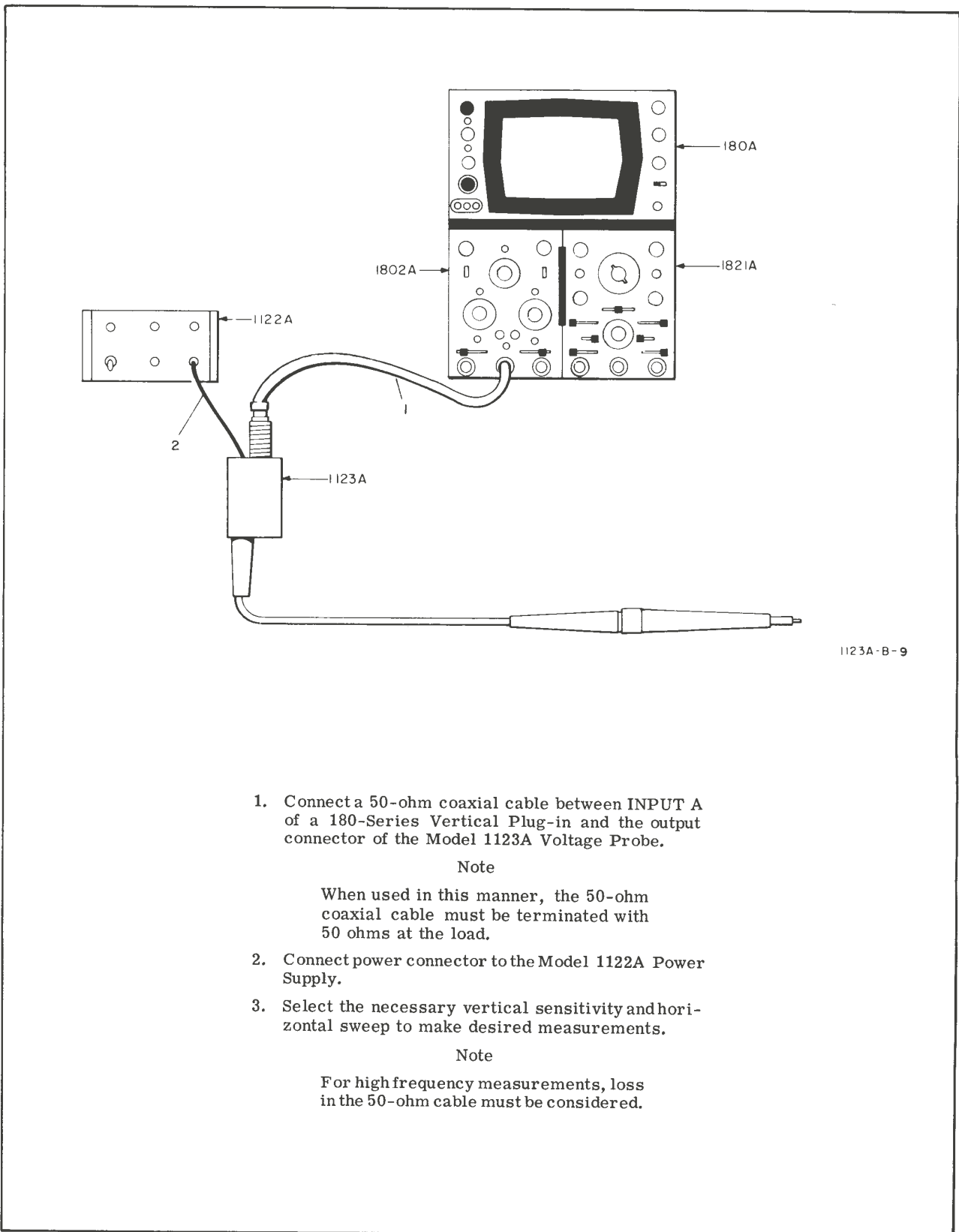

1123A-B-9

1. Connect a 50-ohm coaxial cable between INPUT A of a 180-Series Vertical Plug-in and the output connector of the Model 1123A Voltage Probe.

Note

When used in this manner, the 50-ohm coaxial cable must be terminated with 50 ohms at the load.

2. Connect power connector to the Model 1122A Power Supply.
3. Select the necessary vertical sensitivity and horizontal sweep to make desired measurements.

Note

For high frequency measurements, loss in the 50-ohm cable must be considered.

Figure 3-3. Remote Operation

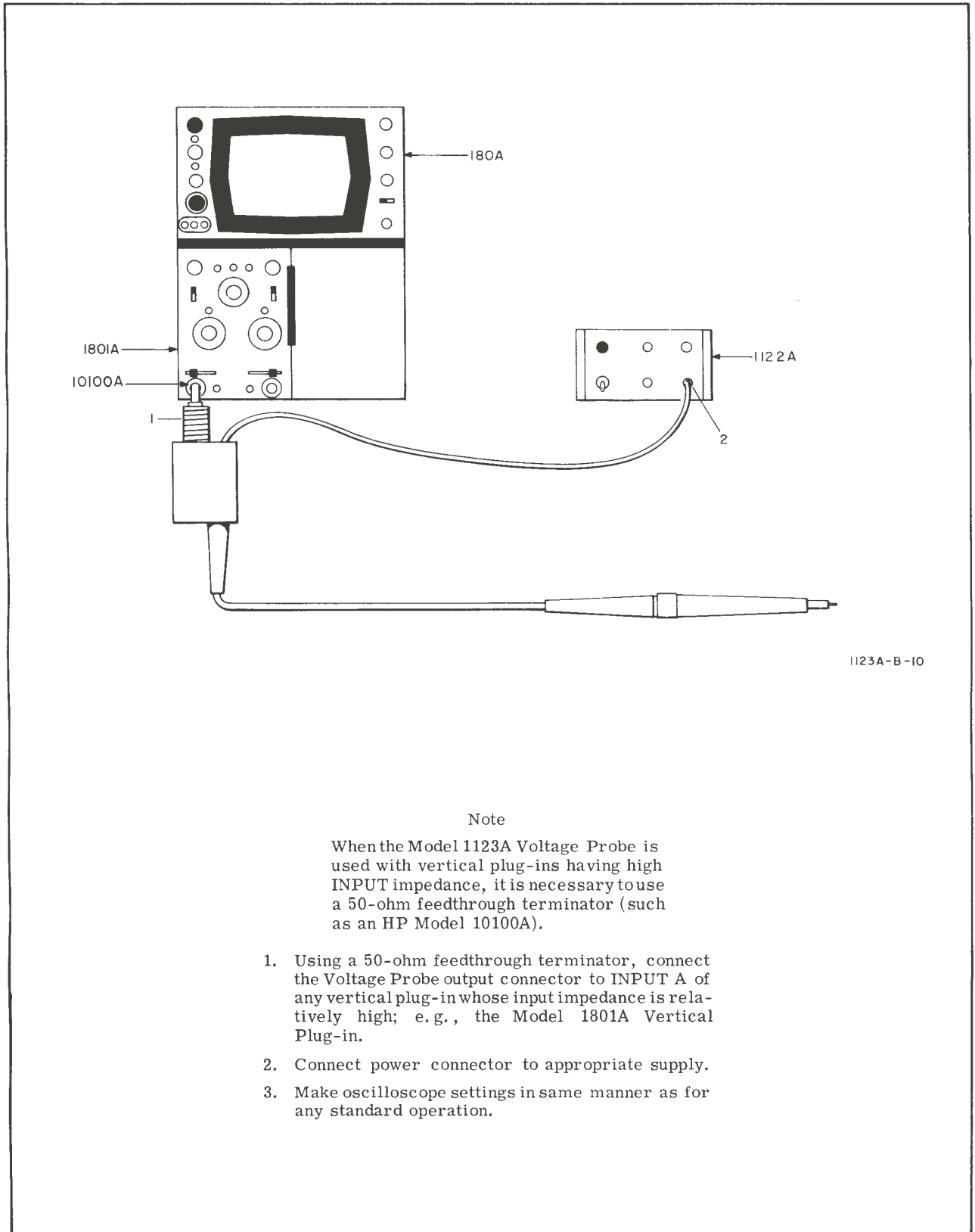

Note

When the Model 1123A Voltage Probe is used with vertical plug-ins having high INPUT impedance, it is necessary to use a 50-ohm feedthrough terminator (such as an HP Model 10100A).

1. Using a 50-ohm feedthrough terminator, connect the Voltage Probe output connector to INPUT A of any vertical plug-in whose input impedance is relatively high; e.g., the Model 1801A Vertical Plug-in.
2. Connect power connector to appropriate supply.
3. Make oscilloscope settings in same manner as for any standard operation.

Figure 3-4. High Impedance Loads

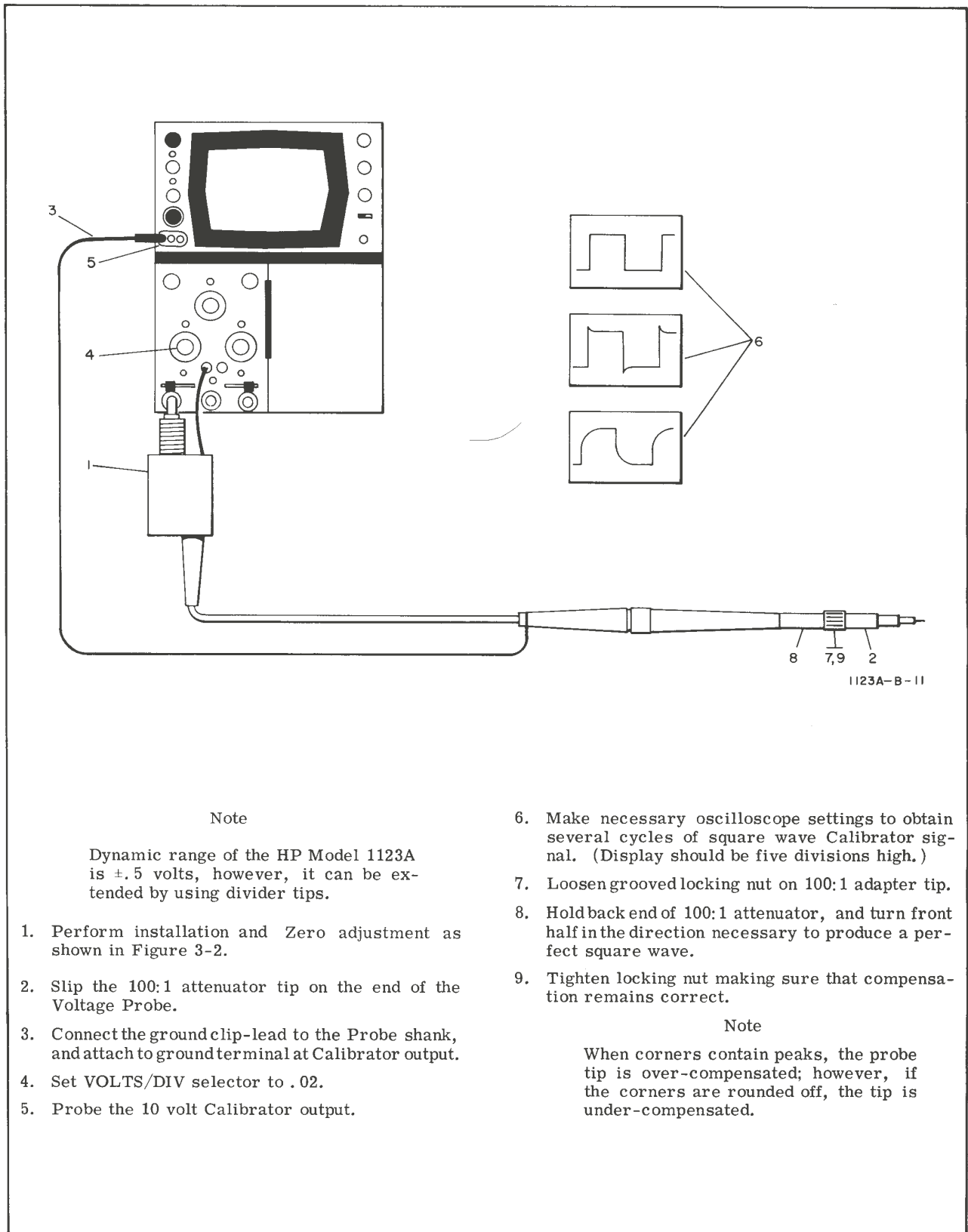

Note

Dynamic range of the HP Model 1123A is ± 5 volts, however, it can be extended by using divider tips.

1. Perform installation and Zero adjustment as shown in Figure 3-2.
2. Slip the 100:1 attenuator tip on the end of the Voltage Probe.
3. Connect the ground clip-lead to the Probe shank, and attach to ground terminal at Calibrator output.
4. Set VOLTS/DIV selector to .02.
5. Probe the 10 volt Calibrator output.

6. Make necessary oscilloscope settings to obtain several cycles of square wave Calibrator signal. (Display should be five divisions high.)
7. Loosen grooved locking nut on 100:1 adapter tip.
8. Hold back end of 100:1 attenuator, and turn front half in the direction necessary to produce a perfect square wave.
9. Tighten locking nut making sure that compensation remains correct.

Note

When corners contain peaks, the probe tip is over-compensated; however, if the corners are rounded off, the tip is under-compensated.

Figure 3-5. 100:1 Divider Compensation

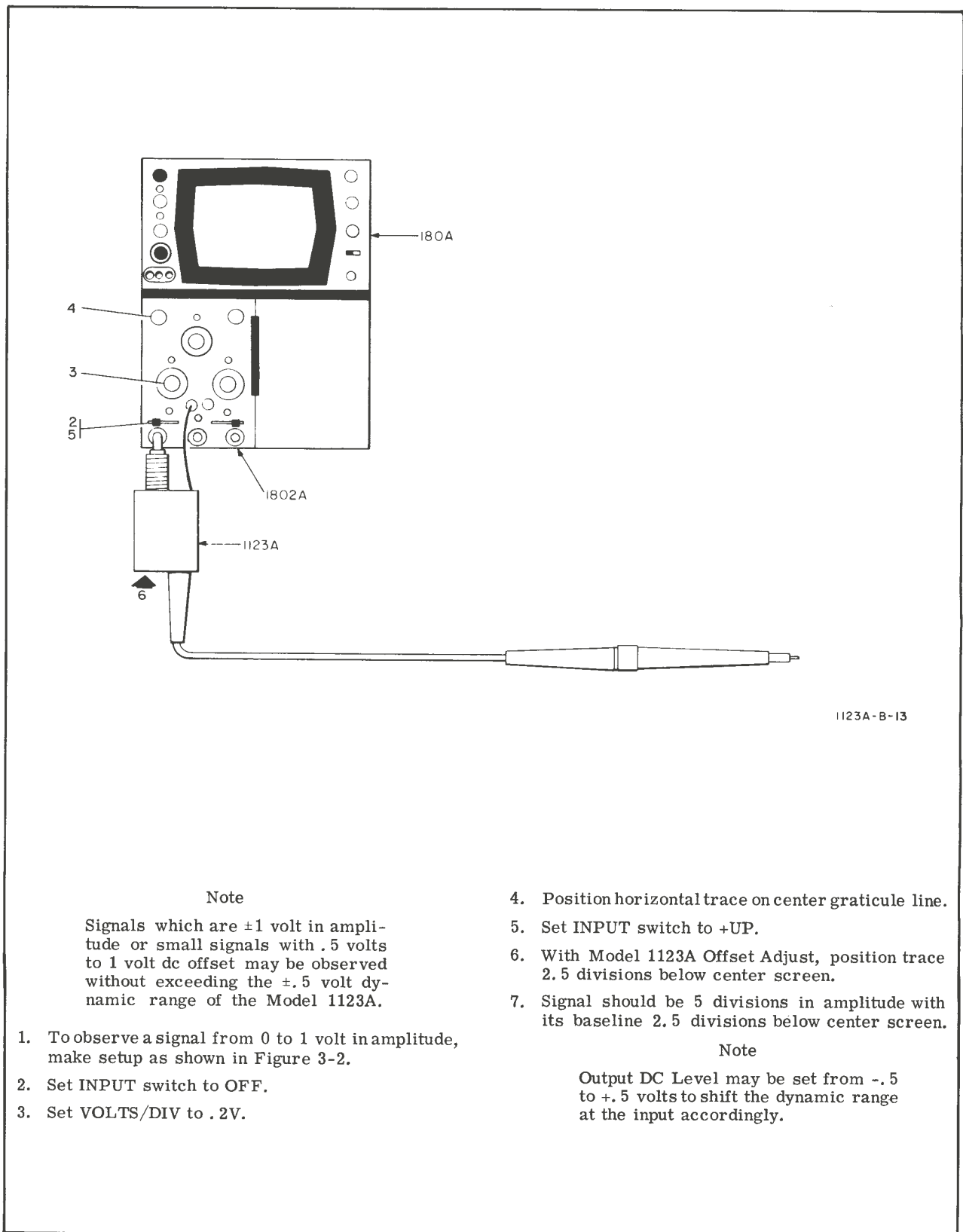

Figure 3-7. Using DC Offset

SECTION IV PRINCIPLES OF OPERATION

4-1. INTRODUCTION.

4-2. This section contains theory of operation for the Model 1123A Voltage Probe. The text is divided into three sub-sections, (1) Simplified Circuit Theory, (2) Functional Description, and (3) Detailed Theory of Operation. Each typical circuit function is discussed once, either in the simplified theory, or as it appears in the main signal path of the detailed theory. The Functional Description is discussed at block level for a quick overall understanding of instrument operation.

4-3. SIMPLIFIED CIRCUIT THEORY.

4-4. Several circuits in the Model 1123A are common circuits and are discussed in their simplified forms. By so doing, the detailed text is reserved for explaining signal flow, special circuits and modifications to basic circuits. Emitter followers, inverting amplifiers, and other simple networks are not discussed.

4-5. ATTENUATOR PROBE.

4-6. Attenuator probes (or probe tip adapters) are used to extend the dynamic range of associated instruments. This is accomplished by a voltage divider in the probe (or tip). Figure 4-1 is an example of a typical 100:1 divider which includes compensating capacitors.

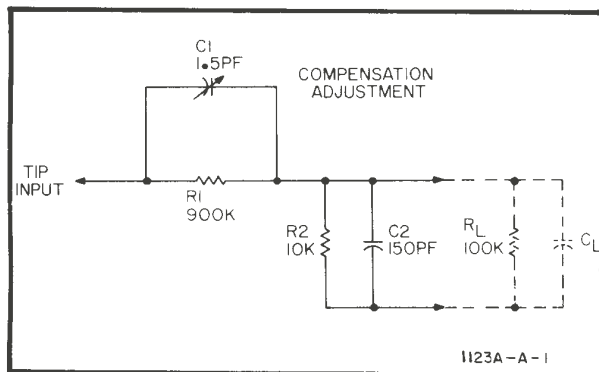

Figure 4-1. Attenuator Probe (100:1)

4-7. To provide 100:1 attenuation, the ratio of R1 to R2 in parallel with the load (R_L) must be 100:1. Since R1 is 900K and equivalent to R2, and R_L is approximately 9K, the dc ratio is correct. For high frequencies, however, the load impedance at the divider output varies due to the load capacitance, C_L , which is the input capacitance of the probe. To minimize the effects of C_L (which might be 2 to 3 picofarads), a large capacitor (C2) is added across the output. This large capacitance performs two functions, (1) it minimizes the effects of load capacitance, and (2) with C1 it comprises a capacitive divider which provides a 100:1 attenuation at high frequencies. Variable capacitor C1 is added in parallel with R1 to

02632-1

provide compensation. To keep the impedance ratio equal to 100:1 at high frequencies, C1 and C2 should be adjusted to the same ratio as R1/R2.

4-8. IMPEDANCE CONVERTER.

4-9. Although there are several methods of accomplishing impedance conversion, the circuit shown in Figure 4-2 has been chosen due to its frequent usage in HP instruments. To reduce loading of circuits being tested, high impedance inputs are used. The field effect transistor (FET) provides this high input impedance (similar to a vacuum tube).

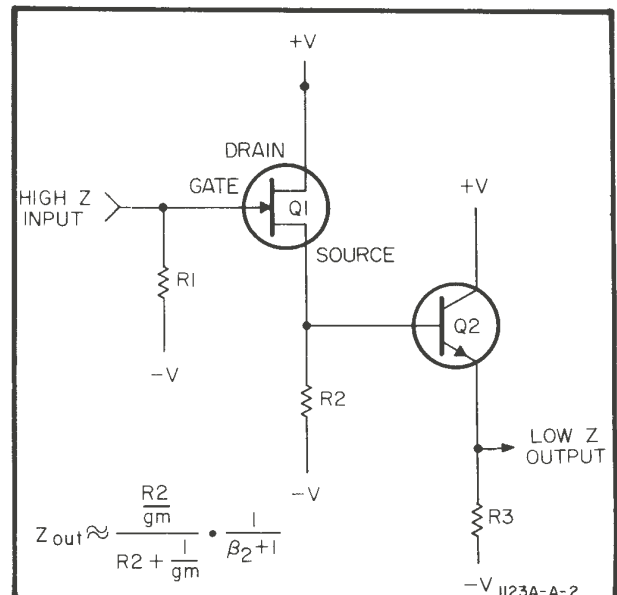

Figure 4-2. Impedance Converter

4-10. Source follower Q1 coupled with emitter follower Q2 produces a high to low impedance conversion. Due to the high input impedance of Q1, the input resistance is established by R1. Output impedance is determined by Q1 and Q2. Emitter follower Q2, connected to the source output, furnishes additional current amplification, thus reducing the output impedance even more. The output impedance (from emitter of Q2 to ground) can be calculated using the equation shown in Figure 4-2.

4-11. CONSTANT VOLTAGE SOURCE.

4-12. As its name implies, the constant voltage source supplies a constant voltage to the load. This circuit is often used to prevent erroneous results caused by fluctuating supply voltages.

4-13. Figure 4-3 shown one method of obtaining a constant voltage source. Voltage divider R1/R2 establishes the desired voltage level at the base of Q1.

4-1

Since the voltage drop across the emitter-base junction of Q1 remains relatively constant, the voltage at the emitter is approximately 0.6 volts more positive than the base voltage. This circuit is an emitter follower, and as such, has a low impedance output. Essentially, this circuit approximates a voltage source whose source impedance is near zero. To calculate the output impedance, use the equation given in Figure 4-3.

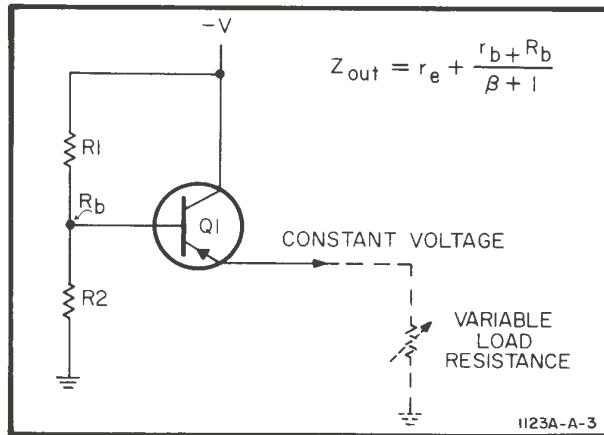

Figure 4-3. Constant Voltage Source

4-14. CONSTANT CURRENT SOURCE.

4-15. To maintain a known current through a varying load, a constant current source must be available. The source bias current in a FET must be held constant to minimize parameter variations. The circuit shown in Figure 4-4 will provide this constant current.

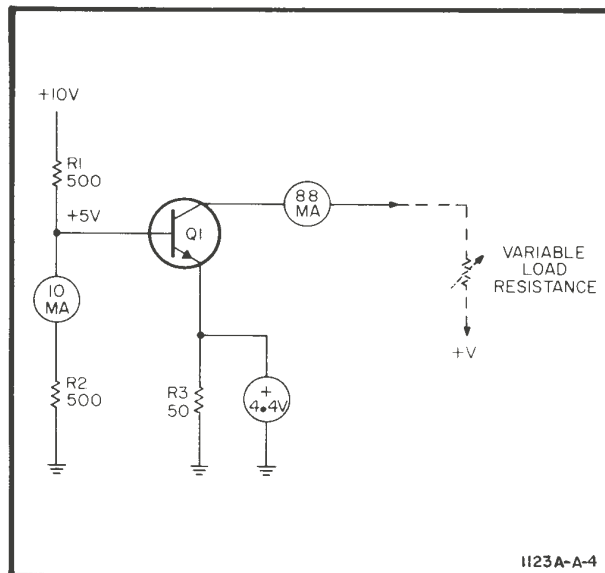

Figure 4-4. Constant Current Source

4-16. Voltage divider R1/R2 establishes a voltage at the base of Q1 which provides forward bias to the transistor. The inherent 0.6 volt drop across the

emitter-base junction results in a constant voltage at the emitter of Q1. As shown in Figure 4-4, the values used will produce a voltage drop of +4.4 volts across resistor R3. Simple calculations show that there is a constant current in the collector circuit of approximately 88 milliamps. This current remains constant regardless of changes in the load resistance, as long as Q1 does not become saturated.

4-17. MILLER EFFECT.

4-18. The Miller Effect in an amplifier results from the transistor interelement capacitance between base and collector. Figure 4-5 is a simple common emitter amplifier with Miller Capacitance (C1) shown in dotted lines. Miller capacitance is detrimental in wide-band high-frequency circuits having high voltage gain, since its effects are amplified by the gain of the stage. Amplification of the effects of C1 is due to the out of phase (and amplified) signal at the collector of Q1. This amplified signal causes more current to be drawn from the base of Q1 through C1, thereby making C1 look like a large capacitance. Negative feedback is produced by C1; consequently, at high frequencies the capacitive reactance decreases causing amplifier gain to decrease. At low frequencies, the Miller Effect is insignificant due to the size of C1, which is usually a few picofarads.

4-19. The effects of C1 can be reduced by two means, (1) by making the source resistance low, and (2) by having a low amplifier gain.

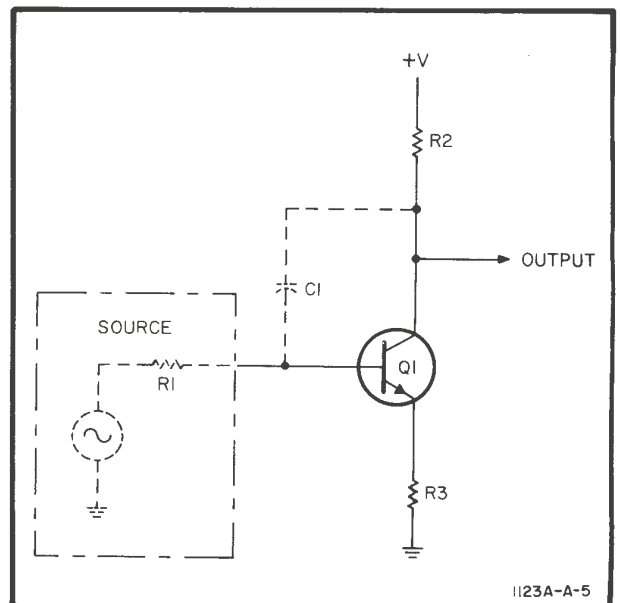

Figure 4-5. Miller Effect

4-20. DIFFERENTIAL AMPLIFIER.

4-21. Differential amplifiers come in a wide variety. The one shown in Figure 4-6 will be used for explanation because of its similarity to the ones used in this instrument. Its ability to reject common mode signals (e.g. noise or 60-Hz signals common to each

input) while producing a differential output make it an excellent choice for many applications. As its name suggests, only the difference between the two inputs is amplified. This makes the differential amplifier suitable for many comparator or control functions. When used in power supply regulator circuits, a fixed reference at one input (B) can be compared to another voltage source at the other input (A). The difference between the two inputs is amplified and the output (C), or complement (D) can then be used as a correction signal to bring one input into balance with the other.

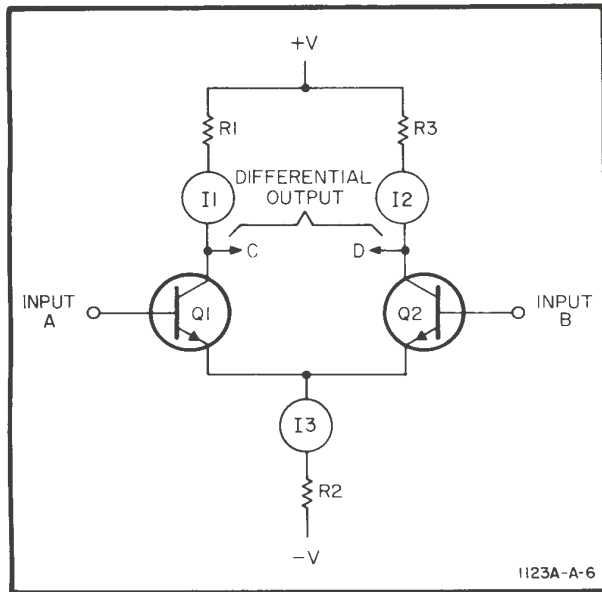

Figure 4-6. Differential Amplifier

4-22. With zero volts (no signal) applied to the inputs, the current through R2 divides equally through Q1 and Q2. Considering either transistor as a separate amplifier, it can be seen that when the base of Q2, for example, is at zero volts the current flowing through the forward biased emitter base junction clamps the top of R2 at approximately -0.6 volts. As long as the base of Q2 remains at zero volts, a constant current (I_3) will flow through R2. If the voltage applied to input A goes slightly positive, the current (I_1) through Q1 increases, causing the voltage drop across R1 to increase. Since R2 is a constant current source, when I_1 increases I_2 must decrease, thereby decreasing the voltage drop across R3. When the input voltage at input A goes in a negative direction, the opposite will happen, i.e. I_1 decreases and I_2 increases causing the voltage across R1 and R3 to change in opposite directions. These voltage changes are 180° out-of-phase; therefore, the output signal generated between points C and D is differential.

4-23. Normally, input A accepts the signal voltage and input B is the reference (or ground) signal. Occasionally, long leads are required to connect one instrument to another. Consequently, noise or 60 Hz pickup is often induced on the signal leads. The differential amplifier only amplifies the difference

between the two inputs; therefore, the undesirable common mode signal is rejected.

4-24. FUNCTIONAL DESCRIPTION.

4-25. Figure 4-7 is a functional block diagram which shows the major stages of the Model 1123A Voltage Probe. The high impedance and low capacitive input provides minimum loading to circuits being examined. The Impedance Converter functions basically as described above and provides the high to low impedance conversion. The incoming signal is then applied to a Differential Amplifier which provides impedance matching to drive the 100-ohm coaxial cable. To keep signal losses to a minimum, a Constant Current Source and Constant Voltage Source are used to supply power to part of the probe and amplifier circuitry.

4-26. The incoming signal from the probe assembly is applied to an Intermediate Amplifier whose input impedance is matched to the cable. An Output Amplifier provides current gain and impedance matching to drive a 50-ohm load.

4-27. To maintain low dc drift in the probe assembly, several amplifier stages are used in a closed loop feedback configuration. The output of A2Q4 is summed with an amplified and inverted input at the Error Amplifier. Any resulting offset is amplified and fed back to the probe. This feedback signal controls the dc level of the Differential Amplifier in the probe and causes the output to increase or decrease until the offset at the Error Amplifier is zero. When the error is zero, the dc output voltage at connector P1 is correct.

4-28. DETAILED THEORY OF OPERATION.

4-29. The overall function of the Probe having been discussed in the preceding paragraphs, the following paragraphs now provide a stage-by-stage detailed description of the entire Probe circuit. Refer to the schematic diagram, Figure 8-1, in conjunction with the following text.

4-30. SOURCE FOLLOWER.

4-31. To insure minimum loading to the circuit being tested, source follower A1Q1 is used immediately following the probe tip due to its input impedance characteristics. Resistor A1R2 across the input performs two functions: (1) it establishes a fixed 100k ohm input resistance for the probe, and (2) fixes the gate bias on A1Q1 when no signal is present at the input. Resistor A1R1 furnishes overload protection up to 50 volts by limiting the gate current of A1Q1. High frequency response is maintained by A1C1. Resistor A1R3 is used as a damping resistor to minimize the effects of lead inductance.

4-32. CONSTANT CURRENT SOURCE.

4-33. Source Follower, A1Q1, is biased by the Constant Current Source A2Q9. Resistor values in the base and emitter circuits of A2Q9 establish a constant current of 5 milliamps to bias the source follower

low drift using a FET source follower unless a matched pair is used or the drain bias current supply is variable. A feedback amplifier is used to establish the dc output level and low frequency gain. By using this type of feedback amplifier, dc drift in the probe tip assembly is almost completely eliminated.

4-51. To understand how the feedback system operates, assume an input of 0.5 volts at the probe tip. From previously established gain, assume a 1 volt output at the emitter of A2Q4. The 0.5 volt input produces a 10 microamp current flow through A1R2 to the base of A2Q11. Differential Feedback Amplifier A2Q10/Q11 provides a gain of -0.5 which results in 0.25 volts at the emitter of A2Q10. The gain of this amplifier is set by the ratio of the feedback resistor (A2R28) to the input resistor (A1R2). Input Balance Adjust (A2R32) is adjusted during calibration to insure zero volts at the base of A2Q11 and at the probe tip with no signal applied.

4-52. With -0.25 volts at the bottom of A2R39 and 1 volt at the top of A2R44, the input to the Error Amplifier (the base of A2Q8) should see a null (zero volts) at the summing point. If no error is present at the base of A2Q8B, the feedback signal does not change. The Differential Input Amplifier A1Q3/Q4 is not affected, and the output remains constant.

4-53. If the output at the emitter of A2Q4 were slightly more positive than 1 volt, the summing point would go slightly positive, increasing the forward bias on A2Q8B. The resulting small decrease in collector voltage on A2Q8B is coupled to the base of A2Q6. After amplification and inversion by A2Q5/Q6, the

feedback signal is connected to the base of A1Q4. Because this signal has increased in a positive direction, it causes increased conduction in A1Q4. Due to the differential connection of A1Q3/Q4, current in A1Q3 decreases. Due to the decrease in A1Q3 collector current, the collector voltage increases. Transistor A2Q1 inverts this signal causing it to go less positive. Consequently, the output at A2Q4 goes negative, bringing the signal back into balance at the summing point.

4-54. It should be understood that this feedback amplifier circuitry forms a closed loop around the probe amplifier, and that operation is instantaneous. When properly adjusted, the instrument will track from input to output providing a 1:1 dc output to any 50 ohm load. The dc temperature drift characteristics are determined by the feedback amplifier. The only component affecting temperature drift in the probe tip assembly is A1R2. In the amplifier assembly drift determined by A2Q8A/B and A2Q11A/B which are matched pairs. Therefore there is almost no dc drift due to temperature changes.

4-55. DC GAIN AND OFFSET ADJUSTMENT.

4-56. Potentiometer A2R38 and A2R41 apply a dc input signal to the feedback system which can be adjusted for the desired dc output level. If it is desired to look at an input signal 0 volts to +1 volts, the probe output can be adjusted to -0.5 volts, thus when the input signal goes to +1 volt, the output goes to +0.5 volts. In this manner, a +1 volt signal can be observed without exceeding the ± 0.5 volt dynamic range of the probe. DC gain of the feedback system is adjusted by A2R43.

F
11

into the desired operating range. Diode A2CR2 temperature compensates the current source A2Q9, keeping the output current to A1Q1 constant.

4-34. EMITTER FOLLOWER.

4-35. Source Follower A1Q1 followed by emitter follower A1Q2 constitutes an impedance converter. It accepts signals through its high impedance input, and furnishes the signal to differential amplifier stage A1Q3/Q4 from its low impedance output. As explained previously, the low output impedance of emitter follower A1Q2 produces maximum bandwidth by minimizing the effects of Miller capacitance in the following stage, A1Q3. Capacitor A1C4 bootstraps the source resistor of A1Q1 thus maintaining constant current biasing of A1Q1 and eliminating high frequency distortion. High frequency stabilization is maintained by A1R4 and A1C2.

4-36. DIFFERENTIAL AMPLIFIER.

4-37. Differential Amplifier A1Q3/Q4 performs two important functions: (1) it provides current amplification which is required to drive the four-foot, 100-ohm coaxial cable (W1) which connects the probe tip and amplifier assembly and (2) it provides the means for introducing a dc voltage to counteract variations in gate to source voltage of Q1 and therefore, establish the probe dc level at the probe output. The amplifier is designed for a gain of one to minimize the Miller Effect. Inductor A1L1 compensates for collector capacitance of A2Q3 and better terminates the sending end of the 100-ohm coaxial cable. It also provides some high frequency compensation.

4-38. Feedback from the output amplifier, A2Q4 is applied to the base of A1Q4. This feedback signal is generated as a result of an offset (or error) between input and output levels, detected at the base of A2Q8B (the summing point for input and output currents). When an error is detected, it causes an increase or decrease in the voltage difference between the base of A1Q3 and A1Q4. This error signal is fed through A2Q1 and A2Q4 causing the output level to change until the resulting error signal at A2Q8B drops to zero. Thus the feedback network maintains the desired dc level from input to output.

4-39. INTERMEDIATE AMPLIFIER.

4-40. Transistor A2Q1 receives the signal through cable W1. Resistor A2R1 terminates the cable with 100 ohms to provide impedance matching at its output end. Inductor A2L1 compensates for loading caused by the input capacitance of A2Q1. Common emitter stage A2Q1 provides a voltage gain of approximately 2.2 and contains both emitter and collector peaking networks for maintaining a flat frequency response. Emitter peaking is accomplished by frequency compensating adjustments C3, C4, C5, R5, R7, R8, R10 and R48. Collector peaking furnishes additional compensation with L3 peaking medium frequencies and L2 peaking high frequencies.

4-41. INTERMEDIATE AMPLIFIER GAIN.

4-42. To determine Intermediate Amplifier gain, the total emitter resistance in the circuit of A2Q1 is equal to the sum of resistors R5, R6 and the internal resistance of Q1 (totaling approximately 90 ohms for all three). Collector load resistance is equal to the equivalent of A2R11 in parallel with A2R15 (approximately 200 ohms). Therefore, the low frequency gain of A2Q1 is about 2.2. Potentiometer A2R5 provides low frequency gain adjustment. Capacitor A2C9 is a temperature compensated capacitor (with a large negative temperature coefficient) which is used to compensate for the inherent negative temperature coefficient of transistor high frequency response in all stages.

4-43. CONSTANT VOLTAGE SOURCE.

4-44. A constant voltage source, comprised of A2Q2 and A2Q3, furnishes a stable voltage level to the emitter network of A2Q1. Zener regulator VR1, temperature compensated by CR1, produces a fixed voltage drop; therefore, the resulting level at the base of A2Q2 remains constant. The majority of current through the diode network supplies probe circuitry. Due to the differential amplifier A1Q3/Q4 used in the probe, the current through CR1 and VR1 is relatively constant. Transistor A2Q3 provides feedback around A2Q2 thus lowering the output impedance of Q2 making it a more effective voltage source.

4-45. TEMPERATURE COMPENSATION.

4-46. Transistor A2Q1 is temperature compensated by A2Q2. Careful examination shows the base/emitter junction of A2Q2 plus L1 and R1 are in parallel with the base/emitter junction of A2Q1 plus R5 and R6. During normal operation, the sum of the voltage drops across each of these strings is equal. Since the change in voltage across these base/emitter junctions is equal, they cancel each other and thus do not affect the output level of A2Q1.

4-47. OUTPUT AMPLIFIER.

4-48. Output Amplifier A2Q4 is an emitter follower which provides a low output impedance of 50-ohms for proper impedance matching. This instrument exhibits a 50-ohm source impedance and is designed to drive a 50-ohm load. The source impedance, looking into connector P1, consists of A2R45 added to the small internal emitter resistance of A2Q4. At high frequencies the internal resistance increases, causing the output impedance to increase; however, due to capacitor A2C13 whose reactance decreases at high frequencies, and R46/C14, the output impedance remains relatively constant at 50 ohms.

4-49. FEEDBACK TO MINIMIZE DC TEMPERATURE DRIFT.

4-50. Since the temperature coefficient of the gate to source voltage of a FET is dependent on the bias current applied to the drain, it is impossible to get

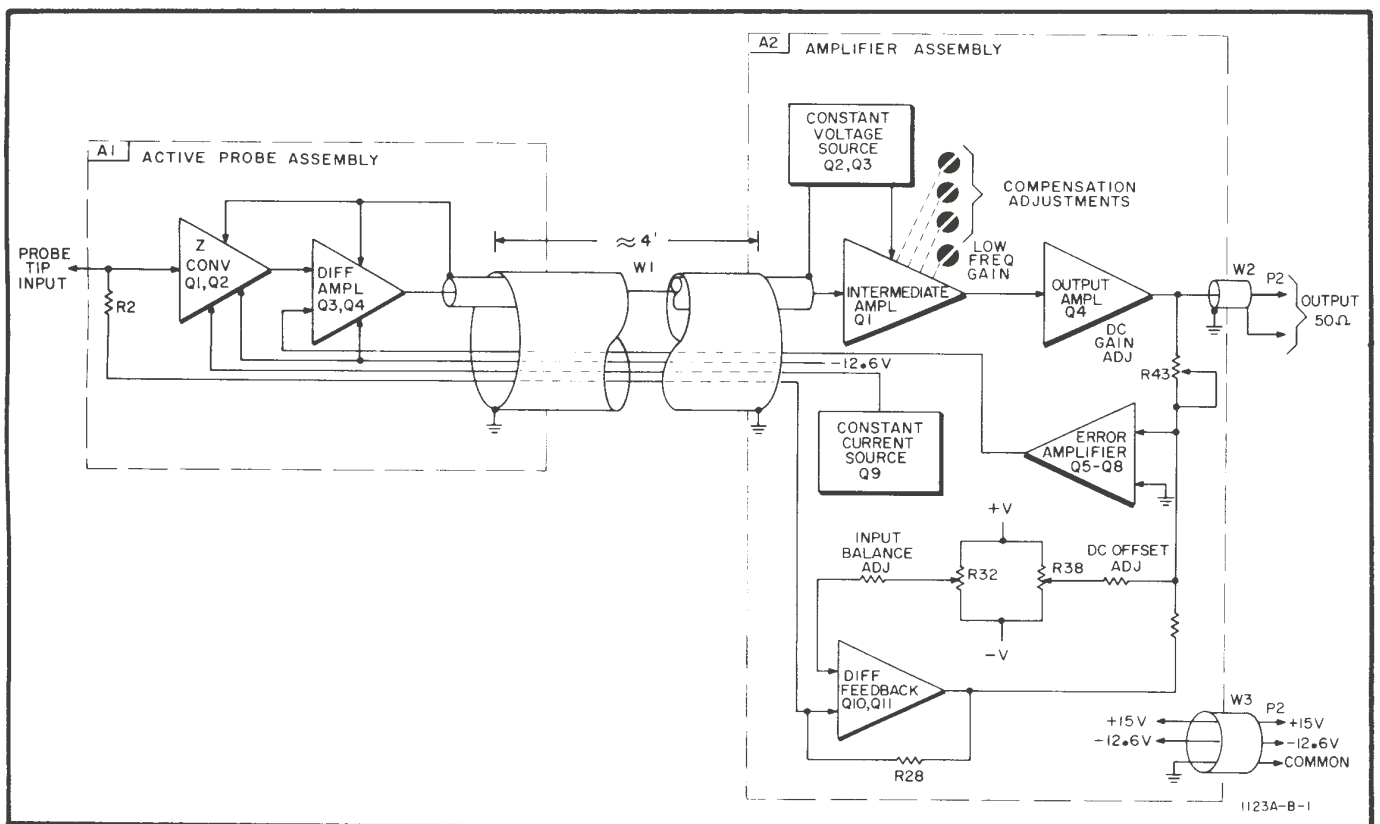

Figure 4-7. Functional Block Diagram

Table 5-1. Required Test Equipment

Recommended Type	Instrument Model	Required Characteristics
DC Voltmeter	HP 412A	100 mV $\pm 1\%$
Oscilloscope	HP 180A w/1801A or 1802A and 1820A	.005 V/Div 2 μ sec/Div
Square Wave Generator	HP 211A	500 Hz - 10 kHz 160 mV
Power Supply	HP 1122A	-12.6 V 120 mZ, +15 V 150 mA
Power Supply	HP 6206A	10.5 V 20 mA
Oscillator	HP 200CD	2 kHz - 200 kHz 40 mV pk-pk
Oscilloscope	HP 140A w/ 1410A and 1424A	100 mV/cm 2 μ sec/cm
Pulse Generator	HP 213B	100 psec risetime 500 mV
RX Meter	HP 250B	Measure 3-4 pF at 100 MHz
VHF Signal Generator	HP 608D	230 MHz 1 V pk-pk
<p>Accessories Required:</p> <ul style="list-style-type: none"> (2) 50-ohm Tee connectors HP Model 10221A (2) BNC Tee connectors HP Part No. 1250-0281 (4) BNC to GR Adapter HP Part No. 1250-0050 (2) BNC to N Adapter HP Part No. 1250-0780 (1) 10 dB Pad GR 874 G10 		

SECTION V PERFORMANCE CHECK AND ADJUSTMENTS

5-1. INTRODUCTION.

5-2. This section contains procedures for performance check and adjustments. The purpose of this information is to determine whether or not the instrument is operating within the specifications as listed in Table 1-1, and if not, how to calibrate the instrument. Physical location of all internal adjustments is shown in Figure 5-9. Troubleshooting information, component and assembly locations, and schematic diagrams are located in Section VIII.

5-3. TEST EQUIPMENT.

5-4. Test equipment needed to check and maintain the instrument is listed in Table 5-1. Similar or equivalent test equipment may be used if necessary. Due to the unique design of this instrument, some of the test equipment required is not commercially available. Steps are given in the performance check and adjustment procedure to build the test fixture necessary to accomplish the procedure. When making adjustments, a non-metallic screwdriver or alignment tool should be used.

5-5. SIMPLIFIED PERFORMANCE CHECK.

5-6. A simplified performance check consisting of selected checks within the over-all procedure is recommended as a quick check to ensure that the instrument is operating properly. To accomplish the quick check, steps 5-13 thru 5-15 and 5-19 should be performed. If a thorough performance check is required, all steps in the procedure must be performed.

5-7. PERFORMANCE CHECK.

5-8. The purpose of this performance check is to determine whether or not the instrument is operating within its listed specifications. This check may be used as part of an incoming quality control inspection, a periodic operational check, or to check the calibration after repair and/or adjustments are made.

5-9. Enter the readings of the initial performance check on the Performance Check Record on Page 5-7/5-8. The form may then be removed and filed in a safe place so that readings taken at a later date can be compared to the original readings.

5-10. It is recommended that the performance checks be done in the sequence given because succeeding steps depend upon control settings and results of previous steps. If necessary, steps may be done individually by referring to control settings and results prior to the desired step.

5-11. PRELIMINARY SET-UP.

5-12. Connect the HP Model 1123A to an appropriate power source.

a. Apply power and allow 5-minute warm-up.

5-13. INPUT BALANCE CHECK.

- a. Connect the Voltmeter to the probe tip pin.
- b. Connect the Voltmeter ground lead to probe ground.
- c. Observe a reading of 0 volts ± 1 mV.

5-14. DC OFFSET CHECK.

- a. Connect a 50-ohm load and Tee connector to the output BNC.
- b. Connect the Voltmeter to the center conductor of the Tee connector.
- c. Connect Voltmeter ground lead to probe ground.
- d. Observe a reading of 0 volts ± 5 mV.

5-15. GAIN CHECK.

- a. Connect the equipment as shown in Figure 5-1.
- b. Set the controls as follows:

VERTICAL AMPLIFIER

VOLTS/DIV 0.02 V
DISPLAY ALT
COUPLING DC

TIME BASE

SWEEP TIME 0.2 msec
TRIGGER AUTO

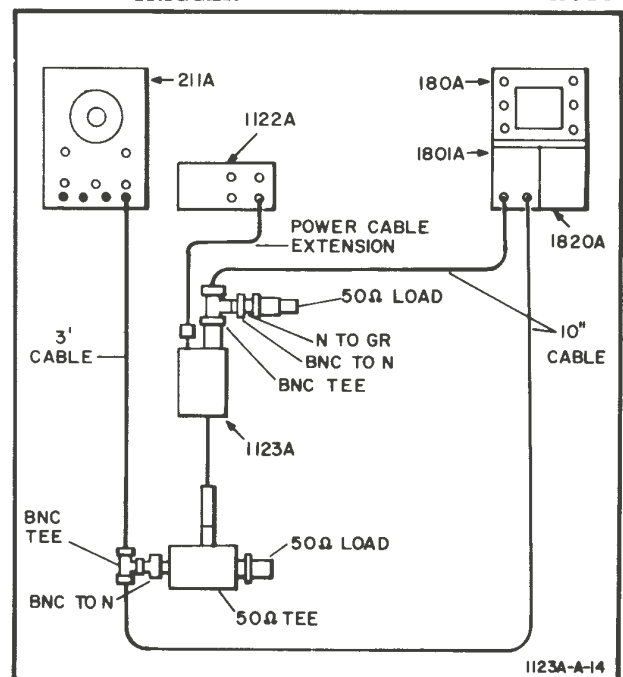

Figure 5-1. Gain Check Test Set-up

SQUARE WAVE GENERATOR

FREQUENCY 500 Hz
AMPLITUDE Set for 8 div display

c. Repeat step b above with SWEEP TIME set to 20 μ sec with 5 kHz input, and 5 μ sec with 10 kHz input.

d. In each of the above conditions, the output of the probe shall be within $\pm 1\%$ (± 0.4 minor divisions) of the input square wave.

5-16. SINE WAVE COMPRESSION CHECK.

Note

The DC Blocking Assembly used in this check allows the input signal to be superimposed on a ± 0.5 volt dc level. The DC Blocking Assembly must be assembled for this test (see Figure 5-2), however care must be taken to minimize perturbations caused by the high frequency signal path.

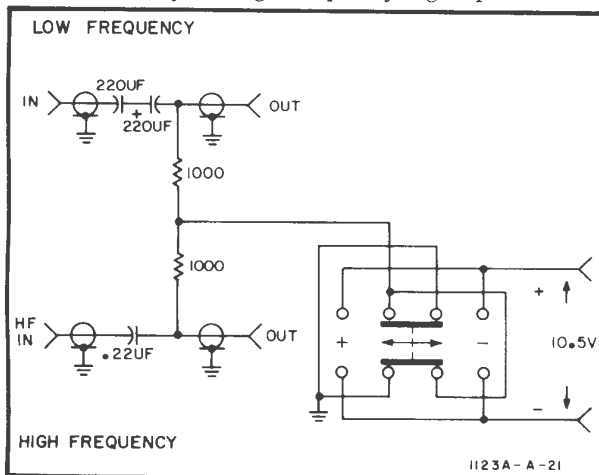

Figure 5-2. DC Blocking Assembly Schematic

- a. Connect the equipment as shown in Figure 5-3.
- b. Set instrument controls as follows:

VERTICAL AMPLIFIER

VOLTS/DIV005
COUPLING AC
VERNIER fully cw

TIME BASE

SWEEP TIME2 msec
MODE AUTO

SINE WAVE GENERATOR

FREQUENCY 2 kHz
AMPLITUDE adjust for 8 div display

- c. Adjust Power Supply output for +10.5 volts.
- d. Set switch on DC Blocking Assembly to the OFF position.
- e. Display should be a sine wave, 8 divisions in amplitude with no visible distortion.
- f. Set switch to plus position and then to minus position. Observe the signal amplitude in each case.

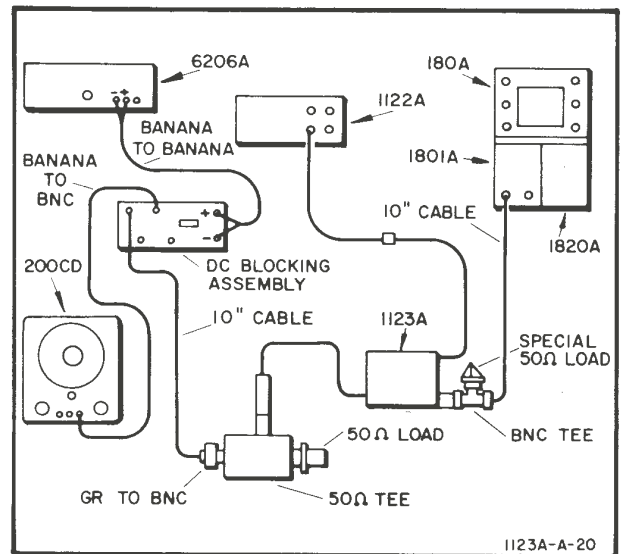

Figure 5-3. Compression Test Set-up

g. Change Oscillator frequency to 200 kHz and Sweep Time to 2 μ sec/div.

h. Repeat steps d thru f.

i. In each of the above cases, the signal compression should be less than 8% (signal amplitude should be greater than 7.4 divisions).

5-17. PULSE COMPRESSION CHECK.

- a. Connect the equipment as shown in Figure 5-4.
- b. Set controls as follows:

SAMPLING VERTICAL AMPLIFIER

VOLTS/CM 10 mV
VERNIER adjust for 10 cm display

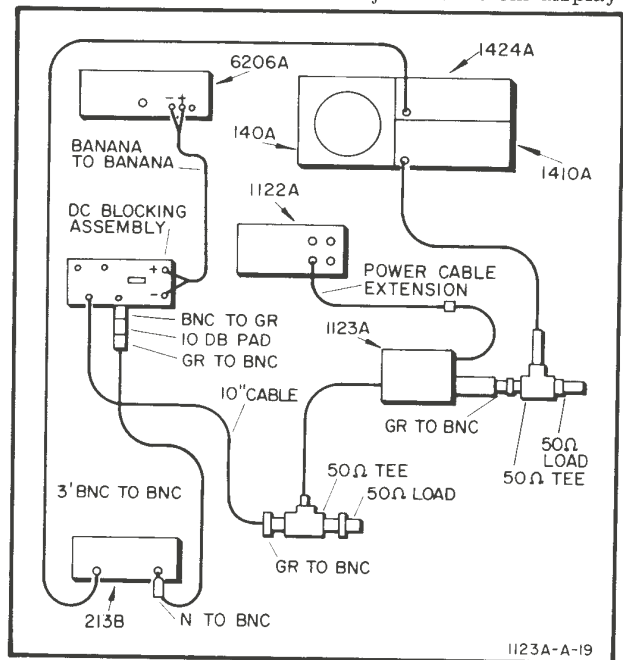

Figure 5-4. Pulse Compression Test Set-up

SAMPLING TIME BASE

SWEEP TIME 10 ns
 LEVEL/MODE FREE RUN
 SCANNING NORMAL
 SYNC PULSE ON

PULSE GENERATOR

PULSE +
 TRIGGER +
 SENSITIVITY for triggered output

- c. Adjust Power Supply output for +10.5 volts.
- d. Set the switch on the DC Blocking Assembly to the OFF position.
- e. Amplitude of the pulse should be 10 cm. Overshoot and ringing should be less than 6% (6 mm).
- f. Set the polarity switch on the DC Blocking Assembly to plus and then minus. The pulse must be repositioned on screen each time.
- g. In each of the conditions in step f, the pulse should be greater than 9.2 cm in amplitude. Overshoot and ringing should be less than 6% of signal amplitude.

5-18. INPUT CAPACITANCE CHECK.

- a. Connect the equipment as shown in Figure 5-5.
- b. Set Frequency of RX Meter to 100 MHz.
- c. Adjust DETECTOR TUNING and null RX Meter.
- d. Apply power to the probe and insert the probe tip into the adapter.
- e. Capacitance should be from 3 to 4 pF.

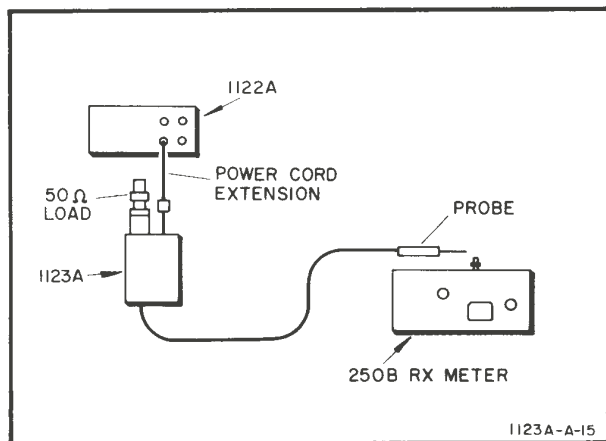

Figure 5-5. Input Capacitance Set-up

5-19. PULSE RESPONSE CHECK.

- a. Connect the equipment as shown in Figure 5-6.
- b. Set controls as follows:
SAMPLING TIME BASE
 TIME/DIV 10 ns
 MAGNIFIER X10
 SYNC MODE AUTO
 SYNC PULSE ON
 SCANNING NORMAL

SAMPLING VERTICAL AMPLIFIER

VOLTS/DIV 50 mV
 VERNIER Set for 10 cm display

PULSE GENERATOR

TRIGGER +
 OUTPUT +
 SENSITIVITY Obtain Trigger

- c. Observe a risetime of less than 1.6 nsec. Overshoot and ringing shall be less than ±3% (3 mm). Perturbations shall be less than 6% (6 mm) pk-pk.

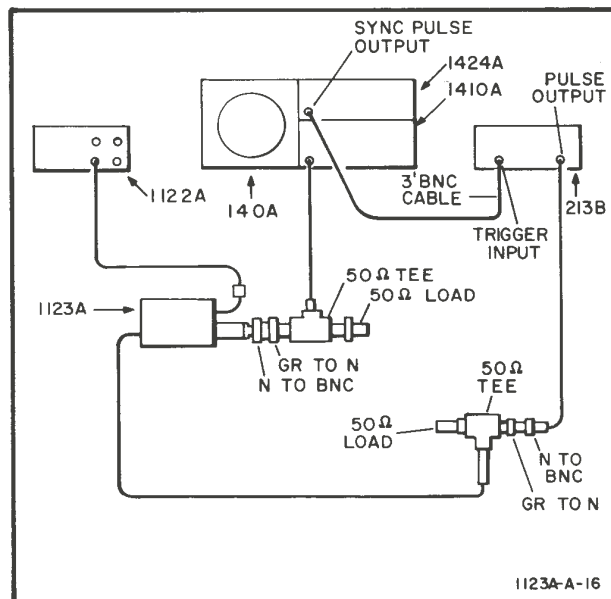

Figure 5-6. Pulse Response Test Set-up

5-20. BANDWIDTH CHECK.

- a. Connect the equipment as shown in Figure 5-7.
- b. Set controls as follows:

SAMPLING TIME BASE

TIME/DIV 2 nsec
 TRIGGER +INT
 SCANNING NORMAL

SAMPLING VERTICAL AMPLIFIER

VOLTS/DIV 100 mV
 VERNIER fully cw
 TRIGGER A

OSCILLATOR

FREQUENCY 220 MHz

- c. Insert the Probe of Model 1410A into the connector labeled B.
- d. Adjust Oscillator output for 10 cm display.
- e. Move the Probe of Model 1410A to the connector labeled A and insert the Model 1123A Probe into the connector labeled B.
- f. Observe a signal of greater than 0.71 V pk-pk (7.1 cm) in amplitude.

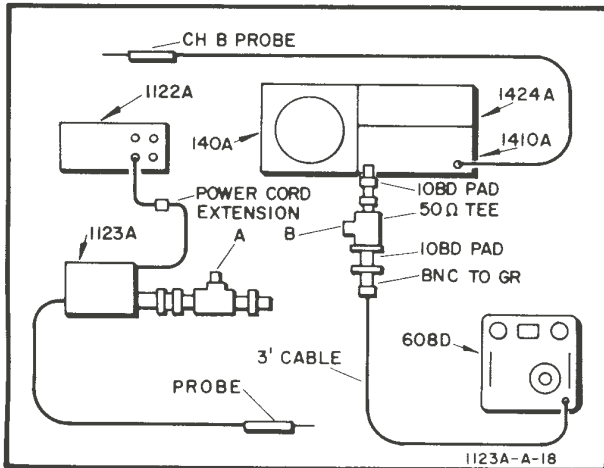

Figure 5-7. Bandwidth Test set-up

5-21. NOISE CHECK.

- a. Connect the equipment as shown in Figure 5-8.
- b. Set controls as follows:

VERTICAL AMPLIFIER

SYNC SOURCE A
 VOLT/DIV (Both Channels)01
 INPUTS OFF
 DISPLAY B

TIME BASE

TIME/DIV 1 μsec
 TRIGGER AUTO

- c. Switch INPUT of both channels to +UP.
- d. Noise should not increase by more than 300 μvolts (0.3 divisions).

Note

It may be necessary to shield the probe tip to prevent noise pick-up.

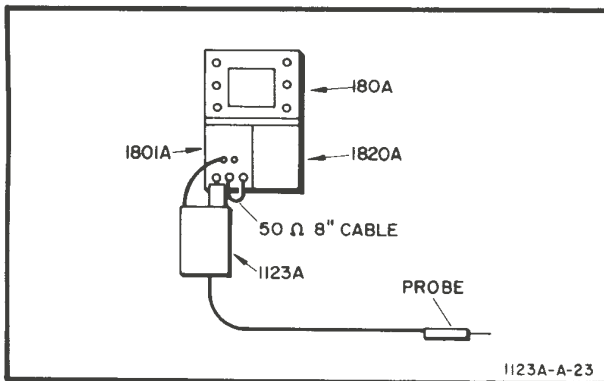

Figure 5-8. Noise Test Set-up

5-22. ADJUSTMENTS.

5-23. The purpose of the adjustment procedure is to establish proper calibration so the instrument will perform as indicated in the specifications given in Table 1-1. Physical location of all adjustments is shown in

Figure 5-9. Recommended test equipment is listed in Table 5-1.

5-24. It is recommended that the adjustment procedure be done in the sequence given because succeeding steps depend upon control settings and results of previous steps.

5-25. When internal adjustments are made, a special cover (HP Part No. 01123-04102) should be used to maintain proper cover to circuit capacitance and operating temperature. If the cover is not used, allow the circuit to reach operating temperature, then remove the cover and make the required adjustment. Replace the cover and wait for circuit to reach operating temperature again before checking the results of the adjustment.

5-26. PRELIMINARY SET-UP.

5-27. Connect the HP Model 1123A to an appropriate power source and allow a five minute warm-up.

5-28. INPUT BALANCE ADJUST.

- a. Connect the Voltmeter to the probe tip pin.
- b. Connect the Voltmeter ground lead to probe ground.
- c. Set Input Balance Adjust A2R32 for 0 volts ±1 mV.

5-29. DC OFFSET ADJUST.

- a. Connect a Tee connector and 50-ohm load to output BNC.
- b. Connect a Voltmeter to the center conductor of the Tee connector.
- c. Connect the Voltmeter ground lead to probe ground.
- d. Adjust A2R38 fully cw, then fully ccw making sure adjustment range is greater than +0.5 volts to -0.5 volts.
- e. Set A2R38 for a reading of 0 volts ±5 mV.

5-30. GAIN ADJUSTMENT.

- a. Connect equipment as shown in Figure 5-1.
- b. Set controls as follows:

SQUARE WAVE GENERATOR

FREQUENCY 100 Hz
 AMPLITUDE Set for 8 div display

VERTICAL AMPLIFIER

VOLTS/DIV02
 DISPLAY ALT
 COUPLING DC

TIME BASE

TIME/DIV 2 msec
 TRIGGER AUTO

- c. Adjust A2R43 so that the square wave output of probe is the same amplitude as input to the probe.
- d. Reset TIME/DIV switch to .5 msec and adjust A2R5 to make leading edges of the square waves identical.
- e. Change Square Wave Generator FREQUENCY to 1 kHz and Time Base Plug-in TIME/DIV to 50 μsec.

- f. Adjust A2R8 for same flatness and shape of both square waves.
- g. Change Square Wave Generator frequency to 20 kHz and Time Base Plug-in TIME/DIV to 5 μ sec.
- h. Adjust A2R10 for same flatness and shape of both square waves.
- i. In each condition above, amplitudes of both square waves should differ by less than 1% (\pm 4 minor divisions).

5-31. PULSE RESPONSE ADJUSTMENT.

- a. Connect the equipment as shown in Figure 5-6.
- b. Set controls as follows:

SAMPLING TIME BASE

TIME/DIV 10 nsec
 MAGNIFIER X1
 MODE AUTO
 SYNC PULSE ON
 SCANNING NORMAL

SAMPLING VERTICAL AMPLIFIER

VOLTS/DIV 50 mV
 VERNIER Set for 10 cm display

PULSE GENERATOR

TRIGGER +
 OUTPUT +
 SENSITIVITY To obtain triggered output

- c. Make appropriate adjustments as listed in Table 5-2 to obtain optimum risetime and pulse response.

Note

Because of adjustment interaction, it may be necessary to repeat the procedure several times.

Table 5-2. Pulse Response Adjustments

Adjustment	Adjusts
C3 thru C5, R7 and R48	Corner
C3 and R7	Level of top
C4	First peak
C5 and R48	Level of top

- d. Risetime should be less than 1.6 nsec.
- e. Overshoot and ringing should be less than \pm 3% (1.5 minor divisions).
- f. Perturbations should be less than 6% pk-pk (3 minor divisions).

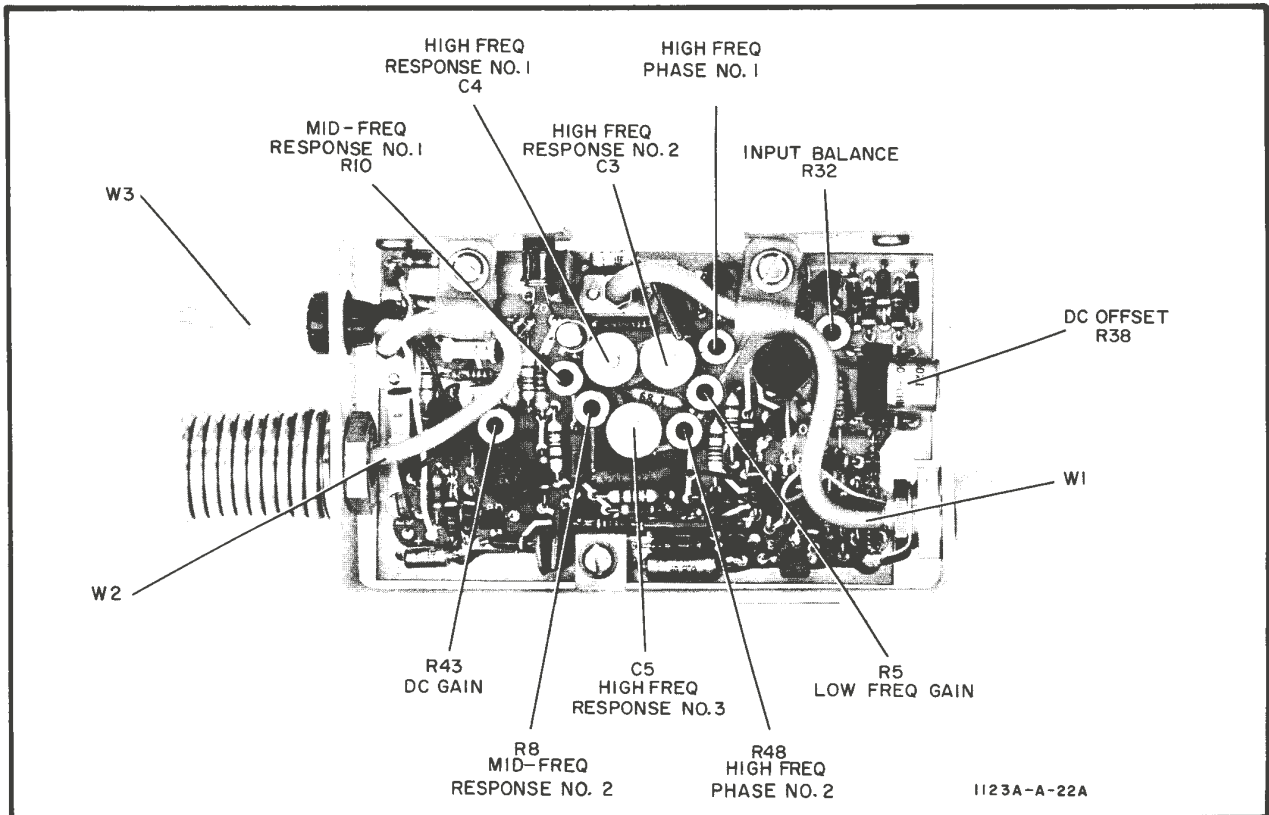

Figure 5-9. Adjustment Location

PERFORMANCE CHECK RECORD

Paragraph	Check	Min	Reading	Max
5-13 step c	<u>Input Balance</u>	None	_____	0 V ±1 mV
5-14 step d	<u>DC Offset</u>	None	_____	0 V ±5 mV
5-15 step d	<u>Gain</u>	7.9 div	_____	8.1 div
5-16 step i	<u>Sine Wave Compression</u>	7.4 div	_____	None
5-17 step e step g	<u>Pulse Compression</u>	None 9.2 cm	_____ _____	6% 10.0 cm
5-18 step e	<u>Input Capacitance</u>	3 pF	_____	4 pF
5-19 step c " " "	<u>Pulse Response</u> "Risetime" "Overshoot" "Perturbations"	None None None	_____ _____ _____	1.6 nsec 3% 6%
5-20 step f	<u>Bandwidth</u>	7.1 cm	_____	None
5-21 step d	<u>Noise</u>	None	_____	1.5 minor div

SECTION VI REPLACEABLE PARTS

6-1. INTRODUCTION.

6-2. This section contains information for ordering replaceable parts for the instrument. Table 6-2 lists the parts in alpha-numerical order of their reference designations and provides the following information for each item:

- a. HP Part Number.
- b. Total quantity (TQ) used in instrument; given only first time a part number is listed.
- c. Description of part; see Table 6-1 for list of reference designators and abbreviations.

6-3. Parts not identified by a reference designation are listed in Table 6-2 under miscellaneous.

6-4. ORDERING INFORMATION.

6-5. To order replacement parts from Hewlett-Packard Company, address the order or inquiry to the nearest HP Sales/Service Office (list at rear of manual) and supply the following information:

- a. HP Part Number of item(s).
- b. Model number and eight-digit serial number of instrument.
- c. Quantity of parts required.

6-6. To order a part not listed in the table, provide the following information:

- a. Model number and eight-digit serial number of instrument.
- b. Description of part including function and location.

6-7. Component descriptions given in Table 6-2 are as complete as possible to assist in obtaining replacement parts from manufacturers other than HP. However, many parts are manufactured only by HP, or are produced by other manufacturers to HP proprietary specifications, and are therefore available only from HP. Actual manufacturer and manufacturers part number for non-HP parts will be supplied upon request. Contact the nearest HP Sales/Service Office.

Table 6-1. Reference Designators And Abbreviations

REFERENCE DESIGNATORS																																																																																																																																																																																																																																							
<table style="width: 100%; border: none;"> <tr><td>A</td><td>= assembly</td></tr> <tr><td>B</td><td>= motor</td></tr> <tr><td>C</td><td>= capacitor</td></tr> <tr><td>CP</td><td>= coupling</td></tr> <tr><td>CR</td><td>= diode</td></tr> <tr><td>DL</td><td>= delay line</td></tr> <tr><td>DS</td><td>= device signaling (lamp)</td></tr> <tr><td>E</td><td>= misc. electronic part</td></tr> <tr><td>F</td><td>= fuse</td></tr> <tr><td>FL</td><td>= filter</td></tr> <tr><td>H</td><td>= hardware</td></tr> <tr><td>IC</td><td>= integrated circuit</td></tr> <tr><td>J</td><td>= jack</td></tr> <tr><td>K</td><td>= relay</td></tr> <tr><td>L</td><td>= inductor</td></tr> <tr><td>LS</td><td>= speaker</td></tr> <tr><td>M</td><td>= meter</td></tr> <tr><td>MP</td><td>= mechanical part</td></tr> <tr><td>P</td><td>= plug</td></tr> <tr><td>Q</td><td>= transistor</td></tr> <tr><td>R</td><td>= resistor</td></tr> <tr><td>RT</td><td>= thermistor</td></tr> <tr><td>S</td><td>= switch</td></tr> <tr><td>T</td><td>= transformer</td></tr> <tr><td>TB</td><td>= terminal board</td></tr> <tr><td>TP</td><td>= test point</td></tr> <tr><td>V</td><td>= vacuum tube, neon bulb, photocell, etc.</td></tr> <tr><td>VR</td><td>= voltage regulator (diode)</td></tr> <tr><td>W</td><td>= cable</td></tr> <tr><td>X</td><td>= socket</td></tr> <tr><td>Y</td><td>= crystal</td></tr> </table>	A	= assembly	B	= motor	C	= capacitor	CP	= coupling	CR	= diode	DL	= delay line	DS	= device signaling (lamp)	E	= misc. electronic part	F	= fuse	FL	= filter	H	= hardware	IC	= integrated circuit	J	= jack	K	= relay	L	= inductor	LS	= speaker	M	= meter	MP	= mechanical part	P	= plug	Q	= transistor	R	= resistor	RT	= thermistor	S	= switch	T	= transformer	TB	= terminal board	TP	= test point	V	= vacuum tube, neon bulb, photocell, etc.	VR	= voltage regulator (diode)	W	= cable	X	= socket	Y	= crystal	<table style="width: 100%; border: none;"> <tr><td>amp</td><td>= amperes</td></tr> <tr><td>ampl</td><td>= amplifier</td></tr> <tr><td>bp</td><td>= bandpass</td></tr> <tr><td>car</td><td>= carbon</td></tr> <tr><td>ccw</td><td>= counterclockwise</td></tr> <tr><td>cer</td><td>= ceramic</td></tr> <tr><td>coef</td><td>= coefficient</td></tr> <tr><td>com</td><td>= common</td></tr> <tr><td>comp</td><td>= composition</td></tr> <tr><td>conn</td><td>= connector</td></tr> <tr><td>crt</td><td>= cathode-ray tube</td></tr> <tr><td>cw</td><td>= clockwise</td></tr> <tr><td>depc</td><td>= deposited carbon</td></tr> <tr><td>elect</td><td>= electrolytic</td></tr> <tr><td>encap</td><td>= encapsulated</td></tr> <tr><td>ext</td><td>= external</td></tr> <tr><td>f</td><td>= farads</td></tr> <tr><td>fet</td><td>= field effect transistor</td></tr> <tr><td>fxd</td><td>= fixed</td></tr> <tr><td>Ge</td><td>= germanium</td></tr> <tr><td>gl</td><td>= glass</td></tr> <tr><td>grd</td><td>= ground(ed)</td></tr> <tr><td>h</td><td>= henries</td></tr> <tr><td>Hg</td><td>= mercury</td></tr> <tr><td>hr</td><td>= hour(s)</td></tr> <tr><td>HP</td><td>= Hewlett-Packard</td></tr> <tr><td>if.</td><td>= intermediate freq.</td></tr> <tr><td>impgr</td><td>= impregnated</td></tr> <tr><td>incd</td><td>= incandescent</td></tr> <tr><td>incl</td><td>= include(s)</td></tr> <tr><td>ins</td><td>= insulation(ed)</td></tr> <tr><td>int</td><td>= internal</td></tr> <tr><td>k</td><td>= kilo (10³)</td></tr> <tr><td>lin</td><td>= linear taper</td></tr> <tr><td>log</td><td>= logarithmic taper</td></tr> <tr><td>lpf</td><td>= low pass filter</td></tr> <tr><td>m</td><td>= milli (10⁻³)</td></tr> <tr><td>meg</td><td>= mega (10⁶)</td></tr> <tr><td>metflm</td><td>= metal film</td></tr> <tr><td>met ox</td><td>= metal oxide</td></tr> <tr><td>mfr</td><td>= manufacturer</td></tr> <tr><td>minat</td><td>= miniature</td></tr> <tr><td>mom</td><td>= momentary</td></tr> <tr><td>mtg</td><td>= mounting</td></tr> <tr><td>my</td><td>= mylar</td></tr> <tr><td>n</td><td>= nano (10⁻⁹)</td></tr> <tr><td>n/c</td><td>= normally closed</td></tr> <tr><td>ne</td><td>= neon</td></tr> <tr><td>n/o</td><td>= normally open</td></tr> <tr><td>npo</td><td>= negative positive zero (zero temperature coefficient)</td></tr> <tr><td>nsr</td><td>= not separately replaceable</td></tr> <tr><td>obd</td><td>= order by description</td></tr> <tr><td>ox</td><td>= oxide</td></tr> <tr><td>pc</td><td>= printed circuit</td></tr> <tr><td>pF</td><td>= picofarads = 10⁻¹² farads</td></tr> <tr><td>piv</td><td>= peak inverse voltage</td></tr> <tr><td>p/o</td><td>= part of</td></tr> <tr><td>porc</td><td>= porcelain</td></tr> <tr><td>pos</td><td>= position(s)</td></tr> <tr><td>pot</td><td>= potentiometer</td></tr> <tr><td>pk-pk</td><td>= peak-to-peak</td></tr> <tr><td>rect</td><td>= rectifier</td></tr> <tr><td>rf</td><td>= radio frequency</td></tr> <tr><td>s-b</td><td>= slow-blow</td></tr> <tr><td>Se</td><td>= selenium</td></tr> <tr><td>sect</td><td>= section(s)</td></tr> <tr><td>semicon</td><td>= semiconductor</td></tr> <tr><td>Si</td><td>= silicon</td></tr> <tr><td>sil</td><td>= silver</td></tr> <tr><td>sl</td><td>= slide</td></tr> <tr><td>spl</td><td>= special</td></tr> <tr><td>Ta</td><td>= tantalum</td></tr> <tr><td>td</td><td>= time delay</td></tr> <tr><td>tgl</td><td>= toggle</td></tr> <tr><td>Ti</td><td>= titanium</td></tr> <tr><td>tol</td><td>= tolerance</td></tr> <tr><td>trim</td><td>= trimmer</td></tr> <tr><td>u</td><td>= micro (10⁻⁶)</td></tr> <tr><td>var</td><td>= variable</td></tr> <tr><td>w</td><td>= watts</td></tr> <tr><td>w/o</td><td>= with</td></tr> <tr><td>w/o</td><td>= without</td></tr> <tr><td>wvdc</td><td>= dc working volts</td></tr> <tr><td>ww</td><td>= wirewound</td></tr> </table>	amp	= amperes	ampl	= amplifier	bp	= bandpass	car	= carbon	ccw	= counterclockwise	cer	= ceramic	coef	= coefficient	com	= common	comp	= composition	conn	= connector	crt	= cathode-ray tube	cw	= clockwise	depc	= deposited carbon	elect	= electrolytic	encap	= encapsulated	ext	= external	f	= farads	fet	= field effect transistor	fxd	= fixed	Ge	= germanium	gl	= glass	grd	= ground(ed)	h	= henries	Hg	= mercury	hr	= hour(s)	HP	= Hewlett-Packard	if.	= intermediate freq.	impgr	= impregnated	incd	= incandescent	incl	= include(s)	ins	= insulation(ed)	int	= internal	k	= kilo (10 ³)	lin	= linear taper	log	= logarithmic taper	lpf	= low pass filter	m	= milli (10 ⁻³)	meg	= mega (10 ⁶)	metflm	= metal film	met ox	= metal oxide	mfr	= manufacturer	minat	= miniature	mom	= momentary	mtg	= mounting	my	= mylar	n	= nano (10 ⁻⁹)	n/c	= normally closed	ne	= neon	n/o	= normally open	npo	= negative positive zero (zero temperature coefficient)	nsr	= not separately replaceable	obd	= order by description	ox	= oxide	pc	= printed circuit	pF	= picofarads = 10 ⁻¹² farads	piv	= peak inverse voltage	p/o	= part of	porc	= porcelain	pos	= position(s)	pot	= potentiometer	pk-pk	= peak-to-peak	rect	= rectifier	rf	= radio frequency	s-b	= slow-blow	Se	= selenium	sect	= section(s)	semicon	= semiconductor	Si	= silicon	sil	= silver	sl	= slide	spl	= special	Ta	= tantalum	td	= time delay	tgl	= toggle	Ti	= titanium	tol	= tolerance	trim	= trimmer	u	= micro (10 ⁻⁶)	var	= variable	w	= watts	w/o	= with	w/o	= without	wvdc	= dc working volts	ww	= wirewound
A	= assembly																																																																																																																																																																																																																																						
B	= motor																																																																																																																																																																																																																																						
C	= capacitor																																																																																																																																																																																																																																						
CP	= coupling																																																																																																																																																																																																																																						
CR	= diode																																																																																																																																																																																																																																						
DL	= delay line																																																																																																																																																																																																																																						
DS	= device signaling (lamp)																																																																																																																																																																																																																																						
E	= misc. electronic part																																																																																																																																																																																																																																						
F	= fuse																																																																																																																																																																																																																																						
FL	= filter																																																																																																																																																																																																																																						
H	= hardware																																																																																																																																																																																																																																						
IC	= integrated circuit																																																																																																																																																																																																																																						
J	= jack																																																																																																																																																																																																																																						
K	= relay																																																																																																																																																																																																																																						
L	= inductor																																																																																																																																																																																																																																						
LS	= speaker																																																																																																																																																																																																																																						
M	= meter																																																																																																																																																																																																																																						
MP	= mechanical part																																																																																																																																																																																																																																						
P	= plug																																																																																																																																																																																																																																						
Q	= transistor																																																																																																																																																																																																																																						
R	= resistor																																																																																																																																																																																																																																						
RT	= thermistor																																																																																																																																																																																																																																						
S	= switch																																																																																																																																																																																																																																						
T	= transformer																																																																																																																																																																																																																																						
TB	= terminal board																																																																																																																																																																																																																																						
TP	= test point																																																																																																																																																																																																																																						
V	= vacuum tube, neon bulb, photocell, etc.																																																																																																																																																																																																																																						
VR	= voltage regulator (diode)																																																																																																																																																																																																																																						
W	= cable																																																																																																																																																																																																																																						
X	= socket																																																																																																																																																																																																																																						
Y	= crystal																																																																																																																																																																																																																																						
amp	= amperes																																																																																																																																																																																																																																						
ampl	= amplifier																																																																																																																																																																																																																																						
bp	= bandpass																																																																																																																																																																																																																																						
car	= carbon																																																																																																																																																																																																																																						
ccw	= counterclockwise																																																																																																																																																																																																																																						
cer	= ceramic																																																																																																																																																																																																																																						
coef	= coefficient																																																																																																																																																																																																																																						
com	= common																																																																																																																																																																																																																																						
comp	= composition																																																																																																																																																																																																																																						
conn	= connector																																																																																																																																																																																																																																						
crt	= cathode-ray tube																																																																																																																																																																																																																																						
cw	= clockwise																																																																																																																																																																																																																																						
depc	= deposited carbon																																																																																																																																																																																																																																						
elect	= electrolytic																																																																																																																																																																																																																																						
encap	= encapsulated																																																																																																																																																																																																																																						
ext	= external																																																																																																																																																																																																																																						
f	= farads																																																																																																																																																																																																																																						
fet	= field effect transistor																																																																																																																																																																																																																																						
fxd	= fixed																																																																																																																																																																																																																																						
Ge	= germanium																																																																																																																																																																																																																																						
gl	= glass																																																																																																																																																																																																																																						
grd	= ground(ed)																																																																																																																																																																																																																																						
h	= henries																																																																																																																																																																																																																																						
Hg	= mercury																																																																																																																																																																																																																																						
hr	= hour(s)																																																																																																																																																																																																																																						
HP	= Hewlett-Packard																																																																																																																																																																																																																																						
if.	= intermediate freq.																																																																																																																																																																																																																																						
impgr	= impregnated																																																																																																																																																																																																																																						
incd	= incandescent																																																																																																																																																																																																																																						
incl	= include(s)																																																																																																																																																																																																																																						
ins	= insulation(ed)																																																																																																																																																																																																																																						
int	= internal																																																																																																																																																																																																																																						
k	= kilo (10 ³)																																																																																																																																																																																																																																						
lin	= linear taper																																																																																																																																																																																																																																						
log	= logarithmic taper																																																																																																																																																																																																																																						
lpf	= low pass filter																																																																																																																																																																																																																																						
m	= milli (10 ⁻³)																																																																																																																																																																																																																																						
meg	= mega (10 ⁶)																																																																																																																																																																																																																																						
metflm	= metal film																																																																																																																																																																																																																																						
met ox	= metal oxide																																																																																																																																																																																																																																						
mfr	= manufacturer																																																																																																																																																																																																																																						
minat	= miniature																																																																																																																																																																																																																																						
mom	= momentary																																																																																																																																																																																																																																						
mtg	= mounting																																																																																																																																																																																																																																						
my	= mylar																																																																																																																																																																																																																																						
n	= nano (10 ⁻⁹)																																																																																																																																																																																																																																						
n/c	= normally closed																																																																																																																																																																																																																																						
ne	= neon																																																																																																																																																																																																																																						
n/o	= normally open																																																																																																																																																																																																																																						
npo	= negative positive zero (zero temperature coefficient)																																																																																																																																																																																																																																						
nsr	= not separately replaceable																																																																																																																																																																																																																																						
obd	= order by description																																																																																																																																																																																																																																						
ox	= oxide																																																																																																																																																																																																																																						
pc	= printed circuit																																																																																																																																																																																																																																						
pF	= picofarads = 10 ⁻¹² farads																																																																																																																																																																																																																																						
piv	= peak inverse voltage																																																																																																																																																																																																																																						
p/o	= part of																																																																																																																																																																																																																																						
porc	= porcelain																																																																																																																																																																																																																																						
pos	= position(s)																																																																																																																																																																																																																																						
pot	= potentiometer																																																																																																																																																																																																																																						
pk-pk	= peak-to-peak																																																																																																																																																																																																																																						
rect	= rectifier																																																																																																																																																																																																																																						
rf	= radio frequency																																																																																																																																																																																																																																						
s-b	= slow-blow																																																																																																																																																																																																																																						
Se	= selenium																																																																																																																																																																																																																																						
sect	= section(s)																																																																																																																																																																																																																																						
semicon	= semiconductor																																																																																																																																																																																																																																						
Si	= silicon																																																																																																																																																																																																																																						
sil	= silver																																																																																																																																																																																																																																						
sl	= slide																																																																																																																																																																																																																																						
spl	= special																																																																																																																																																																																																																																						
Ta	= tantalum																																																																																																																																																																																																																																						
td	= time delay																																																																																																																																																																																																																																						
tgl	= toggle																																																																																																																																																																																																																																						
Ti	= titanium																																																																																																																																																																																																																																						
tol	= tolerance																																																																																																																																																																																																																																						
trim	= trimmer																																																																																																																																																																																																																																						
u	= micro (10 ⁻⁶)																																																																																																																																																																																																																																						
var	= variable																																																																																																																																																																																																																																						
w	= watts																																																																																																																																																																																																																																						
w/o	= with																																																																																																																																																																																																																																						
w/o	= without																																																																																																																																																																																																																																						
wvdc	= dc working volts																																																																																																																																																																																																																																						
ww	= wirewound																																																																																																																																																																																																																																						

Table 6-2. Replaceable Parts

Ref Desig	HP Part No.	TQ	Description (See Table 6-1.)
A1	01123-66504	1	A: Probe
<p>Note</p> <p>The Probe Board Assembly is not a field repairable item. If trouble is evident, the entire probe assembly (A1) should be returned to HP for repair or replacement.</p>			
A2	01123-66502	1	A: Probe Amplifier
C1	0180-0230	3	C: fxd ta 1 μ f 50V
C2	0160-0127	1	C: fxd cer 1 μ f 25V 20%
C3	0121-0060	2	C: var cer 2-8 pF
C4	0121-0060		C: var cer 2-8 pF
C5	0121-0114	1	C: var cer 7-25 pF
C6	0160-0161	1	C: fxd mylar .01 μ f 200V 10%
C7	0160-0154	1	C: fxd mylar .0022 μ f 200V 10%
C8	0150-0121	2	C: fxd cer .1 μ f 50V 30%
C9	0160-3285	1	C: fxd cer 1.5 pF 500V 1%
C10	0150-0121		C: fxd cer .1 μ f 50V 30%
C11	0180-0116	1	C: fxd ta 6.8 μ f 35V 10%
C12	0150-0093	2	C: fxd cer .01 μ f 100V +80 -20%
C13	0160-2246	1	C: fxd cer 3.6 pF 500V 1%
C14	0160-2249	1	C: fxd cer 4.7 pF 500V 1%
C15	0180-0230		C: fxd ta 1 μ f 50V 20%
C16	0180-0230		C: fxd ta 1 μ f 50V 20%
C17	0150-0093		C: fxd cer .01 μ f 100V +80 -20%
CR1	1901-0049	1	CR: si
CR2 thru CR5	1901-0040	4	CR: si
L1	9100-2598	1	L: fxd .075 μ h
L2	9140-0146	1	L: fxd 10 μ h 10%
L3	9100-2276	1	L: fxd 100 μ h 10%
L4	9100-2258	3	L: fxd 1.2 μ h 10%
L5	9100-2258		L: fxd 1.2 μ h 10%
L6	9100-2258		L: fxd 1.2 μ h 10%
Q1	1853-0061	1	Q: si PNP
Q2	1853-0036	1	Q: si PNP
Q3	1854-0071	3	Q: si NPN
Q4	1854-0372	1	Q: si NPN S22277
Q5	1853-0020	3	Q: si PNP
Q6	1853-0020		Q: si PNP
Q7	1853-0020		Q: si PNP
Q8	1854-0374	2	Q: si NPN Dual
Q9	1854-0071		Q: si NPN
Q10	1854-0071		Q: si NPN
Q11	1854-0374		Q: si NPN Dual
R1	0757-0401	1	R: fxd metflm 100 ohms 1% 1/8w
R2	0757-0924	2	R: fxd metox 1k ohm 2% 1/4w
R3	0757-0924		R: fxd metox 1k ohm 2% 1/4w
R4	0757-0900	1	R: fxd metox 100 ohms 2% 1/4w
R5	2100-2060	1	R: var cer metflm 50 ohms 30% 1/2w

Table 6-2. Replaceable Parts (Cont'd)

Ref Desig	HP Part No.	TQ	Description (See Table 6-1.)
A2 (Cont'd.)			
R6	0757-0397	1	R: fxd metflm 68.1 ohms 1% 1/8w
R7	2100-1788	3	R: var cer metflm 500 ohms 30% 1/2w
R8	2100-2030	2	R: var cer metflm 20k ohms 30% 1/2w
R9	0757-0911	1	R: fxd metox 300 ohms 2% 1/4w
R10	2100-2030		R: var cer metflm 20k ohms 30% 1/2w
R11	0757-0282	1	R: fxd metflm 221 ohms 1% 1/8w
R12	0757-0936	1	R: fxd metox 3.3k ohms 2% 1/4w
R13	0757-0968	1	R: fxd metox 68k ohms 2% 1/4w
R14	0757-0405	1	R: fxd metflm 162 ohms 1% 1/8w
R15	0757-0928	1	R: fxd metflm 1.5k ohm 1% 1/4w
R16	0757-0296	1	R: fxd metox 200 ohms 2% 1/2w
R17	0757-0075	1	R: fxd metox 470 ohms 2% 1/2w
R18			Deleted
R19	0757-0957	1	R: fxd metox 24k ohms 2% 1/4w
R20	0757-0912	1	R: fxd metox 330 ohms 2% 1/4w
R21	0757-0929	1	R: fxd metox 1.6k ohm 2% 1/4w
R22	0757-0958	2	R: fxd metox 27k ohms 2% 1/4w
R23	0757-0972	2	R: fxd metox 100k ohms 2% 1/4w
R24	0757-0955	1	R: fxd metox 20k ohms 2% 1/4w
R25	0757-0972		R: fxd metox 100k ohms 2% 1/4w
R26	0757-0967	2	R: fxd metox 62k ohms 2% 1/4w
R27	0757-0975	1	R: fxd metox 130k ohms 2% 1/4w
R28	0757-0458	2	R: fxd metflm 51.1k ohms 1% 1/8w
R29	0757-0459	2	R: fxd metflm 56.2k ohms 1% 1/8w
R30	0757-0967		R: fxd metox 62k ohms 2% 1/4w
R31	0757-0958		R: fxd metox 27k ohms 2% 1/4w
R32	2100-1788		R: var cer metflm 500 ohms 30% 1/2w
R33	0757-0920	2	R: fxd metox 680 ohms 2% 1/4w
R34	0757-0920		R: fxd metox 680 ohms 2% 1/4w
R35	0698-6994	1	R: fxd metox 30 ohms 2%-1/4w
R36	0698-7077	1	R: fxd metox 15 ohms 2% 1/4w
R37	0757-0941	1	R: fxd metox 5.1k ohms 2% 1/4w
R38	2100-2610	1	R: var cer metflm 5k ohms 10% 1/2w
R39	0757-0458		R: fxd metflm 51.1k ohms 1% 1/8w
R40	0757-0943	1	R: fxd metox 6.2k ohms 2% 1/4w
R41	0757-0976	1	R: fxd metox 150k ohms 2% 1/4w
R42	0757-0459		R: fxd metflm 56.2k ohms 1% 1/8w
R43	2100-2031	1	R: var cer metflm 50k ohms 30% 1/2w
R44	0757-0470	1	R: fxd metflm 162k ohms 1% 1/8w
R45	0757-0393	1	R: fxd metflm 47.5k ohms 1% 1/8w
R46	0757-0398	1	R: fxd metflm 75 ohms 1% 1/8w
R47	0757-0408	1	R: fxd metflm 243 ohms 1% 1/8w
R48	2100-1788		R: var cer metflm 500 ohms 30% 1/2w
VR1	1902-0799	1	VR: 7.5V zener 5% 1w
VR2	1902-3203	1	VR: 14.7V zener 5% 400 mw
W1	01123-61301		W: 2 inch ground lead
W2	01123-61302		W: 2 1/2 inch ground lead
W3	01123-61601		W: 4 1/2 foot coax
W4	01123-61603		W: 9 inch 3 conductor

Table 6-2. Replaceable Parts (Cont'd)

Ref Desig	HP Part No.	TQ	Description (See Table 6-1.)
MISCELLANEOUS			
	1205-0010	1	Heat sink
	01123-04101	1	Cover
	1251-2229	5	Socket
	01123-26101	5	Pin
	01123-63201	1	Connector Assy - output
	1251-2088	1	Plug-Power

SECTION VII MANUAL CHANGES AND OPTIONS

7-1. MANUAL CHANGES.

7-2. This manual applies directly to standard Model 1123A Voltage Probe having a serial number prefixed by 842- (refer to Paragraph 1-9). The following paragraphs provide instructions for modifying this manual to cover older (lower serial prefix) or newer (higher serial prefix) instruments. Refer to the separate "Manual Changes" sheet supplied with this manual for Errata.

7-3. OLDER INSTRUMENTS.

7-4. Table 7-1 contains information on changes required to adapt this manual to an older instrument (lower serial prefix). Check Table 7-1 for your instrument serial prefix, and make the changes indicated. Note that these changes adapt the manual to cover a particular instrument as manufactured; and therefore will not apply to an instrument subsequently modified in the field.

7-5. NEWER INSTRUMENTS.

7-6. As changes are made to the Model 1123A Voltage Probe, newer instruments may have serial prefixes higher than 842-. The manual for these instruments

will be supplied with a "Manual Changes" sheet which contains the required updating information. If the change sheet is missing, contact the nearest HP Sales/Service Office.

7-7. OPTIONS.

7-8. Options for an HP instrument are standard modifications to the standard instrument, and are installed at the factory. At the presnet time, no options are offered for the Model 1123A Voltage Probe.

7-9. SPECIAL INSTRUMENTS.

7-10. Modified versions (per customer specifications) of any HP instrument are available on special order. The manual for these special instruments (having electrical modifications), includes a separate insert sheet, which describes the modifications and any changes required in addition to any "Manual Changes" sheet (refer to Paragraph 7-6). Contact the nearest HP Sales/Service Office if either of these sheets are missing from the manual for a special instrument, being sure to refer to the instrument by its full specification number and name.

Table 7-1. Manual Changes















Instrument Serial Prefix Number	Incorporate Change(s) Numbered
827-	1

CHANGE 1

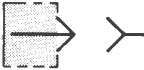
Table 6-2, Page 6-2,
A1: Change to HP Part No. 01123-66501.
Page 8-5, Figure 8-5,
A1R14: Delete.
A1C9: Delete.

Table 8-1. Schematic Symbols and Conventions

Refer to MIL-STD-15-1A for schematic symbols not listed in this table.

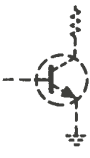
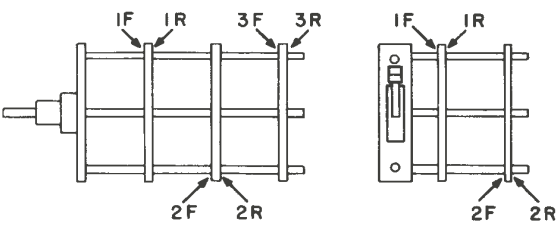
 = Etched circuit board  = Front panel marking  = Rear panel marking  = Front panel control  = Screwdriver adjustment <p>P/O = Part of</p> <p>CW = Clockwise end of variable resistor</p> <p>N.C. = No connection</p>  = Waveform test point (with number)  = Common electrical point (with letter) not necessarily ground  = Single pin connector  = Pin of a plug-in board (with letter or number)  = Primary signal flow  = Secondary signal flow <p>* = Optimum value selected at factory, average value shown; part may have been omitted.</p>	 = Field effect transistor (N-channel)  = Breakdown diode  = Tunnel diode  = Step recovery diode  = Circuits or components drawn with dashed lines (phantom) show function only and are not intended to be complete. The circuit or component is shown in detail on another schematic. <p>Unless otherwise indicated: resistance in ohms capacitance in picofarads inductance in microhenries</p> <p>Wire colors are given by numbers in parentheses using the resistor color code [(925) is wht-red-grn].</p> <table border="0"> <tr> <td>0 - Black</td> <td>5 - Green</td> </tr> <tr> <td>1 - Brown</td> <td>6 - Blue</td> </tr> <tr> <td>2 - Red</td> <td>7 - Violet</td> </tr> <tr> <td>3 - Orange</td> <td>8 - Gray</td> </tr> <tr> <td>4 - Yellow</td> <td>9 - White</td> </tr> </table> <p>Switch wafers are identified as follows:</p> 	0 - Black	5 - Green	1 - Brown	6 - Blue	2 - Red	7 - Violet	3 - Orange	8 - Gray	4 - Yellow	9 - White
0 - Black	5 - Green										
1 - Brown	6 - Blue										
2 - Red	7 - Violet										
3 - Orange	8 - Gray										
4 - Yellow	9 - White										

SECTION VIII

SCHEMATICS AND TROUBLESHOOTING

8-1. INTRODUCTION.

8-2. This section contains Model 1123A diagrams, component location pictorials, troubleshooting information and repair and replacement procedures.

8-3. SCHEMATIC DIAGRAMS.

8-4. Schematic diagrams appear on right hand pages that unfold outside the right edge of the manual. These "throw clear" pages allow viewing the schematics while referring to another section. Text can be followed by unfolding the appropriate "throw clear" page.

8-5. Schematics are drawn primarily to show the electronic function of an instrument. A given schematic may include all or part of several assemblies. Schematics also include dc voltages and waveform measurement test points. Waveforms applicable to each schematic are shown opposite that schematic. DC voltage and waveform measurement conditions are shown in Table 8-2. Information about symbols and conventions used in these schematics is provided by Table 8-1.

8-6. COMPONENT IDENTIFICATION.

8-7. Chassis mounted parts, not on an assembly, are shown on a fold out page. Assembly mounted components are shown on page opposite the schematic. When an assembly appears on more than one schematic, all components are identified opposite the schematic on which the assembly first appears.

8-8. REFERENCE DESIGNATION.

8-9. The unit system of reference designation, used in this manual, is in accordance with the provisions of the American Standard Electrical and Electronics Reference Designations. Minor variations, due to de-

sign and manufacturing, may be noted. A brief explanation is presented here for those unfamiliar with the designation system.

8-10. Each component is identified by a letter-number combination. For example R1, R2; ---C1, C2; etc. This letter-number combination is the basic designation for each component. Components which are separately replaceable and are part of an assembly have, in addition to the basic designator, a prefix designation which identifies the assembly on which the component is located. Components not mounted on an assembly have only the basic reference designation.

8-11. Figure 8-1 is used as an example. The basic reference designation appears three times, however each R1 is identified by a designation formed by combining component, assembly and sub-assembly designators. Consider the R1 on sub-assembly A1. The complete designation of that resistor is A2A1R1. Now, R1 connected between assembly A1 and the complete instrument has only the designation R1 because it is not mounted on an assembly. This system applies to all classes of components; C, CR, Q, etc.

8-12. Assemblies are numbered from 1, consecutively. If an assembly number is assigned and later deleted, this number is not reused.

8-13. TROUBLESHOOTING.

8-14. The first and most important requirement for successful troubleshooting is a thorough understanding of how the instrument is designed to operate. Section III (Operation) and Section IV (Theory of Operation) of this manual are intended to provide the operator with the necessary understanding to troubleshoot this instrument. Many times suspected malfunctions are

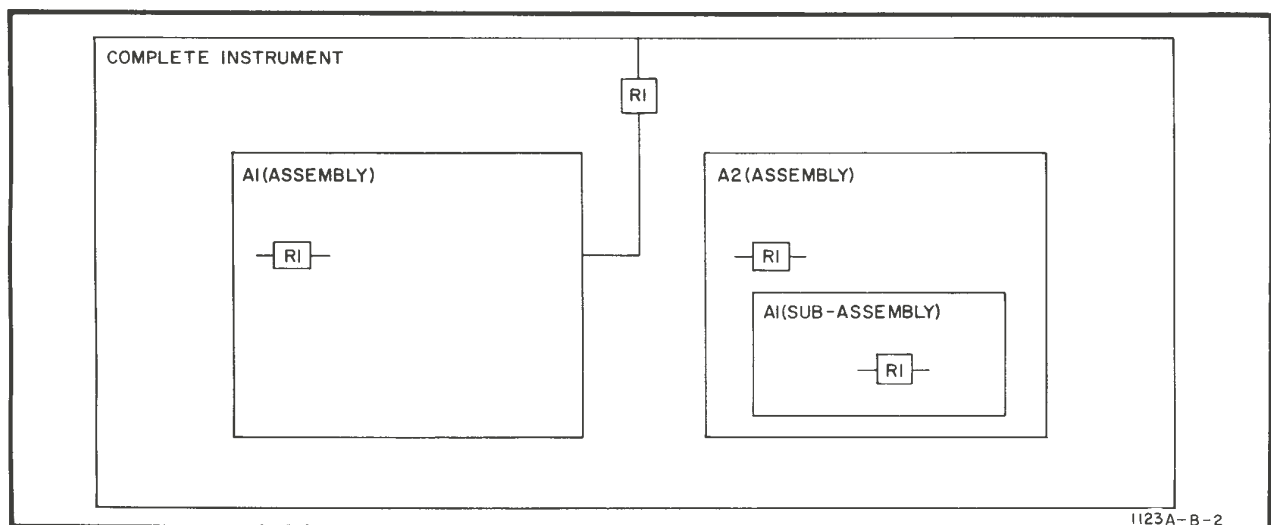

Figure 8-1. Unit System Reference Designation.

caused by improper control settings or system hook-up. Therefore, it is recommended that the operator become as familiar as possible with the operation of the Model 1123A before troubleshooting.

8-15. To locate a trouble, start with a thorough visual inspection of front panel control settings and hook-up. Look for burned or loose components, mis-wiring or any condition which suggests a trouble. Square pin wiring is shown on each component pictorial. Refer to these callouts, after a board has been replaced, to assure proper connections. Correct any faults located in instrument performance before continuing to troubleshoot.

Note

Test point jacks shown on schematics are used in various checks and adjustments and do not correspond to waveform test points.

8-16. The first electrical check should be to insure that proper voltages are coming on to the printed circuit boards. Check the Low Voltage Power Supply (LVPS) to insure all voltages are correct. Use the overall block diagram (Section IV), the schematic diagrams, and the waveform photos adjacent to each schematic. This procedure will isolate the trouble to a particular circuit. When trouble appears probable in a circuit, check the dc voltages given on the schematics.

8-17. WAVEFORMS.

8-18. Typical waveform measurement points (refer to Table 8-1) are located at strategic points along the main signal path. The numbers inside the symbol refer to a corresponding waveform photo. Conditions for making the waveform measurements are given in Table 8-2.

8-19. DC VOLTAGES.

8-20. DC voltage levels are shown on schematic diagrams for all active components (transistors, mainly). Conditions for making dc voltage measurements are given in Table 8-2. In locating points on printed circuit boards, note a small dot on the board identifies the emitter lead of transistors, the source lead of a field effect transistor (FET), the cathode lead of diodes, and the positive side of electrolytic capacitors. On dual transistors only, the tab denotes the collector leads.

8-21. REPAIR AND REPLACEMENT.

8-22. The following paragraphs provide procedures for replacing components and special considerations for removing components from printed circuit boards. Section VI provides a detailed parts list to permit ordering of replacement parts. If satisfactory repair or replacement cannot be accomplished, notify the

nearest HP Sales/Service Office (addresses at rear of this manual) immediately. If shipment for repair is recommended, see Section II of this manual for repacking and shipping information.

8-23. SERVICING PRINTED CIRCUIT BOARDS.

8-24. Printed circuit boards in this instrument have components mounted on one side, conductive surfaces on both sides, and plated through component mounting holes. Hewlett-Packard Service Note M-20E contains useful information on servicing and repair of printed circuit boards. Some important considerations are as follows:

a. Use a 37 to 47.5 watt chisel tip soldering iron with a tip diameter of 1/16 to 1/8 inch, and a small diameter rosin core solder.

b. Components may be removed by placing the soldering iron to component leads on either side of the board. If heat is applied to the component side of the board, greater care is required so as not to damage components. Extreme care is required to avoid damage to semiconductor devices. Damage may be minimized by gripping component lead between soldering iron and the component using a pair of long nose pliers.

c. If a component is obviously damaged or faulty, clip the leads close to the component, then unsolder the leads from the board.

d. Large components, such as potentiometers, may be removed by rotating the iron from one lead to another while gently applying pressure to lift the component from the board.

e. Excessive heat or force will destroy the laminate bond between the metal plated surface and the board. If this should occur, the lifted conductor may be cemented down with a small amount of quick drying acetate base cement having good insulating properties. If this repair cannot be accomplished, a section of good conducting wire may be soldered along the damaged area.

f. Before replacing a component, heat the remaining solder in the component hole and clean it out with a toothpick or similar object. Sharp pointed metallic tools are not recommended because they may damage the plated through surface of the hole.

g. Tin and shape leads of replacement component to fit existing holes.

h. Install components in the same position as the original component (refer to Paragraph 8-20).

j. When removing or replacing square pin connections, be sure to pull straight up for removal and replacement. These connections can loosen and cause poor contact.

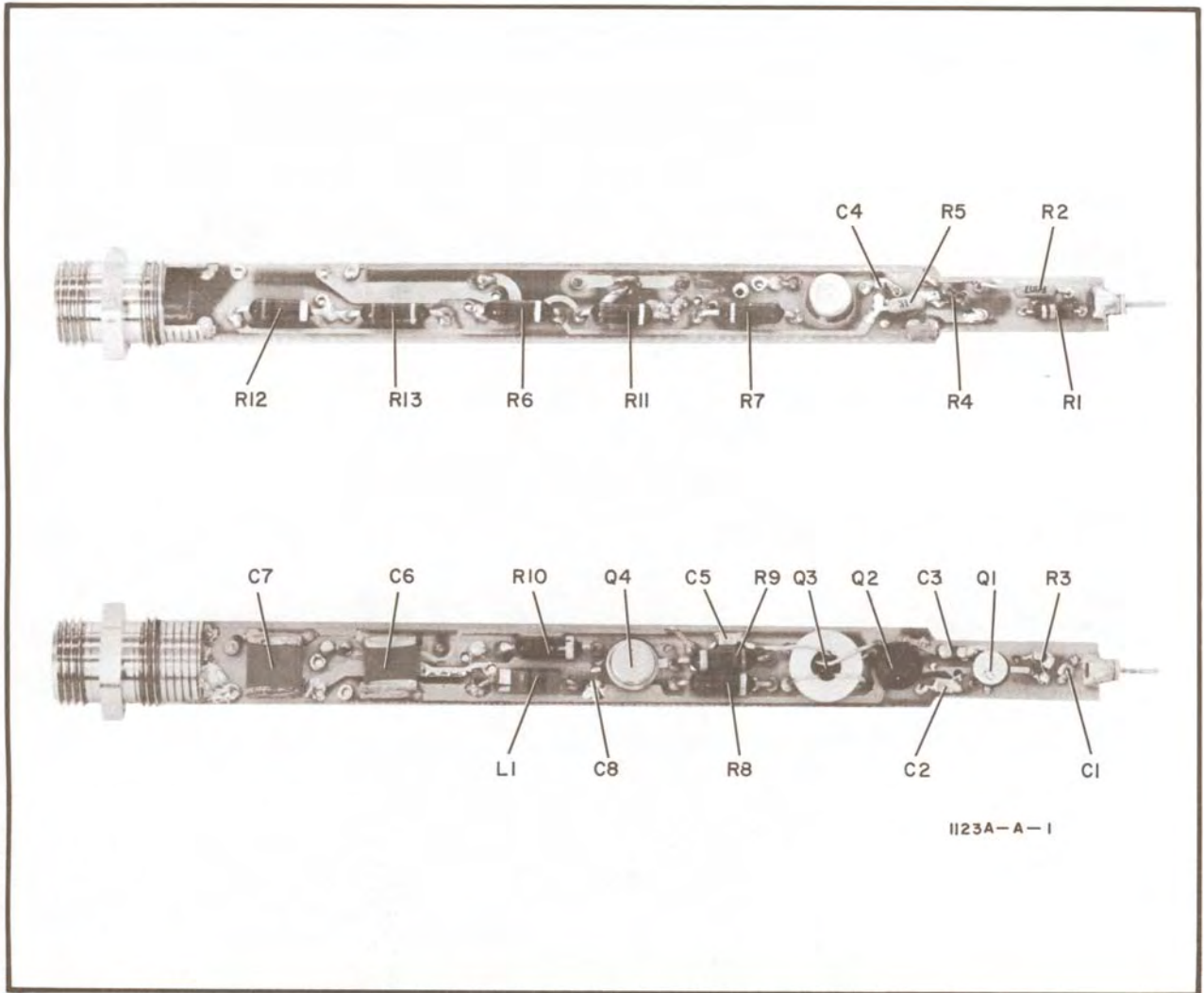

Figure 8-2. Component Identification, Assy A1

Table 8-2. Waveform and DC Voltage Measurement Conditions

WAVEFORMS		Model 140-Series Sampling System:																				
<p>The test point waveform, as given in figures preceding the schematic diagram, were taken under the following conditions:</p> <p>MODEL 180A/AR (TEST OSCILLOSCOPE)</p> <table border="0"> <tr> <td>DISPLAY</td> <td>INT</td> </tr> <tr> <td>MAGNIFIER</td> <td>X1</td> </tr> <tr> <td>HORIZONTAL PLUG-IN</td> <td></td> </tr> <tr> <td>TRIGGERING</td> <td>INT</td> </tr> <tr> <td>SLOPE</td> <td>+</td> </tr> <tr> <td>SWEEP MODE</td> <td>AUTO</td> </tr> <tr> <td>VERTICAL PLUG-IN</td> <td></td> </tr> <tr> <td>Polarity</td> <td>+UP</td> </tr> <tr> <td>DISPLAY</td> <td>A</td> </tr> <tr> <td>INPUT</td> <td>AC</td> </tr> </table>		DISPLAY	INT	MAGNIFIER	X1	HORIZONTAL PLUG-IN		TRIGGERING	INT	SLOPE	+	SWEEP MODE	AUTO	VERTICAL PLUG-IN		Polarity	+UP	DISPLAY	A	INPUT	AC	<p>For waveforms ∇_{2B} and ∇_{3C}, use test set-up and connections given in Paragraph 5-19.</p> <p>Any exceptions to these conditions are noted adjacent to the applicable waveform photo.</p>
DISPLAY	INT																					
MAGNIFIER	X1																					
HORIZONTAL PLUG-IN																						
TRIGGERING	INT																					
SLOPE	+																					
SWEEP MODE	AUTO																					
VERTICAL PLUG-IN																						
Polarity	+UP																					
DISPLAY	A																					
INPUT	AC																					
		DC VOLTAGES																				
		<p>The DC Voltage readings, as given on the schematic diagram, were taken with the Model 1123A disconnected from Oscilloscope with power applied.</p> <p>All voltages are measured with reference to chassis ground.</p> <p>Voltage readings are considered normal if within $\pm 10\%$ of voltage given on schematic.</p>																				

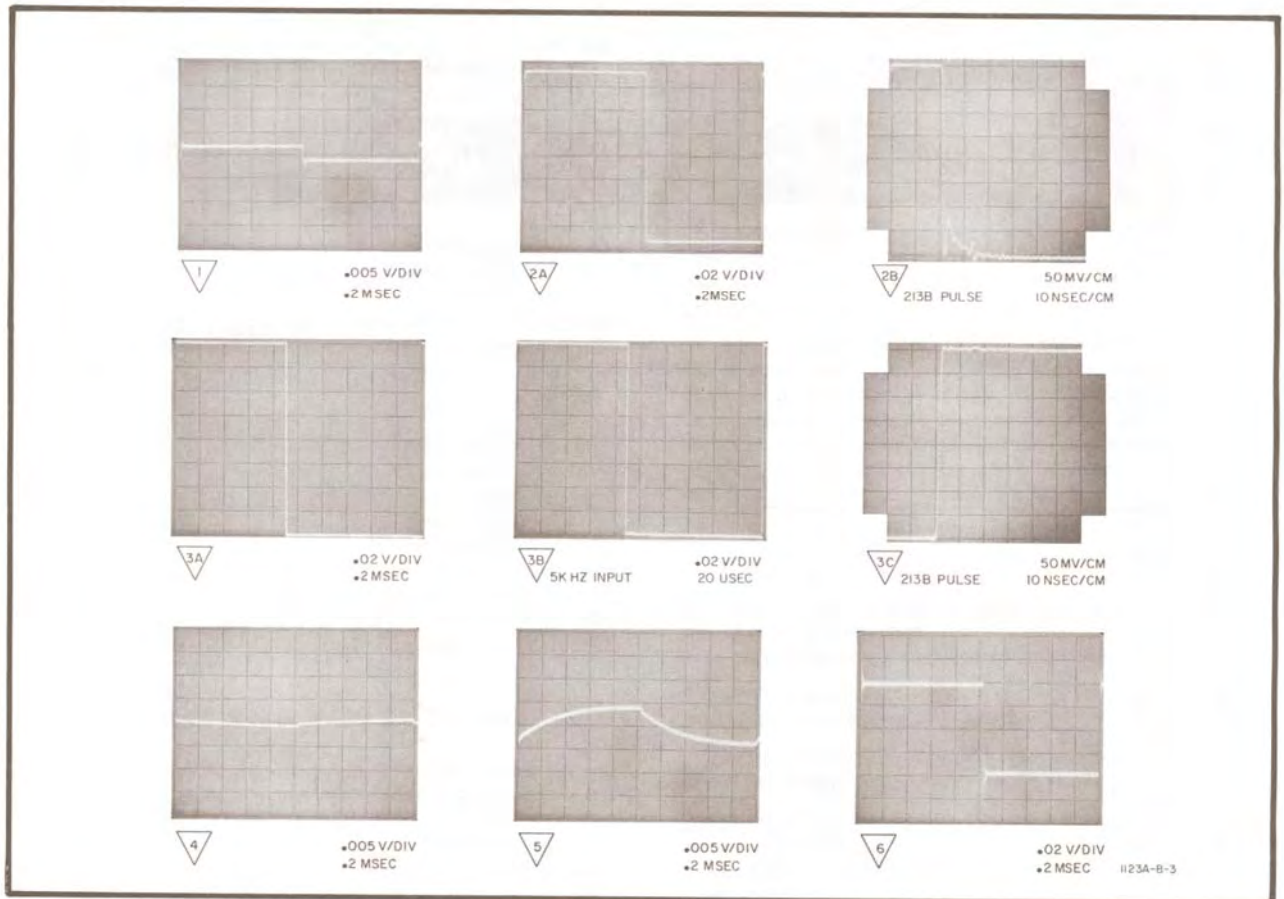

Figure 8-3. Waveforms at Test Points

	A	B	C	D	E	F	
1							1
2							2
3							3
4							4
5							5
6							6



REF DESIG	GRID LOC	REF DESIG	GRID LOC	REF DESIG	GRID LOC	REF DESIG	GRID LOC	REF DESIG	GRID LOC	REF DESIG	GRID LOC	REF DESIG	GRID LOC	REF DESIG	GRID LOC
C1	C-2	C12	C-4	L1	D-2	Q6	B-4	R6	C-3	R17	B-2	R29	E-3	R40	E-3
C2	D-2	C13	B-3	L2	C-4	Q7	B-4	R7	D-2	R19	E-4	R30	D-3	R41	E-3
C3	D-3	C14	B-3	L3	C-3	Q8	B-3	R8	C-3	R20	E-4	R31	E-2	R42	E-3
C4	C-3	C15	B-4	L4	B-4	Q9	D-4	R9	D-4	R21	E-4	R32	E-2	R43	B-3
C5	C-3	C16	B-2	L5	B-2	Q10	D-3	R10	C-3	R22	B-4	R33	E-2	R44	C-3
C6	C-3	C17	C-2	L6	B-3	Q11	D-3	R11	B-3	R23	B-4	R34	E-2	R45	B-2
C7	C-3	CR1	D-4	Q1	C-2	R1	C-2	R12	D-4	R24	B-3	R35	E-2	R46	B-3
C8	C-4	CR2	E-4	Q2	D-2	R2	E-2	R13	C-4	R25	B-4	R36	E-2	R47	C-3
C9	B-3	CR3	D-4	Q3	E-2	R3	D-2	R14	C-4	R26	B-3	R37	E-4	R48	D-3
C10	D-4	CR4	E-4	Q4	C-2	R4	D-2	R15	C-3	R27	D-4	R38	E-3	VR1	D-4
C11	D-4	CR5	E-2	Q5	D-4	R5	D-3	R16	B-3	R28	D-3	R39	D-3	VR2	E-3

1123A-A-17

Figure 8-4. Component Identification, Assy A2

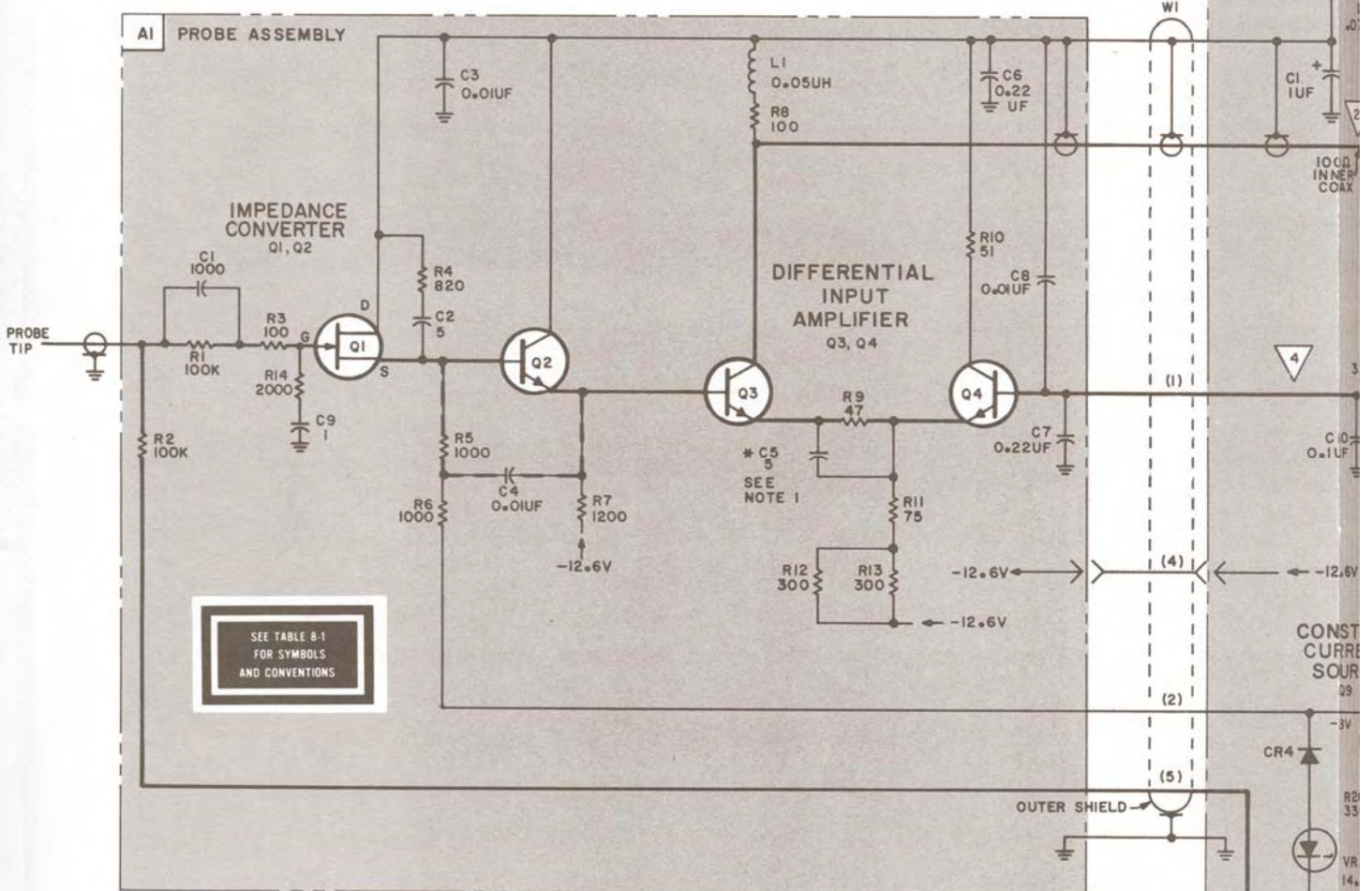

SEE TABLE 8-1
FOR SYMBOLS
AND CONVENTIONS

NOTE 1. * DENOTES FACTORY SELECTED ITEM,
MAY BE OMITTED.

NOTE 2. * MAY VARY FROM -0.6V TO +1.4V.

Reference designations within assemblies
are abbreviated. Add assembly designation
as prefix to form complete designation
(e.g. R1 on assembly A2 is A2R1).

COPYRIGHT 1968 BY HEWLETT-PACKARD CO.
1123A - PROBE - 827

REFERENCE DESIGNATIONS

A1	A2
C1-9	C1-17
L1	CR1-5
Q1-4	L1-6
R1-14	Q1-11
	R1-48
	VR1, 2
CHASSIS	
PI, 2	
WI-3	

DELETED: R18



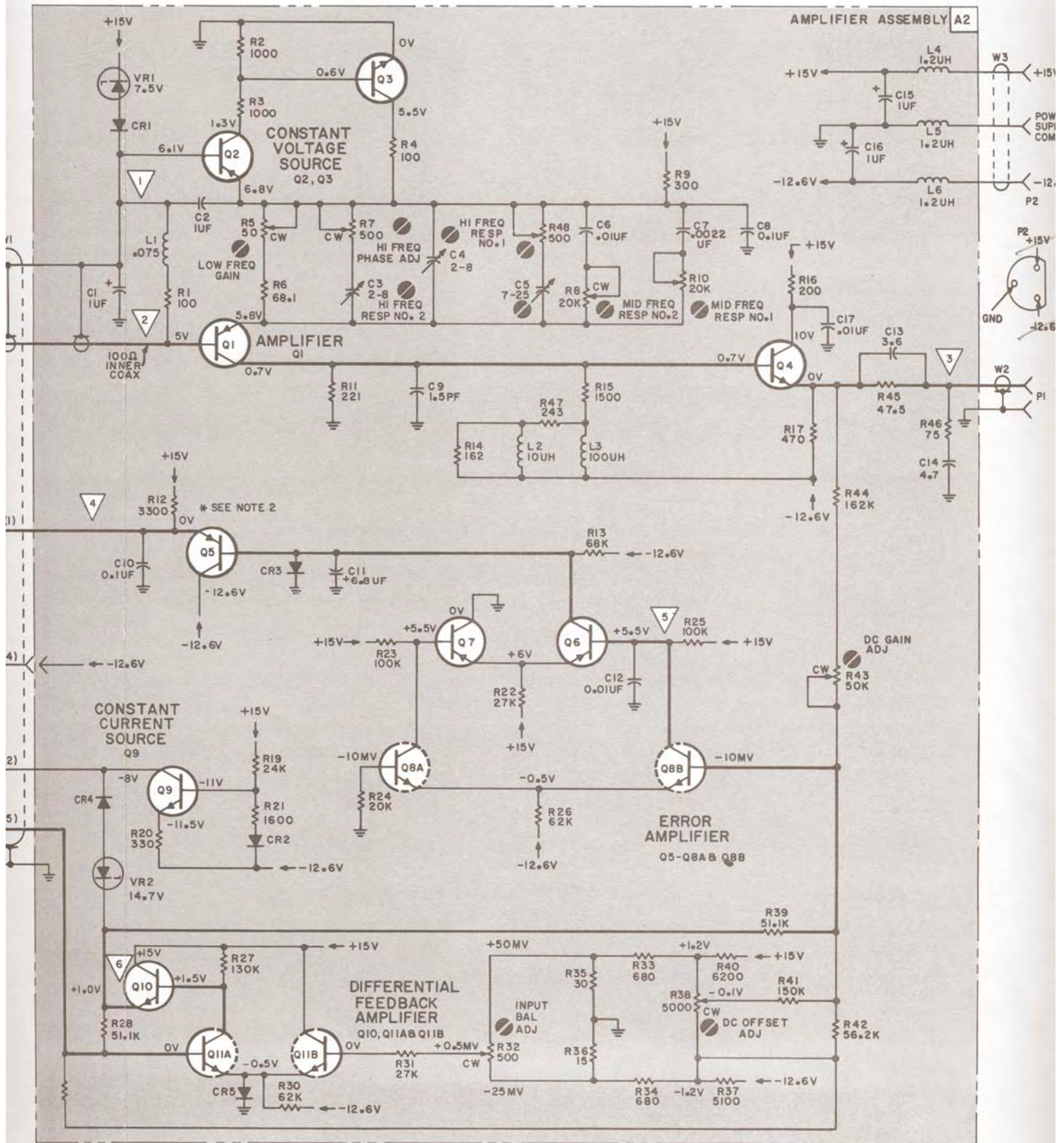

Figure 8-5. Model 1123A Schematic Diagram
 8-5/8-6

APPENDIX I

ACCESSORIES

MODEL 10214A 10:1 DIVIDER

1. DESCRIPTION.

2. The HP Model 10214A 10:1 Divider is a signal probing accessory for the HP Model 1425A/1410A oscilloscope sampling system. The Model 10214A is illustrated in Figure 1. The divider offers essentially a constant impedance to the probe regardless of the impedance to which the divider is connected. Since the divider maintains a constant output impedance, it can be used in point-to-point circuit probing without experiencing a base-line shift or requiring response adjustments on the oscilloscope. Specifications for the Model 10214A are listed in Table 1.

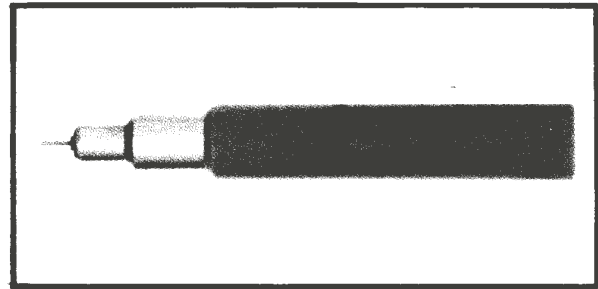

Figure 1. Model 10214A 10:1 Divider

3. CONNECTIONS.

4. The Model 10214A is connected to the probe of the sampling system by sliding the probe into the body portion of the divider.

5. USE WITH OTHER ACCESSORIES.

6. If the circuit to be probed contains dc potentials, the HP Model 10217A Blocking Capacitor must be used in conjunction with the Model 10214A.

Table 1. Specifications

ATTENUATION: 10:1 $\pm 5\%$ over bandpass of the sampling system.
INPUT IMPEDANCE: 1 megohm shunted by 2.5 pF.
EFFECT ON RISE TIME OF SYSTEM: Negligible.
MAXIMUM INPUT VOLTAGE: 350V dc, 20V pk-to-pk ac.

7. CIRCUITS.

8. The schematic of the Model 10214A is shown in Figure 2. The major components of the divider are resistor R1 and a metal sleeve which is spring loaded to hold R1 in place. The capacitance of C1 is the capacitance between R1 and the metal sleeve; C2 is the capacitance between the metal sleeve and the divider body. The capacitance of C1 determines the high-frequency division ratio of the divider. At low frequencies, the division ratio is accomplished between R1 and the 100k-ohm resistance of the sampling system probe. Resistor R2 and inductor L1 critically damp resonance at the divider input and output. Capacitor C3 represents the stray capacitance present within the assembly.

9. MAINTENANCE.

10. The only maintenance recommended for the Model 10214A is to run a performance check if a malfunction is suspected, and to adjust the capacity of C1.

11. PERFORMANCE CHECK.

12. Perform the following checkout procedure as an acceptance check or if a malfunction in the divider is suspected. Test equipment required for the performance check is listed in Table 2.

a. Set Pulse Generator controls as follows:

REP RATE	100-1M
VERNIER	Set to 500 kHz output
PULSE DELAY and VERNIER	as required
PULSE WIDTH5-5
VERNIER	Set for exactly 1 μ sec output
PULSE POLARITY	+
PULSE AMPLITUDE	1
VERNIER	Set for 1 volt output

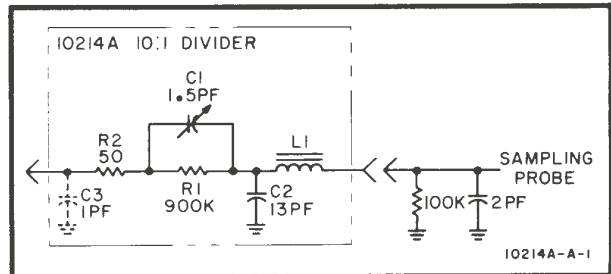

Figure 2. Model 10214A Divider Schematic Diagram

Table 2. Test Equipment

RECOMMENDED INSTRUMENT		REQUIRED CHARACTERISTICS
TYPE	MODEL	
Pulse Generator	HP 222A	1 MHz repetition rate, 0.5 μ sec pulse width
Sampling Oscilloscope	HP 1425A 1410A	1 GHz Bandwidth
50-ohm Tee	HP10221A	1 GHz Bandwidth
50-ohm Load	GR 874-W50	1 GHz Bandwidth

b. Set Oscilloscope controls as follows:

Function Selector CHANNEL A
 SENSITIVITY 100 mv/cm
 VERNIER CALIBRATED
 SMOOTHING NORMAL (optimized)
 SCANNING INTERNAL
 DENSITY cw
 TIME SCALE MAGNIFIER X2
 DELAY as required
 TIME SCALE 1 μ sec/cm
 VERNIER CAL
 MODE STABILITY . adjust for stable triggering
 TRIGGERING NORMAL
 TRIGGER SLOPE as required

c. Connect 50-ohm Load to 50-ohm Tee.

d. Connect loaded 50-ohm Tee to Pulse Generator OUTPUT.

e. Connect Oscilloscope CHANNEL A probe to 50-ohm Tee. A 10-cm pulse should appear on the CRT.

f. Insert Model 10214A 10:1 Divider between probe and 50-ohm Tee, and change oscilloscope SENSITIVITY to 10 mv/cm. A 10 (\pm 0.5) cm pulse should be obtained.

13. ADJUSTMENT PROCEDURE.

14. The following procedure adjusts the probe for optimum capacity. If the 10:1 division ratio is incorrect, replace the divider. Adjust the probe capacity as follows:

- a. Use the divider to monitor a 75-kHz square wave on the sampling oscilloscope.
- b. Adjust the oscilloscope to obtain a 10-centimeter display and optimize oscilloscope response.
- c. The overshoot on the display should be 3%.
- d. If the overshoot is not 3%, disconnect the divider and adjust the slotted plate in the female connector.
- e. Repeat steps b through d until the overshoot is 3%. Keep the response optimized during the adjustment procedure.

15. REPLACEABLE PARTS.

16. There is only one replaceable part in the Model 10214A, the probe pin, HP Part No. 5020-0457. Contact the nearest HP Sales/Service Office for replacements.

MODEL 10215A 100:1 DIVIDER

1. DESCRIPTION.

2. The HP Model 10215A 100:1 Divider is a signal probing accessory (see Figure 1) which is designed for use with the Model 1123A Voltage Probe only. The divider increases the dynamic range of the Model 1123A to ± 50 volts. Specifications for the HP Model 10215A are listed in Table 1.

Table 1. Specifications

ATTENUATION: 100:1 $\pm 5\%$ over bandpass of the HP Model 1123A.
INPUT IMPEDANCE: 1 megohm shunted by 3 pF.
EFFECT ON RISE TIME OF 1123A: Negligible.
MAXIMUM INPUT VOLTAGE: 500 Vdc overload, 50 V peak signal with HP Model 1123A.

3. CONNECTIONS.

4. The Model 10215A is connected to the probe by sliding the probe into the body portion of the divider.

5. USE WITH OTHER ACCESSORIES.

6. If the circuit to be probed contains dc potentials, an HP Model 10217A or 10228A Blocking Capacitor may be used in conjunction with the Model 10215A. When used together, however, the Blocking Capacitor should be used in front of the Divider Tip.

7. CIRCUITS.

8. A schematic of the Model 10215A is shown in Figure 2. The major components of the divider are resistor R1, which is used to damp lead inductance at the divider input. Resistor R1 and R2, with the 100k ohm parallel input resistance in the probe, accomplish the division ratio at low frequencies. At high frequencies the division is determined by C1 and C2.

9. MAINTENANCE.

10. The only maintenance recommended for the Model 10215A is to perform the performance check procedure if a malfunction is suspected, and compensation adjustment of the divider tip.

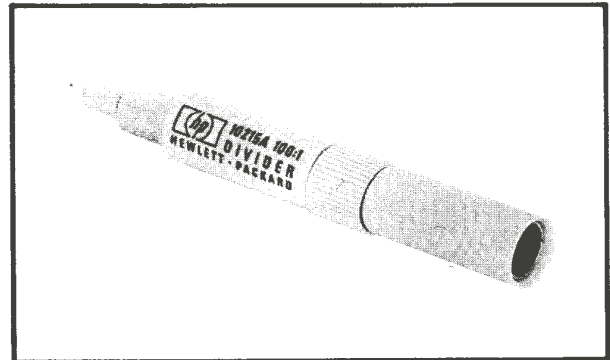

Figure 1. Model 10215A

11. PERFORMANCE CHECK.

12. The performance check procedure may be used as an incoming quality assurance inspection, or as an aid to troubleshooting. Test equipment required to check and maintain the Model 10215A is listed in Table 2.

a. Set controls as follows:

Square Wave Generator

FREQUENCY 10 KHz
 SYMMETRY CENTERED
 AMPLITUDE05

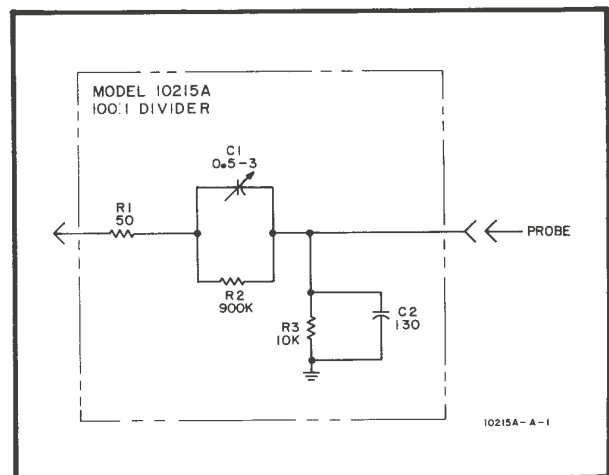

Figure 2. Schematic Diagram

Monitor Oscilloscope Vertical Amplifier

DISPLAY CHANNEL B
 VOLTS/DIV005
 COUPLING DC

Monitor Oscilloscope Time Base

TIME/DIV 20 μ sec
 MODE AUTO

Table 2. Required Test Equipment

Instrument	Type	Required Characteristics
Square Wave Generator	HP 211B	10 kHz
Monitor Oscilloscope	HP 180 A w/ 1801A, 1820A	50 MHz

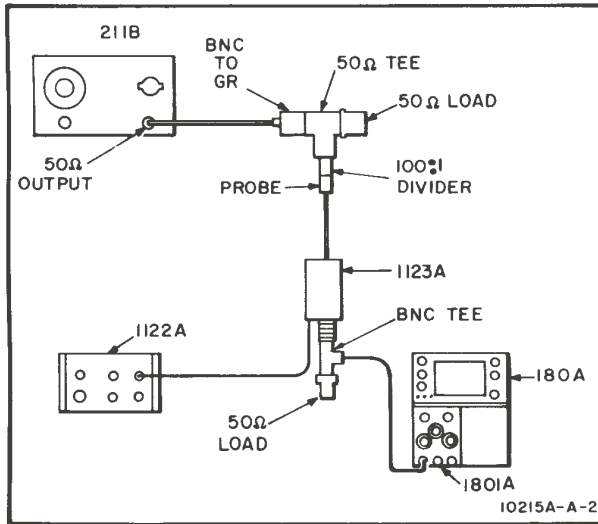

Figure 3. Test Set-up

- b. Make test set-up as shown in Figure 3.
- c. Adjust VERNIER for 8 division vertical display.
- d. Insert Model 10215A between probe and 50-ohm tee.
- e. Switch AMPLITUDE control on Square Wave Generator to 5.
- f. Deflection should be within 0.4 divisions ($\pm 5\%$) of full 8 divisions.

13. ADJUSTMENT PROCEDURE.

14. The following procedure contains steps to adjust the divider compensation.

- a. Use test set-up as shown in Figure 3.
- b. Hold front portion of divider and loosen locking sleeve by turning ccw.
- c. Hold locking sleeve and front portion while adjusting rear portion for optimum pulse response.
- d. Tighten locking sleeve making sure pulse does not change.

15. REPLACEABLE PARTS.

16. Replaceable parts for the Model 10215A are listed in Table 3. When ordering parts, be sure to include model number and HP Part Number. Sales/Service Office addresses are listed at the rear of this Operating Note.

Table 3. Replaceable Parts

Description	HP Part No.
Nut, locking	10215-60701
Resistor & Spring Assembly	10215-61501
Body Assembly, Rear	10215-67701
Body Assembly, Front	10215-67702
Probe Pin	5020-0457

MODEL 10217A BLOCKING CAPACITOR

1. DESCRIPTION.

2. The HP Model 10217A Blocking Capacitor is a probing accessory for the HP Model 1425A/1410A oscilloscope sampling system. The Model 10217A is illustrated in Figure 1. The blocking capacitor is used to isolate the sampling probe from dc potentials present in the test circuit. Specifications for the Model 10217A are listed in Table 1.

3. CONNECTIONS.

4. The Model 10217A is connected to the sampling probe by sliding the probe into the body portion of the blocking capacitor.

5. USE WITH OTHER ACCESSORIES.

6. The Model 10217A is used with the sampling probe as described above. It may also be used with the Model 10214A 10:1 Divider and the Model 10216A Isolator.

Table 1. Specifications

CAPACITANCE: 0.001 μ F.
MAXIMUM INPUT VOLTAGE: ± 50 Vdc, 50V pk-to-pk ac. (± 200 V when used with 10:1 Divider.)
SAG: 1% on 1 μ sec pulse. (0.1% on 1 μ sec when Model 10214A 10:1 Divider is used.)
SHUNT CAPACITANCE: Less than 3.0 pF.

7. CIRCUITS.

8. The schematic of the Model 10217A is shown in Figure 2. The blocking capacitor is a 0.001- μ F low-inductance capacitor which is used to keep dc potentials in the circuit under test from reaching the vertical amplifier. It is capable of blocking ± 100 volts dc from

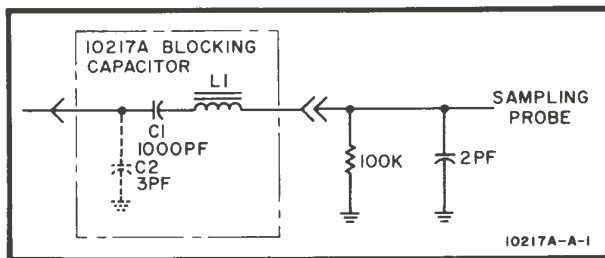

Figure 2. Model 10217A Blocking Capacitor Schematic

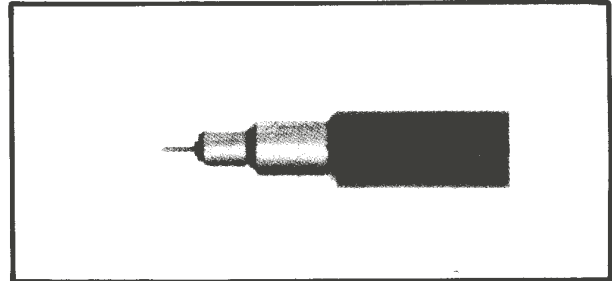

Figure 1. Model 10217A Blocking Capacitor

ground. Inductor L1 provided to damp any resonances that may be developed in the circuit, and capacitor C2 represents the stray input capacitance present within the assembly.

9. MAINTENANCE.

10. The only maintenance recommended for the Model 10217A is to run a performance check if a malfunction is suspected.

11. PERFORMANCE CHECK.

12. Perform the following procedure as an acceptance check or if a malfunction in the blocking capacitor is suspected. Test equipment required for the performance check is listed in Table 2.

a. Set pulse generator controls as follows:

REP RATE	100k-1M
VERNIER	Set for 500 kHz output
PULSE DELAY and VERNIER	as required
PULSE WIDTH	.5-5
VERNIER	Set for exactly 1 μ sec output
PULSE POLARITY	+
PULSE AMPLITUDE	1
VERNIER	Set for 1 volt output

b. Set oscilloscope controls as follows:

Function Selector	CHANNEL A
SENSITIVITY	100 mV/cm
VERNIER	CALIBRATED
SMOOTHING	NORMAL (optimized)
SCANNING	INTERNAL
DENSITY	·cw
TIME SCALE MAGNIFIER	X10
DELAY	as required
TIME SCALE	1 μ sec/cm
VERNIER	CAL

Table 2. Test Equipment

RECOMMENDED INSTRUMENT		REQUIRED CHARACTERISTICS
TYPE	MODEL	
Pulse Generator	HP 213B	Risetime less than 100 ps
Sampling Oscilloscope	HP 1425A/1410A	1 GHz Bandwidth
50-ohm Tee	HP 10221A	1 GHz Bandwidth
50-ohm Load	GR 874-W50	1 GHz Bandwidth

MODE STABILITY . adjust for stable triggering
 TRIGGERING NORMAL
 TRIGGERING SLOPE required

- c. Connect 50-ohm load to 50-ohm tee.
- d. Connect loaded 50-ohm tee to pulse generator OUTPUT.
- e. Connect Model 10217A to oscilloscope CHANNEL A probe, and insert into 50-ohm tee.
- f. Adjust VERTICAL POSITION, pulse generator DELAY, and oscilloscope DELAY to observe a 10-cm pulse.

g. Change the system sensitivity to 10 mV/cm, and adjust VERTICAL POSITION to observe top of pulse on CRT. Sag shall be less than 1 cm.

13. REPLACEABLE PARTS.

14. There is only one replaceable part in the Model 10217A; probe pin, HP Part No. 5020-0457. Contact the nearest HP Sales/Service Office for replacements. If it is determined that the blocking capacitor is faulty, it must be replaced in its entirety.

MODEL 10228A BLOCKING CAPACITOR

1. DESCRIPTION.

2. The HP Model 10228A Blocking Capacitor is a signal probing accessory (see Figure 1). The Model 10228A is used to isolate an instrument from dc potentials present in the test circuit. Specifications for the Model 10228A are listed in Table 1.

Table 1. Specifications

CAPACITANCE:	0.18 μ F
MAXIMUM INPUT VOLTAGE:	\pm 50V dc (\pm 200V when used with divider tip).
RISETIME: (Driven from 25 Ω source)	< 4.5 nsec.
SHUNT CAPACITANCE:	Less than 25 pF.

3. CONNECTIONS.

4. The Model 10228A is connected to the probe by sliding the probe into the body portion of the blocking capacitor.

5. USE WITH OTHER ACCESSORIES.

6. The Model 10228A may be used in conjunction with the probe as described above or it may be used with the Model 10214A 10:1 Divider, the Model 10215A 100:1 Divider, and the Model 10229A Hook Tip.

7. CIRCUITS.

8. A schematic diagram of the Model 10228A is shown in Figure 2. The blocking capacitor (C1) is a 0.18 μ F low-inductance capacitor which is used to keep dc voltages in the circuit under test from reaching the Vertical Amplifier. It is capable of blocking \pm 50 volts dc from ground. Inductor L1 is provided to dampen the lead inductance. Capacitor C2 represents the stray circuit capacitance within the blocking Capacitor Assembly.

9. MAINTENANCE.

10. The only maintenance recommended is to run a performance check if operation is improper. There are no adjustments or replaceable parts (except for the probe pin) for the Model 10228A.

11. PERFORMANCE CHECK.

12. The following procedure may be used as an incoming quality assurance check, or if the Blocking Capacitor is not functioning properly. Test equipment required for the procedure is listed in Table 2.

- a. Set Pulse Generator controls as follows:
 TRIGGER POS
 OUTPUT POS
 SENSITIVITY For triggered output



Figure 1. Model 10228A

- b. Set Sampling Oscilloscope controls as follows:
 CHANNEL SELECTOR CHANNEL A
 MILLIVOLTS/CM 10
 SMOOTHING NORMAL
 POLARITY +UP
 VERNIER For 10 cm display
 TIME/CM 10 nsec
 MAGNIFIER X1
 SCANNING NORMAL
 SYNC PULSE ON
 TRIGGER FREE RUN

- c. Make connections as shown in Figure 3.
- d. Adjust Channel A POSITION control to observe a 10 cm display.
- e. Overshoot should be less than 5%.
- f. Switch MAGNIFIER to X10.
- g. Risetime from baseline to flat portion of pulse top should be less than 4.5 nsec.

13. REPLACEABLE PARTS.

14. There is only one replaceable part for the Model 10228A, which is the probe pin, HP Part No. 5020-0457. For replacements, contact the nearest HP Sales/Service Office, listed at the rear of this Operating Note.

Table 2. Test Equipment

INSTRUMENT		CHARACTERISTICS
TYPE	MODEL	
Pulse Generator	HP 213B	100 psec risetime
Sampling Oscilloscope	HP 140A w/1410A, 1424A	1GHz Bandwidth
Test Oscilloscope	HP 180A w/1801A, 1821A	50 MHz Bandwidth

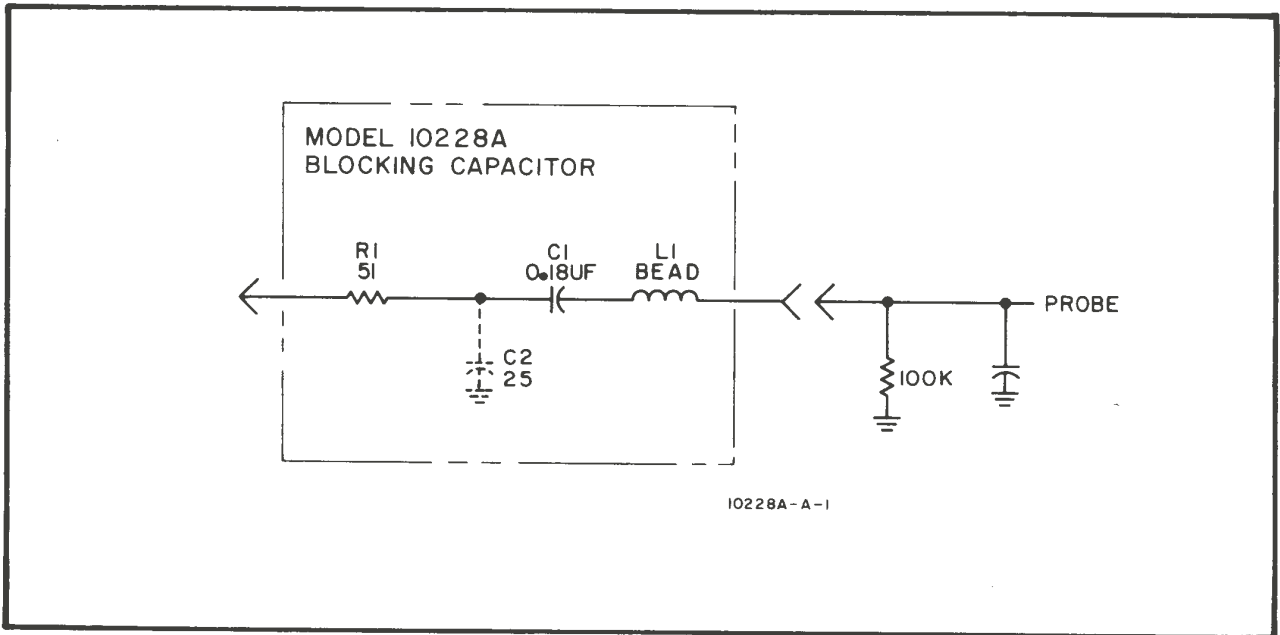

Figure 2. Schematic Diagram

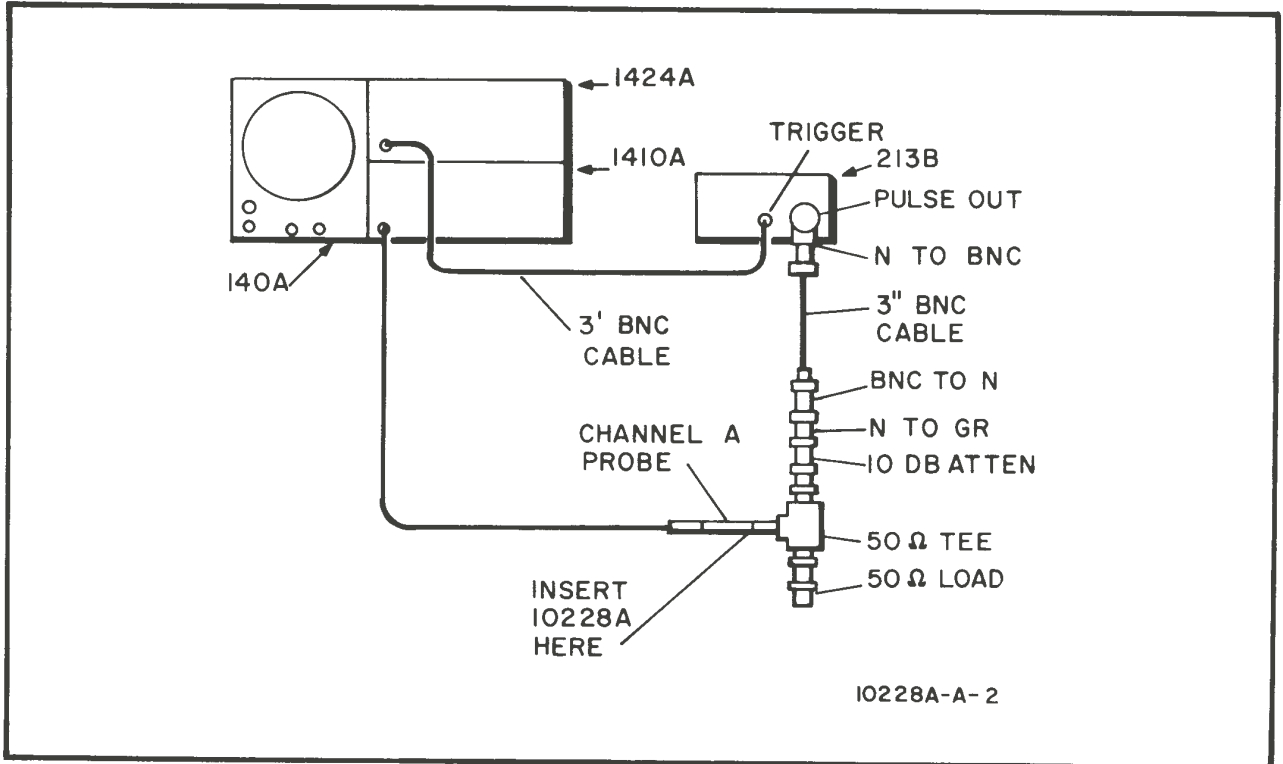

Figure 3. Test Set-up