

Errata

This manual may contain references to HP or Hewlett-Packard. Please note that Hewlett-Packard's former test and measurement, semiconductor products and chemical analysis businesses are now part of Agilent Technologies. To reduce potential confusion, the only change to product numbers and names has been in the company name prefix: where a product number/name was HP XXXX the current name/number is now Agilent XXXX. For example, model number HP8648 is now model number Agilent 8648.

Ce manuel peut contenir des références à <<HP>> ou <<Hewlett-Packard.>> Veuillez noter que les produits de test et mesure, de semi-conducteur et d'analyse chimique qui avaient fait partie de la société Hewlett-Packard sont maintenant une partie de la société Agilent Technologies. Pour réduire la confusion potentielle, le seul changement aux noms de référence a été dans le préfixe de nom de société : là où un nom de référence était HP XXXX, le nouveau nom de référence est maintenant Agilent XXXX. Par exemple, le HP 8648 s'appelle maintenant Agilent 8648.

Diese Gebrauchsanweisung kann Bezug nehmen auf die Namen HP oder Hewlett-Packard. Bitte beachten Sie, dass ehemalige Betriebsbereiche von Hewlett-Packard wie HP-Halbleiterprodukte, HP-chemische Analysen oder HP-Test- und Messwesen nun zu der Firma Agilent Technology gehören. Um Verwirrung zu vermeiden wurde lediglich bei Produktname und - Nummer der vor laufende Firmenname geändert: Produkte mit dem Namen/Nummer HP XXXX lauten nun mehr Agilent XXXX. Z.B. das Modell HP 8648 heißt nun Agilent 8648.

Questo manuale potrebbe contenere riferimenti ad HP o Hewlett-Packard. Si noti che le attività precedentemente gestite da Hewlett-Packard nel campo di Test & Misura, Semiconduttori, ed Analisi Chimica sono ora diventate parte di Agilent Technologies. Al fine di ridurre il rischio di confusione, l'unica modifica effettuata sui numeri di prodotto e sui nomi ha riguardato il prefisso con il nome dell'azienda : dove precedentemente compariva "HP XXXX" compare ora "Agilent XXXX". Ad esempio: il modello HP8648 è ora indicato come Agilent 8648.

Este manual puede hacer referencias a HP o Hewlett Packard. Las organizaciones de Prueba y Medición (Test and Measurement), Semiconductores (Semiconductor Products) y Análisis Químico (Chemical Analysis) que pertenecían a Hewlett Packard, ahora forman parte de Agilent Technologies. Para reducir una potencial confusión, el único cambio en el número de producto y nombre, es el prefijo de la compañía: Si el producto solía ser HP XXXX, ahora pasa a ser Agilent XXXX. Por ejemplo, el modelo HP8648 es ahora Agilent 8648.

这个手册里面可能含有惠普公司的资料。请注意惠普公司以前的测试, 半导体产品, 化学分析部门现在属于安捷伦公司。为了减少可能的误解, 产品号码和名字只改变最前面的公司名字。如果一个产品的号码/名字以前是HP XXXX, 现在的号码/名字是安捷伦 XXXX。例如模型号码是惠普8648。现在是模型号码安捷伦8648。

Document Part Number 5971-2669
Printed in the UK September 2004



Agilent Technologies

マニュアル・チェンジ

変更

本文中の「HP (YHP)」、または「(横河)ヒューレット・パッカー株式会社」という語句を、「Agilent」、または「アジレント・テクノロジー株式会社」と変更してください。

ヒューレット・パッカー社の電子計測、半導体製品、化学分析ビジネス部門は分離独立し、アジレント・テクノロジー社となりました。

社名変更に伴うお客様の混乱を避けるため、製品番号の接頭部のみ変更しております。

(例: 旧製品名 HP 4294A は、現在 Agilent 4294A として販売いたしております。)

11683A Range Calibrator

Operating and Service Manual



Agilent Technologies

Part No. 11683-90014

Printed in UK

July 1998

© Copyright Hewlett-Packard Ltd. 1998

Notice

The information contained in this document is subject to change without notice.

Hewlett-Packard makes no warranty of any kind with regard to this material, including but not limited to, the implied warranties of merchantability and fitness for a particular purpose. Hewlett-Packard shall not be liable for errors contained herein or for incidental or consequential damages in connection with the furnishing, performance, or use of this material.

This manual applies to instruments with serial numbers prefixed 3303U and below. With the changes in the Appendix added, this manual applies to instruments with serial numbers prefixed 1314A, 1551A.

© Copyright Hewlett-Packard Ltd. 1998.
All Rights Reserved. Reproduction, adaptation, or translation without prior written permission is prohibited, except as allowed under the copyright laws. Station Road, South Queensferry, Scotland, EH30 9TG, UK.

Warranty

This Hewlett-Packard product is warranted against defects in materials and workmanship for a period of one year from date of shipment. During the warranty period, Hewlett-Packard Company will, at its option, either repair or replace products which prove to be defective.

For warranty service or repair, this product must be returned to a service facility designated by HP. Buyer shall prepay shipping charges to HP and HP shall pay shipping charges to return the product to Buyer. However, Buyer shall pay all shipping charges, duties, and taxes for products returned to HP from another country.

Limitation of Warranty

The foregoing warranty shall not apply to defects resulting from:

- 1 Improper or inadequate maintenance, adjustment, calibration, or operation by Buyer;
- 2 Buyer-supplied software, hardware, interfacing or consumables;
- 3 Unauthorized modification or misuse;
- 4 Operation outside of the environmental and electrical specifications for the product;
- 5 Improper site preparation and maintenance; or
- 6 Customer induced contamination or leaks.

THE WARRANTY SET FORTH IS EXCLUSIVE AND NO OTHER WARRANTY, WHETHER WRITTEN OR ORAL, IS EXPRESSED OR IMPLIED. HP SPECIFICALLY DISCLAIMS THE IMPLIED WARRANTIES OF MERCHANTABILITY AND FITNESS FOR A PARTICULAR PURPOSE.

Limitation of Remedies and Liability

THE REMEDIES PROVIDED HEREIN ARE BUYER'S SOLE AND EXCLUSIVE REMEDIES. IN NO EVENT SHALL HP BE LIABLE FOR DIRECT, INDIRECT, SPECIAL, INCIDENTAL, OR CONSEQUENTIAL DAMAGES (INCLUDING LOSS OF PROFITS) WHETHER BASED ON CONTRACT, TORT OR ANY OTHER LEGAL THEORY.

Declaration of Conformity

Declaration of Conformity

Declaration of Conformity according to ISO/IEC Guide 22 and EN45014	
Manufacturer's Name:	Hewlett-Packard Ltd.
Manufacturer's Address:	Queensferry Microwave Division South Queensferry West Lothian, EH30 9TG Scotland, United Kingdom
Declares that the product	
Product Name:	Power Meter Range Calibrator
Model Numbers:	HP 11683A
Product Options:	This declaration covers all options of the above products as detailed in TCF A-5951-9852-02
Conforms with the protection requirements of European Council Directive 89/336/EEC on the approximation of the laws of the member states relating to electromagnetic compatibility.	
Against EMC test specifications EN 55011:1991 (Group 1, Class A) and EN 50082-1:1992	
As Detailed in:	Electromagnetic Compatibility (EMC) Technical Construction File (TCF) No. A-5951-9852-02
Assessed by:	Dti Appointed Competent Body EMC Test Centre, GEC-Marconi Avionics Ltd., Maxwell Building, Donibristle Industrial Park, KY11 5LB Scotland, United Kingdom
Technical Report Number:6893/2200/CBR, dated 23 September 1997	
Supplementary Information:	The product conforms to the following safety standards: EN 61010-1(1993) / IEC 1010-1(1990) +A1(1992) CSA-C22.2 No. 1010.1-92
The product herewith complies with the requirements of the Low Voltage Directive 73/23/EEC, and carries the CE-marking accordingly.	
<i>South Queensferry, Scotland</i>	<i>25 May 1998</i> <i>R.M. Evans</i>
<i>Location</i>	<i>Date</i> <i>R.M. Evans / Quality Manager</i>

Europe Contact:

Your local Hewlett-Packard Sales and Service Office or Hewlett-Packard GmbH, Department 2Q/
Standards Europe Herrenberger Strasse 130, D7030 Boblinger (Fax: +49-7031-143143)

Statement of Compliance

Electromagnetic Compatibility (EMC) Information

This product has been designed to meet the protection requirements of the European Communities Electromagnetic Compatibility (EMC) directives:

- EN55011:1991 (Group 1, Class A)
- EN50082-1:1992
- IEC 1000-4-2 (1995) ESD
- IEC 1000-4-3 (1995) Radiated Susceptibility
- IEC 1000-4-4 (1995) EFT

In order to preserve the EMC performance of the product, any cable which becomes worn or damaged must be replaced with the same type and specification.

Safety Information

This instrument has been designed and tested in accordance with publication EN61010-1(1993) / IEC 1010-1(1990) +A1(1992) +A2(1994) / CSA C22.2 No. 1010.1(1993) Safety Requirements for Electrical Equipment for Measurement, Control and Laboratory Use, and has been supplied in a safe condition. The instruction documentation contains information and warnings which must be followed by the user to ensure safe operation and to maintain the instrument in a safe condition.

Noise Declaration

LpA<70dB

am Arbeitsplatz (operator position)

normaler Betrieb (normal position)

nach DIN 45635 pt.19 (per ISO 7779)

General Safety Information

The following general safety precautions must be observed during all phases of operation, service, and repair of this instrument. Failure to comply with these precautions or with specific warnings elsewhere in this manual violates safety standards of design, manufacture, and intended use of the instrument. Hewlett-Packard Company assumes no liability for the customer's failure to comply with these requirements.

WARNING

This is a Safety Class I instrument (provided with a protective earthing ground, incorporated in the powercord). The mains plug shall only be inserted in a socket outlet provided with a protective earth contact. Any interruption of the protective conductor inside or outside of the instrument is likely to make the instrument dangerous. Intentional interruption is prohibited.

DO NOT operate the product in an explosive atmosphere or in the presence of flammable gasses or fumes.

DO NOT use repaired fuses or short-circuited fuseholders: For continued protection against fire, replace the line fuse(s) only with fuse(s) of the same voltage and current rating and type.

DO NOT perform procedures involving cover or shield removal unless you are qualified to do so: Operating personnel must not remove equipment covers or shields. Procedures involving the removal of covers and shields are for use by service-trained personnel only.









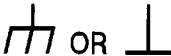

DO NOT service or adjust alone: Under certain conditions, dangerous voltages may exist even with the equipment switched off. To avoid dangerous electrical shock, service personnel must not attempt internal service or adjustment unless another person, capable of rendering first aid and resuscitation, is present.

DO NOT operate damaged equipment: Whenever it is possible that the safety protection features built into this product have been impaired, either through physical damage, excessive moisture, or any other reason, **REMOVE POWER** and do not use the product until safe operation can be verified by service-trained personnel. If necessary, return the product to a Hewlett-Packard Sales and Service Office for service and repair to ensure the safety features are maintained.

DO NOT substitute parts or modify equipment: Because of the danger of introducing additional hazards, do not install substitute parts or perform any unauthorized modification to the product. Return the product to a Hewlett-Packard Sales and Service Office for service and repair to ensure the safety features are maintained.

Safety Symbols

The following symbols on the instrument and in the manual indicate precautions which must be taken to maintain safe operation of the instrument.

Safety Symbols	
	The Instruction Documentation Symbol. The product is marked with this symbol when it is necessary for the user to refer to the instructions in the supplied documentation.
	Indicates the field wiring terminal that must be connected to earth ground before operating the equipment - protects against electrical shock in case of fault.
	Frame or chassis ground terminal - typically connects to the equipment's metal frame.
	Alternating current (AC)
	Direct current (DC)
	Indicates hazardous voltages
	Warning denotes a hazard. It calls attention to a procedure, which if not correctly performed or adhered to could result in injury or loss of life. Do not proceed beyond a warning note until the indicated conditions are fully understood and met.
	Caution denotes a hazard. It calls attention to a procedure, which if not correctly performed or adhered to could result in damage to or destruction of the instrument. Do not proceed beyond a caution note until the indicated conditions are fully understood and met.
	The CE mark shows that the product complies with all relevant European Legal Directives.
ISM 1-A	This is a symbol of an Industrial, Scientific, and Medical Group 1 Class A product.
	The CSA mark is a registered trademark of the Canadian Standards Association, and indicates compliance to the standards laid out by them.

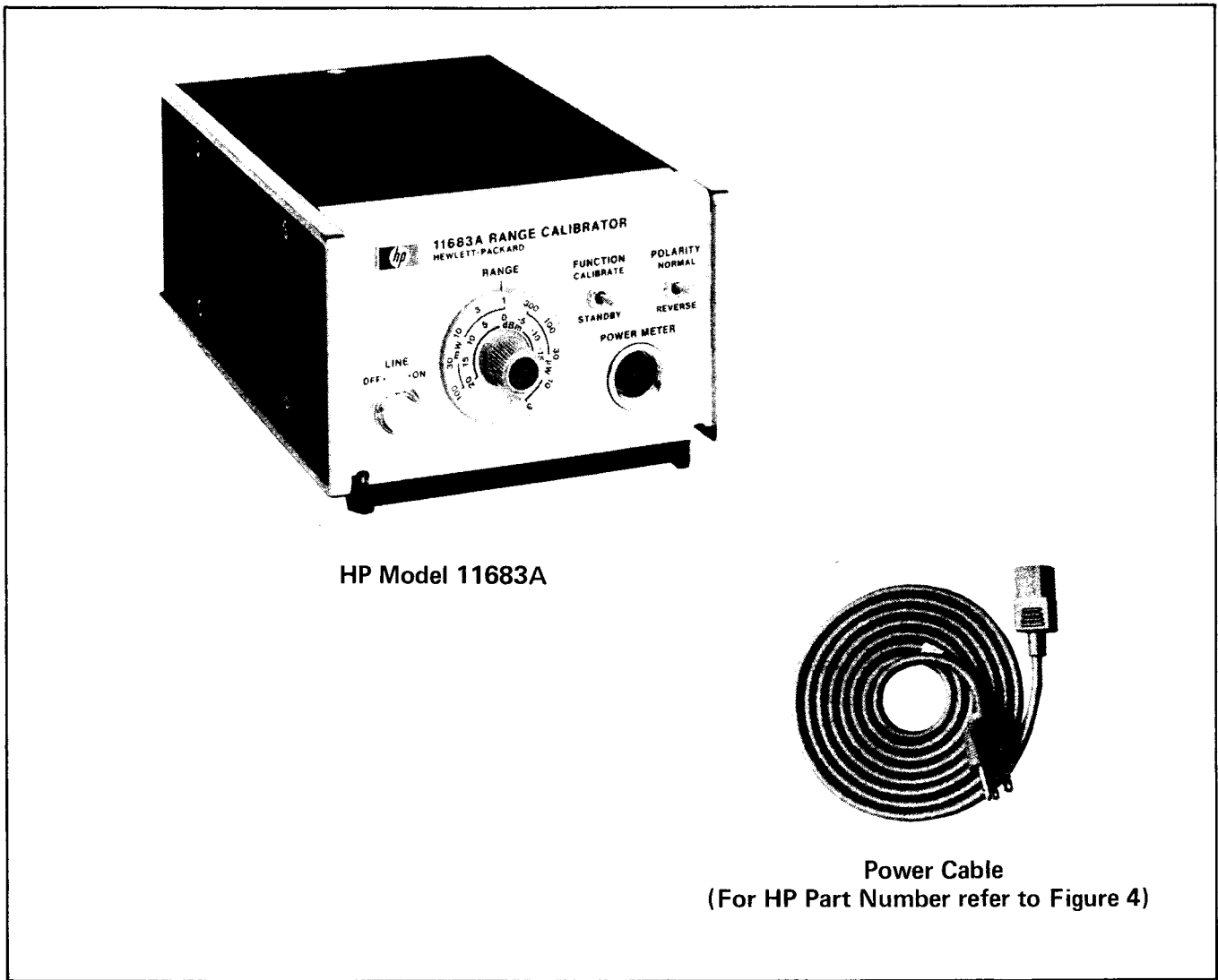

HP Model 11683A

Power Cable
(For HP Part Number refer to Figure 4)

Figure 1. HP Model 11683A Calibrator and Accessories Supplied

Table 1. Specifications

<p>Operational</p>	<p>Calibration Functions: Output voltage corresponding to meter readings at 3, 10, 30, 100 and 300 μW; 1, 3, 10, 30, and 100mW.</p> <p>Range-to-Range Calibration Uncertainty: 0.25% in all ranges.</p>
<p>Environmental</p>	<p>Operating Temperature: 0 to + 55 °C.</p> <p>Storage Temperature: -40 to + 70 °C.</p> <p>Humidity: Up to 95% Relative Humidity to 40 °C.</p> <p>EMC: Meets EN55011:1991 (Group1, ClassA), and EN50082-1:1992.</p>
<p>Physical</p>	<p>Weight: 1.1 kg (2lb 8 oz) nominal.</p> <p>Dimensions (height x width x depth): 88.9H x 133.3W x 215.9D mm (3.5 x 5.25 x 8.5 ins) nominal.</p>

1. GENERAL INFORMATION

2. This operating and service manual contains information pertaining to incoming inspection, operation, performance tests, adjustments, and service for the HP Model 11683A Range Calibrator.

3. Equipment recommended for use in performance tests, adjustments, and service to the 11683A is listed in Table 2. Test equipment which meets or exceeds the critical specifications of Table 2 must be used for calibration if the 11683A is expected to conform to the published specifications.

4. The 11683A and all supplied accessories are shown in Figure 1. The published specifications are listed in Table 1.

5. Instruments Covered by Manual

6. This instrument has a two-part serial number. The first four digits and the letter comprise the serial number prefix. The last five digits form the sequential suffix that is unique to each instrument. The contents of this manual apply directly to instruments having the same serial number prefix(es) as listed under SERIAL NUMBERS on the title page.

7. An instrument manufactured after the printing of this manual may have a serial prefix that is not listed on the title page. This unlisted serial prefix indicates that the instrument is different from those documented in this manual. The manual for this instrument is supplied with a yellow Manual Changes supplement that contains "change information" that documents the differences.

8. In addition to change information, the supplement may contain information for correcting errors in the manual. To keep this manual as current and accurate as possible, Hewlett-Packard recommends that you periodically request the latest Manual Changes supplement. The supplement for this manual is keyed to this manual's print date and part number, both of which appear on the title page. Complimentary copies of the supplement are available from Hewlett-Packard.

9. For information concerning a serial number prefix not listed on the title page or in the Manual Changes supplement, contact your nearest Hewlett-Packard office.

10. Description

11. The 11683A Range Calibrator is used to verify proper operation of compatible Power Meters such

Table 2. Recommended Test Equipment

Instrument	Critical Specifications	Model	Use*
Digital Voltmeter	Readout: 5 digits DC Measurements Ranges: 100 mV to 100 V full-scale Accuracy: ± 0.02% Resistance Measurements (four-wire measurement capability) Ranges: 100 Ω to 10 kΩ full-scale Sensitivity: 1 mΩ Accuracy: ± 0.02%	HP 3455A	P, A, T
Oscilloscope	Vertical Amplifier Bandwidth: DC to 5 MHz Deflection Factor: 50 mV/division minimum Attenuator Accuracy: ± 2% Time Base Time Span/division: 1 ms to 1 s Time base accuracy: ± 3%	HP 180C/ 1801A/ 1821A	A, T
Four-Wire Cable	Recommended Length: 5 feet maximum	(see Figure 2)	P

*P = performance; A = adjustment; T = troubleshooting

as the HP Model 435A. The Power Meter's range-to-range accuracy and proper auto-zero operation can be easily verified. The 11683A can supply a full-scale test signal to the Power Meter for each Range Switch setting.

12. When set to CALIBRATE, the FUNCTION switch applies a dc voltage to the Power Meter; the input is grounded in STANDBY. The POLARITY switch increases ease of testing and adjusting the Power Meter auto-zero feedback circuit.

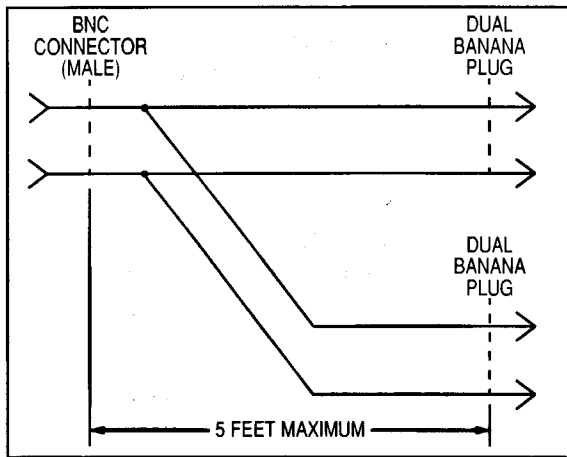

Figure 2. Four-Wire Cable

13. INSTALLATION

14. Initial Inspection

15. Inspect the shipping container for damage. If the shipping container or packing material is damaged it should be kept until the contents of the shipment have been checked mechanically and electrically. If there is mechanical damage or if the instrument does not pass the performance tests, notify the nearest Hewlett-Packard office. Keep the damaged shipping materials (if any) for the carrier and a Hewlett-Packard representative to inspect. The HP office will arrange for repair or replacement without waiting for claim settlement.

16. Power Requirements

17. The 11683A Range Calibrator requires a power source with an output of 100, 120, 220, or 240 Vac +5% -10%. For 100 and 120Vac, 48 to 66Hz or 360 to 440 Hz at 125 mA. For 220 and 240 Vac, 48 to 66 Hz at 62 mA. Power consumption is less than 12 VA.

18. Line Voltage Selection

19. Figure 3 provides instruction for line voltage and fuse selection. The Line Voltage Selection Card and fuse are factory installed for 120 Vac operation.

20. Power Cable

21. In accordance with international safety standards, this instrument is equipped with a three-wire power cable. When connected to an appropriate ac power receptacle, this cable grounds the instrument cabinet. The type of power cable plug shipped with each instrument depends on the country of destination. Refer to Figure 4 for the part numbers of the power cable plugs available.

WARNING

The protection provided by grounding the instrument cabinet may be lost if any power cable other than the three-pronged type supplied is used to couple the ac line voltage to the instrument.

22. Interconnections

23. Refer to the Power Meter's operating and service manual for hook-up instructions.

24. Operating Environment

25. The instrument is designed for Indoor use only. The instrument may be operated at temperatures from 0°C to +55°C at altitudes up to 4600m (15,000ft.). The instrument may be operated in environments up to 95% relative humidity to 40°C, but should be protected from temperature extremes which may cause condensation.

CAUTION

This instrument is designed for use in Installation Category II and Pollution Degree 2 per IEC1010 and 644 respectively.

26. Bench Operation

27. The instrument is equipped with plastic feet and a tilt stand for use on a bench.

28. Rack Mounting

29. The instrument can be rack mounted by using an adapter frame. The adapter frame is a rack frame that accepts several combinations of sub-modular units. For additional information, address inquiries to your nearest Hewlett-Packard office.

30. Storage and Shipment

31. The instrument should be stored in a clean dry environment. The following environmental limitations apply to both storage and shipment:

- Temperature -40 to +75°C
- Humidity < 95% relative
- Altitude < 25,000 feet

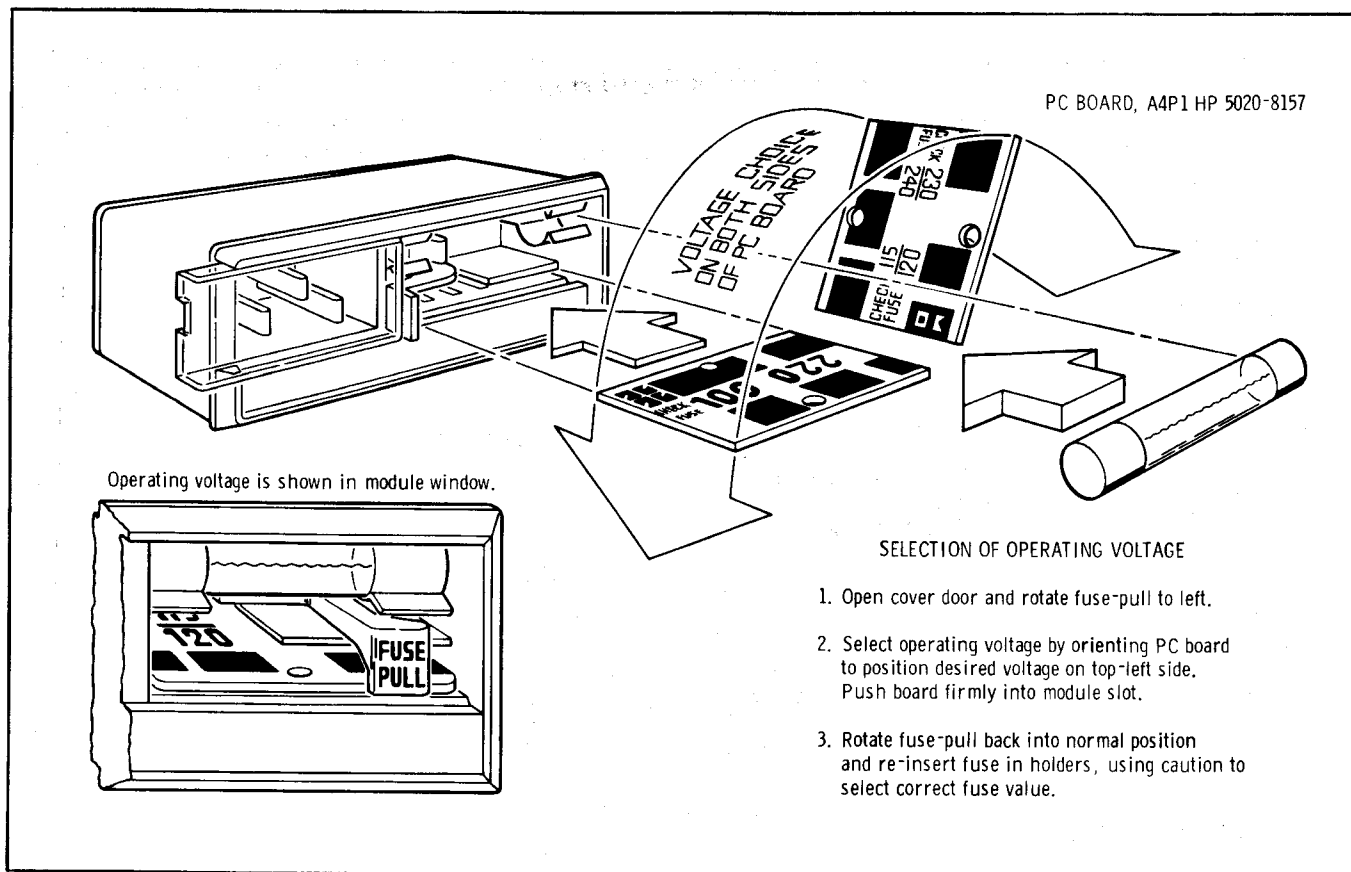

Figure 3. Line Voltage Selection

32. Original Packaging. Containers and materials identical to those used in factory packaging are available through Hewlett-Packard offices. If the instrument is being returned to Hewlett-Packard for servicing, attach a tag indicating the type of service required, return address, model number,

and full serial number. Also, mark the container **FRAGILE** to assure careful handling. In any correspondence, refer to the instrument by model number and full serial number.

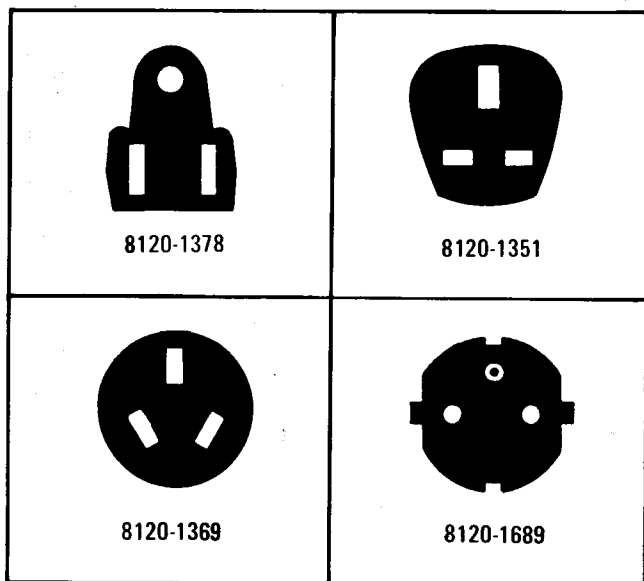

Figure 4. Power Cable HP Part Numbers Versus Mains Plugs Available

33. Other Packaging. The following general instructions should be used for re-packaging with commercially available materials:

- a. Wrap the instrument in heavy paper or plastic. (If shipping to a Hewlett-Packard office or service center, attach a tag indicating the type of service required, return address, model number, and full serial number.)
- b. Use a strong shipping container.
- c. Use enough shock-absorbing material (3- to 4-inch layer) around all sides of the instrument to provide a firm cushion and prevent movement inside the container. Protect the control panel with cardboard.
- d. Seal the shipping container securely.
- e. Mark the shipping container **FRAGILE** to assure careful handling.

34. OPERATING INSTRUCTIONS

35. Operation of the controls of the 11683A is explained in Figure 6; Figure 7 provides operating and hookup instructions with a compatible Power Meter.

36. MAINTENANCE INSTRUCTIONS

a. Use a soft clean damp cloth to clean the front panel and side covers.

b. Maintenance by the operator consists of changing the fuse (refer to Figure 3), and Line switch lamp replacement (refer to Figure 5).



Power Requirements

Operating Voltage Range: 100/120/220/240V

Operating Frequency Range: 48-66 and 360-440Hz at
100 & 120Vac.
48 - 66Hz at 220 & 240Vac

Power Dissipation: 12 VA (max)



Before switching on this instrument, make sure that the line voltage selector PCB board is set to the voltage of the power supply and the correct fuse installed. Assure the power supply voltage is in the specified range.

Mains supply voltage fluctuations should not exceed +/-10% of the nominal selected line voltage.

WARNING

Appliance coupler (mains input powercord) is the power disconnect device. Do not position the instrument such that access to the coupler is impaired.

For continued protection against fire hazard, replace the line fuse only with the same type and line rating (F125mA 250V @ 100V & 120V, or F62mA 250V @ 220V & 240V). The use of other fuses or materials is prohibited.

If this instrument is not used as specified, the protection provided by the equipment could be impaired. This instrument must be used in a normal condition only (in which all means for protection are intact).

No operator serviceable parts inside. Refer servicing to qualified personnel. To prevent electrical shock do not remove covers.

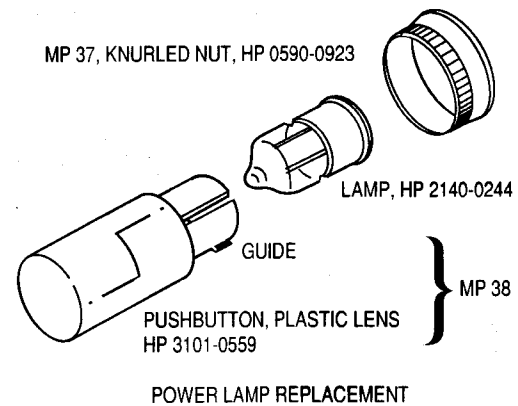

1. Remove lens by pulling straight out.
2. Replace lamp.
3. To replace lens, align guide with notch in receptacle. Push straight in.

Figure 5. Line Switch Lamp Replacement

FRONT AND REAR PANEL FEATURES
(ILLUSTRATIONS FOR INDICATION ONLY)

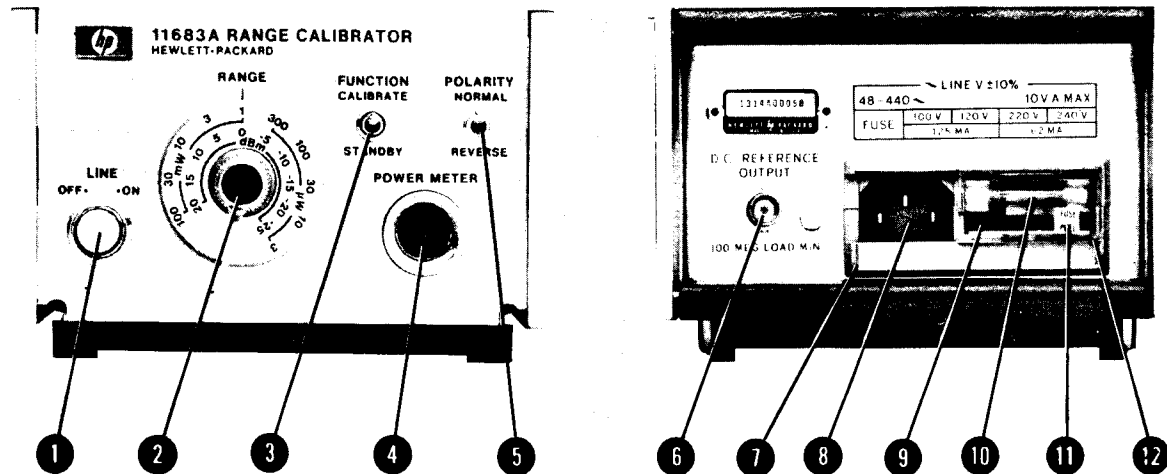

- 1** **LINE Switch.** Controls primary power. Illuminated when instrument is ON.
- 2** **RANGE Switch.** Equivalent to compatible Power Meter's Range Switch; produces a full scale Power Meter reading when 11683A and Power Meter Range switches are set to same scale.
- 3** **FUNCTION Switch.** When the switch is set to CALIBRATE an output dependent on the RANGE switch setting is coupled to the Power Meter. In STANDBY mode the output is grounded.
- 4** **POWER METER Connector.** Connects the output to, and control signals from, compatible Power Meter via Power Sensor Cable.
- 5** **POLARITY Switch.** An upscale reading is obtained on the Power Meter when the switch is set to NORMAL. The REVERSE setting produces a down-scale reading.
- 6** **D.C. REFERENCE OUTPUT Connector.** DC reference voltage output from RANGE Switch. Load resistance must be $\geq 100 \text{ M}\Omega$ for proper operation of the 11683A.
- 7** **Power Module Assembly.**
- 8** **Receptacle.** Couples transformer primary to line voltage via power cable.
- 9** **Line Voltage Selection Card.** Matches transformer primary to line voltage. Refer to Figure 3.
- 10** **Fuse.** A 1/8 A fuse is used at 100/120 Vac; 1/16 A fuse at 220/240 Vac.
- 11** **Fuse Pull Handle.** Mechanical interlock; fuse must be removed before extraction of Line Voltage Selection Card.
- 12** **Window.** Safety interlock; fuse cannot be removed while power cable is coupled to Power Module Receptacle.

Figure 6. Front and Rear Panel Controls, Connectors, and Indicators

OPERATING INSTRUCTIONS

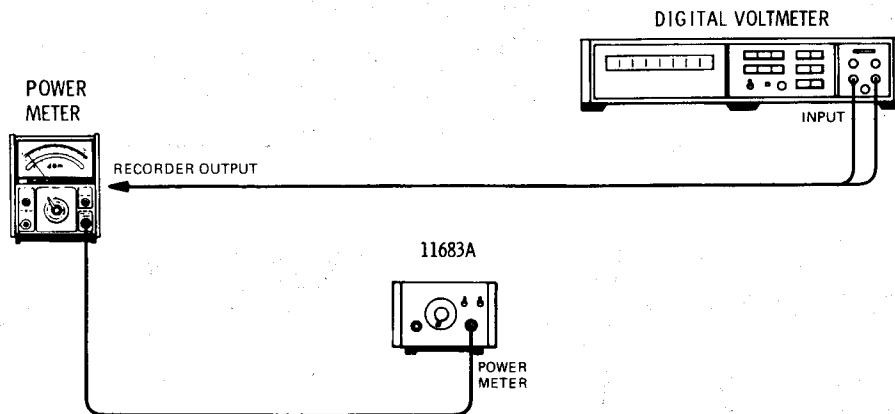

TURN ON

- a. Verify that the power transformer primary of the 11683A is matched to the line voltage. See Figure 3.
- b. Check the fuse, contained in the Power Module Assembly, for the correct rating. The voltage and amperage are shown on the rear panel. If necessary, change the fuse. See Figure 3.
- c. Connect the equipment together as shown above.
- d. Connect the Power Cable to the power outlet and Power Module receptacles. Press the LINE switch and release. The switch should remain in, the lamp within the plastic lens should be illuminated, and the cursor on the curved portion of the switch should indicate ON.

POWER METER PERFORMANCE TEST AND ADJUSTMENTS

- e. Refer to the Power Meter manual for Performance Test and Adjustment Procedures.

POWER METER TROUBLESHOOTING

- f. The 11683A may be used as a test signal source which is capable of a full scale meter reading in any range. The POLARITY switch increases the ease of Auto-Zero circuit troubleshooting, and the 11683A may be substituted for the Power Sensor in order to isolate a malfunction to the Power Meter/Power Sensor Cable or the Power Sensor. Troubleshooting information is found in Section VIII of the Power Meter Operating and Service Manual.

Figure 7. 11683A Operating Instructions

37. RANGE SWITCH PERFORMANCE TEST

38. The range-to-range accuracy of the 11683A Range Switch is checked to ensure a full-scale meter reading will be obtained when the 11683A and Power Meter Range Switches are set to the same scale.

39. Description. Voltage and resistance measurements are made at the rear panel output jack. Voltage measurements are made on the higher ranges. Because precise low voltage measurements are more difficult to make, resistance measurements are made at the lower RANGE switch settings. To achieve the needed accuracy, the four-wire resistance measurement technique is used.

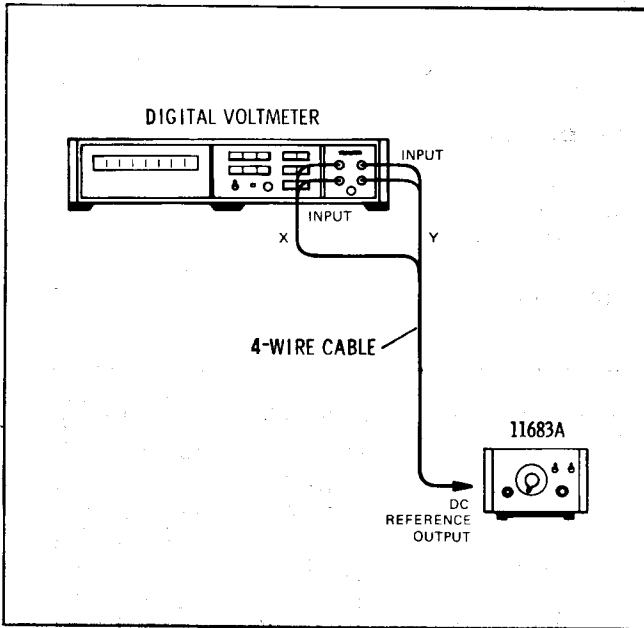

Figure 8. Range Switch Performance Test Setup

40. Equipment. Recommended equipment for performing these tests and adjustments are a digital voltmeter, HP 3455A, and a 4-wire cable for performing the resistance measurements (refer to Table 2).

NOTE

The 4-wire cable must connect directly to the 11683A. Do not use connectors or adaptors because their series resistance will reduce measurement accuracy.

41. Procedure.

a. Set the 11683A controls as follows:

RANGE 100 mW
 FUNCTION STANDBY
 POLARITY NORMAL

b. Set the DVM controls so measurements of up to +20 Vdc may be made. All measurements are to be 5-digit resolution.

c. Connect the equipment together as shown in Figure 8.

d. Set the 11683A FUNCTION control to CALIBRATE. On the table, record the dc voltage measured in each RANGE from 100 mW to 300 μW. If the voltage measured at the 1 mW range is beyond the limits shown on the table, when this procedure is completed, perform the Power Supply Adjustments. Calculate and record the ratio of the voltages using the formula shown in the table below.

Range	DVM Reading			Ratio ($V_{100\text{ mW}} / V_{\text{range}}$)		
	Min.	Actual	Max.	Min.	Actual	Max.
100 mW		_____		-----	1.0000	-----
30 mW		_____		3.3457	_____	3.3604
10 mW		_____		10.768	_____	10.815
3 mW		_____		34.394	_____	34.545
1 mW	143.00mVdc	_____	147.00mVdc	108.76	_____	109.23
300 mW		_____		343.95	_____	345.45

e. Set the 11683A FUNCTION switch to STANDBY. Set the DVM controls to measure resistance.

f. Measure the resistance at each RANGE setting from 300 to 3 μ W to 5-digit resolution and record the reading on the table below. Verify that each reading falls within the limits shown.

Range	DVM Reading (Ohms)		
	Min.	Actual	Max.
300 μ W	3143.3	_____	3157.1
100 μ W	995.90	_____	1000.2
30 μ W	315.14	_____	316.52
10 μ W	99.749	_____	100.18
3 μ W	31.580	_____	31.718

g. If any of the voltage ratios or resistance readings are incorrect, refer to the troubleshooting information.

42. ADJUSTMENTS

WARNING

The operations in this section require the instrument is operated with its covers removed and should only be carried out by qualified service personnel.

43. Power Supply Adjustment

44. The dc output of the 11683A is set to a specified level to ensure Power Meter full-scale deflection occurs when the RANGE controls of the Calibrator and Power Meter are set to the same scale.

45. Description. The 11683A RANGE switch is set to the 1 mW scale and the dc voltage at the rear panel D.C. REFERENCE OUTPUT is set to a specified level.

46. Equipment. The HP Model 3455A is the recommended Digital Voltmeter used to set the power supply voltage. A DVM that meets or exceeds the critical specifications of Table 2 may be substituted.

47. Procedure.

1. Connect the 11683A rear panel DC REFERENCE OUTPUT to the DVM INPUT.
2. Set the DVM controls to provide 5-digit resolution at 145 mVdc.
3. Remove the 11683A top cover.
4. Adjust A2R1 for a DVM reading of 145.00 \pm 2.00 mVdc.

48. FET BALANCE ADJUSTMENT

49. The sampling gate balance is affected by the relative positions of the wires in the Power Sensor which connect to pins G and H of connector A3J1. One wire is black and white, and the other is brown and white. Once positioned, care must be used not to displace these wires.

NOTE

This procedure normally will have to be performed only when the U1 assembly is replaced or if the white/black or white/brown wires which connect A3A1 to A3J1 are moved since their relative position is critical.

50. Equipment. The HP Model 180C/1801A/1821A is the recommended oscilloscope for use in the balance adjustment. An oscilloscope that meets or exceeds the critical specifications for Table 2 may be substituted.

51. Procedure

a. Remove the A3 Assembly (refer to the paragraph Disassembly of the A3 Sampling Gate assembly, under the heading Repair). Reinstall the LINE and A1 RANGE switch in the front panel before proceeding.

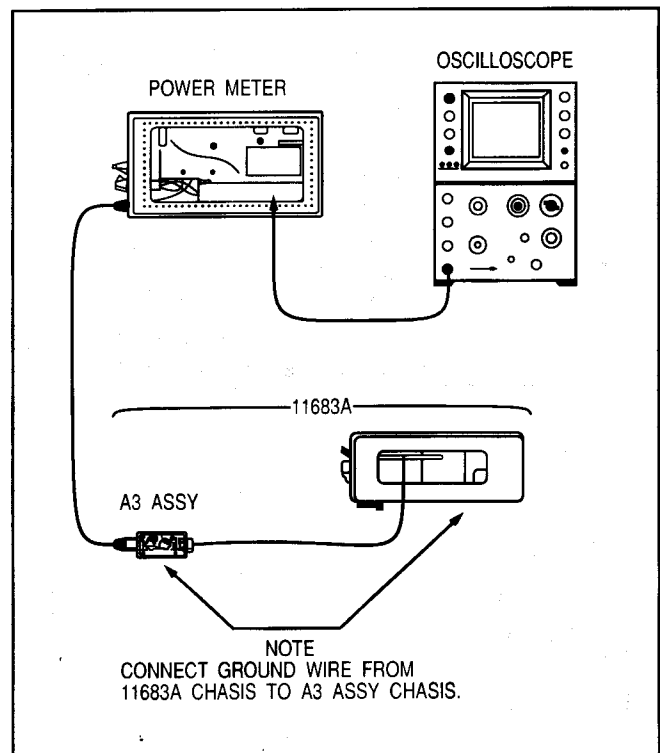

Figure 9. FET Balance Adjustment Setup

b. Connect the equipment as shown in Figure 9. The oscilloscope probe will be coupled to A4TP4 in the HP 435A Power Meter or A2TPAC in the 436A Power Meter.

c. Set the 11683A FUNCTION switch to STANDBY; the Power Meter RANGE switch to $3 \mu\text{W}$.

d. Press the Power Meter ZERO switch while monitoring the Oscilloscope for the switching transient (spike) waveform. Adjust the position of the black/white and brown/white wires until the amplitude is less than 1.0 Vp-p.

NOTE

The Power Meter ZERO Switch must be pressed for the duration of this adjustment procedure.

52. REPLACEABLE PARTS

53. Table 3 lists all replaceable parts in reference designator order. Table 4 contains the names and addresses that correspond to manufacturer's code numbers.

54. Replaceable Parts List

55. Table 3 is the list of replaceable parts and is organized as follows:

a. Electrical Assemblies and their components in alphanumeric order by reference designation.

b. Chassis-mounted parts in alpha-numerical order by reference designation.

c. Miscellaneous parts.

d. Illustrated parts breakdowns.

The information given for each part consists of the following:

a. The Hewlett-Packard part number.

b. Check digit (CD).

c. The total quantity (Qty) in the instrument.

d. The description of the part.

e. A typical manufacturer of the part in a five-digit code.

f. The manufacturer's number for the part.

The total quantity for each part is given only once -- at the first appearance of the part number in the list.

56. Ordering Information

57. To order a part listed in the replaceable parts table, quote the Hewlett-Packard part number, indicate the quantity required, and address the order to the nearest Hewlett-Packard office.

58. To order a part that is not listed in the replaceable parts table, include the instrument model number, instrument serial number, the description and function of the part, and the number of parts required. Address the order to the nearest Hewlett-Packard office.

Table 3. Replaceable Parts

Reference Designation	HP Part Number	C D	Qty	Description	Mfr Code	Mfr Part Number
A1	11683-60005	5	1	RANGE SWITCH ASSEMBLY (SEE MP8)	28480	11683-60005
A1R1	0811-0570	0	1	RESISTOR 196K .1X .05M PWH TC0+10	20940	140-1/8-D-1963-B
A1R2	0811-0571	1	1	RESISTOR 363.3K .1X .05M PWH TC0+10	20940	140-1/8-D-36332-B
A1R3	0811-0572	2	1	RESISTOR 548.5K .1X .125M PWH TC0+10	28480	0811-0572
A1R4	0811-0573	3	1	RESISTOR 139.8K .1X .05M PWH TC0+10	20940	140-1/8-D-13982-B
A1R5	0811-0574	4	1	RESISTOR 26.88K .1X .05M PWH TC0+10	20940	140-1/8-D-26881-B
A1R6	0811-0575	5	1	RESISTOR 7.309K .1X .05M PWH TC0+10	20940	140-1/8-D-7309-B
A1R7	0811-0576	6	1	RESISTOR 2.207K .1X .05M PWH TC0+10	20940	140-1/8-D-2207-B
A1R8	0811-0578	8	1	RESISTOR 687.7 .1X .05M PWH TC0+10	20940	140-1/8-D-6877-B
A1R9	0811-0579	9	1	RESISTOR 216.4 .1X .05M PWH TC0+10	20940	140-1/8-D-2164-B
A1R10	0811-0577	7	1	RESISTOR 68.38 .1X .05M PWH TC0+10	20940	140-1/8-D-6838-B
A1R11	0811-3214	5	1	RESISTOR 31.62 .1X .05M PWH TC0+10	14140	140-1/40-3162-B
A181	3100-3211	8	1	SWITCH-ROTARY 1.250 STRUT CTR SPCG; 10	28480	3100-3211
A2	11683-60001	1	1	POWER SUPPLY ASSEMBLY	28480	11683-60001
A2C1	0180-0141	2	1	CAPACITOR-FXD 50UF+75-10% 50VDC AL	56289	30D506050DD2
A2C2	0160-2204	0	1	CAPACITOR-FXD 100PF +-3% 300VDC MICA	28480	0160-2204
A2CR1	1901-0328	8	4	DIODE-PWR RECT 400V 1A 6UB	03508	A14D
A2CR2	1901-0328	8		DIODE-PWR RECT 400V 1A 6UB	03508	A14D
A2CR3	1901-0328	8		DIODE-PWR RECT 400V 1A 6UB	03508	A14D
A2CR4	1901-0328	8		DIODE-PWR RECT 400V 1A 6UB	03508	A14D
A2R1	2100-1788	9	1	RESISTOR-TMR 500 10% C TOP-ADJ 1-TMR	73138	82PR500
A2R2	0698-3433	8	1	RESISTOR 28.7 1X .125M F TC0+100	03888	PME55-1/8-T0-287-F
A2R3	0698-3151	7	1	RESISTOR 2.87K 1X .125M F TC0+100	24546	CA-1/8-T0-2871-F
A2R4	0698-3150	6	1	RESISTOR 2.37K 1X .125M F TC0+100	24546	CA-1/8-T0-2371-F
A281	3101-0554	8	1	SWITCH-TGL SUBMIN DPDT .02A 20VAC/DC PC (SEE MP4, MP9)	28480	3101-0554
A282	3101-0553	7	1	SWITCH-TGL SUBMIN SPDT .02A 20VAC/DC PC (SEE MP4, MP9)	28480	3101-0553
A2U1	1826-0177	5	1	V RGLTR TO-100	15818	723BE
A3	11683-60009	8	1	SAMPLING GATE ASSEMBLY	28480	11683-60009
A3C1	0160-2357	4	1	CAPACITOR-FDTHRU 1000PF +80 -20% 500V	28480	0160-2357
A3J1	08481-60024	7	1	CONNECTOR- 12 CONTACT (SEE A3MP4)	28480	08481-60024
A3MP1	0470-0231	6	1	ADHESIVE LOCTITE 242 POLYESTER 1P BLE	05972	242
A3MP2	0516-0009	4	1	SCREW-MACH 0-80 .312-IN-LG 82 DEG	00000	ORDER BY DESCRIPTION
A3MP3	3030-0436	4	1	SCREW-SKT HD CAP 0-80 .5-IN-LG 88T=300	00000	ORDER BY DESCRIPTION
A3MP4	1251-3363	8	1	NUT,CONN,RND SPANNER NUT,AUDIO TYPE CONN (USED WITH A3J1)	28480	1251-3363
A3MP5	1460-1978	0	1	SPRING-CPRSN .088-IN-OD .188-IN-OA-LG	28480	1460-1978
A3MP6	3030-0952	9	8	SCREW-SET 1/4-20, 2-IN-LG CUP-PT STL.	00000	ORDER BY DESCRIPTION
A3MP7	08481-00002	5	2	SHIELD	28480	08481-00002
A3MP8	08481-20011	8	2	CHASSIS	28480	08481-20011
A3MP9	5040-6939	7	1	CLAMP	28480	5040-6939
A3MP10	5040-6940	0	1	WLOCK	28480	5040-6940
A3MP11	11683-00003	7	1	PANEL, FRONT, SUB	28480	11683-00003
A3MP12	08484-20020	2	1	FLANGE, FRONT	28480	08484-20020
A3MP13	11683-20004	0	1	ENDBELL, FEED-THRU	28480	11683-20004
A3MP14	11683-20005	1	1	SHELL, PLASTIC	28480	11683-20005
A3R1	0698-7219	6	1	RESISTOR 196 1X .05M F TC0+100	24546	C3-1/8-T0-196R-G
A3A1	08481-60025	8	1	BOARD ASSEMBLY, POWER SENSOR (FOR 8481A ONLY)	28480	08481-60025
A3A1C1	0180-2515	8	2	CAPACITOR-FXD 47UF+-20% 6VDC 1A	28480	0180-2515
A3A1C2	0160-4306	7	4	CAPACITOR-FXD 100PF +-10% 100VDC CER	51959	0805C101K3P
A3A1C3	0160-4306	7		CAPACITOR-FXD 100PF +-10% 100VDC CER	51959	0805C101K3P
A3A1C4	0180-0594	9	1	CAPACITOR-FXD 3.3UF+-20% 15VDC 1A	14433	TA0-10-3.3/16-20
A3A1C5	0160-3094	8	1	CAPACITOR-FXD .1UF +-10% 100VDC CER	28480	0160-3094
A3A1C6	0160-3879	7	1	CAPACITOR-FXD .01UF +-20% 100VDC CER	28480	0160-3879
A3A1C7	0160-4306	7		CAPACITOR-FXD 100PF +-10% 100VDC CER	51959	0805C101K3P
A3A1C8	0160-4306	7		CAPACITOR-FXD 100PF +-10% 100VDC CER	51959	0805C101K3P
A3A1C9	0180-2515	8		CAPACITOR-FXD 47UF+-20% 6VDC 1A	28480	0180-2515
A3A1C10	0180-2545	4	1	CAPACITOR-FXD 100UF+-20% 4VDC 1A	28480	0180-2545
A3A1U1	1454-0610	0	1	TRANSISTOR NPN SI TO-46 FT=60MHZ	28480	1454-0610
A3A1R1	0698-3260	9	1	RESISTOR 464K 1X .125M F TC0+100	28480	0698-3260

See introduction to this section for ordering information

Table 3. Replaceable Parts

Reference Designation	HP Part Number	C D	Qty	Description	Mfr Code	Mfr Part Number
A3A1R2	0698-7248	1	1	RESISTOR 3.16K 1% .05W F TC0+/-100	24546	C3=1/8-T0=3161-G
A3A1R3	0698-7224	3	1	RESISTOR 316 1% .05W F TC0+/-100	24546	C3=1/8-T0=316H-G
A3A1R4	0698-7236	7	1	RESISTOR 1K 1% .05W F TC0+/-100	24546	C3=1/8-T0=1001-G
A3A1RT1	0411-3210	1	1	RESISTOR 31.6 5% .05W PMW TC0+250+/-252	14140	1409-1/20-31R6-J
A3A1U1	1813-0060	8	1	IC TD-8	28480	1813-0060
				MISCELLANEOUS PARTS		
	0590-1040	1	1	THREADED INSERT-NUT 0-80 .06-LG SST	28480	0590-1040
	5040-6538	2	1	SPACER	28480	5040-6538
A4	0960-0443	1	1	POWER MODULE ASSEMBLY	28480	0960-0443
A4J1	0360-0514	5	8	TERMINAL	28480	0360-0514
A4J2	0360-0514	5		TERMINAL	28480	0360-0514
A4J3	0360-0514	5		TERMINAL	28480	0360-0514
A4J4	0360-0514	5		TERMINAL	28480	0360-0514
A4J5	0360-0514	5		TERMINAL	28480	0360-0514
A4J6	0360-0514	5		TERMINAL	28480	0360-0514
A4J7	0360-0514	5		TERMINAL	28480	0360-0514
A4J8	0360-0514	5		TERMINAL	28480	0360-0514
A4TB1	5020-8122	2	1	LINE VOLTAGE SELECTION CARD	28480	5020-8122
				CHASSIS PARTS		
D81	2140-0244	4	1	LAMP-GLOW A1M 135/105VDC 1.2MA T-2-BULB (PART OF 81)	00466	A1M
F1	2110-0027	8	1	FUSE .125A 250V 1.25X.25 UL (FOR 100/120 VAC OPERATION)	28480	2110-0027
F1	2110-0011	0	1	FUSE .062A 250V 1.25X.25 UL (FOR 220/240 VAC OPERATION)	28480	2110-0011
J1	1250-0083	1	1	CONNECTOR-RF BNC FEM 80L-HOLE-FR 50-OHM (SEE MP8)	28480	1250-0083
MP1	0360-1190	5	1	TERMINAL-BLDR LUG PL-MTG FOR-#3/8-SCR	28480	0360-1190
MP2	0370-2388	6	1	KNOB-BASE-BAR/SKT 1/2 JGK .25-IN-ID	28480	0370-2388
MP3	0590-1696	3	1	NUT-SHMET-J-TF 6-32-THD .017-IN-THK	28480	0590-1696
MP4	0590-0765	5	2	NUT-KNRLD-R 1/4-40-THD .078-IN-THK (USED WITH A281 AND A282)	28480	0590-0765
MP5	2190-0016	3	2	WASHER-LK INTL T 3/8 IN .377-IN-ID	28480	2190-0016
MP6	2190-0067	4	2	WASHER-LK INTL T 1/4 IN .256-IN-ID	28480	2190-0067
MP7	2360-0113	2	1	SCREEN-MACH 6-32 .25-IN-LG PAN-MD-POZI	00000	ORDER BY DESCRIPTION
MP8	2950-0043	6	2	NUT-HEX-DBL-CHAM 3/8-40-THD .094-IN-THK (USED WITH A1 AND J1)	00000	ORDER BY DESCRIPTION
MP9	2950-0052	9	2	NUT-HEX-DBL-CHAM 1/4-40-THD .062-IN-THK (USED WITH A281 AND A282)	00000	ORDER BY DESCRIPTION
MP10	11683-20007	8	1	SUPPORT, P.C. BOARD	28480	11683-20007
MP11	11683-00005	9	1	BRACKET, TRANSFORMER MOUNTING	28480	11683-00005
MP12	0590-0923	7	1	NUT-KNRLD-R 1/2-32-THD .125-IN-THK (PART OF 81)	00000	ORDER BY DESCRIPTION
MP13	3101-0559	3	1	CAP-PUSHBUTTON TRL MHT; BLK.ZIZ-ZAG (PART OF 81)	28480	3101-0559
MP14	11683-80001	3	1	LABEL-INFORMATION (LINE MODULE)	28480	0362-0063
P1	0362-0063	3	8	CONNECTOR-80L CONT QD18C-FEM	28480	0362-0063
P2	0362-0063	3		CONNECTOR-80L CONT QD18C-FEM	28480	0362-0063
P3	0362-0063	3		CONNECTOR-80L CONT QD18C-FEM	28480	0362-0063
P4	0362-0063	3		CONNECTOR-80L CONT QD18C-FEM	28480	0362-0063
P5	0362-0063	3		CONNECTOR-80L CONT QD18C-FEM	28480	0362-0063
P6	0362-0063	3		CONNECTOR-80L CONT QD18C-FEM	28480	0362-0063
P7	0362-0063	3		CONNECTOR-80L CONT QD18C-FEM	28480	0362-0063
P8	0362-0063	3		CONNECTOR-80L CONT QD18C-FEM	28480	0362-0063
R1	0757-0459	8	1	RESISTOR 56.2K 1% .125W F TC0+/-100 (PART OF W2)	24546	C6=1/8-T0=5622-F
S1	3101-1394	6	1	SWITCH-PB DPDT-DB ALTN 10.5A 250VAC (PART OF W2; INCL D81, MP12, MP13).	28480	3101-1394
T1	9100-0552	0	1	TRANSFORMER-POWER PRI: 100/115/230 V	28480	9100-0552
W1	8120-1378	1	1	CABLE ASSY 18AWG 3-CNDCT JGK-JKT	28480	8120-1378
W2	11683-80004	4	1	PRIMARY POWER CABLE (INCLUDES R1 AND S1)	28480	11683-80004

See introduction to this section for ordering information

Table 3. Replaceable Parts

Reference Designation	HP Part Number	C D	Qty	Description	Mfr Code	Mfr Part Number
CABINET PARTS (SEE FIGURE 10)						
1	2360-0182	5	2	SCREW-MACH 6-32 .312-IN-LG 82 DEG	00000	ORDER BY DESCRIPTION
2	11683-00007	7	2	COVER ASSEMBLY, TOP 5 X 8	28480	5060-8553
3	11683-00001	5	2	PANEL, REAR	28480	11683-00001
4	5060-0247	0	2	FRAME ASSEMBLY	28480	5060-0247
5	2360-0180	3	8	SCREW-MACH 6-32 .188-IN-LG 82 DEG	00000	ORDER BY DESCRIPTION
6	5000-8766	8	2	COVER, SIDE 3 X 8	28480	5000-8766
7	5000-8569	9	1	COVER, BOTTOM 5 X 8	28480	5000-8569
8	11683-00002	6	1	PANEL, FRONT	28480	11683-00002
9	5060-0727	1	2	FOOT ASSY	28480	5060-0727
10	1490-0031	7	1	TILT STAND 2,236-IN-W 4,438-IN-DA-LG 88T	28480	1490-0031

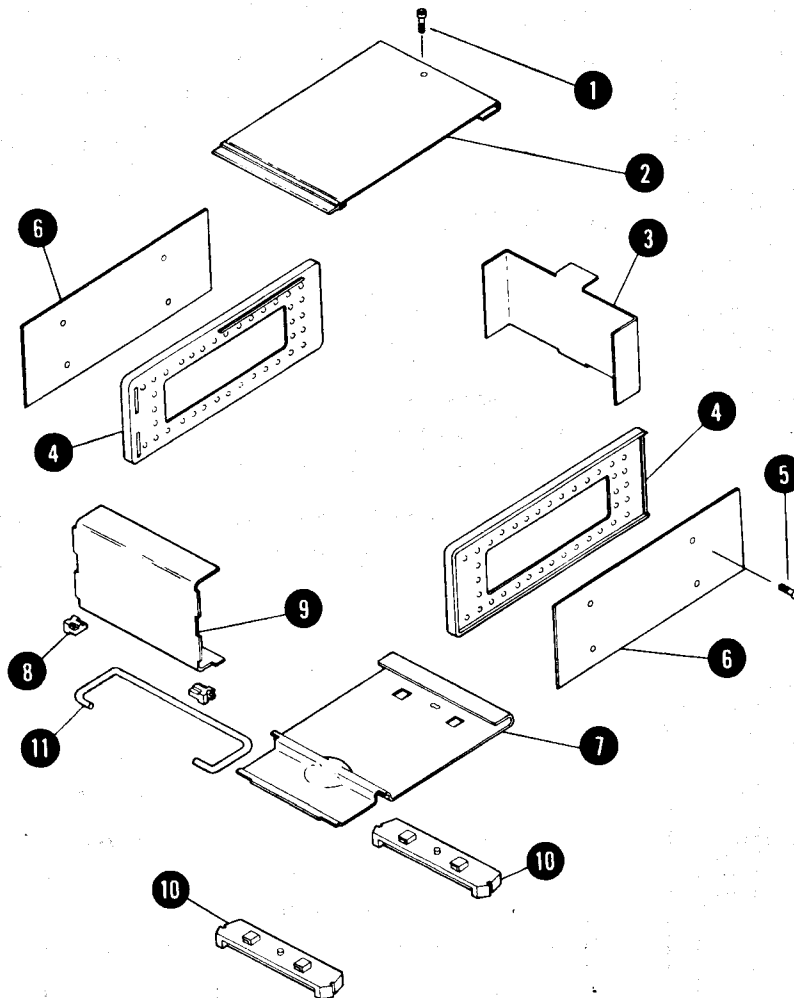

Figure 10. Cabinet Parts Exploded View

See introduction to this section for ordering information

Table 3. Replaceable Parts

Reference Designation	HP Part Number	C D	Qty	Description	Mfr Code	Mfr Part Number

Figure 11. A3 Assembly Exploded View

Table 4. Code List of Manufacturers

Mfr Code	Manufacturer Name	Address	Zip Code
00000	ANY SATISFACTORY SUPPLIER		
0046G	NORELCO NORTH AMER PHILIPS LYG CORP	LOS ANGELES CA	90021
03508	GE CO SEMICONDUCTOR PROD DEPT	SYRACUSE NY	13201
0388R	KODI PYROFILM CORP	WHIPPANY NJ	07981
04713	MOTOROLA SEMICONDUCTOR PRODUCTS	PHOENIX AZ	85062
05972	LOCTITE CORP	NEWINGTON CT	06111
14140	EDISON ELEK DIV MCGRAW-EDISON	MANCHESTER NH	03130
14433	ITT SEMICONDUCTORS DIV OF ITT CORP	PALM BEACH FL	33401
20940	MICRO-DHM CORP	EL MONTE CA	91731
24546	CORNING GLASS WORKS (BRADFORD)	BRADFORD PA	16701
28480	HEWLETT-PACKARD CO CORPORATE HQ	PALO ALTO CA	94304
51959	VICLAN INC	SAN DIEGO CA	92138
56289	SPRAGUE ELECTRIC CO	NORTH ADAMS MA	01247
7313R	BECKMAN INSTRUMENTS INC HELIPOT DIV	FULLERTON CA	92634

59. SERVICE

60. Service Information is composed of Repair, Principles of Operation, and Troubleshooting, followed by the assembly and component locations diagrams (Figure 13 and 15) and schematic diagrams (Figures 14 and 16).

61. Test equipment that meets or exceeds the critical specifications of Table 2 may be used in place of the recommended test instruments.

WARNING

The service information is often used with power supplied and protective covers removed from the instrument. Energy available at many points may, if contacted, result in personal injury or death.

62. Repair

63. The repair information includes instructions for removing and installing the A3 Sampling Gate Assembly, and proper installation of the A3A1 Board.

64. **Disassembly of A3 Sampling Gate Assembly.** For steps 1 through 3 see Figure 11. Refer to Figure 10 steps 4 through 8.

a. Remove the top, bottom, and side covers of the 11683A.

b. Remove the right-side frame which is adjacent to A2 and A3 assemblies after removing five 6-32 x 1/4" flat head machine screws.

c. Remove the RANGE switch knob after loosening the socket set screws. Remove the 3/8-32 x 7/16" hex nut from the RANGE switch; remove the RANGE SWITCH.

d. Remove the 1/2-32 knurled nut on the LINE switch and lift the A3 Assembly, which is attached only by the orange wire, from the 11683A chassis.

e. To remove the A3 Assembly plastic covers, insert the blade of a screwdriver into the seam on each side of the bulkhead feedthrough. Gently twist until the covers snap apart. Remove the covers and the magnetic shields.

f. Remove the two 0-80 x 0.312" flat-head machine screws which attach the sub-panel to the upper chassis.

g. Remove the two 0-80 x 0.188" socket cap screws which secure the feedthrough endbell to the upper chassis. Loosen the lower cap screws and remove the upper chassis.

h. To reassemble the A3 Assembly follow the preceding instructions in reverse order.

65. **A3A1 Assembly Installation.** The relative position of the installed circuit board and some components on the board are critical for proper operation.

a. Place the circuit board in the correct position and insert four 0-80 x 0.188" socket cap screws.

b. Center the circuit board so there is equal air gap between each side and the chassis. Tighten the cap screws.

66. Principles of Operation

67. The principles of operation are intended to give the user a basic understanding of circuit operation and is, therefore, the most important troubleshooting aid available.

68. **Power Supply.** The A4 Power Module Assembly contains the Line Voltage Selector Card which matches the line voltage to power transformer primary. A line filter reduces line surge and transients.

The A2 Power Supply Assembly contains a bridge rectifier A2CR1-4, filter capacitor A2C1, a packaged voltage regulator circuit A2U1, and its associated components.

Within the IC package is a reference voltage generator, an operational amplifier, regulator driver, series regulator, and current limiting transistors. The reference voltage output, pin 4, is coupled to the non-inverting operational amplifier input, pin 3. The amplifier output drives the regulator driver and series regulator transistors and the regulated output is coupled from the emitter, through the current sense resistor A2R2, to the POLARITY switch A2S1. A2R3, R1, and R4 form

a voltage divider through which the feedback bias is coupled to A2U1 pin 2, the inverting input.

If the current flow through A2R2 exceeds 20 mA, the current limiting transistor is turned-on and the drive voltage to the regulator driver is reduced which drops the regulated voltage toward zero.

A2C2 provides high frequency rolloff which reduces the feedback loop tendency to support spurious oscillations.

69. A1 Range Switch Assembly. The Range switch is a voltage divider which changes the output voltage by a factor of approximately $\sqrt{10}$ for each sequential range change.

70. A3 Sampling Gate Assembly. The dc input from the Range Switch assembly is divided by one thousand and is coupled to the A3A1U1 Sampling Gate circuit. A 220 Hz squarewave drive signal from the Power Meter is coupled to the FET gates. When A3A1U1Q1 is conducting, the dc input is coupled to the Input Amplifier A3A1Q1. When A3A1U1A2 is conducting, the input to the amplifier is essentially ground. The signal coupled to the Input Amplifier is 220 Hz ac, with the amplitude directly proportional to the dc input level.

The Input Amplifier and the first amplifier in the Power Meter are the component parts of a Hybrid Operational Amplifier. The Amplifier, which has a gain of approximately 730, is shown in Figure 12.

71. Troubleshooting

72. The Troubleshooting information is intended to supplement the principles of operation and schematics. This information should reduce troubleshooting time and increase the ease of solving problems that do not have obvious answers.

73. Power Supplies. If the output noise level has increased and the dc voltage at A2U1 pin 8 has decreased slightly, one of the bridge rectifier diodes or A2C1 may be defective.

If the output voltage has decreased, 0.6 Vdc measured across A2R2 indicates the current limiter is operating.

Measure the voltage on A2U1 pins 2 and 3. If the voltage difference is >10 mVdc, verify that the

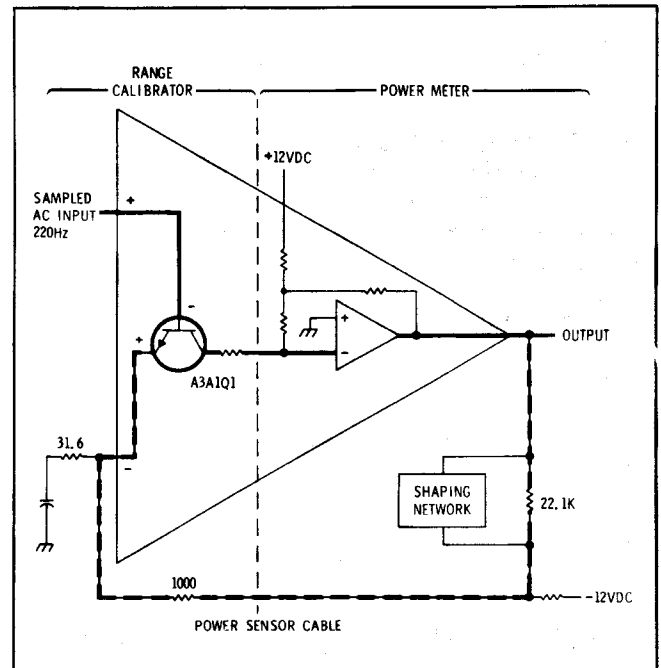

Figure 12. Hybrid Operational Amplifier

regulated output has correctly followed the change in input levels. The regulated output's relative change from normal should follow the non-inverting input change and be opposite to the inverting input change. If the preceding statement is not true, the integrated circuit is probably defective, otherwise, the problem is probably with the associated components of A2U1.

74. A1 Range Switch Assembly. Voltages and/or, resistance measurements, taken while performing the Range Switch Performance Test, may be out of the specified tolerances. This may be due to a definite change-in-resistance of one of the resistors mounted on the switch, high resistance contacts on the FUNCTION or RANGE switches, or a soldered connection which exhibits high resistance.

75. A3 Sampling Gate Assembly. The input to the A3 assembly is normally +15.8 mVdc with the RANGE switch set to a 100 mW.

NOTE

The following instructions apply after the A3A1 Circuit Board Assembly has been exposed. Refer to Disassembly of A3 Sampling Gate Assembly.

The multivibrator drive from the Power Meter to the FET Sampling Gate circuit may be checked on pins 4 or 6 of U1. This drive voltage is a 220 Hz square wave whose most positive level is

-0.05 ± 0.05 Vdc with the most negative level $> 9V$ more negative.

In most cases it may be assumed that the operational amplifier, made up of the Input Amplifier and the first amplifier in the Power Meter, is operating correctly if the dc voltage found on the metal cover of A3A1Q1 is -70 ± 30 mVdc.

The FET's in A3A1U1 may be checked by the following procedure:

- a. Disconnect the cables from the 11683A.
- b. Remove the upper chassis from the A3 assembly. (Refer to disassembly procedures.)
- c. Measure the resistance between pins 1 and 2 of the A3A1U1. The resistance should be 15 ± 0.75 ohms. The same resistance should be found between pins 8 and 9 of A3A1U1.

d. Short pins 4, 6, and 9 of A3A1U1. While the pins are shorted, measure the resistance between pins 2 and 3, and between pins 3 and 8, of A3A1U1. The resistance should be less than 40 ohms.

e. Set a power supply to 10 Vdc.

f. Connect the positive side of the power source to A3J1 pin E signal ground. Connect the negative power supply lead to pins 4 and 6 of A3A1U1.

g. Measure the resistance between pins 2 and 3 of A3A1U1. Also measure the resistance between pins 3 and 8 of A3A1U1. In both cases, the resistance should be several hundred times the resistance found in step d.

If A3A1U1 is replaced it is recommended that the FET BALANCE ADJUSTMENT be performed to ensure the 11683A is operating at maximum capability.

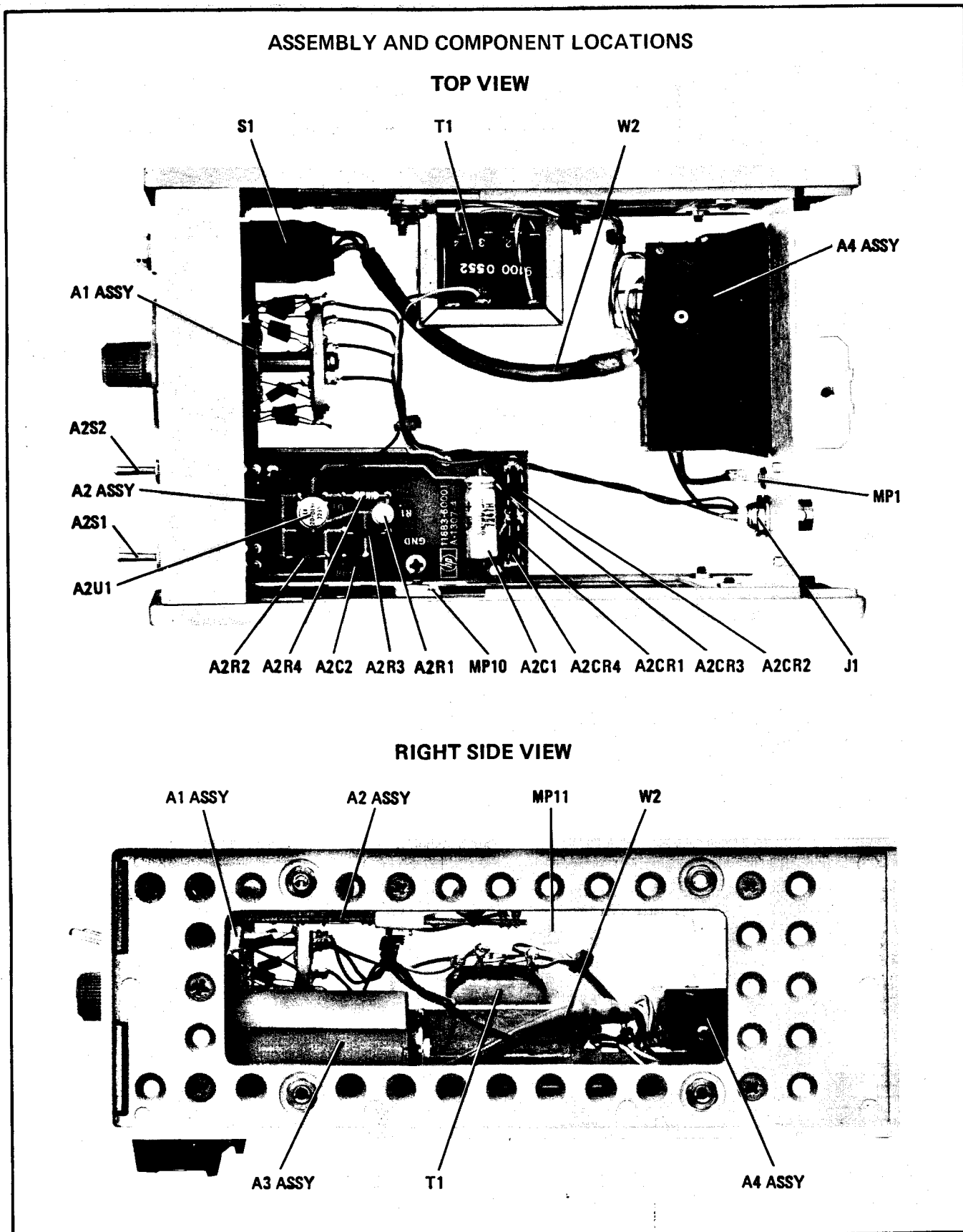

Figure 13. 11683A Assembly and Component Locations

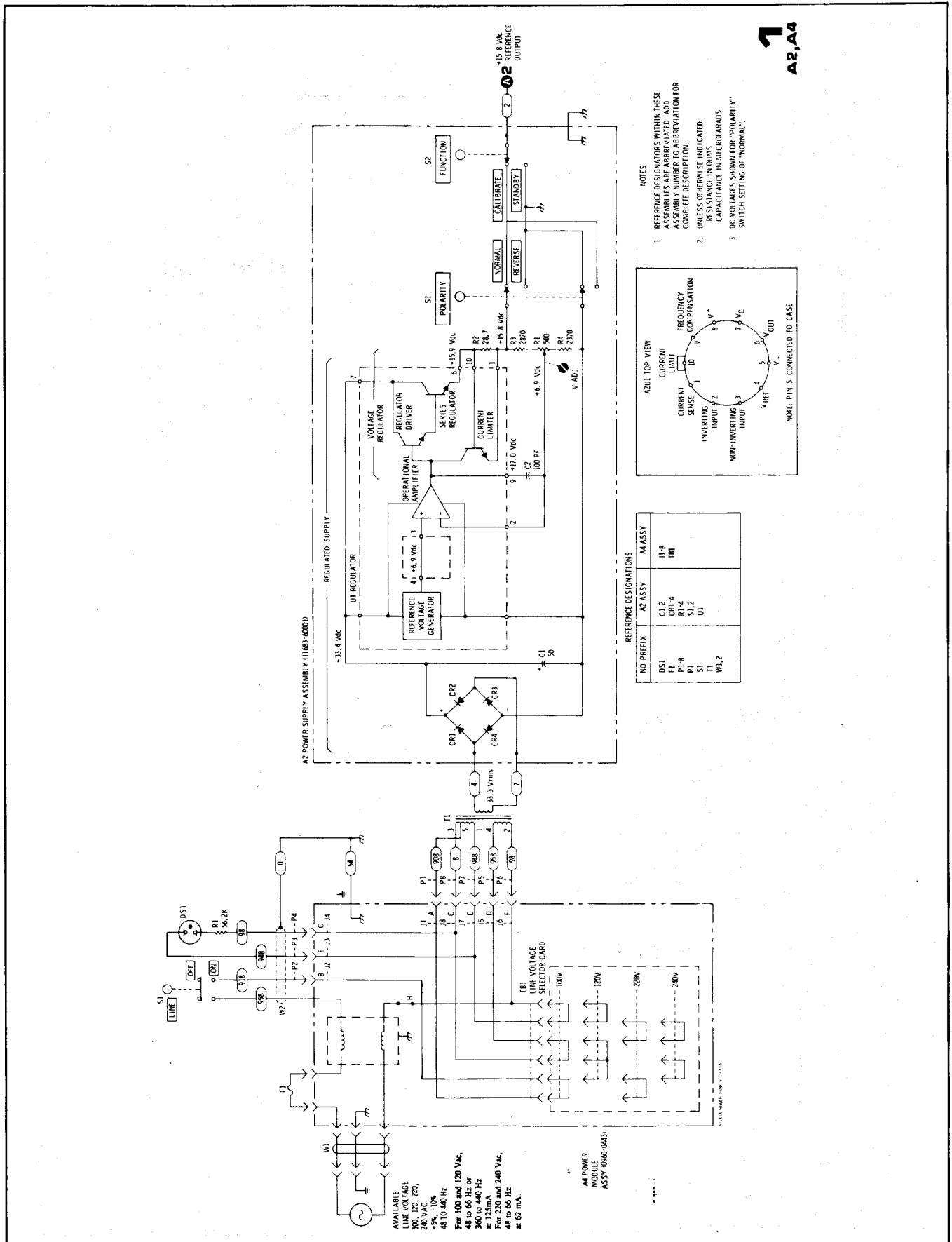
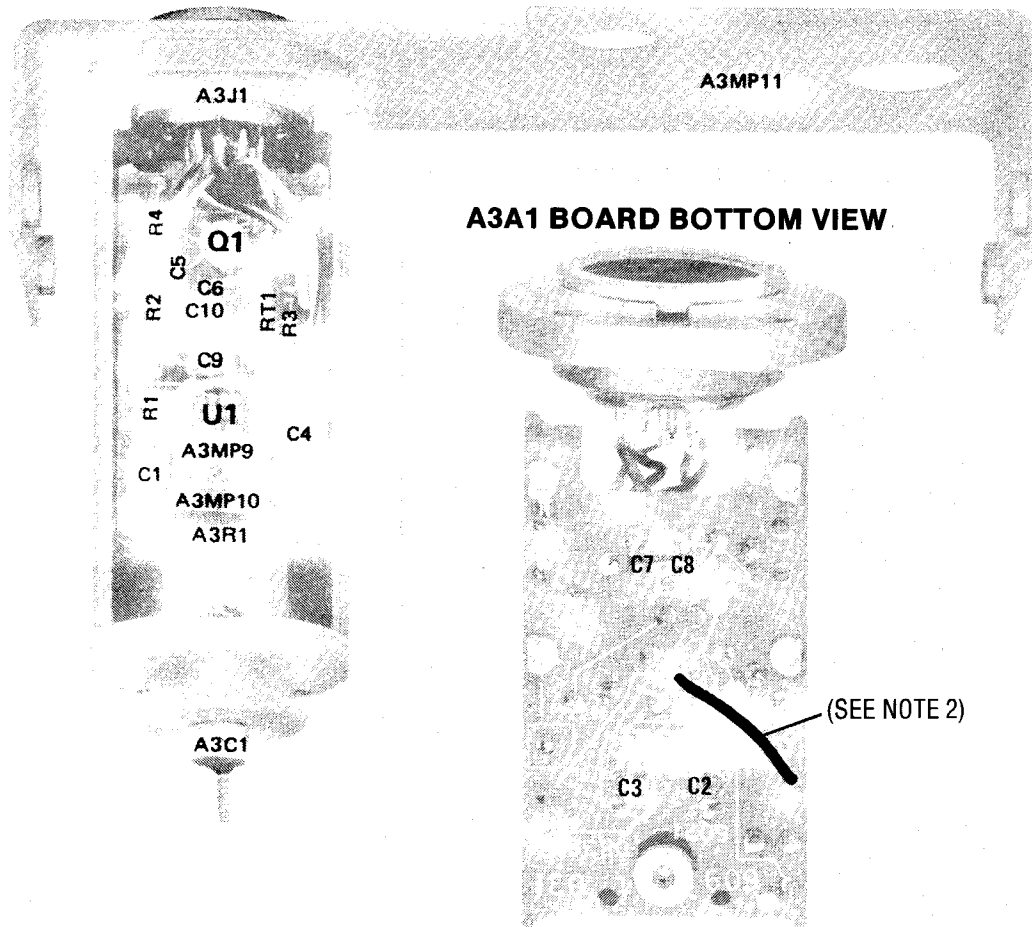

Figure 14. Power Supply Schematic Diagram

A3 ASSEMBLY COMPONENT LOCATIONS

A3 ASSEMBLY TOP VIEW



NOTE 1: A3 COMPONENT REFERENCE DESIGNATIONS ARE PRECEDED BY "A3". ALL OTHER COMPONENTS ARE PART OF THE A3A1 BOARD.

NOTE 2: WHEN THE A3A1 ASSEMBLY IS REPLACED AN INSULATED JUMPER WIRE MUST BE ADDED BETWEEN GUARD AND SIGNAL GROUND.

Figure 15. A3 Assembly Component Locations

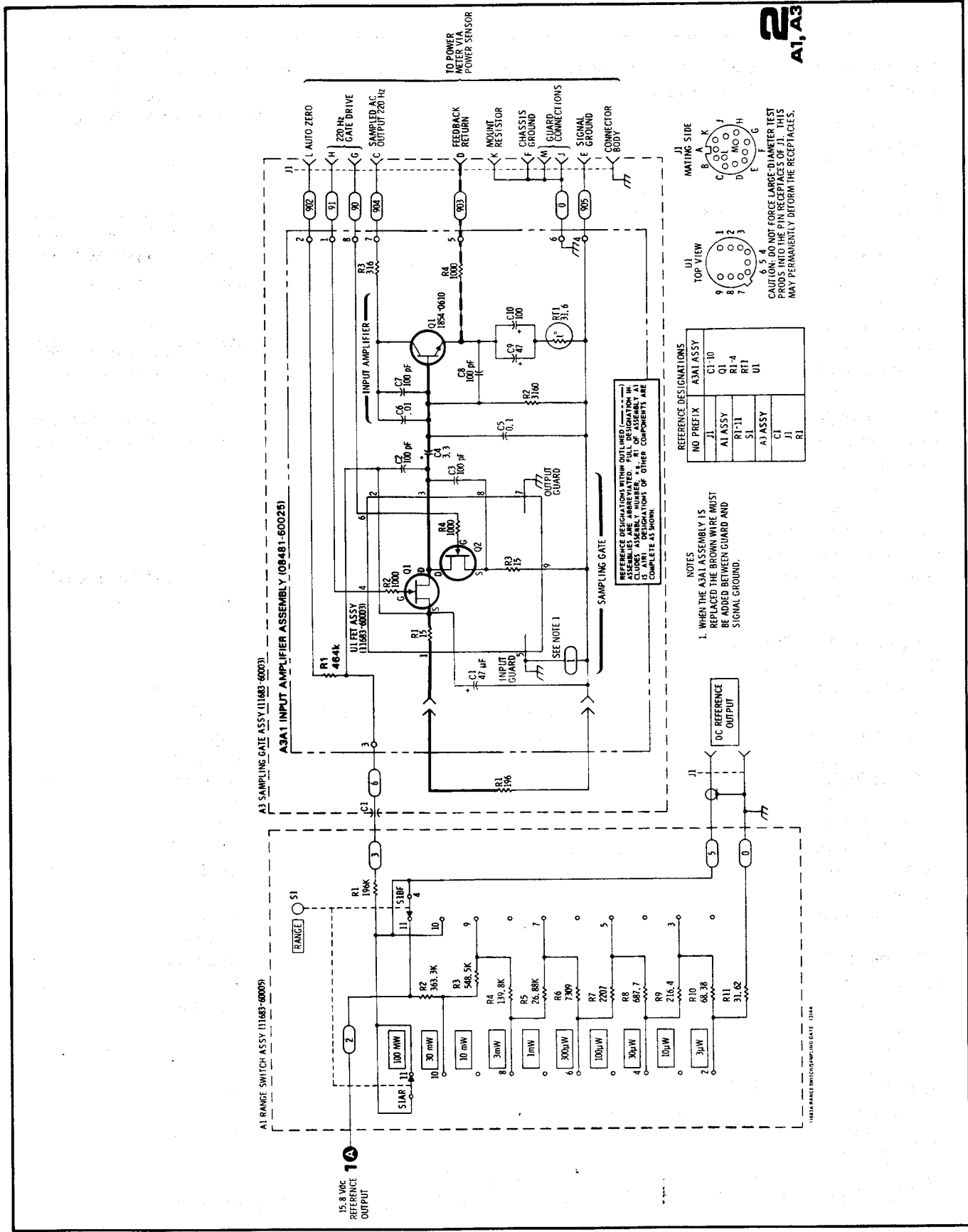

Figure 16. Range Switch/Sampling Gate Schematic Diagram

MANUAL CHANGES

APPENDIX

This appendix contains backdating information which makes this manual applicable to instruments with serial number prefixes 1314A and 1551A.

CHANGES

Page 8:

Replace paragraphs 49 to 52 with the following (leave the note following paragraph 49):

49. A characteristic of an FET Sampling Gate circuit is transient spikes caused by an imbalance in gate-to-drain capacitance. The imbalance can be corrected by making the effective junction capacitance equal. A capacitor of correct value is coupled across the gate-to-drain leads of the active component with the lower junction capacitance. Other factors keep the transient from being eliminated completely, therefore, the amplitude is reduced to a minimum.

50. **Description.** Adequate FET gate-to-drain capacitance balance is achieved when the transient spike amplitude is found to be < 1.0 Vp-p at the appropriate test location (TP4 in the HP Model 435A). Solder the selected capacitor in place.

51. **Equipment.** The HP Model 180C/1801A/1821A is the recommended oscilloscope for use in the balance adjustment. An oscilloscope that meets or exceeds the critical specifications of Table 2 may be substituted.

52. Procedure.

a. Remove the A3 assembly (refer to the paragraph, Disassembly of the A3 Sampling Gate Assembly, under the heading Repair). Reinstall the LINE and A1 RANGE switch in the front panel before proceeding.

b. Connect the equipment as shown in Figure 9. (The oscilloscope probe will be coupled to TP4 if the HP 435A Power Meter is being used.)

c. Set the 11683A FUNCTION switch to STANDBY; the Power Meter RANGE switch to $3 \mu\text{W}$.

d. Press the 435A ZERO Switch and check the spike amplitude on the oscilloscope display. Remove A2C2 and replace it, in the same location, with the next higher value capacitor. A2C2 may be located in one of the two positions or it may be omitted; see Figure 13.

NOTE

The 435A ZERO switch must be pressed for the duration of this adjustment procedure.

e. If the spike amplitude decreases, continue to increase the capacitor value, in sequence, until the minimum spike amplitude (balance point) is found. The capacitor normally will not be >7 pF. After two or three capacitors are tried, if the spike amplitude is constant or increases, a smaller value capacitor may be tried. If the lowest value capacitor is reached without finding the balance point, remove the capacitor and check the spike amplitude. Next begin to insert capacitors, in sequence, in the other A2C2 location. When the spike amplitude of <1.0 Vp-p at the appropriate test point is found, the circuit is considered balanced and the capacitor may be soldered in place.

MANUAL CHANGES

CHANGES (Cont'd)

Page 10, Table 3:

Replace the A3 portion of the parts list with the following:

Table 3. Replaceable Parts

Reference Designation	HP Part Number	Qty	Description	Mfr Code	Mfr Part Number
A3	11683-60003	1	SAMPLING GATE ASSY	28480	11683-60003
A3C1	0160-2357	1	C:FXD CER FEED-THRU 1000 PF +80-20%	28480	0160-2357
A3J1	1251-3228	1	CONNECTOR:AUDIO, 12 FEMALE CONTACT (SEE A3MP4)	74868	91-T-3638
A3MP1	0470-0231	1	COMPOUND:NUT LOCKING	28480	0470-0231
A3MP2	0516-0009	4	SCREW:FLAT HD SLOT DR 0-80 X 0.312" LG	00000	080
A3MP3	0730-0436	1	SCREW:SOCKET CAP 0-80 X 0.500" LG	00000	080
A3MP4	1251-3363	1	NUT:CONNECTOR MOUNTING (USED WITH A3J1)	28480	1251-3363
A3MP5	1460-1330	1	SPRING:COMPRESSION 0.150"	28480	1460-1330
A3MP6	0030-0422	8	SCREW:SOCKET CAP 0-80 X 0.188" LG	00000	080
A3MP7	08481-0002	2	SHIELD	28480	08481-0002
A3MP8	08481-20011	2	CHASSIS	28480	08481-20011
A3MP9	08481-40003	1	SPACER F.E.T.	28480	08481-40003
A3MP10	08481-40004	1	CLAMP LEAD	28480	08481-40004
A3MP11	11683-00005	1	PANEL:FRONT, SUB	28480	11683-00005
A3MP12	11683-20003	1	ENDBELL:FRONT	28480	11683-20003
A3MP13	11683-20004	1	ENDBELL:FEED THRU	28480	11683-20004
A3MP14	11683-20005	2	SHELL:PLASTIC	28480	11683-20005
A3A1	0698-7219	1	R:FXD FLM 196 OHM 2% 1/8W	28480	0698-7219
A3A1	11683-60002	1	BOARD ASSY:SAMPLING GATE	28480	11683-60002
A3A1C1	0180-2515	2	C:FXD ELECT 47 UF	28480	0180-2515
A3A1C2	0160-3872	1	C:FXD CER 2.2 TO 0.25 PF 200VDCW FACTORY SELECTED PART	72982	8121-8226-CCG-229C
A3A1C3	0180-2515	1	C:FXD ELECT 47 UF	28480	0180-2515
A3A1C4	0160-3094	1	C:FXD CER 0.1 UF 10% 100VDCW	56285	2C18A1-CML
A3A1C5	0160-3879	1	C:FXD CER 0.01 UF 20% 100VDCW	72982	8121-8112-X7R-103M
A3A1C6	0180-2545	1	C:FXD ELECT 100 UF	28480	0180-2545
A3A101	1854-0610	1	TRANSISTOR:SI NPN	28480	1854-0610
A3A1R1	0698-3260	1	R:FXD MET FLM 464K OHM 1% 1/8W	28480	0698-3260
A3A1R2	0698-7248	1	R:FXD FLM 3.16K OHM 2% 1/8W	28480	0698-7248
A3A1R3	0698-7236	3	R:FXD FLM 1K OHM 2% 1/8W	28480	0698-7236
A3A1R4	0698-7236	1	R:FXD FLM 1K OHM 2% 1/8W	28480	0698-7236
A3A1R5	0757-0180	1	R:FXD MET FLM 31.6 OHM 1% 1/8W	28480	0757-0180
A3A1R6	0698-7224	1	R:FXD FLM 316 OHM 2% 1/8W	28480	0698-7224
A3A1R7	0698-7236	1	R:FXD FLM 1K OHM 2% 1/8W	28480	0698-7236
A3A2	08481-60002	1	FET ASSEMBLY	28480	08481-60002

MANUAL CHANGES

CHANGES (Cont'd)

Page 14, paragraph 65:

Add sub-paragraph c:

- c. Bend the 100 μ F capacitor, A3A1C6, so it touches A3A1Q1. Position A3A1C1 and A3A1C3 so they touch A3A1C6.

Page 14, 15:

Insert the following paragraphs and the Figure between paragraphs 65 and 66.

67. FET Assembly Removal

CAUTION

Excessive heat from the soldering iron when installing or removing the assembly may destroy the FET internal circuitry. Before removing the FET Assembly be sure that it must be replaced. The Troubleshooting information gives the correct procedures for verifying that the FET's are defective.

a. Remove the A3A1 Circuit Board Assembly. Refer to Disassembly of A3 Sampling Gate Assembly.

b. Remove the 0-80 x 0.500" cap screw, spring, clamp, and A3R1.

c. Remove the RTV coating which covers the FET pin connections to the printed circuit board.

d. With a desoldering tool, remove the solder from the six pins which hold the FET Assembly in place.

e. Carefully break each pin loose from the printed circuit board with a soldering aid tool.

f. Gently lift the FET Assembly and spacer from the circuit board. Refer to Figure 12.

68. FET Assembly Installation

a. Insert the FET Assembly leads through the spacer and printed circuit board. Refer to Figure A1.

b. Insert the clamp and cap screw to hold the spacer and assembly in place against the printed circuit boards.

c. Quickly solder the FET leads to the circuit board.

d. With hypodermic needle place RTV* into the hollow portion of the spacer. For this purpose the needle is inserted into the hole in the circuit board directly beneath the FET Assembly.

e. Cover the soldered connections from the FET Assembly with RTV*.

f. Cover the rest of the circuit side of the A2 assembly circuit board with Krylon**.

*RTV - 732 RTV Silicone Rubber Adhesive/Sealant by Dow Corning Corp., Midland, Michigan, 48640.

**Krylon - No. 1302 Humiseal Protective Coating, Type 1B12 by Columbia Technical Corp., Woodside 77, New York.

Krylon Inc., Norristown, Pennsylvania

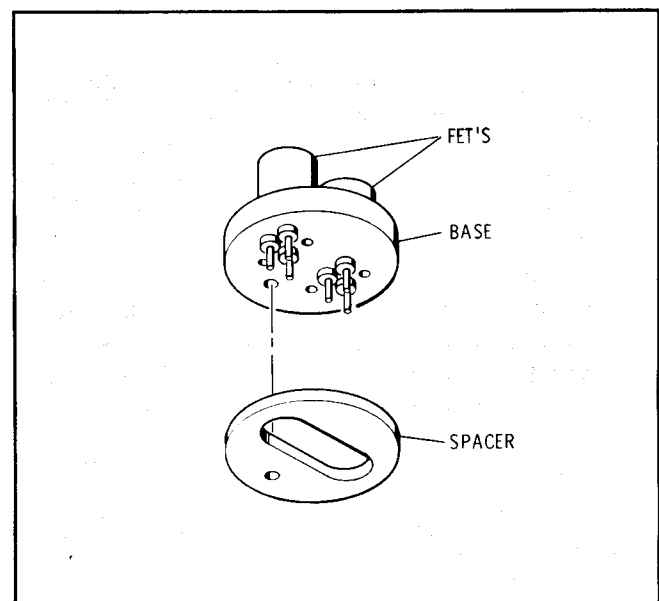

Figure A1. FET Assembly and Spacer

MANUAL CHANGES

CHANGES (Cont'd)

Page 20, Figure 15:

Replace Figure 15 with the one below:

A3 ASSEMBLY COMPONENT LOCATIONS

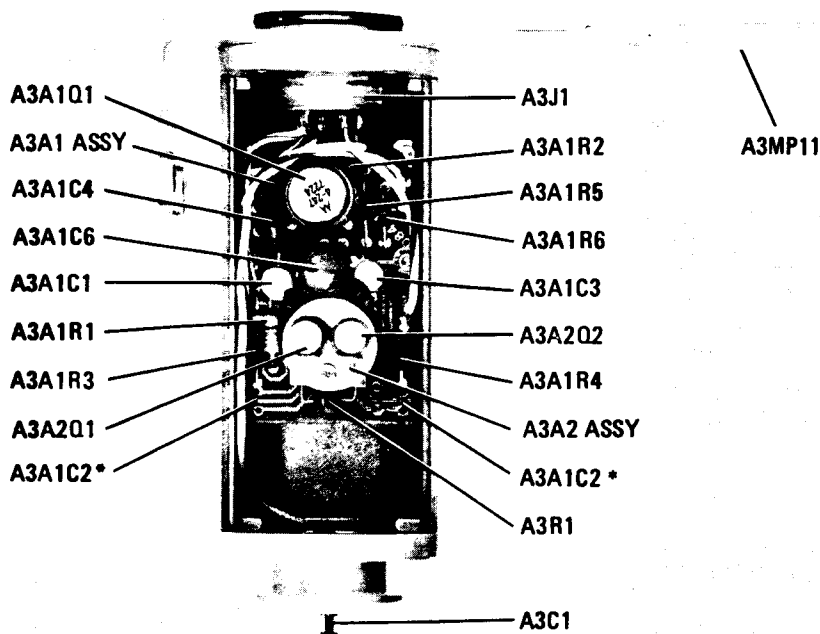
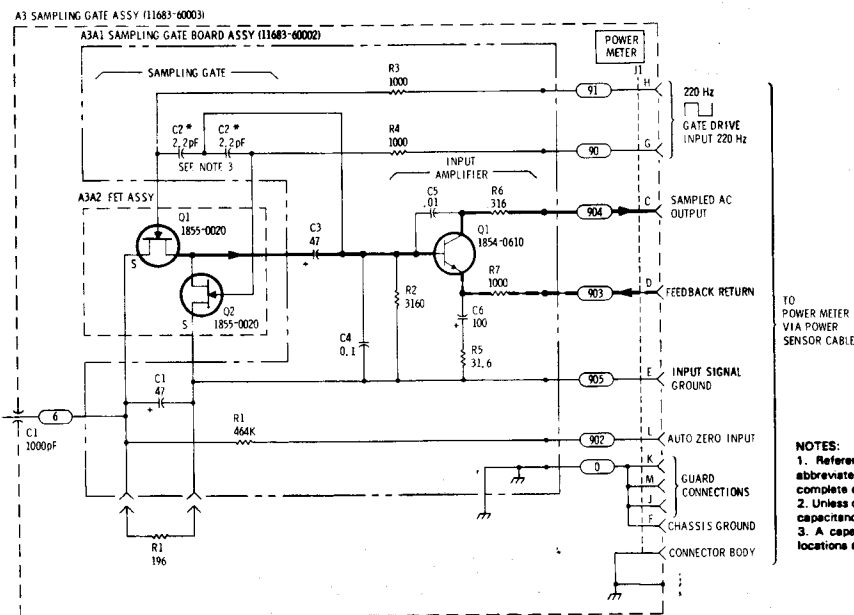

Figure A2. Assembly Component Locations

Page 21, Figure 16:

Replace the A3 portion of the schematic with the one below:



NOTES:
 1. Reference designations within this assembly are abbreviated. Add assembly number to abbreviation for complete designator.
 2. Unless otherwise indicated, resistance is in ohms and capacitance in microfarads.
 3. A capacitor may be found in only one of the two locations shown for A3A1C2 or it will be omitted.

Figure A3. Range Switch/Sampling Gate Schematic Diagram (P/O Figure 18)

Regional Sales and Support Offices

US FIELD OPERATIONS			
Headquarters Hewlett-Packard Co. 19320 Pruneridge Ave. Cupertino, CA 95014 (800) 752-0900	California, Northern Hewlett-Packard Co. 301 E. Evelyn Mountain View, CA 94041 (415) 694-2000	California, Southern Hewlett-Packard Co. 1421 South Manhattan Ave. Fullerton, CA 92631 (714) 999-6700	Colorado Hewlett-Packard Co. 24 Inverness Place, East Englewood, CO 80112 (303) 649-5512
Atlanta Annex Hewlett-Packard Co. 2124 Barrett Park Drive Kennesaw, GA 30144 (404) 648-0000	Illinois Hewlett-Packard Co. 5201 Tollview Drive Rolling Meadows, IL 60008 (708) 255-9800	New Jersey Hewlett-Packard Co. 150 Green Pond Rd. Rockaway, NJ 07866 (201) 586-5400	Texas Hewlett-Packard Co. 930 E. Campbell Rd. Richardson, TX 75081 (214) 231-6101
EUROPEAN FIELD OPERATIONS			
Headquarters Hewlett-Packard S.A. 150, Route du Nant-d'Avril 1217 Meyrin 2/Geneva Switzerland (41 22) 780.8111	France Hewlett-Packard France 1 Avenue Du Canada Zone D'Activite De Courtaboeuf F-91947 Les Ulis Cedex France (33 1) 69 82 60 60	Germany Hewlett-Packard GmbH Hewlett-Packard Strasse 61352 Bad Homburg v.d.H Germany (49 6172) 16-0	Great Britain Hewlett-Packard Ltd. Eskdale Road, Winnersh Triangle Wokingham, Berkshire RG41 5DZ England (44 1734) 696622
INTERCON FIELD OPERATIONS			
Headquarters Hewlett-Packard Company 3495 Deer Creek Road Palo Alto, California, USA 94304-1316 (415) 857-5027	Australia Hewlett-Packard Australia Ltd. 31-41 Joseph Street Blackburn, Victoria 3130 (61 3) 895-2895	Canada Hewlett-Packard (Canada) Ltd. 17500 South Service Road Trans-Canada Highway Kirkland, Quebec H9J 2X8 Canada (514) 697-4232	China China Hewlett-Packard Company 38 Bei San Huan X1 Road Shuang Yu Shu HaiDian District Beijing, China (86 1) 256-6888
Japan Hewlett-Packard Japan, Ltd. 1-27-15 Yabe, Sagami-hara Kanagawa 229, Japan (81 427) 59-1311	Singapore Hewlett-Packard Singapore (Pte.) Ltd. 150 Beach Road #29-00 Gateway West Singapore 0718 (65) 291-9088	Taiwan Hewlett-Packard Taiwan 8th Floor, H-P Building 337 Fu Hsing North Road Taipei, Taiwan (886 2) 712-0404	