

Errata

Title & Document Type: 1402A Dual Trace Amplifier Operating and Service Manual

Manual Part Number: 01402-90903

Revision Date: March 1967

About this Manual

We've added this manual to the Agilent website in an effort to help you support your product. This manual provides the best information we could find. It may be incomplete or contain dated information, and the scan quality may not be ideal. If we find a better copy in the future, we will add it to the Agilent website.

HP References in this Manual

This manual may contain references to HP or Hewlett-Packard. Please note that Hewlett-Packard's former test and measurement, life sciences, and chemical analysis businesses are now part of Agilent Technologies. The HP XXXX referred to in this document is now the Agilent XXXX. For example, model number HP8648A is now model number Agilent 8648A. We have made no changes to this manual copy.

Support for Your Product

Agilent no longer sells or supports this product. You will find any other available product information on the Agilent Test & Measurement website:

www.agilent.com

Search for the model number of this product, and the resulting product page will guide you to any available information. Our service centers may be able to perform calibration if no repair parts are needed, but no other support from Agilent is available.

OPERATING AND SERVICE MANUAL

DUAL TRACE AMPLIFIER 1402A

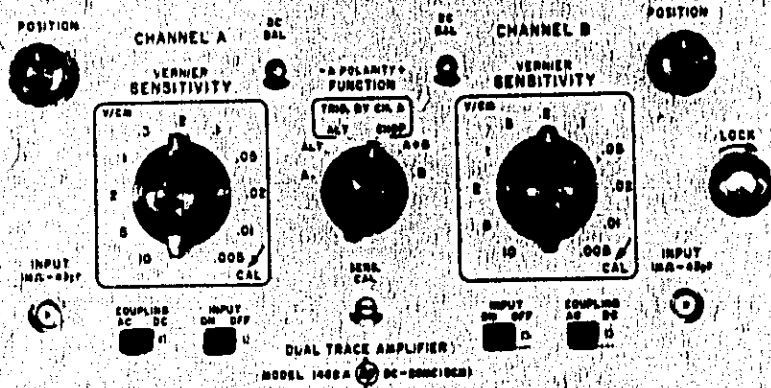

HEWLETT  PACKARD



OPERATING AND SERVICE MANUAL

H/P Part No. 01402-90903

**MODEL 1402A
DUAL TRACE AMPLIFIER**

SERIALS PREFIXED: 709-

(See Section I for instruments with
other Serial Prefixes.)

Copyright © HEWLETT-PACKARD COMPANY 1964
1501 PAGE MILL ROAD, PALO ALTO, CALIFORNIA, U.S.A.

TABLE OF CONTENTS

Section	Page	Section	Page
I GENERAL INFORMATION	1-1	V MAINTENANCE	5-1
1-1. Description	1-1	5-1. Introduction	5-1
1-5. Probes	1-1	5-3. Performance Check	5-1
1-7. Manual Identification and Changes	1-1	5-5. Test Equipment	5-1
1-9. Scope of Manual	1-1	5-7. Procedure	5-1
II INSTALLATION	2-1	5-9. Common-Mode Rejection	5-1
2-1. Initial Inspection	2-1	5-10. Sensitivity	5-1
2-4. Claims and Repackaging	2-1	5-11. Bandwidth	5-1
2-7. Preparation for Use	2-2	5-12. Rise Time	5-2
III OPERATING INSTRUCTIONS	3-1	5-13. Adjustment	5-2
3-1. Introduction	3-1	5-17. Preliminary Procedure	5-2
3-3. Operating Procedures	3-1	5-19. DC Balance Adjustment	5-3
3-5. Modes of Presentation	3-1	5-21. Position Adjustment	5-3
3-14. Bandwidth	3-2	5-22. DC Level Adjustment	5-3
IV CIRCUIT DESCRIPTION	4-1	5-23. Sensitivity Adjustment	5-3
4-1. Overall Description	4-1	5-24. Input Capacity and Attenuator Compensation Adjustment	5-3
4-3. Circuit Details	4-1	5-25. High Frequency Adjustments	5-3
4-5. Channel A	4-1	5-26. Trigger Amplifier Balance	5-3
4-8. Switching Circuit	4-1	5-27. Troubleshooting	5-4
4-13. Output Amplifier	4-3	5-33. Adjustments Following Component Replacement	5-5
4-15. Trigger Amplifier	4-3	5-25. Servicing Etched Circuit Boards	5-5
4-17. Dual X-Y Switching	4-3	VI REPLACEABLE PARTS	6-1
APPENDIX I MANUAL CHANGES	IA-1	6-1. Introduction	6-1
		6-4. Ordering Information	6-1

LIST OF ILLUSTRATIONS

Number	Title	Page	Number	Title	Page
1-1.	Model 1402A Dual Trace Amplifier	1-0	5-6.	Channel A Amplifier Schematic Diagram	5-13
3-1.	Model 1402A Bandwidth	3-2	5-7.	Waveforms at Test Points in Channel B	5-14
3-2.	Controls and Connectors	3-3	5-8.	Channel B Amplifier Schematic Diagram	5-15
3-3.	DC Balance Adjustment	3-4	5-9.	Component Locations on Switching Circuit Board A2	5-16
3-4.	Sensitivity Calibration	3-5	5-10.	Waveforms at Test Points in Switching Circuit	5-16
3-5.	Single Channel Operation	3-6	5-11.	Switching Circuit Schematic Diagram	5-17
3-6.	Dual Trace Operation	3-7	5-12.	Waveforms at Test Points in Output Amplifier	5-18
3-7.	Algebraic Addition	3-8	5-13.	Component Locations on Output Amplifier Board A10 and Deck	5-18
3-8.	Dual X-Y Operation for Two Independent Displays	3-9	5-14.	Output Amplifier Schematic Diagram	5-19
4-1.	Model 1402A Block Diagram	4-0	5-15.	Component Locations on Trigger Amplifier Board A3	5-20
4-2.	Switching Circuit Simplified	4-2	5-16.	Waveforms at Test Points in Trigger Amplifier	5-20
5-1.	Location of Adjustments	5-2	5-17.	Trigger Amplifier Schematic Diagram	5-21
5-2.	Component Locations on Input Amplifier Board A9	5-8	5-18.	Interconnection Plug Schematic Diagram	5-22
5-3.	Component Locations on Channel A Sensitivity Switch	5-9			
5-4.	Component Locations on Channel B Sensitivity Switch	5-10			
5-5.	Waveforms at Test Points in Channel A	5-12			

LIST OF TABLES

Number	Title	Page	Number	Title	Page
1-1.	Specifications	1-0	5-7.	Adjustments Following Component Replacement	5-7
5-1.	Equipment Required for Tests and Adjustments	5-0	5-8.	Schematic Diagram Notes	5-11
5-2.	Sensitivity Check	5-1	5-9.	Conditions for Waveform Measurement in Channel A, Channel B, Output, and Trigger Amplifiers	5-12
5-3.	Attenuator Adjustment	5-3	6-1.	List of Reference Designators and Abbreviations	6-1
5-4.	Troubleshooting for Unbalance	5-4	6-2.	Replaceable Parts	6-2
5-5.	Switching Troubleshooting	5-5	6-3.	Code List of Manufacturers	6-10
5-6.	Switching Circuit Troubleshooting Voltages	5-6			

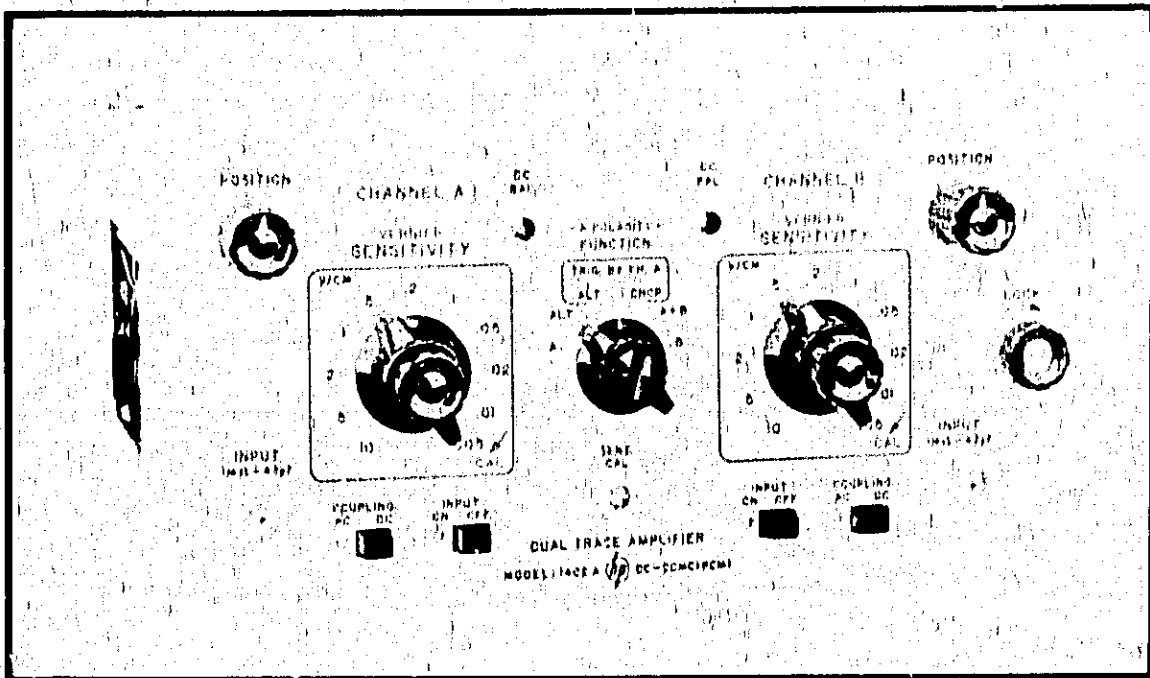

Figure 1-1. Model 1402A Dual Trace Amplifier

Table 1-1. Specifications

MODE OF OPERATION:

1. Channel A alone.
2. Channel B alone.
3. Channel A and Channel B displayed on alternate sweeps.
4. Channel A and Channel B displayed by switching at approximately 100 kc, with trace blanking during switching.
5. Channel A and Channel B added algebraically; polarity of Channel A may be inverted to obtain differential operation.

SENSITIVITY:

Each channel has sensitivities from 5 mv/cm to 10 v/cm in 11 calibrated ranges in a 1, 2, 5 sequence. Verter allows continuous adjustment between calibrated ranges and extends minimum sensitivity to at least 25 v/cm. Attenuator accuracy $\pm 3\%$.

BANDWIDTH: (6 cm reference signal)

DC coupled: dc to 20 mc.
AC coupled: 2 cps to 20 mc.

RISE TIME: Less than 20 nsec with 6 cm step input.

SIGNAL DELAY:

Signal is delayed so that leading edge of fast rise signals is visible at start of sweep.

COMMON MODE REJECTION:

(In B-A mode). At least 40 db on 5, 10, and 20 mv/cm ranges, at least 30 db on 50 mv/cm to 10 v/cm. Sine wave common mode signal not to exceed 150 cm (e.g., 150 volts on 1 v/cm range) or a frequency of 500 kc.

INPUT IMPEDANCE: 1 megohm shunted by 43 pf.

MAXIMUM INPUT:

600 volts (dc + peak ac).

WEIGHT: Net, 6 lbs. (2,7 kg). Shipping, 8 lbs. (3,6 kg).

POWER: Supplied by oscilloscope.

SECTION I

GENERAL INFORMATION

1-1. DESCRIPTION.

1-2. The $\frac{1}{2}$ Model 1402A Dual Trace Amplifier, Figure 1-1, is a 20-Mc DC-coupled amplifier plug-in unit which has been designed for use with $\frac{1}{2}$ Model 140-series oscilloscopes. It contains dual amplifying channels for amplification of two separate input signals, and a function control which determines the presentation of the signal on the screen of the oscilloscope cathode-ray tube. The amplified signals from the Model 1402A are applied directly to the deflection plates of the CRT. Power is supplied to the plug-in unit by the oscilloscope.

1-3. The Model 1402A provides the Model 140-series oscilloscopes with calibrated sensitivities from 5 millivolts per centimeter to 10 volts per centimeter. DC coupling is available at all sensitivities, with provision for AC coupling at the input. The Model 1402A may be used in either vertical or horizontal plug-in compartments of the Model 140A Oscilloscope, and sensitivity is the same horizontally as vertically. Front-panel gain adjustments are provided to calibrate the sensitivity for both amplifier channels. Frequency-compensated probes are available for use with the Model 1402A (see Paragraph 1-5).

1-4. In dual trace operation, the two signals are presented on the screen either on alternate sweeps of the time base (ALT) or alternately on the same sweep (CHOP) at a chopped rate of approximately 100 kc. Except for special cases such as single-shot high-speed phenomena, these two modes accommodate all dual-trace applications. Internal triggering uses the Channel A signal; optionally the combined signal may be selected for triggering in the ALT/alternate mode. In single trace operation, either one of the signals is presented while the opposite channel is switched off. Algebraic addition (A+B) presents the sum of the two input signals. Dual X-Y displays also are possible (see Figure 3-8).

1-5. PROBES.

1-6. Frequency-compensated probes are recommended for measuring in high impedance circuits, or for reducing signal voltage applied to the Model 1402A. The 10:1 Divider Probes, Model 10001A/B (30 Mc) and Model 10003A (50 Mc), provide an effective input impedance of 10 megohms shunted by 10 pf. The 50:1 Divider Probe, Model 10002A/B (30 Mc), provides an effective input impedance of 50 megohms shunted by 2.5 pf. The calibrator on the front panel of the oscilloscope provides a square wave which may be used for the probe compensation adjustment described in the Operating Note supplied with the Probe.

1-7. MANUAL IDENTIFICATION AND CHANGES.

1-8. Information in this manual applies directly to Model 1402A instruments with a serial prefix of 709- (see manual title page). The serial prefix of an $\frac{1}{2}$ instrument is the first three digits (i. e. those before the dash, as in 000-00000) of the serial number stamped on a plate attached to the rear panel. Appendix I, Manual Changes, provides information to adapt this manual to an instrument with any serial prefix lower than 709-. Serial prefixes of 525- and below are covered in another manual, hp Part No. 01402-09001. Any errors in this manual when it was printed are called Errata, and these corrections (if any) will appear on the separate change sheet included with this manual.

1-9. SCOPE OF MANUAL.

1-10. This manual supplies operating and maintenance instructions for the $\frac{1}{2}$ Model 1402A Dual Trace Amplifier. The information in this manual supplements the manuals for the $\frac{1}{2}$ Model 140-series oscilloscopes. If a time base or other plug-in unit is used in combination with the Model 1402A refer also to the manual for that plug-in.

SECTION II

INSTALLATION

2-1. INITIAL INSPECTION.

2-2. MECHANICAL CHECK. If external damage to the shipping carton is evident, ask the carrier's agent to be present when the instrument is unpacked. Check the instrument for external damage such as broken controls or connectors, dents or scratches on the panel surfaces. If damage is evident, see Paragraph 2-4 for recommended claim procedure and repackaging information. If the shipping carton is not damaged, check the cushioning material and note any signs of severe stress as an indication of rough handling in transit. If the instrument appears undamaged, perform the electrical check given in the following paragraph.

2-3. ELECTRICAL CHECK. Check the electrical performance of the Model 1402A as soon as possible after receipt. Paragraphs 5-3 through 5-12 contain performance check procedures which will verify instrument operation within the specifications listed in Table 1-1. This check is also suitable for incoming quality control inspection. If the Model 1402A does not perform within the specifications when received, refer to Paragraph 2-4 for recommended claim procedure and repackaging information.

2-4. CLAIMS AND REPACKAGING.

2-5. If physical damage is evident, or if the instrument does not meet specifications when received,

Section II
Paragraphs 2-6 to 2-8

notify the carrier and the nearest Hewlett-Packard Sales/Service Office (see list at rear of this manual). The Sales/Service Office will arrange for repair or replacement without waiting for settlement of a claim with the carrier.

2-6. The original shipping carton and packing material, with the exception of the accordion-pleated pads, should be used for reshipment. The accordion-pleated pads are fatigued with one use and are not reusable. The Hewlett-Packard Sales/Service Office will also provide information and recommendations on materials to be used if the original packaging material is not available or is not reusable. Materials used should include: (1) a double-walled carton (check with a freight carrier for test strength required), (2) heavy paper or sheets of cardboard to protect all instrument surfaces; use extra material around projecting parts of the instrument, (3) at least four inches of tightly-

packed shock-absorbing material surrounding the instrument. Close the carton securely with durable shipping tape. If the instrument is to be shipped to a Sales/Service Office for repair, attach a tag showing owner, model, serial number, and repairs required.

2-7. PREPARATION FOR USE.

2-8. The Model 1402A is an amplifier plug-in unit for the Model 140-series Oscilloscopes. In the Model 140A Oscilloscope the Model 1402A can be used in either plug-in compartment, but it is normally used as a vertical amplifier in the lower plug-in compartment, while the upper compartment is used for the sweep plug-in unit. To install the Model 1402A, slide the unit into the appropriate compartment in the oscilloscope front panel. Lock the plug-in in place to ensure good electrical and mechanical connection. All necessary power for the Model 1402A is supplied by the oscilloscope.

OPERATION

SECTION III

OPERATING INSTRUCTIONS

3-1. INTRODUCTION.

3-2. The Model 1402A Dual Trace Amplifier contains two amplifier channels, with provision for display of either or both signals on the cathode-ray tube of a Model 140-series oscilloscope. With the exception of FUNCTION, A POLARITY, and SENS CAL, all controls and inputs are duplicated: one set for Channel A at left, the other for Channel B at right. Figure 3-2 lists the functions of the controls and connectors.

3-3. OPERATING PROCEDURES.

3-4. Figures 3-3 through 3-8 give step-by-step operating instructions for the Model 1402A. These instructions are keyed to individual controls. Additional information on the various modes of presentation is given in Paragraphs 3-6 through 3-13. The DC Balance and Sensitivity Calibration adjustments, Figures 3-3 and 3-4, are to be made before using the Model 1402A. Sensitivity calibration should be checked each time the Model 1402A is transferred from one compartment to the other, or from one oscilloscope to another. The Model 1402A may be used in either vertical or horizontal plug-in compartments of the Model 140A oscilloscope; however, chopped blanking takes place only when the Model 1402A is used in the lower (vertical) compartment.

3-5. MODES OF PRESENTATION.

3-6. SINGLE CHANNEL. Either Channel A or Channel B may be displayed by switching the FUNCTION control fully counterclockwise (A) or fully clockwise (B). In either position the unused channel is switched off, so that it is not necessary to disconnect input signal. When internal triggering is used, time base triggering is from the signal displayed.

3-7. ALTERNATE. In ALTERNATE operation, the Model 1402A connects the output of one channel to the CRT for the duration of one sweep, and the output of the other channel for the duration of the next sweep. Alternate operation is intended for comparing signals which require fast sweep speeds. Although the sweep may be triggered by an external trigger signal which is synchronized with both vertical signals, internal triggering may be used, each sweep being triggered by the signal of the channel which is about to be presented. This mode is useful when two signals unrelated in time are to be displayed. See also Paragraph 3-8.

3-8. ALTERNATE, TRIG BY CH. A. This mode is similar to the alternate mode of operation described in paragraph 3-7, except that internal sweep triggering is from the Channel A signal only. This method of triggering permits accurate time comparisons between the two signals.

3-9. CHOPPED. In CHOPPED operation the Model 1402A switches channels at a rate of approximately 100 kc, so both signals appear during each sweep. Chopped operation is intended for comparing signals which require sweep speeds below about 50 microseconds per centimeter, that is, sweep speeds which are low compared to the 100-kc switching rate. This type of operation permits precise time comparisons because both signals are displayed on the same sweep. When internal triggering is used, the Channel A signal is used to trigger the time base. Switching transients are blanked when the Model 1402A is used in the vertical (lower) compartment of the Model 140A oscilloscope.

3-10. ALGEBRAIC ADDITION. In A+B operation, the sum of in-phase signals applied to Channels A and B is presented on screen; or, in the case of out-of-phase (differential) signals, the difference of the two signals is presented. Differential (B-A) operation is obtained by switching A POLARITY to negative (-). The B-A mode presents the sum of out-of-phase (differential) signals, or the difference of in-phase signals. Common-mode rejection may be improved by slight adjustment of one sensitivity VERNIER or the other to null the common-mode signal seen on the screen. Use only one VERNIER in order to maintain a calibrated display.

3-11. DUAL X-Y. Two independent X-Y displays may be presented on the CRT of the Model 140A Oscilloscope by using two Model 1402A plug-ins, or one Model 1402A and another 1400-series dual-trace vertical amplifier. Operating instructions are given in Figure 3-8. For X-Y measurement above 10 kc the delay line of the Model 1402A may cause phase-shift errors greater than 2° when used with a 1400-series plug-in that does not contain a delay line. Two Model 1402A's, however, are matched closely enough that less than 2° of phase shift beyond 100 kc is assured, and less than 3° to 1 Mc is typical.

3-12. If higher-frequency X-Y operation is desired, the following modification and adjustments must be performed.

- a. Disconnect the delay line in both Model 1402A's.
- b. Connect a 10-20 ohm, 1/4 watt resistor between the L402/R408 junction and L404/R415 junction in both Model 1402A's. Refer to Figure 5-14.
- c. Connect a 10-20 ohm, 1/4 watt resistor between the L401/R407 junction and L403/R411 junction in both Model 1402A's.

NOTE

Jumpering the amplifier leads with these resistors damps oscillation tendencies.

Section III
Paragraphs 3-13 to 3-15

d. Install the Model 1402A's in the Model 140A, and insert the same high-frequency signal into both units using Channel A or B functions.

e. Adjust C433, C441, and C461 in the lower Model 1402A, as necessary, between the 1-10 Mc band for minimum phase shift on a 45° line display. C461 is dominant through the 1-4 Mc band, C441 from 4 to 8 Mc, and C433 above 8 Mc, although all three interact to some extent.

The maximum signal sizes to minimized distortion are 10 X 10 cm for signals below 10 Mc, and 6 X 6 cm (centered) for signals above 10 Mc. When these limits are observed, the 1402A X-Y operation may typically be less than 3° of phase shift or distortion through 20 Mc.

3-13. When normal use of the Model 1402A's is again desired; remove the resistors installed above, and reconnect the delay lines. The Model 1402A in the upper compartment should still be calibrated. The Model 1402A in the lower compartment must be re-compensated for high frequency performance, using the procedure supplied in Paragraph 5-25.

3-14. BANDWIDTH.

3-15. The bandwidth specification of the Model 1402A is 20 megacycles, referenced to a low frequency display of 6 centimeters. Linearity is such that the 6-

cm display may be positioned anywhere over the 10 x 10 cm area of the CRT graticule without significant distortion or loss of bandwidth. Figure 3-1 illustrates a typical bandwidth curve.

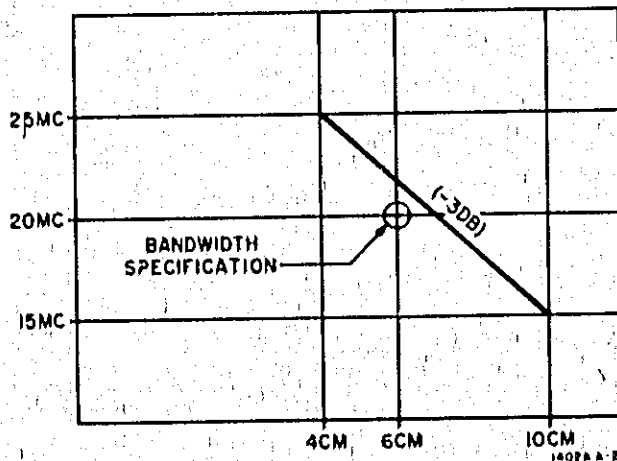
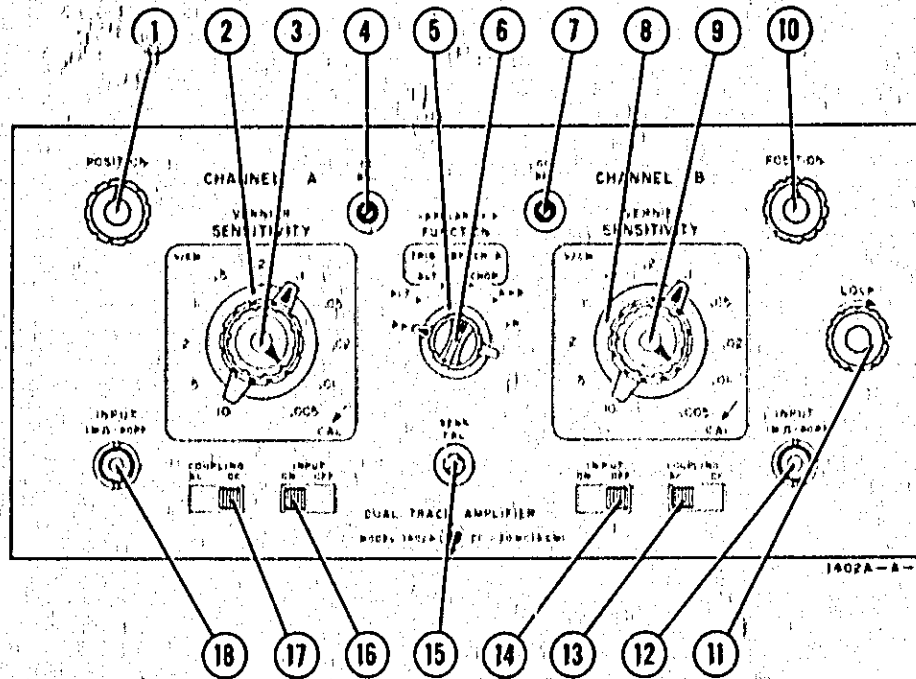
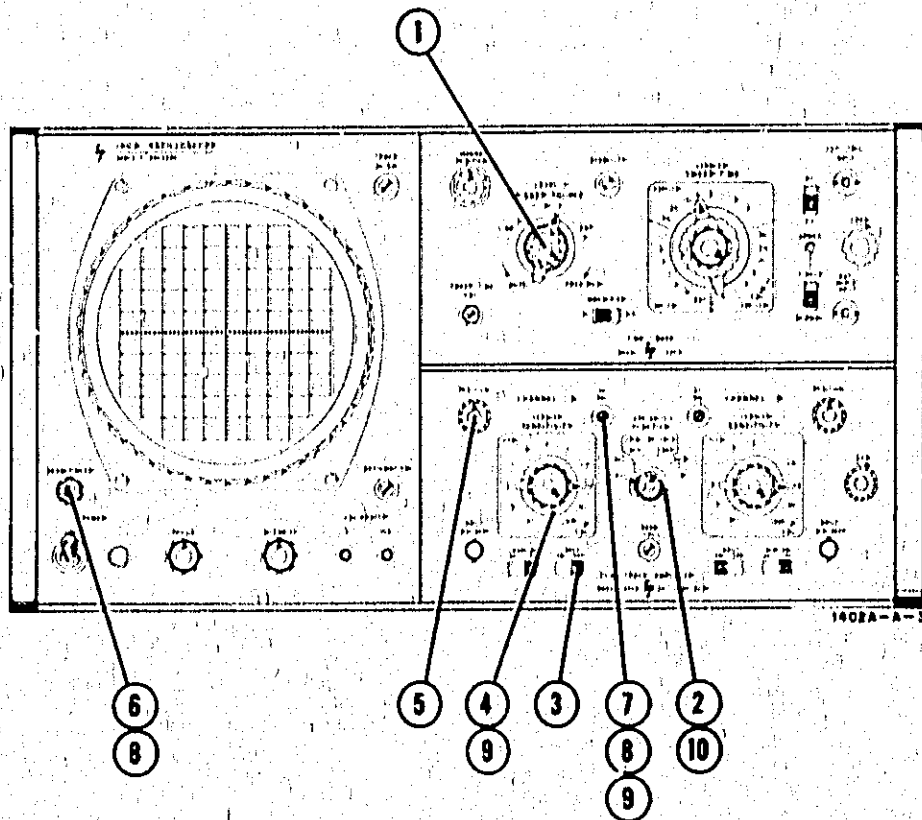

Figure 3-1. Model 1402A Bandwidth



- | | |
|--|---|
| <ol style="list-style-type: none"> 1. Positions Channel A trace vertically on CRT. 2. Selects sensitivity of Channel A. 3. Provides continuous adjustment between steps of SENSITIVITY switch. 4. Balances Channel A amplifier to prevent vertical shift of trace when sensitivity is changed. 5. Selects signals displayed, mode of display, and signal (Channel A or combined) to be used for internal triggering. 6. Determines polarity of Channel A display. 7. Balances Channel B amplifier. 8. Selects sensitivity of Channel B. 9. Provides continuous adjustment between steps of SENSITIVITY. | <ol style="list-style-type: none"> 10. Positions Channel B trace vertically on CRT. 11. Locks plug-in unit in place. 12. Signal input connector for Channel B. 13. Selects AC coupling or DC coupling at Channel B input. 14. Connects (ON) or disconnects (OFF) signal to Channel B. 15. Calibrates sensitivity of the Model 1402A. 16. Connects or disconnects signal to Channel A. 17. Selects AC coupling or DC coupling at Channel A input. 18. Signal input connector for Channel A. |
|--|---|

Figure 3-2. Controls and Connectors



1. Set LEVEL to FREE RUN.
2. Select Channel A.
3. Set INPUT to OFF.
4. Set Channel A SENSITIVITY to .02 V/CM.
5. Center Channel A POSITION control.
6. Depress BEAM FINDER switch.
7. Adjust DC BAL to center trace.
8. Release BEAM FINDER and recenter trace with DC BAL.
9. Adjust DC BAL for no vertical shift as SENSITIVITY is varied between .02 V/CM and .005 V/CM.
10. Select Channel B and repeat steps 3 through 9, using corresponding Channel B controls.

Figure 3-3. DC Balance Adjustment

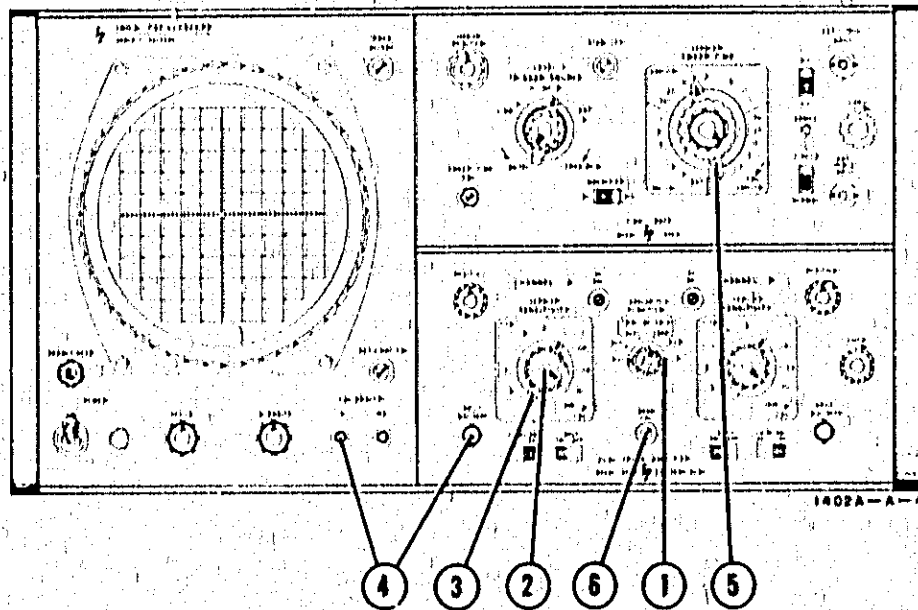

1. Select Channel A.
2. Set Channel A VERNIER to CAL.
3. Set Channel A SENSITIVITY to .1 V/CM.
4. Connect 1V CALIBRATOR to Channel A INPUT.
5. Set SWEEP TIME to display a convenient number of cycles.
6. Adjust SENS CAL for exactly 10 centimeters of vertical deflection.

Figure 3-4. Sensitivity Calibration

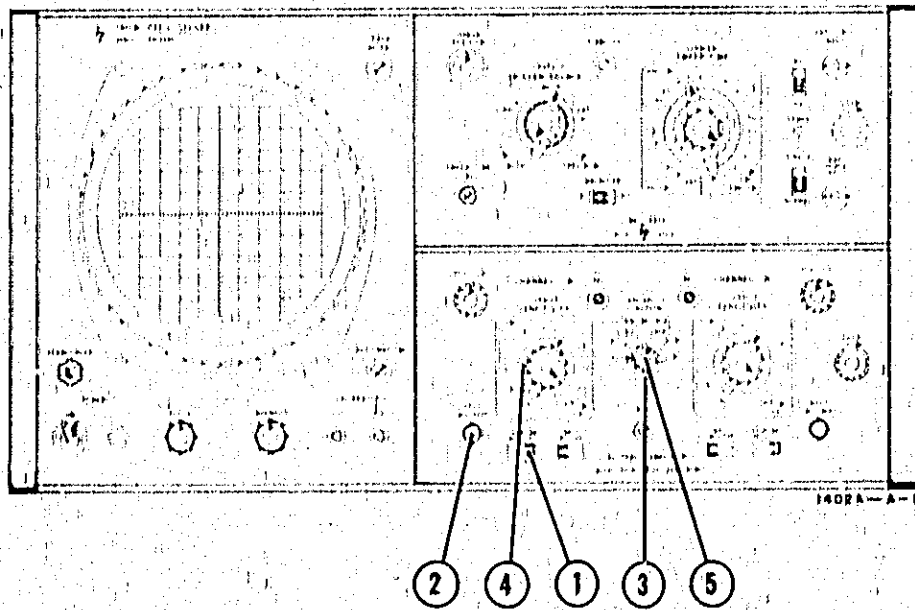

1. Set **COUPLING** to DC if DC coupling is desired, or to AC to block large DC components.
2. Connect signal to **INPUT**.
3. Select Channel A (or B).
4. Set **SENSITIVITY** to the desired range. For calibrated sensitivity, set **VERNIER** to CAL.
5. Set **A POLARITY** to (+) for normal positive-up presentation, or to (-) if inverted display is desired. (This control is effective for Channel A only.)

Figure 3-5. Single Channel Operation

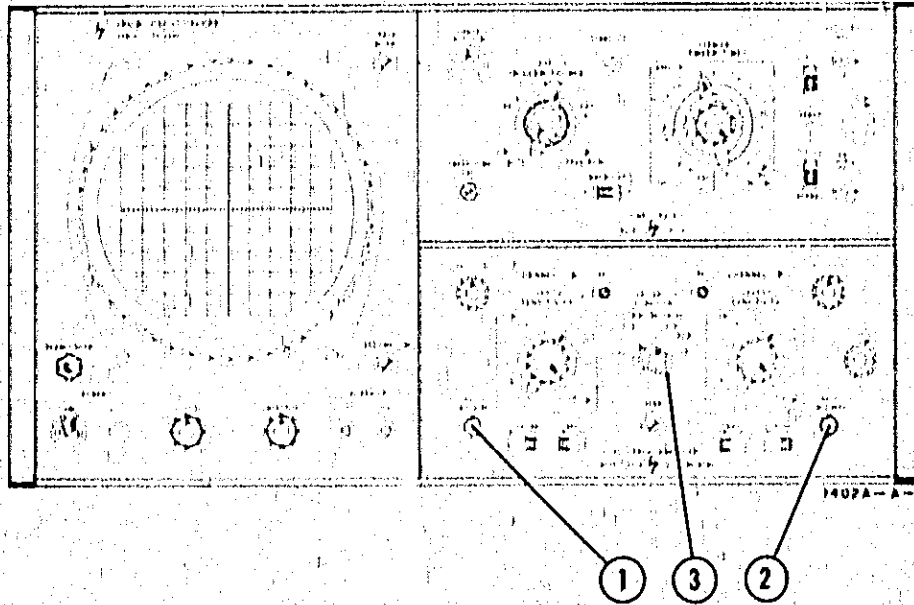

1. Connect one signal to Channel A INPUT, and set Channel A controls as desired (procedure shown in Figure 3-5).
2. Connect second signal to Channel B INPUT and set Channel B controls as desired.
3. Select CHOP for display of both signals during the same sweep, or ALT for display of signal on alternate sweeps. (Chopped operation is suitable for slower sweep rates; alternate operation for fast sweep rates.)

Note

Internal triggering in the mode shown is on both channels (alternately); the next two clockwise positions of the FUNCTION control use the Channel A signal only.

Figure 3-6. Dual Trace Operation

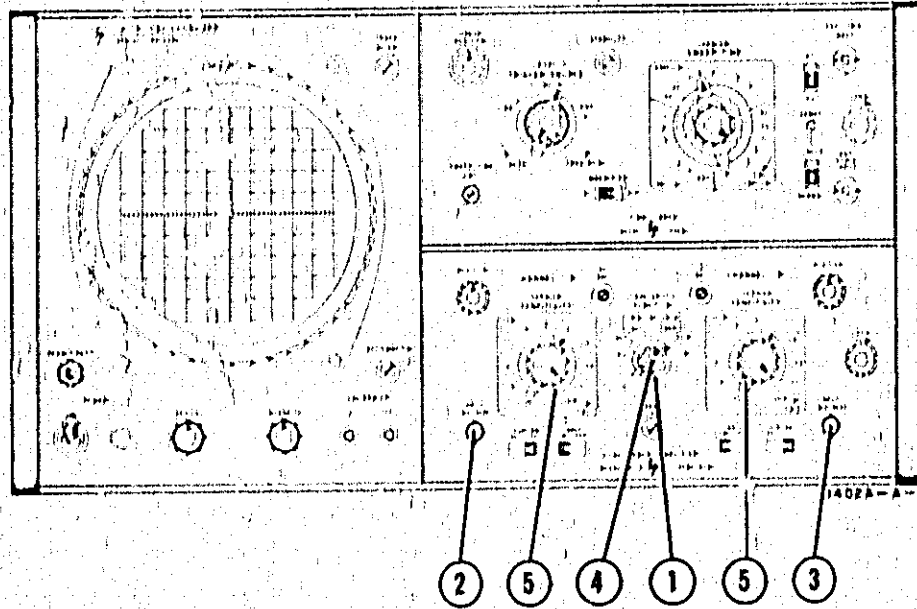

1. Select A+B.
2. Connect one signal to Channel A INPUT.
3. Connect second signal to Channel B INPUT.
4. Set A POLARITY TO (+).
5. Set SENSITIVITY switches as desired, with identical settings for best results.

Note

Differential (B-A) operation is obtained by setting A POLARITY to (-) in Step 4.

Figure 3-7. Algebraic Addition

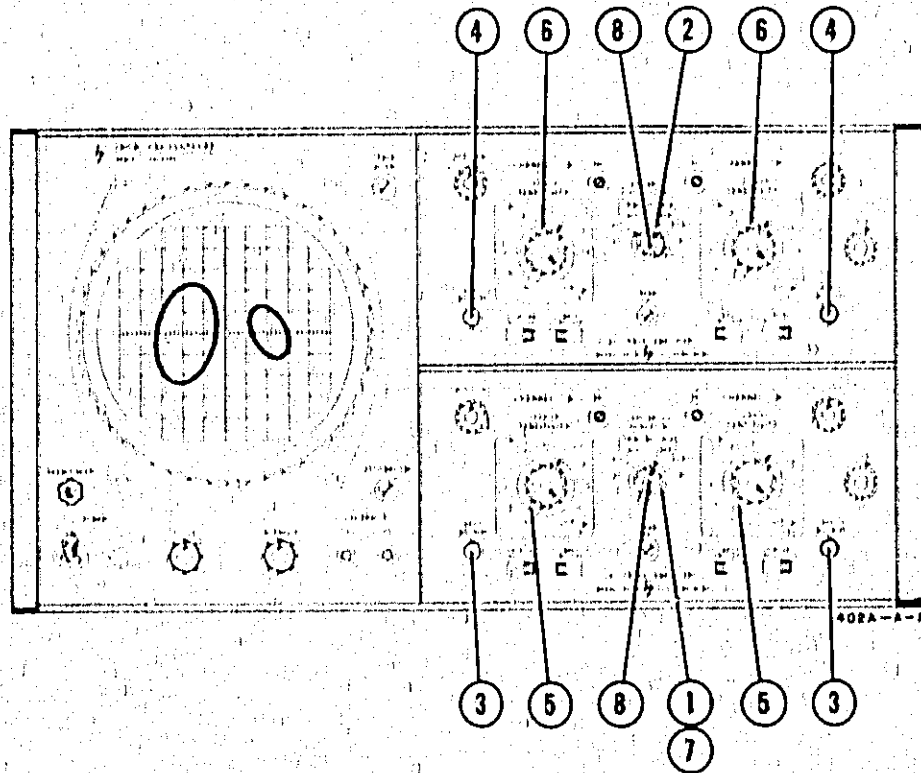

1. Set FUNCTION of vertical (lower) Model 1402A plug-in to CHOP.
2. Set FUNCTION of horizontal (upper) Model 1402A plug-in to ALT.
3. Connect Y (vertical) signals to Channel A INPUT and Channel B INPUT of vertical (lower) plug-in.
4. Connect X (horizontal) signals to Channel A INPUT and Channel B INPUT of horizontal (upper) plug-in.
5. Adjust vertical sensitivities for desired Y-deflection.
6. Adjust horizontal sensitivities for desired X-deflection.
7. If necessary, switch vertical (lower) FUNCTION control out of and into CHOP until desired comparison of X and Y signals is obtained (Channels A with A and B with B, or A with B and B with A). Use POSITION controls to identify which channels are being compared.
8. The A POLARITY switches can be used to reverse Channel A signals in both plug-ins.

Note

Two signals applied to a Model 1402A (set to CHOP) may also be compared with one signal applied to a single-channel plug-in in the other compartment.

Figure 3-8. Dual X-Y Operation for Two Independent Displays

THEORY

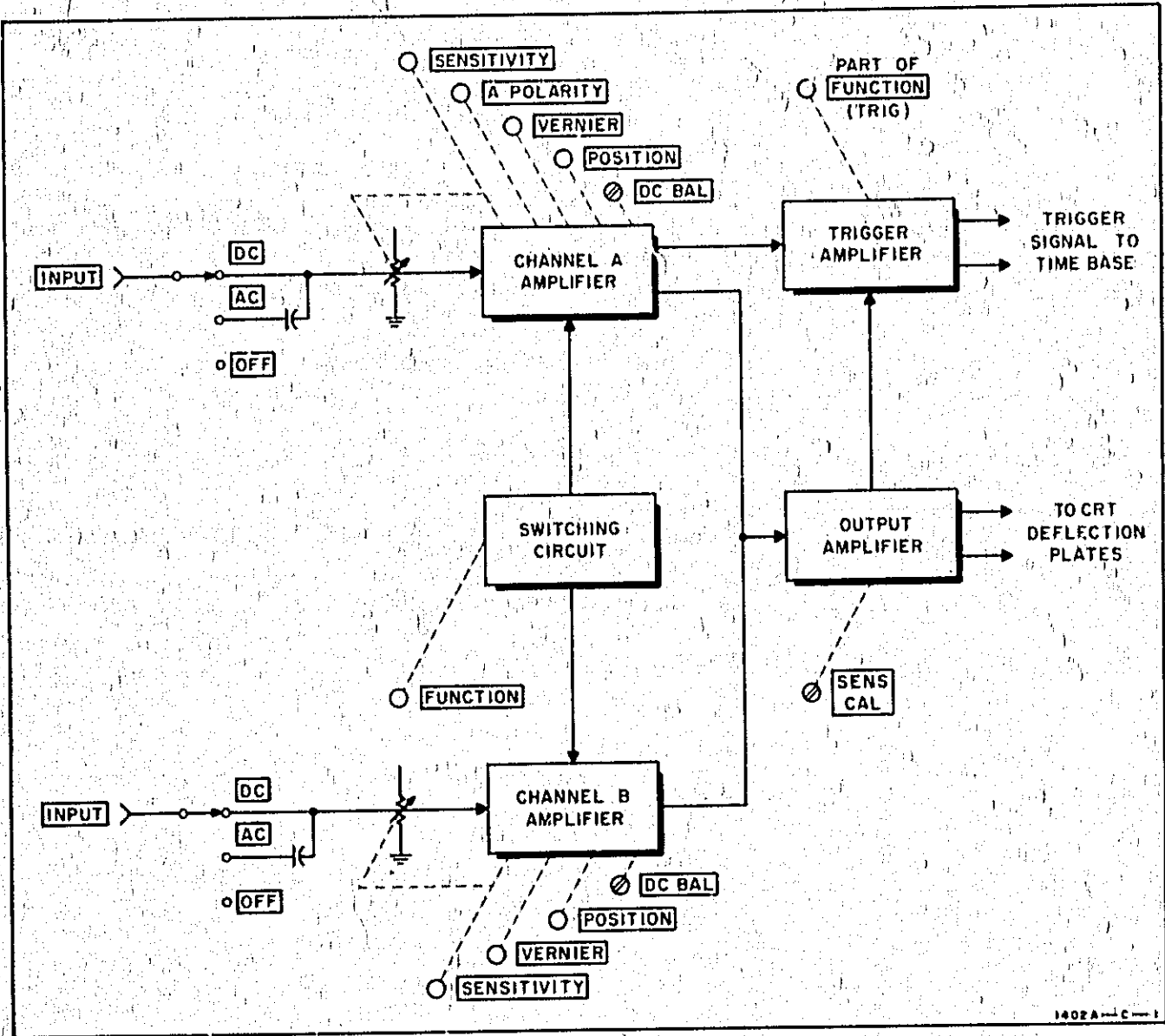

Figure 4-1. Model 1402A Block Diagram

SECTION IV

CIRCUIT DESCRIPTION

4-1. OVERALL DESCRIPTION.

4-2. The Model 1402A Dual Trace Amplifier contains five basic circuits: two independent differential amplifiers (Channels A and B), an output amplifier, a switching circuit, and a trigger amplifier. The relationship of these circuits is shown in the block diagram, Figure 4-1. The input signal for each channel is DC-coupled or AC-coupled through an input attenuator to the amplifiers, or may be disconnected (OFF). No input attenuation is used on the three most sensitive ranges. With the exception that a polarity-reversing switch is provided for Channel A only, the two input amplifier channels are essentially identical. The switching circuit turns on either or both channels for one of the five modes of presentation selectable by the FUNCTION control (A, ALT, CHOP, A+B, or B). Signal from either or both Channel A and Channel B is applied to the differential output amplifier, which drives the deflection plates of the oscilloscope cathode-ray tube. A part of the FUNCTION switch is used to select either Channel A signal or the combined signal from the output amplifier for application to the trigger amplifier. The differential signal from the trigger amplifier is connected through the oscilloscope to a time base plug-in unit for sweep triggering. The single sensitivity calibration control, SENS CAL, is located in the output amplifier; the two input channels do not require separate front-panel gain adjustments, since these circuits are very insensitive to aging and temperature effects.

4-3. CIRCUIT DETAILS.

4-4. Refer to the schematic diagrams throughout the following circuit descriptions. Channel B operation is similar to Channel A, except as noted in the Channel A description.

4-5. CHANNEL A.

4-6. The signal is AC- or DC-coupled through S101A and S101B to the input attenuator. On the two most sensitive settings of the attenuator, two switch wafers are used to bypass the attenuator sections, and the change of sensitivity is accomplished in the amplifier. The next (.02) position also uses no input attenuation. The remaining less sensitive ranges switch in one or two of the four attenuator networks, which provide attenuation ratios of 2.5:1 (R111/R112), 5:1 (R113/R114), 10:1 (R101/R102), 100:1 (R103/R104). Variable capacitors in these networks are adjusted to maintain these ratios for high frequencies by capacitive division.

4-7. Input overload protection is provided by R120, V102, and CR101. DC BAL control R140 adjusts the DC level in the lower half of the amplifier, so that with no input signal the emitters of Q103 and Q104 will be at the same voltage. Thus when amplifier gain is changed (by operating SENSITIVITY control), the position of the trace will not shift. The VERNIER

control R140, when rotated counterclockwise, reduces signal amplitude by shunting signal around the bases of Q103 and Q104. R150C calibrates amplifier gain for all ranges of SENSITIVITY except .01 and .005, which are calibrated (after R150C is correctly set) by R150A and R150B respectively. The output of differential amplifier Q103/Q104 can be reversed in Channel A by S103. POSITION control R170A/B varies the DC level at the output of the Channel A circuit for positioning of the display on the CRT. Signal is coupled through switching diodes CR110 and CR113 (when these diodes are switched on) to the output amplifier.

4-8. SWITCHING CIRCUIT.

4-9. The switching circuit consists of a blocking oscillator, a blanking pulse amplifier, and a multivibrator. The switching circuit applies either cut-off bias or conducting bias to the switching diodes at the output of each amplifier channel (CR110 through CR113, and CR210 through CR213) and thus determines which channel is on at a given time. Figure 4-2 is a simplified diagram of the switching circuit.

4-10. BLOCKING OSCILLATOR. Depending on the position of FUNCTION switch S301, Blocking Oscillator Q301 can be astable, monostable, or disabled. When the emitter of Q301 is returned through R307 to the +100 volt supply (CHOP function), the circuit is permitted to oscillate with a free-running frequency of about 200 kilocycles. The positive-going voltage at the collector is coupled through C321 to switch the multivibrator; since the multivibrator must switch twice for a full cycle, multivibrator frequency is 100 kc. When the emitter of Q301 is returned to ground (ALT function), the circuit is biased off in a monostable condition and will produce a pulse each time the negative-going gate signal is received through C301 and CR301. Thus in the ALTERNATE mode, the multivibrator switches once for each sweep of the time base. Opening the emitter lead in the A, A+B, and B positions disables the circuit for these functions.

4-11. BLANKING PULSE AMPLIFIER. The positive-going portion of the pulse from the blocking oscillator has no effect on Q302; the negative backswing, however, turns this transistor on, producing a positive pulse which blanks the CRT beam. Transients caused by switching in the CHOPPED mode thus do not appear on the CRT screen. The time period between the start of the blocking oscillator pulse and the negative-going backswing is about 200 nanoseconds, which corresponds to the signal delay introduced in the output amplifier. Thus blanking starts at the same time as any transient which may appear. CR303 is reverse-biased in CHOP mode, but in all other positions is forward-biased to ground undetectable blanking transients.

4-12. MULTIVIBRATOR. Transistors Q303 and Q304 are connected in a bistable multivibrator circuit. Depending on the position of the FUNCTION switch the multivibrator may be switched by positive triggers from Blocking Oscillator Q301 (ALT or CHOP), locked in either of its two stable states (A or B), or disabled (A+B). Figure 4-2 illustrates signal conditions for ALTERNATE operation at a time when Q303 has been switched on (output more negative) and Q304 has been cut off (output more positive). With these output voltages, CR111 and CR112 are forward-biased, which shorts Channel A signal. The current of Channel A output transistors Q103 and Q104 flows through Q303 of the multivibrator. Diodes CR110 and CR113 are reverse-biased, which disconnects Channel A output from the output amplifier. Channel A is therefore "off". In Channel B, diodes CR211 and CR212 are biased off and CR210 and CR213 are forward-biased, which permits signal from Channel B output transistors Q203 and Q204 to be coupled to the output

amplifier. Channel B is therefore "on". When the next sweep starts, a positive trigger from Q301 reverses the states of Q303 (off) and Q304 (on). This reverse-biases the four diodes which were on (CR111, CR112, CR210, and CR213), and forward-biases those which were off (CR110, CR113, CR211, and CR212). Thus Channel A is switched on and Channel B is switched off, and for each following successive sweep, the two channels will be switched alternately on and off. In CHOP mode, the channels are switched at a 100-ke rate, as determined by the free-running rate of the blocking oscillator. In the A position of the FUNCTION switch, -12.6 volts is applied through R332 to CR211 and CR212, which forward-biases these diodes and reverse-biases CR210 and CR213. The multivibrator is disabled by R334 which limits current available to Q303 and Q304, and the output of Q303 is near ground (less negative than when conducting). Diodes CR111 and CR112 are therefore reverse-biased, and Channel A signal is coupled through CR110

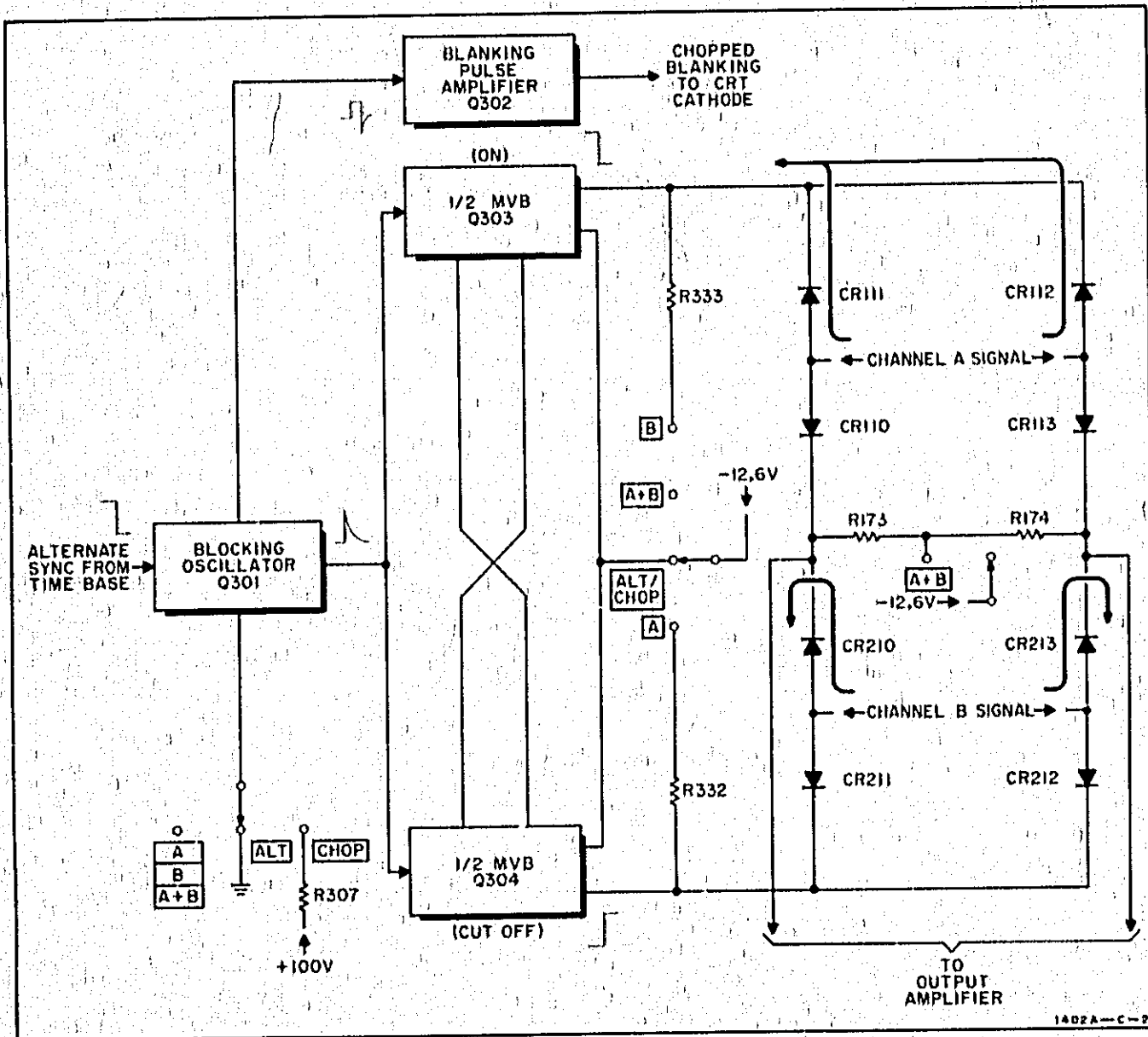

Figure 4-2. Switching Circuit Simplified

and CR113 to the output amplifier. In the B position of the FUNCTION switch, the reverse situation holds true, with -12.6 volts being applied through R333. In the A+B mode the multivibrator is also held inoperative by R334, and -12.6 volts is applied to the junction of R173 and R174, which forward-biases CR110, CR113, CR210, and CR213 while reverse-biasing CR111, CR112, CR211, and CR212. The signals of both channels are thus added and applied to the output amplifier.

4-13. OUTPUT AMPLIFIER.

4-14. Signals from Channel A or Channel B (or both in A+B mode) are amplified by common base amplifiers Q401/Q402 and are applied to delay lines DL401 and DL402. The purpose of the delay introduced by these lines is to permit starting of the sweep trace in advance of the display of a vertical signal. Thus if a fast-rise vertical signal is also used to trigger the sweep, the entire pulse rise will be displayed on the CRT screen. Trigger pickoff is ahead of the delay lines, at the junctions of R401/R402 and R405/R406. Position Adjustment R409 sets DC levels to be the same in both halves of the output amplifier. Adjustment is made by centering the trace with no DC differential input to Q401/Q402. SENS CAL control R423 adjusts signal degeneration between the bases of Q405 and Q406, and is set for calibrated sensitivity of the Model 1402A. High-frequency adjustments C433, C441, and C461 adjust high-frequency gain in the third, fourth, and sixth stages respectively. Each of the three adjustments provides frequency compensation of a different time constant, and the adjustment having the longest time constant, C461, should be adjusted first. Diodes CR451, CR452, CR461, and CR462 are normally reverse-biased, and provide voltage overload protection for V401A/B, V402, and V403 by clamping the cathodes of these tubes to -12.6 volts. Output Plate Voltage adjustment R460 adjusts the voltage applied to the deflection plates for optimum focus operation of the CRT. The BEAM-FINDER switch, located on the oscilloscope front panel, reduces current available to output tubes V402 and V403 by allowing R474 to be inserted in series with the cathode supply. With stage current thus reduced, the difference in CRT deflection plate voltages will be small enough to locate the trace on screen, regardless of signal amplitude or the setting of POSITION controls.

4-15. TRIGGER AMPLIFIER.

4-16. Differential signal from Channel A is applied to Q501 and Q502, and differential signal from the output amplifier (which may be either Channel A or Channel B signal, or both) is applied to Q503 and Q504. A part of FUNCTION switch S301 selects

either one of these trigger sources (Channel A only for the two dual trace functions designated TRIG BY CH. A, or the combined signal for the four remaining positions) and the signal is AC-coupled through C511 and C512 to differential amplifier Q505/Q506. Slightly less sensitive triggering may be noted on TRIG BY CH. A ALT when using the 5 and 20 millivolt settings of the SENSITIVITY control. Sync Bal adjustment R514 balances the differential signal applied to the time base. The output of the second differential amplifier, Q507/Q508 is applied through emitter followers Q509 and Q510 to the time base plug-in. Diode CR541 is reverse-biased in all function positions except CHOP, effectively disconnecting C541 and C542. In CHOP position CR541 is forward-biased, which places C541 and C542 across the output of Q507 and Q508. This reduces the bandwidth of the stage and prevents switching transients from being applied to the time base triggering circuit. Extended bandwidth is not required in the CHOP mode since this type of display is suitable only for vertical signals considerably below the 100-ke chopping rate. The calibrator voltage divider, shown on the trigger amplifier schematic, divides the 1-volt line-frequency calibrator voltage to calibrated voltages of 120 millivolts, 60 millivolts, and 30 millivolts. These voltages are available at terminal posts on the trigger amplifier board for use in checking sensitivity calibration (see paragraph 5-23 for recommended procedure in making sensitivity adjustment).

4-17. DUAL X-Y SWITCHING.

4-18. When two Model 1402A amplifiers are used for dual X-Y measurements, the vertical plug-in (lower compartment of the Model 140A) is used in CHOP MODE. The frequency of the blocking oscillator in this plug-in (about 200 ke) determines the switching rate of both units, and provides chopped blanking to the CRT in the oscilloscope. The blocking oscillator waveform is applied through the oscilloscope to the base of the blocking oscillator in the horizontal plug-in. The horizontal plug-in (upper compartment of the Model 140A) is used in ALT mode, and since the blocking oscillator is in the monostable condition, it is triggered by the 200-ke switching waveform received from the vertical plug-in, and thus switches at the same rate. Because the multivibrators in the two Model 1402A's will not always be in the same state when the first chopping pulse is received, the selection of channels for X-Y comparison is random (not selectable from the front panel). However, by operating the FUNCTION switch of the vertical plug-in out of and into CHOP a few times, the desired X and Y channels can be caused to switch on together, thus permitting comparison of Channel A with A and B with B, or A with B and B with A.

MAINTENANCE

Table 5-1. Equipment Required for Tests and Adjustments

Instrument Type	Recommended Model	Required Characteristics	Required for	Ref Para
1. Signal Generator	Tektronix Type 180	Frequency 50 kc to 20 Mc; output 1v - 2v	Common-Mode Rejection Check; Bandwidth Check	5-9 5-11
2. Voltmeter Calibrator	4p 738AR	AC output 50 mv to 100 v p-p; accuracy $\pm 0.5\%$	Sensitivity Check	5-10
3. Pulse Generator	Tektronix Type 107	Output 250 mv; rise time less than 5 ns; frequency 400 kc	Rise Time Check; High Frequency Adjustment	5-12 5-25
4. Square Wave Generator	4p 211A	Frequency 10 kc; output 0.2 v	Attenuator Compensation Adjustment	5-24
5. DC Voltmeter	4p 412A	Full-scale range 1v, 100 v; accuracy 1%; floating common lead	DC Level Adjustment; Trigger Amplifier Balance Adjustment	5-22 5-26
6. Audio Oscillator	4p 200CD	Output 3v p-p; frequency 400 cps	Sensitivity Adjustment	5-23
7. L-C Meter	Tektronix Type 130	To indicate 43 pf	Input Capacity Adjustment	5-24

SECTION V MAINTENANCE

5-1. INTRODUCTION.

5-2 This section covers maintenance, troubleshooting, and adjustment of the Model 1402A Dual Trace Amplifier. The performance check (Paragraphs 5-3 through 5-12) may be used at incoming inspection or after adjustments have been made to verify that the instrument meets its specifications (Table 1-1).

5-3. PERFORMANCE CHECK.

5-4. The performance check is intended to determine whether or not the instrument is operating within its specifications. If adjustment is required, refer to Paragraph 5-13. To check calibrator accuracy and other specifications for the oscilloscope, refer to the oscilloscope manual.

5-5. TEST EQUIPMENT.

5-6. Test equipment recommended for the performance check is listed in Table 5-1, Items 1 through 3. Similar instruments having the listed characteristics may be substituted.

5-7. PROCEDURE.

5-8. Install the Model 1402A in the desired plug-in compartment of an Model 140-series oscilloscope, depending on whether the plug-in is intended for use as a horizontal or a vertical amplifier. In the following performance check procedure it is assumed that the lower (vertical) compartment of the Model 140A is being used to test the Model 1402A.

5-9. COMMON MODE REJECTION.

- a. Set: FUNCTION ALT
A POLARITY (-)
VERNIER (both) CAL
Channel A and B SENSITIVITY . . . 0.2

b. Apply a 500 kilocycle signal from the Signal Generator (see Table 5-1) to both Channel A and Channel B INPUT connectors.

c. Adjust Signal Generator output for 10-cm display on both traces.

- d. Set: FUNCTION A+B
Channel A and B SENSITIVITY . . . 0.02

e. Display height should not be greater than 1 centimeter.

- f. Set Channel A and B SENSITIVITY to .01.

g. Display height should not be greater than 2 centimeters.

- h. Set: FUNCTION ALT
Channel A and B SENSITIVITY . . . 0.1

i. Adjust Signal Generator output for 10-cm display on both traces.

- j. Set: FUNCTION A+B
Channel A and B SENSITIVITY . . . 0.005

k. Display height should not be greater than 2 centimeters.

5-10. SENSITIVITY.

- a. Set: FUNCTION A
SENSITIVITY (A) 0.02
VERNIER (A) CAL

b. Connect Voltmeter Calibrator output to Channel A INPUT.

c. Check all SENSITIVITY ranges by setting Voltmeter Calibrator and SENSITIVITY controls as shown in Table 5-2. Vertical deflection in each case should be 10 cm \pm 0.3 cm.

- d. Repeat Steps a through c for Channel B.

Table 5-2. Sensitivity Check

SENSITIVITY		Calibrator Output	
10	V/CM	100	VOLTS
5		50	
2		20	
1		10	
.5		5	
.2		2	
.1		1	
.05		.5	
.02		.2	
.01		.1	
.005		.05	

5-11. BANDWIDTH.

- a. Set: FUNCTION A
SENSITIVITY (A) 0.005
VERNIER (A) CAL

b. Apply a 1 Mc signal from Signal Generator to Channel A INPUT. Use a 50-ohm load across output of Signal Generator.

c. Adjust Signal Generator amplitude for 6 cm deflection.

d. Change frequency to 20 Mc. Vertical deflection should be 4.2 cm or greater.

- e. Repeat Steps a through d for Channel B.

Note

When a Model 1402A is installed for the first time in a Model 140A Oscilloscope with a serial prefix of 407-, 413-, 425-, or 437-, proceed as follows to obtain full bandwidth and rise time.

- (1) Remove variable capacitor C1 from the Model 140A.
- (2) Readjust C461 in Model 1402A for optimum flat top on pulse.

5-12. RISE TIME.

- a. Connect Pulse Generator to Channel A INPUT. Attach a 50-ohm load across output of Pulse Generator.
- b. Set:

FUNCTION	A
SENSITIVITY (A)	0.02
VERNIER	CAL
SWEEP TIME	0.5 USEC/CM
Sweep MAGNIFIER	X10
- c. Obtain a 6-cm step. Rise time from 10% to 90% points on pulse should be less than 18 nanoseconds.

Note

When a Model 1402A is installed for the first time in a Model 140A Oscilloscope with a serial prefix of 407-, 413-, 425-, or 437-, proceed as follows to obtain full bandwidth and rise time.

- (1) Remove variable capacitor C1 from the Model 140A
- (2) Readjust C461 in Model 1402A for optimum flat top on pulse.

5-13. ADJUSTMENTS.

5-14. Paragraphs 5-27 to 5-28 give the adjustment procedure for the Model 1402A. If difficulty is encountered in making any adjustment, refer to Paragraph 5-27 for troubleshooting procedures.

5-15. EQUIPMENT NEEDED FOR ADJUSTMENTS. Test equipment recommended for the adjustment procedure is listed in Table 5-1, Items 3 through 7. Similar instruments having the listed characteristics may be substituted.

5-16. LOCATION OF ADJUSTMENTS. Figure 5-1 shows the location of all internal adjustments in the Model 1402A.

5-17. PRELIMINARY PROCEDURE.

5-18. Install the Model 1402A in the lower compartment of the oscilloscope. If a Model 140A Oscilloscope is used, install another plug-in, preferably a time base such as the Model 1420A or Model 1421A, in the upper compartment. Turn on the instrument and allow several minutes for warmup.

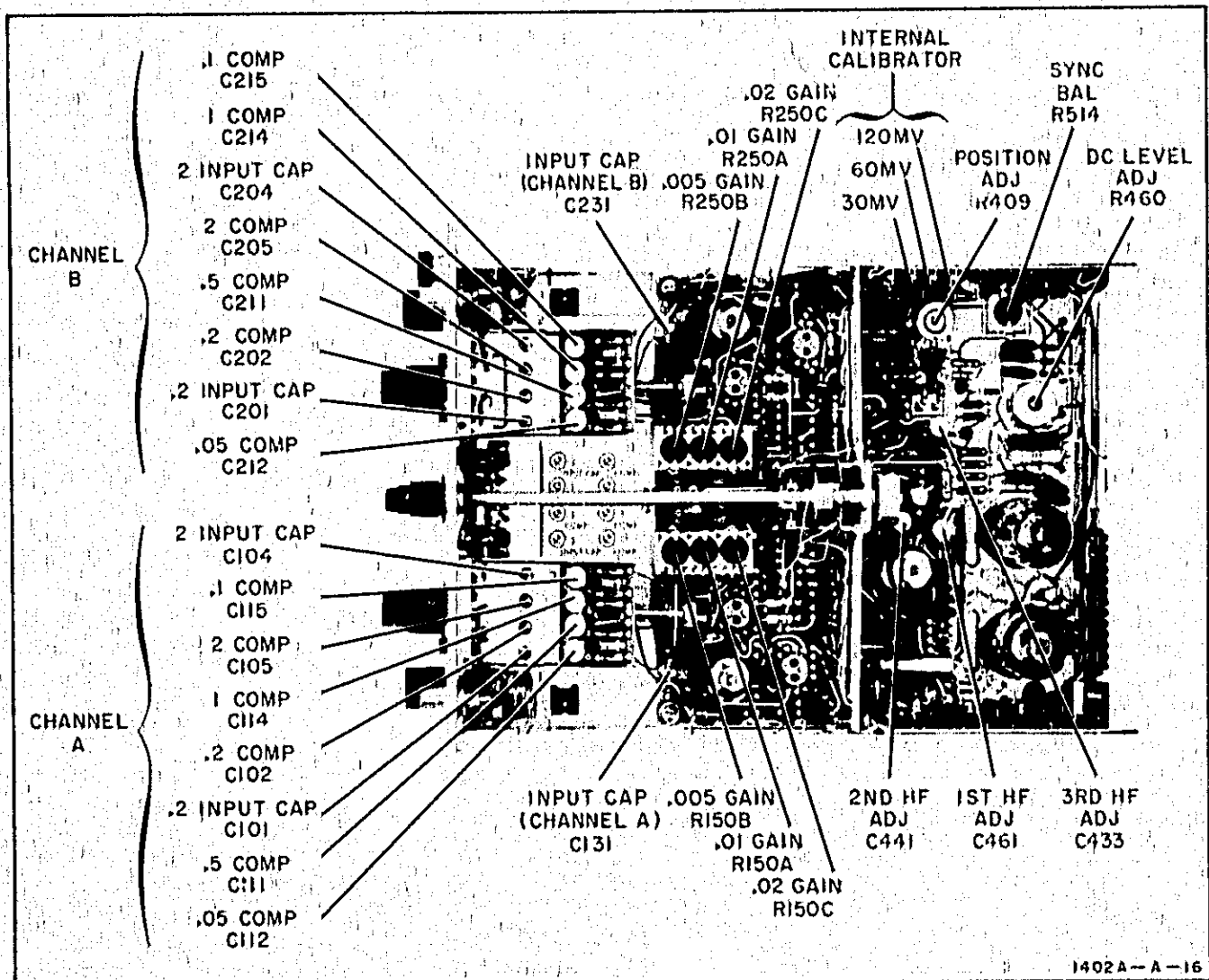

Figure 5-1. Location of Adjustments

5-19. DC BALANCE ADJUSTMENT.

5-20. Adjust DC BAL to eliminate trace shift when SENSITIVITY is switched between .005 V/CM and .02 V/CM. Perform for both channels.

5-21. POSITION ADJUSTMENT.

- a. Set: FUNCTION CHOP
POSITION controls 12 O'clock
- b. Center both traces about center of screen with Position Adj R409.

5-22. DC LEVEL ADJUSTMENT.

- a. Short the plates of V402 and V403 together and measure the voltage between this short and the +250 volt supply. This may be done by clipping one voltmeter lead to pins 12 and 24 (together) of P1, the 24-pin connector in the Model 140A, and the other voltmeter lead to the +250 volt supply.
- b. Set the voltage to 79 volts with DC Level Adj R460.

5-23. SENSITIVITY ADJUSTMENT.

- a. Set: SENSITIVITY 0.02 V/CM
VERNIER CAL
INPUT (Channel A) ON
INPUT (Channel B) OFF
- b. Connect 0.1v p-p signal from Voltmeter Calibrator to Channel A INPUT.
- c. Turn SENS CAL completely clockwise.
- d. Set .02 Gain adjustment for about 6 cm deflection.
- e. Adjust SENS CAL for exactly 5 cm deflection.
- f. Change signal input to 0.2v p-p and readjust SENS CAL for 10 cm deflection. Change signal input to 0.1v p-p.
- g. Set SENSITIVITY to .01 V/CM.
- h. Set .01 Gain adjustment for 10 cm deflection.
- i. Change signal input to 0.05v p-p.
- j. Set SENSITIVITY to .005 V/CM.
- k. Set .005 Gain adjustment for 10 cm deflection.
- m. Set: FUNCTION A+B
A POLARITY (-)
A&B SENSITIVITY02 V/CM
INPUT (Channel B) ON
- n. Apply 3v p-p 400 cps sine wave to both Channel A&B inputs.
- p. Adjust Channel B .02 Gain adjustment for minimum deflection.
- q. Change sine wave amplitude to 2v p-p.
- r. Set SENSITIVITY to .01 V/CM.
- s. Set Channel B .01 Gain adjustment for minimum deflection.
- t. Change sine wave amplitude to 1v p-p.
- u. Set SENSITIVITY to .005 V/CM.

v. Set Channel B .005 Gain adjustment for minimum deflection.

5-24. INPUT CAPACITY AND ATTENUATOR COMPENSATION ADJUSTMENT.

Note

Adjustments are given for Channel A with corresponding Channel B adjustments in parentheses, e.g. C131 (231). Perform adjustments for Channel A, then repeat for Channel B when instructed.

- a. Set SENSITIVITY to .02 V/CM.
- b. Connect L-C Meter to Channel A INPUT and adjust C131 (231) for 43 pf. Repeat for Channel B.
- c. Apply 10 kc square wave to Channel A INPUT. Obtain a pattern 10 cm high, and make the adjustments indicated in Table 5-3. Repeat for Channel B.
- d. Connect L-C Meter to Channel A INPUT and adjust C101 (C201) with SENSITIVITY at .2, and C104 (C204) with SENSITIVITY at 2 for 43 pf.

Table 5-3. Attenuator Adjustment

SENSITIVITY (V/CM)	Capacitor
.05	C112 (212)
.1	C115 (215)
.2	C102 (202)
.5	C111 (211)
1	C114 (214)
2	C105 (205)

5-25. HIGH FREQUENCY ADJUSTMENTS.

- a. Set: SENSITIVITY (A) 0.02 V/CM
VERNIER (A) CAL
FUNCTION A
- b. Connect 400 kc Pulse Generator signal to Channel A INPUT through 50-ohm termination.
- c. Obtain a 6 cm deflection and adjust C461, C441, and C433 for optimum flat top on pulse.

Note

When a Model 1402A is installed for the first time in a Model 140A Oscilloscope with a serial prefix of 407-, 413-, 425-, or 437-, proceed as follows to obtain full bandwidth and rise time.

- (1) Remove variable capacitor C1 from the Model 140A.
- (2) Readjust C461 in Model 1402A for optimum flat top on pulse.

5-26. TRIGGER AMPLIFIER BALANCE.

- a. Measure the DC voltage between the output leads of the trigger amplifier. This may be done at the ends of R551 and R552 which are connected to the black and white coax leads.
- b. Set this voltage to zero with Sync Bal adjustment R514. Should be 0 ± .5 volt.

Table 5-4. Troubleshooting for Unbalance

OUTPUT AMPLIFIER			
Step	Short Together	Effect	Common Fault (or Procedure)
1	Pins 3 and 8 of V401	Trace centers	Proceed to next step
		Trace does not center	V402, or V403, or CR461 or CR462
2	Pins 2 and 7 of V401	Trace centers	Proceed to next step
		Trace does not center	V401 or CR451 or CR452
3	Junction of R431 and Q405 Collector to Junction of R436 and Q406 Collector	Trace centers	Proceed to next step
		Trace does not center	Q407 or Q408
4	Junction of R421 and R422 to Junction of R425 and R424	Trace centers	Proceed to next step
		Trace does not center	Q405 or Q406
5	Junction of R411 and L405 to Junction of R415 and L406	Trace centers	Proceed to next step
		Trace does not center	Q403 or Q404
INPUT AMPLIFIERS			
6	Base of Q103 to Base of Q104 (Center both POSITION controls)	Trace Centers	Proceed to next step
		If the trace does not center on one channel, check the other channel before making a component replacement. If only one channel checks normal, the "Common Fault" is then one of the transistors (Q103/Q104 or Q203/Q204) in the channel where the trace does not center. If the trace fails to center on both channels the trouble may be one of the following: (1) either (or both) matched transistor pair (Q103/Q104 or Q203/Q204), or (2) incorrect switching circuit levels (see Table 5-6) or (3) the common-base stage, Q401/Q402, in the output amplifier.	
7	Base of Q101 to Base of Q102	Trace centers	Proceed to next step
		Trace does not center	Q101 or Q102
8	Junction of R132 and V102 to Pin 7 of V101	Trace centers	R140
		Trace does not center	V101, or CR101, or CR102
NOTE: Steps 6 through 8 may be used for Channel B; reference designations are 200-series			

5-27. TROUBLESHOOTING.

5-28. The following paragraphs outline procedures for locating and clearing problems in the Model 1402A. Be sure that the trouble cannot be cleared by making an adjustment. Waveforms and DC voltage levels are shown with the schematic diagrams.

5-29. **LOW AMPLIFIER GAIN.** Whenever overall gain is too low to be adjusted properly with the SENS CAL control, waveforms for the Model 140A 10V

CALIBRATOR signal are provided for troubleshooting. To locate the trouble, trace the calibrator signal from the input through each successive stage, using the test points and waveforms (1 through 11) provided with the schematics until the faulty stage is located. Switching from Channel A to Channel B will aid in determining whether the trouble is in the output amplifier or one of the input amplifiers.

5-30. **UNBALANCE.** Unbalance in a differential amplifier is generally caused by malfunction of a component(s) on one side of stage of the amplifier and

Table 5-5. Switching Troubleshooting

SWITCHING CONDITIONS		TROUBLESHOOTING PROCEDURE		
Operates	Does Not Operate	Check	Condition	Repair Procedure
Chop, Alt	A, B, or A+B	DC Voltages at Test Points 20 and 21 (see Table 5-6)	Voltages in error	Check for good switch connections and solder joints.
A, B, A+B	ALT and Chop	a. Waveforms at Test Point 19 (transistor case and collector are tied together)	No signal	Replace Q301
			Signal present	Proceed to b.
		b. Waveforms at test point 20 or 21	(1) No signal	(2) Replace Q303 and/or Q304
			(3) Still no signal	(4) Trace signal through multivibrator circuit.
A, B, A+B and Chop	ALT	Waveforms at Test Point 23	No Signal	Check Time Base plug-in and J1/P1 connections.
			Signal present	Replace CR301
	No blanking in CHOP position	Waveform at Test Point 22 (Pin 15 of J1 in 140A)	Signal present	a. Check Z Axis switch on rear panel of 140A for INT position; b. If still not operating check for good connections on switch. c. If still not operating replace switch.
			No Signal	a. Remove CR303. b. If signal appears replace CR303. c. If still no signal proceed to d.
			d. No Signal	e. Replace Q302
			f. Still no signal	g. Trace signal through circuit.

can be isolated to either input amplifier or to the output amplifier by setting the FUNCTION control first to one channel and then to the other. If balance is possible on one channel and not the other the unbalance is not in the output amplifier and unnecessary steps can be eliminated.

5-31. IMPROPER SWITCHING OPERATION. Table 5-5 is provided for step-by-step troubleshooting. Troubleshooting voltages are listed in Table 5-6.

5-32. INSUFFICIENT TRIGGER AMPLITUDE. Insufficient amplitude of the trigger signal can be caused either by low gain in the input amplifier or in the trigger amplifier. Input amplifier gain can be checked by procedures in Paragraph 5-29. Low gain in the trigger amplifier can be located by tracing a Model 140A 10V CALIBRATOR signal connected to either input, through each stage of amplification using test point waveforms (12 - 17) provided with the trigger

amplifier schematic. Waveforms at Test Points 18 and 19 are also provided for troubleshooting when Channel A signal is used for triggering.

5-33. ADJUSTMENTS FOLLOWING COMPONENT REPLACEMENT.

5-34. Table 5-7 lists adjustments to be made after replacement of tubes, transistors, or diodes.

5-35. SERVICING ETCHED CIRCUIT BOARDS.

5-36. Etched circuit boards used in the Model 1402A have components on one side of the board with a plated conductive layer of metal through component holes. Service Note M-20D also contains useful information on etched circuit repair. The important steps and considerations are:

- a. Use a low heat (37 to 47.5 watts, less than 800°F

idling temperature), slightly bent chisel tip (1/16 to 1/8 inch diameter) soldering iron, and a small diameter, high tin content solder. If a rosin solder is used, clean the area thoroughly after soldering.

b. Components may be removed by placing the soldering iron on the component lead on either side of the board, and pulling up on the lead. If heat is applied to the component side of the board, greater care is required to avoid damage to the component (especially true for diodes). If heat damage may occur, grip the lead with a pair of pliers to provide a heat sink between the soldering iron and component.

c. If a component is obviously damaged or faulty, clip the leads close to the component and then unsolder the leads from the board.

d. Large components such as potentiometers and tube sockets may be removed by rotating the soldering iron from lead to lead and applying steady pressure to lift the part free (the alternative is to clip the leads of a damaged part).

e. Since the conductor part of the etched circuit board is a metal-plated surface, covered with solder, use care to avoid overheating and lifting the conductor

from the board. A conductor may be cemented back in place with a quick-drying acetate base cement (use sparingly) having good insulating properties. Another method for repair is to solder a section of good conduction wire along the damaged area.

f. Clear the solder from the circuit board hole before inserting a new component lead. Heat the solder in the hole, remove the iron, and quickly insert a pointed non-metallic object, such as a toothpick.

g. Shape the new component leads and clip to proper length. Insert the leads in the holes and apply heat and solder, preferably on the conductor side.

Table 5-6, Switching Circuit Troubleshooting Voltages

FUNCTION	DC Voltage at Test Point 20	DC Voltages at Test Point 21
A	-2.5	-4.1
ALT	-3.1	-3.1
ALT	-3.1	-3.1
CHOP	-3.1	-3.1
A, B	-1.1	-1.1
B	-4.1	-2.5

Table 5-7. Adjustments Following Component Replacement

Component	Function	Adjustment	Ref Para.
<u>INPUT AMPLIFIERS</u>			
VI02, 202,	Grid Overload Neon Lamp	None	
VI01, 201	Cathode Follower	Input Capacity .005, .01, .02 Gain DC BAL	5-24 5-23 5-10
Q101, 102, 201, 202	Emitter Follower	.005, .01, .02 Gain DC BAL	5-23 5-10
Q103, 104, 203, 204	Differential Amplifier (replace in pairs)	.005, .01, .02 Gain DC BAL	5-23 5-10
CR111, 112, 211, 212	Gating Diode	None	
CR110, 113, 210, 213	Isolation Diode	None	
<u>OUTPUT AMPLIFIER</u>			
Q401, 402	Amplifier	DC BAL SENS CAL Position Adj.	5-10 5-23 5-21
Q403, 404	Emitter Follower	DC BAL SENS CAL	5-10 5-23
Q405, 406	1st Differential Amplifier	DC BAL SENS CAL 1st, 2nd, 3rd HF Adj.	5-10 5-23 5-25
Q407, 408	2nd Differential Amplifier	DC BAL SENS CAL 1st, 2nd, 3rd HF Adj.	5-10 5-23 5-25
V401	Cathode Follower	DC BAL SENS CAL 1st, 2nd, 3rd HF Adj.	5-10 5-23 5-25
V402, 403	Output Differential Amplifier	DC BAL SENS CAL 1st, 2nd, 3rd HF Adj.	5-10 5-23 5-25
CR451, 452, 461, 462	Transient Protection Diode	None	
<u>TRIGGER AMPLIFIER</u>			
Q501, 502, 503, 504	Emitter Follower	None	
Q505, 506, 507, 508	Differential Amplifier	Syne Bal	5-26
Q509, 510	Emitter Follower	Syne Bal	5-26
CR541	Chop Operation H. F. Transient Diode	None	
<u>SWITCHING CIRCUIT</u>			
CR301, 302, 304, 305 CR303 Q301 Q302 Q303, 304	Clipper Diode Blocking Diode Blocking Oscillator Blanking Pulse Amplifier Multivibrator	None None None None None	

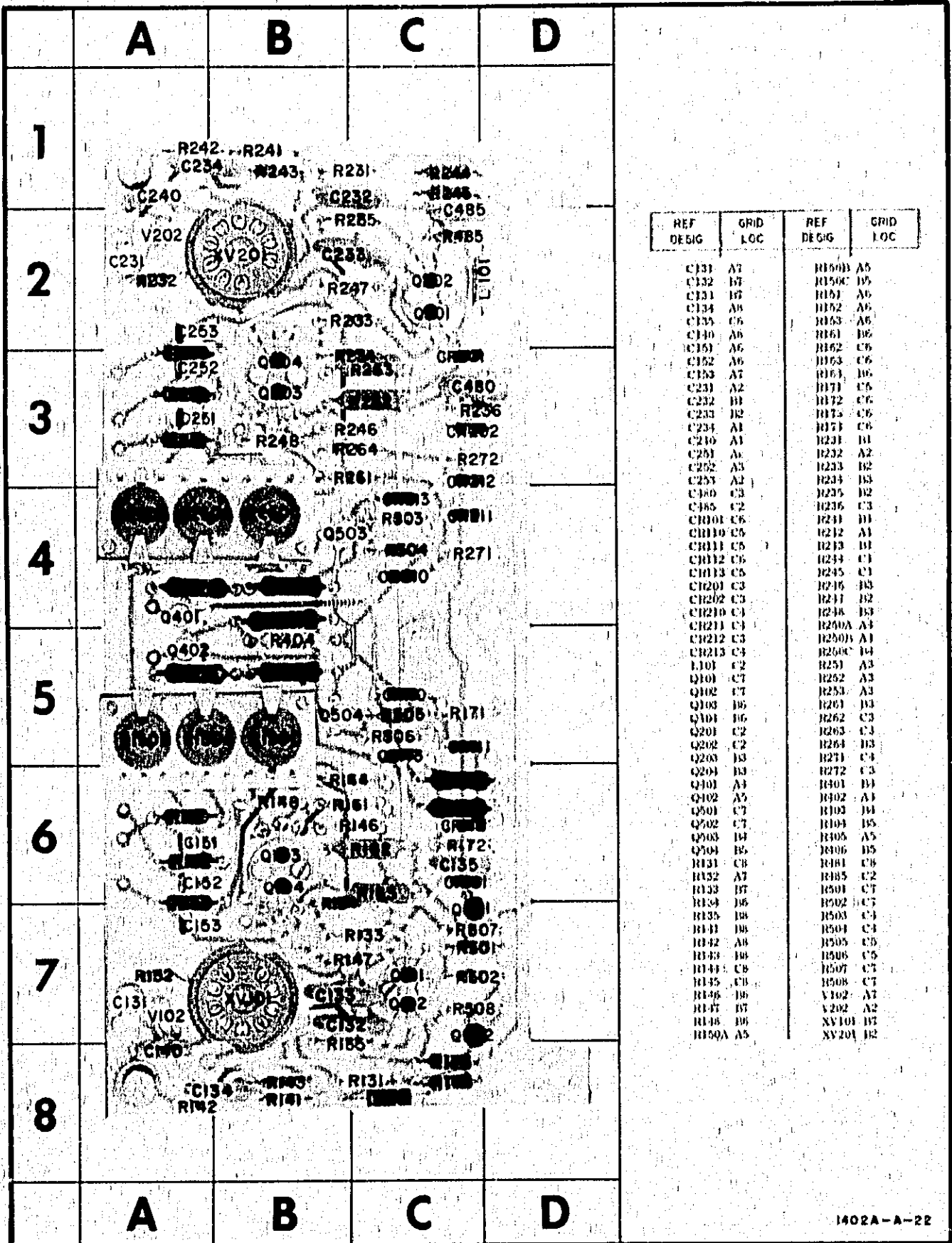

Figure 5-2. Component Locations on Input Amplifier Board A0

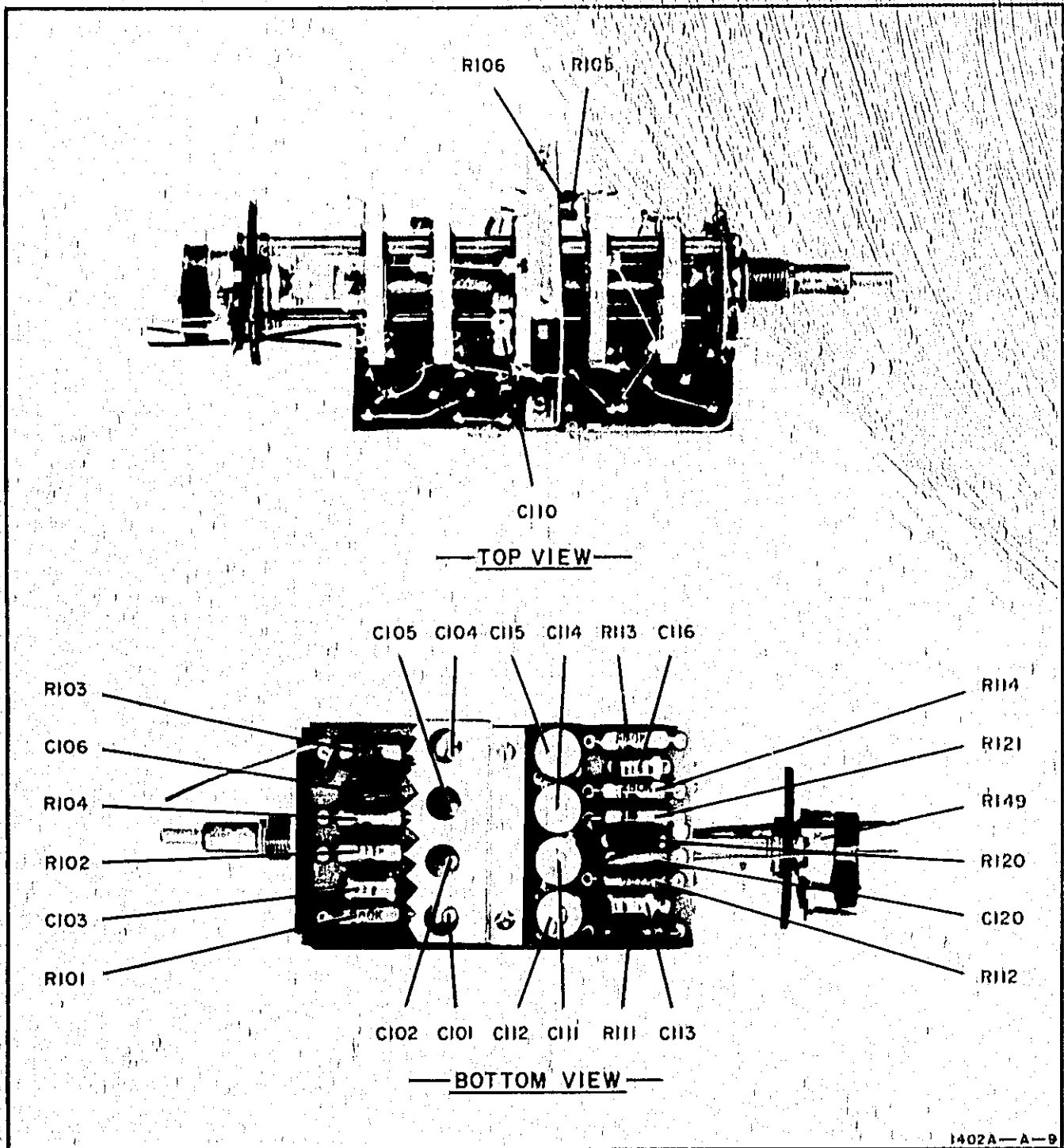

Figure 5-3. Component Locations on Channel A Sensitivity Switch

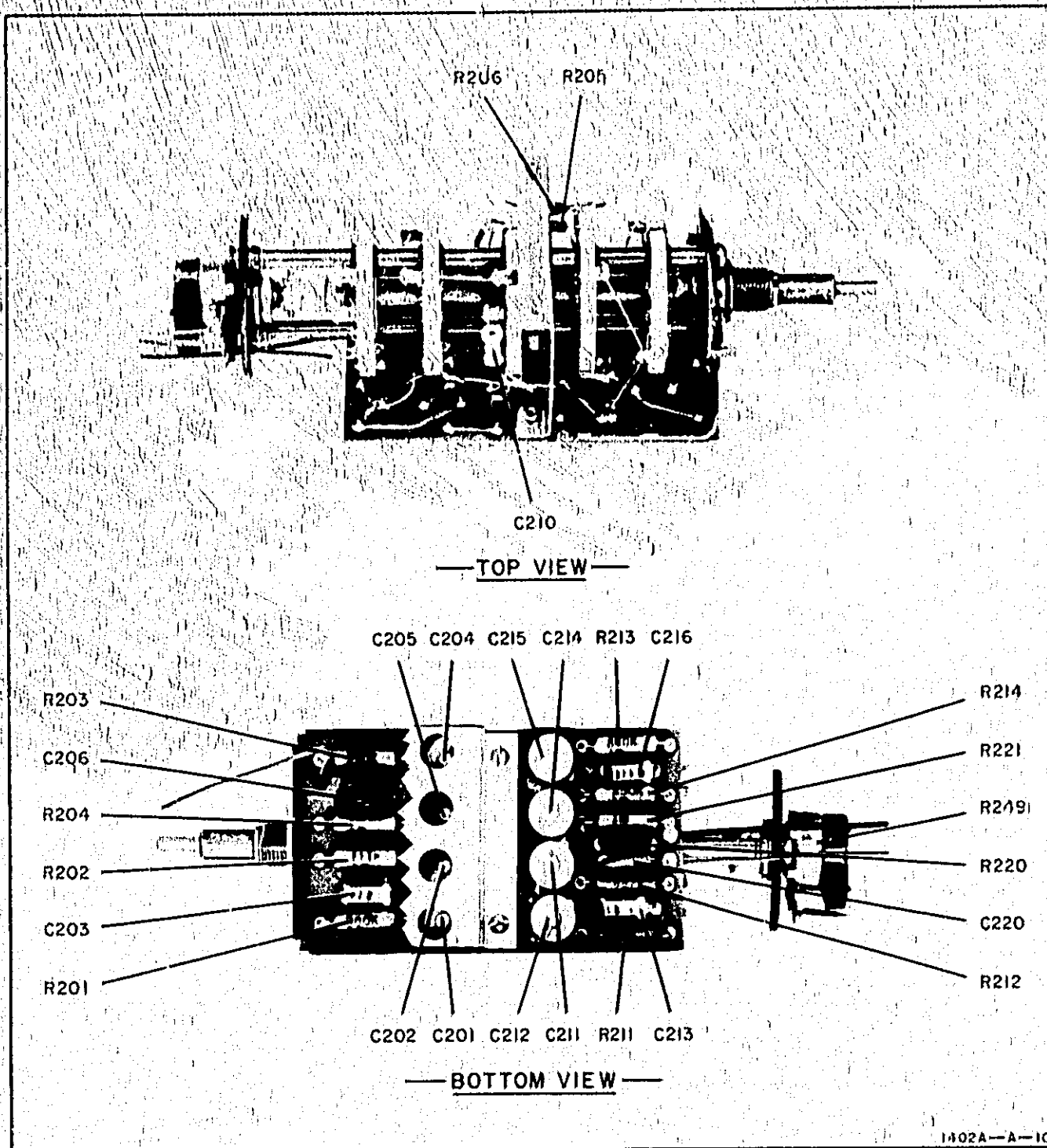

Figure 5-4. Component Locations on Channel B Sensitivity Switch

Table 5-8. Schematic Diagram Notes

Refer to MIL-STD-15-1 for schematic symbols not listed in this table.









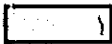

Unless otherwise indicated: capacitance in picofarads inductance in microhenries resistance in ohms		 = Waveform test point (with number)
 = Etched circuit board		 = Common point (with letter)
 = Front panel marking		 = Avalanche (zener) diode
 = Rear panel marking		 = Tunnel diode
 = Front panel control		 = Step recovery diode
 = Screwdriver Adjustment		Numbers in parentheses indicate wire color using resistor color code, e.g. WHT-RED-GRN is (0-2-5). 0 - Black 5 - Green 1 - Brown 6 - Blue 2 - Red 7 - Violet 3 - Orange 8 - Gray 4 - Yellow 9 - White
CW = Clockwise end of variable resistor		P/O = Part of
 = Primary signal path		* = Optimum value selected at factory, average value shown; part may have been omitted.
 = Feedback path		N.C. = No connection

Table 5-0. Conditions for Waveform Measurement
in Channel A, Channel B, Output, and
Trigger Amplifiers
(Test Points 1 through 16)

Model 1402A settings:

FUNCTION	A
SENSITIVITY	0.02 V/CM
COUPLING	DC
INPUT	ON
VERNIER	CAL

Connect 120 mv calibrator signal (see Figure 5-1 to Channel A INPUT.

Test Oscilloscope settings:

TRIGGER SOURCE	+ EXT
LEVEL	AUTO
SWEEP TIME	2 MSEC/CM

Connect 10V CALIBRATOR of Model 140A to external trigger input of Test Oscilloscope.

Test points are indicated for upper half of differential stages only. Square wave signal in the lower half is the same but inverted.

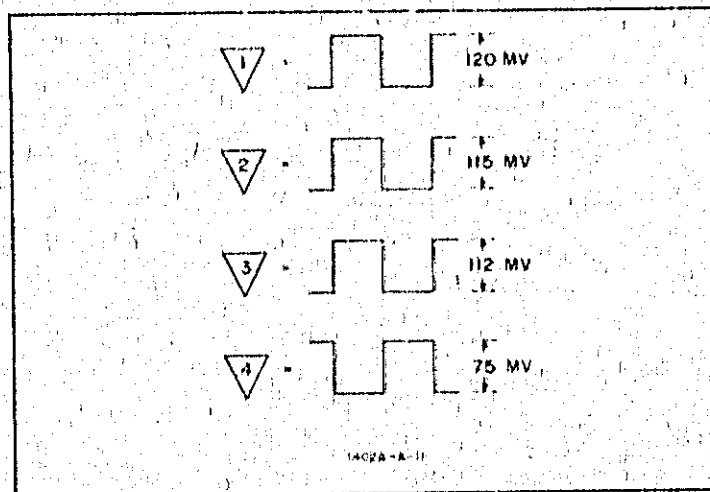

Figure 5-5. Waveforms at Test Points in Channel A

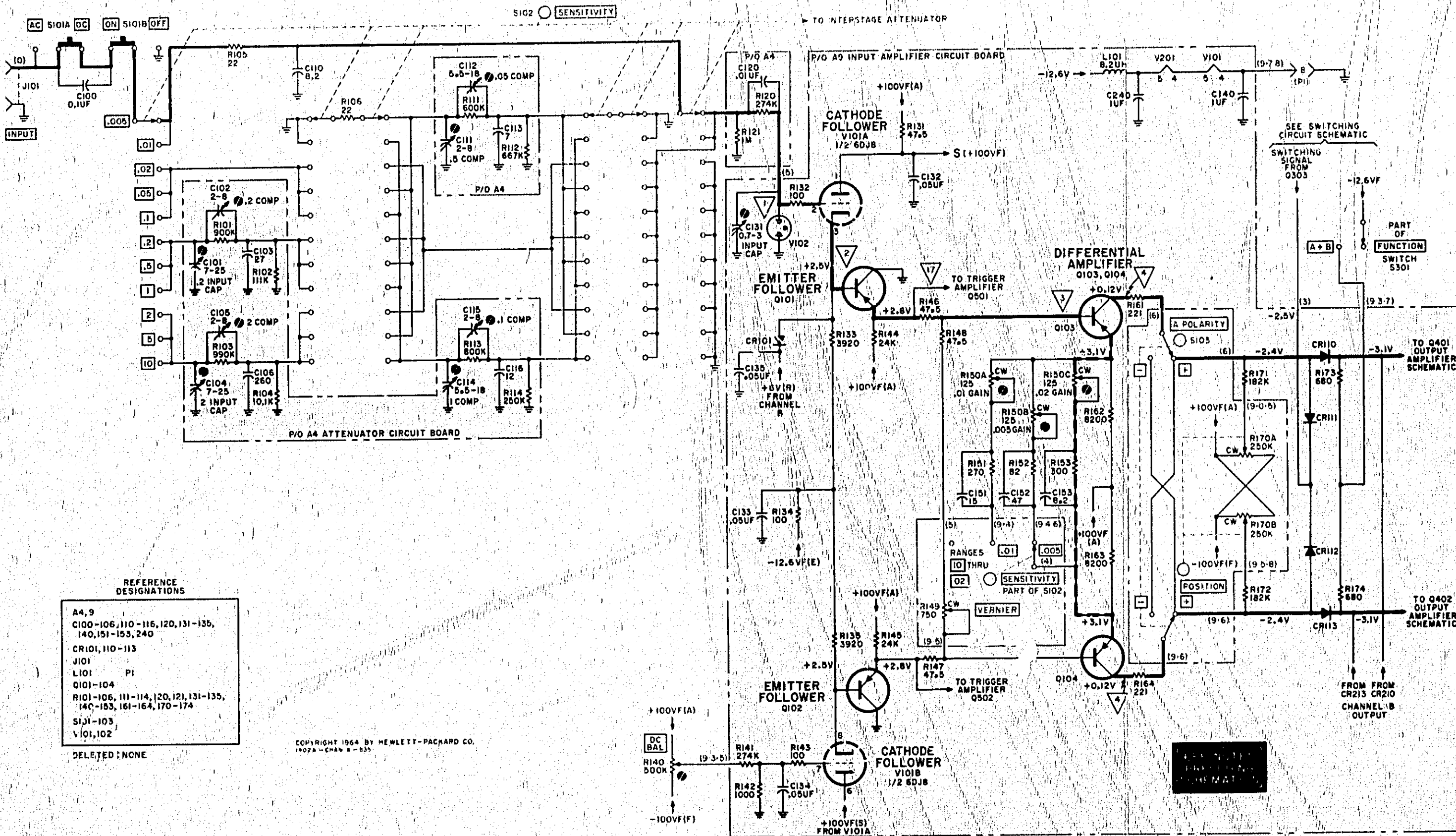

Figure 5-6. Channel A Amplifier Schematic Diagram

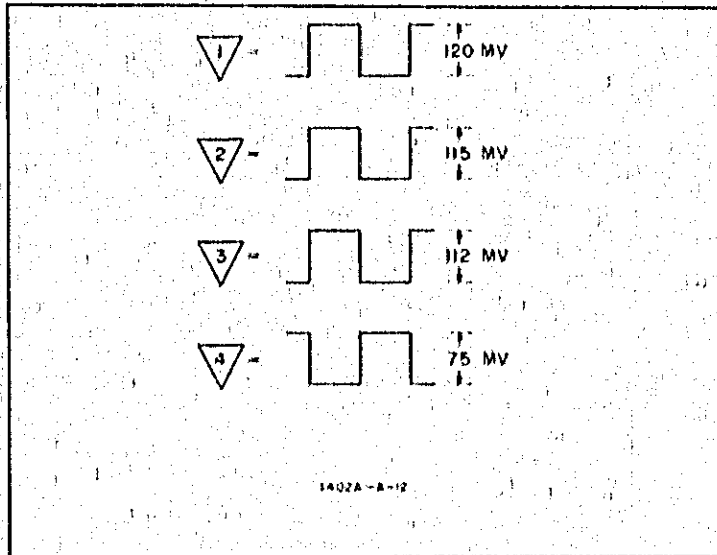

Figure 5-7. Waveforms at Test Points in Channel B

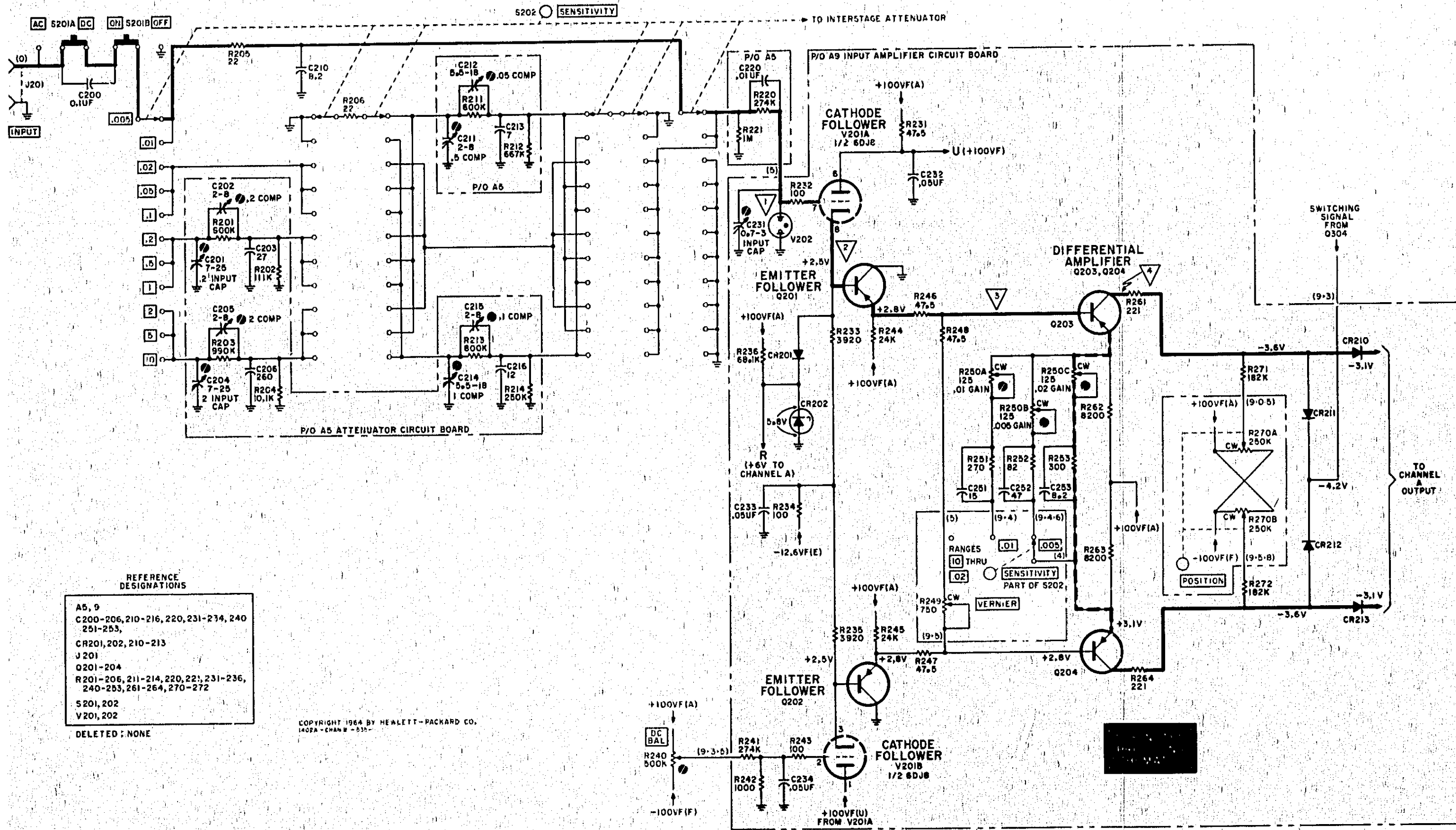
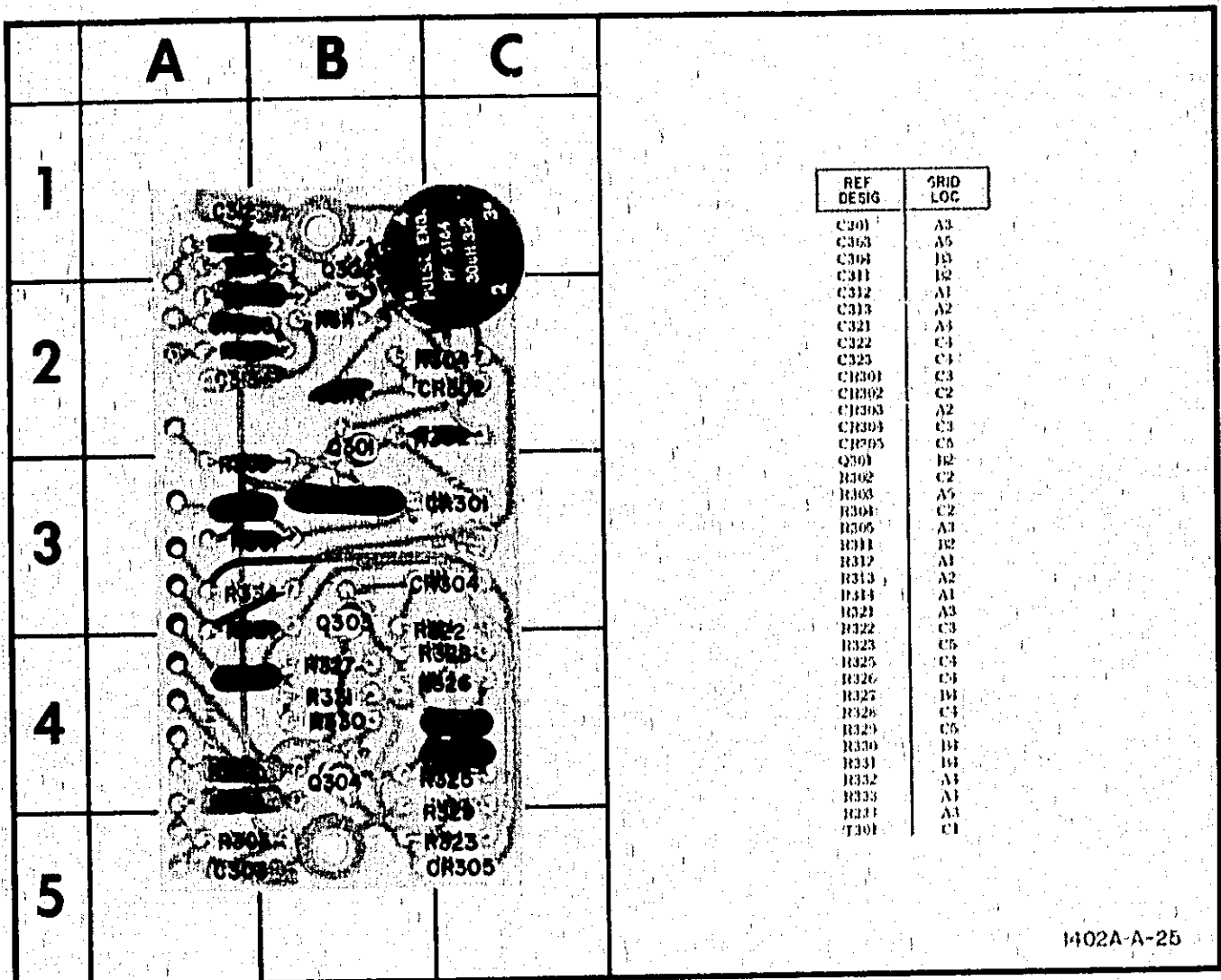

Figure 5-8. Channel B Amplifier Schematic Diagram



1402A-A-25

Figure 5-9. Component Locations on Switching Circuit Board A2

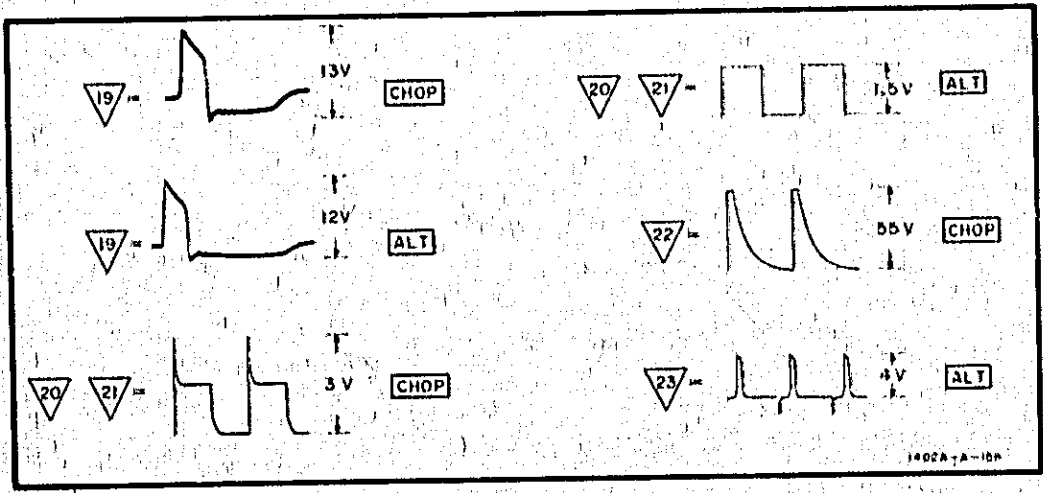
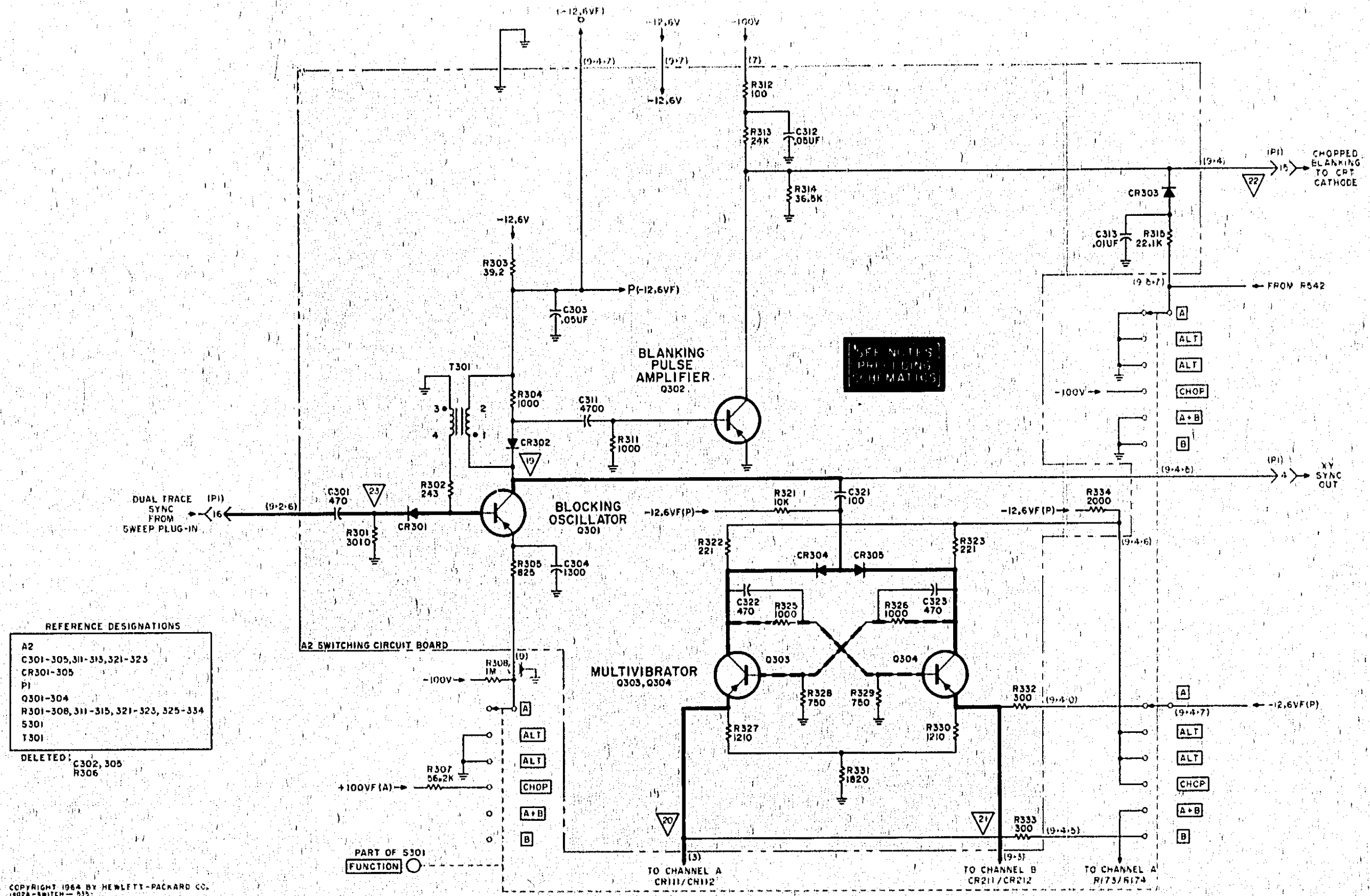

Figure 5-10. Waveforms at Test Points in Switching Circuit



COPYRIGHT 1964 BY HEWLETT-PACKARD CO.
1402A-SWITCH-535

Figure 5-11, Switching Circuit Schematic Diagram

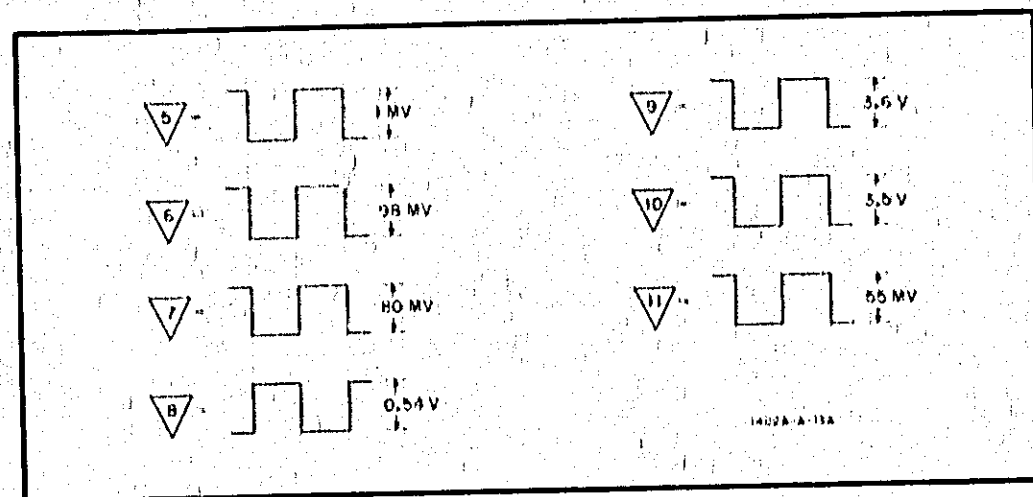

Figure 5-12. Waveforms at Test Points in Output Amplifier

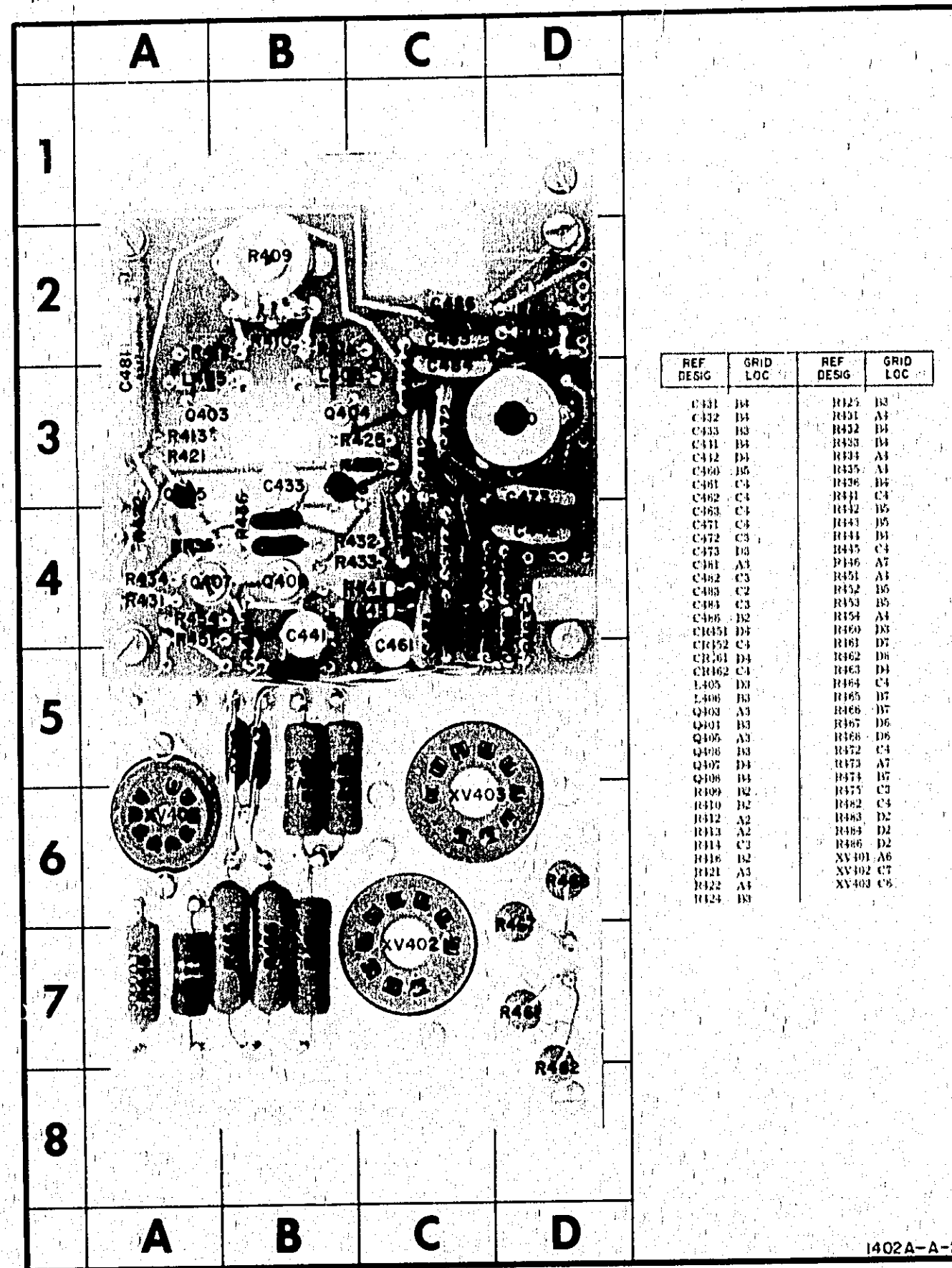
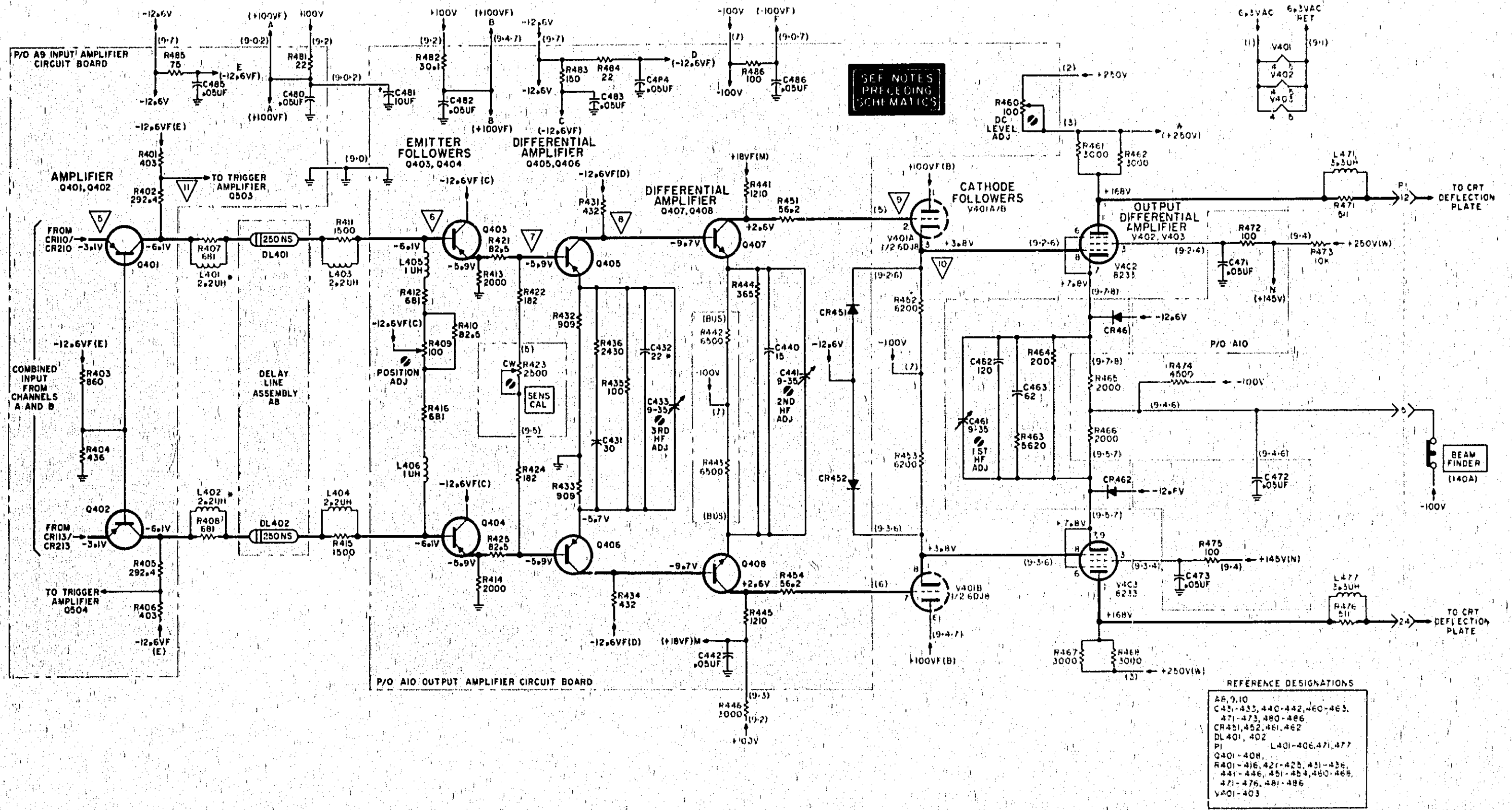

Figure 5-13. Component Locations on Output Amplifier Board A10 and Deck



DESIGNED BY HEWLETT-PACKARD CO.
DATE: OUTPUT AMP - 477A

Figure 5-14. Output Amplifier Schematic Diagram

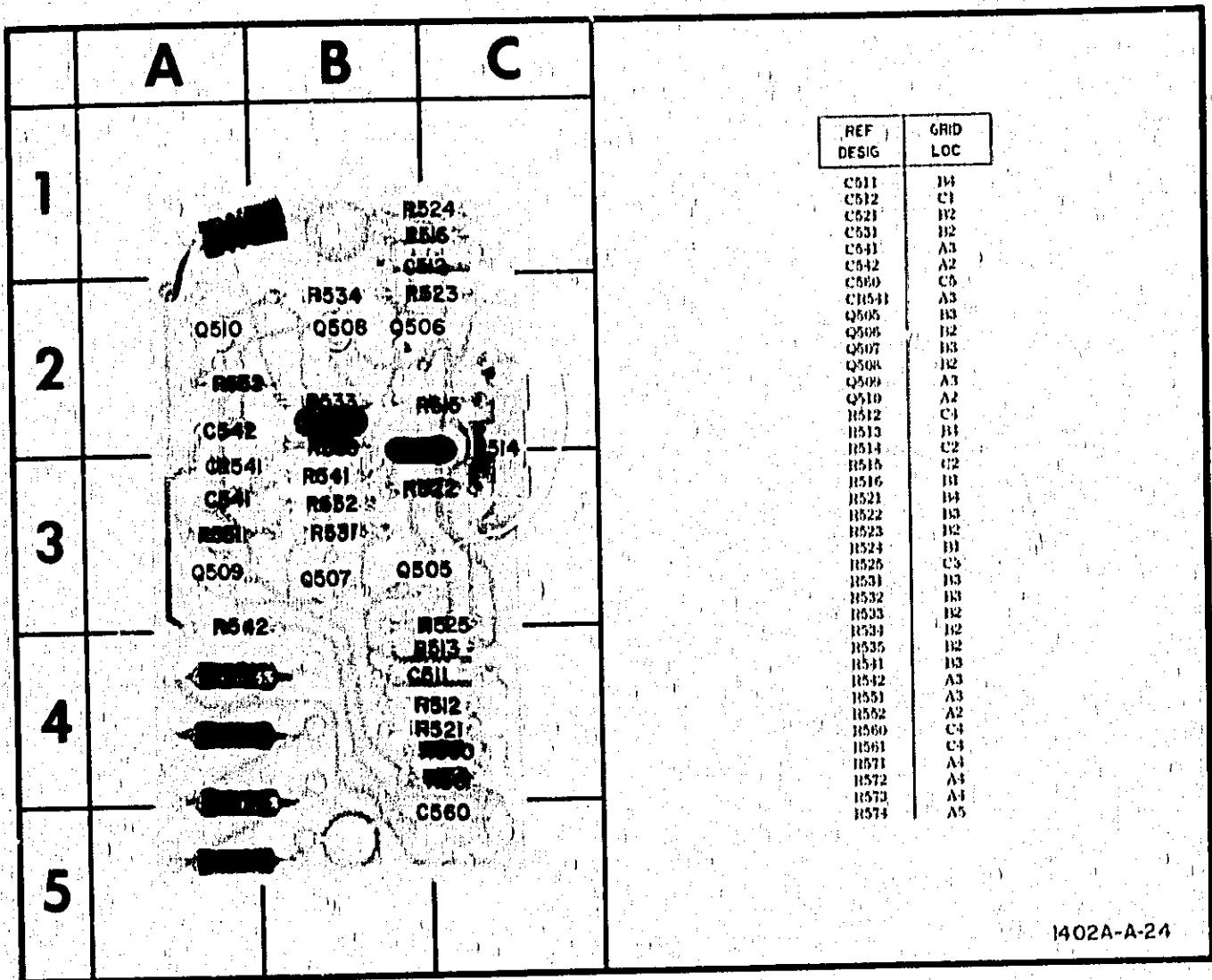

Figure 5-15. Component Locations on Trigger Amplifier Board A3

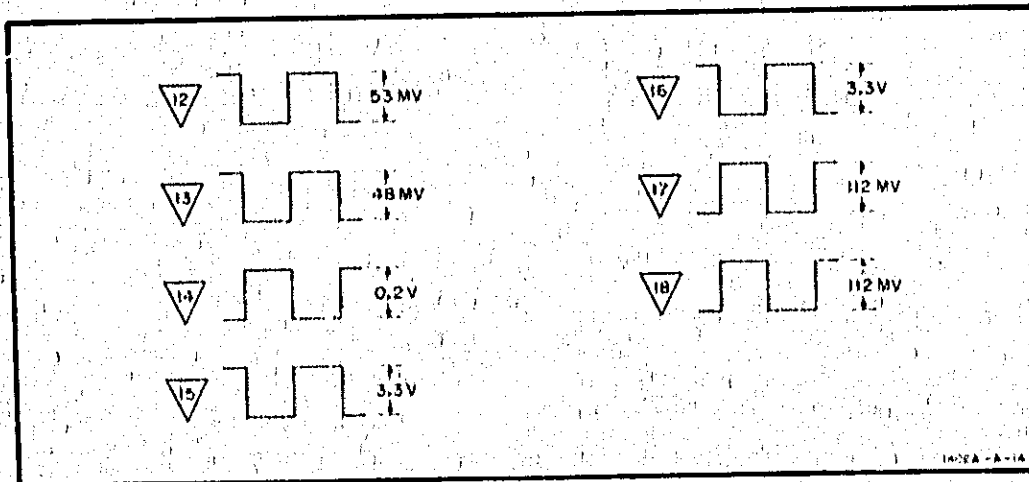

Figure 5-16. Waveforms at Test Points in Trigger Amplifier

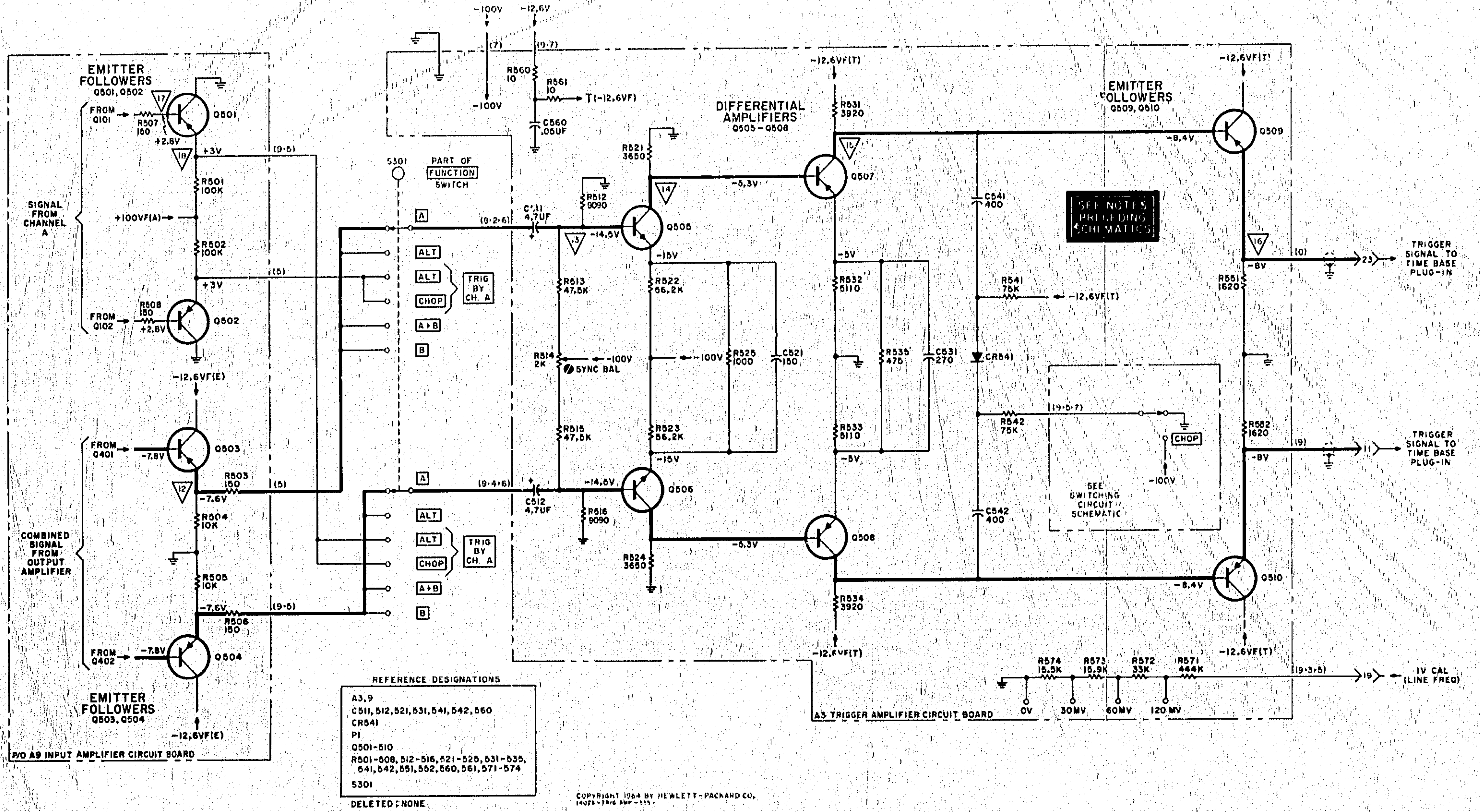

Figure 5-17. Trigger Amplifier Schematic Diagram

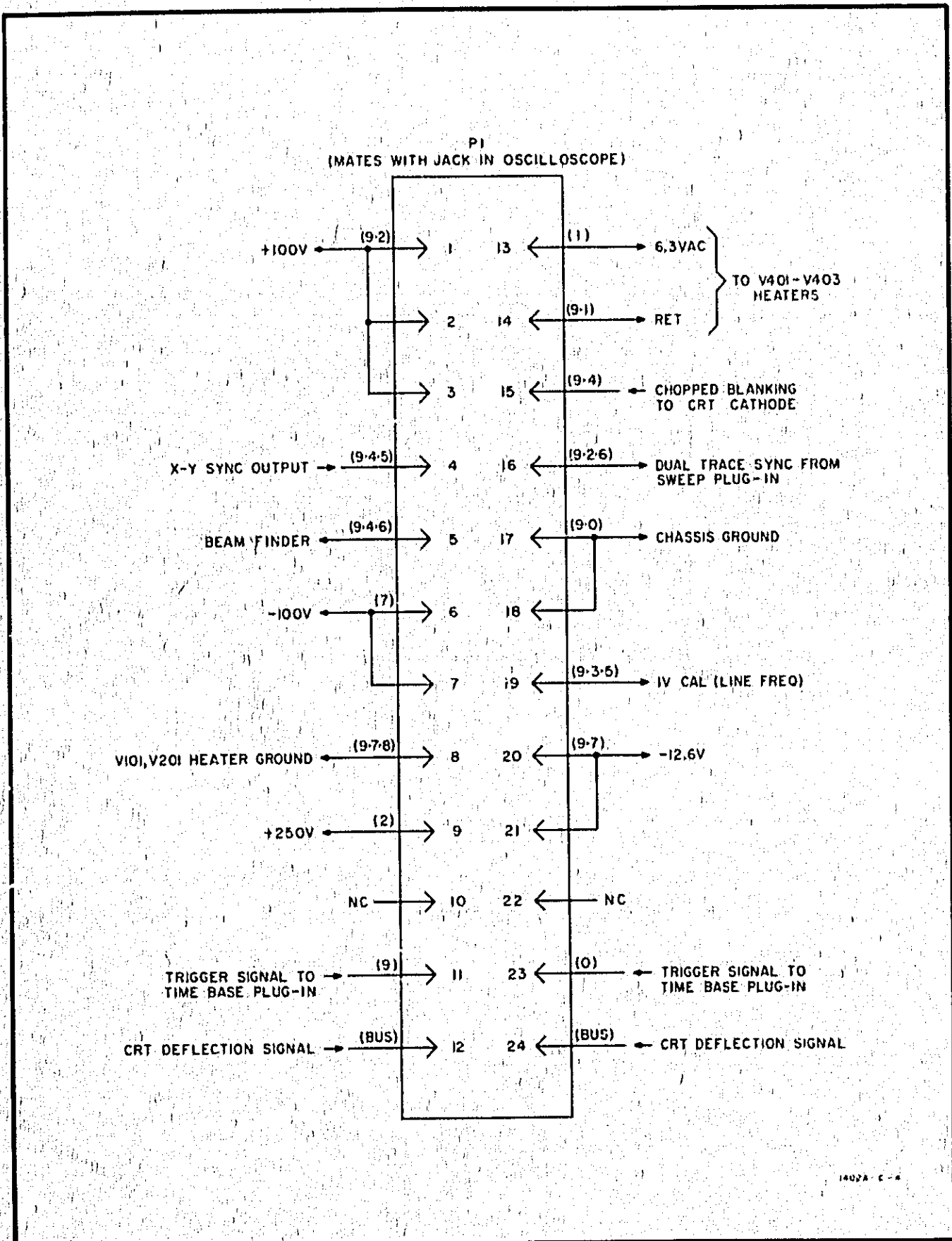

Figure 5-18. Interconnection Plug Schematic Diagram

PARTS LIST

SECTION VI REPLACEABLE PARTS

6-1. INTRODUCTION.

6-2. This section contains information for ordering replaceable parts for the instrument. Table 6-1 lists reference designators and abbreviations that are used in the Table 6-2 component descriptions. Table 6-2 lists the parts in alpha-numerical order of their reference designations (unassigned designators are not listed) and provides the following information for each item:

- a. hp Part Number.
- b. Total quantity (TQ) used in instrument; given only first time the part number is listed.
- c. Description of part (refer to Table 6-1).
- d. Typical manufacturer of the part in a five-digit code, except for Hewlett-Packard Company; see code list of manufacturer's, Table 6-3, for name.
- e. Manufacturer's part number.

6-3. Parts not identified by a reference designation are listed at the end of Table 6-3, under miscellaneous.

6-4. ORDERING INFORMATION.

6-5. To order replacement parts from the Hewlett-Packard Company, address the order or inquiry to the nearest Hewlett-Packard Sales/Service Office (see list of addresses at rear of this manual) and supply the following information:

- a. hp Part Number of item(s).
- b. Model number and eight-digit serial number of instrument.

6-6. To order a part not listed in Table 6-2, provide the following information:

- a. Model number and eight-digit serial number of instrument.
- b. Description of part including function and location.

6-7. To order a part from a manufacturer other than the Hewlett-Packard Company, provide the complete part description and the manufacturer's part number from Table 6-2.

Table 6-1. List of Reference Designators and Abbreviations.

REFERENCE DESIGNATORS			
A	assembly	E	misc electronic part
B	motor	F	fuse
C	capacitor	FL	filter
CP	coupling	J	jack
CR	diode	K	relay
DL	delay line	L	inductor
DS	device signaling (lamp)	M	meter
		MP	mechanical part
		P	plug
		Q	transistor
		R	resistor
		RT	thermistor
		S	switch
		T	transformer
		TB	terminal board
		TP	test point
		V	vacuum tube, neon bulb, photocell, etc.
		W	wire
		X	socket
		Y	crystal

ABBREVIATIONS			
A	amperes	GE	germanium
A.F.C	automatic frequency control	GL	glass
AMPL	amplifier	GRD	ground(s)
		H	henries
B. F. O.	beat frequency oscillator	HEX	hexagonal
BE CU	beryllium copper	Hg	mercury
BH	binder head	hp	Hewlett-Packard
BP	bushings	HR	hour(s)
BRS	brass	IF	intermediate freq
BWO	backward wave oscillator	IMP	impregnated
		INCD	incandescent
CCW	counter-clockwise	INCL	include(s)
CER	ceramic	INS	insulation(s)
CMO	cabinet mount only	INT	internal
COEF	coefficient		
COM	common	K	kilo - 1000
COMP	composition		
CONN	connector	LIN	linear taper
CP	cadmium plate	LK WASH	lock washer
CRT	cathode-ray tube	LOG	logarithmic taper
CW	clockwise	LPF	low pass filter
DEPC	deposited carbon	M	milli - 10 ⁻³
DR	drive	MEG	meg - 10 ⁶
		METFLM	metal film
ELECT	electrolytic	MFR	manufacturer
ENCAP	encapsulated	MINAT	miniature
EXT	external	MOM	momentary
		MTU	mounting
F	farads	MY	"mylar"
FH	flat head	N	nano (10 ⁻⁹)
FIL H	filister head		
FXD	fixed		
		N/C	normally closed
		NE	neon
		NI PL	nickel plate
		N/O	normally open
		NPO	negative positive zero (zero temperature coefficient)
		NRFR	not recommended for field replacement
		NSR	not separately replaceable
		OBDD	order by description
		OH	oval head
		OX	oxide
		P	peak
		PC	printed circuit
		PF	picofarads
			10 ⁻¹² farads
		P BRZ	phosphor bronze
		PHL	Phillips
		PIV	peak inverse voltage
		P/O	part of
		POLY	polystyrene
		PORC	porcelain
		POS	position(s)
		POT	potentiometer
		PP	peak-to-peak
		PT	point
		RECT	rectifier
		RF	radio frequency
		RH	round head
		RMO	rack mount only
		RMS	root-mean-square
		S-B	slow-blow
		SCR	acrow selenium
		SE	selenium
		SECT	section(s)
		SEMICON	semiconductor
		SI	silicon
		SIL	silver
		SL	slide
		SPL	special
		SST	stainless steel
		SR	split ring
		STL	steel
		TA	tantalum
		TD	time delay
		TGL	toggle
		TI	titanium
		TOL	tolerance
		TRIM	trimmer
		TWT	traveling wave tube
		U	micro - 10 ⁻⁶
		VAR	variable
		VDCW	dc working volts
		W	with
		W	watts
		WW	wirewound
		W/O	without

Table 6-2. Replaceable Parts

Ref Desig	hp Part No.	RS	TQ	Description (See Table 6-1.)	Mfr	Mfr Part No.
A2	01402-66502		1	A: switching circuit board	hp	
A3	01402-66503		1	A: trigger amplifier circuit board	hp	
A4	01402-66504		1	A: attenuator circuit board	hp	
A5	01402-66504		1	A: attenuator circuit board	hp	
A6	01402-63401		1	A: attenuator channel A (includes A4)	hp	
A7	01402-63401		1	A: attenuator channel B (includes A5)	hp	
A8	01402-61601		1	A: delay line	hp	
A9	01402-66505		1	A: input amplifier circuit board	hp	
A10	01402-66506		1	A: output amplifier circuit board	hp	
C100	0170-0022		2	C: fxd my 0.1 μ f 20% 600vdcw	09134	Type 24
C101	0121-0114		4	C: var eer 7-25pf	hp	
C102	0121-0060		8	C: var eer disk 2-8pf 300vdcw	hp	
C103	0160-0115		2	C: fxd eer 27pf 10% 500vdcw	71500	CC20 TCN 27
C104	0121-0114			C: var eer 7-25pf	hp	
C105	0121-0060			C: var eer disk 2-8pf 300vdcw	hp	
C106	0140-0223		2	C: fxd mica 280pf 1% 300vdcw	04062	RDM15F261F3C
C110	0150-0062		4	C: fxd eer 8.2pf \pm 25pf 500vdcw	72082	301-011-COHO-820C
C111	0121-0060			C: var eer disk 2-8pf 300vdcw	hp	
C112	0121-0061		4	C: var eer disk 5.5-18pf 300vdcw	hp	
C113	0150-0074		2	C: fxd eer 7pf \pm 5pf 500vdcw	72082	301-000-COHO-709D
C114	0121-0061			C: var eer disk 5.5-18pf 300vdcw	hp	
C115	0121-0060			C: var eer disk 2-8pf 300vdcw	hp	
C116	0160-0132		2	C: fxd eer 12pf 5% 500vdcw	72082	301-000-COGO-120J
C120	0150-0012		3	C: fxd eer 0.01 μ f 20% 1000vdcw	56280	29C214A3
C131	0132-0006		2	C: var rexolite 0.7-3pf 350vdcw	72082	535-034-4R
C132	0150-0052		20	C: fxd eer 0.05 μ f 20% 400vdcw	56280	33C17A
C133	0150-0052			C: fxd eer 0.05 μ f 20% 400vdcw	56280	33C17A
C134	0150-0052			C: fxd eer 0.05 μ f 20% 400vdcw	56280	33C17A
C135	0150-0052			C: fxd eer 0.05 μ f 20% 400vdcw	56280	33C17A
C140	0160-0127		2	C: fxd eer 1 μ f 20% 25vdcw	56280	5C13
C151	0150-0064		2	C: fxd eer 15pf 5% 500vdcw	72082	301-011-COGO-150J
C152	0150-0116		2	C: fxd eer 47pf 10% 500vdcw	71500	CC20 TCN 47
C153	0150-0062			C: fxd eer 8.2- \pm 25pf 500vdcw	72082	301-011-COHO-820C
C200	0170-0022			C: fxd my 0.01 μ f 20% 600vdcw	09134	Type 24
C201	0121-0114			C: var eer 7-25pf	hp	
C202	0121-0060			C: var eer disk 2-8pf 300vdcw	hp	
C203	0150-0115			C: fxd eer 27pf 10% 500vdcw	71500	CC20 TCN 27
C204	0121-0114			C: var eer 7-25pf	hp	
C205	0121-0060			C: var eer disk 2-8pf 300vdcw	hp	
C206	0140-0223			C: fxd mica 280pf 1% 300vdcw	04062	RDM15F261F3C
C210	0150-0062			C: fxd eer 8.2pf \pm 25pf 500vdcw	72082	301-011-COHO-820C
C211	0121-0060			C: var eer disk 2-8pf 300vdcw	hp	
C212	0121-0061			C: var eer disk 5.5-18pf 300vdcw	hp	
C213	0160-0074			C: fxd eer 7pf \pm 5pf 500vdcw	72082	301-000-COHO-709D
C214	0121-0061			C: var eer disk 5.5-18pf 300vdcw	hp	
C215	0121-0060			C: var eer disk 2-8pf 300vdcw	hp	
C216	0160-0132			C: fxd eer 12pf 5% 500vdcw	72082	301-000-COGO-120J
C220	0150-0012			C: fxd eer 0.01 μ f 20% 1000vdcw	56280	29C214A3
C231	0132-0006			C: var rexolite 0.7-3pf 350vdcw	72082	535-034-4R
C232	0150-0052			C: fxd eer 0.05 μ f 20% 400vdcw	56280	33C17A
C233	0150-0052			C: fxd eer 0.05 μ f 20% 400vdcw	56280	33C17A
C234	0150-0052			C: fxd eer 0.05 μ f 20% 400vdcw	56280	33C17A
C240	0160-0127			C: fxd eer 1 μ f 20% 25vdcw	56280	5C13
C251	0150-0064			C: fxd eer 15pf 5% 500vdcw	72082	301-011-COGO-150J
C252	0150-0116			C: fxd eer 47pf 10% 500vdcw	71500	CC20 TCN 47
C253	0150-0062			C: fxd eer 8.2 pf \pm 25pf 500vdcw	72082	301-011-COHO-820C

Table 6-2. Replaceable Parts (Cont'd)

Ref Desig	hp Part No.	RS	TQ	Description / (See Table 6-1.)	Mfr	Mfr Part No.
C301	0140-0149		3	C: fxd mica 470pf 5% 300vdew	04062	RDM15F471J3S
C303	0150-0052			C: fxd cer 0.05pf 20% 400vdew	56289	33C17A
C304	0140-0154		1	C: fxd mica 1300pf 5% 500vdew	04062	RDM20F132J5S
C311	0150-0075		1	C: fxd cer 4700pf +100%-20% 500vdew	72082	851-000-X5UO-472
C312	0150-0052			C: fxd cer 0.05pf 20% 400vdew	56289	33C17A
C313	0150-0012			C: fxd cer 0.01pf 20% 1000vdew	56289	20C214A3
C321	0140-0176		1	C: fxd mica 100pf 2% 300vdew	04062	RDM15F101G3C
C322	0140-0149			C: fxd mica 470pf 5% 300vdew	04062	RDM15F471J3S
C323	0140-0149			C: fxd mica 470pf 5% 300vdew	04062	RDM15F471J3S
C431	0140-02C3		1	C: fxd mica 30pf 5% 500vdew	04062	DM15E300J 500V
C432	0140-0145		1	C: fxd mica 22pf 5% 500vdew	04062	RDM15C220J
C433	0121-0046		3	C: var cer 9-35pf 500vdew	hp	
C440	0140-0202		1	C: fxd mica 15pf 5% 500vdew	hp	
C441	0121-0046			C: var cer 9-35pf 500vdew	hp	
C442	0150-0052			C: fxd cer 0.05pf 20% 400vdew	56289	33C17A
C461	0121-0046			C: var cer 9-35pf 500vdew	hp	
C462	0140-0216		1	C: fxd mica 120pf 2% 300vdew	04062	RDM15F121G3C
C463	0140-0205		1	C: fxd mica 62pf 5% 300vdew	04062	RDM15E620J3C
C471	0150-0052			C: fxd cer 0.05pf 20% 400vdew	56289	33C17A
C472	0150-0052			C: fxd cer 0.05pf 20% 400vdew	56289	33C17A
C473	0150-0052			C: fxd cer 0.05pf 20% 400vdew	56289	33C17A
C480	0150-0052			C: fxd cer 0.05pf 20% 400vdew	56289	33C17A
C481	0180-0089		1	C: fxd elect 10pf -10% +100% 150vdew	56289	30D106G150DF4
C482	0150-0052			C: fxd cer 0.05pf 20% 400vdew	56289	33C17A
C483	0150-0052			C: fxd cer 0.05pf 20% 400vdew	56289	33C17A
C484	0150-0052			C: fxd cer 0.05pf 20% 400vdew	56289	33C17A
C485	0150-0052			C: fxd cer 0.05pf 20% 400vdew	56289	33C17A
C486	0150-0052			C: fxd cer 0.05pf 20% 400vdew	56289	33C17A
C511	0180-0100		2	C: fxd elect TA 4.7pf 10% 35vdew	56289	150D475X0035B2
C512	0180-0100			C: fxd elect TA 4.7pf 10% 35vdew	56289	150D475X0035B2
C521	0140-0106		1	C: fxd mica 150pf 5% 300vdew	04062	RDM15F151J3C
C531	0140-0206		1	C: fxd mica 270pf 5% 500vdew	04062	RDM15F271J5C
C541	0150-0071		2	C: fxd cer 400pf 5% 500vdew	56289	19C FORMULATION 2B
C542	0150-0071			C: fxd cer 400pf 5% 500vdew	56289	19C FORMULATION 2B
C560	0150-0052			C: fxd cer 0.05pf 20% 400vdew	56289	33C17A
CR101	1901-0040		10	CR: si	hp	
CR110	1901-0040			CR: si	hp	
CR111	1901-0040			CR: si	hp	
CR112	1901-0040			CR: si	hp	
CR113	1901-0040			CR: si	hp	
CR201	1901-0040			CR: si	hp	
CR202	1902-0034		1	CR: avalanche 5.8v 10% 400mw	hp	
CR210	1901-0040			CR: si	hp	
CR211	1901-0040			CR: si	hp	
CR212	1901-0040			CR: si	hp	
CR213	1901-0040			CR: si	hp	
CR301	1910-0016		5	CR: ge	hp	
CR302	1910-0016			CR: ge	hp	
CR303	1901-0025		1	CR: si	hp	
CR304	1910-0016			CR: ge	hp	

Table 6-2. Replaceable Parts (Cont'd)

Ref Desig	hp Part No.	HS	TQ	Description (See Table 6-1.)	Mfr	Mfr Part No.
CR305	1910-0016			CR: ge	hp	
CR451	1901-0096	4	4	CR: si	hp	
CR452	1901-0096			CR: si	hp	
CR461	1901-0096			CR: si	hp	
CR462	1901-0096			CR: si	hp	
CR541	1910-0016			CR: ge	hp	
DL401				NSR (P/O AB)		
DL402				NSR (P/O AB)		
J101	1250-0118	0	2	J: Connector-BNC	91737	8427
J201	1250-0118			J: Connector-BNC	91737	8427
L101	0140-0105	1	1	L: coil-RF fxd 8.2:h	99809	1537-34
L401	0140-0142	1	4	L: coil-fxd RF 2.2:h	hp	
L402	0140-0142			L: coil-fxd RF 2.2:h	hp	
L403	0140-0142			L: coil-fxd RF 2.2:h	hp	
L404	0140-0142			L: coil-fxd RF 2.2:h	hp	
L405	0140-0096	1	2	L: coil-fxd RF 1:h	hp	
L406	0140-0096			L: coil-fxd RF 1:h	hp	
L471	0140-0111	1	2	L: coil-fxd RF 3.3:h	hp	
L477	0140-0111			L: coil-fxd RF 3.3:h	hp	
P1	1251-0055	0	1	P: conn-24-contact male	hp	
Q101	1853-0015	4	4	Q: transistor si PNP 2N3640	07263	2N3640
Q102	1853-0015			Q: transistor si PNP 2N3640	07263	2N3640
Q103	5080-0445	2	2	Q: transistor, selected, matched pair (includes Q104)	hp	
Q104				NSR (P/O Q103)		
Q201	1853-0015			Q: transistor si PNP 2N3640	07263	2N3640
Q202	1853-0015			Q: transistor si PNP 2N3640	07263	2N3640
Q203	5080-0445			Q: transistor, selected, matched pair (includes Q204)	hp	
Q204				NSR (P/O Q203)		
Q301	1850-0158	5	5	Q: transistor PNP ge 2N2635	01295	2N2635
Q302	1850-0103	1	1	Q: transistor 2N2100	01295	2N2100
Q303	1850-0158			Q: transistor PNP ge 2N2635	01295	2N2635
Q304	1850-0158			Q: transistor PNP ge 2N2635	01295	2N2635
Q401	1850-0158			Q: transistor PNP ge 2N2635	01295	2N2635
Q402	1850-0158			Q: transistor PNP ge 2N2635	01295	2N2635
Q403	1850-0090	2	2	Q: transistor ge 2N964 PNP	04713	2N964
Q404	1850-0090			Q: transistor ge 2N964 PNP	04713	2N964
Q405	1850-0137	2	2	Q: transistor PNP ge 2N976	56289	2N976
Q406	1850-0137			Q: transistor PNP ge 2N976	56289	2N976
Q407	1854-0091	2	2	Q: transistor NPN si 2N3137	hp	
Q408	1854-0091			Q: transistor NPN si 2N3137	hp	
Q501	1853-0009	6	6	Q: transistor si PNP	hp	
Q502	1853-0009			Q: transistor si PNP	hp	
Q503	1850-0119	2	2	Q: transistor PNP ge EIA 2N963	04713	2N963
Q504	1850-0119			Q: transistor PNP ge EIA 2N963	04713	2N963
Q505	1854-0005	2	2	Q: transistor 2N708 NPN si	07263	2N708
Q506	1854-0005			Q: transistor 2N708 NPN si	07263	2N708
Q507	1853-0009			Q: transistor si PNP	hp	
Q508	1853-0009			Q: transistor si PNP	hp	
Q509	1853-0009			Q: transistor si PNP	hp	
Q510	1853-0009			Q: transistor si PNP	hp	

Table 6-2, Replaceable Parts (Cont'd)

Ref Desig	hp Part No.	RS	TRQ	Description (See Table 6-1.)	Mfr	Mfr Part No.
R101	0727-0231	1	2	R: fxd depe 000k ohm 1% 1/2w	hp	
R102	0727-0212	1	2	R: fxd depe 111k ohm 1% 1/2w	hp	
R103	0727-0271	1	2	R: fxd depe 990k ohm 1% 1/2w	hp	
R104	0727-0158	1	2	R: fxd cflm 10.1k ohm 1% 1/2w	hp	
R105	0683-2205	1	5	R: fxd comp 22 ohm 5% 1/4w	01121	CB2205
R106	0683-2205			R: fxd comp 22 ohm 5% 1/4w	01121	CB2205
R111	0727-0246	1	2	R: fxd depe 600k ohm 1% 1/2w	hp	
R112	0727-0249	1	2	R: fxd depe 667k ohm 1% 1/2w	hp	
R113	0727-1009	1	2	R: fxd depe 800k ohm 1% 1/2w	hp	
R114	0727-0226	1	2	R: fxd depe 250k ohm 1% 1/2w	hp	
R120	0757-0476	1	4	R: fxd met flm 274k ohm 1% 1/8w	hp	
R121	0727-0276	1	2	R: fxd depe 1 meg ohm 1% 1/2w	hp	
R131	0757-0393	2	8	R: fxd met flm 47.5 ohm 1% 1/8w	hp	
R132	0757-0401	3	11	R: fxd met flm 100 ohm 1% 1/8w	hp	
R133	0757-0435	2	6	R: fxd met flm 3.92k ohm 1% 1/8w	hp	
R134	0757-0401			R: fxd met flm 100 ohm 1% 1/8w	hp	
R135	0757-0435			R: fxd met flm 3.92k ohm 1% 1/8w	hp	
R140	2100-0423	1	2	R: var comp lin 500k ohm 20% 1/5w	hp	
R141	0757-0476			R: fxd met flm 274k ohm 1% 1/8w	hp	
R142	0757-0280	2	7	R: fxd met flm 1k ohm 1% 1/8w	hp	
R143	0757-0401			R: fxd met flm 100 ohm 1% 1/8w	hp	
R144	0758-0073	1	5	R: fxd met flm 24k ohm 5% 1/2w	hp	
R145	0758-0073			R: fxd met flm 24k ohm 5% 1/2w	hp	
R146	0757-0393			R: fxd met flm 47.5 ohm 1% 1/8w	hp	
R147	0757-0393			R: fxd met flm 47.5 ohm 1% 1/8w	hp	
R148	0757-0393			R: fxd met flm 47.5 ohm 1% 1/8w	hp	
R149	2100-0948	1	2	R: var comp 750ohm 20% 20cwlog 1/4w	hp	
R150	2100-0947	1	2	R: var comp 3x125 ohm 30% lin 1/4w	hp	
R151	0758-0028	1	2	R: fxd met flm 270 ohm 5% 1/2w	hp	
R152	0758-0026	1	2	R: fxd met flm 82 ohm 5% 1/2w	hp	
R153	0758-0016	1	2	R: fxd met flm 300ohm 5% 1/2w	hp	
R161	0757-0282	2	6	R: fxd met flm 221 ohm 1% 1/8w	hp	
R162	0811-1574	1	4	R: fxd ww 8200 ohms 1% 3w	hp	
R163	0811-1574			R: fxd ww 8200 ohms 1% 3w	hp	
R164	0757-0282			R: fxd met flm 221 ohm 1% 1/8w	hp	
R170	2100-0950	1	2	R: var comp 2x250k ohms lin ganged 20%	hp	
R171	0757-0471	1	4	R: fxd met flm 182k ohms 1% 1/4w	hp	
R172	0757-0471			R: fxd met flm 182k ohms 1% 1/4w	hp	
R173	0727-0085	1	2	R: fxd depe 680 ohm 1% 1/2w	hp	
R174	0727-0085			R: fxd depe 680 ohm 1% 1/2w	hp	
R201	0727-0261			R: fxd depe 000k ohm 1% 1/2w	hp	
R202	0727-0212			R: fxd depe 111k ohm 1% 1/2w	hp	
R203	0727-0271			R: fxd depe 990k ohm 1% 1/2w	hp	
R204	0727-0158			R: fxd cflm 10.1k ohm 1% 1/2w	hp	
R205	0683-2205			R: fxd comp 22 ohm 5% 1/4w	01121	CB 2205
R206	0683-2205			R: fxd comp 22 ohm 5% 1/4w	01121	CB 2205
R211	0727-0246			R: fxd depe 600k ohm 1% 1/2w	hp	
R212	0727-0249			R: fxd depe 667k ohm 1% 1/2w	hp	
R213	0727-1009			R: fxd depe 800k ohm 1% 1/2w	hp	
R214	0727-0226			R: fxd depe 250k ohm 1% 1/2w	hp	
R220	0757-0476			R: fxd met flm 274k ohm 1% 1/8w	hp	
R221	0727-0276			R: fxd depe 1 megohm 1% 1/2w	hp	

Table 6-2. Replaceable Parts (Cont'd)

Ref Desig	hp Part No.	RS	TQ	Description (See Table 6-1.)	Mfr	Mfr Part No.
R231	0757-0303			R: fxd met flm 47.5 ohm 1% 1/8w	hp	
R232	0757-0401			R: fxd met flm 100 ohm 1% 1/8w	hp	
R233	0757-0435			R: fxd met flm 3.92k ohm 1% 1/8w	hp	
R254	0757-0401			R: fxd met flm 100 ohm 1% 1/8w	hp	
R235	0757-0435			R: fxd met flm 3.92k ohm 1% 1/8w	hp	
R236	0757-0461	1		R: fxd met flm 68.1k ohm 1% 1/8w	hp	
R240	2100-0423			R: var comp lin 500k ohm 20% 1/5w	hp	
R241	0757-0475			R: fxd met flm 274k ohm 1% 1/8w	hp	
R242	0757-0280			R: fxd met flm 1k ohm 1% 1/8w	hp	
R243	0757-0401			R: fxd met flm 100 ohm 1% 1/8w	hp	
R244	0758-0073			R: fxd met flm 24k ohm 5% 1/2w	hp	
R245	0758-0073			R: fxd met flm 24k ohm 5% 1/2w	hp	
R246	0757-0303			R: fxd met flm 47.5 ohm 1% 1/8w	hp	
R247	0757-0303			R: fxd met flm 47.5 ohm 1% 1/8w	hp	
R248	0757-0303			R: fxd met flm 47.5 ohm 1% 1/8w	hp	
R249	2100-0948			R: var comp 750 ohm 20% 20cwlog 1/4w	hp	
R250	2100-0947			R: var comp 3x125 ohm 30% lin 1/4w	hp	
R251	0758-0028			R: fxd met ox 270 ohm 5% 1/2w	hp	
R252	0758-0026			R: fxd met flm 82 ohm 5% 1/2w	hp	
R253	0758-0018			R: fxd met flm 300 ohm 5% 1/2w	hp	
R261	0757-0282			R: fxd met flm 221 ohm 1% 1/8w	hp	
R262	0811-1574			R: fxd 24k 3% 3w	hp	
R263	0811-1574			R: fxd 24k 3%	hp	
R264	0757-0282			R: fxd met flm 221 ohm 1% 1/8w	hp	
R270	2100-0950			R: var comp 24250k ohms lin ganged 20%	hp	
R271	0757-0471			R: fxd met flm 182k ohms 1% 1/4w	hp	
R272	0757-0471			R: fxd met flm 182k ohms 1% 1/4w	hp	
R301	0757-0273	1		R: fxd met flm 3.01k ohm 1% 1/8w	hp	
R302	0757-0408	1		R: fxd met flm 243 ohm 1% 1/8w	hp	
R303	0757-0301	1		R: fxd met flm 39.2 ohm 1% 1/8w	hp	
R304	0757-0280			R: fxd met flm 1k ohm 1% 1/8w	hp	
R305	0757-0421	1		R: fxd met flm 825 ohm 1% 1/8w	hp	
R307	0757-0459	3		R: fxd met flm 56.2k ohm 1% 1/8w	hp	
R308	0757-0344	1		R: fxd met flm 1.00M ohms 1% 1/4w	hp	
R311	0757-0280			R: fxd met flm 1k ohm 1% 1/8w	hp	
R312	0757-0401			R: fxd met flm 100 ohm 1% 1/8w	hp	
R313	0758-0073			R: fxd met flm 24k ohm 5% 1/2w	hp	
R314	0757-0455	1		R: fxd met flm 36.5k ohm 1% 1/8w	hp	
R315	0757-0450	1		R: fxd met flm 22.1k ohms 1% 1/8w	hp	
R321	0757-0442	3		R: fxd met flm 10.0k 1% 1/8w	hp	
R322	0757-0282			R: fxd met flm 221 ohm 1% 1/8w	hp	
R323	0757-0282			R: fxd met flm 221 ohm 1% 1/8w	hp	
R325	0757-0280			R: fxd met flm 1k ohm 1% 1/8w	hp	
R326	0757-0280			R: fxd met flm 1k ohm 1% 1/8w	hp	
R327	0757-0274	2		R: fxd met flm 1.21k ohm 1% 1/8w	hp	
R328	0757-0420	2		R: fxd met flm 750 ohm 1% 1/8w	hp	
R329	0757-0420			R: fxd met flm 750 ohm 1% 1/8w	hp	
R330	0757-0274			R: fxd met flm 1.21k ohm 1% 1/8w	hp	
R331	0757-0429	1		R: fxd met flm 1.82k ohm 1% 1/8w	hp	
R332	0727-0065	2		R: fxd depe 300 ohm 1% 1/2w	hp	
R333	0727-0065			R: fxd depe 300 ohm 1% 1/2w	hp	
R334	0757-0283	3		R: fxd met flm 2k ohm 1% 1/8w	hp	
R401	0727-0072	2		R: fxd depe 403 ohm 1% 1/2w	hp	
R402	0727-0063	2		R: fxd depe 292.4 ohm 1% 1/2w	hp	
R403	0727-0092	1		R: fxd depe 850 ohm 1% 1/2w	hp	
R404	0727-0074	1		R: fxd depe 436 ohm 1/2% 1/2w	hp	
R405	0727-0063			R: fxd depe 292.4 ohm 1% 1/2w	hp	

Table 6-2. Replaceable Parts (Cont'd)

Ref Desig	hp Part No.	RS	TQ	Description (See Table 6-1.)	Mfr	Mfr Part No.
R406	0727-0072			R: fxd depe 403 ohm 1% 1/2w	hp	
R407	0757-0410	4		R: fxd met flm 681 ohm 1% 1/8w	hp	
R408	0757-0410			R: fxd met flm 681 ohm 1% 1/8w	hp	
R409	2100-0108	1		R: var comp in 100 ohm 30% 0.15w	hp	
R410	0757-0399	3		R: fxd met flm 82.5 ohm 1% 1/8w	hp	
R411	0757-0427	2		R: fxd met flm 1.50k ohm 1% 1/8w	hp	
R412	0757-0410			R: fxd met flm 681 ohm 1% 1/8w	hp	
R413	0757-J283			R: fxd met flm 2k ohm 1% 1/8w	hp	
R414	0757-0283			R: fxd met flm 2k ohm 1% 1/8w	hp	
R415	0757-0427			R: fxd met flm 1.50k ohm 1% 1/8w	hp	
R416	0757-0410			R: fxd met flm 681 ohm 1% 1/8w	hp	
R421	0757-0399			R: fxd met flm 82.5 ohm 1% 1/8w	hp	
R422	0757-0406	2		R: fxd met flm 182 ohm 1% 1/8w	hp	
R423	2100-0067	1		R: var comp 2500 ohm 10% lin 1/2w	hp	
R424	0757-0406			R: fxd met flm 182 ohm 1% 1/8w	hp	
R425	0757-0399			R: fxd met flm 82.5 ohm 1% 1/8w	hp	
R431	0757-0414	2		R: fxd met flm 432 ohm 1% 1/8w	hp	
R432	0757-0422	2		R: fxd met flm 909 ohm 1% 1/8w	hp	
R433	0757-0422			R: fxd met flm 909 ohm 1% 1/8w	hp	
R434	0757-0414			R: fxd met flm 432 ohm 1% 1/8w	hp	
R435	0757-0401			R: fxd met flm 100 ohm 1% 1/8w	hp	
R436	0757-0431	1		R: fxd met flm 2.43k ohm 1% 1/8w	hp	
R441	0757-0734	2		R: fxd met flm 1.21k ohm 1% 1/4w	hp	
R442	0811-1573	2		R: fxd ww 6500 ohm 1% 3w	hp	
R443	0811-1573			R: fxd ww 6500 ohm 1% 3w	hp	
R444	0757-0412	1		R: fxd met flm 365 ohm 1% 1/8w	hp	
R445	0757-0734			R: fxd met flm 1.21k ohm 1% 1/4w	hp	
R446	0811-0391	1		R: fxd ww 3k ohm 1% 5w	hp	
R451	0757-0395	2		R: fxd met flm 56.2 ohm 1% 1/8w	hp	
R452	0698-3387	2		R: fxd met ox 6200 ohm 5% 3w	hp	
R453	0698-3387			R: fxd met ox 6200 ohm 5% 3w	hp	
R454	0757-0335			R: fxd met flm 56.2 ohm 1% 1/8w	hp	
R460	2100-0750	1		R: var ww 100 ohm 20% 2w	hp	
R461	0815-0047	4		R: fxd ww 3k ohm 5% 10w	hp	
R462	0815-0047			R: fxd ww 3k ohm 5% 10w	hp	
R463	0757-0200	1		R: fxd met flm 5.62k ohm 1% 1/8w	hp	
R464	0757-0407	1		R: fxd met flm 200 ohm 1% 1/8w	hp	
R465	0814-0004	2		R: fxd ww 2k ohm 2% 7w	56289	244E2022
R466	0814-0004			R: fxd ww 2k ohm 2% 7w	56289	244E2022
R467	0815-0047			R: fxd ww 3k ohm 5% 10w	hp	
R468	0815-0047			R: fxd ww 3k ohm 5% 10w	hp	
R471	0757-0416	2		R: fxd met flm 511 ohm 1% 1/8w	hp	
R472	0757-0401			R: fxd met flm 100 ohm 1% 1/8w	hp	
R473	0767-0008	1		R: fxd met ox flm 10k ohm 5% 3w	hp	
R474	0767-0022	1		R: fxd met flm 4500 ohm 5% 3w	07115	LPE3
R475	0757-0401			R: fxd met flm 100 ohm 1% 1/8w	hp	
R476	0757-0416			R: fxd met flm 511 ohm 1% 1/8w	hp	
R481	0686-2205	1		R: fxd comp 22 ohm 5% 1/2w	01121	EB 2205
R482	0757-0388	1		R: fxd met flm 30.1 ohm 1% 1/8w	hp	
R483	0757-0284	5		R: fxd met flm 150 ohm 1% 1/8w	hp	
R484	0683-2205			R: fxd comp 22 ohm 5% 1/2w	01121	EB 2205
R485	0757-0398	1		R: fxd met flm 75 ohm 1% 1/8w	hp	
R486	0757-0401			R: fxd met flm 100 ohm 1% 1/8w	hp	

Table 6-2. Replaceable Parts (Cont'd)

Ref Desig	hp Part No.	RS	TQ	Description (See Table 6-1.)	Mfr	Mfr Part No.
R501	0757-0465	1	2	R: fxd met flm 100k ohm 1% 1/8w	hp	
R502	0757-0465			R: fxd met flm 100k ohm 1% 1/8w	hp	
R503	0757-0284			R: fxd met flm 150 ohm 1% 1/8w	hp	
R504	0757-0442			R: fxd met flm 10k ohm 1% 1/8w	hp	
R505	0757-0442			R: fxd met flm 10k ohm 1% 1/8w	hp	
R506	0757-0284			R: fxd met flm 150 ohm 1% 1/8w	hp	
R507	0757-0284			R: fxd met flm 150 ohm 1% 1/8w	hp	
R508	0757-0284			R: fxd met flm 150 ohm 1% 1/8w	hp	
R512	0757-0288	1	2	R: fxd met flm 0.00k ohm 1% 1/8w	hp	
R513	0757-0457	1	2	R: fxd met flm 47.5k ohm 1% 1/8w	hp	
R514	2100-0834	1	1	R: var comp 2k ohm 20% 1/4w	hp	
R515	0757-0457			R: fxd met flm 47.5k ohm 1% 1/8w	hp	
R516	0757-0288			R: fxd met flm 0.00k ohm 1% 1/8w	hp	
R521	0757-0434	1	2	R: fxd met flm 3.65k ohm 1% 1/8w	hp	
R522	0757-0459			R: fxd met flm 56.2k ohm 1% 1/8w	hp	
R523	0757-0459			R: fxd met flm 56.2k ohm 1% 1/8w	hp	
R524	0757-0434			R: fxd met flm 3.65k ohm 1% 1/8w	hp	
R525	0757-0280			R: fxd met flm 1k ohm 1% 1/8w	hp	
R531	0757-0435			R: fxd met flm 3.92k ohm 1% 1/8w	hp	
R532	0757-0438	1	2	R: fxd met flm 5.11k 1% 1/8w	hp	
R533	0757-0438			R: fxd met flm 5.11k 1% 1/8w	hp	
R534	0757-0435			R: fxd met flm 3.92k ohm 1% 1/8w	hp	
R535	0757-0415	1	1	R: fxd met flm 475 ohm 1% 1/8w	hp	
R541	0757-0462	1	2	R: fxd met flm 75.0 ohms 1% 1/8w	hp	
R542	0757-0462			R: fxd met flm 75.0 ohms 1% 1/8w	hp	
R551	0757-0428	1	2	R: fxd met flm 1.62k ohm 1% 1/8w	hp	
R552	0757-0428			R: fxd met flm 1.62k ohm 1% 1/8w	hp	
R560	0683-1005	1	2	R: fxd comp 10 ohm 5% 1/4w	01121	CB 1005
R561	0683-1005			R: fxd comp 10 ohm 5% 1/4w	01121	CB 1005
R571	0727-1008	1	1	R: fxd depe 444k ohm 1/2% 1/2w	hp	
R572	0727-1007	1	1	R: fxd depe 33k ohm 1/2% 1/2w	hp	
R573	0727-1006	1	1	R: fxd depe 15.9k ohm 1/2% 1/2w	hp	
R574	0727-1005	1	1	R: fxd depe 15.5k ohm 1/2% 1/2w	hp	
S101	3101-0040	1	2	S: slide, dpt 2-section (channel A)	42100	6603 JM (special)
S102				NSR (P/O A6)		
S103	3100-0840	0	1	S: rotary, 2-section, 2 position (polarity)	hp	
S201	3101-0040			S: slide, dpt 2-section (channel B)	42100	6603 JM (special)
S202				NSR (P/O A7)		
S301	3100-0839	0	1	S: rotary, 1-section, 6-position (function)	hp	
T301	9130-0034	1	1	T: pulse	01961	PE 5164
V101	5080-0424	3	3	V: aged 6DJ8	hp	
V102	2140-0008	2	2	V: neon NE2	24455	NE2
V201	5080-0424			V: aged 6DJ8	hp	
V202	2140-0008			V: neon NE2	24455	NE2
V401	5080-0424			V: aged 6DJ8	hp	
V402	1923-0061	2	2	V: electron EIA type 8233	73445	8233
V403	1923-0061			V: electron EIA type 8233	73445	8233
XV101	1200-0058	0	2	XV: electron 9-pin miniature	01662	3001PHSPTD
XV201	1200-0058			XV: electron 9-pin miniature	01662	3001PHSPTD
XV401	1200-0008	0	1	XV: electron 9-pin miniature	71785	121-25-11-055
XV402	1200-0146	0	2	XV: 9 pin magnoval	71785	149-10-11-070
XV403	1200-0146			XV: 9 pin magnoval	71785	149-10-11-070

Table 6-2. Replaceable Parts (Cont'd)

Ref Desig	hp Part No.	RS	TQ	Description (See Table 6-1.)	Mfr	Mfr Part No.
MISCELLANEOUS						
	0340-0038		22	Terminal: feed thru	hp	FT-E-15
	0340-0039		22	Bushing: feed thru insulating	hp	
	0340-0060		2	Receptacle: teflon (on A10)	08201	
	0370-0084		2	Knob: blk w/arrow (position)	hp	
	0370-0088		1	Knob: blk plug-in latch (lock)	hp	
	0370-0099		1	Knob: blk concentric (function)	hp	
	0370-0102		1	Knob: red w/arrow (polarity)	hp	
	0370-0113		2	Knob: blk concentric (sensitivity)	hp	
	0370-0114		2	Knob: red w/arrow (vernier)	hp	
	1390-0035		1	Fastener: lock (front panel)	hp	
	5000-0401		1	Spring: ground (rear panel)	hp	
	5000-0405		1	Panel: rear (includes P1 and ground spring)	hp	
	5000-0535		1	Gusset: right	hp	
	5000-0536		1	Gusset: left	hp	
	01402-01205		1	Bracket: left side	hp	
	01402-01206		1	Bracket: right side	hp	
	01402-00103		1	Deck: output amplifier	hp	
	01402-00201		1	Panel: front	hp	
	01402-00202		1	Panel: hub, front (includes S101, S102, and lock fastener)	hp	
	01402-00602		2	Shield: attenuator	hp	
	01402-01204		1	Bracket: switch	hp	
	01402-04101		1	Cover: delay line	hp	
	01402-04102		2	Cover: attenuator	hp	
	01402-05501		1	Box: delay line	hp	
	01402-23201		1	Coupling: sens cal	hp	
	01402-44101		4	Insulator: transistor (on A9)	hp	
	01402-61603		1	Cable: trigger amplifier	hp	
	01402-61606		1	Cable: main harness	hp	

Table 6-3. Code List of Manufacturers

The following code numbers are from the Federal Supply Code for Manufacturers Cataloging Handbooks H4-1 (Name to Code) and H4-2 (Code to Name) and their latest supplements. The date of revision and the date of the supplements used appear at the bottom of each page. Alphabetical codes have been arbitrarily assigned to suppliers not appearing in the H4 Handbooks.

Code No.	Manufacturer	Address	Code No.	Manufacturer	Address	Code No.	Manufacturer	Address
00000	U. S. A. Common	Any supplier of U. S.	05724	Barber Colman Co.	Rockford, Ill.	12881	Meter Electronics Corp.	Clark, N. J.
00136	McCoy Electronics	Mount Holly Springs, Pa.	05726	Filton Optical Co.	Roslyn Heights, Long Island, N. Y.	12930	Delta Semiconductor Inc.	Newport Beach, Calif.
00144	ADC Products Inc.	Minneapolis, Minn.	05729	Metro Tel Corp.	Westbury, N. Y.	12954	Dickson Electronics Corp.	Scottsdale, Arizona
00213	Sage Electronics Corp.	Hochester, N. Y.	05781	Stewart Engineering Co.	Santa Cruz, Calif.	13103	Theimolloy	Dallas, Texas
00287	Cemco Inc.	Danielson, Conn.	05820	Wakefield Engineering Inc.	Wakefield, Mass.	13396	Teletanken (GmbH)	Hanover, Germany
00334	Humidat	Collon, Calif.	06004	Bassick Co., The	Bridgeport, Conn.	13635	Midland-Wright Div. of Pacific Industries, Inc.	Kansas City, Kansas
00348	Microtron Co., Inc.	Valley Stream, N. Y.	06090	Raytheon Corp.	Redwood City, Calif.	14099	Sem-Tech	Newbury Park, Calif.
00373	Gallock Inc.	Camden, N. J.	06175	Dausch and Lomb Optical Co.	Rochester, N. Y.	14193	Calif. Resistor Corp.	Santa Monica, Calif.
00656	Aerovox Corp.	New Bedford, Mass.	06407	E. T. A. Products Co. of America	Chicago, Ill.	14298	American Components, Inc.	Conshohocken, Pa.
00779	Amp. Inc.	Harrisburg, Pa.	06540	Amalox Electronic Hardware Co., Inc.	New Rochelle, N. Y.	14433	ITT Semiconductor, A Div. of Int. Telephone & Telegraph Corp.	West Palm Beach, Fla.
00781	Aircraft Radio Corp.	Boonton, N. J.	06555	Beede Electrical Instrument Co., Inc.	Penacook, N. H.	14493	Hewlett-Packard Company	Loveland, Colo.
00815	Northern Engineering Laboratories, Inc.	Burlington, Wis.	06666	General Devices Co., Inc.	Indianapolis, Ind.	14655	Cornell Dublier Electric Corp.	Newark, N. J.
00853	Sangamo Electric Co.	Pickens, S. C.	06751	Semcor Div. Components Inc.	Phoenix, Ariz.	14674	Coring Glass Works	Corning, N. Y.
00866	Cob Engineering Co.	Los Angeles, Calif.	06812	Torrington Mfg. Co., West Div.	Van Nuys, Calif.	14752	Electro Cube Inc.	So. Pasadena, Calif.
00891	Carl E. Holmes Corp.	Los Angeles, Calif.	06980	Valvan Assoc. Exact Div.	San Carlos, Calif.	14960	Williams Mfg. Co.	San Jose, Calif.
00929	Microtab Inc.	Livingston, N. J.	07088	Keivin Electric Co.	Van Nuys, Calif.	15203	Webster Electronics Co.	New York, N. Y.
01002	General Electric Co. Capacitor Dept	Gainesville, Fla.	07126	Digitron Co.	Pasadena, Calif.	15291	Adjustable Bushing Co.	N. Hollywood, Calif.
01009	Alden Products Co.	Brighton, Mass.	07137	Transistor Electronics Corp.	Minneapolis, Minn.	15558	Micron Electronics	Garden City, Long Island, N. Y.
01121	Allen Bradley Co.	Milwaukee, Wis.	07138	Westinghouse Electric Corp. Electron Tube Div.	Elmsira, N. Y.	15566	Amprobe Inst. Corp.	Lynbrook, N. Y.
01255	Lifton Industries, Inc.	Beverly Hills, Calif.	07149	Filmohm Corp.	New York, N. Y.	15772	Twentieth Century Coil Spring Co.	Santa Clara, Calif.
01281	TRW Semiconductors, Inc.	Laurel, Calif.	07233	Cinch-Graphix Co.	City of Industry, Calif.	15818	Amelco Inc.	MI. View, Calif.
01295	Texas Instruments, Inc. Transistor Products Div.	Dallas, Texas	07261	Avnet Corp.	Culver City, Calif.	15909	Davco Div. Thomas A. Edison Ind. McGraw-Edison Co.	Long Island City, N. Y.
01349	The Alliance Mfg. Co.	Alliance, Ohio	07263	Fairchild Camera & Inst. Corp. Semiconductor Div.	Mountain View, Calif.	16037	Spurce Pine Mica Co.	Spurce Pine, N. C.
01389	Pacific Relays, Inc.	Van Nuys, Calif.	07322	Minnesota Rubber Co.	Minneapolis, Minn.	16179	Omni-Spelta Inc.	Detroit, Ill.
01930	Aerovox Corp.	Rockford, Ill.	07387	Butcher Corp., The	Monterey Park, Calif.	16352	Computer Diode Corp.	Lodr, N. J.
01961	Pulse Engineering Co.	Santa Clara, Calif.	07700	Technical Wire Products Inc.	Cranford, N. J.	16688	Ideal Elec. Meter Co., Inc. Ne Ju Meter Div.	Brooklyn, N. Y.
02114	Ferroxcube Corp. of America	Saugerties, N. Y.	07910	Continental Device Corp.	Hawthorne, Calif.	16758	Delco Radio Div. of G. M. Corp.	Kokomo, Ind.
02286	Cole Rubber and Plastics Inc.	Sunnyvale, Calif.	07933	Raytheon Mfg. Co. Semiconductor Div.	Mountain View, Calif.	17109	Thermometics Inc.	Canoga Park, Calif.
02660	Amphenol-Borg Electronics Corp.	Chicago, Ill.	07966	Shockley Semi-Conductor Laboratories	Palo Alto, Calif.	17474	Tranex Company	Mountain View, Calif.
02735	Radio Corp. of America, Semiconductor and Materials Div.	Somerville, N. J.	07980	Hewlett-Packard Co., Boonton Radio Div.	Boonton, N. J.	17675	Hamilin Metal Products Corp.	Akron, Ohio
02771	Vocaline Co. of America, Inc.	Old Saybrook, Conn.	08145	U. S. Engineering Co.	Los Angeles, Calif.	17745	Angstrom Prec. Inc.	No. Hollywood, Calif.
02777	Hopkins Engineering Co.	San Fernando, Calif.	08289	Blinn, Dethlef Co.	Pomona, Calif.	18042	Power Design Pacific Inc.	Palo Alto, Calif.
03308	G. E. Semiconductor Prod. Dept.	Syracuse, N. Y.	08358	Burgess Battery Co.	Niagara Falls, Ontario, Canada	18476	Ty-Car Mfg. Co., Inc.	Holliston, Mass.
03705	Apex Machine & Tool Co.	Dayton, Ohio	08664	Bristol Co., The	Waterbury, Conn.	18486	TRW Elect. Comp. Div.	Des Plaines, Ill.
03797	Eidema Corp.	Compton, Calif.	08717	Sigan Company	Sun Valley, Calif.	18583	Curtis Instrument, Inc.	Mt. Kisco, N. Y.
03827	Transitron Electric Corp.	Wakefield, Mass.	08718	ITT Cannon Electric Inc., Phoenix Div.	Phoenix, Arizona	18873	E. J. DuPont and Co., Inc.	Wilmington, Del.
03888	Pyralon Resistor Co., Inc.	Cedar Knolls, N. J.	08792	CBS Electronics Semiconductor Operations, Div. of C. B. S. Inc.	Lowell, Mass.	18911	Durant Mfg. Co.	Milwaukee, Wis.
03954	Singer Co., Diehl Div. Fineline Plant	Somersville, N. J.	08984	Mex-Rain	Indianapolis, Ind.	19315	Bendis Corp., The Eclipse-Pointers Div.	Teterboro, N. J.
04009	Alloy, Hait and Hegeman Elect. Co.	Hartford, Conn.	09026	Babcock Relays Div.	Costa Mesa, Calif.	19500	Thomas A. Edison Industries, Div. of McGraw Edison Co.	West Orange, N. J.
04013	Taurus Corp.	Lambertville, N. J.	09134	Texas Capacitor Co.	Houston, Texas	19644	LRC Electronics	Horseneads, N. Y.
04222	H-Q Division of Aerovox	Myrtle Beach, S. C.	09145	Alpha Electronics	Sun Valley, Calif.	19701	Electra Mfg. Co.	Independence, Kansas
04354	Precision Paper Tube Co.	Chicago, Ill.	09250	Electro Assemblies, Inc.	Chicago, Ill.	20183	General Atomics Corp.	Philadelphia, Pa.
04404	Dynac Division of Hewlett-Packard Co.	Palo Alto, Calif.	09369	Walloy Battery Co. of Canada, Ltd.	Toronto, Ontario, Canada	21226	Excelsione, Inc.	Long Island City, N. Y.
04651	Sylvania Electric Products, Microwave Device Div.	Mountain View, Calif.	10274	General Transistor Western Corp.	Los Angeles, Calif.	21335	Falco Beating Co., The	New Britain, Conn.
04713	Motolera, Inc., Semiconductor Prod. Div.	Phoenix, Arizona	10431	Ty-Fab, Inc.	Berkley, Calif.	21520	Fanstest Metallurgical Corp.	N. Chicago, Ill.
04732	Filton Co., Inc. Western Div.	Culver City, Calif.	10646	Carborundum Co.	Night's Falls, N. Y.	23783	British Radio Electronics Ltd.	Washington, D. C.
04773	Automatic Electric Co.	Hopkinton, Ill.	11236	GTE of Beine, Inc.	Beine, Ind.	24455	G. E. Lamp Division	Mela Park, Cleveland, Ohio
04796	Seabird Wire Co.	Raymond City, Calif.	11237	Chicago Telephone of California, Inc.	So. Pasadena, Calif.	24655	General Radio Co.	West Concord, Mass.
04811	Precision Coil Spring Co.	El Monte, Calif.	11242	Bay State Electronics Corp.	Waltham, Mass.	26365	Gires Reproducer Corp.	New Rochelle, N. Y.
04870	P. M. Motor Company	Westchester, Ill.	11317	Teledyne Inc., Microwave Div.	Palo Alto, Calif.	26467	Grobbs Eyle Co. of America, Inc.	Callstadt, N. J.
05006	Twentieth Century Practices, Inc.	Los Angeles, Calif.	11334	Dynac Electronics Inc.	Costa Mesa, Calif.	26992	Hamilin Watch Co.	Lansdale, Pa.
05277	Westinghouse Electric Corp. Semiconductor Dept	Youngwood, Pa.	11371	General Instrument Corp. Semiconductor Div. Product Group	Newark, N. J.	28480	Hewlett-Packard Co.	Palo Alto, Calif.
05337	Union Carbide Corp.	Cleveland, Ohio	11377	Imperial Electronics Inc.	Buena Park, Calif.	33173	G. E. Receiving Tube Dept.	Owensboro, Ky.
05397	Union Carbide Corp. Linde Division	Kemel Dept.	11870	Metallab, Inc.	Palo Alto, Calif.	35434	Leclorm Inc.	Chicago, Ill.
05593	Humilitronics Engineering Co.	Sunnyvale, Calif.	12136	Philadelphia Handle Co.	Camden, N. J.	36196	Stamway's Coil Products Ltd.	Hawkesbury, Ontario, Canada
05616	Cusum Plastic Electro Electrical Spec. Co.	Cleveland, Ohio	12693	Classtat Mfg. Co.	Dover, N. H.	37942	P. R. Walloy & Co., Inc.	Indianapolis, Ind.
06015-02	Revised July, 1966		12859	Nippon Electric Co., Ltd.	Tokyo, Japan	39543	Mechanical Industries Prod. Co.	Akron, Ohio

From: FSC, Handbook Supplements
H4-1, Dated JULY 1965
H4-2, Dated NOV 1967

Table 6-3. Code List of Manufacturers (Cont'd)

Code No.	Manufacturer	Address	Code No.	Manufacturer	Address	Code No.	Manufacturer	Address
48655	Ohmite Mfg. Co.	Shobie, Ill.	72964	Robert W. Hadley Co.	Los Angeles, Calif.	60037	Waco Division of Sperry Gyro Corp.	Wilmington, N. J.
48384	Penn Eng. & Mfg. Corp.	Doylestown, Pa.	72987	Elite Technological Products, Inc.	Elizabethtown, Pa.	60120	Schnitzer Alloy Products Co.	Elizabethtown, N. J.
48904	Polaroid Corp.	Cambridge, Mass.	73061	Hansen Mfg. Co., Inc.	Princeton, Ind.	60130	Timp Telephone Equipment	New York, N. Y.
48620	Precision Thermometer & Inst. Co.	Southampton, Pa.	73076	H. W. Harper Co.	Chicago, Ill.	60131	Electronic Industries Association	Any Island
49956	Wigwam & Power Tube Div.	Waltham, Mass.	73138	Helipot Div. of Beckman Inst., Inc.	Fullerton, Calif.		Tube meeting IIA Standards	Washington, DC
52050	Rowan Controller Co.	Westminster, Md.	73293	Hughes Products Division of Hughes Aircraft Co.	Hempstead Beach, Calif.	60207	Unimat Switch Div. Mason Electronics Corp.	Wallingford, Conn.
52983	Sanborn Company	Waltham, Mass.	73445	Ampere Electronic Co., Div. of Health American Phillips Co., Inc.	Hicksville, N. Y.	60223	United Franklin Corp.	New York, N. Y.
54294	Shallcross Mfg. Co.	Selma, N. C.	73506	Bradley Semiconductor Corp.	New Haven, Conn.	60246	Oxford Electric Corp.	Chicago, Ill.
55026	Simpson Electric Co.	Chicago, Ill.	73559	Cairing Electric, Inc.	Hartford, Conn.	60294	E-K Inc.	Riverside, Calif.
55933	Sonotone Corp.	Elmsford, N. Y.	73566	Circle 8 Mfg. Co.	Trenton, N. J.	60411	Acro Div. of Robertson Controls Co.	Columbus, Ohio
55938	Raytheon Co. Commercial Apparatus & Systems Div.	Sy. Norwalk, Conn.	73582	George K. Garrett Co., Div. WSL Industries Inc.	Philadelphia, Pa.	60466	Alt Star Products Inc.	Delfranco, Ohio
56137	Spaulding Fibre Co., Inc.	Tonawanda, N. Y.	73734	Federal Screw Products Inc.	Chicago, Ill.	60505	Avery Adhesive Label Corp.	Monrovia, Calif.
56289	Sprague Electric Co.	North Adams, Mass.	73743	Fisher Special Mfg. Co.	Cincinnati, Ohio	60561	Hammarlund Co., Inc.	New York, N. Y.
59446	Telco, Inc.	St. Paul, Minn.	73793	General Industries Co., The	Elyria, Ohio	60640	Stevens, Arnold, Co., Inc.	Boston, Mass.
59730	Thomas & Betts Co.	Elizabeth, N. J.	73846	Goshen Stamping & Tool Co.	Goshen, Ind.	61010	International Instruments Inc.	Orange, Conn.
60743	Triplett Electrical Inst. Co.	Bulliton, Ohio	73899	JFD Electronics Corp.	Brooklyn, N. Y.	61023	Graphite Co.	LaGrange, Ill.
61775	Union Switch and Signal, Div. of Westinghouse Air Brake Co.	Pittsburgh, Pa.	73905	Jennings Radio Mfg. Corp.	San Jose, Calif.	61095	Evad Transformer Corp.	Venice, Calif.
62119	Universal Electric Co.	Ononago, Mich.	74276	Signalite Inc.	Hoplane, N. J.	61337	Winchester Elec. Div. Litten Inc., Inc.	Oakville, Conn.
63743	Ward-Leonard Electric Co.	Mt. Vernon, N. Y.	74435	J. H. Wynn, and Sons	Winchester, Mass.	61349	Military Specification	
64959	Western Electric Co., Inc.	New York, N. Y.	74451	Industrial Condenser Corp.	Chicago, Ill.	61483	International Rectifier Corp.	El Segundo, Calif.
65092	Weston Inst. Inc. Weston Newark	Newark, N. J.	74568	H. F. Products Division of Amphelot-Boig Electronics Corp.	Danbury, Conn.	61541	Airpac Electronics, Inc.	Cambridge, Mass.
66295	Wittek Mfg. Co.	Chicago, Ill.	74970	E. F. Johnson Co.	Waseca, Minn.	61660	Bally Controls, Div. Bally Wright Corp.	Waterloo, Mass.
66346	Reverse Wollansak Div. Minn. Mining & Mfg. Co.	St. Paul, Minn.	75042	International Resistance Co.	Philadelphia, Pa.	62042	Carter Precision Electric Co.	Shobie, Ill.
70276	Allen Mfg. Co.	Hartford, Conn.	75376	CTS Knights Inc.	Sandwich, Ill.	62047	Spirits Faraday Inc., Copper Hewitt Electric Div.	Hoboken, N. J.
70338	Allmetal Screw Product Co., Inc.	Garden City, N. Y.	75382	Kulka Electric Corporation	Mt. Vernon, N. Y.	62147	Jelleis Electronics Division of Speer Carbon Co.	Du Bois, Pa.
70485	Atlantic India Rubber Works, Inc.	Chicago, Ill.	75818	Lenz Electric Mfg. Co.	Chicago, Ill.	62170	Fairchild Camera & Inst. Corp. Defense Prod. Division	Clifton, N. J.
70563	Ampelite Co., Inc.	Union City, N. J.	75915	Littlefuse, Inc.	Des Plaines, Ill.	62209	Maguire Industries, Inc.	Greenwich, Conn.
70503	Belden Mfg. Co.	Chicago, Ill.	76005	Lord Mfg. Co.	Elizabethtown, Pa.	62219	Sylvania Electric Prod. Inc. Electronic Tube Division	Emporium, Pa.
70998	Bird Electronic Corp.	Cleveland, Ohio	76210	C. W. Marwede	San Francisco, Calif.	62376	Aslcon Corp.	East Newark, N. J.
71002	Birnback Radio Co.	New York, N. Y.	76487	James Miller Mfg. Co., Inc.	Malden, Mass.	62389	Switchcraft, Inc.	Chicago, Ill.
71041	Boston Gear Works Div. of Murray Co. of Texas	Quincy, Mass.	76493	J. W. Miller Co.	Los Angeles, Calif.	62647	Metals & Controls Inc. Spencer Products	Millicent, Mass.
71218	Bud Radio, Inc.	Willoughby, Ohio	76530	Cinch-Monadnopp, Div. of United Cast Fastener Corp.	San Leandro, Calif.	62768	Phillips Advance Control Co.	Joliet, Ill.
71286	Camlot Fastener Corp.	Palmyra, N. J.	76545	Muller Electric Co.	Cleveland, Ohio	62868	Research Products Corp.	Madison, Wis.
71313	Cardwell Condenser Corp.	Lindenhurst E. P., N. Y.	76573	National Union	Newark, N. J.	62877	Holton Mfg. Co., Inc.	Woodstock, N. Y.
71400	Bussmann Mfg. Div. of McGraw-Edison Co.	St. Louis, Mo.	76854	Oak Manufacturing Co.	Clyde Lake, Ill.	62892	Vector Electronic Co.	Leedsdale, Calif.
71436	Chicago Condenser Corp.	Chicago, Ill.	77058	Bendix Corp., The Bendix Pacific Div.	N. Hollywood, Calif.	63053	Western Washer Mfg. Co.	Los Angeles, Calif.
71447	Calif. Spring Co., Inc.	Pico-Rivera, Calif.	77075	Pacific Metals Co.	San Francisco, Calif.	63058	Cox Fastener Co.	Cambridge, Mass.
71450	CTS Corp.	Elkhart, Ind.	77221	Phonoshan Instrument and Electronic Co.	South Pasadena, Calif.	63066	New Hampshire Ball-Bearing, Inc.	Peterborough, N. H.
71468	ITT Cannon Electric Inc.	Los Angeles, Calif.	77342	American Machine & Foundry Co. A Bramfield Div.	Princeton, Ind.	63125	General Instrument Corp. Capacitor Div.	Dallington, S. C.
71471	Cinema Plant, H. Q. Div. Aeroquip Corp.	Burbank, Calif.	77630	TRW Electronic Components Div.	Camden, N. J.	63148	ITT Wire and Cable Div.	Los Angeles, Calif.
71482	C. P. Clark & Co.	Chicago, Ill.	77638	General Instrument Corp., Rectifiers Div.	Brooklyn, N. Y.	63186	Victory Engineering Corp.	Springfield, N. J.
71590	Centralab Div. of Globe Union Inc.	Milwaukee, Wis.	77764	Resistance Products Co.	Harrisburg, Pa.	63298	Bendix Corp., Red Bank Div.	Red Bank, N. J.
71616	Commercial Plastics Co.	Chicago, Ill.	77969	Rubbercraft Corp. of Calif.	Torrance, Calif.	63315	Hubbell Corp.	Mundelein, Ill.
71700	Cornish Wire Co., The	New York, N. Y.	78189	Shakeproof Division of Illinois Tool Works	Elgin, Ill.	63320	Smith, Herman A., Inc.	Brooklyn, N. Y.
71707	Colo Coil Co., Inc.	Providence, R. I.	78283	Signal Indicator Corp.	New York, N. Y.	63365	Central Screw Co.	Chicago, Ill.
71744	Chicago Miniature Lamp Works	Chicago, Ill.	78290	Struthers-Dunn Inc.	Pittman, N. J.	63503	Cavit Wire and Cable Co. Div. of Am Race Corp.	Brookfield, Mass.
71753	A. D. Smith Corp., Crowley Div.	West Orange, N. J.	78452	Thompson-Bremer & Co.	Chicago, Ill.	63596	Bairdoughs Corp. Electronic Tube Div.	Pittsfield, N. J.
71785	Cinch Mfg. Co., Howard B. Jones Div.	Chicago, Ill.	78473	Tilley Mfg. Co.	San Francisco, Calif.	63740	Union Carbide Corp. Consumer Prod. Div.	New York, N. Y.
71984	Dow Corning Corp.	Midland, Mich.	78488	Stackpole Carbon Co.	St. Marys, Pa.	63777	Mod' Eng. and Mfg., Inc.	Huntington Ind.
72136	Electro Motive Mfg. Co., Inc.	Williamsville, Conn.	78493	Standard Thomson Corp.	Waltham, Mass.	63821	Layo Scruggs Co.	Festus, Mo.
72354	John E. Fast Co., Div. Victrolux Instr. Co.	Chicago, Ill.	78533	Tinneman Products, Inc.	Cleveland, Ohio	63942	Aeronautical Inst. & Radio Co.	Los Angeles, Calif.
72619	Dialight Corp.	Brooklyn, N. Y.	78790	Transformer Engineers	San Gabriel, Calif.	64171	Aico Electronics Inc.	Great Neck, N. Y.
72656	Indiana General Corp., Electronics Div.	Keosau, N. J.	78947	Ucinite Co.	Newtonville, Mass.	64396	A. J. Clesener Co., Inc.	San Francisco, Calif.
72699	General Instrument Corp., Cap. Div. Hewlett, N. J.	Chicago, Ill.	79136	Waldes Kohnoor Inc.	Long Island City, N. Y.	64431	TRW Capacitor Div.	Ugahala, Neb.
72765	Diak Mfg. Co.	Chicago, Ill.	79142	Vedret Kopt, Inc.	Hartford, Conn.	64970	Sarkis Precision, Inc.	Bloomington, Ind.
72825	H. A. Eby Inc.	Philadelphia, Pa.	79251	Wentz Mfg. Co.	Chicago, Ill.	65454	Benetton Molding Company	Beaumont, N. J.
72928	Gudeman Co.	Chicago, Ill.	79272	Continental-Witt Electronics Corp.	Philadelphia, Pa.			
			79963	Zetlich Mfg. Corp.	New Rochelle, N. Y.			

From FSC Handbook Supplements
H4-1 Dated JULY 1965
H4-2 Dated NOV. 1962

00015-42
Revised July, 1966

Table 6-3. Code List of Manufacturers (Cont'd)

Code No.	Manufacturer	Address	Code No.	Manufacturer	Address	Code No.	Manufacturer	Address
85471	A. B. Boyd Co.	San Francisco, Calif.	94137	General Cable Corp.	Bayonne, N. J.	98376	Zero Mfg. Co.	Burbank, Calif.
85474	R. M. Bracamonte & Co.	San Francisco, Calif.	94144	Raytheon Co., Comp. Div., Ind. Ctrp. Operations	Quincy, Mass.	98377	General Mills Inc., Electronics Div.	Minneapolis, Minn.
85660	Koiled Metals, Inc.	Hamden, Conn.	94148	Scientific Electronics Products, Inc.	Loveland, Colo.	98384	Pasco Div. of Hewlett-Packard Co.	Palo Alto, Calif.
85911	Seamless Rubber Co.	Chicago, Ill.	94154	Tung-Sol Electric, Inc.	Newark, N. J.	98821	North Hills Electronics, Inc.	Glen Cove, N. Y.
86159	Clifton Precision Products Co., Inc.	Chilton Heights, Pa.	94157	Curtiss-Wright Corp. Electronics Div.	East Palestine, N. J.	98975	International Electronic Research Corp.	Burbank, Calif.
86579	Precision Rubber Products Co.	Dayton, Ohio	94272	South Chester Corp.	Chester, Pa.	99109	Columbia Technical Corp.	New York, N. Y.
86684	Radio Corp. of America, Electronic Comp. & Devices Div.	Harrison, N. J.	94310	Trio-Ohm Products Newcor Components Div.	Huntington, Ind.	99313	Varian Associates	Palo Alto, Calif.
87034	Marco Industries	Anaheim, Calif.	94330	Wire Cloth Products, Inc.	Bellwood, Ill.	99378	Allee Corp.	Winchester, Mass.
87216	Philco Corporation (Lansdale Division)	Lansdale, Pa.	94682	Worcester Pressed Aluminum Corp.	Worcester, Mass.	99514	Marshall Ind. Elect. Products Div.	San Marino, Calif.
87473	Western Fibrous Glass Products Co.	San Francisco, Calif.	94696	Magnecraft Electric Co.	Chicago, Ill.	99707	Control Switch Division, Controls Co. of America	El Segundo, Calif.
87664	Van Waters & Rogers Inc.	San Francisco, Calif.	95023	George A. Philbrick Researches, Inc.	Boston, Mass.	99800	Delevan Electronics Corp.	East Aurora, N. Y.
87930	Tower Mfg. Corp.	Providence, R. I.	95236	Allies Products Corp.	Miami, Fla.	99848	Wisco Corporation	Indianapolis, Ind.
88140	Cutter-Hammer, Inc.	Lincoln, Ill.	95238	Continental Connector Corp.	Woodside, N. Y.	99934	Rehbrandt, Inc.	Boston, Mass.
88220	Gould-National Batteries, Inc.	St. Paul, Minn.	95263	Leetroll Mfg. Co., Inc.	Long Island, N. Y.	99942	Hoffman Electronics Corp. Semiconductor Div.	Et Hontle, Calif.
88421	Federal Telephone & Radio Corp.	Chilton, N. J.	95264	Leico Electronics, Inc.	Burbank, Calif.	99957	Technology Instrument Corp. of Calif.	Newbury Park, Calif.
88698	General Mills, Inc.	Buffalo, N. Y.	95265	National Coil Co.	Sheidan, Wyo.			
89231	Graybar Electric Co.	Oakland, Calif.	95275	Vitramon, Inc.	Bridgeport, Conn.			
89665	United Transformer Lb.	Chicago, Ill.	95348	Goidos Corp.	Bloomfield, N. J.			
90179	US Rubber Co., Consumer Ind. & Plastic Prod. Div.	Passaic, N. J.	95354	Welhode Mfg. Co.	Chicago, Ill.			
90970	Beating Engineering Co.	San Francisco, Calif.	95712	Dage Electric Co., Inc.	Franklin, Ind.			
91260	Connor Spring Mfg. Co.	San Francisco, Calif.	95984	Siemon Mfg. Co.	Wayne, Ill.			
91345	Milite Dial & Nameplate Co.	El Monte, Calif.	95987	Wheatster Co.	Chicago, Ill.			
91418	Radio Material Co.	Chicago, Ill.	96067	Huggins Laboratories	Sunnyvale, Calif.			
91506	Augat Inc.	Attleboro, Mass.	96095	Hi Q Div. of Astrovox Corp.	Olean, N. Y.			
91637	Dale Electronics, Inc.	Columbus, Nebr.	96256	Thordarson-Weissner Inc.	ME. Cairnet, Ill.			
91662	Elco Corp.	Willow Grove, Pa.	96296	Solar Manufacturing Co.	Los Angeles, Calif.			
91737	Gremar Mfg. Co., Inc.	Wakefield, Mass.	96330	Carlton Screw Co.	Chicago, Ill.			
91827	K F Development Co.	Redwood City, Calif.	96341	Microwave Associates, Inc.	Burlington, Mass.			
91886	Malco Mfg. Co., Inc.	Chicago, Ill.	96501	Excel Transformer Co.	Oakland, Calif.			
91929	Honeywell Inc., Micro Switch Div.	Freeport, Ill.	97464	Industrial Retainer Ring Co.	Ivington, N. J.			
91961	Nahm-Bios. Spring Co.	Oakland, Calif.	97539	Automatic & Precision Mfg.	Englewood, N. J.			
92180	Trio-Connector Corp.	Peabody, Mass.	97979	Reon Resistor Corp.	Yonkers, N. Y.			
92367	Elgeet Optical Co. Inc.	Rochester, N. Y.	97983	Lifton System Inc., Adler-Westra Commun. Div.	New Rochelle, N. Y.			
92996	Universal Industries, Inc.	City of Industry, Calif.	98141	R-Tronics, Inc.	Jamaica, N. Y.			
92607	Tensolite Insulated Wire Co., Inc.	Tarrytown, N. Y.	98159	Rubber Tech, Inc.	Gardena, Calif.			
93332	Sylvania Electric Prod. Inc. Semiconductor Div.	Woburn, Mass.	98220	Hewlett-Packard Co., Moseley Div.	Pasadena, Calif.			
93369	Robbins and Myers, Inc.	New York, N. Y.	98278	Microdot, Inc.	So. Pasadena, Calif.			
93410	Slevens Mfg. Co., Inc.	Mansfield, Ohio	98291	Sealctio Corp.	Namaronck, N. Y.			
93929	G. V. Controls	Livingston, N. J.						

THE FOLLOWING HP VENDORS HAVE NO NUMBER ASSIGNED IN THE LATEST SUPPLEMENT TO THE FEDERAL SUPPLY CODE FOR MANUFACTURERS HANDBOOK.

0000F	Walco Tool and Die	Los Angeles, Calif.
0000M	Western Coil Div. of Automatic Ind., Int.	Redwood City, Calif.
0000Z	Willow Leather Products Corp.	Newark, N. J.
0000A	British Radio Electronics Ltd.	Washington, D. C.
000AB	ETA	England
000BB	Precision Instrument Components Co.	Van Nuys, Calif.
000MM	Rubber Eng. & Development	Hayward, Calif.
000NN	A "N" D Mfg. Co.	San Jose, Calif.
000QQ	Coofliron	Oakland, Calif.
000WW	California Eastern Lab.	Burlington, Calif.
000YY	S. K. Smith Co.	Los Angeles, Calif.

APPENDIX

APPENDIX I MANUAL CHANGES

Appendix I contains all information required to adapt this manual to Model 1402A Vertical Amplifiers manufactured prior to the ones covered by this manual. Check your instrument's serial prefix located on the plate at the back of the instrument. If the serial prefix does not match the serial prefix given on the front page of this manual, find the serial prefix in the table and make the required changes. For information on Errata, refer to the change sheet supplied with this manual. All changes described herein adapt the standard instrument as manufactured, and do not apply to units subsequently modified in the field. Serial

Instrument Serial Prefix	Make Changes
035-	1

prefixes 625- and below are covered in another manual, hp Part No. 01402-09001.

CHANGE 1

Table 6-2,

A2: change to hp Part No. 01402-66502.

A3: change to hp Part No. 01402-66503.

MISCELLANEOUS,

Bracket: left side; delete.

Bracket: right side; delete.

Bracket: switch; change to hp Part No. 01402-01203.

Gusset: left side; change to hp Part No. 01402-00101.

Gusset: right side; change to hp Part No. 01402-00102.

MANUAL CHANGES



MANUAL CHANGES

MODEL 1402A

DUAL TRACE AMPLIFIER

Manual Serials Prefixed: 709—
Manual Printed: MARCH 1967

Make all changes listed below as Errata. Check the following table for your instrument serial prefix and/or serial number and make listed change(s) to the manual:

Serial Prefix or Number	Make Changes	Serial Prefix or Number	Make Changes
716—	1		

ERRATA

Page 1-0, Table 1-1,

Add to BANDWIDTH specification:

In a Model 143A Oscilloscope,
DC coupled: dc to 15 MHz
AC coupled: 2 Hz to 15 MHz

Page 3-2, Paragraph 3-15,

Add: When used in a Model 143A Oscilloscope
the bandwidth specification is 15 MHz.

Page 5-1, Paragraph 5-11, step d,

Change: d. Change frequency to 20 MHz (in Model
143A change frequency to 15 MHz). Vertical
deflection should be 4.2 divisions or greater.

Page 5-2, Paragraph 5-12c,

Add following to note at end of paragraph:

When a Model 1402A is installed for the first
time in a Model 143A or 143S, proceed as follows
to obtain full bandwidth and rise time:

- (1) Replace C462 in Model 1402A with a larger
fixed capacitor (nominal value 200 pF).
- (2) Readjust C461, C441, and C433 in Model
1402A for optimum flat top on pulse.

Page 5-3, Paragraph 5-25,

Under step c: Change Note to read: Note 1.

ADD: Note 2.

With Model 1402A installed in a 143-series
mainframe, the range of C461, C441, and
C433 may not be sufficient to make proper
adjustment in step c. In this case, replace
C462 with a capacitor of approximately
200 pF. Then rerun this adjustment.

Page 5-8, Figure 5-2,

C251: Change Ac to A3.

Page 5-13, Figure 5-6,

R149: Relocate 'CW' note to opposite end of resistor.
R173 and R174: Change value to 698 ohms.

Page 5-15, Figure 5-8,

R249: Relocate 'CW' note to opposite end of resistor,

Page 5-16, Figure 5-9,

Replace with attached Figure 5-9.

Δ Page 5-17, Figure 5-11,

R332: Change value to 301.

R333: Change value to 301.

Page 5-18, Figure 5-13,

On the grid locator, delete C460 at B5 and add C440
at B5.

On the photograph, reverse CR461 and CR462.

Page 5-19, Figure 5-14,

Add asterisk (*) adjacent to C462 to show optimum
value selected at factory, typical value shown.

Page 5-20, Figure 5-15,

Replace with attached Figure 5-15.

Δ Page 5-21, Figure 5-17,

R573: Change value to 15.6K.

R574: Change value to 15.4K.

Page 5-22, Figure 5-18,

Delete connection between pins 20 and 21. Label
pin 20 'NC' (no connection). Label pin 21 —12.6V.

Table 6-2,

A2: Change to HP Part No. 01402-66507.

A3: Change to HP Part No. 01402-66508.

C110, C153, C210, C253: Change to HP Part No.

0160-2255, C: fxd cer 8.2 pF 500vdcw, Mfr

Code 72982, Mfr Part No. 301-000-COHO-829C.

C151, C251: Change to HP Part No. 0160-2261,

C: fxd cer 15 pF 5% 500vdcw, Mfr Code 72982,

Mfr Part No. 301-NPO-15PF.

C462: Add to description column (factory selected
value).

Q302: Change to HP Part No. 1853-0080, TSTR:

SI PNP, Mfr 80131, Mfr Part No. 2N4888.

19 November 1974

Δ = Latest additions to this change sheet.

This change sheet supersedes all prior change sheets for this manual.

Supplement A for
01402-90903

ERRATA (Cont'd)

Table 6-2 (Cont'd),

- Q501, Q502: Change to HP Part No. 1853-0016;
Q: pnp Si; Mfr HP Preferred replacement.
- Δ R101: Change to HP Part No. 0698-6400,
R:fxd met flm 900k ohm 1% 1/4w, Mfr
28480, Mfr Part No. 0698-6400.
- Δ R102: Change to HP Part No. 0757-0049, R:fxd
met flm 111k ohm 1% 1/2w, Mfr 28480, Mfr
Part No. 0757-0049.
- Δ R103: Change to HP Part No. 0757-0057, R:fxd
met flm 990k ohm 1% 1/2w, Mfr 28480, Mfr
Part No. 0757-0057.
- Δ R104: Change to HP Part No. 0757-0040, R:fxd
met flm 10.1k ohm 1% 1/2w, Mfr 28480,
Mfr Part No. 0757-0040.
- Δ R111: Change to HP Part No. 0698-4077, R:fxd
met flm 600k ohm 1% 1/4w, Mfr 28480, Mfr
Part No. 0698-4077.
- Δ R112: Change to HP Part No. 0698-6684, R:fxd
met flm 667k ohm 1% 1/4w, Mfr 28480, Mfr
Part No. 0698-6684.
- Δ R113: Change to HP Part No. 0698-6654, R:fxd
met flm 800k ohm 1% 1/4w, Mfr 28480, Mfr
Part No. 0698-6654.
- Δ R121: Change to HP Part No. 0757-0059, R:fxd
met flm 1 megohm 1% 1/2w, Mfr 28480, Mfr
Part No. 0757-0059.
- R173 and R174: Change to HP Part No. 0727-0088,
R:fxd depc 698 ohms 1% 1/2w, Mfr HP.
- Δ R201: Change to HP Part No. 0698-6400, R:fxd
met flm 900k ohm 1% 1/4w, Mfr 28480, Mfr
Part No. 0698-6400.
- Δ R202: Change to HP Part No. 0757-0049, R:fxd
met flm 111k ohm 1% 1/2w, Mfr 28480, Mfr
Part No. 0757-0049.
- Δ R203: Change to HP Part No. 0757-0057, R:fxd
met flm 990k ohm 1% 1/2w, Mfr 28480, Mfr
Part No. 0757-0057.

Table 6-2 (Cont'd),

- Δ R204: Change to HP Part No. 0757-0040, R:fxd
met flm 10.1k ohm 1% 1/2w, Mfr 28480, Mfr
Part No. 0757-0040.
- Δ R211: Change to HP Part No. 0698-4077, R:fxd
met flm 600k ohm 1% 1/4w, Mfr 28480, Mfr
Part No. 0698-4077.
- Δ R212: Change to HP Part No. 0698-6684, R:fxd
met flm 667k ohm 1% 1/4w, Mfr 28480, Mfr
Part No. 0698-6684.
- Δ R213: Change to HP Part No. 0698-6654, R:fxd
met flm 800k ohm 1% 1/4w, Mfr 28480, Mfr
Part No. 0698-6654.
- Δ R221: Change to HP Part No. 0757-0059, R:fxd
met flm 1 megohm 1% 1/2w, Mfr 28480, Mfr
Part No. 0757-0059.
- Δ R332: Change to HP Part No. 0757-0334, R:fxd
met flm 301 ohm 1% 1/4w, Mfr 28480, Mfr
Part No. 0757-0334.
- Δ R333: Change to HP Part No. 0757-0334, R:fxd
met flm 301 ohm 1% 1/4w, Mfr 28480, Mfr
Part No. 0757-0334.
- Δ R481: Change to HP Part No. 0698-5884, R:fxd
met flm 22 ohm 5% 1/4w, Mfr 28480, Mfr
Part No. 0698-5884.
- Δ R573: Change to HP Part No. 0698-4006, R:fxd
met flm 15.6k ohm 1% 1/8w, Mfr 28480, Mfr
Part No. 0698-4006.
- Δ R574: Change to HP Part No. 0698-3540, R:fxd
met flm 15.4k ohm 1% 1/8w, Mfr 28480, Mfr
Part No. 0698-3540.
- V101, V201, V401: Change to HP Part No. 5080-
0410.
- Miscellaneous:
Add: HP Part No. 01420-01202; Bracket, cable.
Add: HP Part No. 175A-141C; Plate insulator.

CHANGE 1

Table 6-2,
R149, R249: Change to HP Part No. 2100-2293; same
description and Mfr.

OPTION 090

Model 1402A Option 090 is identical to the standard
instrument except for the addition of two HP Model
10012A or 10012B Probes.

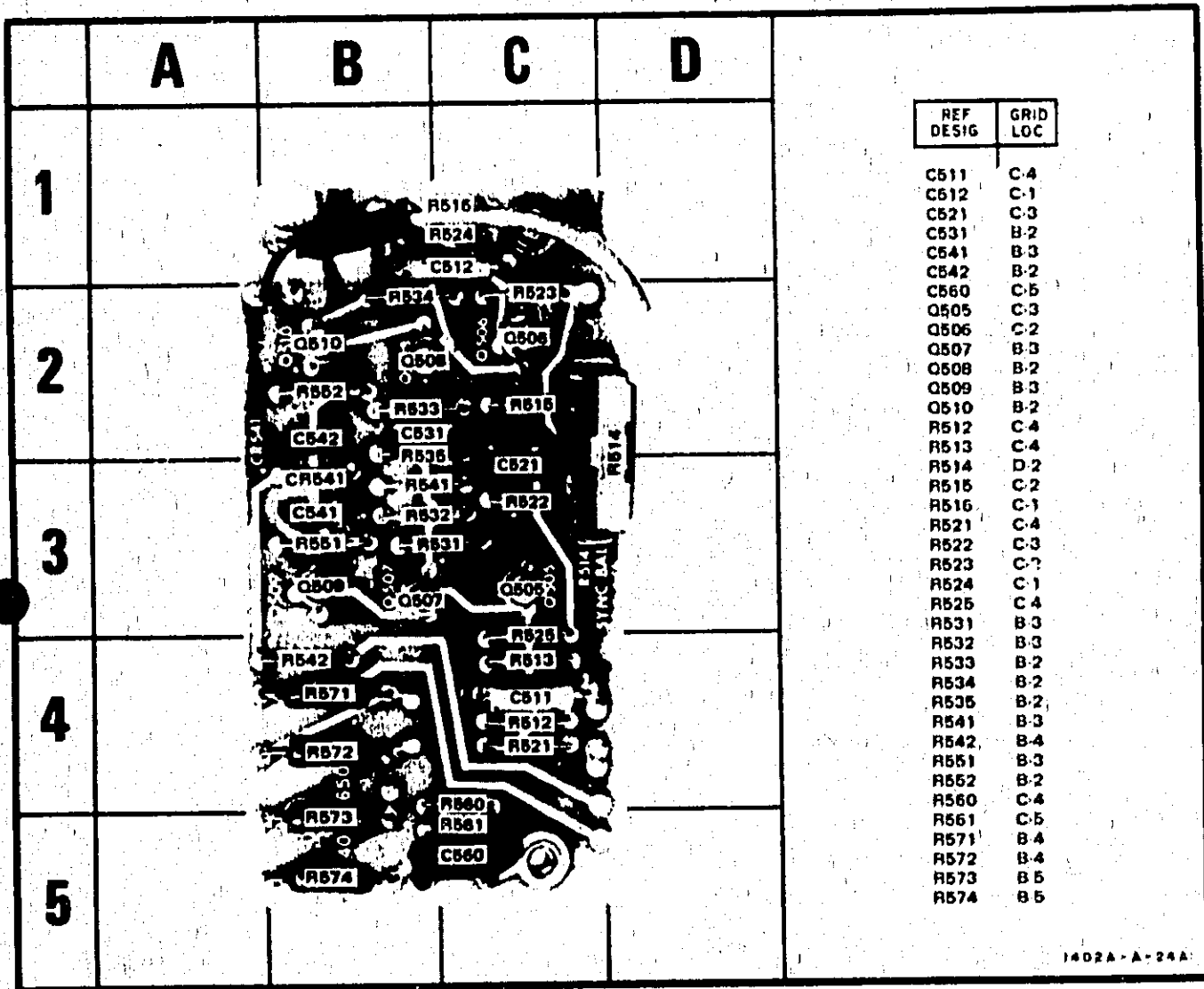

Figure 5-15. Component Locations on Trigger Amplifier Board A3

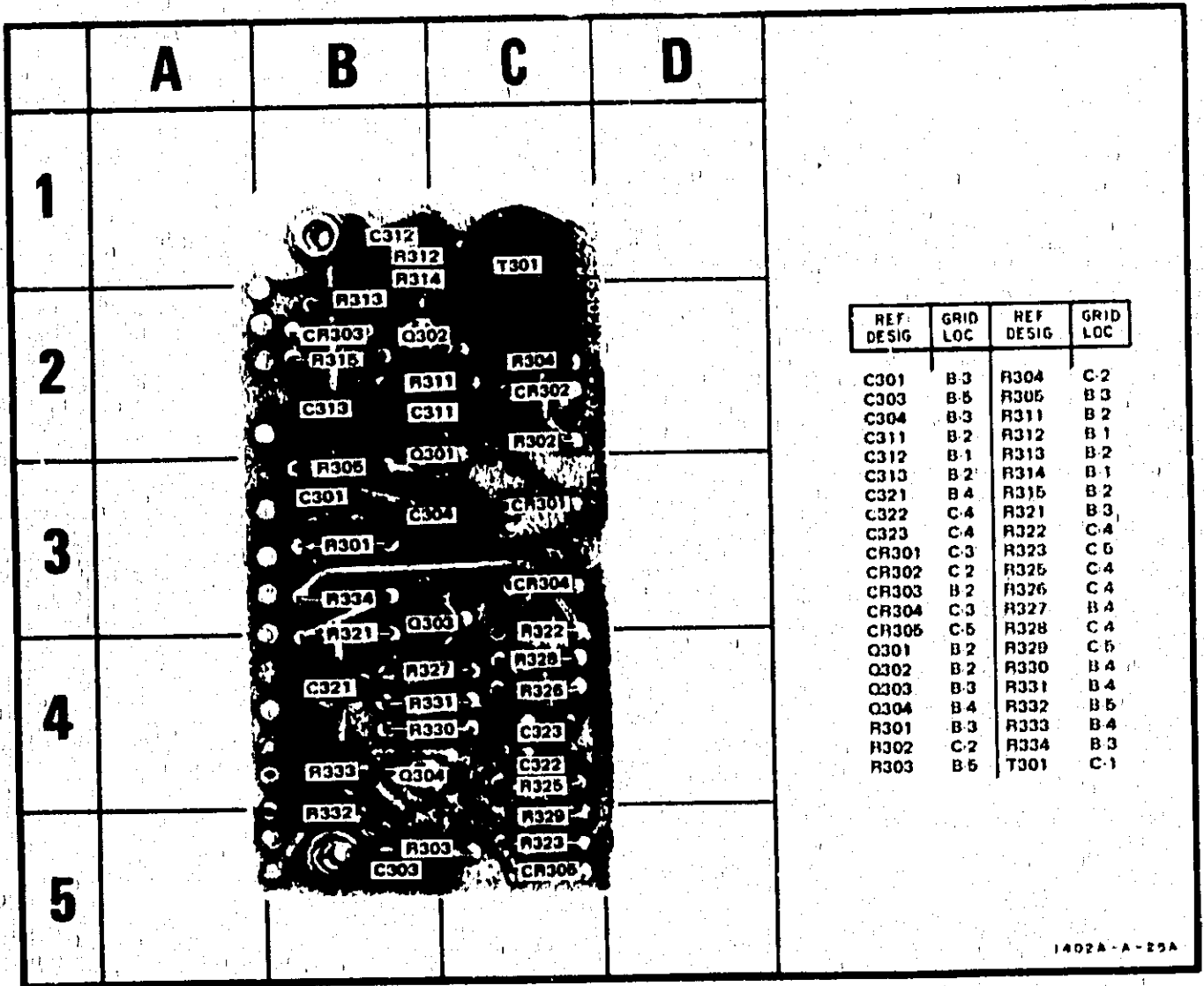

Figure 5-9. Component Locations on Switching Circuit Board A2