

OPERATING AND SERVICE MANUAL

RATE GENERATOR 1905A

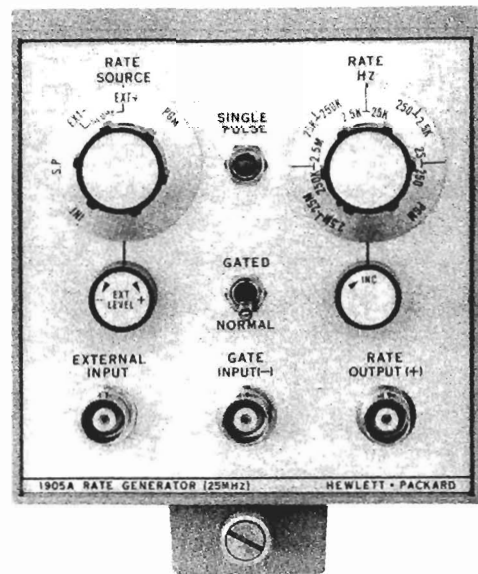

HEWLETT  PACKARD

CERTIFICATION

The Hewlett-Packard Company certifies that this instrument was thoroughly tested and inspected and found to meet its published specifications when it was shipped from the factory. The Hewlett-Packard Company further certifies that its calibration measurements are traceable to the U.S. National Bureau of Standards to the extent allowed by the Bureau's calibration facility.

WARRANTY AND ASSISTANCE

This Hewlett-Packard product is warranted against defects in materials and workmanship. This warranty applies for one year from the date of delivery, or, in the case of certain major components listed in the operating manual, for the specified period. We will repair or replace products which prove to be defective during the warranty period provided they are returned to Hewlett-Packard. No other warranty is expressed or implied. We are not liable for consequential damages.

Service contracts or customer assistance agreements are available for Hewlett-Packard products that require maintenance and repair on-site.

For any assistance, contact your nearest Hewlett-Packard Sales and Service Office. Addresses are provided at the back of this manual.



OPERATING AND SERVICE MANUAL

MODEL 1905A
RATE GENERATOR

SERIALS PREFIXED: 731-

See Section VII for Instruments with other Serial Prefixes

Copyright HEWLETT-PACKARD COMPANY / COLORADO SPRINGS DIVISION 1968
1900 GARDEN OF THE GODS ROAD, COLORADO SPRINGS, COLORADO, U. S. A.

TABLE OF CONTENTS

Section	Page	Section	Page
I	GENERAL INFORMATION	V	PERFORMANCE CHECK AND
	1-1. Instrument Description		ADJUSTMENTS
	1-3. Instrument Identification		5-1. Introduction
	1-5. Manual Changes		5-3. Test Equipment
	1-7. Options		5-5. Performance Check
	1-9. Equipment and Accessories		5-9. Preliminary Test Set-up
	Available		5-11. Output Pulse Characteristic
	1-11. Scope of the Manual		5-12. Output Pulse Jitter
			5-13. External Gating
			5-14. External Triggering
			5-15. Internal Repetition Rate
			5-16. Adjustment Procedure
			5-18. Pulse Amplitude
			5-19. Internal Repetition-rate
			Calibration
II	INSTALLATION	VI	REPLACEABLE PARTS
	2-1. Initial Inspection		6-1. Introduction
	2-2. Mechanical Check		6-4. Ordering Information
	2-4. Electrical Check	VII	MANUAL CHANGES AND OPTIONS
	2-6. Claims		7-1. Manual Changes
	2-9. Repackaging for Shipment		7-3. Older Instruments
	2-12. Preparation for Use		7-5. Newer Instruments
			7-7. Options
			7-9. Special Instruments
III	OPERATION	VIII	SCHEMATICS AND TROUBLE-
	3-1. Introduction		SHOOTING
	3-3. Controls and Connectors		8-1. Introduction
	3-14. Operating Considerations		8-3. Schematic Features
	Interface Switches		8-5. Component Identification
	3-17. Gating of Pulses		8-7. Reference Designations
	3-19. Operating Procedures		8-10. Troubleshooting
	3-20. Internal Drive Mode		8-12. Preliminary Checkout
	3-22. External Drive Mode		8-14. Detailed Checkout
	3-24. Single Pulse Mode		8-19. Repair and Replacement
			8-21. Etched Circuit Board
			Servicing
			8-23. Recalibration
IV	PRINCIPLES OF OPERATION		
	4-1. Introduction		
	4-3. Over-all Functional Description		
	4-8. Detailed Theory of Operation		
	4-10. Trigger Generator		
	4-15. Ramp Generator		
	4-21. External Amplifier		
	4-25. +10-volt DC Supply		
	4-27. -20-volt DC Supply		

LIST OF ILLUSTRATIONS

Figure	Title	Page	Figure	Title	Page
1-1.	Model 1905A Rate Generator	1-0	5-3.	External Gating Test Setup	5-2
3-1.	Front-panel Controls and Connectors	3-0	5-4.	External Trigger Test Setup	5-2
3-2.	Model 1905A Interface Switches	3-1	5-5.	Internal Repetition-rate Test Setup	5-3
4-1.	Model 1905A Simplified Block Diagram	4-0	8-1.	Model 1905A Troubleshooting Tree	8-3
4-2.	Trigger Circuit Waveforms	4-1	8-2.	Chassis Parts Identification	8-4
5-1.	Output Pulse Test Setup	5-1	8-3.	A1 Assembly Component Identification	8-4
5-2.	Pulse Characteristics	5-1	8-4.	Waveforms	8-5/8-6
			8-5.	Rate Generator Schematic	8-5/8-6
			8-6.	Over-all Block Diagram	8-7/8-8

LIST OF TABLES

Table	Title	Page	Table	Title	Page
1-1.	Specifications	1-0	6-1.	Reference Designators and Abbreviations	6-1
2-1.	Shipping Carton Strength	2-1	6-2.	Replaceable Parts	6-2
5-1.	Test Equipment Required	5-0	7-1.	Manual Changes	7-1
5-2.	Internal Repetition-rate Measurements (Part I)	5-3	8-1.	Schematic Notes	8-0
5-3.	Internal Repetition-rate Measurements (Part II)	5-4	8-2.	Waveform Test Conditions	8-4
	Performance Check Record	5-4 a/b	8-3.	DC Voltage Test Conditions	8-4

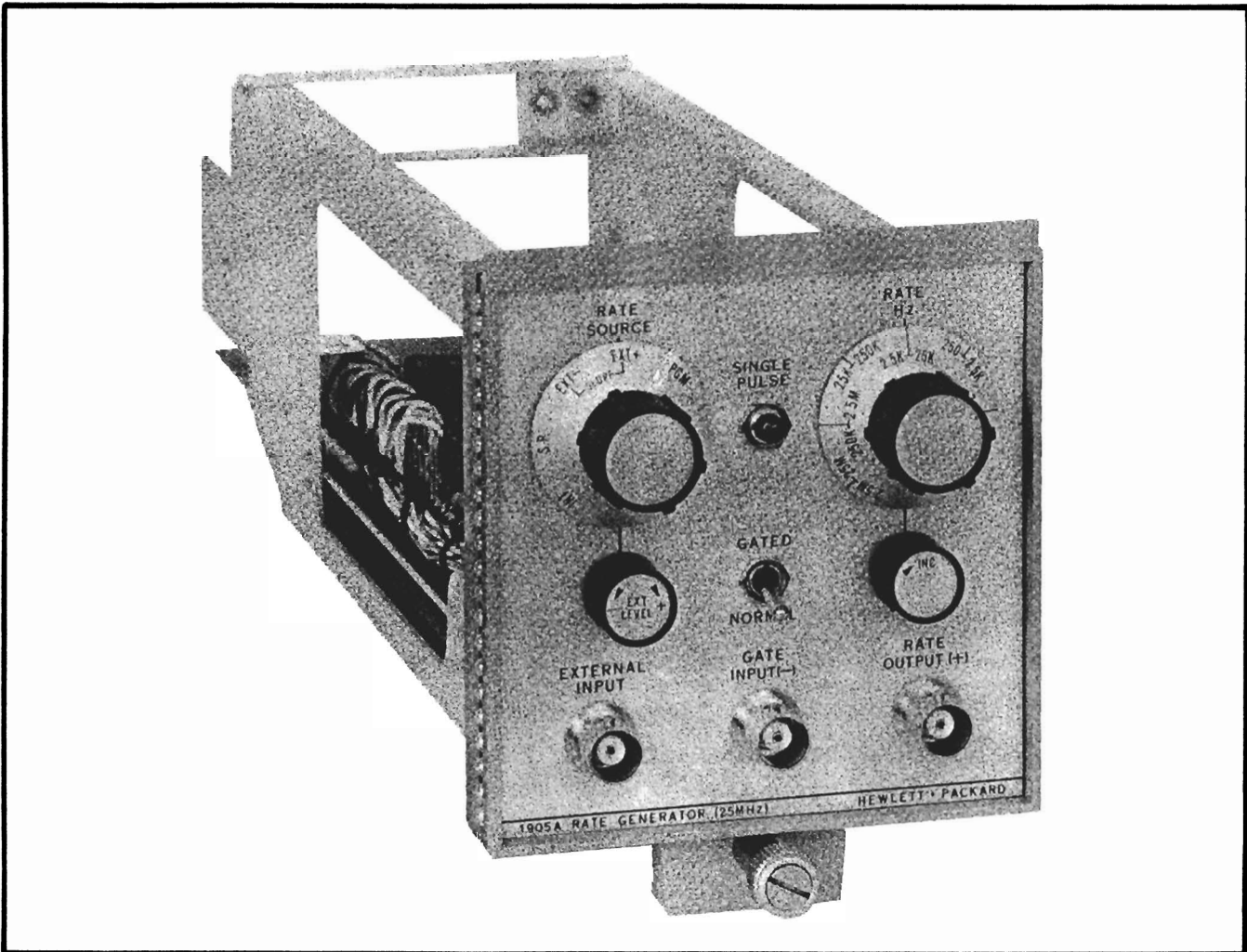

Figure 1-1. Model 1905A Rate Generator

Table 1-1. Specifications

FREQUENCY RANGE

INTERNAL: 25 Hz to 25 MHz in 6 decade ranges.
10:1 vernier provides continuous adjustment within selected range.
EXTERNAL: 0 to 25 MHz.

OUTPUT PULSE

AMPLITUDE: > 1V into 25 ohms.
SOURCE IMPEDANCE: 50 ohms.
RISETIME AND FALLTIME: < 5 nsec.
PULSE JITTER: Internal rate less than 0.1%.
PULSE WIDTH: < 10 nsec.
FAN OUT: Capable of driving two 50-ohm loads.

EXTERNAL TRIGGERING

FREQUENCY: 0 to 25 MHz.
SENSITIVITY: 0.5 V pk-pk.
INPUT IMPEDANCE: Approximately 50 ohms (dc coupled).

SLOPE TRIGGER: Positive or negative (selectable).

TRIGGER LEVEL: Variable from +3V to -3V.

SYNCHRONOUS GATE

SENSITIVITY: (-) 2V gates rate generator on.
INPUT IMPEDANCE: Approximately 50 ohms (dc coupled).

GENERAL

COMPATIBILITY: The Model 1905A is used with the 1900-series mainframe and associated plug-ins.

WEIGHT: Net, 1.5 lbs. (0,7 kg). Shipping, 3.5 lbs. (1,6 kg).

OPTIONS: Provide interface circuitry required to adapt the Model 1905A for use in externally programed 1900-series pulse generator configurations.

SECTION I GENERAL INFORMATION

1-1. INSTRUMENT DESCRIPTION.

1-2. The HP Model 1905A Rate Generator, shown in Figure 1-1, is a pulse generating plug-in unit designed for use in the 1900-series mainframe. The Model 1905A Rate Generator (hereafter referred to as the Model 1905A) provides positive output pulses of constant amplitude and width having selectable repetition rates. Pulses are generated internally at repetition rates of from 25 Hz to 25 MHz (in 6 selectable ranges). A vernier control (INC) provides continuous repetition-rate adjustment within the selected range. Pulse repetition rates from dc to 25 MHz are also obtained using an external trigger source having a minimum signal amplitude of 0.5 volt peak-to-peak. Trigger slope and level points of the external signal may be selected to obtain the desired triggering point. A single output pulse is generated each time the SINGLE PULSE push button is pressed. Synchronous gating of the output pulse is accomplished by applying a -2-volt (or greater) gate pulse from an external source to the GATE INPUT jack. An output pulse will then occur only during the time the negative gate pulse is applied. The Model 1905A input and output circuits match an external system impedance of 50 ohms to minimize reflection. Refer to Table 1-1 for the instrument specifications and operating characteristics.

1-3. INSTRUMENT IDENTIFICATION.

1-4. Hewlett-Packard uses a two-section, eight-digit serial number to identify instruments. The first three digits (000-00000) are the serial prefix and identify a group of instruments; the last five digits identify a particular instrument in that group. The serial number appears on a plate located below the front panel of the instrument. All correspondence with a Hewlett-Packard Sales/Service Office in regard to any instrument should reference the complete serial number of that instrument.

1-5. MANUAL CHANGES.

1-6. Information in this manual applies directly to an instrument with a serial prefix as shown on the title page. If the serial prefix shown on the instru-

ment is not the same as the serial prefix shown on the title page of this manual, a MANUAL CHANGES sheet supplied with the manual, or the information in Section VII, will define the differences between the two instruments. The MANUAL CHANGES sheet also contains corrections to this manual due to errors that existed when the manual was printed. These corrections are called Errata. For information pertaining to the MANUAL CHANGES sheet, contact the nearest Hewlett-Packard Sales/Service Office.

1-7. OPTIONS.

1-8. The Model 1905A is available with several programming options. With the programming option installed, the Model 1905A is capable of being externally programmed for automatic selection of operating mode and repetition rate. For complete information covering the programming options, contact the nearest HP Sales/Service Office.

1-9. EQUIPMENT AND ACCESSORIES AVAILABLE.

1-10. A complete line of electronic test equipment is available from the Hewlett-Packard Company for use in making test measurements and maintaining the Model 1905A. Also available are cables, connectors, adaptors, and other accessory items for use in various test or measurement applications. For information on specific items, refer to the HP catalog or contact the nearest HP Sales/Service Office.

1-11. SCOPE OF THE MANUAL.

1-12. This manual contains information covering the operation and maintenance of the HP Model 1905A Rate Generator. This manual also supplements the information presented in the manual for the 1900-series mainframe in which the Model 1905A is used. Refer to the mainframe manual for specific information concerning other 1900-series plug-ins, refer to the manual covering that particular unit.

SECTION II INSTALLATION

2-1. INITIAL INSPECTION.

2-2. MECHANICAL CHECK.

2-3. Upon receipt of the Model 1905A, visually inspect the instrument for any damage that may have occurred during shipment. Check for physical damage such as broken knobs, bent or broken connectors, and dents or scratches on the front panel or chassis. If damage is found, refer to Paragraph 2-6 for the recommended claim procedure. If instrument appears undamaged, perform the electrical check (Paragraph 2-4). Retain all packing material for possible use in reshipment.

2-4. ELECTRICAL CHECK.

2-5. Check the electrical performance of the Model 1905A as soon as possible after receipt. Paragraph 5-5 contains performance check procedures that will determine whether or not the instrument is still operating within its specifications as listed in Table 1-1. Initial performance and accuracy of this instrument are certified as stated on the inside front cover of this manual. If the Model 1905A does not operate as specified, refer to Paragraph 2-6 for the recommended claim procedure.

2-6. CLAIMS.

2-7. If physical damage is found, or if the instrument does not operate within specifications when received, notify the carrier and the nearest Hewlett-Packard Sales/Service Office immediately. The Sales/Service Office will arrange for repair or replacement of the instrument without waiting for a claim to be settled with the carrier.

2-8. The warranty statement for all Hewlett-Packard products is on the inside front cover of this manual. Contact the nearest Sales/Service Office (addresses listed in rear of this manual) for information about warranty claims.

2-9. REPACKAGING FOR SHIPMENT.

2-10. When shipping an instrument to a Hewlett-Packard Sales/Service Office, attach a tag to it that gives the owner's name and address, the instrument

model number, date of purchase, eight-digit serial number, and a description of the service required.

2-11. Use the original shipping carton and packaging material for shipment. If they are not available or reusable, pack the instrument in the following material:

- a. A double-walled carton that meets the requirements of Table 2-1.
- b. Heavy paper or sheets of cardboard to protect all instrument surfaces. Use a non-abrasive material such as polyurethane foam, or a cushioned paper such as Kimpack around all projecting parts.
- c. At least 4 inches of tightly-packed, industry-approved, shock-absorbing material, such as extra-firm polyurethane foam.
- d. Heavy-duty shipping tape to secure the outside of the carton.

Table 2-1. Shipping Carton Strength

Gross Weight (lbs)	Carton Strength (test lbs)
up to 10	200
10 to 30	275
30 to 120	350
120 to 140	500
140 to 160	600

2-12. PREPARATION FOR USE.

2-13. The Model 1905A can be used in any one of the compartments of the mainframe, but it is normally installed in the left-hand compartment when used with compatible 1900-series plug-ins to form a pulse generator set. To install the Model 1905A, insert the unit into the guide rails in the appropriate mainframe compartment and carefully slide the chassis into place. Make sure that the mating connectors are properly joined. Secure the unit in place by tightening the lock knob located below the Model 1905A front panel. All required operating power is supplied by the 1900-series mainframe.

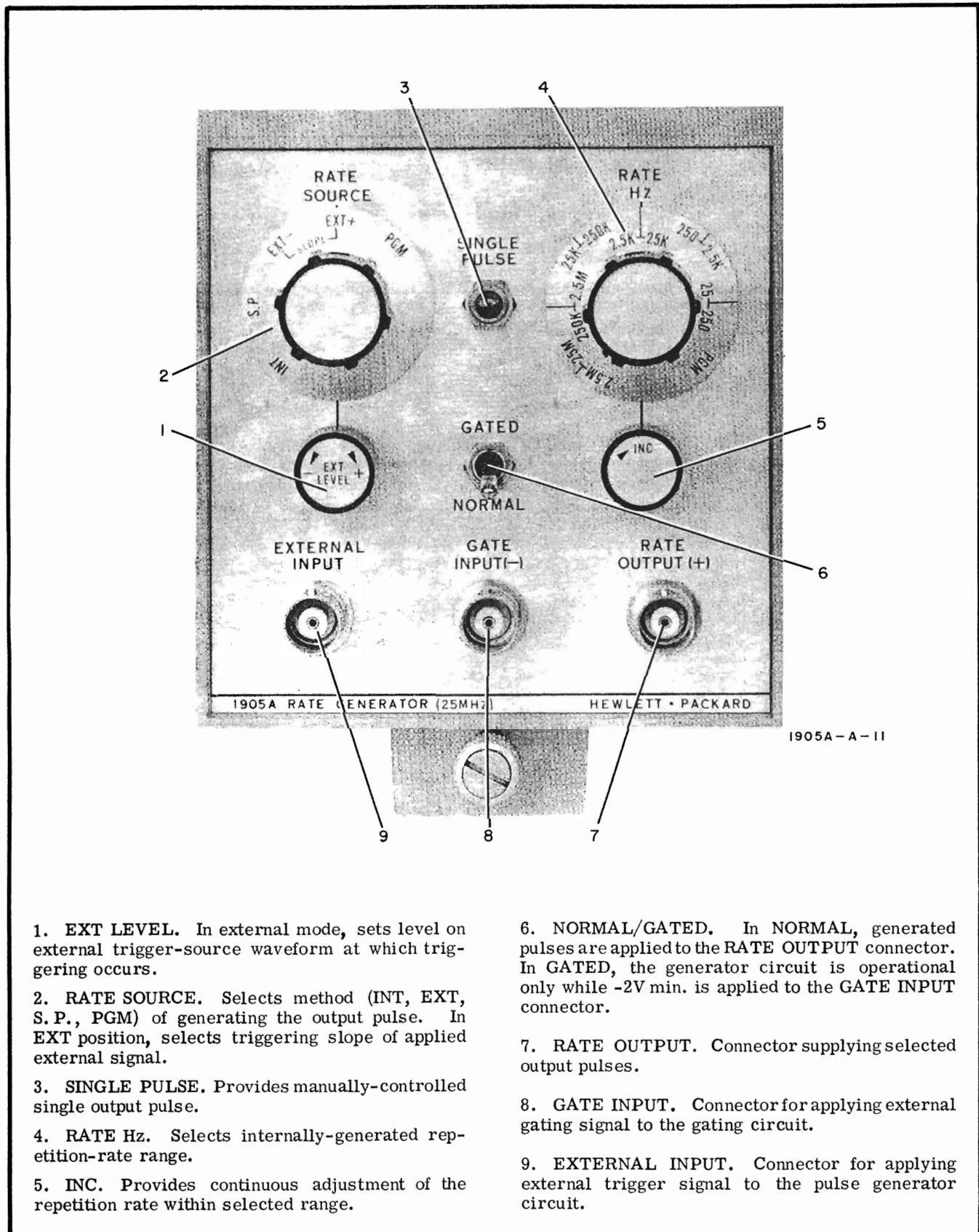

- 1. **EXT LEVEL.** In external mode, sets level on external trigger-source waveform at which triggering occurs.
- 2. **RATE SOURCE.** Selects method (INT, EXT, S.P., PGM) of generating the output pulse. In EXT position, selects triggering slope of applied external signal.
- 3. **SINGLE PULSE.** Provides manually-controlled single output pulse.
- 4. **RATE Hz.** Selects internally-generated repetition-rate range.
- 5. **INC.** Provides continuous adjustment of the repetition rate within selected range.

- 6. **NORMAL/GATED.** In NORMAL, generated pulses are applied to the RATE OUTPUT connector. In GATED, the generator circuit is operational only while -2V min. is applied to the GATE INPUT connector.
- 7. **RATE OUTPUT.** Connector supplying selected output pulses.
- 8. **GATE INPUT.** Connector for applying external gating signal to the gating circuit.
- 9. **EXTERNAL INPUT.** Connector for applying external trigger signal to the pulse generator circuit.

Figure 3-1. Front-panel Controls and Connectors.

SECTION III OPERATION

3-1. INTRODUCTION.

3-2. This section contains information concerning the functions of the controls and connectors on the Model 1905A Rate Generator and provides instructions for operating the instrument.

3-3. CONTROLS AND CONNECTORS.

3-4. The front-panel controls and connectors on the Model 1905A are identified and briefly described in Figure 3-1. A detailed description of the function of each control and connector is given in Paragraphs 3-5 through 3-13. Information regarding the settings of the controls for specific modes of operation is given in Paragraphs 3-19 through 3-25.

3-5. **RATE SOURCE.** The **RATE SOURCE** switch selects the method of generating the rate output pulse. Switch positions permit selection of **INT** (internal repetition rate), **S. P.** (single pulse), and **EXT-** or **EXT+** (external trigger source) drive modes. A **PGM** position permits automatic programming of the drive mode when the Model 1905A is equipped with a programming option and is used in programable 1900-series pulse generator applications.

3-6. **EXT LEVEL.** The **EXT LEVEL** control sets the voltage level where triggering occurs on the external trigger waveform. The control provides variable trigger level adjustment from +3 volts to -3 volts. The control is operative only when the Model 1905A is operating in the external drive mode.

3-7. **SINGLE PULSE.** The **SINGLE PULSE** push button switch provides a single pulse output each time the switch is pressed. The **SINGLE PULSE** push button switch is operative only when the **RATE SOURCE** switch is set to **S. P.**

3-8. **RATE.** The **RATE** switch selects the repetition rate of internally-generated output pulses when the **RATE SOURCE** switch is set to **INT**. The **RATE** switch permits selection on any one of six repetition-rate ranges within a 25 Hz to 25 MHz frequency limit. A **PGM** position permits automatic programming of the repetition-rate range when the Model 1905A is equipped with a programming option and is used in programable 1900-series pulse generator applications.

3-9. **INC.** The **INC**rement control potentiometer allows continuous adjustment of the internal repetition rate between the range limits set by the **RATE** switch. The **INC** control is disabled when the **RATE** switch is set to the **PGM** position.

3-10. **NORMAL/GATED.** The **NORMAL/GATED** switch permits selection of a continuous or gated output pulse provided an appropriate gate signal is applied to the Model 1905A **GATE INPUT** connector. When the **NORMAL/GATED** switch is set to the **GATED** position, the duration of the **RATE OUTPUT** pulse is controlled by the **GATE INPUT** signal.

3-11. **RATE OUTPUT.** The **RATE OUTPUT** connector provides a means of connecting the Model 1905A output pulse to external equipment or associated 1900-series plug-in units.

3-12. **GATE INPUT.** The **GATE INPUT** connector provides a means of connecting an external gate signal to the Model 1905A for synchronous gating of the **RATE OUTPUT** pulse.

3-13. **EXTERNAL INPUT.** The **EXTERNAL INPUT** connector provides a means of connecting an external trigger signal to the Model 1905A when operating in the external drive mode.

3-14. OPERATING CONSIDERATIONS.

3-15. INTERFACE SWITCHES.

3-16. The Model 1905A is equipped with three interface switches (see Figure 3-2). The switches permit the operator to route Model 1905A input and output signals through selectable 1900-series mainframe inter-compartment coaxial connectors instead of through front-panel connectors. The switches are located on underside of the Model 1905A directly below the front-panel connector function being controlled. When the interface switches are set to the forward position, the Model 1905A input and output signals are routed through

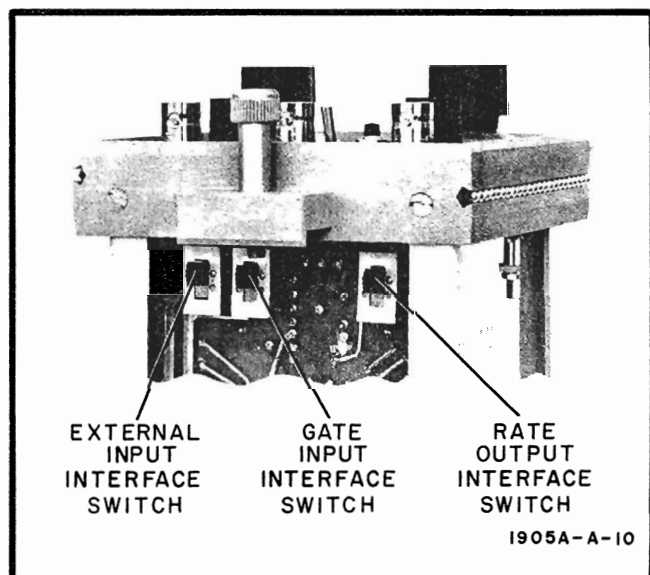

Figure 3-2. Model 1905A Interface Switches

the respective front-panel connectors. With the interface switches set to the rear position, the input and output signals are routed through the Model 1905A plug-in connector and the 1900-series mainframe intercompartment coaxial connectors.

Note

Do not operate the Model 1905A with the interface switches set to the rear position unless the mainframe intercompartment coaxial cabling is properly connected. Refer to the 1900-series mainframe manual for information covering intercompartment cabling configurations and installations.

3-17. GATING OF PULSES.

3-18. By applying a negative gate signal to the Model 1905A GATE INPUT (front-panel or interface routing), and setting the NORMAL/GATED switch to GATED, pulses will occur at the output only when the gate signal is -2 volts or greater. This mode of operation can be used in conjunction with internal or external drive modes. For synchronized pulse trains, the gating signal and repetition rate must be locked together.

3-19. OPERATING PROCEDURES.

3-20. INTERNAL DRIVE MODE.

3-21. In the internal drive mode, the Model 1905A generates pulses at a frequency set by the RATE

switch and INC control. To operate the Model 1905A in this mode, proceed as follows:

- a. Set the RATE SOURCE switch to INT.
- b. Set the RATE switch to the appropriate repetition-rate range; then adjust the INC control for the specific repetition rate desired. (Maximum rate within a selected range is fully cw.)
- c. Set the NORMAL/GATED switch to NORMAL unless operating in a gated mode. (Refer to Paragraph 3-17.)

3-22. EXTERNAL DRIVE MODE.

3-23. To operate the Model 1905A in the external drive mode, an external trigger signal from dc to 25 MHz with an amplitude of at least 0.5 volt peak-to-peak is required. After connecting the appropriate external trigger source to the Model 1905A EXTERNAL INPUT (front-panel or interface routing), proceed as follows:

- a. Set the RATE SOURCE switch to EXT- or EXT+ to correspond with the slope triggering desired.
- b. Adjust the EXT LEVEL control for the desired triggering level on the input waveform.
- c. Set the NORMAL/GATED switch to NORMAL unless operating in a gated mode. (Refer to Paragraph 3-17.)

3-24. SINGLE PULSE MODE.

3-25. With the NORMAL/GATED switch set to NORMAL and the RATE SOURCE switch set to S. P., a single pulse output is produced each time the SINGLE PULSE push button switch is pressed. No additional front-panel control settings are required for this mode of operation.

NOTES

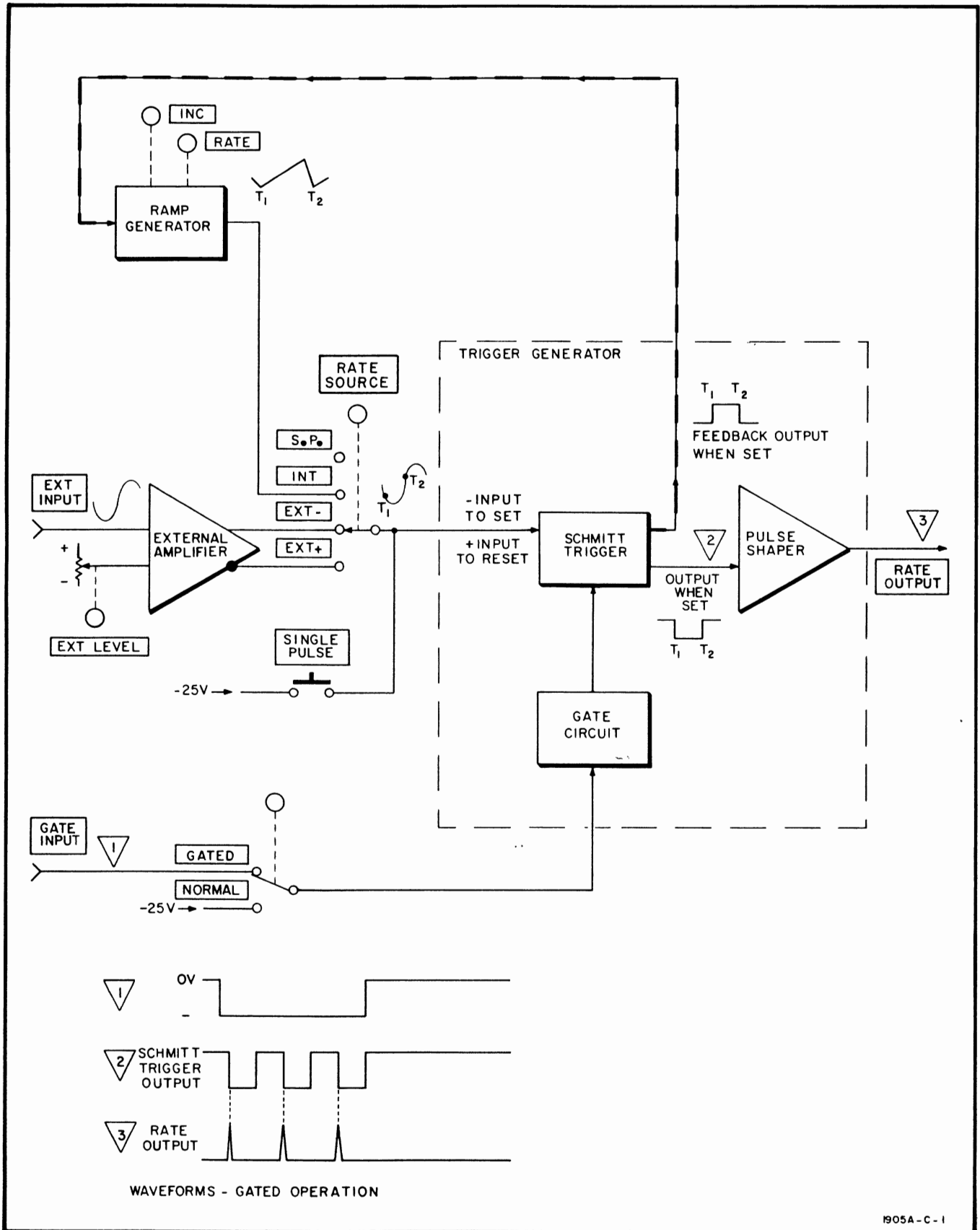

Figure 4-1. Model 1905A Simplified Block Diagram

SECTION IV PRINCIPLES OF OPERATION

4-1. INTRODUCTION.

4-2. This section contains the theory of operation for the Model 1905A Rate Generator. The theory of operation is explained using block diagrams, schematics and waveform illustrations. The descriptive text includes over-all and detailed circuit explanations.

4-3. OVER-ALL FUNCTIONAL DESCRIPTION.

4-4. Figure 4-1 is a simplified block diagram showing the relationship of the principal circuits in the Model 1905A. The instrument consists, basically, of a trigger generator, ramp generator and an external amplifier

4-5. The trigger generator is driven by either the ramp generator, external amplifier, or by a SINGLE PULSE push button switch, depending on the position of the RATE SOURCE switch. When the selected drive signal goes sufficiently negative, the Schmitt trigger circuit develops a negative-going step pulse output. This negative-going step pulse is coupled directly to the pulse shaper circuit. The pulse shaper differentiates and inverts the negative step pulse to produce a positive-going (spike) pulse output. The operation of the Schmitt trigger is also controlled by a gate circuit. When the NORMAL/GATED switch is set to NORMAL, the gate circuit is energized, and the Schmitt trigger functions normally. With the NORMAL/GATED switch set to GATED, the Schmitt trigger is enabled (operational) only when a negative gate signal is applied to the GATE INPUT.

4-6. With the RATE SOURCE set to INT, the ramp-generator ramp voltage is coupled to the Schmitt trigger. A positive pulse is fed back to the ramp generator when the Schmitt trigger is set. This positive pulse initiates a positive-going ramp voltage. When the ramp voltage reaches +2 volts, the Schmitt trigger resets, and a negative feedback pulse is coupled to the ramp generator. The ramp voltage now decreases to -2 volts, the Schmitt trigger is set again, and the cycle is repeated. Since a RATE OUTPUT pulse is generated each time the Schmitt trigger sets, the RATE and INC controls establish the repetition rate of the output pulse train.

4-7. In the EXT positions, with an EXTERNAL INPUT signal applied, the RATE SOURCE switch selects either an in-phase or an inverted signal output from the external amplifier. In the EXT+ position, the inverted output from the external amplifier is routed to the Schmitt trigger to provide positive-slope triggering. In the EXT- position, the in-phase output of the external amplifier is applied to the Schmitt trigger for negative-slope triggering. The EXT LEVEL control sets the voltage level at which triggering occurs by applying a dc off-set voltage to the external amplifier.

4-8. DETAILED THEORY OF OPERATION.

4-9. The following functional descriptions provide a detailed explanation of the operation of the circuits in the Model 1905A. Use the schematic (Figure 8-5) and the detailed block diagram (Figure 8-6) as an aid in understanding the circuit descriptions.

4-10. TRIGGER GENERATOR.

4-11. The trigger generator consists of Schmitt trigger A1Q8 and A1Q9, differentiator A1Q10, emitter follower A1Q11, current gate A1Q13 and current source A1Q14.

4-12. Schmitt trigger A1Q8 and A1Q9 is a bistable circuit whose output is dependent on the level of the driving signal. Two input (hysteresis) limits determine when the Schmitt trigger will switch operating state (see Figure 4-2). When the driving signal drops below the lower hysteresis limit (point A), the Schmitt trigger switches to the set state (A1Q8 cut off, A1Q9 conducting) and produces a negative-going step-pulse output. When the drive signal becomes more positive than the upper hysteresis limit (point B), the Schmitt trigger is reset (A1Q8 conducting, A1Q9 cut off) and the output pulse steps to a more positive level.

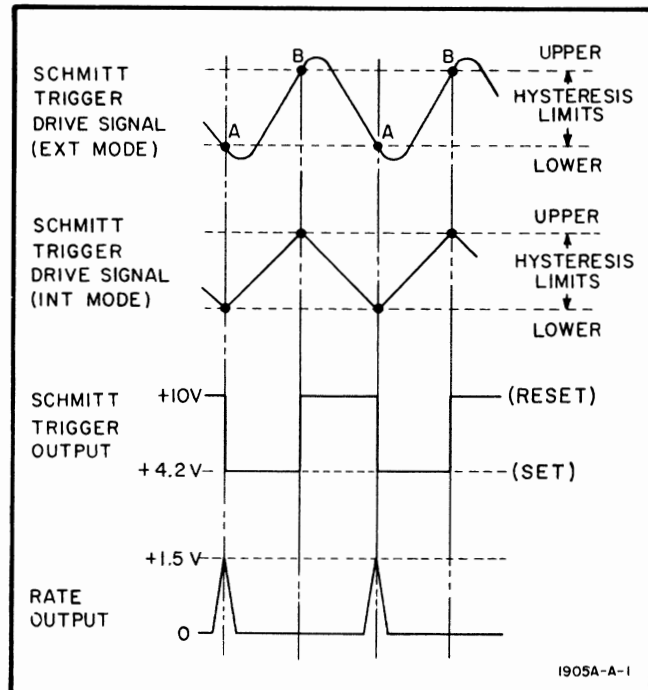

Figure 4-2. Trigger Circuit Waveforms

Paragraphs 4-13 to 4-19

4-13. The Schmitt trigger step-pulse output (Figure 4-2) is coupled directly to differentiator A1Q10. A negative-going step-pulse output from the Schmitt trigger forward biases differentiator A1Q10. With A1Q10 conducting, a positive-going (spike) pulse is developed across resistor A1R29 and inductor A1L3. This positive-going pulse is coupled through emitter follower A1Q11 to the RATE OUTPUT connector. When the Schmitt trigger step-pulse output goes positive, differentiator A1Q10 is reverse biased to cut-off and no RATE OUTPUT signal is generated. A RATE OUTPUT pulse is produced only when the Schmitt trigger step-pulse output is negative-going (set state). OUTPUT ADJ capacitor A1C17 adjusts the amplitude of the RATE OUTPUT pulse. Emitter follower A1Q11 provides impedance matching and circuit isolation.

4-14. The output of the Schmitt trigger is also controlled by current gate A1Q13 and current source A1Q14. When NORMAL/GATED switch S4 is set to NORMAL, the voltage divider network, consisting of A1R36, A1R37, and A1R38, reverse biases current gate A1Q13 to cut off. With A1Q13 cut off, current source A1Q14 is forward biased to conduction and the Schmitt trigger circuit is enabled. With NORMAL/GATED switch S4 set to the GATED position, the voltage divider network, now consisting of A1R36, A1R37, A1R38, and A1R39, forward biases A1Q13 to conduction. With A1Q13 conducting, current source A1Q14 is reverse biased to cut off and the Schmitt trigger circuit is disabled. Current source A1Q14 remains at cut off until a negative (-2 Vdc or greater) GATE INPUT signal drives current gate A1Q13 to cut-off; at which time current source A1Q14 again conducts and the Schmitt trigger is enabled (operational) for the duration of the GATE INPUT signal.

4-15. RAMP GENERATOR.

4-16. The ramp generator consists of current switch driver A1Q15, current source A1Q16, current switch network A1CR9-A1CR12, saturating switch A1Q18-A1Q22 and emitter follower A1Q17. The ramp generator is energized and provides the drive signal to the trigger generator when RATE SOURCE switch S2 is set to INT.

4-17. When the Schmitt trigger circuit in the trigger generator is in the reset state, a negative-going step pulse from the collector of A1Q8 is routed to the base of current switch driver A1Q15. With a negative-going step pulse applied, the conduction of current switch driver A1Q15 decreases and a negative voltage (-3.4 Vdc), developed across the emitter resistor of A1Q15, is applied directly to the junction of A1CR9 and A1CR10 of the current switch. This negative voltage reverse biases A1CR9 and forward biases A1CR10. The junction of A1CR11 and A1CR12 is at a positive level (+2 Vdc) due to the potential on the applicable rate capacitor in the saturating-switch circuit. This positive voltage forward biases A1CR12 and reverse biases A1CR11. With the diodes of the current switch biased in this manner, the negative supply is connected to the saturating switch circuit, and the positive supply is connected, through current source A1Q16, to the emitter of A1Q15. With the negative supply connected to the saturating switch, the potential on the applicable rate capacitor decreases

at a fixed rate, producing a negative-going ramp voltage output. This negative-going ramp voltage is coupled through emitter follower A1Q17 and steering diode A1CR7 to the input of the Schmitt trigger. When the negative-going ramp reaches the lower hysteresis limit, the Schmitt trigger switches to the set state (A1Q8 cut off and A1Q9 conducting) and produces a negative-going step-pulse output (positive RATE OUTPUT). The feedback to the base of current driver A1Q15 is now at a positive level. With the positive-going step voltage applied, the conduction of A1Q15 increases and a positive voltage (+3.6 Vdc), developed across emitter resistor A1R50, is applied to the junction of A1CR9 and A1CR10 of the current switch. This positive voltage forward biases A1CR9 and reverse biases A1CR10. The junction of A1CR11 and A1CR12 is at a negative level (-2 Vdc) due to the potential on the rate capacitor in the saturating-switch circuit. This negative potential forward biases A1CR11 and reverse biases A1CR12. With the diodes of the current switch network biased in this manner, the negative and positive supplies are simultaneously switched. The positive supply is now connected through current source A1Q16 to the saturating switch, and the negative supply is connected to the emitter of A1Q15. With the positive supply connected to the rate capacitor of the saturating switch, the ramp voltage output begins to rise to a positive level. When the positive-going ramp voltage output reaches the upper hysteresis limit, the Schmitt trigger returns to the reset state, and the entire cycle is repeated.

4-18. The risetime of the positive-going ramp voltage is determined by the value of the rate capacitor in the saturating-switch circuit and the amplitude of the charging current provided by current source A1Q16. By controlling the positive-going portion of the ramp voltage, the time required to reach the upper hysteresis limit of the Schmitt trigger is also controlled. Thus the repetition rate of the RATE OUTPUT signal is determined by the risetime of the positive-going ramp voltage. The negative-going portion of the ramp voltage is fixed by the circuit constants of the saturating switch.

4-19. The operation of the saturating switch is controlled by RATE switch S1. RATE switch S1 energizes the applicable saturating-switch circuit A1Q18-A1Q22 which connects the respective rate capacitor to the current switch network A1CR9-A1CR12. As the operation of saturating switches A1Q18-A1Q22 are identical, only the circuit operation of A1Q18 will be covered. When RATE switch S1 is set to the 25-250 Hz repetition-rate range, the voltage divider network, consisting of A1R61 and A1R70, forward biases A1Q18 to saturation. With A1Q18 at saturation, rate capacitor A1C27 is connected between the current switch network and the -20 Vdc supply. Rate capacitor A1C27 is now charged and discharged by the switching action of current switch network A1CR9-A1CR12. When the current switch network connects the positive supply to rate capacitor A1C27, the capacitor begins to charge to a positive potential. At a +2 Vdc level, the upper hysteresis limit of the Schmitt trigger is reached, and the bias on the current switch network instantaneously switches A1C27 to the negative supply. A1C27 discharges through A1Q18, A1R54 and A1CR12 toward

-20 Vdc. At a -2 Vdc level, the lower hysteresis limit of the Schmitt trigger is reached. At this point, the bias on the current switch network instantaneously switches the rate capacitor A1C27 back to the positive supply, and the cycle is repeated. When saturating switch A1Q18 is in the de-energized (off) state, both junctions are reverse biased by the -20 Vdc supply to prevent A1Q18 collector-to-base leakage current from affecting the rate output on other ranges. Resistor A1R60 holds the collector of A1Q18 at approximately -20 Vdc. This prevents rate-capacitor leakage from producing circuit transients in the ramp generator output when saturating switch A1Q18 is initially energized.

4-20. Current source A1Q16 provides a constant current to the current switch network A1CR9-A1CR12 for charging the rate capacitor in the saturating switch. A fixed-base bias network holds A1Q16 in conduction. The setting of INC potentiometer R2 determines the amplitude of the charging current output, thereby controlling the repetition rate of the output signal.

4-21. EXTERNAL AMPLIFIER.

4-22. The external amplifier consists of differential amplifier A1Q3 and A1Q4, positive slope amplifier A1Q5, negative slope amplifier A1Q6, emitter follower A1Q7 and sensitivity switch A1Q12. In either EXT position of RATE SOURCE switch S2, the external amplifier circuits provide the drive signal to the trigger generator. The circuits of the external amplifier enable triggering on either the positive or negative slope of the EXTERNAL INPUT signal. This is accomplished by developing a negative drive signal from either slope of the input signal.

4-23. With an EXTERNAL INPUT signal applied, differential amplifier A1Q3 and A1Q4 provide in-phase and out-of-phase outputs to positive and negative slope amplifiers A1Q5 and A1Q6 respectively. With RATE SOURCE switch S2 set to EXT+, positive slope amplifier A1Q5 and emitter follower A1Q7 are energized. Positive slope amplifier A1Q5 amplifies and inverts the in-phase output from the differential amplifier. The output of the positive slope amplifier is coupled through emitter follower A1Q7 and steering diode A1CR5 to set the Schmitt trigger from a positive-going EXTERNAL INPUT. For negative-slope triggering, RATE SOURCE switch S2 is set to EXT- and negative slope amplifier A1Q6 and emitter follower A1Q7 are

energized. Negative slope amplifier A1Q6 amplifies and inverts the out-of-phase signal from the differential amplifier. The output of negative slope amplifier A1Q6 is coupled through emitter follower A1Q7 and steering diode A1CR5 to the input of the Schmitt trigger. The drive signal applied to the Schmitt trigger is now in phase with the EXTERNAL INPUT signal, and triggering occurs on the negative slope of the input waveform.

4-24. To provide the necessary external triggering sensitivity, RATE SOURCE switch S2 also energizes sensitivity switch A1Q12 in either EXT position. With sensitivity switch A1Q12 at saturation, the hysteresis limits of the Schmitt trigger circuit are reduced. With the hysteresis limits reduced, the Schmitt trigger functions at lower driving-signal voltage levels.

4-25. +10-VOLT DC SUPPLY.

4-26. Series regulator A1Q2 in conjunction with sensor-driver A1Q1 provides a regulated +10 Vdc output from a +25 Vdc source. The series regulator functions as a variable impedance that is changed directly as the load impedance changes in order to maintain a constant voltage output. Any fluctuation in the output voltage is sensed by the emitter of sensor-driver A1Q1. If the output voltage increases, the conduction of sensor-driver A1Q1 decreases. The decrease in conduction of A1Q1 causes a corresponding decrease in the conduction of series regulator A1Q2. With a decrease in conduction, the voltage drop across A1Q2 increases, and the output voltage is held at the regulated level. Any decrease in the output voltage is corrected by a similar action.

4-27. -20-VOLT DC SUPPLY.

4-28. Series regulator A1Q23 in conjunction with A1Q24 provides a regulated -20 Vdc output from a -25 Vdc source. Operation of the circuit is similar to the +10 Vdc supply described in Paragraph 4-25. The circuit operates as a conventional regulated supply. Any fluctuation in the output voltage is sensed by the emitter of sensor-driver A1Q24, causing A1Q24 to increase or decrease conduction accordingly. The level of conduction of A1Q24 controls the conduction of series regulator A1Q23 to compensate for the original fluctuation in the output voltage.

Table 5-1. Test Equipment Required

Recommended Instrument		Required Characteristic	Use
Type	Model		
Sampling Oscilloscope	HP 140A Mainframe HP 1410A Vert Ampl HP 1425A Time Base	Bandwidth: 1 GHz	Performance Checks & Adjustments
High Freq Oscilloscope	HP 140A Mainframe HP 1402A Vert Ampl HP 1421A Time Base	Bandwidth: 20 MHz	Performance Checks & Adjustments
Var Pulse Generator	HP 222A	+2V amplitude, variable pulse width	Performance Checks
DC Volt-Ohm-Ammeter	HP 412A	Resistance Range: 1 to 10k ohms, +5%	Performance Checks
HF Signal Generator	HP 606A	Frequency Range: 0 to 50 MHz	Performance Checks
Test Oscillator	HP 651B	Frequency Range: 10 to 10 MHz	Performance Checks
Mainframe	HP 1900A	Power Source: +25 Vdc and -25 Vdc	Performance Checks & Adjustments
20 dB Atten (2 reqd)	Weinchel Model 50-20	50 ohms, 20 dB attenu- ation	Performance Checks
Extender Plug-in	HP 10484A	Extend Model 1905A from Model 1900A (mainframe)	Performance Checks & Adjustments
10:1 Divider	HP 10214A	Bandwidth: 1 GHz	Performance Checks
BNC Adapter	HP 10218A	Adapt probe to BNC	Performance Checks
50 ohm load	HP 908A	Bandwidth: 4 GHz Power rating: 0.5 watts, Type N Connector	Performance Checks
50 ohm Tee Connector (2 reqd)		BNC Connectors	Performance Checks & Adjustments
Adapter, Type N Female to BNC Male		Non-reactive Connectors	Performance Checks & Adjustments
Adapter, BNC female to GR		Non-reactive Connectors	Performance Checks & Adjustments
Cables, 50 ohm w/BNC male		Non-reactive Connectors	Performance Checks & Adjustments

SECTION V PERFORMANCE CHECK AND ADJUSTMENTS

5-1. INTRODUCTION.

5-2. This section provides performance check and adjustment procedures for the Model 1905A. Test equipment required for maintenance is also identified.

5-3. TEST EQUIPMENT.

5-4. Test equipment recommended for checking, adjusting, and maintaining the Model 1905A is listed in Table 5-1. Similar test equipment may be substituted provided that the required characteristics are maintained. Ensure that the test equipment used is in calibration.

5-5. PERFORMANCE CHECK.

5-6. The performance checks verify that the Model 1905A is operating within the specifications listed in Table 1-1. Perform the checks as a part of incoming inspection, periodic inspection, and after repair or adjustment.

5-7. A Performance Check Record is provided at the end of this section. During the initial incoming performance check, record the actual test indications and results on the form. The Performance Check Record can then be removed from the manual and filed for use as a reference standard for comparison with measurements taken at a later date.

5-8. The performance checks are presented in a planned sequence. Do not attempt to deviate from the sequence as succeeding steps are dependent on the control settings and results of previous steps. If the operation of the instrument does not meet the required specifications, perform the adjustment procedures listed in Paragraph 5-16. Do not use the adjustment procedures as a substitute for trouble isolation. Troubleshooting information is provided in Section VIII of this manual.

5-9. PRELIMINARY SET-UP.

5-10. Set the three interface switches located on the underside of the Model 1905A to the forward position. Install the Model 1905A in the Model 1900A Pulse Generator mainframe. Set the mainframe power switch to on and allow 5 minutes for instrument warmup.

5-11. OUTPUT PULSE CHARACTERISTICS.

a. Connect the equipment and accessories as shown in Figure 5-1.

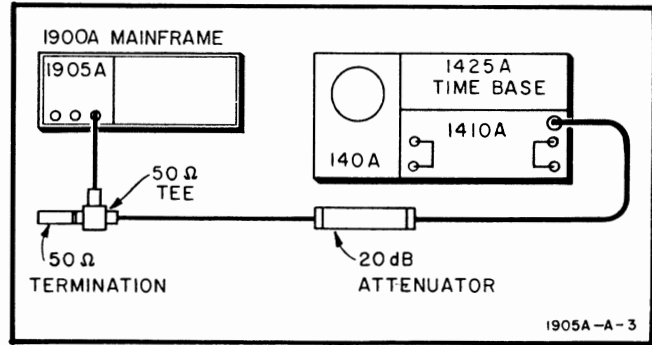

Figure 5-1. Output Pulse Test Setup

b. Set the Model 1905A front-panel controls as follows:

RATE SOURCE INT
 NORMAL/GATED NORMAL
 RATE 2.5-25 MHz
 INC fully cw

c. Set the Model 1410A/1425A controls as follows:

Channel Selector B
 TRIGGER B
 CHANNEL B Sensitivity 20 MV/CM
 SMOOTHING NORM
 TIME/CM 100 nsec
 MAIN SWEEP MAGNIFIER 50
 MAIN SWEEP TRIGGER +, INT, NORM
 SCANNING NORMAL
 SWEEP MAIN

d. Adjust Model 1425A MAGNIFIED POSITION and LEVEL/MODE control for a stable pulse display on the Model 140A CRT.

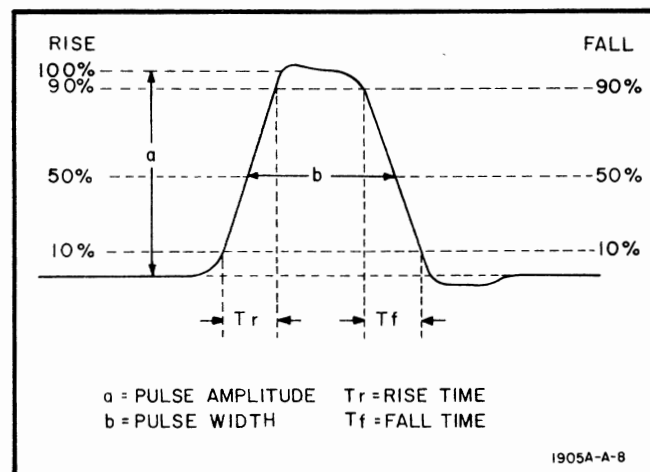

Figure 5-2. Pulse Characteristics

e. The characteristics of the observed pulse should be as follows (refer to Figure 5-2):

- Pulse Amplitude > 7.5 cm (1.5 volts)
- Pulse Width < 5 cm (10 nsec)
- Risetime and Faltime < 2.5 cm (5 nsec)

5-12. OUTPUT PULSE JITTER.

a. Change the following Model 1425A controls to the settings indicated:

- TIME/CM 20 nsec
- MAIN SWEEP MAGNIFIER 100
- MAGNIFIED POSITION fully cw

b. Adjust the Model 1425A LEVEL/MODE control for a stable display of the leading edge of the RATE OUTPUT pulse.

c. Pulse jitter as observed on the Model 140A CRT shall be less than 200 psec (1 cm of horizontal display).

5-13. EXTERNAL GATING.

a. Connect the equipment and accessories as shown in Figure 5-3.

b. On the Model 1905A, set the NORMAL/GATED switch to the GATED position.

c. Set the Model 1410A/1425A controls as follows:

- Channel Selector A & B
- CHANNEL A Sensitivity 50 MV/CM
- CHANNEL B Sensitivity 50 MV/CM
- SMOOTHING (A & B) NORM
- TIME/CM 100 nsec
- MAIN SWEEP MAGNIFIER X1
- MAIN SWEEP TRIGGER -, EXT, NORM

d. Set the Model 222A front-panel controls as follows:

- REP. RATE 100K-1M
- VERNIER fully cw
- PULSE DELAY (μ sec) < .1
- VERNIER fully cw
- PULSE WIDTH (μ sec)05 - .5
- VERNIER fully cw
- PULSE POLARITY -
- PULSE AMPLITUDE 5

e. Adjust the Model 222A PULSE AMPLITUDE VERNIER for a 4 cm (200 mV peak) gate-pulse display on the Model 140A CRT.

f. Observe that the Model 1905A RATE OUTPUT pulse is gated on with a -2 volt pulse from the Model 222A. Vary the Model 222A PULSE WIDTH VERNIER and the Model 1905A INC control to verify the gated performance.

5-14. EXTERNAL TRIGGERING.

a. Connect the equipment and accessories as shown in Figure 5-4.

b. Set the Model 1905A RATE SOURCE switch to EXT- and the NORMAL/GATED switch to NORMAL.

c. Set the following Model 1410A/1425A controls as indicated:

- CHANNEL A sensitivity 100 MV/CM
- SCAN DENSITY cw
- MAIN SWEEP TRIGGER +, INT, NORM
- LEVEL MODE AUTO

d. Set the Model 606A FREQUENCY control for 25 MHz. Then adjust the OUTPUT LEVEL for 0.5 volt peak-to-peak as measured on the Model 140A CRT.

e. Adjust the Model 1905A EXT LEVEL control for a stable RATE OUTPUT pulse display. The RATE OUTPUT pulse characteristic shall be the same as specified in Paragraph 5-11e.

f. Disconnect the Model 606A from the 50-ohm tee and connect the Model 651B.

g. Set the following controls of the Model 1410A/1425A as indicated:

- CHANNEL A Sensitivity 200 MV/CM
- CHANNEL B Sensitivity 100 MV/CM
- TIME/CM 200 nsec

h. Set the Model 651B FREQUENCY and RANGE controls for 1 MHz output. Adjust the output AMPLITUDE control for 6-volts peak-to-peak as indicated on the Model 140A CRT.

i. Observe that the Model 1905A RATE OUTPUT pulses occur at the time corresponding to the negative-

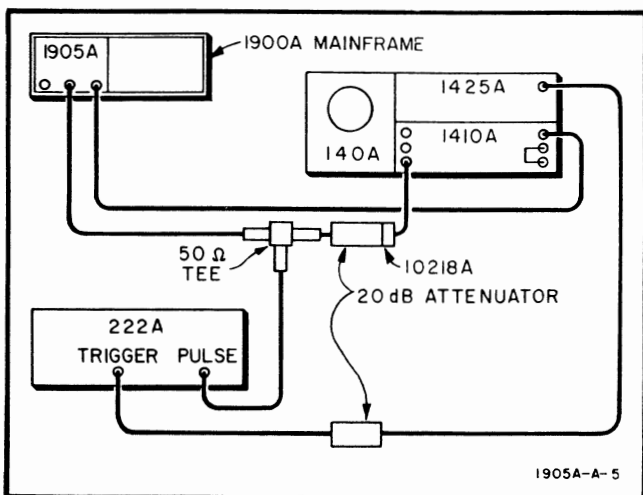

Figure 5-3. External Gating Test Setup

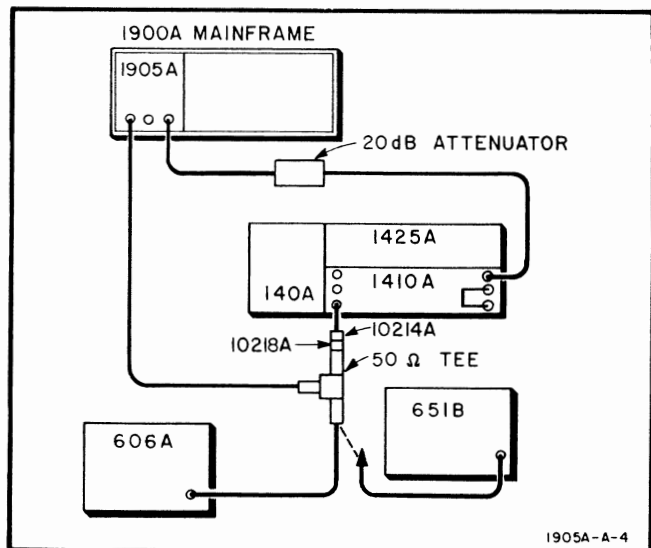

Figure 5-4. External Trigger Test Setup

slope of the external input. Then set the Model 1905A RATE SOURCE switch to EXT+, and observe that the RATE OUTPUT pulses occur at a time corresponding to the positive-slope of the external input.

j. Turn the Model 1905A EXT LEVEL control first cw then ccw, and observe that, with positive-slope triggering, the sine wave display moves to the left and to the right respectively. Set the Model 1905A RATE SOURCE switch to EXT- and again observe that the sine wave shifts left and right when the EXT LEVEL control is adjusted. Check that the 140A display disappears when the EXT LEVEL control is set fully cw or ccw (indicates a trigger level range of ±3 volts).

5-15. INTERNAL REPETITION RATE.

- a. Set up the equipment as shown in Figure 5-1.
- b. Set the Model 1905A RATE SOURCE switch to INT and the RATE and INC controls as indicated in Table 5-2.
- c. Set the Model 1410A/1425A controls as follows:
 Channel Selector B
 TRIGGER B
 CHANNEL B Sensitivity 50 MV/CM
 SMOOTHING NORM
 TIME/CM (Table 5-2)
 SWEEP MAIN
 SCANNING NORMAL
 MAIN SWEEP TRIGGER . . . +, INT, NORM
 MAIN SWEEP MAGNIFIER . . . (Table 5-2)
- d. Make the internal repetition-rate measurements indicated in Table 5-2.
- e. Remove the Model 1410A/1425A plug-ins from the Model 140A mainframe and install the Model 1421A and 1402A plug-ins. Connect the equipment as shown in Figure 5-5.
- f. Set the Model 1402A/1421A controls as follows:
 FUNCTION B
 CHANNEL B Sensitivity5 V/CM
 MAIN SWEEP TRIGGER INT, +
 TIME/CM (Table 5-3)
- g. Set the Model 222A controls to the following positions:
 REP. RATE EXT+
 PULSE DELAY <.1
 VERNIER cw
 PULSE WIDTH (Table 5-3)
 VERNIER cw
 PULSE POLARITY +
- h. Adjust the Model 1421A LEVEL control for a stable display and make the internal repetition-rate measurements indicated in Table 5-3.

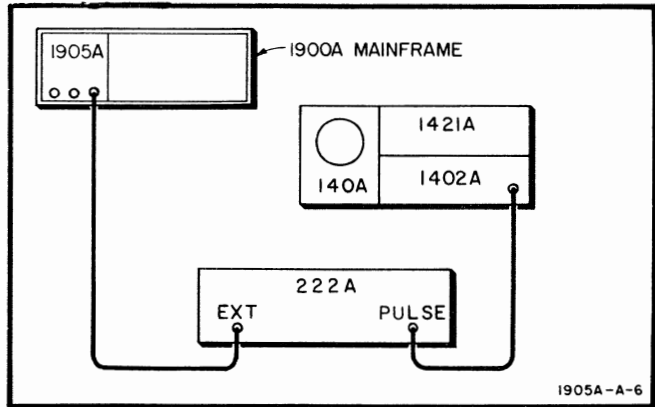

Figure 5-5. Internal Repetition-rate Test Setup

5-16. ADJUSTMENT PROCEDURE.

5-17. The following adjustment procedures are provided to ensure optimum performance of the Model 1905A. Perform these procedures only after it has been determined that the instrument does not meet the performance checks. Before attempting any adjustment, read the entire procedure to become familiar with the steps involved. Refer to Figure 8-3 for the location of the adjustments. If the instrument cannot be adjusted to meet the required performance specification, refer to the troubleshooting information presented in Section VIII of this manual.

5-18. PULSE AMPLITUDE.

- a. Connect the equipment as shown in Figure 5-1. Then extend the Model 1905A from the Model 1900A mainframe using HP extender plug-in 10484A.
- b. Set the controls of the Model 1905A, 1410A, and 1425A as specified in Paragraph 5-11b, c, and d.
- c. Adjust Output Adj capacitor A1C17 for a pulse amplitude of +1.5 volts or greater. (> 7.5 cm, 0.15 volt as observed on the Model 140A CRT).

5-19. INTERNAL REPETITION-RATE CALIBRATION.

- a. Connect the equipment as shown in Figure 5-1. Then extend the Model 1905A from the Model 1900A mainframe using HP extender plug-in 10484A.
- b. Set the Model 1905A controls as follows:
 RATE SOURCE INT
 RATE 2.5M-25M
 INC cw

Table 5-2. Internal Repetition-rate Measurements (Part I)

Model 1905A		Model 1425A		Model 140A Display
RATE Hz	INC	TIME/CM	MAIN SWEEP MAGNIFIER	Test Specification
2.5M-25M	cw	100 nsec	10	Pulse spacing of 37 nsec (3.7 cm)
2.5M-25M	ccw	1 μsec	10	Pulse spacing > 410 nsec (4.1 cm)
250K-2.5M	cw	1 μsec	10	Pulse spacing < 380 nsec (3.8 cm)

Table 5-3. Internal Repetition-rate Measurements (Part II)

Model 1905A		Model 1421A		Model 222A	Model 140A Display
RATE Hz	INC	TIME/CM	MAGNIFIER	PULSE WIDTH	Test Specification
250K-2.5M	ccw	1 μ sec	X1	.5 μ sec	Pulse spacing > 4.1 μ sec (4.1 cm)
25K-250K	cw	1 μ sec	X1	.5 μ sec	Pulse spacing < 3.8 μ sec (3.8 cm)
25K-250K	ccw	10 μ sec	X1	5 μ sec	Pulse spacing > 41 μ sec (4.1 cm)
2.5K-25K	cw	10 μ sec	X1	5 μ sec	Pulse spacing < 38 μ sec (3.8 cm)
2.5K-25K	ccw	100 μ sec	X1	50 μ sec	Pulse spacing > 410 μ sec (4.1 cm)
250-2.5K	cw	100 μ sec	X1	50 μ sec	Pulse spacing < 380 μ sec (3.8 cm)
250-2.5K	ccw	1 msec	X1	500 μ sec	Pulse spacing > 4.1 msec (4.1 cm)
25-250	cw	1 msec	X1	500 μ sec	Pulse spacing < 3.8 msec (3.8 cm)
25-250	ccw	10 msec	X1	5000 μ sec	Pulse spacing > 41 msec (4.1 cm)

c. Set the Model 1410A/1425A controls to the following positions:

- Channel Selector B
- TRIGGER B
- CHANNEL B Sensitivity 100 MV/CM
- SMOOTHING NORM
- SWEEP MAIN
- SCANNING NORMAL
- TIME/CM 100 nsec
- MAIN SWEEP MAGNIFIER 10
- MAIN SWEEP TRIGGER +, INT, NORM

d. Adjust the Model 1425A LEVEL/MODE control for a stable waveform presentation on the Model 140A CRT.

e. Adjust High Rate Adj capacitor A1C24 for a pulse spacing of 37 nsec (3.7 cm) on the Model 140A CRT.

f. After making the internal repetition-rate adjustment, verify that all repetition-rate ranges are operating within the required specifications by accomplishing the performance check procedures given in Paragraph 5-5.

PERFORMANCE CHECK RECORD

Paragraph Reference	Check	Reference Standard	
		Required	Actual
5-11, Step e	Output Pulse Characteristic		
	Pulse Amplitude	> 1.5V	
	Pulse Width	< 10 nsec	
	Risetime and Falltime	< 5 nsec	
5-12, Step c	Output Pulse Jitter	< 200 psec	
5-13, Step f	External Gating	> (-) 2V	
5-14, Steps d, i and j	External Triggering		
	Upper Limit	25 MHz	
	Slope	POS or NEG	
	External Level Range	±3V	
5-15, Steps d and h	Internal Repetition Rate		
	<u>RATE (Hz)</u> <u>INC</u>		
	2.5M-25M cw	37 nsec (3.7 cm)	
	2.5M-25M ccw	> 410 nsec (4.1 cm)	
	250K-2.5M cw	< 380 nsec (3.8 cm)	
	250K-2.5M ccw	> 4.1 μ sec (4.1 cm)	
	25K-250K cw	< 3.8 μ sec (3.8 cm)	
	25K-250K ccw	> 41 μ sec (4.1 cm)	
	2.5K-25K cw	< 38 μ sec (3.8 cm)	
	2.5K-25K ccw	> 410 μ sec (4.1 cm)	
	250-2.5K cw	< 380 μ sec (3.8 cm)	
	250-2.5K ccw	> 4.1 msec (4.1 cm)	
	25-250 cw	< 3.8 msec (3.8 cm)	
	25-250 ccw	> 41 msec (4.1 cm)	

CUT ALONG DOTTED LINE

SECTION VI REPLACEABLE PARTS

6-1. INTRODUCTION.

6-2. This section contains information for ordering replaceable parts for the Model 1905A Rate Generator. Table 6-2 lists the maintenance parts for the Model 1905A. The parts are listed in alphanumeric order by complete reference designation. Table 6-2 also lists the following information for each item:

- a. HP Part Number.
- b. Total quantity (TQ) used in the instrument; indicated only the first time a part number is listed.
- c. Description of the part; refer to Table 6-1 for a list of applicable reference designations and abbreviations.

6-3. Parts not identified by a reference designation are listed in Table 6-2 as miscellaneous items.

6-4. ORDERING INFORMATION.

6-5. Order replacement parts through the nearest Hewlett-Packard Sales/Service Office (refer to the list of addresses at the rear of this manual). Furnish the HP part number of the item(s) required from Table 6-2.

6-6. To order a part not listed in Table 6-2, provide the following information:

- a. Model number of the instrument.
- b. Complete serial number (eight-digits) of the instrument.
- c. Description of the part including function and location.

Table 6-1. Reference Designators And Abbreviations

REFERENCE DESIGNATORS			
A = assembly B = motor C = capacitor CP = coupling CR = diode DL = delay line DS = device signaling (lamp) E = misc. electronic part	F = fuse FL = filter H = hardware IC = integrated circuit J = jack K = relay L = inductor LS = speaker	M = meter MP = mechanical part P = plug Q = transistor R = resistor RT = thermistor S = switch T = transformer	TB = terminal board TP = test point V = vacuum tube, neon bulb, photocell, etc. VR = voltage regulator (diode) W = cable X = socket Y = crystal
ABBREVIATIONS			
amp = amperes ampl = amplifier bp = bandpass car = carbon ccw = counterclockwise cer = ceramic coef = coefficient com = common comp = composition conn = connector CRT = cathode-ray tube cw = clockwise depc = deposited carbon elect = electrolytic encap = encapsulated ext = external F = farads fet = field effect transistor fxd = fixed Ge = germanium	gl = glass grd = ground(ed) H = henries Hg = mercury hr = hour(s) HP = Hewlett-Packard if = intermediate freq. impg = impregnated incd = incandescent incl = include(s) ins = insulation(ed) int = internal k = kilo (10 ³) lin = linear taper log = logarithmic taper lpf = low pass filter m = milli (10 ⁻³) meg = mega (10 ⁶) metfilm = metal film met ox = metal oxide mfr = manufacturer minat = miniature mom = momentary	mtg = mounting my = mylar n = nano (10 ⁻⁹) n'c = normally closed ne = neon n'o = normally open npo = negative positive zero (zero temperature coefficient) nsr = not separately replaceable obd = order by description ox = oxide pc = printed circuit pF = picofarads = 10 ⁻¹² farads piv = peak inverse voltage p'o = part of porc = porcelain pos = position(s) pot = potentiometer pk-pk = peak-to-peak rect = rectifier	rf = radio frequency s-b = slow-blow Se = selenium sect = section(s) semicon = semiconductor Si = silicon sil = silver sl = slide spl = special Ta = tantalum td = time delay tgl = toggle Ti = titanium tol = tolerance trim = trimmer u = micro (10 ⁻⁶) var = variable W = watts w/ = with w/o = without wVdc = dc working volts ww = wirewound

Table 6-2. Replaceable Parts

Ref Desig	HP Part No.	TQ	Description (See Table 6-1.)
CHASSIS PARTS			
A1	01905-66501	1	A: Rate Generator assembly
J1	1250-0083	3	J: BNC, bulkhead connector
J2	1250-0083		J: BNC, bulkhead connector
J3	1250-0083		J: BNC, bulkhead connector
R1	2100-1529	1	R: var, comp, 2000 ohms 20% 200mW
R2	2100-2629	1	R: var, 25k ohms 20% 2W
S1	3100-1393	1	S: rotary, rate
S2	3100-1392	1	S: rotary, drive input
S3	3101-0063	1	S: pushbutton, single pulse
S4	3101-0995	1	S: toggle (dpdt), gate
CHASSIS MISCELLANEOUS			
	01905-67401	1	Knob, rate source
	01905-67402	1	Knob, rate
	01905-67403	1	Knob, ext level
	01905-67404	1	Knob, vernier
	01900-01204	1	Bracket, connector
	01905-00201	1	Insert, front panel
	01900-00504	1	Gusset, right side
	01900-00505	1	Gusset, left side
	01905-20201	1	Frame, front panel
A1			
A1	01905-66501	1	A: Rate Generator assembly
C1	0150-0121	7	C: fxd cer .1 μ F -20 +80% 50 wVdc
C2	0180-0116	3	C: fxd Ta 6.8 μ F 10% 35 wVdc
C3	0150-0121		C: fxd cer .1 μ F -20 +80% 50 wVdc
C4	0180-0155	1	C: fxd Ta 2.2 μ F 20% 20 wVdc
C5	0150-0121		C: fxd cer .1 μ F -20 +80% 50 wVdc
C6	0180-0116		C: fxd Ta 6.8 μ F 10% 35 wVdc
C7	0180-0376	1	C: fxd Ta .47 μ F 10% 35 wVdc
C8	0160-2930	9	C: fxd cer .01 μ F -20% +80% 100 wVdc
C9	0140-0176	1	C: fxd mica 100 pF 2% 300 wVdc
C10	0160-2930		C: fxd cer .01 μ F -20 +80% 100 wVdc
C11	0150-0121		C: fxd cer .1 μ F -20 +80% 50 wVdc
C12	0160-2930		C: fxd cer .01 μ F -20 +80% 100 wVdc
C13	0160-2930		C: fxd cer .01 μ F -20 +80% 100 wVdc
C14	0160-2264	1	C: fxd cer 20 pF 5% 500 wVdc
C15	0160-2930		C: fxd cer .01 μ F -20 +80% 100 wVdc
C16	0160-2930		C: fxd cer .01 μ F -20 +80% 100 wVdc
C17	0121-0046	2	C: var cer 9-35 pF
C18	0150-0121		C: fxd cer .1 μ F -20 +80% 50 wVdc
C19	0140-0203	1	C: fxd mica 30 pF 5% 500 wVdc
C20	0150-0121		C: fxd cer .1 μ F -20 +80% wVdc

Table 6-2. Replaceable Parts (Cont'd)

Ref Desig	HP Part No.	TQ	Description (See Table 6-1.)
C21	0150-0115	1	C: fxd cer 27 pF 10% 500 wVdc
C22	0160-2930		C: fxd cer .01 μ F -20 +80% 100 wVdc
C23	0150-0121		C: fxd cer .1 μ F -20 +80% 50 wVdc
C24	0121-0046		C: var cer 9-35 pF
C25	0160-2930		C: fxd cer .01 μ F -20 +80% 100 wVdc
C26	0180-0291	1	C: fxd metflm 1 μ F 10% 35 wVdc
C27	0180-0116		C: fxd Ta 6.8 μ F 10% 35 wVdc
C28	0180-0373	1	C: fxd Ta .68 μ F 10% 35 wVdc
C29	0160-0166	1	C: fxd my .068 μ F 10% 200 wVdc
C30	0160-0159	1	C: fxd my 6800 pF 10% 200 wVdc
C31	0140-0178	1	C: fxd mica 560 pF 2% 300 wVdc
C32	0160-2930		C: fxd cer .01 μ F -20 +80% 100 wVdc
CR1	1901-0040	7	CR: Si
CR2	1901-0040		CR: Si
CR3	1901-0040		CR: Si
CR4	1901-0040		CR: Si
CR5	1901-0033	2	CR: Si
CR6	1901-0040		CR: Si
CR7	1901-0033		CR: Si
CR8	1901-0040		CR: Si
CR9	1901-0179	4	CR: Si
CR10	1901-0179		CR: Si
CR11	1901-0179		CR: Si
CR12	1901-0179		CR: Si
CR13	1901-0040		CR: Si
L1	9140-0106	1	L: fxd .47 μ H 20%
L2	9140-0024	1	L: fxd .68 μ H 15%
L3	9140-0096	1	L: fxd 1 μ H 10%
L4	9140-0159	1	L: fxd .47 μ H 20%
P1	1251-2090	1	Conn: pc 15 pin
Q1	1854-0215	2	Q: Si npn
Q2	1853-0001	1	Q: Si pnp
Q3	1853-0015	3	Q: Si pnp
Q4	1853-0015		Q: Si pnp
Q5	1854-0092	9	Q: Si npn
Q6	1854-0092		Q: Si npn
Q7	1854-0092		Q: Si npn
Q8	1854-0092		Q: Si npn
Q9	1854-0092		Q: Si npn
Q10	1853-0015		Q: Si pnp
Q11	1854-0092		Q: Si npn
Q12	1853-0036	1	Q: Si pnp
Q13	1854-0092		Q: Si npn
Q14	1854-0215		Q: Si npn
Q15	1854-0019	1	Q: Si npn
Q16	1853-0016	1	Q: Si pnp
Q17	1854-0092		Q: Si npn
Q18	1854-0071	5	Q: Si npn
Q19	1854-0071		Q: Si npn
Q20	1854-0071		Q: Si npn
Q21	1854-0071		Q: Si npn
Q22	1854-0071		Q: Si npn
Q23	1854-0092		Q: Si npn
Q24	1853-0020	1	Q: Si pnp

Table 6-2. Replaceable Parts (Cont'd)

Ref Desig	HP Part No.	TQ	Description (See Table 6-1.)
R1	0757-0433	1	R: fxd metflm 3320 ohms 1% 1/8W
R2	0757-0431	1	R: fxd metflm 2430 ohms 1% 1/8W
R3	0811-0987	1	R: fxd ww 68 ohms 3% 3W
R4	0757-1000	1	R: fxd metflm 51.1 ohms 1% 1/2W
R5	0757-0435	2	R: fxd metflm 3920 ohms 1% 1/8W
R6	0684-1011	7	R: fxd car 100 ohms 10% 1/4W
R7	0757-0739	3	R: fxd metflm 2000 ohms 1% 1/4W
R8	0757-0409	2	R: fxd metflm 274 ohms 1% 1/8W
R9	0757-0338	1	R: fxd metflm 1000 ohms 1% 1/4W
R10	0684-1011		R: fxd car 100 ohms 10% 1/4W
R11	0757-0435		R: fxd metflm 3920 ohms 1% 1/8W
R12	0757-0409		R: fxd metflm 274 ohms 1% 1/8W
R13	0758-0044		R: fxd metflm 2200 ohms 5% 1/2W
R14	0758-0004	1	R: fxd metflm 2700 ohms 5% 1/2W
R15	0757-0417	2	R: fxd metflm 562 ohms 1% 1/8W
R16	0757-0402	3	R: fxd metflm 110 ohms 1% 1/8W
R17	0757-0088	2	R: fxd metox 620 ohms 2% 1/2W
R18	0757-0402		R: fxd metflm 110 ohms 1% 1/8W
R19	0757-0088		R: fxd metox 620 ohms 2% 1/2W
R20	0684-1011		R: fxd car 100 ohms 10% 1/4W
R21	0758-0070	2	R: fxd metflm 1200 ohms 5% 1/2W
R22	0684-1011		R: fxd car 100 ohms 10% 1/4W
R23	0760-0008	1	R: fxd metflm 470 ohms 5% 1W
R24	0757-0402		R: fxd metflm 110 ohms 1% 1/8W
R25	0757-0421	1	R: fxd metflm 825 ohms 1% 1/8W
R26	0757-0282	1	R: fxd metflm 221 ohms 1% 1/8W
R27	0684-1011		R: fxd car 100 ohms 10% 1/4W
R28	0757-0284	1	R: fxd metflm 150 ohms 1% 1/8W
R29	0757-0403	1	R: fxd metflm 121 ohms 1% 1/8W
R30	0758-0007	1	R: fxd metflm 150 ohms 5% 1/2W
R31	0757-0417		R: fxd metflm 562 ohms 1% 1/8W
R32	0683-5125	6	R: fxd car 5100 ohms 5% 1/4W
R33	0683-3025	1	R: fxd car 3000 ohms 5% 1/4W
R34	0757-0406	1	R: fxd metflm 182 ohms 1% 1/8W
R35	0757-0824	1	R: fxd metflm 2000 ohms 1% 1/2W
R36	0757-0706		R: fxd metflm 51.1 ohms 1% 1/4W
R37	0757-0283	2	R: fxd metflm 2000 ohms 1% 1/8W
R38	0757-0434	1	R: fxd metflm 3650 ohms 1% 1/8W
R39	0757-0427	1	R: fxd metflm 1500 ohms 1% 1/8W
R40	0684-1011		R: fxd car 100 ohms 10% 1/4W
R41	0684-1511	1	R: fxd car 150 ohms 10% 1/4W
R42	0758-0067	3	R: fxd metflm 750 ohms 5% 1/2W
R43	0684-1011		R: fxd car 100 ohms 10% 1/4W
R44	0757-0744	1	R: fxd metflm 3920 ohms 1% 1/4W
R45	0757-0283		R: fxd metflm 2000 ohms 1% 1/8W
R46	0757-0420	1	R: fxd metflm 750 ohms 1% 1/8W
R47	0757-0339	1	R: fxd metflm 3010 ohms 1% 1/4W
R48	0683-5105	1	R: fxd car 51 ohms 5% 1/4W
R49	0757-0710	1	R: fxd metflm 75 ohms 1% 1/4W
R50	0758-0067		R: fxd metflm 750 ohms 5% 1/2W
R51	0757-0273	1	R: fxd metflm 3010 ohms 1% 1/8W
R52	0757-0745	1	R: fxd metflm 4320 ohms 1% 1/4W
R53	0758-0067		R: fxd metflm 750 ohms 5% 1/2W
R54	0758-0070		R: fxd metflm 1200 ohms 5% 1/2W
R55	0684-2711	1	R: fxd car 270 ohms 10% 1/4W

Table 6-2. Replaceable Parts (Cont'd)

Ref Desig	HP Part No.	TQ	Description (See Table 6-1.)
R56	0757-0438	1	R: fxd metflm 5110 ohms 1% 1/8W
R57	0757-0428	1	R: fxd metflm 1620 ohms 1% 1/8W
R58	0757-0281	1	R: fxd metflm 2740 ohms 1% 1/8W
R59	0757-0449	1	R: fxd metflm 20k ohm 1% 1/8W
R60	0684-1051	5	R: fxd car 1 megohm 10% 1/4W
R61	0758-0043	5	R: fxd metflm 1800 ohms 5% 1/2W
R62	0684-1051		R: fxd car 1 megohm 10% 1/4W
R63	0758-0043		R: fxd metflm 1800 ohms 5% 1/2W
R64	0684-1051		R: fxd car 1 megohm 10% 1/4W
R65	0758-0043		R: fxd metflm 1800 ohms 5% 1/2W
R66	0684-1051		R: fxd car 1 megohm 10% 1/4W
R67	0758-0043		R: fxd metflm 1800 ohms 5% 1/2W
R68	0684-1051		R: fxd car 1 megohm 10% 1/4W
R69	0758-0043		R: fxd metflm 1800 ohms 5% 1/2W
R70	0683-5125		R: fxd car 5100 ohms 5% 1/4W
R71	0683-5125		R: fxd car 5100 ohms 5% 1/4W
R72	0683-5125		R: fxd car 5100 ohms 5% 1/4W
R73	0683-5125		R: fxd car 5100 ohms 5% 1/4W
R74	0683-5125		R: fxd car 5100 ohms 5% 1/4W
R75	0757-0426	1	R: fxd metflm 1300 ohms 1% 1/8W
R76	0757-0290		R: fxd metflm 6190 ohms 1% 1/8W
R77	0684-3901		R: fxd car 39 ohms 10% 1/4W
R78	0758-0003	1	R: fxd metox 1000 ohms 5% 1/2W
S1	3101-0973	3	S: slide DPDT
S2	3101-0973		S: slide DPDT
S3	3101-0973		S: slide DPDT
VR1	1902-0037	1	VR: Breakdown 9.09V 10% 400 mW
			A1 MISCELLANEOUS
	1200-0185	2	Insulator
	1205-0095	1	Heat Sink
	1205-0037	1	Heat Sink
	01905-26501	1	PC: etched epoxy g1
	5020-0495	30	Pin: pc board

SECTION VII

MANUAL CHANGES AND OPTIONS

7-1. MANUAL CHANGES.

7-2. This manual provides information applicable to standard Model 1905A Rate Generators having a serial prefix as shown on the title page of this manual. Instructions for modifying this manual to cover older or newer instruments are given in the following paragraphs. Refer to the separate MANUAL CHANGES sheet supplied with this manual for Errata.

7-3. OLDER INSTRUMENTS.

7-4. Table 7-1 contains information on changes required to adapt this manual to older instruments (lower serial prefix). Check Table 7-1 for the applicable serial prefix and make the change or changes indicated.

Note

These changes adapt the manual to cover a particular instrument as manufactured and do not apply to an instrument subsequently modified in the field.

Table 7-1. Manual Changes

Serial Prefix	Change Required
No backdating changes are applicable at this time.	

7-5. NEWER INSTRUMENTS.

7-6. As changes are made in the Model 1905A, serial prefixes higher than that shown on the title page may be assigned. The manual supplied with the newer instruments will contain a MANUAL CHANGES sheet which provides all necessary updating information. If the serial prefix of the instrument received is higher than the serial prefix listed on the title page, and no MANUAL CHANGES sheet is provided, contact the nearest Hewlett-Packard Sales/Service Office.

7-7. OPTIONS.







7-8. Options for an HP instrument are standard modifications installed at the factory. There are several options available for the Model 1905A that will adapt it for use in programable 1900-series pulse generator applications. Contact the nearest HP Sales Service Office for additional information concerning the available options.



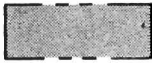
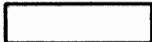
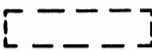
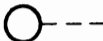

7-9. SPECIAL INSTRUMENTS.

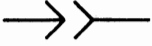
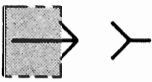
7-10. Modified versions (per customer specifications) of any HP instrument are available on special order. The manual for these special instruments will include a separate insert sheet that describes the modification and any special manual changes in addition to the MANUAL CHANGES sheet (if applicable). Contact the nearest Hewlett-Packard Sales/Service Office if either of these sheets is missing from the manual shipped with the special instrument. Make all reference to the instrument by its full name, model, and serial number.

Table 8-1. Schematic Notes

Refer to MIL-STD-15-1A for schematic symbols not listed in this table.

-  = Etched circuit board
-  = Front panel marking
-  = Rear panel marking
-  = Front panel control
-  = Screwdriver adjustment
- P/O = Part of
- CW = Clockwise end of variable resistor
- N.C. = No connection
-  = Waveform test point (with number)
-  = Common electrical point (with letter) not necessarily ground
-  = Single pin connector
-  = Pin of a plug-in board (with letter or number)
-  = Primary signal flow
-  = Secondary signal flow
- * = Optimum value selected at factory, average value shown; part may have been omitted.

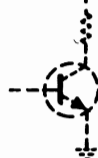
-  = Field effect transistor (N-channel)
-  = Breakdown diode
-  = Tunnel diode
-  = Step recovery diode
-  = Circuits or components drawn with dashed lines (phantom) show function only and are not intended to be complete. The circuit or component is shown in detail on another schematic.

Unless otherwise indicated:
resistance in ohms
capacitance in picofarads
inductance in microhenries

Wire colors are given by numbers in parentheses using the resistor color code [(925) is wht-red-grn].

0 - Black	5 - Green
1 - Brown	6 - Blue
2 - Red	7 - Violet
3 - Orange	8 - Gray
4 - Yellow	9 - White

Switch wafers are identified as follows:

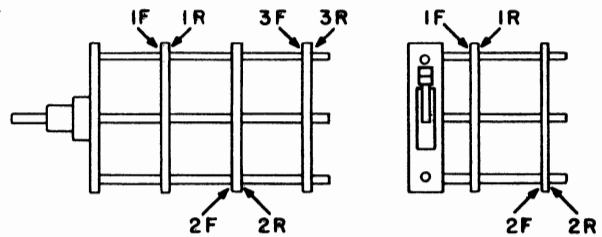

SECTION VIII

SCHEMATICS AND TROUBLESHOOTING

8-1. INTRODUCTION.

8-2. This section contains Model 1905A component identification illustrations, schematics and detailed block diagrams. Information pertaining to troubleshooting and repair of the Model 1905A is also provided.

8-3. SCHEMATIC FEATURES.

8-4. The schematics are on foldout pages to allow the schematics to be viewed while referring to other sections of the manual. The layout of the schematics readily shows circuit functions and main signal paths. Signal inputs are on the left-hand side of the schematic and outputs are on the right-hand side. All components within the shaded areas of the schematic are physically located on etched circuit boards. The schematic also indicates waveform test points (∇ with a number enclosed) and typical dc voltages of active components such as transistors, etc. Table 8-1 lists the general schematic notes and defines the symbols used.

8-5. COMPONENT IDENTIFICATION.

8-6. Identification of chassis-mounted parts and assemblies are shown in Figure 8-2. An assembly component identification illustration (Figure 8-3) is located adjacent to the schematic. As an additional aid in identifying and locating components and test points, a grid location index and a component-to-grid coordinate cross-reference table is provided on the component identification illustration.

8-7. REFERENCE DESIGNATIONS.

8-8. The unit numbering method of assigning reference designations (in accordance with American Standard Association document number ASA Y32.16, dated Aug. 65) is used to identify assemblies and electrical components in the Model 1905A. Each electrical component is identified by a class letter and number. A prefix designation is added when the component is physically located on an assembly. Components not on an assembly will have only the basic class letter and number designation.

Example of unit numbering system:

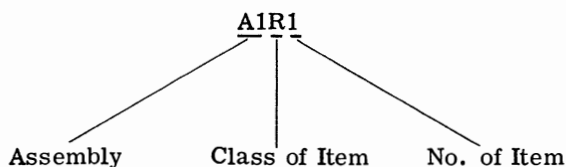

8-9. Partial reference designations are used on the equipment and illustrations. The partial reference designation consists of the class of the item and the identifying number of the item. The complete reference designation is derived by placing the proper assembly prefix before the partial reference designation.

8-10. TROUBLESHOOTING.

8-11. Troubleshooting procedures for the Model 1905A are given in the following paragraphs. The procedures are provided to assist the technician in locating instrument malfunctions.

8-12. PRELIMINARY CHECKOUT.

8-13. An indication of a malfunction may occur due to improper operating procedures, marginal operation of the instrument, or complete failure of a circuit component. To help in isolating the malfunction, perform the following preliminary checkout procedures:

- a. Check for improper operating procedure (refer to Section III).
- b. Accomplish the performance checks presented in Section V and make any adjustments required to eliminate marginal performance.
- c. Visually inspect the instrument for loose wire and cable connections, burned, broken or chafed wires, charred or discolored components, or any other indications of physical damage.
- d. Check the voltage inputs to the Model 1905A at the plug-in connector.

8-14. DETAILED CHECKOUT.

8-15. If the malfunction is not resolved by performing the preliminary checkout procedures, a detailed checkout of the electrical circuits is necessary. Refer to Section IV, Principles of Operation, as in aid in diagnosing circuit malfunctions.

8-16. **TEST EQUIPMENT.** A detailed checkout of the instruments' electrical circuits can be accomplished using the test equipment listed in Table 5-1. No additional test equipment or accessories are required.

8-17. **TEST SETUP.** To troubleshoot the Model 1905A Rate Generator, set up the instrument as follows:

- a. Remove the Model 1905A from the mainframe.
- b. Connect HP extender cable 10485A between the Model 1905A plug-in connector and the applicable mainframe compartment connector.
- c. Set the mainframe power switch to on.

8-18. **TROUBLE ISOLATION.** As an aid in isolating an instrument malfunction to a circuit stage, refer to the troubleshooting tree shown in Figure 8-1. After locating the faulty circuit stage, check the dc voltages of the circuit to determine the defective component. Use the schematic and component identification illustrations as an aid in locating test points and components. Typical waveform illustrations are located adjacent to the schematic and are cross-referenced by symbol to specific test points. Before making any waveform or dc voltage tests, ensure that all Model 1905A operating controls are set as indicated in Table 8-2 or Table 8-3 respectively.

8-19. REPAIR AND REPLACEMENT.

8-20. The following paragraphs cover the basic considerations involved in repairing the Model 1905A. Most of the components in the Model 1905A are physically located on the A1 etched circuit board assembly and are accessible for removal and replacement when the instrument is removed from the Model 1900A. Refer to Section VI for the part numbers of replaceable components and ordering instructions. If satisfactory repair cannot be made, contact the nearest Hewlett-Packard Sales/Service Office (addresses given at rear of manual). If shipment of the instrument to the Hewlett-Packard Sales and Service Office for repair is recommended, refer to Section II for packaging and shipping instructions.

8-21. ETCHED CIRCUIT BOARD SERVICING.

8-22. The etched circuit board used in the Model 1905A has components mounted on one side of the board and conductive strips on both sides. The component mounting holes are plated-through the board. The following procedures should be used when servicing the board:

a. Use a low-temperature soldering iron (37 to 47.5 watts, 800° F) with a slightly bent chisel tip (1/16 to 1/8 inch in diameter).

b. Use a small-diameter, high-tin content solder. If a rosin-core solder is used, clean the area thoroughly after soldering.

c. Remove components by placing the soldering iron on the component lead on either side of the board and pulling straight up on the lead. To prevent heat damage to semi-conductor components, always grip the component lead with pliers to provide a suitable heat sink between the soldering iron and the component.

d. Remove obviously defective components by clipping the leads close to the component; then unsolder the leads from the board.

e. Remove large components, such as potentiometers, switches and connectors, by rotating the soldering iron from lead to lead, while maintaining a steady pressure to lift the part from the board.

f. Avoid overheating the conductor strips. Excessive heat will cause the conductor to separate from the board. A lifted conductor strip can be cemented in place with a quick-drying acetate-base cement having good insulating properties. Another method of repair is to solder a section of high conductive wire along the damaged area.

g. Clear solder from component holes before inserting a new component lead. Heat solder in hole, remove soldering iron, and quickly insert a non-metallic object, such as a toothpick, into the hole. Clean area with acetone to remove dry film.

h. Shape new component leads, and clip to length required. Insert leads into holes. Apply heat and solder (preferable on side opposite component). Use heat sink if necessary.

i. Inspect repair area and remove all foreign material; then recoat with DG Dry Film 88.

8-23. RECALIBRATION.

8-24. After repair and/or replacement of a component, accomplish the performance checks and adjustments presented in Section V to ensure that the instrument is operating within the specifications listed in Table 1-1.

Model 1905A

02622-1

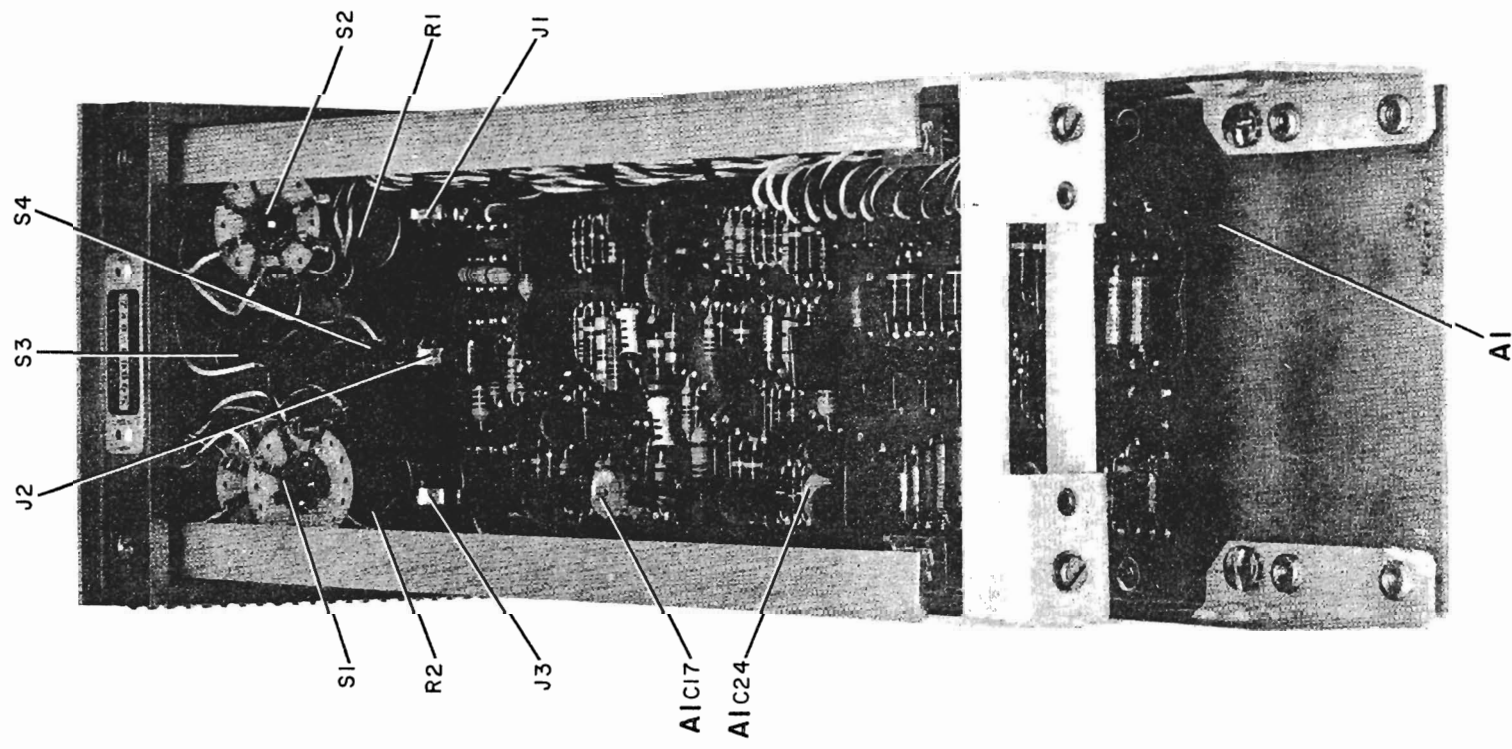
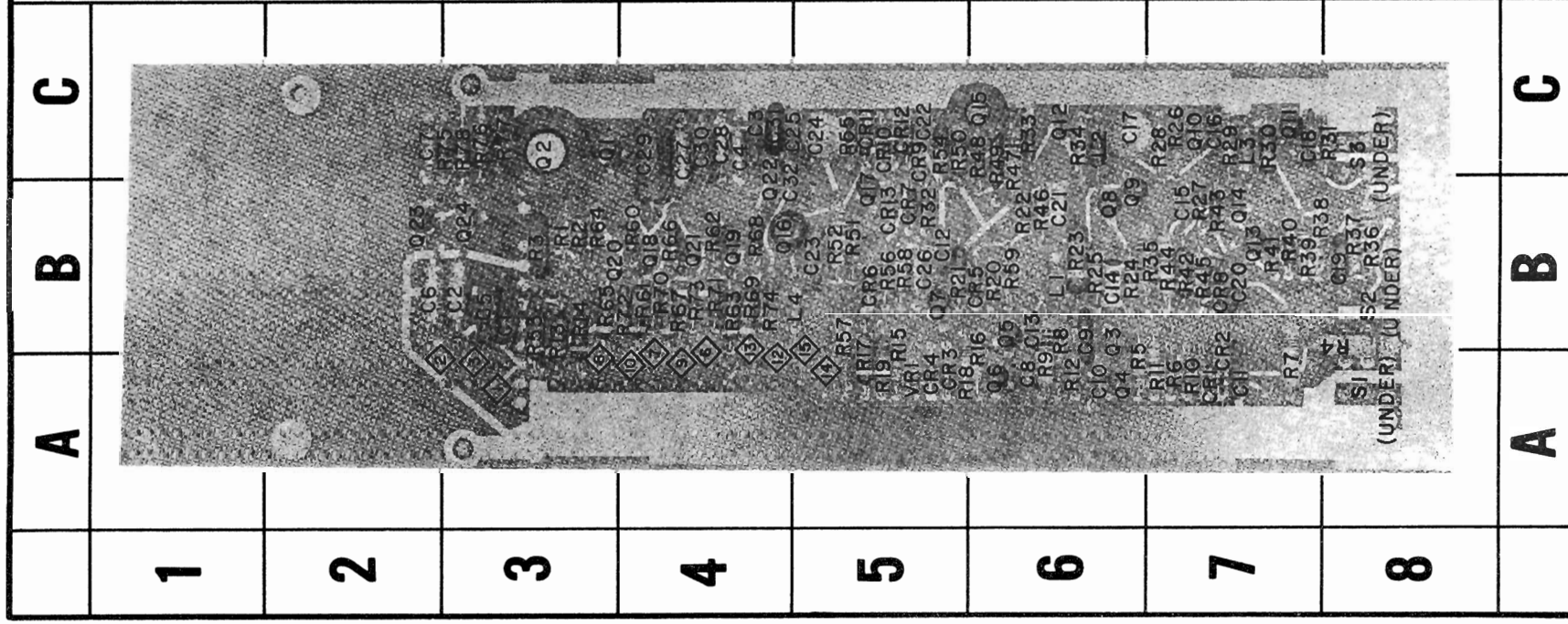

Figure 8-2. Chassis Parts Identification



REF DESIG	GRID LOC	REF DESIG	GRID LOC	REF DESIG	GRID LOC	REF DESIG	GRID LOC
C1	B-3	CR11	C-5	Q84	B-3	R42	B-7
C2	B-3	CR12	C-5	R1	B-3	R43	B-7
C3	C-4	CR13	B-5	R2	B-3	R44	B-7
C4	C-4	L1	B-6	R3	B-3	R45	B-7
C5	B-3	L2	C-6	R4	B-8	R46	B-6
C6	B-2	L3	C-7	R5	B-6	R47	C-6
C7	C-2	L4	B-5	R6	A-7	R48	C-6
C8	A-6	PGM1	A-3	R7	A-7	R49	C-6
C9	B-6	PGM2	A-2	R8	B-6	R50	C-5
C10	A-6	PGM3	B-4	R9	A-6	R51	B-5
C11	A-7	PGM4	A-7	R10	A-7	R52	B-5
C12	B-5	PGM5	B-4	R11	A-7	R53	B-3
C13	B-6	PGM6	B-3	R12	A-6	R54	C-5
C14	B-6	PGM7	A-4	R13	B-3	R55	C-5
C15	B-7	PGM8	A-4	R14	B-3	R56	B-5
C16	C-7	PGM9	A-4	R15	B-3	R57	B-5
C17	C-6	PGM10	A-4	R16	B-6	R58	B-5
C18	C-6	PGM11	B-4	R17	A-5	R59	B-6
C19	B-8	PGM12	A-5	R18	A-6	R60	B-4
C20	B-7	PGM13	B-5	R19	A-5	R61	B-4
C21	B-5	PGM14	C-3	R20	B-6	R62	B-4
C22	C-5	PGM15	B-6	R21	B-5	R63	B-4
C23	B-5	Q1	A-6	R22	B-6	R64	B-3
C24	C-5	Q2	B-6	R23	B-6	R65	B-3
C25	C-4	Q3	A-6	R24	B-6	R66	B-4
C26	B-5	Q4	B-5	R25	B-6	R67	B-4
C27	C-4	Q5	B-6	R26	C-7	R68	B-4
C28	C-4	Q6	B-6	R27	B-7	R69	B-4
C29	C-4	Q7	C-7	R28	C-7	R70	B-4
C30	C-4	Q8	C-7	R29	C-7	R71	B-4
C31	C-4	Q9	C-6	R30	C-7	R72	B-4
C32	C-4	Q10	B-7	R31	C-8	R73	B-4
CR1	A-7	Q11	B-7	R32	B-5	R74	B-4
CR2	B-7	Q12	C-6	R33	C-6	R75	C-3
CR3	A-5	Q13	B-4	R34	B-5	R76	C-3
CR4	A-5	Q14	B-4	R35	B-7	R77	C-3
CR5	B-6	Q15	B-4	R36	B-8	R78	C-3
CR6	B-5	Q16	B-4	R37	B-8	S1	A-8
CR7	B-5	Q17	B-3	R38	B-8	S2	B-8
CR8	B-7	Q18	B-4	R39	B-7	S3	C-8
CR9	C-5	Q19	C-4	R40	B-7	VR1	A-5
CR10	C-5	Q20	B-2	R41	B-7		
		Q21	C-4				
		Q22	C-4				
		Q23	B-2				

Figure 8-3. A1 Assembly Component Identification

Table 8-2. Waveform Test Conditions

INT MODE TEST CONDITIONS	EXT MODE TEST CONDITIONS
<p>1. Set the Model 1905A controls as follows: RATE SOURCE INT RATE 2.5K-25K INC fully ccw NORMAL/GATED NORMAL</p> <p>2. Set Model 140A/1402A/1421A controls as follows: FUNCTION A CHANNEL A Sensitivity5 V/CM SWEEP MAIN MAIN SWEEP TRIGGER INT, AC, + TIME/CM 50 μsec MAGNIFIER X1</p>	<p>1. Apply a 0.5V rms, 2.5 kHz signal to EXT INPUT</p> <p>2. Set Model 1905A controls as follows: RATE SOURCE EXT+ EXT LEVEL centered NORMAL/GATED NORMAL</p> <p>3. Set Model 140A/1402A/1421A controls as follows: FUNCTION A CHANNEL A Sensitivity5 V/CM SWEEP MAIN MAIN SWEEP TRIGGER INT, AC, + TIME/CM 50 μsec MAGNIFIER X1</p>

Table 8-3. DC Voltage Test Conditions

<p>1. Set the Model 1905A controls as follows: RATE SOURCE EXT+ NORMAL/GATED NORMAL INC fully ccw EXT LEVEL fully ccw</p>	<p>2. Voltages may vary slightly from one instrument to another. Normal variations of to 15% are permissible. Unless otherwise indicated, all voltages are dc, taken with a 20,000 ohm-per-volt meter, and measured to ground (chassis) with no signals applied.</p>
---	--

Figure 8-4. Waveforms

1905A-C-3

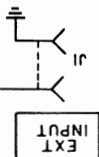
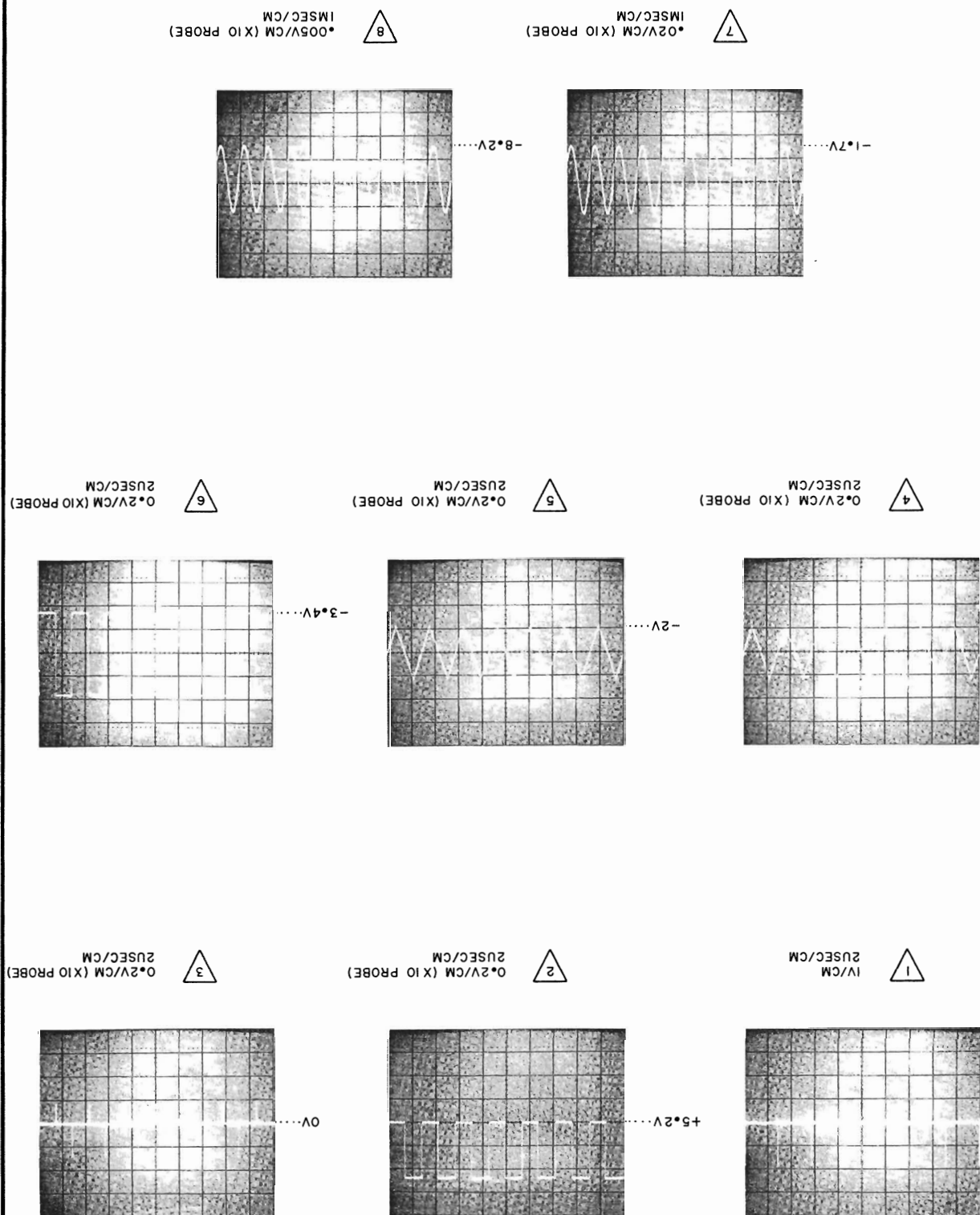

INTERFACE INPUT

Section VIII
Figures 8-4 and 8-5

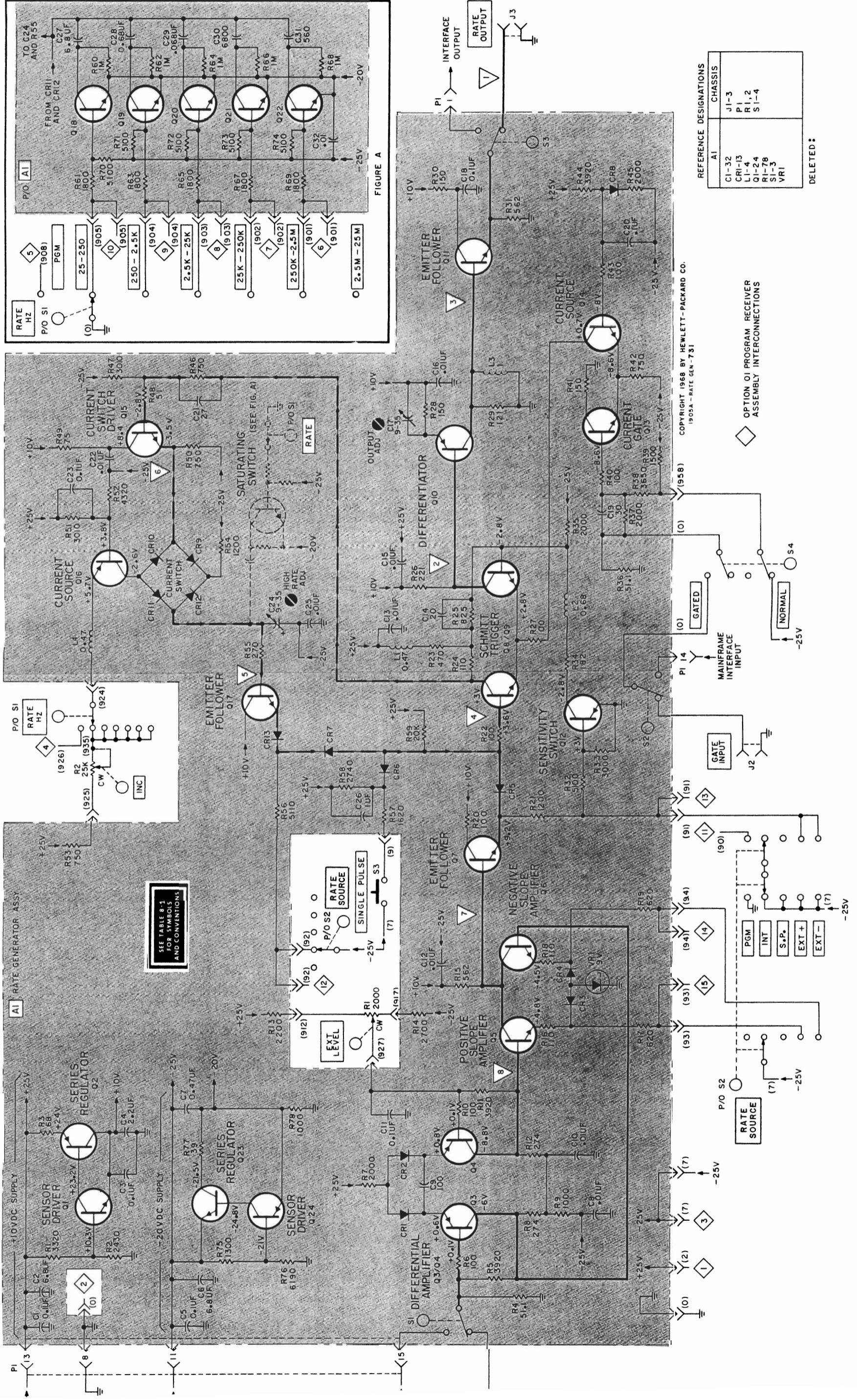
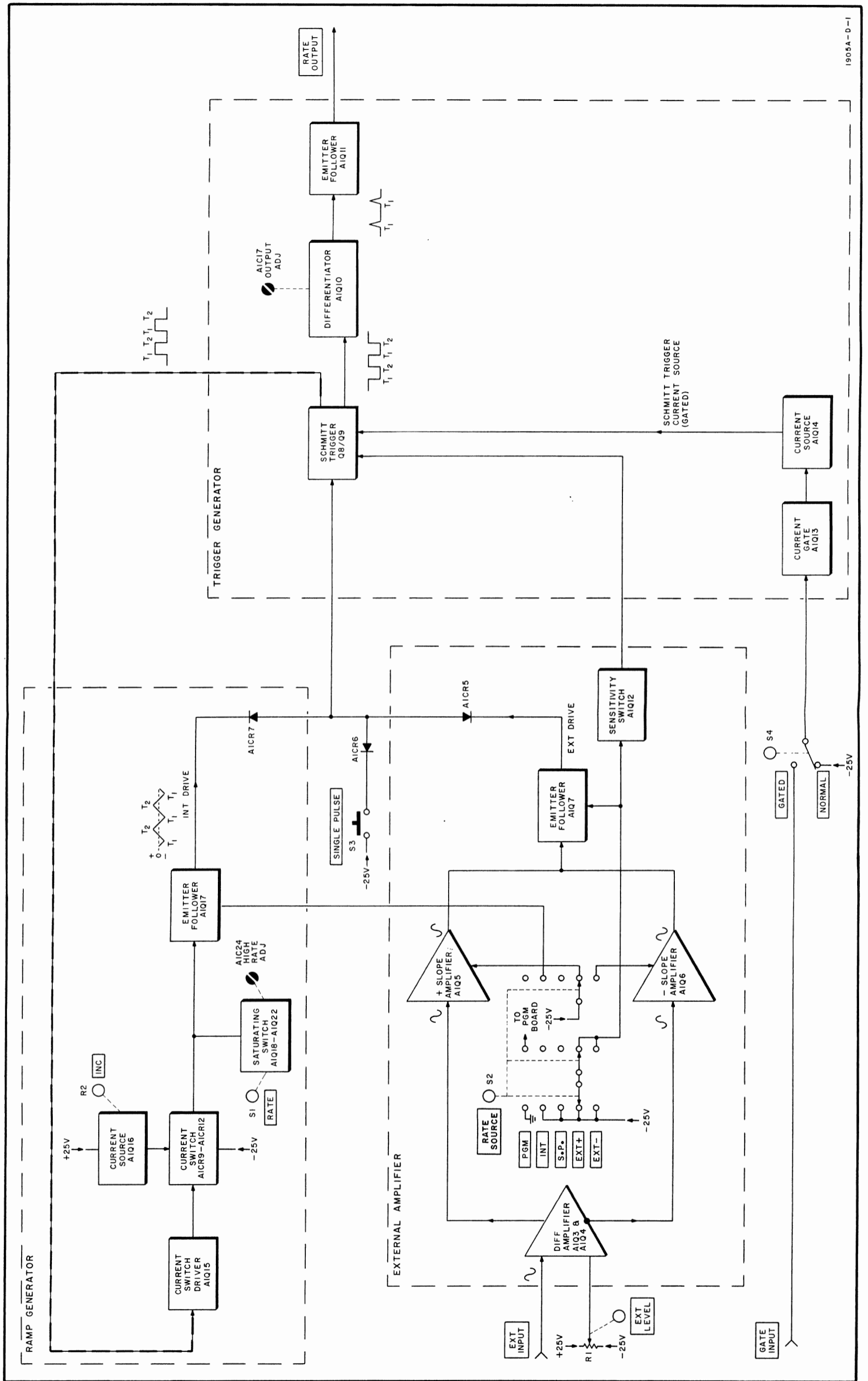

Figure 8-5. Rate Generator Schematic
8-5/8-6



1905A-D-1

Figure 8-6. Over-all Block Diagram 8-7/8-8