

OPERATING AND SERVICE MANUAL

VARIABLE TRANSITION TIME OUTPUT

1915A

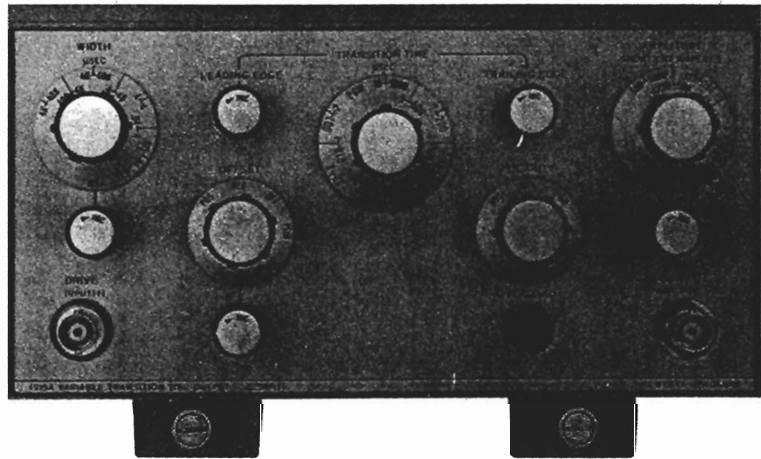

HEWLETT  PACKARD

CERTIFICATION

The Hewlett-Packard Company certifies that this instrument was thoroughly tested and inspected and found to meet its published specifications when it was shipped from the factory. The Hewlett-Packard Company further certifies that its calibration measurements are traceable to the U.S. National Bureau of Standards to the extent allowed by the Bureau's calibration facility.

WARRANTY AND ASSISTANCE

This Hewlett-Packard product is warranted against defects in materials and workmanship. This warranty applies for one year from the date of delivery, or, in the case of certain major components listed in the operating manual, for the specified period. We will repair or replace products which prove to be defective during the warranty period provided they are returned to Hewlett-Packard. No other warranty is expressed or implied. We are not liable for consequential damages.

Service contracts or customer assistance agreements are available for Hewlett-Packard products that require maintenance and repair on-site.

For any assistance, contact your nearest Hewlett-Packard Sales and Service Office. Addresses are provided at the back of this manual.



OPERATING AND SERVICE MANUAL

MODEL 1915A
VARIABLE TRANSITION TIME OUTPUT

SERIALS PREFIXED: 1119A

Refer to Section VII for instruments with the following serial prefix numbers: 835-, 838-, 903-, 906-, 915-, 918-, 925-, 936-, 946-, 960-, 971-, 983-, 0984A-, 1102A.

Refer to Section VII for instruments with the following standard options: 001, 002, 003, 004, 005.

HEWLETT-PACKARD COMPANY/COLORADO SPRINGS DIVISION
1900 GARDEN OF THE GODS ROAD, COLORADO SPRINGS, COLORADO, U.S.A.

Manual Part Number 01915-90906
Microfiche Part Number 0915-90806

PRINTED JULY 1971

Section	Page	Section	Page
I GENERAL INFORMATION	1-1	5-12. Transition Time (maximum)	5-4
1-1. Introduction	1-1	5-13. Width	5-4
1-4. Instrument Description	1-1	5-14. Offset	5-5
1-12. Accessories Available	1-1	5-15. Duty Cycle (internal)	5-5
1-15. Instrument and Manual Identification	1-3	5-16. Drive Sensitivity	5-5
II INSTALLATION	2-1	5-17. Pulse Top Variations	5-6
2-1. Introduction	2-1	5-18. Width Jitter	5-6
2-3. Initial Inspection	2-1	5-19. Adjustment Procedure	5-9
2-6. Claims	2-1	5-21. Initial Preparation	5-9
2-8. Repackaging for Shipment	2-1	5-23. Bias Level A5R15 Adjustment	5-9
2-11. Preparation for Use	2-1	5-24. FET Current A5R23 Adjustment	5-9
III OPERATION	3-1	5-25. Neg Base Tracking Supply A3R57 Adjustment	5-9
3-1. Introduction	3-1	5-26. Negative Amplitude A2R68 Adjustment	5-10
3-3. Controls, Connectors and Indicator	3-1	5-27. Neg Power Detector Level A3R85 Adjustment and Neg Power De- tector Balance A3R88 Adjust- ment	5-10
3-10. Operating Considerations	3-1	5-28. Pos Base Tracking Supply A4R57 Adjustment	5-12
3-11. Trigger Pulse	3-1	5-29. Positive Amplitude A2R69 Adjustment	5-13
3-14. Overload Conditions	3-1	5-30. Pos Power Detector Level A4R85 Adjustment and Pos Power De- tector Balance A4R88 Adjust- ment	5-13
3-16. Output Terminations	3-3	VI REPLACEABLE PARTS	6-1
3-19. 50-ohm Source	3-3	6-1. Introduction	6-1
3-21. High-Z Source	3-3	6-3. Ordering Information	6-1
3-27. Operating Procedure	3-4	VII MANUAL CHANGES AND OPTIONS	7-1
3-29. Low Duty Cycle Operation	3-5/3-6	7-1. Introduction	7-1
3-30. Peak Detector Disabled	3-5/3-6	7-3. Manual Changes	7-1
3-32. Option H15-Single Pulse Operation	3-5/3-6	7-5. Special Options	7-5
IV PRINCIPLES OF OPERATION	4-1	7-9. Standard Options	7-5
4-1. Introduction	4-1	7-11. Option 001, Analog Programming	7-5
4-3. Overall Functional Description	4-1	7-14. Option 002, Positive Output	7-5
4-16. Detailed Theory of Operation	4-2	7-19. Option 003, Negative Output	7-6
4-17. Trigger Select Interface Switch	4-2	7-24. Option 004, Voltage Calibration	7-6
4-19. Input Amplifier	4-2	7-28. Option 005, Digital Programming	7-6
4-21. Width Control	4-2	VIII SCHEMATICS AND TROUBLESHOOTING	8-1
4-28. Transition Time	4-3	8-1. Introduction	8-1
4-43. Positive Output Pulse Circuits	4-4	8-3. Schematics	8-1
4-45. Negative Output Pulse Circuits	4-4	8-8. Reference Designation	8-1
4-64. Polarity Select	4-5	8-12. Circuit Boards	8-1
4-66. Offset	4-5	8-14. Board Connections	8-1
4-75. Variable Power Supplies	4-6	8-16. Board Removal	8-1
4-84. Duty Cycle Detector	4-7	8-19. Board Extender	8-2
4-90. Negative Overload Protection	4-7	8-21. Component Identification	8-2
4-99. Positive Overload Protection	4-9	8-23. Repair and Replacement	8-2
4-101. Amplitude Vernier Circuit	4-9	8-25. Servicing Etched Circuit Boards	8-2
V PERFORMANCE CHECKS AND ADJUSTMENTS	5-1	8-29. Heat Sink Removal	8-2
5-1. Introduction	5-1		
5-3. Required Test Equipment	5-1		
5-5. Mainframe Operation	5-1		
5-7. Performance Check	5-1		
5-9. Amplitude	5-1		
5-10. Overload	5-2		
5-11. Transition Time (minimum)	5-3		

Section		Page	Section		Page
8-34.	Replacing Reed Relay	8-2	8-53.	Troubleshooting Table	8-5
8-36.	Overall Troubleshooting	8-3	8-55.	Detailed Troubleshooting	8-5
8-39.	DC Voltages	8-3	8-56.	Power Supply Check	8-5
8-42.	Waveforms	8-3	8-58.	Output Troubleshooting Procedure	8-6
8-46.	Initial Inspection	8-3			
8-50.	Initial Preparation	8-3			

LIST OF ILLUSTRATIONS

Figure	Title	Page	Figure	Title	Page
1-1.	Model 1915A Variable Transition Time Output	1-0	8-4.	Chassis Mounted Parts Locations (Front View)	8-13
1-2.	Instrument Serial Number	1-3	8-5.	Detailed Block Diagram	8-13
3-1.	Controls, Connectors and Indicator	3-2	8-6.	Input and Width Assembly, A2, Component Identification	8-14
3-2.	Trigger Select Interface Switch Location ..	3-3	8-7.	Input and Width, A2, Waveforms and Measurement Conditions	8-15
3-3.	Internal Termination Cable Storage	3-4	8-8.	Input and Width, A2, Schematic	8-15
3-4.	Basic Operating Setup	3-5/3-6	8-9.	Transition-time Assembly, A5, Component Identification	8-16
4-1.	Width vs. Amplitude—25-ohm Load	4-8	8-10.	Transition-time and Duty Cycle, A5, Wave- forms and Measurement Conditions ..	8-17/8-18
4-2.	Width vs. Amplitude—50-ohm Load	4-9	8-11.	Transition-time and Duty Cycle, A5, Schematic	8-17/8-18
4-3.	Model 1915A Overall Block Diagram	4-11	8-12.	Amplitude Vernier, A2, Measurement Conditions	8-19
5-1.	Amplitude Test Setup	5-1	8-13.	Amplitude Vernier, A2, Schematic	8-19
5-2.	Negative Overload Test Pulse	5-2	8-14.	Negative Output Assembly, A3, Component Identification (Front View)	8-20
5-3.	Positive Overload Test Pulse	5-2	8-15.	Negative Output Assembly, A3, Component Identification (Rear View)	8-20
5-4.	Sampling Oscilloscope Test Setup	5-3	8-16.	Negative Output Circuit, A3, Waveforms and Measurement Conditions	8-21
5-5.	Monitor Oscilloscope Test Setup	5-4	8-17.	Negative Output, A3, Schematic	8-21
5-6.	Sampling Oscilloscope Test Setup	5-4	8-18.	Positive Output Assembly, A4, Component Identification (Front View)	8-22
5-7.	Sampling Oscilloscope Test Setup	5-5	8-19.	Positive Output Assembly, A4, Component Identification (Rear View)	8-22
5-8.	Drive Sensitivity Test Setup	5-5	8-20.	Positive Output Circuit, A4, Waveforms and Measurement Conditions	8-23/8-24
5-9.	Sampling Oscilloscope Test Setup	5-6	8-21.	Positive Output, A4, Schematic	8-23/8-24
5-10.	Adjustment Test Setup	5-9	8-22.	Negative Overload Protection, A2, A3, A5, Waveforms and Measurement Conditions	8-25/8-26
5-11.	Adjustment Test Setup	5-10	8-23.	Negative Overload Protection, A2, A3, A5, Schematic	8-25/8-26
5-12.	Negative Overload Setup Pulse	5-10	8-24.	Positive Overload Protection, A2, A4, A5, Waveforms and Measurement Conditions	8-27
5-13.	Negative Overload Adjustment Pulse	5-11	8-25.	Positive Overload Protection, A2, A4, A5, Schematic	8-27
5-14.	Overload Voltage Locator and Adjustment ..	5-11	8-26.	Offset and Power Supply, A7, Component Identification (Front View)	8-28
5-15.	Negative Overload Test Pulse	5-12	8-27.	Offset and Power Supply, A7, Component Identification (Rear View)	8-28
5-16.	Adjustment Test Setup	5-12	8-28.	Offset and Power Supply, A2 and A7, Measurement Conditions	8-29
5-17.	Adjustment Test Setup	5-13	8-29.	Offset and Power Supply, A2 and A7, Schematic	8-29
5-18.	Positive Overload Setup Pulse	5-13			
5-19.	Positive Overload Adjustment Pulse	5-14			
5-20.	Positive Overload Test Pulse	5-14			
5-21.	Adjustment Locations	5-15/5-16			
7-1.	Input and Width Assembly, A2, Schematic Correction	7-2			
7-2.	Negative Overload Protection Schematic Corrections	7-3			
7-3.	Positive Overload Protection Schematic Corrections	7-4			
7-4.	Input and Width Assembly, A2, Component Identification	7-7			
8-1.	Adjustment Locations	8-10			
8-2.	Assemblies and Chassis Mounted Parts Locations (Top View)	8-11			
8-3.	Assemblies and Chassis Mounted Parts Locations (Bottom View)	8-12			

LIST OF TABLES

Table	Title	Page
1-1.	Specifications	1-2
1-2.	Reference Designators and Abbreviations . . .	1-4
2-1.	Shipping Carton Test Strengths	2-1
5-1.	Recommended Test Equipment	5-0
5-2.	Amplitude Checks	5-1
5-3.	Minimum Range Transition Time Checks . . .	5-2
5-4.	Maximum Range Transition Time Checks . . .	5-3
5-5.	Width Checks	5-4
5-6.	25-ohm Pulse Top Variation Checks	5-6
	Performance Check Record	5-8a
6-1.	Abbreviations for Replaceable Parts List	6-1
6-2.	Replaceable Parts	6-2
6-3.	List of Manufacturers' Codes	6-15/6-16
7-1.	Manual Changes	7-1
7-2.	Option 004 Amplitude Cross Reference	7-6
7-3.	Option 004 Replaceable Parts	7-6
8-1.	Schematic Notes	8-0
8-2.	Overall Troubleshooting Table	8-4
8-3.	Power Supply Checks	8-5
8-4.	Negative Output Supply Checks (Disabled) . .	8-6
8-5.	Negative Output Supply Checks (Enabled) . .	8-7
8-6.	Positive Output Supply Checks (Disabled) . .	8-7
8-7.	Positive Output Supply Checks (Enabled) . . .	8-8
8-8.	1915A Test Point Pins	8-9

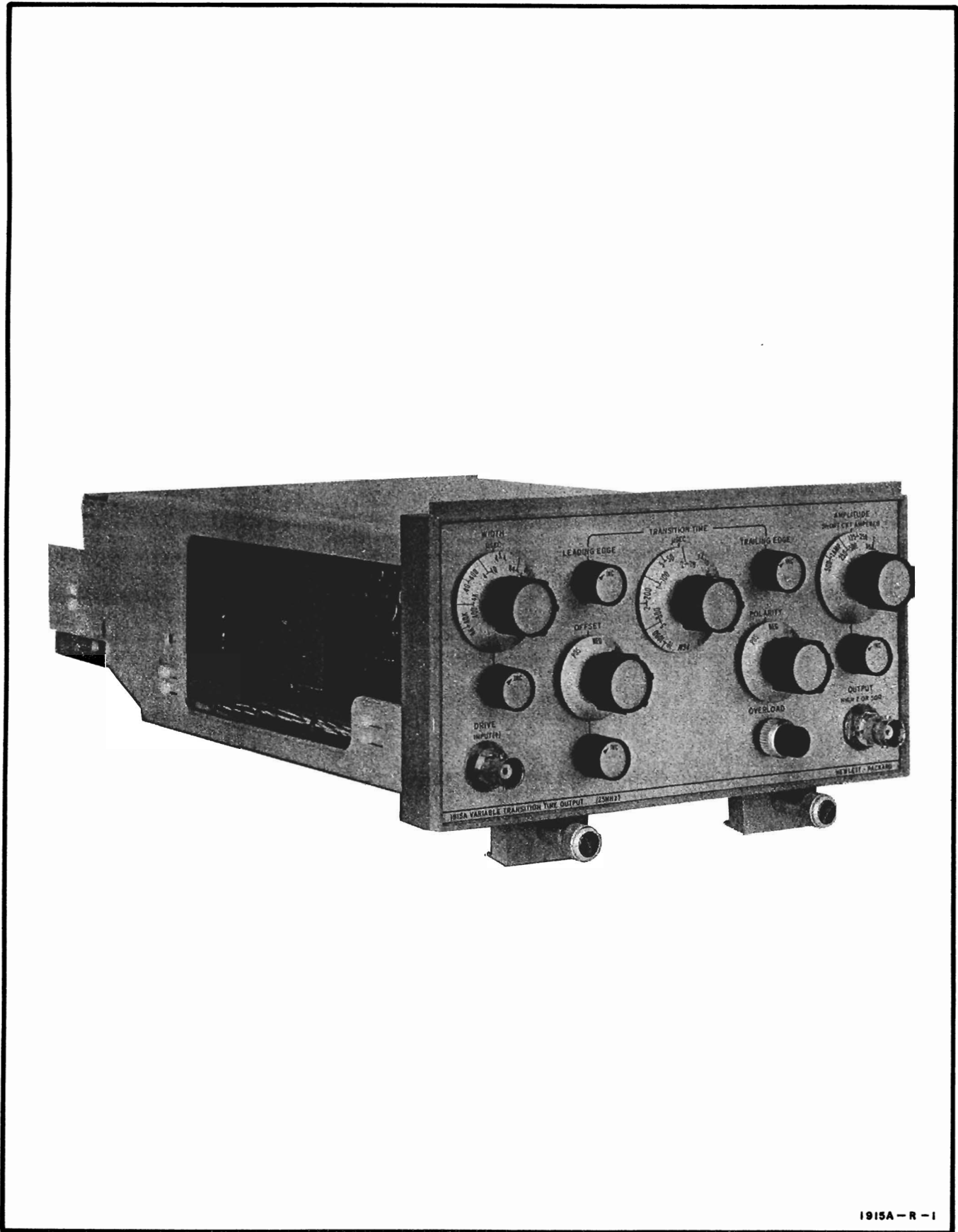

Figure 1-1. Model 1915A Variable Transition Time Output

SECTION I

GENERAL INFORMATION

1-1. INTRODUCTION.

1-2. This manual provides operating and servicing information for the Hewlett-Packard Model 1915A Variable Transition Time Output (Figure 1-1). The manual is divided into eight sections, each covering a specific topic or aspect of the instrument. All schematics are located at the rear of the manual and can be unfolded and used for reference while reading any part of the manual.

1-3. This section contains a description of the Model 1915A. The instrument specifications are listed in Table 1-1. Table 1-2 lists and describes the abbreviations used in this manual except Section VI. The parts list is a computer readout and uses computer-supplied abbreviations. Special accessories and standard options available for this instrument are listed in the specifications table.

1-4. INSTRUMENT DESCRIPTION.

1-5. The Model 1915A is designed for use as a pulse shaper and output amplifier in the 1900A pulse generator mainframe. The Model 1915A accepts an input trigger signal with repetition rates from 0 to 25 MHz and provides an output pulse of selectable width, amplitude, risetime, falltime, polarity, and offset current. The variable pulse characteristics are selected directly by front-panel controls on the instrument.

1-6. Protection circuitry within the Model 1915A monitors output voltage, current, and duty cycle. When any combination of these three parameters exceeds safe operating conditions, the protection circuitry interrupts operation and flashes a warning (OVERLOAD) on the front panel.

1-7. Pulse risetime and falltime is variable from 7 ns to 1 ms. A switch (TRANSITION TIME) on the front panel selects the transition-time range while two independent vernier controls (LEADING EDGE and TRAILING EDGE) determine the exact risetime and falltime of the output pulse. The verniers provide a 100:1 ratio between the leading-edge and trailing-edge transition times.

1-8. The OFFSET switch and vernier provide from 0 to 60 mA offset current to the OUTPUT connector. In the OFF position, the output pulse is referenced to ground.

1-9. The WIDTH switch and vernier provide continuous adjustment of the output pulse width over seven decade ranges (15 ns to 40 ms). When the WIDTH switch is set to EXT, the width of the input pulse determines the width of the output pulse and the instrument functions as a variable transition time pulse amplifier.

1-10. The OUTPUT connector is either a low impedance (50 ohms) or high impedance (4000 ohms) source. The high impedance source is selected by disconnecting the 50-ohm internal terminations. When terminated externally with 50 ohms, the high impedance source provides maximum current (.05 to 1 ampere) and voltage (+2.5 volts to +50 volts) output into the external 50 ohms. The low impedance source provides from .025 to 0.5 ampere and from ± 1.25 volts to ± 25 volts into the external 50-ohm load.

1-11. The AMPLITUDE switch and vernier provide continuous adjustment of the output pulse amplitude. The POLARITY switch selects either positive or negative output pulses.

1-12. ACCESSORIES AVAILABLE.

1-13. Several programing options are available for use in the Model 1915A. The program options allow use of an external control device to establish the output pulse width, amplitude, transition times, polarity, and baseline offset. Contact the nearest HP Sales/Service Office for further information.

1-14. A half-module rigid extender plug-in is available for use with the Model 1915A. The plug-in extender provides support and power connections when operating the Model 1915A outside of the mainframe during calibration and adjustment procedures.

Note

Use an external fan to cool the circuitry of the Model 1915A when an extender plug-in is used.

Table 1-1. Specifications

OUTPUT PULSE

SOURCE IMPEDANCE: 50 ohms or high-Z; self-contained 50-ohm termination may be connected or disconnected.

HIGH-Z OUTPUT: Approx 4 kilohms shunted by < 45 pF.

50-OHM OUTPUT: Approx 50 ohms shunted by < 45 pF.

MAXIMUM DELAY: (after drive input) <45 ns.

AMPLITUDE (Short-circuit Current): 50 mA to 1A in 4 ranges; 2.5:1 vernier allows continuous adjustment over each range. Voltage into external 50 ohms is $\pm 2.5V$ to $\pm 50V$ with high-Z source; $\pm 1.25V$ to $\pm 25V$ with 50-ohm source. Max. amplitude (including offset) is $\pm 50V$.

PULSE SHAPE**PULSE TOP VARIATIONS:**

50-OHM SOURCE AND 50-OHM LOAD: $\pm 5\%$ for transition times 7 ns to 20 ns; $\pm 2\%$ for transition times > 20 ns.

HIGH-Z SOURCE AND 50-OHM LOAD: $\pm 5\%$ for all transition times.

TRANSITION TIMES: 7 ns (10 ns with high-Z source) to 1 ms in 11 ranges (1, 2, 5 sequence); two 100:1 verniers allow independent control of risetime and falltime. Transition time variations over entire amplitude range ($\pm 1.25V$ to ± 25 volts): 40%, 7 to 100 ns; $\pm 15\%$, ≥ 100 ns.

POLARITY: + or -, selectable.

BASELINE OFFSET: ± 60 mA. Max. offset into external 50 ohms is $\pm 1.5V$ with 50-ohm source; $\pm 3V$ with high-Z source.

WIDTH

INTERNAL RANGES: 15 ns to 40 ms in 7 decade ranges (except for first range which is 15 to 40 ns); 10:1 vernier allows continuous adjustment on any range.

INTERNAL WIDTH JITTER: < 0.5% of selected pulse width.

EXTERNAL: Provides pulse amplifier operation; output pulse width determined by width of drive input.

DUTY CYCLE: $\geq 65\%$ on all ranges except $\geq 50\%$ on .015-.04 usec width range; 0 to 100%, in external width mode. For less than 0.2% duty cycle operation, see overload specification.

OVERLOAD

Overload lamp lights to indicate when power detector protection circuits are turning off the output current to limit the output power and prevent output transistor damage. The power detector is energized for single pulse or <0.2% duty cycle operation for pulse widths greater than 1 usec. For single pulse operation or low duty cycle operation with pulse widths greater than 1 usec, Option H15 may be ordered.

DRIVE INPUT

REPETITION RATE: 0 to 25 MHz.

INPUT IMPEDANCE: 50 ohms dc-coupled.

AMPLITUDE: $> +1V$ peak but $< +5V$ peak.

CONNECTION: drive input may be connected internally or externally from other plug-ins, selected by internal switch.

GENERAL

DIMENSIONS: a half-size module for 1900A mainframe. Over-all dimensions; 12 in. long, 7 1/2 in. wide, 4 5/8 in. high (304,8; 190,5; 117,48 mm).

WEIGHT: net, 5 1/2 lb (2,5 kg); shipping, 9 lb (4, 1 kg).

POWER: supplied by 1900A mainframe. Only one 1915A (unless modified) may be operated in a 1900A mainframe.

OPTIONS

OPTION 001-Analog Programming.

Provides connectors and circuitry allowing width range, transition time range, amplitude range, offset and polarity selection by contact closure to ground. Verniers for width, leading edge, trailing edge, offset, and amplitude are controlled by analog current. Option 001 will not operate in a single pulse mode or with duty cycles <0.2% with pulse widths greater than 1 usec.

OPTION 002-Positive Output.

Provides positive-only pulse output and positive only offset.

Table 1-1. Specifications (Cont'd)

<p>OPTION 003-Negative Output.</p> <p>Provides negative-only pulse output and negative only offset.</p> <p>OPTION 004-Voltage Calibration.</p> <p>Calibration of pulse amplitude in voltage. Amplitude range is labeled in volts from 1.25V to 25V. Model 1915A output pulse is from ±1.25V to ±25V from 50-ohm internal source to 50-ohm external load and ±2.5V to ±50V from high-Z internal source to 50-ohm external load.</p> <p>OPTION 005-Digital Programming.</p> <p>Provides cables, connectors, and circuitry to control the width, transition time, amplitude, polarity and offset from a digital source. An HP Model 6936S Multiprogrammer is needed to convert the digital information from the computer to the proper digital range signals and the necessary analog vernier currents to drive the program re-</p>	<p>ceiver circuits in the Model 1915A Option 005. Included are the necessary digital-to-analog converter cards for the Model 6936S Multiprogrammer. Option 005 will not operate in a single pulse mode or with duty cycles <0.2% with pulse widths greater than 1 usec.</p> <p>OPTION H15-Single Pulse Operation.</p> <p>Option H15 prevents the power detector from interrupting a single pulse output, which would limit the output voltage, and allows single pulse operation (refer to overload light specification for details). This modification takes up one programming board slot, which prevents remote operation of amplitude and offset.</p> <p>ACCESSORIES AVAILABLE</p> <p>PROGRAMMING KIT: Field installation of same capability as Option 001.</p>
---	---

1-15. INSTRUMENT AND MANUAL IDENTIFICATION.

1-16. This manual applies directly to Model 1915A instruments with a serial prefix number as listed on the manual title page. The serial prefix number is the first group of digits in the instrument serial number (Figure 1-2). The instrument serial number is on a tag located on the casting above the front panel.

1-17. Check the serial prefix number of the instrument. If the serial prefix number is different from that listed on the title page of this manual, refer to Section VII or the MANUAL CHANGES sheet included (if any), for instructions to adapt this manual for proper instrument coverage. Errors in the manual are listed under ERRATA on the MANUAL CHANGES sheet.

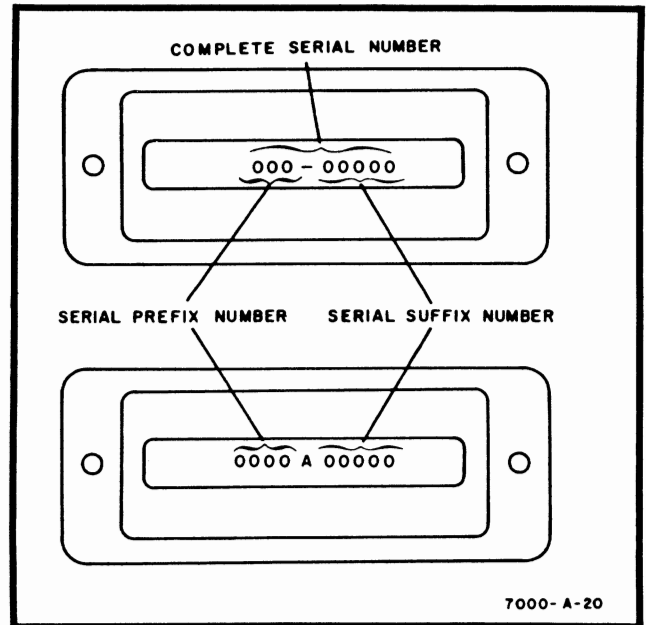

Figure 1-2. Instrument Serial Number

Table 1-2. Reference Designators and Abbreviations

REFERENCE DESIGNATORS

A	= assembly	E	= misc. electrical part	P	= plug	U	= integrated circuit (unrepairable)
AT	= attenuator, resistive termination	F	= fuse	PS	= power supply	V	= vacuum tube, neon bulb, photocell, etc.
B	= motor, fan	FL	= filter	Q	= transistor	VR	= voltage regulator (diode)
BT	= battery	H	= hardware	R	= resistor	W	= cable
C	= capacitor	J	= Jack	RT	= thermistor	X	= socket
CP	= coupling	K	= relay	S	= switch	Y	= crystal
CR	= diode	L	= inductor	T	= transformer	Z	= network
DL	= delay line	LS	= speaker	TB	= terminal board		
DS	= device signaling (lamp)	M	= meter	TP	= test point		
		MP	= mechanical part				

ABBREVIATIONS

A	= ampere(s)	FET	= field-effect transistor(s)	n	= nano (10^{-9})	rfi	= radio frequency interference
ampl	= amplifier(s)			nc	= normally closed	rms	= root mean square
assy	= assembly			no.	= normally open	rwv	= reverse working voltage
ampltd	= amplitude	G	= giga (10^9)	npn	= negative-positive-negative		
bd	= board(s)	gnd	= ground(ed)	ns	= nanosecond	SCR	= silicon controlled rectifier
bp	= bandpass	H	= henry(ies)	p	= pico (10^{-12})	sec	= second(s)
c	= centi (10^{-2})	hr	= hour(s)	pc	= printed (etched) circuit(s)	std	= standard
C	= carbon	HP	= Hewlett-Packard	pk	= peak	trmr	= trimmer
ccw	= counterclockwise	Hz	= hertz	pnp	= positive-negative-positive	u	= micro (10^{-6})
coax.	= coaxial	if.	= intermediate freq.	p/o	= part of	usec	= microsecond
coef	= coefficient	intl	= internal	p-p	= peak-to-peak	V	= volts
com	= common	k	= kilo (10^3)	prgm	= program	var	= variable
CRT	= cathode-ray tube	lb	= pound(s)	prv	= peak inverse voltage(s)	w/	= with
cw	= clockwise	lpf	= low-pass filter(s)	ps	= picosecond	w/o	= without
d	= deci (10^{-1})	m	= milli (10^{-3})	pwv	= peak working voltage	wiv	= working inverse voltage
dB	= decibel	M	= mega (10^6)	rf	= radio frequency		
ext	= external	ms	= millisecond				
F	= farad(s)						

SECTION II INSTALLATION

2-1. INTRODUCTION.

2-2. This section contains instructions for performing an initial inspection of the Model 1915A. Installation procedures and precautions are presented in step-by-step order. The procedures for making a claim for warranty repairs and for repackaging the instrument for shipment are also described in this section.

2-3. INITIAL INSPECTION.

2-4. **MECHANICAL CHECK.** Inspect the instrument upon receipt for any damage which may have occurred in transit. Check for external damage such as broken knobs, bent or broken connectors, and dents or scratches on the panel surface. If damage is found, refer to Paragraph 2-6 for the recommended claim procedure. Retain packing material for possible future use.

2-5. **ELECTRICAL CHECK.** Check the electrical performance of the instrument as soon as possible after receipt (refer to Section V for recommended performance checks). These checks verify that the instrument is operating within the specifications listed in Table 1-1. The performance check is a good test procedure for incoming quality-control inspection. Initial performance and accuracy of the instrument are certified as stated on the inside front cover of this manual. If the instrument does not operate as specified, refer to Paragraph 2-6 for the claim procedure.

2-6. CLAIMS.

2-7. The warranty statement applicable to this Hewlett-Packard instrument is provided on the inside front cover of this manual. If physical damage is found, or if operation is not as specified when the instrument is first received, notify the carrier and the nearest Hewlett-Packard Sales/Service Office immediately (see list in back of manual for addresses). The HP Sales/Service Office will arrange for repair or replacement without waiting for settlement of the claim with the carrier.

2-8. REPACKAGING FOR SHIPMENT.

2-9. If the instrument is to be shipped to a Hewlett-Packard Sales/Service Office for service or repair, attach a tag showing owner (with address), instrument serial number, and a description of the service or repair required.

2-10. Use the original shipping carton and packaging material for shipment. The HP Sales/Service Office will provide information and recommendations on materials to

be used if the original packaging material is not available. Materials used for shipping an instrument should include the following:

a. a double-walled carton. Refer to Table 2-1 for test strength required.

b. heavy paper or sheets of cardboard to protect all instrument surfaces. Use a nonabrasive material such as polyurethane or cushioned paper such as Kimpak around all projecting parts.

c. a minimum of 4 inches of tightly-packed, industry-approved, shock-absorbing material such as extra-firm polyurethane foam.

d. heavy-duty shipping tape for securing outside of carton.

Table 2-1. Shipping Carton Test Strengths

Gross Weight (lbs)	Carton Strength (test lbs)
up to 10	200
10 to 30	275
30 to 120	350
120 to 140	500
140 to 160	600

2-11. PREPARATION FOR USE.

2-12. The Model 1915A is a plug-in chassis designed for installation in a Model 1900A Pulse Generator (mainframe). The mainframe supplies the power requirements, equipment interconnections and circuit cooling for the plug-in, and if a program option is installed, provides the external program input connections. The chassis rests in two slide tracks in the mainframe. Guide pins mounted on a channel inside the mainframe align the plug-in before it contacts the electrical connectors.

Note

The Model 1915A is designed only for use in Model 1900A mainframes, the Model 1901A mainframe does not contain the necessary power supplies to operate the Model 1915A.

2-13. Set trigger select interface switch for desired input trigger coupling. Refer to Paragraph 3-11 for trigger pulse information. Figure 3-2 shows the location of the switch.

Carefully set the instrument on the two tracks of the mainframe compartment and slide the chassis into the mainframe, making certain that it properly contacts the guide pins. Set the plug-in fully into the mainframe to assure proper electrical connections and tighten the two locking screws under the front panel to lock the chassis within the mainframe.

2-14. Both module ports of the mainframe must be closed (with plug-in chassis or a mask) to ensure proper circuit cooling from the mainframe blower. Set the POWER switch on the mainframe to ON to supply operating power to the Model 1915A.



Use only one Model 1915A per Model 1900A mainframe unless mainframe or Model 1915A is modified. For further information contact your nearest Hewlett-Packard Sales/Service Office.

SECTION III OPERATION

3-1. INTRODUCTION.

3-2. This section contains information covering the functions of the controls, connectors, and indicator on the Model 1915A and provides instructions for operating the instrument.



Allow 15 seconds for the power supplies to discharge after power has been turned off before installing or removing the Model 1915A from the Model 1900A mainframe.

3-3. CONTROLS, CONNECTORS AND INDICATOR.

3-4. The controls and connectors on the Model 1915A are identified and briefly described in Figure 3-1. The following paragraphs provide detailed descriptions of the more complex functions of some of the controls.

Note

The PGM position of the POLARITY, OFFSET, WIDTH, TRANSITION TIME, and AMPLITUDE switches is used only when one of the program options is installed.

3-5. WIDTH. The WIDTH switch selects one of seven decade ranges. The width of the output pulse can be varied between .015 usec and 40 ms. The width vernier provides continuous adjustment of the pulse width within the selected range.

3-6. TRANSITION TIME. The TRANSITION TIME switch selects one of eleven transition-time ranges. The transition times (leading edge and trailing edge of the pulse) can be varied between 7 ns and 1 ms. The LEADING EDGE and TRAILING EDGE verniers provide continuous TRANSITION TIME adjustment within the range selected.

3-7. AMPLITUDE. The AMPLITUDE switch selects one of four current ranges. The output stages provide a constant-current pulse so the amplitude ranges are marked in terms of current from the output stages. To determine the voltage of the output pulse, the total output impedance (internal termination plus external load) must be known and multiplied by the selected output current. The amplitude vernier provides continuous adjustment within the amplitude range.

3-8. OFFSET. The OFFSET switch provides negative or positive offset current which is added to the output pulse current. The offset vernier determines the degree (from 0 to 60 mA) of offset current.

3-9. OVERLOAD. The OVERLOAD lamp lights to indicate excessive power dissipation in the output stages and that the overload-protection circuit is interrupting operation. To resume normal operation, the pulse amplitude, width, or duty cycle must be reduced.

3-10. OPERATING CONSIDERATIONS.



Use only one Model 1915A per Model 1900A mainframe unless mainframe or Model 1915A is modified. For further information contact your nearest Hewlett-Packard Sales/Service Office.

3-11. TRIGGER PULSE.



Trigger pulses in excess of 5 volts can damage the instrument.

3-12. The trigger pulse for the Model 1915A can be applied internally through the mainframe wiring or externally through the DRIVE INPUT (+) connector. Trigger select interface switch A10S1 (Figure 3-2) selects between internal (rear position) and external (forward position) triggers. The trigger pulse must be greater than +1 volt but less than +5 volts.

3-13. When the width of the output pulse is determined by the Model 1915A, a spike of proper amplitude may be used to trigger the instrument. If the Model 1915A is used as a pulse amplifier (WIDTH switch set to EXT), the width of the trigger pulse determines the width of the output pulse and the trigger pulse must be selected accordingly.

3-14. OVERLOAD CONDITIONS.

3-15. POWER DETECTOR. There are several common operating conditions which will cause the power detector circuits to interrupt the output pulse. When this happens, the front-panel OVERLOAD lamp lights to signal the operator of the existing condition. The following conditions will cause the Model 1915A to go into overload:

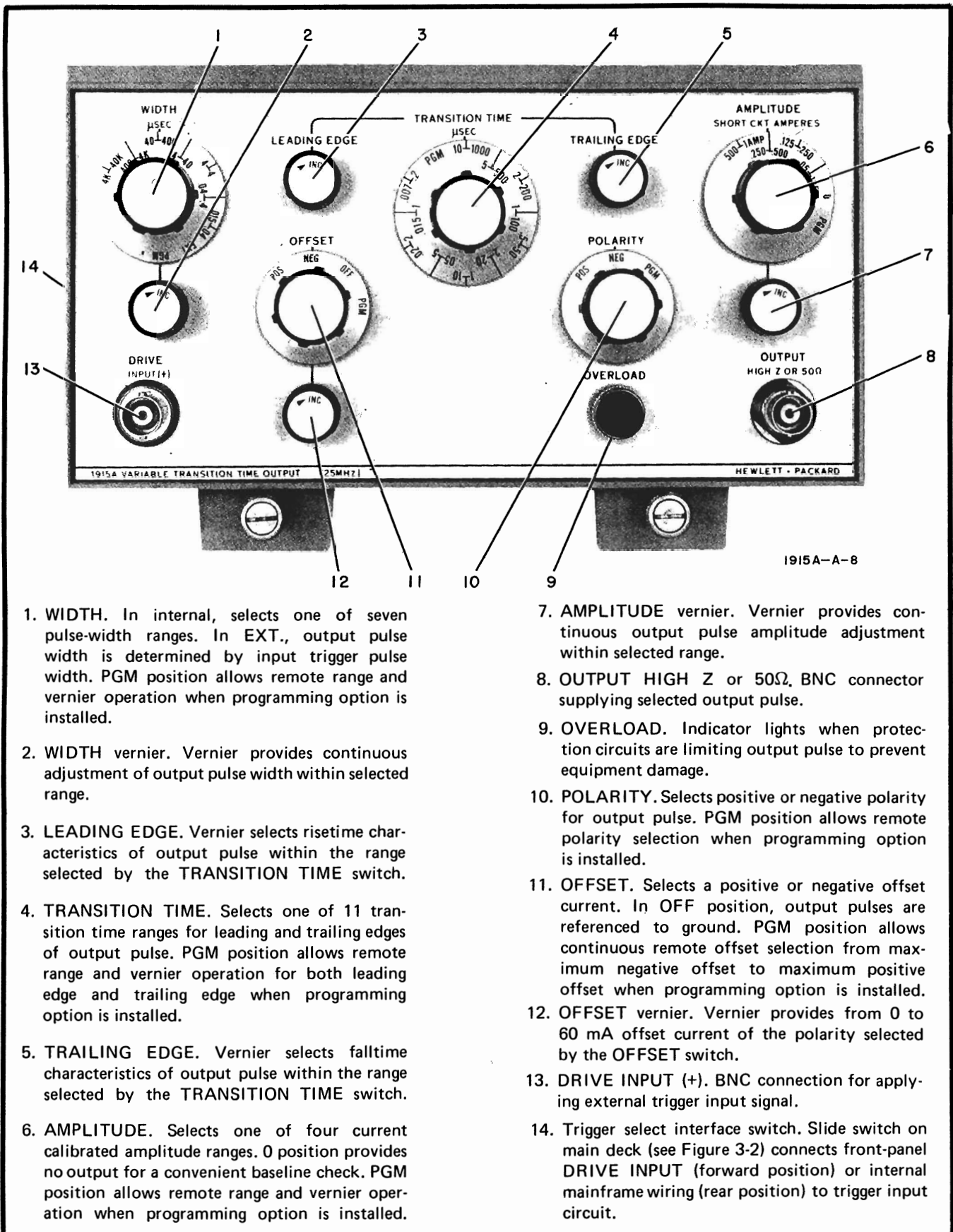

- 1. **WIDTH.** In internal, selects one of seven pulse-width ranges. In EXT., output pulse width is determined by input trigger pulse width. PGM position allows remote range and vernier operation when programming option is installed.
- 2. **WIDTH vernier.** Vernier provides continuous adjustment of output pulse width within selected range.
- 3. **LEADING EDGE.** Vernier selects risetime characteristics of output pulse within the range selected by the TRANSITION TIME switch.
- 4. **TRANSITION TIME.** Selects one of 11 transition time ranges for leading and trailing edges of output pulse. PGM position allows remote range and vernier operation for both leading edge and trailing edge when programming option is installed.
- 5. **TRAILING EDGE.** Vernier selects falltime characteristics of output pulse within the range selected by the TRANSITION TIME switch.
- 6. **AMPLITUDE.** Selects one of four current calibrated amplitude ranges. 0 position provides no output for a convenient baseline check. PGM position allows remote range and vernier operation when programming option is installed.

- 7. **AMPLITUDE vernier.** Vernier provides continuous output pulse amplitude adjustment within selected range.
- 8. **OUTPUT HIGH Z or 50Ω,** BNC connector supplying selected output pulse.
- 9. **OVERLOAD.** Indicator lights when protection circuits are limiting output pulse to prevent equipment damage.
- 10. **POLARITY.** Selects positive or negative polarity for output pulse. PGM position allows remote polarity selection when programming option is installed.
- 11. **OFFSET.** Selects a positive or negative offset current. In OFF position, output pulses are referenced to ground. PGM position allows continuous remote offset selection from maximum negative offset to maximum positive offset when programming option is installed.
- 12. **OFFSET vernier.** Vernier provides from 0 to 60 mA offset current of the polarity selected by the OFFSET switch.
- 13. **DRIVE INPUT (+).** BNC connection for applying external trigger input signal.
- 14. **Trigger select interface switch.** Slide switch on main deck (see Figure 3-2) connects front-panel DRIVE INPUT (forward position) or internal mainframe wiring (rear position) to trigger input circuit.

Figure 3-1. Controls, Connectors and Indicator

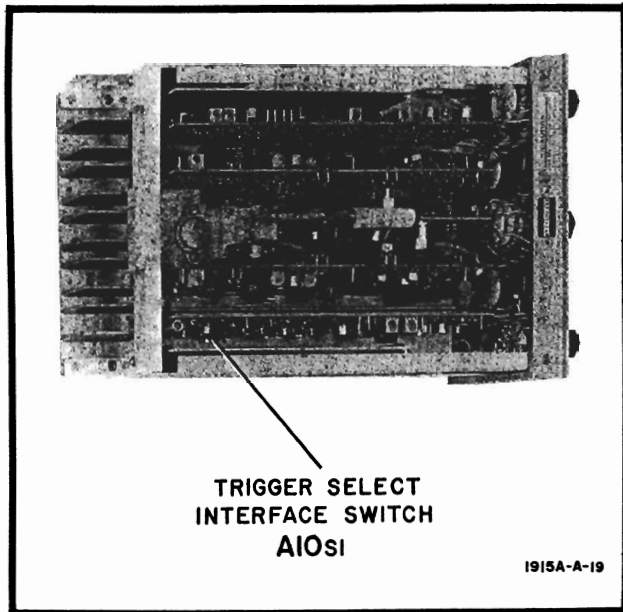

Figure 3-2. Trigger Select Interface Switch Location

- a. High voltage output pulses (38 to 50 volts) with transition times (leading or trailing edge) greater than 1 usec.
- b. Down-range amplitude switching (e.g. switching from .500-1 AMP range to .250-.500 range) with either 50-ohm or 25-ohm total output impedance. (This condition is only momentary while the variable power supplies stabilize).
- c. Duty cycle less than 0.2% (refer to Paragraph 4-88 and Figures 4-1 and 4-2).
- d. Maximum amplitude region (5 to 6.25 volts) of the .125-.250 AMPLITUDE range with pulse width greater than 5 usec (regardless of duty cycle) and a total output impedance of 25 ohms (internal 50-ohm termination with external 50-ohm load). To achieve these same conditions (5 to 6.25 volt amplitude, greater than 10 usec pulse width, 25-ohm output impedance) go to the next higher amplitude range and reduce the AMPLITUDE vernier to the desired amplitude.

3-16. OUTPUT TERMINATIONS.



Any circuit with the capability of reflecting a pulse back into the output amplifier (mismatched transmission line or inductive load) may cause damage to the output transistors. Ensure that the peak amplitude of any reflected pulse does not exceed 100 milliamperes peak. For example, with a 50-ohm cable connected to the Model 1915A output and terminated in a short circuit (or a circuit which approximates a short circuit), the Model 1915A front panel amplitude setting should not exceed 100 mA.

= Keying

3-17. The Model 1915A output circuits can be operated in either of two modes. A 50-ohm output impedance (using internal 50-ohm termination) provides the best pulse shape by absorbing reflections from an external load. The high-Z source (internal 50-ohm terminations disconnected) provides maximum current to the external load.

3-18. The output stages of the Model 1915A function as a current source into the total output impedance. Therefore the current ranges marked on the AMPLITUDE switch indicate the current flowing through the total load. When the internal 50-ohm terminations are connected and the external load is 50 ohms, only half the selected output current flows through the OUTPUT connector. The remainder of the current flows through the internal terminations.

3-19. 50-OHM SOURCE.

3-20. To operate the Model 1915A as a 50-ohm output impedance, the internal 50-ohm terminations (AT1R1A and R1B) must be connected via coaxial cables AT1W1 and AT1W2 to A4J2 and A3J2 (Positive and Negative Output circuit boards) respectively. The Model 1915A is shipped from the factory (and all figures are shown) with the internal 50-ohm terminations connected.

3-21. HIGH-Z SOURCE.

3-22. To operate the Model 1915A as a high impedance output, the internal 50-ohm terminations must be disconnected as described in the following paragraphs. When operating in the high-Z high-current mode, an external termination of greater than 50-ohms may cause the output amplifiers to saturate. The best way to make sure the output amplifiers do not saturate is to keep the product of the output current and the total output impedance equal to or less than 50 volts.

3-23. POSITIVE HIGH-Z SOURCE CONVERSION. The positive output termination (AT1R1A) is connected to the positive circuit board (A4) through coaxial cable AT1W1 (see Figure 3-3) to snap-on jack A4J2 located on the back side of circuit board A4 (see Figure 8-19 for the location of A4J2). To convert the positive output circuit board to a high-Z source, proceed as follows:

- a. Turn off Model 1900A mainframe power.



Allow at least 15 seconds after equipment turn-off for power supplies to discharge before installing or removing the plug-in from the Model 1900A mainframe, or installing or removing any circuit boards from the plug-in.

- b. Remove Model 1915A from Model 1900A mainframe.

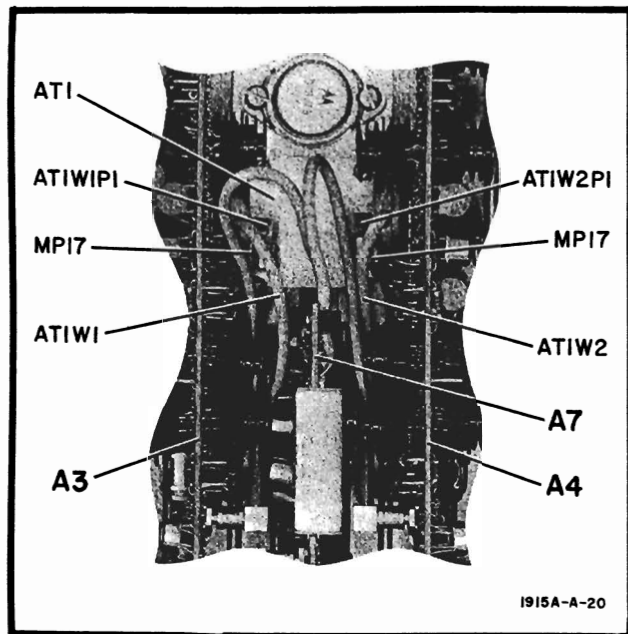

Figure 3-3. Internal Termination Cable Storage

c. Remove connector bracket MP15 from back of plug-in.

d. Remove top cover MP1 by sliding toward rear of plug-in.

e. Carefully remove positive output circuit board A4 (see Figure 8-2 for assemblies and chassis mounted parts locations).

f. Disconnect coaxial cable AT1W1 from A4J2 (see Figure 8-19 for location of A4J2).

g. Store plug AT1W1P1 (on end of coaxial cable AT1W1) by snapping barrel portion of plug into fuse clip MP17 mounted on top of internal termination assembly AT1. (Figure 3-3 shows the plug in the stored position.)

h. Carefully insert positive output circuit board A4 into guides on board supports MP16 and gently push into place.

3-24. Model 1915A is now equipped for high-Z source operation for POS polarity only. If high-Z source operation is desired for NEG polarity also, continue with Paragraph 3-25, step e, otherwise install top cover MP1 and connector bracket MP15. Install the plug-in into the Model 1900A mainframe, turn mainframe power on and allow sufficient time for instrument warm-up before operating.

3-25. **NEGATIVE HIGH-Z SOURCE CONVERSION.** The negative output termination (AT1R1B) is connected similar to the positive output termination (AT1R1A). Negative output termination AT1R1B is connected to the negative output circuit board (A3) through coaxial cable AT1W2 (see Figure 3-3) to snap-on jack A3J2 located on

the back side of circuit board A3 (see Figure 8-15 for the location of A3J2). To convert the negative output circuit board to a high-Z source, proceed as follows:

a. Turn off Model 1900A mainframe power.



Allow at least 15 seconds after equipment turn-off for power supplies to discharge before installing or removing the plug-in from the Model 1900A mainframe, or installing or removing any circuit boards from the plug-in.

b. Remove Model 1915A from Model 1900A mainframe.

c. Remove connector bracket MP15 from back of plug-in.

d. Remove top cover MP1 by sliding toward rear of plug-in.

e. Carefully remove negative output circuit board A3 (see Figure 8-2 for assemblies and chassis mounted parts locations).

f. Disconnect coaxial cable AT1W2 from A3J2 (see Figure 8-15 for location of A3J2).

g. Store plug AT1W2P1 (on end of coaxial cable AT1W2) by snapping barrel portion of plug into fuse clip MP17 mounted on top of internal termination assembly AT1. (Figure 3-3 shows the plug in the stored position.)

h. Carefully insert negative output circuit board A3 into guides on board supports MP16 and gently push into place.

3-26. Model 1915A is now equipped for high-Z source operation for NEG polarity only (POS and NEG polarity if procedure in Paragraph 3-23 is performed). Install top cover MP1 and connector bracket MP15. Install plug-in into Model 1900A mainframe, turn mainframe power on and allow sufficient time for instrument warm-up before operating. To convert from high-Z source to 50-ohm source, reverse the above procedure.

3-27. OPERATING PROCEDURE.

3-28. Due to the many combinations of switch positions and drive input signals, an output pulse may not be obtained. If no output signal is present at the output jack, check the overload indicator. If the overload indicator is lighted, the most common causes are excessive duty cycle and excessive amplitude for a slow transition time. In either case the output can be restored by decreasing the pulse width. The following procedure will produce a typical output pulse from the Model 1915A.

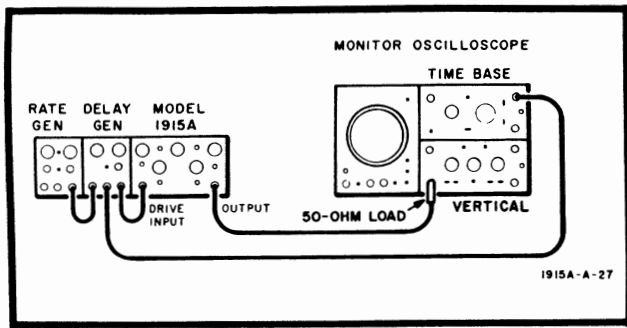

Figure 3-4. Basic Operating Setup

a. Connect internal 50-ohm terminations (if connected for high-Z, reverse procedure given in Paragraphs 3-23 through 3-26).

b. Set trigger select interface switch A10S1 (Figure 3-2) forward for external trigger.

c. With Model 1900A mainframe power off, connect the equipment as shown in Figure 3-4.

d. Set DRIVE INPUT signal (from rate generator or external signal generator) for 500-Hz repetition rate, with greater than +1 volt (but less than +5 volts) amplitude.

e. Set delay generator (if used) to minimum delay.

f. Set Model 1915A controls as follows:

- WIDTH 400-4K
- WIDTH vernier ccw
- TRANSITION TIME 10-1000
- LEADING EDGE vernier ccw
- TRAILING EDGE vernier ccw
- AMPLITUDE125-.250
- AMPLITUDE vernier ccw
- POLARITY POS
- OFFSET POS
- OFFSET vernier mid-range

g. Set monitor oscilloscope functions as follows:

- Sweep Speed 1 ms/div
- Vertical sensitivity 1 volt/div

h. Adjust monitor oscilloscope controls to observe a positive pulse of approximately 3.1 volts in amplitude with the baseline offset from ground by approximately +0.75 volt.

3-29. LOW DUTY CYCLE OPERATION.

3-30. PEAK DETECTOR DISABLED.

3-31. To operate the Model 1915A at wide pulse widths with duty cycles less than 0.2%, the peak detector circuits can be disabled by removing transistors A3Q22 and A4Q22 from their sockets. When operating in this condition there is rounding on the leading edge of the first pulse (either in a train or a single pulse). The rounding is caused by the charging of the peak detector input circuit. In addition to the rounding, pulses greater than 15 volts are limited by the peak detector response in conjunction with the variable power supply.

3-32. OPTION H15—SINGLE PULSE OPERATION.

3-33. Special Option H15 prevents the power detector from limiting the output voltage. This eliminates any interruption of low duty cycle (less than 0.2% as described in OVERLOAD specification) or single pulse operation. This modification eliminates any need to disable the duty cycle detector as described in Paragraph 3-30, thus preserving the pulse shape.

3-34. If your instrument is modified to Option H15 specifications, a special insert sheet included describes the differences in operation and construction from a standard Model 1915A. If your needs require low duty cycle or single pulse operation, contact your nearest Hewlett-Packard Sales/Service Office for information concerning modification to Option H15 specifications.

SECTION IV

PRINCIPLES OF OPERATION

4-1. INTRODUCTION.

4-2. This section contains the theory of operation for the Model 1915A. Due to the complexity of the instrument, circuit theory will be covered both by an overall functional description referenced to a block diagram, and a detailed description of the individual circuits referenced to schematics. Figure 4-3 provides an overall block diagram of the instrument and is located on a fold-out page in this section. The schematics as well as a detailed block diagram are located in Section VIII.

4-3. OVERALL FUNCTIONAL DESCRIPTION.

4-4. See Figure 8-5. The input amplifier accepts the input trigger and provides a drive pulse for the monostable multivibrator in the width circuit. The drive pulse sets the multivibrator and the selected width capacitor starts charging. Charging current for the selected width capacitor is supplied by the width-vernier current source which is biased by the width-vernier control. The charge time of the circuit is dependent on the size of the capacitor selected and the setting of the width vernier. When the width capacitor charges sufficiently, the monostable multivibrator resets. The time that the multivibrator remains set is the width of the output pulse.

4-5. The transition-time control circuit determines the risetime and falltime of the output pulse. The LEADING EDGE and TRAILING EDGE verniers determine the exact risetime and falltime of the output pulse within the limits set by the TRANSITION TIME switch. The amplitude of the pulse from the transition-time circuitry is adjusted by the amplitude vernier. The amplitude vernier controls the transition-time circuitry and the positive and negative output current sources, providing amplitude control of the output pulse within the limits of the AMPLITUDE switch. The pulse of established width, transition times, and amplitude is coupled to the phase splitter. The phase splitter provides two identical pulses of opposite polarity which are applied to the positive and negative output amplifiers.

4-6. The positive and negative output amplifiers, current sources, output disablers, overload detectors, and peak detectors are nearly identical with the exception of reversed polarities of the power supplies and the active components. Only the negative output amplifier, current sources, output disabler, overload detector, and peak detector will be explained.

4-7. The negative output amplifier accepts the pulse from the phase splitter and provides a pulse of selectable

amplitude. The output pulse is coupled to three circuits; the polarity-select circuit, the negative peak detector, and the negative overload detector.

4-8. The polarity-select circuit couples an output pulse from either the negative or the positive output amplifier to the OUTPUT connector in response to the setting of the POLARITY switch. Two dc voltages, also taken from the polarity-select circuit, are coupled to the output disablers. These voltages deactivate the output amplifier not selected by the polarity-select circuit. When switching from one polarity to the other, the output disablers deactivate both output amplifiers.

4-9. The offset circuit adds positive or negative dc current at the OUTPUT connector to shift the dc level of the output pulse. The OFFSET switch and vernier determine the polarity and amplitude of offset current. Positive or negative offset current can be added to either positive or negative output pulses.

4-10. The negative output current sources provide current for the negative output amplifiers. The AMPLITUDE switch activates and deactivates the current sources as the various AMPLITUDE ranges are selected. The amplitude vernier circuit controls the current level of each current source in response to the setting of the amplitude vernier. An automatically controlled variable power supply from the mainframe provides operating voltage for the negative current source. A bias voltage from the negative output disabler is also coupled to the output current sources. The bias voltage turns the current sources off during switching, when the output amplifier is not selected by the polarity-select circuits, and when the output amplifier is overloaded.

4-11. The negative overload detectors receive instantaneous voltage and current samples from the output amplifiers. The samples are multiplied to obtain a current proportional to the instantaneous power dissipation of the output amplifiers. This proportional current is applied to the negative output disabler. That circuit disables the negative output current sources when the instantaneous power dissipation exceeds the preset safe limit.

4-12. When the negative output disabler is energized by inputs from the overload detectors, the OVERLOAD lamp lights. This indicates that excessive power dissipation has occurred in the output stages and the negative output stages are being limited. The negative output disabler also receives inputs from the polarity-select circuits. These inputs disable the output amplifier during switching and disable the negative output when not selected by the POLARITY switch.

4-13. The negative peak detector provides a dc control current proportional to the peak of the pulse. The control current adjusts the level of the negative variable supply in the mainframe. The dc voltage from the variable supply is maintained at a level sufficient to produce the selected output pulse. The negative peak detector also receives a dc override voltage from the duty-cycle detector.

4-14. The duty-cycle detector monitors the pulse at the transition-time circuit and provides a dc override voltage when the pulse duty-cycle is low. The override voltage is applied to the peak detector to keep the variable power supplies at maximum when the output duty-cycle is too low for the peak detector to function efficiently.

4-15. The Model 1900A mainframe provides fixed +25-volt and -25-volt supplies in addition to the positive and negative variable supplies. The Model 1915A provides an 11-volt bias supply, a +12-volt and a -12-volt supply, and a positive and a negative supply which tracks 24 volts below (near ground) the corresponding variable supply from the mainframe.

4-16. DETAILED THEORY OF OPERATION.

4-17. TRIGGER SELECT INTERFACE SWITCH.

4-18. Trigger select interface switch A10S1 (see input and width schematic in Section VIII) selects between drive pulses supplied internally through mainframe wiring or externally through the DRIVE INPUT (+) connector. With the switch in the forward position, the input signal is applied to the input amplifier through the DRIVE INPUT (+) connector. With the trigger select interface switch set to the rear position, the input trigger pulse is applied to the input amplifier from the Model 1900A mainframe wiring.

4-19. INPUT AMPLIFIER.

4-20. The input amplifier provides a drive signal for the width-control circuits (see input and width schematic in Section VIII). The input amplifier consists of dual-differential amplifier A2Q1 through Q4 and emitter follower Q5. The positive input trigger signal (greater than 1 volt but less than 5 volts) is applied to the base of transistor Q1. During the quiescent state, Q1 and Q2 are off while Q3 and Q4 are on. The positive trigger pulse turns on Q1 and Q2, turning off Q3 and Q4. At the end of the trigger pulse, the input amplifier returns to the quiescent state. Dual-diode CR1 protects transistors Q1 and Q4 against negative inputs to the input amplifier. The pulse from the input amplifier is coupled through emitter follower Q5 to the monostable multivibrator Q6 and Q7.

4-21. WIDTH CONTROL.

4-22. The width control circuit (see input and width schematic in Section VIII) determines the duration of the output pulse in response to the setting of the WIDTH

switch and vernier. With the WIDTH switch set to EXT, the width of the output pulse is determined by the width of the input trigger pulse. The width circuit consists of width monostable multivibrator A2Q6 and Q7, range-select circuit Q15 through Q20, int-ext width logic circuit Q13 and Q14, int-ext switch circuit Q8 and Q9, internal and external ground switches Q10 and Q11, and width vernier current source Q12.

4-23. The positive trigger from emitter follower Q5 in the input amplifier turns on width-monostable transistor Q6, causing the multivibrator to set. The feedback path for the width monostable is from the collector of Q7 through CR2, VR2, and R89 to the base of Q6. The positive trigger and set bias conditions of the width monostable turn off internal grounding switch Q10, removing the ground path from range capacitors C5 through C12. With the ground path removed, C5 and the selected range capacitor begin to charge through width-vernier current source Q12 forming a ramp wave-form at the base of Q7. The slope of the ramp is determined by charging current from the width-vernier current source which is controlled by the width vernier control and the size of the range capacitor selected by the WIDTH switch. When the ramp waveform reaches approximately +2.5 volts, width-monostable transistor Q7 turns on, resetting the multivibrator. When the monostable multivibrator is in the reset state, internal ground switch Q10 is biased on, making a ground path for the range capacitors. The time required to discharge the range capacitors after the monostable resets is the recovery time of the instrument.

4-24. With the WIDTH switch set to any of the internal ranges, int-ext width logic transistor A5Q14 is biased off biasing Q13 on. This biases int-ext switch transistors Q8 on and Q9 off, and external grounding switch Q11 off. Transistor Q8 supplies operating voltage (+11 volts) to monostable multivibrator transistor Q7 and voltage divider R14, VR2, R829, and R9. In the quiescent (reset) state, the voltage divider holds Q6 off and Q7 on, and turns on internal-grounding switch Q10, shorting the range capacitors to ground.

4-25. The EXT position of the WIDTH switch grounds R32, turning int-ext transistor Q14 on and Q13 off. This biases int-ext switch transistors Q9 on and Q8 off. Transistor Q8 no longer supplies operating voltage for monostable multivibrator transistor Q7 and voltage divider R14, VR2, R89, and R9. Diode CR2 is reverse biased, removing the feedback path for the monostable multivibrator. Transistor Q5 supplies voltage to the base of Q6, keeping the transistor off. Under these conditions, the width monostable vibrator functions as a differential amplifier, and the width of the input trigger pulse determines the width of the output pulse.

4-26. Saturation switch transistors Q15 through Q20 select the proper range capacity in response to the setting of the WIDTH switch. Width vernier current source Q12 supplies current to charge the range capacitors. The narrowest width range uses only the inherent capacity of the circuit and C5.

4-27. The pulse of established width is taken from the collector of width-monostable multivibrator A2Q6 and coupled to synchronous-switch transistors A5Q1 and A5Q2 in the transition-time circuit (see transition-time schematic in Section VIII).

4-28. TRANSITION TIME.

4-29. The transition-time circuit determines the risetime and falltime of the pulse (see transition-time schematic in Section VIII). Inputs from the amplitude vernier circuit keep the risetime and falltime constant within specifications over the range of the amplitude vernier. Another input from the amplitude vernier circuit sets the dc level of the baseline of the pulse, providing amplitude control of the output pulse. The transition-time circuit consists of synchronous-switch transistors A5Q1 through Q4, trailing-edge current source Q5, leading-edge current source Q6, pulse-peak clamp CR3, pulse-baseline clamp Q7 and CR2, range-select saturation switches Q11 through Q19, and holding transistors Q20 through Q27 (connected as diodes).

4-30. The leading-edge and trailing-edge transition times are determined by a controlled capacitance-current-source circuit. The synchronous switch connects a controlled discharging current source A5Q6 to the selected capacitance to determine the leading-edge transition time of the output pulse. When width monostable A2Q6 and A2Q7 resets, a controlled charging current source A5Q5 determines the trailing edge transition time of the output pulse. The TRANSITION TIME switch selects the capacitance; the LEADING EDGE and TRAILING EDGE verniers control the current in the charging and discharging current sources. The base voltage (and thus the current) of the current source is controlled by the amplitude vernier circuit to maintain a constant risetime and falltime over the range of the AMPLITUDE vernier control. Another dc level from the amplitude vernier circuit sets the base voltage of pulse baseline clamp Q7. Transistor Q7 controls the dc level of the pulse baseline to provide amplitude control of the pulse.

4-31. During the quiescent state (reset), synchronous-switch transistors Q1 and Q4 are off and Q2 and Q3 are on. Current flows through trailing-edge current source Q5, RL network L1 and R5, and synchronous-switch transistor Q3, charging the selected transition-time range capacitors, C14 through C23, positively toward the baseline clamp voltage. Current through leading-edge current source Q6 flows from ground through synchronous-switch transistor Q2 and RL network L2 and R7.

4-32. The leading edge of the negative-going pulse from the pulse-width circuit sets the synchronous switch, turning on transistors Q1 and Q4, and turning off Q2 and Q3. Current flowing through leading-edge current source Q6 now flows from the range capacitors, through synchronous switch transistor Q4 and RL network L2 and R7, discharging the range capacitors negatively toward the peak clamp voltage. Current flowing through trailing-edge current source Q5 now flows through RL network

L1 and R5, synchronous-switch transistor Q1, and R4 to ground. The time required to discharge the selected range capacitors from the level of the pulse baseline clamp to the level of the pulse peak clamp is the leading-edge transition time.

4-33. The trailing edge of the negative-going pulse from the pulse width circuit resets the synchronous switch, turning on Q2 and Q3 and turning off Q1 and Q4. Current flowing through trailing-edge current source Q5 now flows through RL network L1 and R5 and synchronous-switch transistor Q3 charging the range capacitors toward the pulse baseline clamp voltage. Current through leading-edge current source Q6 now flows from ground, through synchronous switch transistor Q2 and RL network L2 and R7. The time required to charge the range capacitors from the level of the pulse-peak clamp to the level of the pulse baseline clamp is the trailing-edge transition time.

4-34. The dc level to which current sources Q5 and Q6 charge and discharge the selected range capacitors is determined by the pulse-peak clamp and the pulse-baseline clamp. Pulse-peak clamp CR3 is connected to ground clamping the peak level of all pulses at -0.7 volt. Pulse baseline clamp CR2 is connected to pulse baseline clamp transistor Q7. Transistor Q7, in response to the amplitude vernier circuit, adjusts the dc level of the baseline of the pulse, providing amplitude control of the pulse.

4-35. TRANSITION TIME RANGE SELECT. The transition-time ranges are changed by adding capacitance to and subtracting capacitance from the capacitance-current-source circuit. Capacitance is added in parallel for each successively slower transition-time range to increase the total capacity of the circuit. As the capacity increases, the time required by the leading-edge and trailing-edge current sources to charge the capacity to the level of the peak and baseline clamps increases.

4-36. When the fastest transition time range (.007-.2) is selected, the TRANSITION TIME switch energizes relay K1 which disconnects the capacity of the range-select circuitry from the capacitance-current-source circuit.

4-37. When the second fastest range (.01-.1) is selected, the TRANSITION TIME switch deenergizes relay K1. Capacitor C23 and the inherent capacity of the range-select circuits are added to the capacitance-current-source circuit.

4-38. Selecting the .02-.2 transition-time range grounds resistor R55. This turns-on range-select saturation switch Q19, adding the capacity of C22 to the capacitance-current-source circuit.

4-39. Selecting the 0.5-.5 transition-time range grounds resistor R54. This turns on range-select saturation transistors Q18 and Q19, adding the capacities of C21 and C22 to the capacitance-current-source circuit. Transistor Q19

is turned on by base current through holding transistor Q27 and resistor R55.

4-40. Each of the successive slower transition-time ranges is selected in the same manner. Diodes CR5 through CR13 provide a path for leading edge discharge current.

4-41. The selected pulse is applied to the high impedance gate of buffer transistor Q8 (a field-effect transistor). The voltage level is shifted by VR3 and VR4 and directly coupled through R19 to the base of phase splitter Q10. The bias applied to the base of Q10 is controlled by FET CURRENT adjust potentiometer R23. This base voltage controls the emitter and collector voltages of Q10.

4-42. PHASE SPLITTER. Pulses of established width, transition times, and amplitude, are provided from both the emitter and collector of phase splitter Q10. The positive pulse from the collector of Q10 is coupled to the negative output amplifier and the negative pulse from the emitter of Q10 is coupled to the positive output amplifier. The pulses are identical except for opposite polarities. Inductors L5 and L6 and capacitors C9 and C10 provide de-coupling for the phase splitter.

4-43. POSITIVE OUTPUT PULSE CIRCUITS.

4-44. The circuits for the positive and negative output pulses are nearly identical except the active components and power supplies are of opposite polarity. Only the negative output pulse circuits will be explained.

4-45. NEGATIVE OUTPUT PULSE CIRCUITS.

4-46. The negative output pulse circuits consist of five types of circuits which condition and amplify the pulse of established width and transition times in response to the amplitude controls. A negative cascode reference shifter converts the pulse of established width and transition times from a ground referenced pulse to a variable supply referenced pulse. The complimentary emitter followers provide the current gain necessary to drive the negative output differential amplifiers. Five negative output current sources provide from .05 to 1 ampere emitter current to the negative output differential amplifiers. A negative base-tracking supply provides a base-supply voltage for the output transistors which tracks the variable supply. Four negative output differential amplifiers provide output current corresponding to the four AMPLITUDE ranges.

4-47. NEGATIVE CASCODE REFERENCE SHIFTER.

The negative cascode reference shifter accepts the ground referenced pulse from the phase splitter and provides a pulse which is referenced to the negative variable supply. The negative cascode reference shifter consists of cascode amplifier A3Q1 and Q2 (see negative output schematic in Section VIII). The pulse from the phase splitter is coupled to the ground referenced base of transistor Q1. The collector signal from Q1 is applied to common base amplifier Q2 which is referenced to the

negative variable supply, as is the remaining negative output circuitry. The pulse from collector of Q2 is coupled through R7 to the base of complimentary emitter follower Q3 and through VR2 and R8 to the base of complimentary emitter follower Q4.

4-48. COMPLIMENTARY EMITTER FOLLOWERS. The complimentary emitter followers Q3 through Q6 provide the current gain necessary to drive the output differential amplifiers while maintaining the width, transition-time, and amplitude characteristics of the pulse (see negative output schematic in Section VIII).

4-49. The negative-going leading-edge of the pulse turns Q4 and Q6 on harder than Q3 and Q5, while the positive-going trailing edge of the pulse turns Q3 and Q5 on harder. Breakdown diode VR2 maintains an approximate 3-volt difference between the bases of Q3 and Q4 to keep both transistors on. The pulses taken from the emitters of Q5 and Q6 are coupled to the bases of output differential amplifier transistors Q7 through Q10. Breakdown diodes VR1 and VR3 provide the proper dc level for the cascode reference shifter transistor Q2 and the complimentary emitter followers Q3 through Q6.

4-50. CURRENT SOURCES. Current source transistors A3Q15, Q16, and Q17 each supply .250 ampere which is coupled to differential amplifier transistors Q10/Q11, Q9/Q12, and Q8/Q13 respectively. Current source transistors Q18 and Q19 each supply .125 ampere which is coupled to differential amplifier transistors Q7/Q14. The current sources are activated by base current supplied by the negative current source base supply in the amplitude vernier circuit (see amplitude vernier schematic in Section VIII). The base current is coupled to the current sources by the AMPLITUDE switch which activates the current sources necessary to produce the selected output current.

4-51. When AMPLITUDE switch S5 is set to the .05-.125 position, base current is applied through the AMPLITUDE switch to activate A3Q19. Depending on the setting of AMPLITUDE vernier R5, A3Q19 supplies from .05 to .125 ampere to differential amplifier Q7/Q14.

4-52. When AMPLITUDE switch S5 is set to the .125-.250 position, base current is applied through the AMPLITUDE switch to activate current sources A3Q18 and Q19. Together current sources Q18 and Q19 supply from .125 to .250 ampere to differential amplifier Q7/Q14.

4-53. When the AMPLITUDE switch is set to the .250-.500 position, base current is applied through AMPLITUDE switch S5 to activate current sources Q17, Q18, and Q19. Current source Q17 provides from .125 to .250 ampere for differential amplifier Q8/Q13 while Q18 and Q19 together provide from .125 to .250 ampere to differential amplifier Q7/Q14. The three current sources provide from .250 to .500 ampere to differential amplifiers Q7/Q14 and Q8/Q13.

4-54. When the AMPLITUDE switch is set to the .500-1 AMP position, base current is applied through AMPLITUDE switch S5 to activate current sources Q15-Q19. Current sources Q15, Q16, and Q17 each supply from .125 to .250 ampere to differential amplifiers Q8/Q13, Q9/Q12, and Q10/Q11 respectively. Current sources Q18 and Q19 together supply from .125 to .250 ampere to differential amplifier Q7/Q14. The five current sources combined provide from .500 to 1 ampere to the differential amplifiers.

4-55. The current level of the current sources is controlled by the amplitude vernier circuit to produce the output current selected by the amplitude controls. (For a discussion of the amplitude vernier circuits refer to Paragraph 4-101.)

4-56. **NEGATIVE OUTPUT DIFFERENTIAL AMPLIFIERS.** With their collectors connected to the -24-volt tracking supply (fixed +24V from the negative variable supply), transistors Q7-Q10 function as emitter followers. Amplifiers Q11-Q14 supply the output current. Current from current-source transistors Q15-Q19 is shared between Q7-Q10 and Q11-Q14. Their relative conduction is dependent upon the differential voltage between the negative base tracking supply and the voltage on the bases of Q7-Q10.

4-57. With no pulse applied, the voltage at the bases of Q7-Q10 is maximum (positive) and all the current from the current sources flows through Q7-Q10. At the peak of the pulse, following the leading edge, the base voltages of Q7-Q10 are maximum (negative) and all current flows through Q11-Q14.

4-58. The negative-going leading-edge of the pulse is applied to the bases of transistors Q7-Q10. As the voltage on the bases and emitters of Q7-Q10 falls, the current through the transistors decreases. When the leading-edge of the pulse reaches approximately 10% of maximum amplitude, transistors Q11-Q14 begin to turn on. The current continues to decrease through Q7-Q10 and increase through Q11-Q14 as the leading edge of the pulse increases negatively. When the leading-edge of the pulse reaches approximately 90% of maximum amplitude, Q7-Q10 cut-off, clipping the bottom 10% of the pulse. Now all of current supplied by the current sources flows through Q11-Q14.

4-59. The trailing-edge of the pulse reverses the process caused by the leading-edge of the pulse. The positive-going trailing-edge of the pulse is applied to transistors Q7-Q10. When the pulse decreases to 90% of maximum amplitude, Q7-Q10 begins to turn on. As the pulse continues to decrease, current from the current sources decreases through Q11-Q14 and increases through Q7-Q10. When the pulse decreases to approximately 10% of maximum amplitude, Q11-Q14 cut-off, clipping the top 10% of the pulse. Now all the current from the current sources flows through Q7-Q10. The top and bottom of the pulse are clipped to maintain a clean output pulse.

4-60. The output pulse taken from the collectors of Q11-Q14 is coupled to the internal (50-ohm termination AT1) and external loads. The four differential amplifiers, connected in parallel, function as current sources. The current, as selected by the AMPLITUDE controls, is constant into the total load. The voltage of the pulse is the product of the output current selected and the total impedance of the load.

4-61. Diodes CR1 through CR13 provide reverse-voltage breakdown protection and temperature compensation for the output differential amplifier transistors. Diodes CR1 through CR13 also improve pulse response by reducing the turn-off times of the output transistors.

4-62. Current flow for the entire output amplifier (with the exception of the base and emitter circuits of Q1) is from the negative variable supply to the -24-volt tracking supply. The output current from the differential amplifiers flows from ground to the negative variable supply.

4-63. **BASE-TRACKING SUPPLIES.** Negative base-tracking supply Q20 and Q21 provides a base-supply voltage for the negative output amplifier transistors Q11 through Q14. The base-tracking supplies are set approximately 13 volts below (near ground) the variable supplies. The base-tracking supply circuit tracks the variable supplies at this potential difference throughout the range of the variable supplies.

4-64. POLARITY SELECT.

4-65. The pulses from the positive and negative output amplifiers are coupled to polarity-select relay A7K1. (See offset and power supply schematic in Section VIII.) POLARITY switch S4 energizes or deenergizes A7K1, selecting either positive or negative output pulses, and couples the selected pulses to the OUTPUT jack. When POLARITY switch S4 is set to POS, current flows through resistor R17 and the coil of relay K1 to energize K1. Relay K1 is deenergized when switch S4 is set to NEG. Diode CR5 and capacitor C3 suppress the transient voltage generated by the coil of relay K1 when the relay is energized and deenergized.

4-66. OFFSET.

4-67. The offset circuit adds from 0 to 60 milliamperes current to the output pulse at the OUTPUT connector. (See offset and power supply schematic in Section VIII.) Either positive or negative offset current can be added to either positive or negative output pulses in response to the settings of the OFFSET switch and vernier. The offset circuit consists of reference shifter amplifiers A7Q1 and Q2, Darlington amplifiers Q3/Q7 and Q4/Q8, OUTPUT amplifiers Q9 and Q10, and offset switches Q5 and Q6.

4-68. **POSITIVE OFFSET.** The +25 or -25 volts, as selected by S2, is taken from the wiper of R3 and applied through A7R1 and R2 to the emitters of A7Q1 and Q2. Transistors Q1 and Q2 convert the reference of the dc

level from ground to the variable supplies. When positive offset is selected, the negative voltage from S2 turns off A7Q2, disabling the negative offset circuits. Transistor Q1 is turned on and the variable-supply-referenced dc level is applied to the base of Q3. Transistors Q3 and Q7 comprise a Darlington amplifier which drives output transistor Q9. The offset current taken from the collector of Q9 is applied through L1 and R16 to OUTPUT jack J1. Base current for Q9 flows through R11 and CR3 to the positive base tracking supply.

4-69. NEGATIVE OFFSET. When negative offset is selected, the positive voltage from S2 turns off A7Q1, disabling the positive offset circuits. Transistor Q2 is turned on and the variable-supply-referenced dc level is applied to the base of Q4. Transistors Q4 and Q8 comprise a Darlington amplifier which drives output transistor Q10. The offset current taken from the collector of Q10 is applied through L1 and R16 to OUTPUT jack J1. Base current for Q10 flows through R12 and CR4 to the negative base tracking supply.

4-70. OFFSET CIRCUIT PROTECTION. Transistors A7Q5 and Q6 (positive and negative offset switches) comprise a voltage protection circuit for the output offset transistors. When high voltage output pulses are selected and both variable power supplies are at or near maximum, the protection circuit clamps the base voltages of the output transistors at safe levels. The remaining voltage is dropped across the Darlington amplifiers.

4-71. Before clamping can occur, two conditions must be met: first the offset polarity and the output pulse polarity must be opposite; second the positive base tracking supply and the negative base tracking supply must be greater than 64.9 volts apart. When these two conditions occur, the base of the operating offset output transistor is clamped 64.9 volts below (nearer ground) the base tracking supply of the opposite polarity.

4-72. NEG OFFSET SWITCH. If negative output pulses are selected, negative offset switch A7Q6 is biased on by current from the amplitude vernier circuit applied through R6 to the base of the transistor. Current flows from the negative base tracking supply through CR4 and R8 to Q6. If the variable supplies are at maximum (68 volts), the base tracking supplies track 13 volts below (nearer ground) the variable supplies. Diode VR1 is a 64.9-volt breakdown diode, so the voltage on the cathode of VR1 is +9.9 volts. Since the positive base tracking supply voltage is +55 volts (13 volts below the positive variable supply), diode CR3 is reverse biased. Base current for transistor Q9 flows through R11, VR1, R8, and Q6. With the base of Q9 clamped 64.9 volts above the voltage of the negative base tracking supply, all voltage in excess of the clamp voltage is dropped across Darlington amplifier Q3/Q7.

4-73. If a negative 50-volt pulse is present on the common collectors of Q9 and Q10, the voltage difference between the positive variable supply (68 volts) and the output

pulse (-50 volts) is distributed as follows: 59.9 volts (the difference between the base clamp voltage and the output pulse) will be dropped across Q9, 58.1 volts (the difference between the clamp voltage and the positive variable supply) will be dropped across Darlington amplifier Q3/Q7. These voltages do not exceed the maximum ratings of the transistors.

4-74. POS OFFSET SWITCH. If positive output pulses are selected, positive offset switch A7Q5 is biased on by current from the amplitude vernier circuit applied through R5 to the base of the transistor. Current flows from Q5, through R7 and CR3 to the positive base tracking supply. If the variable supplies are at maximum (68 volts), the voltage on cathode of VR1 will be +55 volts as the base tracking supplies track 13 volts below the variable supplies. Breakdown diode VR1 breaks down at 64.9 volts, so the anode of VR1 is -9.9 volts. Since the negative base tracking supply voltage is -55 volts (13 volts below the negative variable supply), CR4 is reverse biased. Base current for Q10 flows through Q5, R7, VR1, and R12. With the base of Q10 clamped 64.9 volts below the voltage of the positive base tracking supply, all voltage in excess of the clamp voltage is dropped across Darlington amplifier Q4/Q8.

4-75. VARIABLE POWER SUPPLIES.

4-76. The positive and negative variable supplies, located in the 1900A mainframe, provide operating voltages for the output stages of the instrument. These voltages vary between 28 and 68 volts in response to the peak detector circuits located in the Model 1915A.

4-77. NEGATIVE PEAK DETECTOR. The negative peak detector monitors the amplitude of the output pulse from the negative output amplifier and provides a dc control current to the variable supply in the mainframe (see negative output schematic in Section VIII). The control current sets the negative variable supply at the level required by the output circuits. The variable supply is fixed at 28 volts until the output pulse exceeds 10 volts. The variable supply rises 1 volt for each volt of increase in pulse amplitude to a maximum of 68 volts.

4-78. The negative pulse from the negative output differential amplifiers is applied to peak-holding circuit A3R62, CR14, C33, and R65. The negative pulse applied through R62 forward biases CR14 and charges C33 to the peak level of the output pulse. At the end of the pulse, CR14 becomes reverse biased, removing the charge path from the circuit. The voltage on C33 remains at the dc level of the peak of the output pulse until the next pulse is applied from the negative output differential amplifiers.

4-79. The dc level from the peak-holding circuit is applied to bootstrap amplifier Q23 and Q24. Transistors Q23, Q24, and R65 provide the high impedance necessary to preserve the long time constant (1.35 sec) of the holding circuit. Transistors Q23 and Q24 also provide unity voltage gain to drive the peak detector output circuits.

4-80. The dc level taken from the collector of Q24 is directly coupled to the base of reference shifter Q26. Transistor Q26 shifts the reference of the dc level from ground (output pulse reference) to the variable supply. (Both variable supplies use the negative limits of the supply for reference.) Diode VR7 biases Q26 to hold the circuit off until the output pulse exceeds 10 volts.

4-81. The variable-supply-reference dc level is coupled to output current source Q25. Transistor Q25 provides a current to control the variable supply in the mainframe. The voltage of the variable supply changes 4 volts for each 1 milliamperere of current from Q25.

4-82. **POSITIVE PEAK DETECTOR.** The positive and negative peak detectors are nearly identical except for reversed polarities of the power supplies and active components. Only the differences between the positive and negative peak detectors will be described (see positive output schematic in Section VIII).

4-83. The dc level from bootstrap amplifier Q23 and Q24 is coupled directly to output current source Q25 instead of a reference shifter as in the negative peak detector. The reference of the positive variable supply is the negative limit of the supply (ground) and no reference shifting is necessary.

4-84. DUTY CYCLE DETECTOR.

4-85. The duty-cycle detector monitors the duty cycle of the selected pulse. It causes the peak detector to drive the variable supplies to maximum when the duty cycle of the selected pulse falls below approximately .2%. The duty-cycle detector consists of transistors A5Q28 through A5Q33 (see transition-time and duty cycle schematic in Section VIII). The charge on A5C25 turns the duty-cycle detector output transistors (Q30 through Q33) either on or off. This turns A4Q22 and A3Q22 in the peak detectors on or off (see positive and negative output schematics in Section VIII). When A4Q22 and A3Q22 are turned on, the input from the peak-holding circuit in the peak detector is overridden and the peak detectors drive the variable power supplies to maximum.

4-86. The charge on A5C25 (transition-time and duty cycle schematic) is controlled by Q28 and Q29. The bases of Q28 and Q29 are connected to the bases of synchronous switch transistors Q2 and Q4 respectively. Transistors Q4 and Q29 are held off by BIAS LEVEL adjust R15 when no pulse is applied. Transistors Q2 and Q28 are held on with no signal applied. Transistors Q28 and Q29 are connected in a differential amplifier configuration. When Q29 is off, C25 charges toward +25 volts. When Q29 is on, C25 discharges through Q29 toward ground. Breakdown diode VR5 lowers the collector voltage of Q28 to a safe level.

4-87. With less than .2% duty cycle, the negative pulses from the width circuits turn Q28 off less than .2% of

the time and Q29 on less than .2% of the time. With C25 discharging toward ground less than .2% of the time the voltage on C25 rises toward +25 volts sufficiently to turn on Q30. Transistor Q30 is a field-effect transistor providing high input impedance to maintain the long time constant of C25 and R58. When Q30 turns on, the base of Q32 becomes negative with respect to +25 volts, turning Q31, Q32 and Q33 on. Transistor Q31 turns on A4Q22 and Q33 turns on A3Q22 in the positive and negative peak detectors (positive and negative output schematics). Transistors A4Q22 and A3Q22 provide dc levels which override the inputs from the peak-holding circuits and drive both the positive and negative variable supplies to maximum.

4-88. At duty cycles below which the peak detector functions efficiently, the variable supply voltages fall. At the lower supply voltages, the output amplifiers approach saturation which results in distortion of the output pulse. To correct this, the duty cycle detector increases the output of the variable supplies to their maximum level (50-volt output operation). This prevents the output amplifiers from saturating at low duty cycles; however, operating the variable supplies at their maximum level creates some operating limitations. Pulses with amplitudes significantly below 50 volts may be limited to less than 1 microsecond in width. See Figure 4-1 and Figure 4-2 for width vs amplitude graphs.

4-89. When calibrating or troubleshooting the Model 1915A, the duty cycle detector should be deactivated by removing transistors A3Q22 and A4Q22 from their socket mounts.

Note

When operating at output voltages of less than 15 volts, transistors A3Q22 and A4Q22 can be removed from their socket mounts.

4-90. NEGATIVE OVERLOAD PROTECTION.

4-91. The negative overload protection circuit monitors the instantaneous power dissipated in the negative output differential amplifier and turns off the differential amplifier if excessive dissipation occurs. The negative protection circuit also turns on the OVERLOAD lamp on the front panel to indicate the voltage, current or duty cycle must be reduced to resume normal operation. The negative overload protection circuit consists of power-detector current sources A3Q27 and A3Q28, voltage-times-current multiplier A3Q29 and A3Q30, hold-off emitter follower A3Q31, negative-disable monostable multivibrator A5Q39 and A5Q40, negative reference shifter A5Q38, OR gate A5Q34, blinker circuit A2Q37, and lamp driver A2Q36 (see negative overload protection schematic in Section VIII).

4-92. Power detector current sources A3Q27 and A3Q28 supply current for multiplier A3Q29 and A3Q30. At the

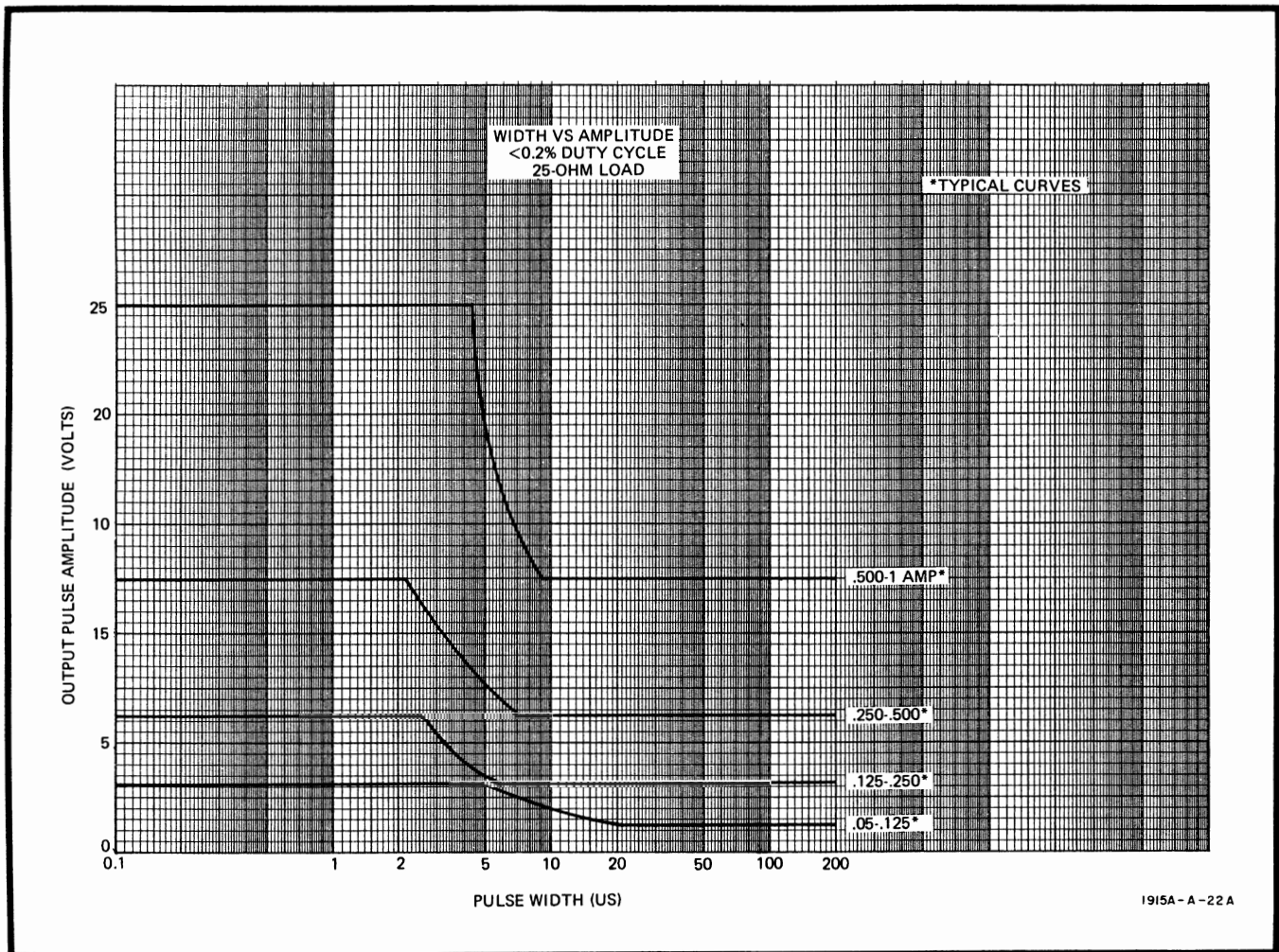

Figure 4-1. Width vs. Amplitude—25-ohm Load

same time the .05-.125 AMPLITUDE range activates current source A3Q19 (negative output schematic), it also activates power detector current source A3Q27. As current increases or decreases through negative output differential amplifier A3Q14 a proportional amount of current from A3CR1 is added to or subtracted from the current through A3Q27. Since the current through A3Q27 is supplied by A3CR16 and A3Q30A, as well as A3R79, the current flowing through A3Q30A is proportional to the current flowing through negative output differential amplifier A3Q14.

4-93. The output voltage pulse (from the negative output differential amplifier) is applied to A3R82 to produce a current through A3R82 and A3Q29A which is proportional to the base-collector voltage of negative output differential amplifier A3Q14. The collector voltage of A3Q30B, derived from the multiplier circuit, is proportional to the products of the currents through Q29A and Q30A. This produces an output voltage from emitter follower A3Q31 which is proportional to the instantaneous power in negative output differential amplifier A3Q14.

Note

Transistors A3Q29 and A3Q30 are dual transistors which are matched for similar voltage-current characteristics. Transistors Q29A, Q29B and Q30A function as diodes.

4-94. When the .125-.250 AMPLITUDE range is selected, both A3Q27 and A3Q28 are activated and function similarly. The current through A3CR16 and A3CR17 add to produce the current through A3Q30A. Again this current is proportional to the current through negative output differential amplifier A3Q14. Since the current through each negative output differential amplifier is equal, only the current in the first differential amplifier is monitored when higher stages are selected.

4-95. Integrating capacitor A3C35 in the collector circuit of A3Q30B prevents very short overloads from energizing the negative disable monostable multivibrator (A5Q39 and A5Q40). For longer overloads, the signal coupled through hold-off emitter follower A3Q31 energizes the negative disable monostable multivibrator. Neg power detector

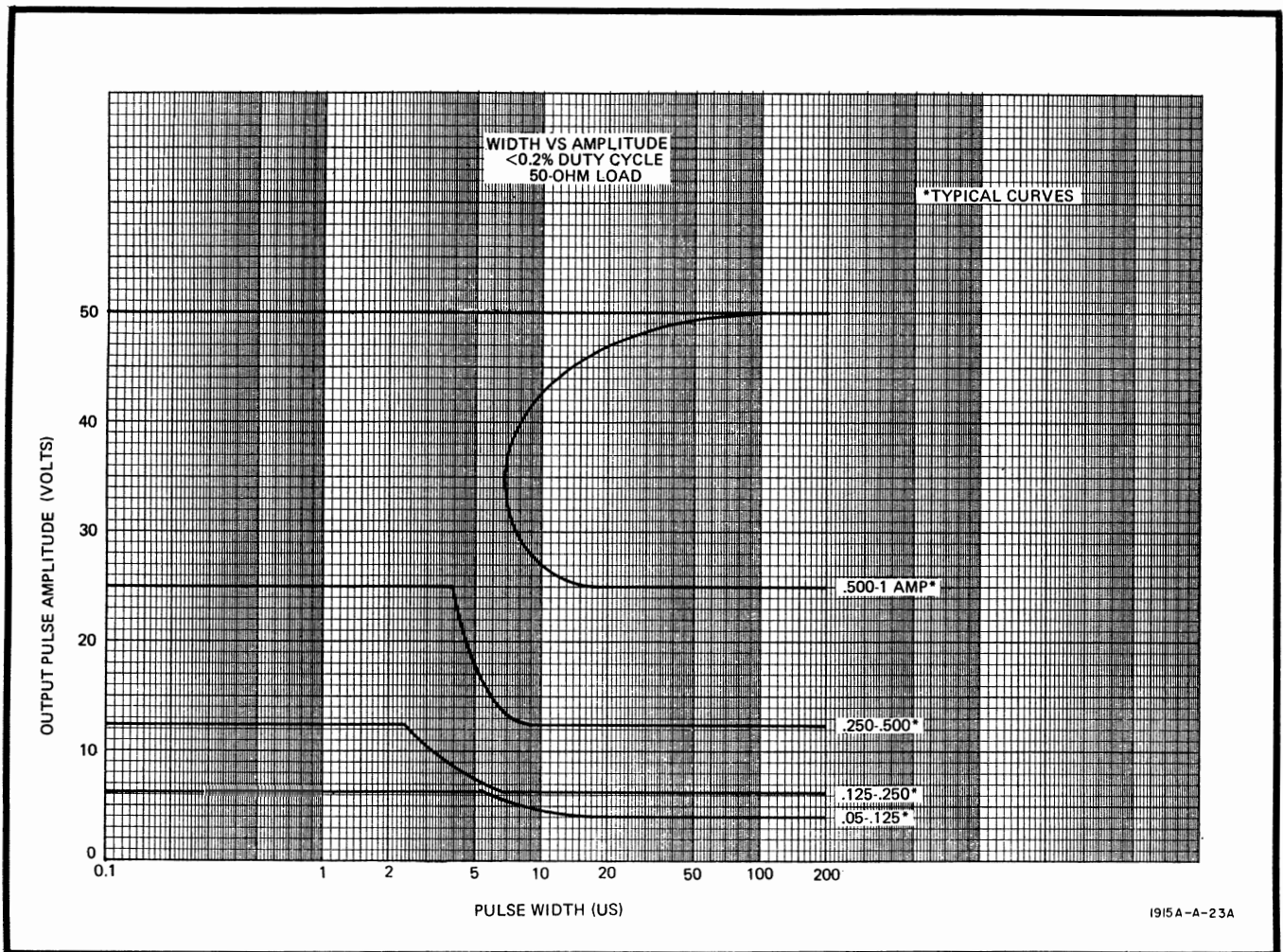

Figure 4-2. Width vs. Amplitude—50-ohm Load

level adj A3R85 sets the precise level at which the negative disable monostable multivibrator energizes.

4-96. Collector current from Q40 flows through R74 and turns on negative disable switch A2Q27 (amplitude vernier schematic). With A2Q27 conducting, the negative current source base (A2Q31 and A2Q33) supply is disabled. This, in turn, disables the negative output amplifier.

4-97. The voltage from the collector of Q40 (negative disable monostable multivibrator) is applied to the base of reference shifter Q38. Transistor Q38 shifts the reference of the voltage from the variable supply to ground. The negative ground referenced voltage taken from the collector of Q38 turns on OR gate Q34. The voltage applied to the emitter of Q34 is the disable voltage from the positive reference converter. Either the positive or negative disable circuits can turn on OR gate transistor Q34.

4-98. Blinker circuit A2Q37 is normally reverse biased by the -25-volt supply through R88 and VR6. When the OR gate turns on, the gate of Q37 goes positive and the transistor turns on. Lamp driver Q36 is normally off with ground applied to the base through R84. The collector of

Q36 and the upper end of C16 are held at 18 volts from the voltage divider consisting of DS1, R82 and R83. When blinker circuit Q37 turns on, lamp driver Q36 saturates, and the collector of Q36 and the top end of C16 are grounded through the transistor. With the upper end grounded, C16 starts charging through R86. The time required to charge C16 is the time that the OVERLOAD lamp on the front panel stays lit. When the capacitor charges sufficiently to turn off Q37, the transistor cuts off the base current for Q36. With Q36 off, ground is removed from the OVERLOAD lamp and C16. The lamp remains off until the next overload condition.

4-99. POSITIVE OVERLOAD PROTECTION.

4-100. The positive and negative overload protection circuits are nearly identical with the exception of reversed polarities of the power supplies and active components.

4-101. AMPLITUDE VERNIER CIRCUIT.

4-102. The amplitude vernier circuit, in response to the AMPLITUDE vernier, controls the amplitude of the output pulse, adjusts the output amplifier current sources to the

required level, and compensates the transition-time current sources to keep the transition times constant. The amplitude vernier circuit consists of AMPLITUDE vernier front panel control R5, amplitude vernier control A2Q21, trailing-edge compensator Q22, amplifiers Q23 and Q25, leading-edge compensator Q24, positive and negative disable switches Q26 and Q27, reference-shifter Q28 and Q29, and positive and negative current-source base supplies Q30 through Q33, (see amplitude vernier schematic in Section VIII).

4-103. AMPLITUDE VERNIER CONTROL. AMPLITUDE vernier R5 is part of voltage divider R5, A2R51, A2CR14, and A2R52 which applies a variable input voltage to the base of Q21. The voltage taken from the collector of Q21 is applied to pulse baseline clamp A5Q7, controlling the dc level of the baseline of the pulse and consequently the amplitude of the pulse. The baseline of the pulse varies from +4.8 volts to +10 volts maximum with respect to ground.

4-104. TRAILING EDGE COMPENSATOR. The voltage from the emitter of Q21 is applied to the base of trailing-edge compensator Q22. The voltage from the emitter of Q22 is coupled through TRANSITION TIME switch S3 to the base of trailing-edge current source A5Q5, providing a compensation voltage to keep the trailing-edge transition time of the pulse constant within specifications over the range of the AMPLITUDE vernier.

4-105. LEADING EDGE COMPENSATOR. The voltage from the emitter of A2Q22 is also applied to the base of amplifier Q23 which inverts and applies the voltage to leading-edge compensator Q24. The voltage from the emitter of Q24 is applied through TRANSITION TIME switch S3 to the base of leading-edge current source A5Q6, providing a compensation voltage to keep the leading-edge transition time of the pulse constant within specifications over the range of the AMPLITUDE vernier.

4-106. REFERENCE SHIFTER. The voltage from the collector of A2Q23 is also applied through R57 to the base of amplifier Q25. The inverted voltage from the

collector of Q25 is coupled to the base of Q29. Transistors Q28 and Q29 shift the reference of the dc voltage from ground to the variable supplies.

4-107. POSITIVE CURRENT SOURCE BASE SUPPLY. The voltage from the collector of Q28 is applied to the base of Q30. Positive current-source base supply transistors Q30 and Q32 comprise a Darlington amplifier which supplies base current for the positive output current sources.

4-108. NEGATIVE CURRENT SOURCE BASE SUPPLY. The voltage from the collector of Q29 is applied to the base of Q31. Negative current-source base supply transistors Q31 and Q33 comprise a Darlington amplifier which supplies base current for the negative output current sources.

4-109. The positive and negative current-source base supplies provide a variable base voltage for the positive and negative output current sources. The variable base voltage controls the output current sources to obtain the proper current for each setting of the AMPLITUDE vernier.

4-110. DISABLE SWITCHES. Positive and negative disable switches A2Q26 and A2Q27 disable the positive or negative current-source base supply in response to inputs from the POLARITY switch and the overload-disable circuit. When an input is applied to the base of Q26 or Q27, the transistor saturates, applying the variable supply voltage to the base of the positive or negative current source base supply (a Darlington amplifier). The variable supply voltage reverse biases the Darlington amplifier and disables the output.

4-111. Transistors Q3 and Q4 (located on the bottom of the plug-in) are parallel disabling circuits. Q3 parallels the positive disable input and Q4 parallels the negative disable input. The function of Q3 and Q4 is to activate the the positive and negative disable switches as the power supplies decay when the mainframe power is turned off.

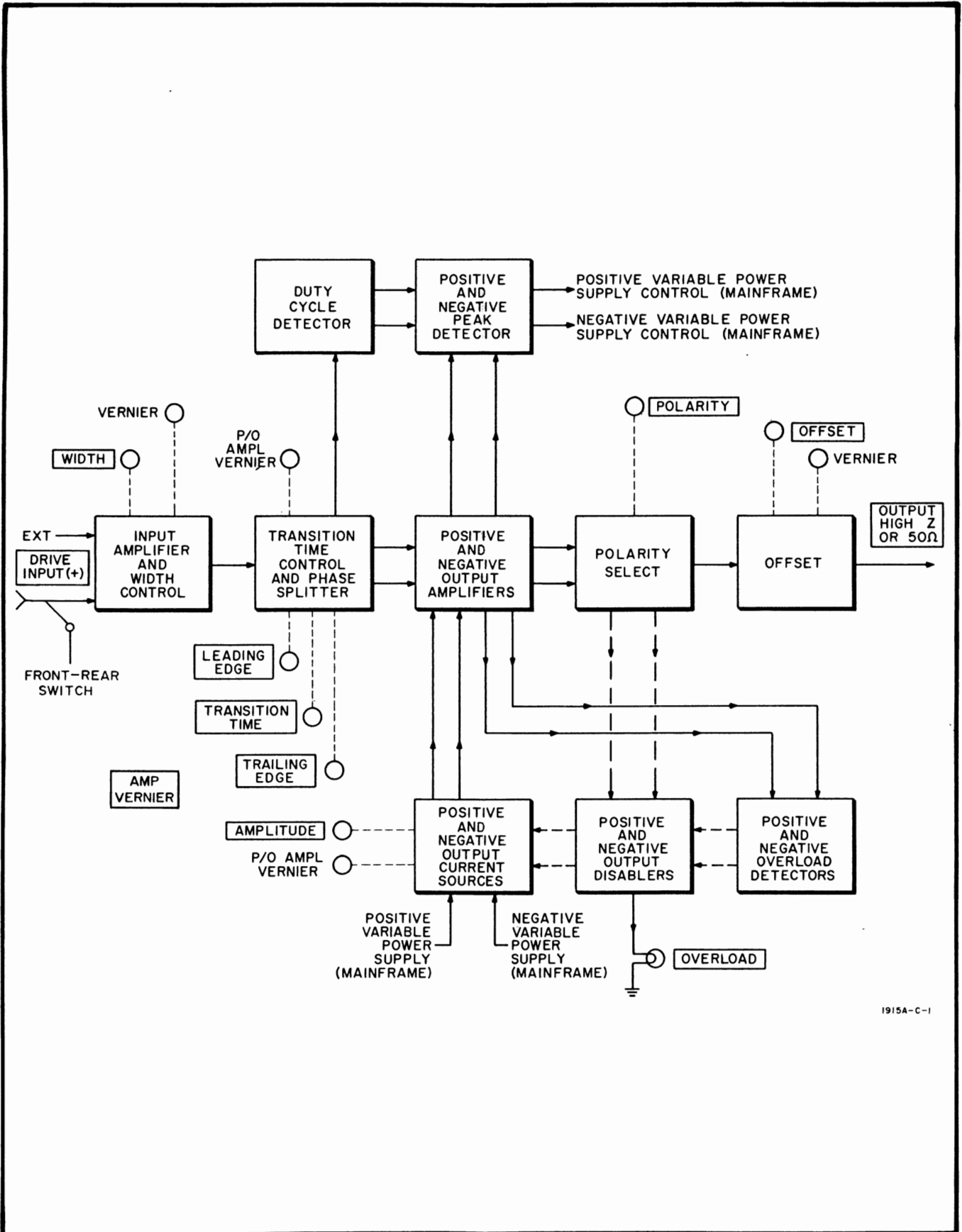

1915A-C-1

Figure 4-3. Model 1915A Overall Block Diagram

Table 5-1. Recommended Test Equipment

Instrument		Required Characteristics	Required For
Type	Model		
Test Pulse Generator	HP 222A	1 kHz rep rate, > 5 ns pulse width, 0 to > +1 volt amplitude	Drive Sensitivity Check
Monitor Oscilloscope Mainframe Vertical Time Base	HP 140A HP 1402A HP 1420A	10 MHz, dual trace, real time	Amplitude Check Transition Time Check Width Check Drive Sensitivity Check
Sampling Oscilloscope Mainframe Vertical Time Base	HP 140A HP 1410A HP 1425A	1 GHz bandwidth, delayed sweep, sampling	Duty Cycle Check Pulse Top Check Width Jitter Check Transition Time Check Width Check
Voltmeter	HP 3430A	0.1% accuracy	Offset Check
Extender: plug-in	HP 10484A	Extend Model 1915A from 1900A mainframe	Adjustment Procedure and Troubleshooting
Extenders: circuit board	HP 5060-0461 HP 5060-0460 HP 5060-0459	15-pin (dual) 22-pin (dual) 24-pin (dual)	FET Current Adjustment and Troubleshooting
50-ohm BNC Tee Connector	HP 1250-0787	BNC Connectors	Performance Checks, Adjustment Procedure and Troubleshooting
50-ohm Tee Connector	HP 10221A	50-ohm Tee, GR Type 874 input, GR Type 874 output, center tap to accept HP 1410A probe tip.	Pulse Top Check
50-ohm Termination	GR 874-W50	50 ohms, GR Type 874 connectors	Pulse Top Check
50-ohm Load	10100A	50 ohms, feed-through BNC connectors	Transition Time Check Width Check
X10 Attenuator	GR874-G20	X10 feed-through attenuator, GR Type 874 50-ohm connector	Pulse Top Check
Mainframe	HP 1900A	No substitute	Operation
Rate Generator	HP 1905A	25 Hz to 25 MHz, >+5V output	Performance Check, Adjustment Procedure and Troubleshooting
Delay Generator	HP 1908A	25 Hz to 25 MHz, variable delay to 10 msec.	Performance Check, Adjustment Procedure and Troubleshooting

7000-A-19

SECTION V

PERFORMANCE CHECK AND ADJUSTMENTS

5-1. INTRODUCTION.

5-2. This section provides adjustment procedures and a performance check for the Model 1915A. The performance check may be used as an incoming inspection, or after repairs or adjustments have been made to verify that the instrument meets the specifications listed in Table 1-1. When the initial performance check is made, record the indications on the Performance Check Record located immediately following the performance check. These indications may be used for comparisons with equipment performance at a later date. Figure 5-21, located on a fold-out at the end of this section, shows all the adjustment locations.

5-3. REQUIRED TEST EQUIPMENT.

5-4. Test equipment recommended for both the performance check and adjustments is listed in Table 5-1. Similar equipment may be substituted provided it has the required characteristics listed in the table.

5-5. MAINFRAME OPERATION.

5-6. Before attempting the performance check or adjustment procedure for the Model 1915A ensure proper operation of the Model 1900A mainframe by completing the performance checks listed in the mainframe manual.

5-7. PERFORMANCE CHECK.

5-8. Set trigger select interface switch A10S1 (see Figure 5-21) forward for external trigger. Connect the internal 50-ohm terminations in the Model 1915A. Install the Model 1915A in the Model 1900A mainframe and allow at least 10 minutes for warm-up. Each major check provides its own independent test setup to facilitate quick checks of individual functions.

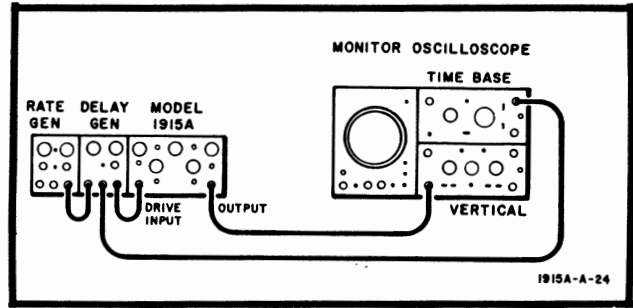

Figure 5-1. Amplitude Test Setup

5-9. AMPLITUDE.

- a. Connect equipment as shown in Figure 5-1.
- b. Set rate generator for 2.5 kHz (400 usec period).
- c. Set Model 1915A front-panel controls as follows:

WIDTH 40-400
 WIDTH vernier ccw
 TRANSITION TIME007-.2
 LEADING EDGE ccw
 TRAILING EDGE ccw
 AMPLITUDE05-.125
 AMPLITUDE vernier ccw
 OFFSET OFF
 OFFSET vernier ccw
 POLARITY POS

- d. Using monitor oscilloscope, make amplitude checks listed in Table 5-2.
- e. Repeat step d with Model 1915A POLARITY switch set to NEG.

Table 5-2. Amplitude Checks

AMPLITUDE switch (amperes)	AMPLITUDE vernier ccw	AMPLITUDE vernier cw
.05-.125	<2.5V	6.25 ±.5V
.125-.250	<6.25V	12.5 ±.5V
.250-.500	<12.5V	25 ±1V
.500-1	< 25V	50 ±2V

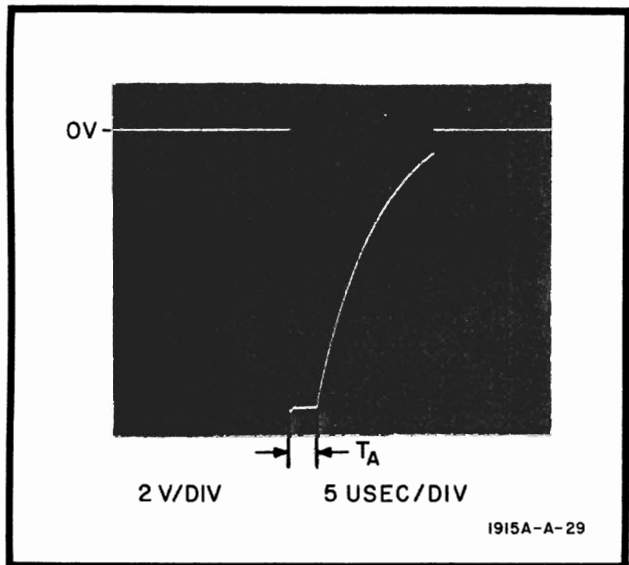

Figure 5-2. Negative Overload Test Pulse

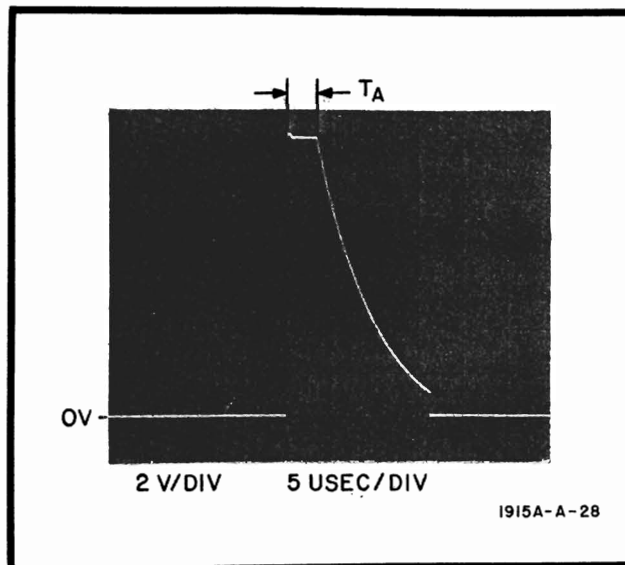

Figure 5-3. Positive Overload Test Pulse

5-10. OVERLOAD.

- a. Connect equipment as shown in Figure 5-1.
- b. Set rate generator for 25 Hz (40 ms period).
- c. Set Model 1915A front-panel controls as follows:
 WIDTH 40-400
 WIDTH vernier ccw

- TRANSITION TIME007-.2
- LEADING EDGE ccw
- TRAILING EDGE ccw
- AMPLITUDE125-.250
- AMPLITUDE vernier cw
- OFFSET OFF
- OFFSET vernier ccw
- POLARITY NEG

Table 5-3. Minimum Range Transition Time Checks

WIDTH (usec)	WIDTH vernier	TRANSITION TIME (usec)	leading and trailing edge transition times
.04-.4	100 ns	.007-.2	<7 ns
.04-.4	100 ns	.015-1	<15 ns
.04-.4	100 ns	.02-2	<20 ns
.4-4	500 ns	.05-5	<50 ns
.4-4	500 ns	.1-10	<100 ns
.4-4	500 ns	.2-20	<200 ns
.4-4	2 usec	.5-50	<500 ns
4-40	20 usec	1-100	<1 usec
4-40	20 usec	2-200	<2 usec
4-40	20 usec	5-500	<5 usec
4-40	40 usec	10-1000	<10 usec

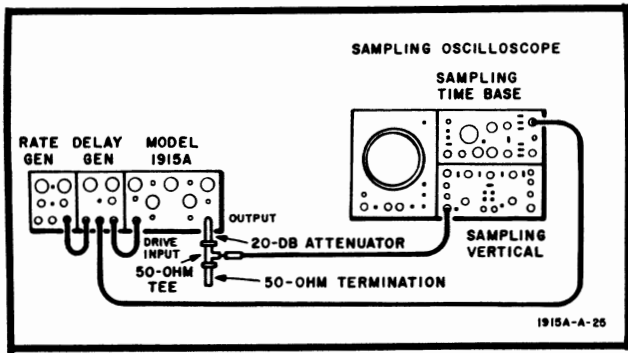

Figure 5-4. Sampling Oscilloscope Test Setup

NOTE

OVERLOAD light should be on.

d. Using monitor oscilloscope observe Model 1915A output. Output should be similar to that shown in Figure 5-2. Limit: T_A should be less than 5 usec.

e. Change Model 1915A POLARITY to POS.

f. Using monitor oscilloscope observe Model 1915A output. Output should be similar to that shown in Figure 5-3. Limit: T_A should be less than 5 usec.

5-11. TRANSITION TIME (minimum).

- a. Connect equipment as shown in Figure 5-4.
- b. Set rate generator for 10 kHz (100 usec period).
- c. Set Model 1915A front-panel controls as follows:

WIDTH04-4
 WIDTH vernier for 100 ns
 TRANSITION TIME..... .007-.2
 LEADING EDGE ccw
 TRAILING EDGE ccw
 AMPLITUDE05-.125
 AMPLITUDE vernier as required
 OFFSET OFF
 OFFSET vernier ccw
 POLARITY POS

d. Using sampling oscilloscope, make leading edge and trailing edge transition time checks listed in Table 5-3. Leading edge and trailing edge transition times are measured between the 10% and 90% amplitude points.

e. Repeat step d with Model 1915A POLARITY switch set to NEG.

Table 5-4. Maximum Range Transition Time Checks

WIDTH switch	WIDTH vernier (usec)	TRANSITION TIME (usec)	leading and trailing edge transition times
4-40	5 usec	.007-.2	>200 ns
4-40	10 usec	.015-1	>1 usec
4-40	10 usec	.02-2	>2 usec
40-400	50 usec	.05-5	>5 usec
40-400	50 usec	.1-10	>10 usec
40-400	200 usec	.2-20	>20 usec
40-400	200 usec	.5-50	>50 usec
400-4K	1.0 ms	1-100	>100 usec
400-4K	1.0 ms	2-200	>200 usec
4K-40K*	5.0 ms	5-500	>500 usec
4K-40K*	10.0 ms	10-1000	>1.0 ms

* Set rate generator for 50 Hz.

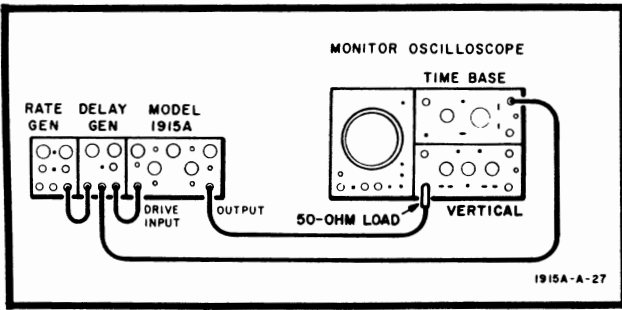

Figure 5-5. Monitor Oscilloscope Test Setup

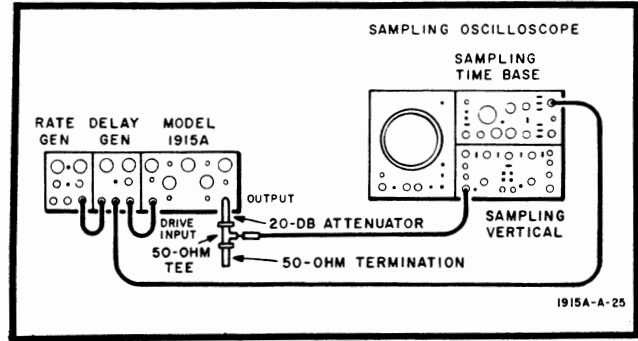

Figure 5-6. Sampling Oscilloscope Test Setup

5-12. TRANSITION TIME (maximum).

- a. Connect equipment as shown in Figure 5-5.
- b. Set rate generator for 300 Hz (3.33 ms period).
- c. Set Model 1915A front-panel controls as follows:

WIDTH 4-40
 WIDTH vernier for 5 usec
 TRANSITION TIME..... .007-.2
 LEADING EDGE cw
 TRAILING EDGE cw
 AMPLITUDE05-.125
 AMPLITUDE vernier as required
 OFFSET..... OFF
 OFFSET vernier ccw
 POLARITY POS

d. Using monitor oscilloscope, make leading edge and trailing edge transition time checks listed in Table 5-4. Leading edge and trailing edge transition times are measured between the 10% and 90% amplitude points.

- e. Repeat step d with Model 1915A POLARITY switch set to NEG.

5-13. WIDTH.

- a. Connect equipment as shown in Figure 5-6.
- b. Set rate generator for 100 kHz (10 usec period).
- c. Set Model 1915A front-panel controls as follows:

WIDTH015-.04
 WIDTH vernier ccw
 TRANSITION TIME..... .007-.2
 LEADING EDGE ccw
 TRAILING EDGE ccw
 AMPLITUDE05-.125
 AMPLITUDE vernier as required
 OFFSET..... OFF
 OFFSET vernier ccw
 POLARITY..... POS

Table 5-5. Width Checks

Oscilloscope	Rate Generator Frequency	WIDTH switch (usec)	Pulse Width	
			vernier ccw	vernier cw
sampling	100 kHz	.015-.04	<15 ns	>40 ns
sampling	100 kHz	.04-.4	<40 ns	>400 ns
sampling	100 kHz	.4-4	<400 ns	>4 usec
monitor *	10 kHz	4-40	<4 usec	>40 usec
monitor *	1 kHz	40-400	<40 usec	>400 usec
monitor *	100 kHz	400-4K	<400 usec	>4 ms
monitor *	10 Hz	4K-40K	<4 ms	>40 ms

*Connect equipment as shown in Figure 5-5.

d. Using the sampling and monitor oscilloscopes, make the width checks listed in Table 5-5.

5-14. OFFSET.

a. With no input to Model 1915A, connect voltmeter to Model 1915A OUTPUT connector.

b. Set Model 1915A front-panel controls as follows:

- WIDTH015-.04
- WIDTH vernier ccw
- TRANSITION TIME..... .007-.2
- LEADING EDGE..... ccw
- TRAILING EDGE ccw
- AMPLITUDE 0
- AMPLITUDE vernier ccw
- OFFSET..... OFF
- OFFSET vernier..... ccw
- POLARITY..... POS

c. Rotate Model 1915A OFFSET switch between OFF, NEG, and POS, while observing voltmeter. Limit: 0 ±50 mV dc.

d. Rotate Model 1915A OFFSET vernier between full cw and full ccw with OFFSET switch in the OFF, NEG, and POS positions while observing voltmeter. Limit: <±50 mV in OFF; 0 to >-3V in NEG; 0 to >+3V in POS.

5-15. DUTY CYCLE.(internal).

- a. Connect equipment as shown in Figure 5-7.
- b. Set rate generator for 100 kHz (10 usec period).
- c. Set Model 1915A front-panel controls as follows:

- WIDTH 4-40
- WIDTH vernier..... ccw

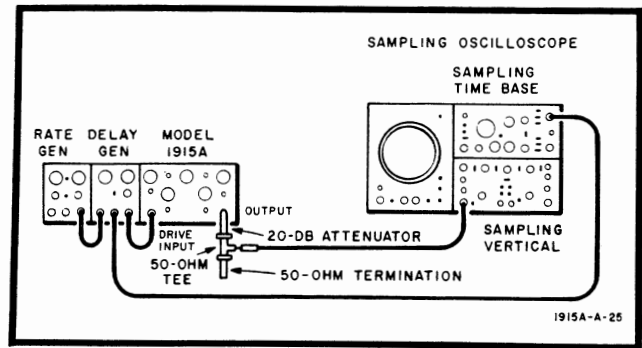

Figure 5-7. Sampling Oscilloscope Test Setup

- TRANSITION TIME..... .007-.2
- LEADING EDGE..... ccw
- TRAILING EDGE ccw
- AMPLITUDE05-.125
- AMPLITUDE vernier..... as required
- OFFSET..... OFF
- OFFSET vernier ccw
- POLARITY POS

d. Set sampling oscilloscope controls to place leading edge of two adjacent pulses 10 divisions apart.

e. Adjust Model 1915A WIDTH vernier for maximum attainable duty cycle. Limit: ≥65% duty cycle.

f. Set rate generator for 25 MHz (40 ns period).

g. Set Model 1915A WIDTH switch to .015-.04 range and repeat steps d and e. Limit: ≥50% duty cycle.

5-16. DRIVE SENSITIVITY.

- a. Connect equipment as shown in Figure 5-8.
- b. Set test pulse generator rate for 1 kHz (1 ms period), pulse width for greater than 5 ns, output amplitude greater than +1V (but less than +5V) to DRIVE INPUT jack of Model 1915A.

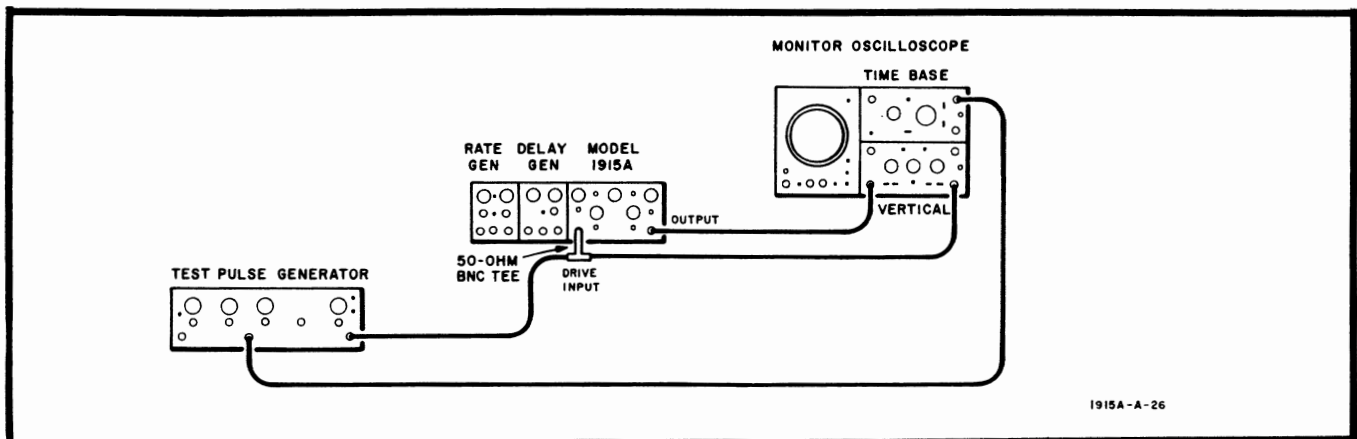

Figure 5-8. Drive Sensitivity Test Setup

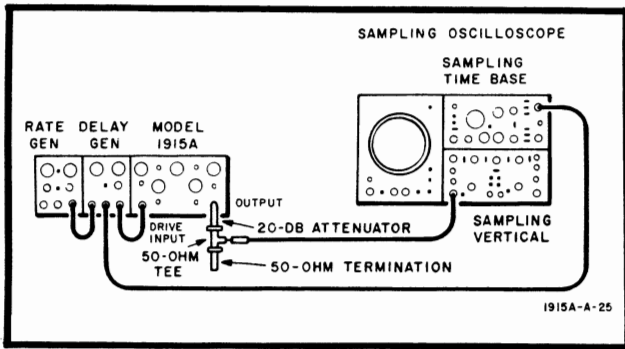

Figure 5-9. Sampling Oscilloscope Test Setup

c. Set Model 1915A front-panel controls as follows:

WIDTH 400-4K
 WIDTH vernier ccw
 TRANSITION TIME007-.2
 LEADING EDGE ccw
 TRAILING EDGE ccw
 AMPLITUDE05-.125
 AMPLITUDE vernier as required
 OFFSET OFF
 OFFSET vernier ccw
 POLARITY POS

d. Slowly decrease amplitude of test pulse generator output until Model 1915A just stops triggering. Limit: amplitude of pulse at DRIVE INPUT connector must be less than +1V.

5-17. PULSE TOP VARIATIONS.

- a. Connect equipment as shown in Figure 5-9.
- b. Set rate generator for 100 kHz (10 usec period).
- c. Set Model 1915A front-panel controls as follows:

WIDTH4-4
 WIDTH vernier for 3 usec pulse
 TRANSITION TIME007-.2
 LEADING EDGE ccw
 TRAILING EDGE ccw
 AMPLITUDE05-.125
 AMPLITUDE vernier ccw
 OFFSET OFF
 OFFSET vernier ccw
 POLARITY POS
- d. Set sampling oscilloscope controls to monitor pulse from OUTPUT connector.
- e. Measure the pulse top variations to the limits listed in Table 5-6. These limits apply for a total output impedance of 25 ohms (50-ohm internal termination with external 50-ohm load) at all amplitudes and all pulse widths.

Table 5-6. 25-ohm Pulse Top Variation Checks

Transition Times	Pulse Top Variations
< 7 ns	not specified
7 ns to 20 ns	±5%
> 20 ns	±2%

- f. Repeat step e with POLARITY switch set to NEG.
- g. Remove internal 50-ohm terminations (see Section III).
- h. Pulse top variations must be less than 5%. These limits apply for a total output impedance of 50 ohms (high-z internal impedance with external 50-ohm load) at all amplitudes and all pulse widths.
- i. Repeat step h with POLARITY switch set to POS.
- j. Connect internal 50-ohm terminations.

5-18. WIDTH JITTER.

- a. Connect equipment as shown in Figure 5-9.
- b. Set rate generator for 50 kHz (20 usec period).
- c. Set Model 1915A front-panel controls as follows:

WIDTH04-.4
 WIDTH vernier for 100 ns
 TRANSITION TIME007-.2
 LEADING EDGE ccw
 TRAILING EDGE ccw
 AMPLITUDE05-.125
 AMPLITUDE vernier as required
 OFFSET OFF
 OFFSET vernier ccw
 POLARITY POS
- d. Set sampling oscilloscope controls to observe transition times at 1 ns/division.
- e. Measure leading edge jitter and trailing edge jitter. Subtract leading edge jitter from trailing edge jitter, the difference is pulse width jitter. Limit: pulse width jitter shall be less than 0.5 ns.
- f. Set Model 1915A WIDTH switch to .4-4 range, set WIDTH vernier for 1 usec pulse width.

g. Set sampling oscilloscope controls to observe transition time at 2 ns/division.

h. Measure leading edge and trailing edge jitter. Subtract leading edge jitter from trailing edge jitter, the difference is pulse width jitter. Limit: pulse width jitter shall be less than 5 ns.

i. Set Model 1915A WIDTH switch to 4-40 range. Set WIDTH vernier for 10 usec pulse width.

j. Set sampling oscilloscope controls to observe transition times at 20 ns/division.

k. Measure leading edge and trailing edge jitter. Subtract leading edge jitter from trailing edge jitter, the difference is pulse width jitter. Limit: pulse width jitter shall be less than 25 ns.

This completes the Performance Check Procedure.

PERFORMANCE CHECK RECORD

Model 1915A

Instrument Serial Number _____

Date _____

Paragraph Reference	Check	Specification	Measured		
5-9	AMPLITUDE				
5-9d	Positive Polarity				
	Range	Vernier			
	.05 - .125	ccw cw			< 2.5V 6.25 ±.5V
	.125 - .250	ccw cw			< 6.25V 12.5 ±.5V
	.250 - .500	ccw cw			< 12.5V 25 ±1V
	.500 - 1	ccw cw			< 25V 50 ±2V
	5-9e	Negative Polarity			
		Range			Vernier
.05 - .125		ccw cw	< 2.5V 6.25 ±.5V		
.125 - .250		ccw cw	< 6.25V 12.5 ±.5V		
.250 - .500		ccw cw	< 12.5V 25 ±1V		
.500 - 1		ccw cw	< 25V 50 ±2V		
5-10		OVERLOAD			
5-10d		Negative Polarity		< 5 usec	
5-10f	Positive Polarity		< 5 usec		

PERFORMANCE CHECK RECORD

Model 1915A

Instrument Serial Number _____

Date _____

Paragraph Reference	Check	Specification	Measured	
5-11	TRANSITION TIME (minimum)			
5-11d	Positive Polarity <u>Range</u> .007 - .2 .015 - 1 .02 - 2 .05 - 5 .1 - 10 .2 - 20 .5 - 50 1 - 100 2 - 200 5 - 500 10 - 1000	< 7 ns < 15 ns < 20 ns < 50 ns < 100 ns < 200 ns < 500 ns < 1 usec < 2 usec < 5 usec < 10 usec	Leading Edge _____ _____ _____ _____ _____ _____ _____ _____ _____ _____	Trailing Edge _____ _____ _____ _____ _____ _____ _____ _____ _____ _____
5-11e	Negative Polarity <u>Range</u> .007 - .2 .015 - 1 .02 - 2 .05 - 5 .1 - 10 .2 - 20 .5 - 50 1 - 100 2 - 200 5 - 500 10 - 1000		Leading Edge _____ _____ _____ _____ _____ _____ _____ _____ _____ _____	Trailing Edge _____ _____ _____ _____ _____ _____ _____ _____ _____ _____
5-12	TRANSITION TIME (maximum)			
5-12d	Positive Polarity <u>Range</u> .007 - .2 .015 - 1 .02 - 2 .05 - 5 .1 - 10 .2 - 20 .5 - 50 1 - 100 2 - 200 5 - 500 10 - 1000	> 200 ns > 1 usec > 2 usec > 5 usec > 10 usec > 20 usec > 50 usec > 100 usec > 200 usec > 500 usec > 1.0 ms	Leading Edge _____ _____ _____ _____ _____ _____ _____ _____ _____ _____	Trailing Edge _____ _____ _____ _____ _____ _____ _____ _____ _____ _____

PERFORMANCE CHECK RECORD

Model 1915A

Instrument Serial Number _____

Date _____

Paragraph Reference	Check		Specification	Measured		
5-12e	Negative Polarity			Leading Edge	Trailing Edge	
	<u>Range</u> .007 - .2 .015 - 1 .02 - 2 .05 - 5 .1 - 10 .2 - 20 .5 - 50 1 - 100 2 - 200 5 - 500 10 - 1000					
5-13	WIDTH					
5-13d	Range	Vernier				
	.015 - .04	ccw cw		< 15 ns > 40 ns		
	.04 - .4	ccw cw		< 40 ns > 400 ns		
	.4 - 4	ccw cw		< 400 ns > 4 usec		
	4 - 40	ccw cw		< 4 usec > 40 usec		
	40 - 400	ccw cw		< 40 usec > 400 usec		
	400 - 4K	ccw cw		< 400 usec > 4 ms		
	4K - 40K	ccw cw		< 4 ms > 40 ms		

PERFORMANCE CHECK RECORD

Model 1915A

Instrument Serial Number _____

Date _____

Paragraph Reference	Check	Specification	Measured	
5-14	OFFSET			
5-14c	Range			
	Vernier			
	OFF NEG POS	ccw ccw ccw	0 ±50 mV 0 ±50 mV 0 ±50 mV	_____ _____ _____
5-14d	OFF	ccw-cw	< ±50 mV	_____
	NEG	ccw-cw	0 to > -3V	_____
	POS	ccw-cw	0 to > +3V	_____
5-15	DUTY CYCLE (internal)			
5-15e	4-40 WIDTH range, 100 kHz Rate	≥ 65%	_____	
5-15g	.015 - .04 WIDTH range, 25 MHz Rate	≥ 50%	_____	
5-16	DRIVE SENSITIVITY			
5-16d	400-4K WIDTH range, 1 kHz Rate	< +1V	_____	
5-17	PULSE TOP VARIATIONS			
5-17e	25-ohm Positive Polarity			
	Transition Time			
	7 ns to 20 ns > 20 ns	< ±5% < ±2%	_____ _____	
5-17f	25-ohm Negative Polarity			
	Transition Time			
	7 ns to 20 ns > 20 ns	< ±5% < ±2%	_____ _____	
5-17h	50-ohm Negative Polarity	< ±5%	_____	
5-17i	50-ohm Positive Polarity	< ±5%	_____	
5-18	WIDTH JITTER			
5-18e	100 ns pulse width	< 0.5 ns	_____	
5-18h	1 usec pulse width	< 5 ns	_____	
5-18k	10 usec pulse width	< 25 ns	_____	

5-19. ADJUSTMENT PROCEDURE.

5-20. This adjustment procedure is presented in a planned sequence. Do not deviate from this sequence as succeeding steps are dependent on proper adjustment and results of previous steps. Make no internal adjustments unless the Model 1915A does not meet all the specifications listed in Table 1-1 as verified in the performance checks immediately preceding this adjustment procedure.

5-21. INITIAL PREPARATION.

5-22. Before attempting this adjustment procedure, perform the following initial preparation procedure.

- a. Turn mainframe power off.



Allow 15 seconds for the power supplies to discharge after power has been turned off before installing or removing the Model 1915A from the Model 1900A mainframe.

- b. Remove Model 1915A from Model 1900A mainframe.
- c. Remove connector bracket MP15 from back of plug-in.
- d. Remove top cover MP1 by sliding toward rear of plug-in.
- e. Set trigger select interface switch A10S1 (see Figure 5-15) toward front-panel for external trigger coupling.
- f. Connect internal 50-ohm terminations.
- g. Install HP Model 10484A extender plug-in into Model 1900A mainframe.
- h. Install Model 1915A on extender plug-in.
- i. Place A5 circuit board assembly on circuit board extender.
- j. Turn mainframe power on and allow 10 minutes for instrument warm-up.

5-23. BIAS LEVEL A5R15 ADJUSTMENT.

- a. Disconnect any input to Model 1915A DRIVE INPUT connector.

- b. Set Model 1915A front-panel controls as follows:

WIDTH	4-40
WIDTH vernier	ccw
TRANSITION TIME007-.2
LEADING EDGE	ccw
TRAILING EDGE	ccw

AMPLITUDE	0
AMPLITUDE vernier	ccw
OFFSET	OFF
OFFSET vernier	ccw
POLARITY	NEG

- c. Using a voltmeter, monitor dc voltages at A5TP6 and A5TP7.

- d. Adjust BIAS LEVEL A5R15 so A5TP6 is 0.5V more negative than A5TP7.

5-24. FET CURRENT A5R23 ADJUSTMENT.

- a. Using a voltmeter, monitor dc voltages on emitter and collector of A5Q10.

Note

The emitter voltage of A5Q10 can be measured on the lower end of A5R27 (nearest board plug). The collector voltage of A5Q10 can be measured on the lower end of A5R26.

- b. Adjust FET CURRENT A5R23 to obtain $-1 \pm .25V$ emitter voltage and $+1 \pm .25V$ collector voltage.

Note

If the voltages in step b cannot be obtained, A5VR3 and A5VR4 may be selected to change the operating range of A5Q10.

- c. Turn mainframe power off (allow 15 seconds for power supplies to discharge before continuing).

- d. Remove A5 circuit board assembly from circuit board extender and install in instrument.

- e. Turn mainframe power on

5-25. NEG BASE TRACKING SUPPLY A3R57 ADJUSTMENT.

- a. Connect equipment as shown in Figure 5-10.

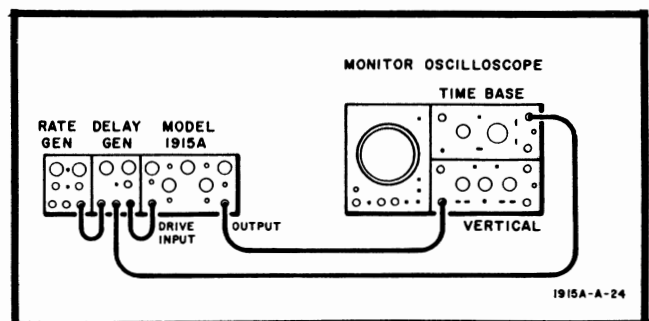

Figure 5-10. Adjustment Test Setup

- b. Set rate generator for 25 kHz (40 usec period).
- c. Set Model 1915A front-panel controls as follows:

WIDTH	4-40
WIDTH vernier	ccw
TRANSITION TIME007.2
LEADING EDGE	ccw
TRAILING EDGE	ccw
AMPLITUDE05-.125
AMPLITUDE vernier	ccw
OFFSET	OFF
OFFSET vernier	ccw
POLARITY	NEG

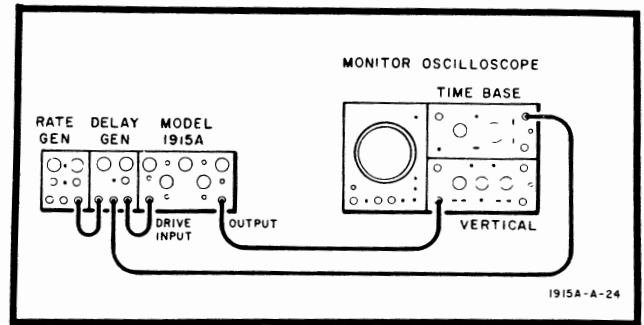

Figure 5-11. Adjustment Test Setup

- d. Set monitor oscilloscope controls to obtain a display.
- e. Observe output pulse and set neg base tracking supply adjustment A3R57 in center of region of maximum amplitude.

5-26. NEGATIVE AMPLITUDE A2R68 ADJUSTMENT.

- a. Connect equipment as shown in Figure 5-11.
- b. Set rate generator for 25 kHz (40 usec period).
- c. Set Model 1915A front-panel controls as follows:

- | | |
|-------------------------|----------|
| WIDTH | 4-40 |
| WIDTH vernier | ccw |
| TRANSITION TIME | .007-.2 |
| LEADING EDGE | ccw |
| TRAILING EDGE | ccw |
| AMPLITUDE | .05-.125 |
| AMPLITUDE vernier | cw |
| OFFSET | OFF |
| OFFSET vernier | ccw |
| POLARITY | NEG |

- d. Set monitor oscilloscope controls to obtain a display.

- e. Adjust -AMPL A2R68 for -6.3V pulse amplitude as indicated on monitor oscilloscope.

5-27. NEG POWER DETECTOR LEVEL A3R85 ADJUSTMENT AND NEG POWER DETECTOR BALANCE A3R88 ADJUSTMENT.



This procedure must be performed exactly as described herein. Overload protection adjustments made in some manner other than described herein will void the equipment warranty.

- a. Connect equipment as shown in Figure 5-11.
- b. Set rate generator for 100 Hz (10 ms period).
- c. Set Model 1915A front-panel controls as follows:

- | | |
|-------------------------|-----------|
| WIDTH | 400-4K |
| WIDTH vernier | ccw |
| TRANSITION TIME | 10-1000 |
| LEADING EDGE | ccw |
| TRAILING EDGE | ccw |
| AMPLITUDE | .125-.250 |
| AMPLITUDE vernier | cw |
| OFFSET | OFF |
| OFFSET vernier | ccw |
| POLARITY | NEG |

- d. Set monitor oscilloscope controls to obtain a display.
- e. Set Model 1915A WIDTH vernier, LEADING EDGE and TRAILING EDGE controls to obtain the display shown in Figure 5-12.
- f. Adjust -PD (neg power detector level) A3R85 until OVERLOAD indicator just turns off (power detector just off).

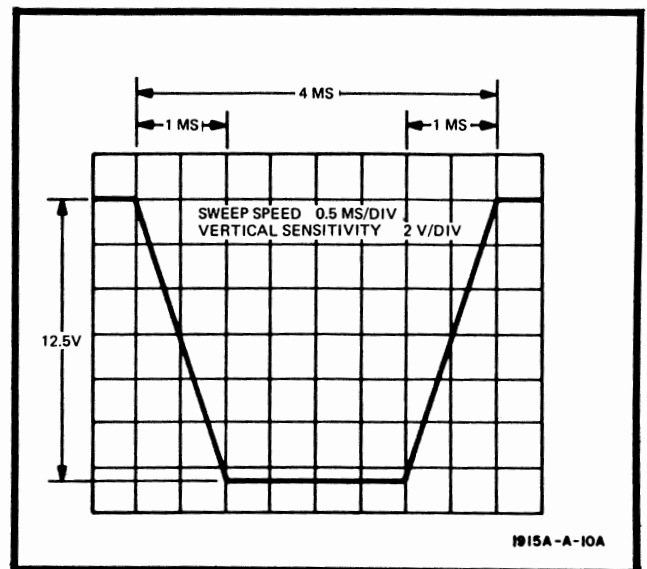

Figure 5-12 Negative Overload Setup Pulse

Note

If OVERLOAD indicator stays on throughout the entire range of A3R85 (-PD), adjust neg power detector balance adjustment A3R88 slightly ccw and repeat step f. If the indicator stays off throughout the entire range of A3R85 (-PD) adjust A3R88 slightly cw and repeat step f.

g. Change the following Model 1915A front-panel controls:

TRANSITION TIME..... .007-2
 AMPLITUDE500-1
 AMPLITUDE vernier ccw

h. Observe output pulse and set neg base tracking supply adjustment A3R57 in center of region of maximum amplitude.

i. Change the following Model 1915A front-panel controls:

TRANSITION TIME..... 10-1000
 AMPLITUDE vernier..... cw

j. Set Model 1915A WIDTH vernier, LEADING EDGE and TRAILING EDGE controls to obtain the display shown in Figure 5-13.

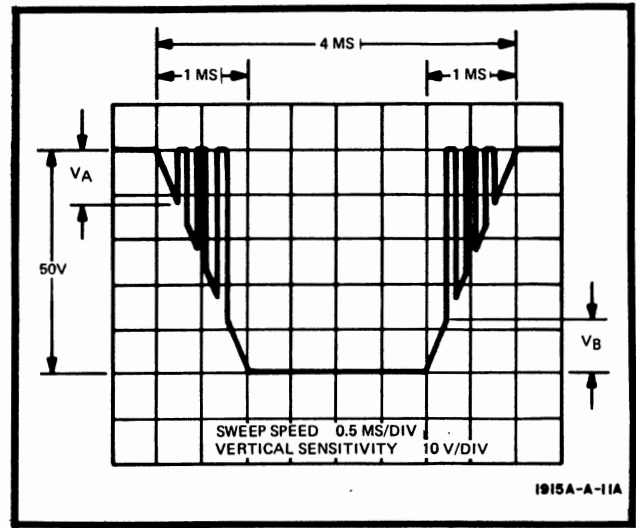

Figure 5-13. Negative Overload Adjustment Pulse

k. Readjust (if necessary) -AMPL A2R68 for -50V pulse amplitude as indicated on monitor oscilloscope.

l. Using a voltmeter, measure voltage from A3TP1 (neg base tracking supply) to ground. Note voltage.

m. Using Figure 5-14, find the voltage noted in step l on the vertical axis (Base Tracking Supply Voltage). Locate VA and VB at intersection with noted voltage.

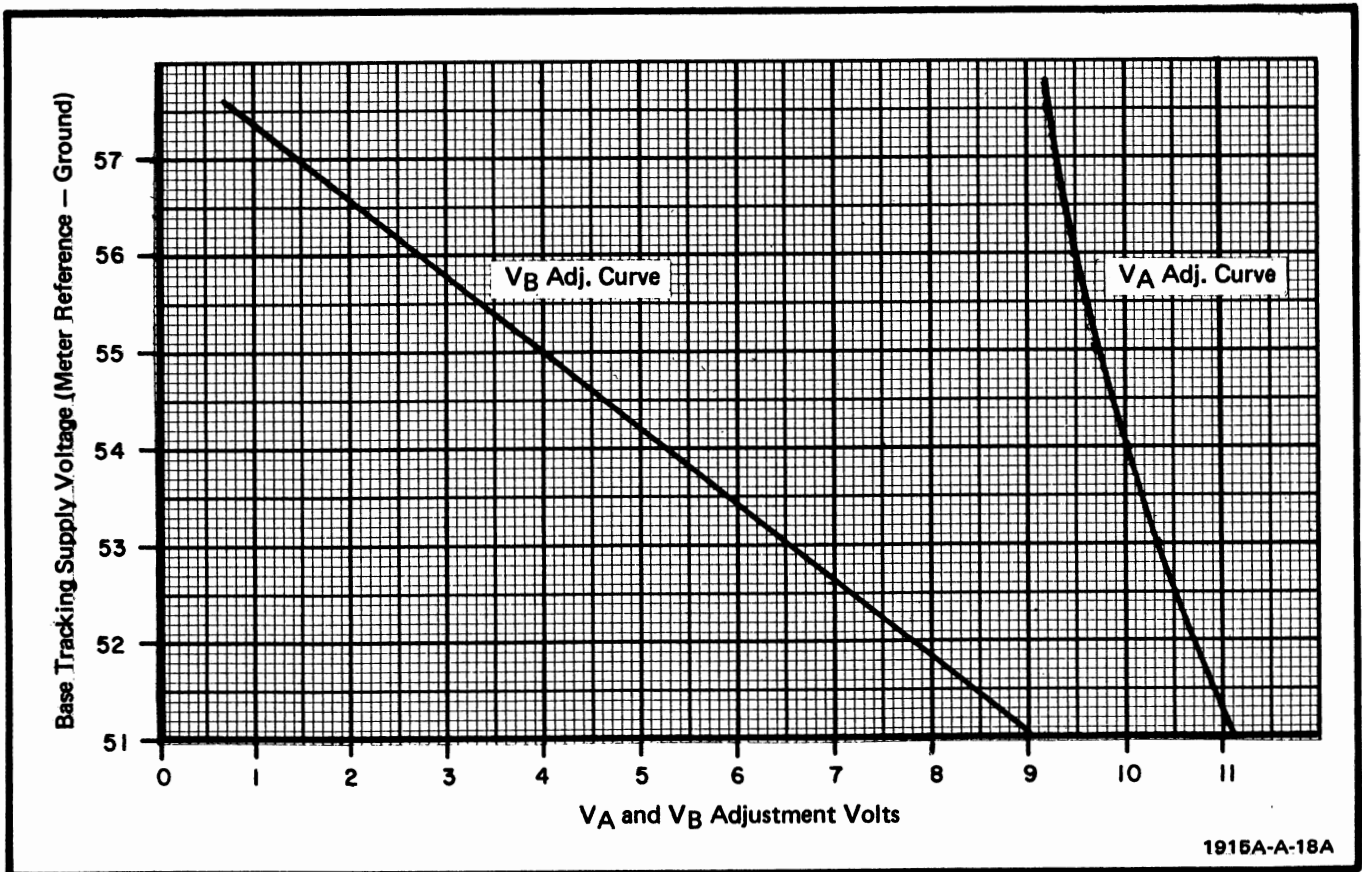

Figure 5-14. Overload Voltage Locator and Adjustment

Note

V_A is the initial voltage that causes the power detector to go into overload on the leading edge of the pulse. V_B is the initial voltage that causes the power detector to go into overload on the trailing edge of the pulse.

n. Adjust A3R88 (neg power detector balance adj) and A3R85 (-PD) until V_A and V_B correspond to the values obtained in step m. (see Figure 5-13.)

Note

By adjusting either A3R88 or A3R85 cw, both V_A and V_B (as measured on oscilloscope) will decrease unequally. (A3R85 has the most effect on the leading edge while A3R88 has the most effect on the trailing edge.) By adjusting either A3R88 or A3R85 ccw, both V_A and V_B will increase unequally. Since both adjustments must be made several times in succession to obtain the desired results, adjust A3R88 and A3R85 simultaneously (using two adjustment tools) until the plotted values for V_A and V_B are achieved.

o. Set rate generator for 25 Hz (40 ms period).

p. Change the following front panel controls:

WIDTH 40-400
 WIDTH vernier ccw
 TRANSITION TIME007-.2
 LEADING EDGE ccw
 TRAILING EDGE ccw
 AMPLITUDE125-.250
 AMPLITUDE vernier cw
 OFFSET OFF
 OFFSET vernier ccw
 POLARITY NEG

q. Using monitor oscilloscope observe Model 1915A output. Output should be similar to that shown in Figure 5-15. T_A should be less than 5 usec.

NOTE

If T_A does not meet the conditions in step q, readjust neg base tracking supply adjustment A3R57 closer to the point where the baseline begins to pull down, then repeat steps a through g and i through q until T_A is less than 5 usec.

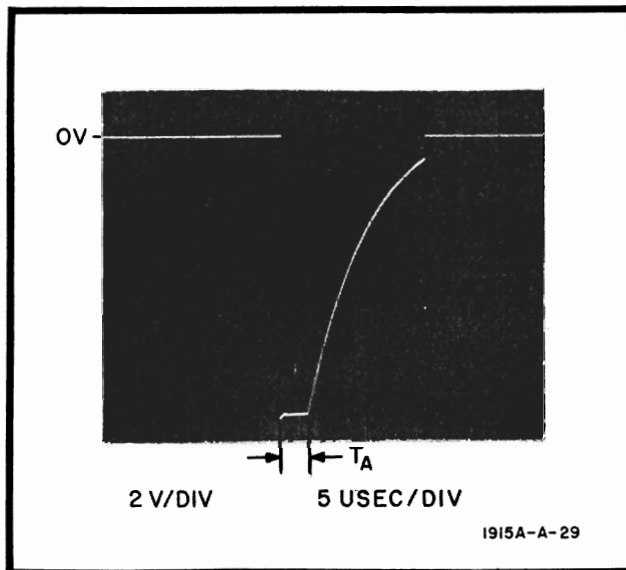

Figure 5-15. Negative Overload Test Pulse

5-28. POS BASE TRACKING SUPPLY A4R57 ADJUSTMENT.

- a. Connect equipment as shown in Figure 5-16.
- b. Set rate generator for 25 kHz (40 usec period).
- c. Set Model 1915A front-panel controls as follows:

WIDTH 4-40
 WIDTH vernier ccw
 TRANSITION TIME007-.2
 LEADING EDGE ccw
 TRAILING EDGE ccw
 AMPLITUDE05-.125
 AMPLITUDE vernier ccw
 OFFSET OFF
 OFFSET ccw
 POLARITY POS

d. Set monitor oscilloscope controls to obtain a display.

e. Observe output pulse and set pos base tracking supply adjustment A4R57 in center of region of maximum amplitude.

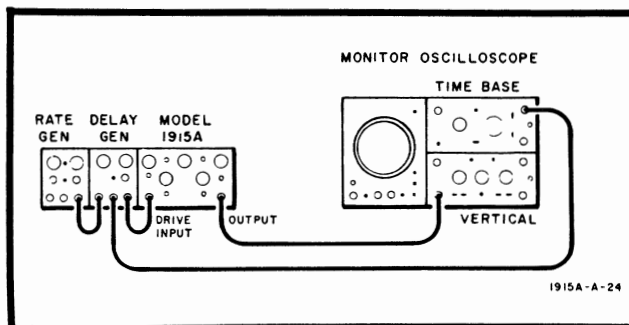

Figure 5-16. Adjustment Test Setup

5-29. POSITIVE AMPLITUDE A2R69 ADJUSTMENT.

- a. Connect equipment as shown in Figure 5-16.
- b. Set rate generator for 25 kHz (40 usec period).
- c. Set Model 1915A front-panel controls as follows:
 WIDTH 4-40
 WIDTH vernier ccw
 TRANSITION TIME007-.2
 LEADING EDGE ccw
 TRAILING EDGE ccw
 AMPLITUDE05-.125
 AMPLITUDE vernier cw
 OFFSET OFF
 OFFSET vernier ccw
 POLARITY POS
- d. Set monitor oscilloscope controls to obtain a display.
- e. Adjust +AMPL A2R69 for +6.3V pulse amplitude as indicated on monitor oscilloscope.

5-30. POS POWER DETECTOR LEVEL A4R85 ADJUSTMENT AND POS POWER DETECTOR BALANCE A4R88 ADJUSTMENT.



This procedure must be performed exactly as described herein. Overload protection adjustments made in some manner other than described herein will void the equipment warranty.

- a. Connect equipment as shown in Figure 5-17.

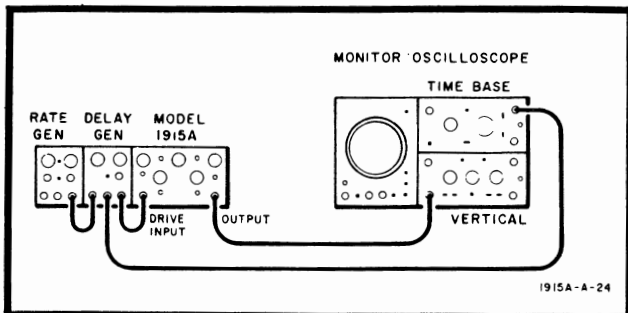

Figure 5-17. Adjustment Test Setup

- b. Set rate generator for 100 Hz (10 ms period).
- c. Set Model 1915A front-panel controls as follows:
 WIDTH 400-4K
 WIDTH vernier ccw
 TRANSITION TIME 10-1000
 LEADING EDGE ccw
 TRAILING EDGE ccw
 AMPLITUDE125-.250

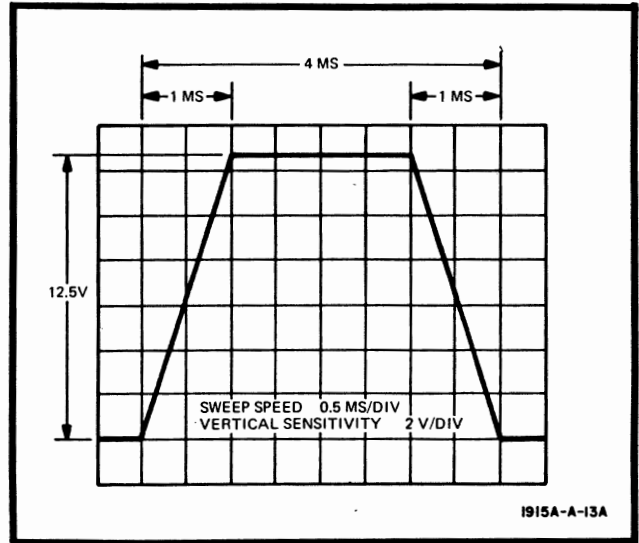

Figure 5-18. Positive Overload Setup Pulse

- AMPLITUDE vernier cw
 OFFSET OFF
 OFFSET vernier ccw
 POLARITY POS
- d. Set monitor oscilloscope controls to obtain a display.
- e. Set Model 1915A WIDTH vernier, LEADING EDGE and TRAILING EDGE controls to obtain the display shown in Figure 5-18.
- f. Adjust +PD (pos power detector level) A4R85 until OVERLOAD indicator just turns off (power detector off).

Note

If OVERLOAD indicator stays on throughout the entire range of +PD A4R85 adjust pos power detector balance adjustment A4R88 slightly ccw and repeat step f. If the indicator stays off throughout the range of +PD A4R85 adjust A4R88 slightly cw and repeat step f.

- g. Change the following Model 1915A front-panel controls:

TRANSITION TIME007-.2
 AMPLITUDE500-1
 AMPLITUDE vernier ccw

- h. Observe output pulse and set pos base tracking supply adjustment A4R57 in center of region of maximum amplitude.
- i. Change the following Model 1915A front-panel controls.

TRANSITION TIME 10-1000
 AMPLITUDE vernier cw

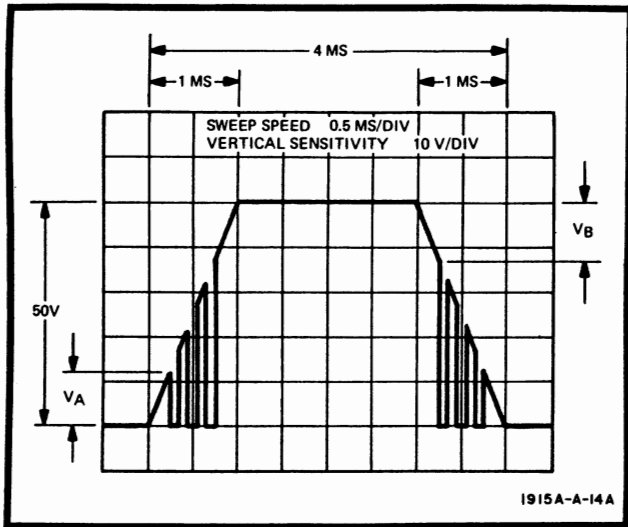

Figure 5-19. Positive Overload Adjustment Pulse

j. Set Model 1915A WIDTH vernier, LEADING EDGE and TRAILING EDGE controls to obtain the display shown in Figure 5-19.

k. Readjust (if necessary) +AMPL A2R69 for +50V pulse amplitude as indicated on monitor oscilloscope.

l. Using a voltmeter, measure voltage from A4TP3 (pos base tracking supply) to ground. Note voltage.

m. Using Figure 5-14, find the voltage noted in step l on the vertical axis (Base Tracking Supply Voltage). Locate V_A and V_B at intersection with noted voltage.

Note

V_A is the initial voltage that causes the power detector to go into overload on the leading edge of the pulse.
 V_B is the initial voltage that causes the power detector to go into overload on the trailing edge of the pulse.

n. Adjust A4R88 (pos power detector balance adj) and A4R85 (+PD) until V_A and V_B correspond to the values obtained in step m. (see Figure 5-19.)

Note

By adjusting either A4R88 or A4R85 cw, both V_A and V_B (as measured on oscilloscope) will decrease unequally. (A4R85 has the most effect on the leading edge while A4R88 has the most effect on the trailing edge.) By adjusting either A4R88 or A4R85 ccw, both V_A and V_B will increase unequally. Since both adjustments must be made several times in succession to obtain the desired results, adjust A4R88 and A4R85 simultaneously (using two adjustment tools) until the plotted values for V_A and V_B are achieved.

o. Set rate generator for 25 Hz (40 ms period).

p. Change the following front-panel controls:

- WIDTH 40-400
- WIDTH vernier ccw
- TRANSITION TIME..... .007-.2
- LEADING EDGE..... ccw
- TRAILING EDGE ccw
- AMPLITUDE125-.250
- AMPLITUDE vernier..... cw
- OFFSET..... OFF
- OFFSET vernier..... ccw
- POLARITY..... POS

q. Using monitor oscilloscope observe Model 1915A output. Output should be similar to that shown in Figure 5-20. T_A should be less than 5 usec.

Note

If T_A does not meet the conditions in step q, readjust neg base tracking supply adjustment A4R57 closer to the point where the baseline begins to pull up, then repeat steps a through g and i through q until T_A is less than 5 usec.

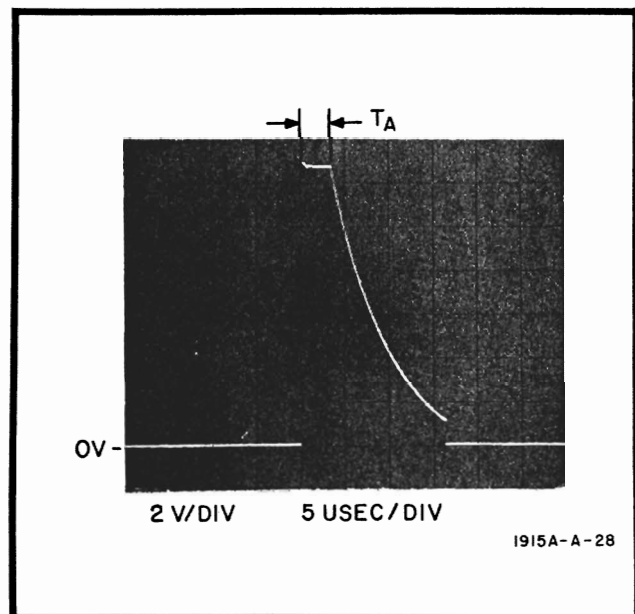

Figure 5-20. Positive Overload Test Pulse

This completes the Adjustment Procedure.

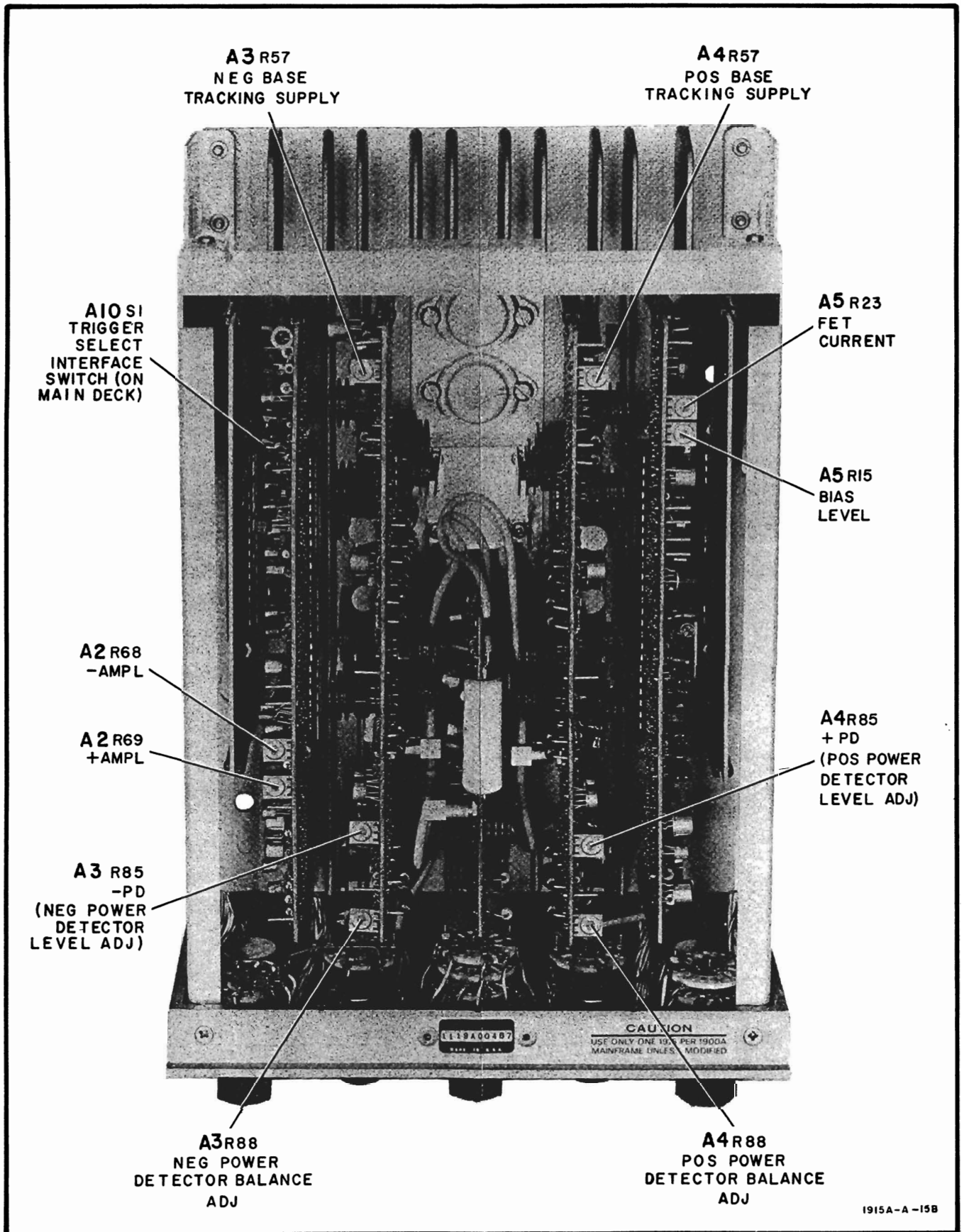

Figure 5-21. Adjustment Locations

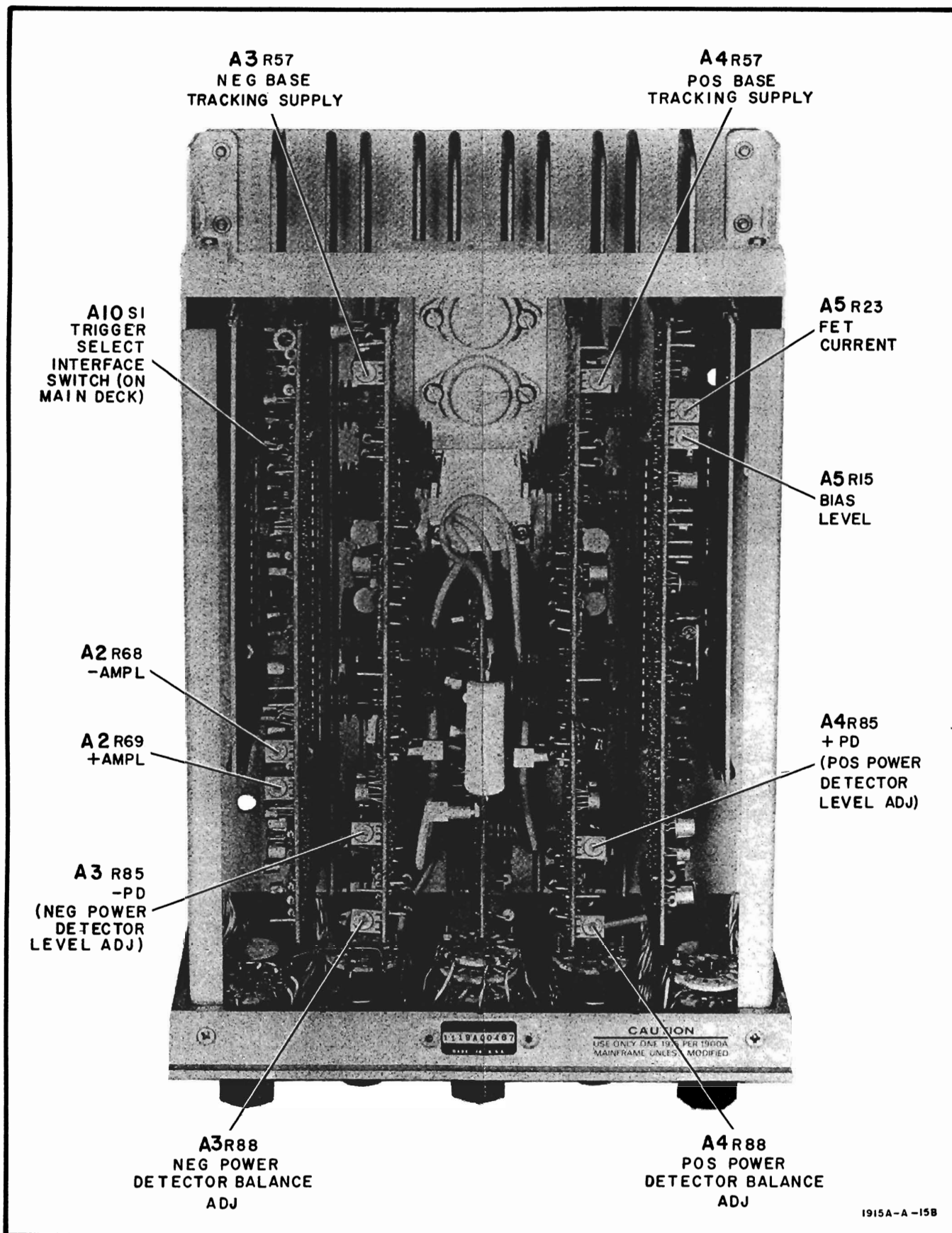

Figure 5-21. Adjustment Locations

SECTION VI REPLACEABLE PARTS

6-1. INTRODUCTION.

6-2. This section contains information for ordering replacement parts. The abbreviations used in the parts list are described in Table 6-1. Table 6-2 lists the parts in alphanumeric order by reference designator and includes the manufacturer and manufacturer's part number. Table 6-3 contains the list of manufacturer's codes.

6-3. ORDERING INFORMATION.

6-4. To obtain replacement parts from Hewlett-Packard, address order or inquiry to the nearest Hewlett-Packard Sales/Service Office and supply the following information:

- a. Instrument model and serial number.
- b. HP Part Number of item(s).
- c. Quantity of part(s) desired.
- d. Reference designator of part(s).

6-5. To order a part not listed in the table, provide the following information:

- a. Instrument model and serial number.
- b. Description of the part, including function and location in the instrument.
- c. Quantity desired.

Table 6-1. Abbreviations for Replaceable Parts List

<p>A = ampere(s) ASSY = assembly</p> <p>BD = board(s) BH = binder head BP = bandpass</p> <p>C = centi (10^{-2}) CAR = carbon CCW = counterclockwise CER = ceramic CMO = cabinet mount only COAX = coaxial COEF = coefficient COMP = composition CONN = connector(s) CRT = cathode-ray tube CW = clockwise</p> <p>D = deci (10^{-1}) DEPC = deposited carbon DP = double pole DT = double throw</p> <p>ELECT = electrolytic ENCAP = encapsulated EXT = external</p> <p>F = farad(s) FET = field-effect transistor(s) FH = flat head FIL H = fillister head FXD = fixed</p> <p>G = giga (10^9) GE = germanium GL = glass</p>	<p>GRD = ground(ed)</p> <p>H = henry(ies) HG = mercury HP = Hewlett-Packard HZ = hertz</p> <p>IF = intermediate freq. IMPG = impregnated INCD = incandescent INCL = include(s) INS = insulation(ed) INT = internal</p> <p>K = kilo (10^3) KG = kilogram</p> <p>LB = pound(s) LH = left hand LIN = linear taper LOG = logarithmic taper LPF = low-pass filter(s) LVR = lever</p> <p>M = milli (10^{-3}) MEG = mega (10^6) MET FILM = metal film MET OX = metal oxide MFR = manufacturer MINAT = miniature MOM = momentary MTG = mounting MY = mylar</p> <p>N = nano (10^{-9}) N/C = normally closed NE = neon N/O = normally open</p>	<p>NPO = negative positive zero (zero temperature coefficient) NPN = negative-positive-negative NSR = not separately replaceable</p> <p>OBD = order by description OH = oval head OX = oxide</p> <p>P = peak PC = printed (etched) circuit(s) PF = picofarads PHL = Phillips PIV = peak inverse voltage(s) PNP = positive-negative-positive P/O = part of PORC = porcelain POS = position(s) POT = potentiometer(s) P-P = peak-to-peak PRGM = program PS = polystyrene PWV = peak working voltage</p> <p>RECT = rectifier(s) RF = radio frequency RFI = radio frequency interference RH = round head or right hand RMO = rack mount only RMS = root mean square</p>	<p>RWV = reverse working voltage</p> <p>S-B = slow-blow SCR = silicon controlled rectifier SE = selenium SEC = second(s) SECT = section(s) SI = silicon SIL = silver SL = slide SP = single pole SPL = special ST = single throw STD = standard</p> <p>TA = tantalum TD = time delay TFL = teflon TGL = toggle THYR = thyristor TI = titanium TNLDIO = tunnel diode(s) TOL = tolerance TRIM = trimmer</p> <p>U = micro (10^{-6})</p> <p>V = volts VAR = variable VDCW = dc working volt(s)</p> <p>W = watt(s) W/ = with WIV = working inverse voltage W/O = without WW = wirewound</p>
--	--	---	--

Table 6-2. Replaceable Parts

Reference Designation	HP Part Number	Qty	Description	Mfr Code	Mfr Part Number
A1			NOT ASSIGNED		
A2	01915-66513	1	ASSY:WIDTH CONTROL & AMPLITUDE VERNIER	28480	01915-66513
A2C1	0180-2204	2	C:FXD ELECT 10 UF 20% 10VDCW	37942	TIM106M010POW
A2C2	0180-2203	15	C:FXD ELECT 1.0 UF 20% 35VDCW	37942	TIM105M035POW
A2C3			NOT ASSIGNED		
A2C4	0180-2203		C:FXD ELECT 1.0 UF 20% 35VDCW	37942	TIM105M035POW
A2C5	0160-2265	1	C:FXD CER 22 PF 5% 500VDCW	72982	301-NPC-22PF
A2C6	0160-2205	1	C:FXD MICA 120 PF 5%	28480	0160-2205
A2C7			NOT ASSIGNED		
A2C8	0160-0258	1	C:FXD MY 0.0015 UF 10% 200VDCW	56289	192P15292-PTS
A2C9	0160-0154	1	C:FXD MY 0.015 UF 10% 200 VDCW	56289	192P15392-PTS
A2C10	0180-0216	1	C:FXD ELECT 0.15 UF 10% 35VDCW	28480	0180-0216
A2C11	0180-0347	1	C:FXD ELECT 1.5 UF 10% 35VDCW	28480	0180-0347
A2C12	0180-2195	1	C:FXD ELECT 15 UF 10% 35VDCW	28480	0180-2195
A2C13	0180-2203		C:FXD ELECT 1.0 UF 20% 35VDCW	37942	TIM105M035POW
A2C14	0180-2204		C:FXD ELECT 10 UF 20% 10VDCW	37942	TIM106M010POW
A2C15	0180-2203		C:FXD ELECT 1.0 UF 20% 35VDCW	37942	TIM105M035POW
A2C16	0180-2203		C:FXD ELECT 1.0 UF 20% 35VDCW	37942	TIM105M035POW
A2C17	0150-C053	49	C:FXD CER 0.01 UF +80-20% 100VDCW	91418	TA
A2C18	0150-0693		C:FXD CER 0.01 UF +80-20% 100VDCW	91418	TA
A2CR1	1901-0513	1	DIODE:SILICON DUAL 100 MV	04713	SSD 101
A2CR2	1901-004C	19	DIODE:SILICON 30MA 30WV	07263	FDG1088
A2CR3	1901-004C		DIODE:SILICON 30MA 30WV	07263	FDG1088
A2CR4	1901-0347	1	DIODE:SILICON 8V HOT CARRIER	28480	1901-0347
A2CR5			NOT ASSIGNED		
A2CR6	1901-005C	33	DIODE:SI 200 MA AT 1V	07263	FDA 6308
A2CR7	1901-004C		DIODE:SILICON 30MA 30WV	07263	FDG1088
A2CR8	1901-005C		DIODE:SI 200 MA AT 1V	07263	FDA 6308
A2CR9	1901-005C		DIODE:SI 200 MA AT 1V	07263	FDA 6308
A2CR10	1901-005C		DIODE:SI 200 MA AT 1V	07263	FDA 6308
A2CR11	1901-005C		DIODE:SI 200 MA AT 1V	07263	FDA 6308
A2CR12	1901-005C		DIODE:SI 200 MA AT 1V	07263	FDA 6308
A2CR13	1901-005C		DIODE:SI 200 MA AT 1V	07263	FDA 6308
A2CR14	1901-004C		DIODE:SILICON 30MA 30WV	07263	FDG1088
A2CR15	1901-005C		DIODE:SI 200 MA AT 1V	07263	FDA 6308
A2CR16	1901-005C		DIODE:SI 200 MA AT 1V	07263	FDA 6308
A2CR17	1901-005C		DIODE:SI 200 MA AT 1V	07263	FDA 6308
A2CR18	1901-005C		DIODE:SI 200 MA AT 1V	07263	FDA 6308
A2CR19	1901-004C		DIODE:SILICON 30MA 30WV	07263	FDG1088
A2CR20	1901-004C		DIODE:SILICON 30MA 30WV	07263	FDG1088
A2CR21	1901-004C		DIODE:SILICON 30MA 30WV	07263	FDG1088
A2CR22	1901-004C		DIODE:SILICON 30MA 30WV	07263	FDG1088
A2CR23	1901-004C		DIODE:SILICON 30MA 30WV	07263	FDG1088
A2CR24	1901-004C		DIODE:SILICON 30MA 30WV	07263	FDG1088
A2CR25	1901-004C		DIODE:SILICON 30MA 30WV	07263	FDG1088
A2CR26	1901-004C		DIODE:SILICON 30MA 30WV	07263	FDG1088
A2CR27	1901-004C		DIODE:SILICON 30MA 30WV	07263	FDG1088
A2CR28	1901-005C		DIODE:SI 200 MA AT 1V	07263	FDA 6308
A2CR29	1901-005C		DIODE:SI 200 MA AT 1V	07263	FDA 6308
A2MP1	1205-0226	2	HEAT SINK:SEMICON FOR T0-5 CASE (A2Q35)	13103	11158
A2Q1	1854-C052	2	TSTR:SI NPN	80131	2N3563
A2Q2	1853-C203	4	TSTR:SI PNP	28480	1853-0203
A2Q3	1853-C203		TSTR:SI PNP	28480	1853-0203
A2Q4	1854-C052		TSTR:SI NPN	80131	2N3563
A2Q5	1854-C015	5	TSTR:SI NPN	28480	1854-0019
A2Q6	1854-C015		TSTR:SI NPN	28480	1854-0019
A2Q7	1854-C015		TSTR:SI NPN	28480	1854-0019
A2Q8	1853-0020	2	TSTR:SI PNP(SELECTED FROM 2N3702)	28480	1853-0020
A2Q9	1853-0020		TSTR:SI PNP(SELECTED FROM 2N3702)	28480	1853-0020
A2Q10	1853-0011	1	TSTR:SI PNP	28480	1853-0011
A2Q11	1854-0215	32	TSTR:SI NPN	80131	2N3904
A2Q12	1853-0010	7	TSTR:SI PNP(SELECTED FROM 2N3251)	28480	1853-0010
A2Q13	1854-C365	6	TSTR:SI NPN	80131	2N4410
A2Q14	1854-C365		TSTR:SI NPN	80131	2N4410
A2Q15	1854-0215		TSTR:SI NPN	80131	2N3904
A2Q16	1854-0215		TSTR:SI NPN	80131	2N3904
A2Q17	1854-0215		TSTR:SI NPN	80131	2N3904
A2Q18	1854-0215		TSTR:SI NPN	80131	2N3904
A2Q19	1854-0215		TSTR:SI NPN	80131	2N3904
A2Q20	1854-0215		TSTR:SI NPN	80131	2N3904
A2Q21	1853-C010		TSTR:SI PNP(SELECTED FROM 2N3251)	28480	1853-0010
A2Q22	1854-C023	9	TSTR:SI NPN(SELECTED FROM 2N2484)	28480	1854-0023
A2Q23	1853-C012		TSTR:SI PNP	80131	2N2904A
A2Q24	1853-C010	1	TSTR:SI PNP(SELECTED FROM 2N3251)	28480	1853-0010
A2Q25	1854-C023		TSTR:SI NPN(SELECTED FROM 2N2484)	28480	1854-0023
A2Q26	1853-0036	6	TSTR:SI PNP	80131	2N3906

See introduction to this section for ordering information

Table 6-2. Replaceable Parts (Cont'd)

Reference Designation	HP Part Number	Qty	Description	Mfr Code	Mfr Part Number
A2Q27	1854-0215		TSTR:SI NPN	80131	2N3904
A2Q28	1854-0234	1	TSTR:SI NPN	80131	2N3440
A2Q29	1853-0037	2	TSTR:SI PNP	04713	SS 2109
A2Q30	1853-0034	5	TSTR:SI PNP(SELECTED FROM 2N3251)	28480	1853-0034
A2Q31	1854-0023		TSTR:SI NPN(SELECTED FROM 2N2484)	28480	1854-0023
A2Q32	1853-0210	10	TSTR:SI PNP	28480	1853-0210
A2Q33	1854-0362	9	TSTR:SI NPN	28480	1854-0362
A2Q34	1853-0010		TSTR:SI PNP(SELECTED FROM 2N3251)	28480	1853-0010
A2Q35	1854-0362		TSTR:SI NPN	28480	1854-0362
A2Q36	1853-0006	3	TSTR:SI PNP	80131	2N3134
A2Q37	1855-0057	2	TSTR:SI FET N-CHANNEL	28480	1855-0057
A2R1	0758-0124	1	R:FXD FLM 51 OHM 5% 1/8W	28480	0758-0124
A2R2	0698-3378	10	R:FXD CARBON 51 OHM 5% 1/8W	28480	0698-3378
A2R3	0757-0934	5	R:FXD FLM 2.7K OHM 2% 1/8W	28480	0757-0934
A2R4	0675-2211	1	R:FXD COMP 220 OHM 10% 1/8W	01121	8B 2211
A2R5	0698-3378		R:FXD CARBON 51 OHM 5% 1/8W	28480	0698-3378
A2R6	0757-0924	13	R:FXD MET FLM 1K OHM 2% 1/8W	28480	0757-0924
A2R7	0758-0070	2	R:FXD MET OX 1200 OHM 5% 1/2W	28480	0758-0070
A2R8	0698-3378		R:FXD CARBON 51 OHM 5% 1/8W	28480	0698-3378
A2R9	0758-0004	1	R:FXD MET OX 2.7K OHM 5% 1/4W	28480	0758-0004
A2R10	0761-0021	1	R:FXD MET OX 1000 OHM 5% 1W	28480	0761-0021
A2R11	0757-0900	1	R:FXD MET FLM 100 OHM 2% 1/8W	28480	0757-0900
A2R12	0757-0926	6	R:FXD FLM 1.2K OHM 2% 1/8W	28480	0757-0926
A2R13	0757-0942	11	R:FXD FLM 5.6K OHM 2% 1/8W	28480	0757-0942
A2R14	0757-0904	4	R:FXD FLM 150 OHM 2% 1/8W	28480	0757-0904
A2R15	0698-7096	5	R:FXD COMP 10 OHM 10% 1/8W	01121	8B 1001
A2R16			NOT ASSIGNED		
A2R17	0757-0924		R:FXD MET FLM 1K OHM 2% 1/8W	28480	0757-0924
A2R18			NOT ASSIGNED		
A2R19			NOT ASSIGNED		
A2R20	0757-0918	1	R:FXD FLM 560 OHM 2% 1/8W	28480	0757-0918
A2R21	0757-0924		R:FXD MET FLM 1K OHM 2% 1/8W	28480	0757-0924
A2R22	0757-0904		R:FXD FLM 150 OHM 2% 1/8W	28480	0757-0904
A2R23	0757-0026		R:FXD FLM 1.2K OHM 2% 1/8W	28480	0757-0926
A2R24	0757-0926		R:FXD FLM 1.2K OHM 2% 1/8W	28480	0757-0926
A2R25	0761-0054	1	R:FXD MET OX 330 OHM 5% 1W	28480	0761-0054
A2R26	0757-0934		R:FXD FLM 2.7K OHM 2% 1/8W	28480	0757-0934
A2R27	0757-0948	16	R:FXD FLM 10K OHM 2% 1/8W	28480	0757-0948
A2R28	0757-0952	3	R:FXD FLM 15K OHM 2% 1/8W	28480	0757-0952
A2R29	0757-0946	3	R:FXD FLM 8.2K OHM 2% 1/8W	28480	0757-0946
A2R30	0757-0948		R:FXD FLM 10K OHM 2% 1/8W	28480	0757-0948
A2R31	0757-0924		R:FXD MET FLM 1K OHM 2% 1/8W	28480	0757-0924
A2R32	0757-0942		R:FXD FLM 5.6K OHM 2% 1/8W	28480	0757-0942
A2R33	0698-4073	7	R:FXD COMP 1.0 MEGOHM 10% 1/8W	01121	8B 1051
A2R34	0658-4073		R:FXD COMP 1.0 MEGOHM 10% 1/8W	01121	8B 1051
A2R35	0698-4073		R:FXD COMP 1.0 MEGOHM 10% 1/8W	01121	8B 1051
A2R36	0658-4073		R:FXD COMP 1.0 MEGOHM 10% 1/8W	01121	8B 1051
A2R37	0698-4073		R:FXD COMP 1.0 MEGOHM 10% 1/8W	01121	8B 1051
A2R38	0698-4073		R:FXD COMP 1.0 MEGOHM 10% 1/8W	01121	8B 1051
A2R39	0675-1021	18	R:FXD CARBON 1K OHM 10% 1/8W	28480	0675-1021
A2R40	0675-1021		R:FXD CARBON 1K OHM 10% 1/8W	28480	0675-1021
A2R41	0675-1021		R:FXD CARBON 1K OHM 10% 1/8W	28480	0675-1021
A2R42	0675-1021		R:FXD CARBON 1K OHM 10% 1/8W	28480	0675-1021
A2R43	0675-1021		R:FXD CARBON 1K OHM 10% 1/8W	28480	0675-1021
A2R44	0675-1021		R:FXD CARBON 1K OHM 10% 1/8W	28480	0675-1021
A2R45	0698-5422	11	R:FXD COMP 5600 OHM 10% 1/8W	01121	8B 5621
A2R46	0698-5422		R:FXD COMP 5600 OHM 10% 1/8W	01121	8B 5621
A2R47	0698-5422		R:FXD COMP 5600 OHM 10% 1/8W	01121	8B 5621
A2R48	0698-5422		R:FXD COMP 5600 OHM 10% 1/8W	01121	8B 5621
A2R49	0698-5422		R:FXD COMP 5600 OHM 10% 1/8W	01121	8B 5621
A2R50	0698-5422		R:FXD COMP 5600 OHM 10% 1/8W	01121	8B 5621
A2R51	0698-3150	1	R:FXD MET FLM 2.37K OHM 1% 1/8W	28480	0698-3150
A2R52	0757-0431	1	R:FXD MET FLM 2.43K OHM 1% 1/8W	28480	0757-0431
A2R53	0757-0412	1	R:FXD MET FLM 365 OHM 1% 1/8W	28480	0757-0412
A2R54	0757-0088	3	R:FXD FLM 620 OHM 2% 1/4W	28480	0757-0088
A2R55	0757-0926		R:FXD FLM 1.2K OHM 2% 1/8W	28480	0757-0926
A2R56	0757-0088		R:FXD FLM 620 OHM 2% 1/4W	28480	0757-0088
A2R57	0757-0914	1	R:FXD FLM 390 OHM 2% 1/8W	28480	0757-0914
A2R58	0757-0088		R:FXD FLM 620 OHM 2% 1/4W	28480	0757-0088
A2R59	0757-0930	3	R:FXD FLM 1.8K OHM 2% 1/8W	28480	0757-0930
A2R60	0757-0928	4	R:FXD FLM 1.5K OHM 2% 1/8W	28480	0757-0928
A2R61	0757-0080	1	R:FXD FLM 4700 OHM 2% 1/4W	28480	0757-0080
A2R62	0757-0924		R:FXD MET FLM 1K OHM 2% 1/8W	28480	0757-0924
A2R63	0757-0955	4	R:FXD FLM 20K OHM 2% 1/8W	28480	0757-0955
A2R64	0757-0924		R:FXD MET FLM 1K OHM 2% 1/8W	28480	0757-0924

See introduction to this section for ordering information

Table 6-2. Replaceable Parts (Cont'd)

Reference Designation	HP Part Number	Qty	Description	Mfr Code	Mfr Part Number
A2R65	0757-C955		R:FXD FLM 20K OHM 2% 1/8W	28480	0757-0955
A2R66	0757-C945	1	R:FXD FLM 7.5K OHM 2% 1/8W	28480	0757-0945
A2R67	0757-C928		R:FXD FLM 1.5K OHM 2% 1/8W	28480	0757-0928
A2R68	2100-2574	2	R:VAR CERMET 500 OHM 10% LIN 1/2W	28480	2100-2574
A2R69	2100-2574		R:VAR CERMET 500 OHM 10% LIN 1/2W	28480	2100-2574
A2R70	0757-C915	3	R:FXD FLM 620 OHM 2% 1/8W	28480	0757-0919
A2R71	0757-C915		R:FXD FLM 620 OHM 2% 1/8W	28480	0757-0919
A2R72	0757-CC74	2	R:FXD FLM 430 OHM 2% 1/4W	28480	0757-0074
A2R73	0757-CC74		R:FXD FLM 430 OHM 2% 1/4W	28480	0757-0074
A2R74	0757-C942		R:FXD FLM 5.6K OHM 2% 1/8W	28480	0757-0942
A2R75	0757-C942		R:FXD FLM 5.6K OHM 2% 1/8W	28480	0757-0942
A2R76	0757-C923	3	R:FXD FLM 910 OHM 2% 1/8W	28480	0757-0923
A2R77	0757-C924		R:FXD MET FLM 1K OHM 2% 1/8W	28480	0757-0924
A2R78	0757-C898	2	R:FXD FLM 82 OHM 2% 1/8W	28480	0757-C898
A2R79	0757-C917	9	R:FXD FLM 510 OHM 2% 1/8W	28480	0757-0917
A2R80	0757-C942		R:FXD FLM 5.6K OHM 2% 1/8W	28480	0757-0942
A2R81	0811-2641	2	R:FXD WM 65 OHM 1% 3W	28480	0811-2641
A2R82	0758-C054	1	R:FXD MET OX 330 OHM 5% 1/2W	28480	0758-0054
A2R83	0758-CG70		R:FXD MET OX 1200 OHM 5% 1/2W	28480	0758-0070
A2R84	0757-C931	18	R:FXD FLM 2K OHM 2% 1/8W	28480	0757-0931
A2R85	0757-C930		R:FXD FLM 1.8K OHM 2% 1/8W	28480	0757-0930
A2R86	0757-C948		R:FXD FLM 10K OHM 2% 1/8W	28480	0757-0948
A2R87	0757-C948		R:FXD FLM 10K OHM 2% 1/8W	28480	0757-0948
A2R88	0698-7184	1	R:FXD FLM 220K OHM 2% 1/8W	28480	0698-7184
A2R89	0658-702E	2	R:FXD CGMP 27 OHM 10% 1/8W	01121	BB 2701
A2R90	0758-C00E	2	R:FXD MET OX FLM 390 OHM 5% 1/4W	28480	0758-0008
A2R91	0757-C915		R:FXD FLM 620 OHM 2% 1/8W	28480	0757-0919
A2R92	0684-4701	1	R:FXD CGMP 47 OHM 10% 1/4W	01121	CB 4701
A2TP1	0360-C124	24	TERMINAL:SOLDER LUG	28480	0360-0124
A2TP2	0360-C124		TERMINAL:SOLDER LUG	28480	0360-0124
A2TP3	0360-C124		TERMINAL:SOLDER LUG	28480	0360-0124
A2TP4	0360-C124		TERMINAL:SOLDER LUG	28480	0360-0124
A2TP5	0360-C124		TERMINAL:SOLDER LUG	28480	0360-0124
A2TP6	0360-C124		TERMINAL:SOLDER LUG	28480	0360-0124
A2TP7	0360-C124		TERMINAL:SOLDER LUG	28480	0360-0124
A2VR1	1902-004E	3	DIODE:BREAKDOWN 6.81V 5%	04713	S210939-134
A2VR2	1902-0074	1	DIODE:BREAKDOWN 7.15V 5%	04713	S210939-140
A2VR3	1902-3203	4	DIODE BREAKDOWN:SILICON 14.7V 5%	28480	1902-3203
A2VR4	1902-3172	3	DIODE BREAKDOWN:11.0V 2%	28480	1902-3172
A2VR5	1902-0037	1	DIODE BREAKDOWN:9.09V 10%	28480	1902-0037
A2VR6	1902-004E		DIODE:BREAKDOWN 6.81V 5%	04713	S210939-134
A3	01915-66523	1	ASSY:NEGATIVE OUTPUT/POWER DETECTOR	28480	01915-66523
A3C1	0180-22C1	8	C:FXD ELECT 0.68 UF 20% 75VDCW	56289	1500684X0075A2-DYS
A3C2	0150-CC53		C:FXD CER 0.01 UF +80-20% 100VDCW	9141E	TA
A3C3	0150-CC53		C:FXD CER 0.01 UF +80-20% 100VDCW	9141E	TA
A3C4	0150-CC53		C:FXD CER 0.01 UF +80-20% 100VDCW	9141E	TA
A3C5	0180-C230	2	C:FXD ELECT 1.0 UF 20% 50VDCW	56289	1500105X0050A2-DYS
A3C6	0180-C251	8	C:FXD ELECT 1.0 UF 10% 35VDCW	56289	1500105X9035A2-DYS
A3C7	0150-CC53		C:FXD CER 0.01 UF +80-20% 100VDCW	9141E	TA
A3C8	0150-CC53		C:FXD CER 0.01 UF +80-20% 100VDCW	9141E	TA
A3C9	0150-CC53		C:FXD CER 0.01 UF +80-20% 100VDCW	9141E	TA
A3C10	0180-22C1		C:FXD ELECT 0.68 UF 20% 75VDCW	56289	1500684X0075A2-DYS
A3C11	0150-CC53		C:FXD CER 0.01 UF +80-20% 100VDCW	9141E	TA
A3C12	0150-CC53		C:FXD CER 0.01 UF +80-20% 100VDCW	9141E	TA
A3C13	0150-CC53		C:FXD CER 0.01 UF +80-20% 100VDCW	9141E	TA
A3C14	0150-CC53		C:FXD CER 0.01 UF +80-20% 100VDCW	9141E	TA
A3C15	0150-CC53		C:FXD CER 0.01 UF +80-20% 100VDCW	9141E	TA
A3C16	0150-C116	4	C:FXD CER 47 PF 10% 500VDCW	72982	301-000-U2J0 470K
A3C17	0150-C116		C:FXD CER 47 PF 10% 500VDCW	72982	301-000-U2J0 470K
A3C18	0150-C116		C:FXD CER 47 PF 10% 500VDCW	72982	301-000-U2J0 470K
A3C19	0150-C116		C:FXD CER 47 PF 10% 500VDCW	72982	301-000-U2J0 470K
A3C20	0160-22E3	1	C:FXD CER 18 PF 5% 500VDCW	72982	301-000-C0G0-180J
A3C21	0150-CC53		C:FXD CER 0.01 UF +80-20% 100VDCW	9141E	TA
A3C22	0150-CC53		C:FXD CER 0.01 UF +80-20% 100VDCW	9141E	TA
A3C23	0150-CC53		C:FXD CER 0.01 UF +80-20% 100VDCW	9141E	TA
A3C24	0150-CC53		C:FXD CER 0.01 UF +80-20% 100VDCW	9141E	TA
A3C25	0150-CC53		C:FXD CER 0.01 UF +80-20% 100VDCW	9141E	TA
A3C26	0180-22C1		C:FXD ELECT 0.68 UF 20% 75VDCW	56289	1500684X0075A2-DYS
A3C27	0150-CC53		C:FXD CER 0.01 UF +80-20% 100VDCW	9141E	TA
A3C28	0150-CC53		C:FXD CER 0.01 UF +80-20% 100VDCW	9141E	TA
A3C29	0180-C251		C:FXD ELECT 1.0 UF 10% 35VDCW	56289	1500105X9035A2-DYS
A3C30	0150-CC53		C:FXD CER 0.01 UF +80-20% 100VDCW	9141E	TA
A3C31	0180-C251		C:FXD ELECT 1.0 UF 10% 35VDCW	56289	1500105X9035A2-DYS
A3C32	0150-CC53		C:FXD CER 0.01 UF +80-20% 100VDCW	9141E	TA
A3C33	0180-2201		C:FXD ELECT 0.68 UF 20% 75VDCW	56289	1500684X0075A2-DYS

See introduction to this section for ordering information

Table 6-2. Replaceable Parts (Cont'd)

Reference Designation	HP Part Number	Qty	Description	Mfr Code	Mfr Part Number
A3C34	0150-0053		C:FXD CER 0.01 UF +80-20% 100VDCW	91418	TA
A3C35	0140-0151	2	C:FXD MICA 820 PF 2%	28480	0140-0151
A3C36			NOT ASSIGNED		
A3CR1	1901-0514	16	DIODE:SI 15 WV 125 MA	28480	1901-0514
A3CR2	1901-0514		DIODE:SI 15 WV 125 MA	28480	1901-0514
A3CR3	1901-0514		DIODE:SI 15 WV 125 MA	28480	1901-0514
A3CR4	1901-0514		DIODE:SI 15 WV 125 MA	28480	1901-0514
A3CR5	1901-0514		DIODE:SI 15 WV 125 MA	28480	1901-0514
A3CR6	1901-0514		DIODE:SI 15 WV 125 MA	28480	1901-0514
A3CR7	1901-0514		DIODE:SI 15 WV 125 MA	28480	1901-0514
A3CR8	1901-0514		DIODE:SI 15 WV 125 MA	28480	1901-0514
A3CR9	1901-0050		DIODE:SI 200 MA AT 1V	07263	FDA 6308
A3CR10	1901-0050		DIODE:SI 200 MA AT 1V	07263	FDA 6308
A3CR11	1901-0050		DIODE:SI 200 MA AT 1V	07263	FDA 6308
A3CR12	1901-0050		DIODE:SI 200 MA AT 1V	07263	FDA 6308
A3CR13	1901-0050		DIODE:SI 200 MA AT 1V	07263	FDA 6308
A3CR14	1901-0510	2	DIODE:SI 60 WV 10MA	28480	1901-0510
A3CR15	1901-0026	1	DIODE:SILICON 0.75A 200PIV	04713	SR1358-8
A3CR16	1901-0175	4	DIODE:SILICON 15WV	28480	1901-0179
A3CR17	1901-0175		DIODE:SILICON 15WV	28480	1901-0179
A3J1	1250-0257	5	CONNECTOR:RF 50 OHM PC MOUNT	28480	1250-0257
A3J2	1250-0257		CONNECTOR:RF 50 OHM PC MOUNT	28480	1250-0257
A3L1	9100-2256	2	COIL/CHCKE 0.56 UH 10%	13019	09-4426-3K
A3L2	9100-2276	16	COIL/CHCKE 100 UH 10%	28480	9100-2276
A3L3	9100-2276		COIL/CHCKE 100 UH 10%	28480	9100-2276
A3L4	9100-2276		COIL/CHCKE 100 UH 10%	28480	9100-2276
A3L5	9100-2276		COIL/CHCKE 100 UH 10%	28480	9100-2276
A3L6	9100-2276		COIL/CHCKE 100 UH 10%	28480	9100-2276
A3L7	9100-2276		COIL/CHCKE 100 UH 10%	28480	9100-2276
A3L8	9100-2276		COIL/CHCKE 100 UH 10%	28480	9100-2276
A3L9	9100-2252	2	COIL/CHCKE 0.27 UH 10%	28480	9100-2252
A3MP1	1205-0073	18	HEAT SINK:DUAL (A3Q21)	13103	22108
A3MP2	1205-0073		HEAT SINK:DUAL (A3Q15)	13103	22108
A3MP3	1205-0073		HEAT SINK:DUAL (A3Q16)	13103	22108
A3MP4	1205-0073		HEAT SINK:DUAL (A3Q9)	13103	22108
A3MP5	1205-0231	16	HEAT SINK (A3Q12)	28480	1205-0231
A3MP6	1205-0231		HEAT SINK (A3Q14)	28480	1205-0231
A3MP7	1205-0073		HEAT SINK:DUAL (A3Q7)	13103	22108
A3MP8	1205-0073		HEAT SINK:DUAL (A3Q17)	13103	22108
A3MP9	1205-0095	8	HEAT SINK:TRANSISTOR (A3Q19)	13103	22258
A3MP10	1205-0095		HEAT SINK:TRANSISTOR (A3Q18)	13103	22258
A3MP11	1205-0073		HEAT SINK:DUAL (A3Q8)	13103	22108
A3MP12	1205-0073		HEAT SINK:DUAL (A3Q10)	28480	1205-0231
A3MP13	1205-0231		HEAT SINK (A3Q13)	28480	1205-0231
A3MP14	1205-0231		HEAT SINK (A3Q11)	28480	1205-0231
A3MP15	1205-0073		HEAT SINK:DUAL (A3Q2)	13103	22108
A3MP16	1205-0231		HEAT SINK (A3Q1)	28480	1205-0231
A3Q1	1853-0209	9	TSTR:SI PNP	28480	1853-0209
A3Q2	1853-0201	3	TSTR:SI PNP	28480	1853-0201
A3Q3	1854-0241	2	TSTR:SI NPN	28480	1854-0241
A3Q4	1853-0034		TSTR:SI PNP(SELECTED FROM 2N3251)	28480	1853-0034
A3Q5	1854-0233	3	TSTR:SI NPN	80131	2N3866
A3Q6	1853-0201		TSTR:SI PNP	28480	1853-0201
A3Q7	1854-0363	6	TSTR:SI NPN	80131	2N5262
A3Q8	1854-0363		TSTR:SI NPN	80131	2N5262
A3Q9	1854-0363		TSTR:SI NPN	80131	2N5262
A3Q10	1854-0363		TSTR:SI NPN	80131	2N5262
A3Q11	1854-0364	4	TSTR:SI NPN	28480	1854-0364
A3Q12	1854-0364		TSTR:SI NPN	28480	1854-0364
A3Q13	1854-0364		TSTR:SI NPN	28480	1854-0364
A3Q14	1854-0364		TSTR:SI NPN	28480	1854-0364
A3Q15	1854-0362		TSTR:SI NPN	28480	1854-0362
A3Q16	1854-0362		TSTR:SI NPN	28480	1854-0362
A3Q17	1854-0362		TSTR:SI NPN	28480	1854-0362
A3Q18	1854-0362		TSTR:SI NPN	28480	1854-0362
A3Q19	1854-0362		TSTR:SI NPN	28480	1854-0362
A3Q20	1854-0023		TSTR:SI NPN(SELECTED FROM 2N2484)	28480	1854-0023
A3Q21	1854-0363		TSTR:SI NPN	80131	2N5262
A3Q22	1854-0365		TSTR:SI NPN	80131	2N4410
A3Q23	1853-0010		TSTR:SI PNP(SELECTED FROM 2N3251)	28480	1853-0010
A3Q24	1854-0023		TSTR:SI NPN(SELECTED FROM 2N2484)	28480	1854-0023
A3Q25	1854-0023		TSTR:SI NPN(SELECTED FROM 2N2484)	28480	1854-0023
A3Q26	1853-0010		TSTR:SI PNP(SELECTED FROM 2N3251)	28480	1853-0010
A3Q27	1854-0215		TSTR:SI NPN	80131	2N3904

See introduction to this section for ordering information

Table 6-2. Replaceable Parts (Cont'd)

Reference Designation	HP Part Number	Qty	Description	Mfr Code	Mfr Part Number
A3Q28	1854-C215	1	TSTR:SI NPN	80131	2N3904
A3Q29	5C80-C499		TSTR:SI PNP DUAL(MATCHED PAIR)	28480	5C80-C499
A3Q30			N.S.R. PART OF A3Q29(MATCHED PAIR)		
A3Q31	1854-C215	7	TSTR:SI NPN	80131	2N3904
A3R1	0698-3113		R:FXD CARBON 100 OHM 5% 1/8W	28480	0698-3113
A3R2	0757-C181	2	R:FXD MET OX 150 OHM 2% 1/2W	28480	0757-0181
A3R3	0698-5569	2	R:FXD MET OX 1500 OHM 2% 1W	28480	0698-5569
A3R4	0698-3111	10	R:FXD COMP 30 OHM 5% 1/8W	28480	0698-3111
A3R5	0760-0014	2	R:FXD MET OX 1K OHM 2% 1W	28480	0760-0014
A3R6	0758-0014	3	R:FXD MET FLM 180 OHM 5% 1/2W	28480	0758-0014
A3R7	0698-3113	16	R:FXD CARBON 100 OHM 5% 1/8W	28480	0698-3113
A3R8	0698-3113		R:FXD CARBON 100 OHM 5% 1/8W	28480	0698-3113
A3R9	0757-C934		R:FXD FLM 2.7K OHM 2% 1/8W	28480	0757-0934
A3R10	0757-C904		R:FXD FLM 150 OHM 2% 1/8W	28480	0757-0904
A3R11	0698-3376		R:FXD CARBON 51 OHM 5% 1/8W	28480	0698-3376
A3R12	0698-3376		R:FXD CARBON 51 OHM 5% 1/8W	28480	0698-3376
A3R13	0698-7056		R:FXD COMP 10 OHM 10% 1/8W	01121	BB 1001
A3R14	0698-7056		R:FXD COMP 10 OHM 10% 1/8W	01121	BB 1001
A3R15	0698-3111		R:FXD COMP 30 OHM 5% 1/8W	28480	0698-3111
A3R16	0698-3111		R:FXD COMP 30 OHM 5% 1/8W	28480	0698-3111
A3R17	0698-3111		R:FXD COMP 30 OHM 5% 1/8W	28480	0698-3111
A3R18	0698-3111	R:FXD COMP 30 OHM 5% 1/8W	28480	0698-3111	
A3R19	0698-7033	R:FXD MET OX 47 OHM 2% 1W	28480	0698-7033	
A3R20	0698-7033	R:FXD MET OX 47 OHM 2% 1W	28480	0698-7033	
A3R21	0698-7033	R:FXD MET OX 47 OHM 2% 1W	28480	0698-7033	
A3R22	0698-7033	R:FXD MET OX 47 OHM 2% 1W	28480	0698-7033	
A3R23	0698-7033	R:FXD MET OX 47 OHM 2% 1W	28480	0698-7033	
A3R24	0698-7033	R:FXD MET OX 47 OHM 2% 1W	28480	0698-7033	
A3R25	0698-7033	R:FXD MET OX 47 OHM 2% 1W	28480	0698-7033	
A3R26	0698-7033	R:FXD MET OX 47 OHM 2% 1W	28480	0698-7033	
A3R27	0757-C894	4	R:FXD FLM 56 OHM 2% 1/8W	28480	0757-C894
A3R28	0757-C894		R:FXD FLM 56 OHM 2% 1/8W	28480	0757-C894
A3R29	0757-C894		R:FXD FLM 56 OHM 2% 1/8W	28480	0757-C894
A3R30	0757-C894		R:FXD FLM 56 OHM 2% 1/8W	28480	0757-C894
A3R31	0757-C897	2	R:FXD FLM 75 OHM 2% 1/8W	28480	0757-C897
A3R32	0757-C935	3	R:FXD FLM 51K OHM 2% 1/8W	28480	0757-0935
A3R33	0757-C935		R:FXD FLM 3K OHM 2% 1/8W	28480	0757-0935
A3R34	0757-C935		R:FXD FLM 3K OHM 2% 1/8W	28480	0757-0935
A3R35	0757-C935		R:FXD FLM 3K OHM 2% 1/8W	28480	0757-0935
A3R36	0757-C935		R:FXD FLM 3K OHM 2% 1/8W	28480	0757-0935
A3R37	0757-C935		R:FXD FLM 3K OHM 2% 1/8W	28480	0757-0935
A3R38	0757-C935	R:FXD FLM 3K OHM 2% 1/8W	28480	0757-0935	
A3R39	0757-C935	R:FXD FLM 3K OHM 2% 1/8W	28480	0757-0935	
A3R40	0757-C935	R:FXD FLM 3K OHM 2% 1/8W	28480	0757-0935	
A3R41	0757-C935	R:FXD FLM 3K OHM 2% 1/8W	28480	0757-0935	
A3R42	0757-C935	R:FXD FLM 3K OHM 2% 1/8W	28480	0757-0935	
A3R43	0757-C931	16	R:FXD FLM 2K OHM 2% 1/8W	28480	0757-0931
A3R44	0757-C931		R:FXD FLM 2K OHM 2% 1/8W	28480	0757-0931
A3R45	0757-C931		R:FXD FLM 2K OHM 2% 1/8W	28480	0757-0931
A3R46	0757-C931		R:FXD FLM 2K OHM 2% 1/8W	28480	0757-0931
A3R47	0757-C931		R:FXD FLM 2K OHM 2% 1/8W	28480	0757-0931
A3R48	0698-7031		R:FXD MET OX 43 OHM 2% 1W	28480	0698-7031
A3R49	0698-7031	R:FXD MET OX 43 OHM 2% 1W	28480	0698-7031	
A3R50	0698-7031	R:FXD MET OX 43 OHM 2% 1W	28480	0698-7031	
A3R51	0698-7031	R:FXD MET OX 43 OHM 2% 1W	28480	0698-7031	
A3R52	0698-7031	R:FXD MET OX 43 OHM 2% 1W	28480	0698-7031	
A3R53	0698-7031	R:FXD MET OX 43 OHM 2% 1W	28480	0698-7031	
A3R54	0698-7031	R:FXD MET OX 43 OHM 2% 1W	28480	0698-7031	
A3R55	0698-7031	R:FXD MET OX 43 OHM 2% 1W	28480	0698-7031	
A3R56	0757-C946	R:FXD FLM 10K OHM 2% 1/8W	28480	0757-0946	
A3R57	2100-2522	2	R:VAR CERMET 10K OHM 10% LIM 1/2W	28480	2100-2522
A3R58	0757-C939	6	R:FXD FLM 4.3K OHM 2% 1/8W	28480	0757-0939
A3R59	0757-C946		R:FXD FLM 8.2K OHM 2% 1/8W	28480	0757-0946
A3R60	0757-C939	2	R:FXD FLM 4.3K OHM 2% 1/8W	28480	0757-0939
A3R61	0761-C049		R:FXD MET OX 200 OHM 5% 1W	28480	0761-0049
A3R62	0757-C907	2	R:FXD FLM 200 OHM 2% 1/8W	28480	0757-0907
A3R63	0757-C917		R:FXD FLM 510 OHM 2% 1/8W	28480	0757-0917
A3R64	0757-C926	R:FXD FLM 1.2K OHM 2% 1/8W	28480	0757-0926	
A3R65	0698-7187	2	R:FXD COMP 2 MEGOHM 5% 1/8W	01121	BB 2055
A3R66	0698-7185	2	R:FXD COMP 220K OHM 5% 1/8W	01121	BB 2245
A3R67	0757-C948	1	R:FXD FLM 10K OHM 2% 1/8W	28480	0757-0948
A3R68	0757-C962		R:FXD FLM 39K OHM 2% 1/8W	28480	0757-0962
A3R69	0757-C948		R:FXD FLM 10K OHM 2% 1/8W	28480	0757-0948
A3R70	0757-C924		R:FXD MET FLM 1K OHM 2% 1/8W	28480	0757-0924
A3R71	0757-C943		4	R:FXD FLM 6.2K OHM 2% 1/8W	28480

See introduction to this section for ordering information

Table 6-2. Replaceable Parts (Cont'd)

Reference Designation	HP Part Number	Qty	Description	Mfr Code	Mfr Part Number
A3R72	0757-0965	4	R:FXD FLM 51K OHM 2% 1/8W	28480	0757-0965
A3R73	0757-C94E		R:FXD FLM 10K OHM 2% 1/8W	28480	0757-0548
A3R74	0757-094E		R:FXD FLM 10K OHM 2% 1/8W	28480	0757-0948
A3R75	0757-C672		R:FXD FLM 100K OHM 2% 1/8W	28480	0757-C972
A3R76	0757-0972		R:FXD FLM 100K OHM 2% 1/8W	28480	0757-0972
A3R77	0757-C917	4	R:FXD FLM 510 OHM 2% 1/8W	28480	0757-0917
A3R78	0757-C917		R:FXD FLM 510 OHM 2% 1/8W	28480	0757-0917
A3R79	0757-C951		R:FXD FLM 13K OHM 2% 1/8W	28480	0757-C951
A3R80	0757-C951		R:FXD FLM 13K OHM 2% 1/8W	28480	0757-C951
A3R81	0757-C910		R:FXD MET FLM 270 OHM 2% 1/8W	28480	0757-0910
A3R82	0757-0966	2	R:FXD FLM 56K OHM 2% 1/8W	28480	0757-0966
A3R83	0757-C943		R:FXD FLM 6.2K OHM 2% 1/8W	28480	0757-0943
A3R84	0757-C924		R:FXD MET FLM 1K OHM 2% 1/8W	28480	0757-C924
A3R85	2100-2216		R:VAR CERMET 5000 OHM 10% LIN 1/2W	28480	2100-2216
A3R86	0757-C941		R:FXD FLM 5.1K OHM 2% 1/8W	28480	0757-C941
A3R87		2	NOT ASSIGNED		
A3R88	2100-173E		R:VAR FLM 10K OHM 10% LIN 1/2W	28480	2100-1738
A3TP1	0360-0124		TERMINAL:SOLDER LUG	28480	0360-0124
A3TP2	0360-0124		TERMINAL:SOLDER LUG	28480	0360-0124
A3TP3	0360-C124		TERMINAL:SOLDER LUG	28480	0360-0124
A3VR1	1902-0551	4	DIODE BREAKDOWN:6.19V 5%	28480	1902-0551
A3VR2	1902-304E		DIODE BREAKDOWN:SILICON 3.48V 5%	28480	1902-3048
A3VR3	1902-0551		DIODE BREAKDOWN:6.19V 5%	28480	1902-0551
A3VR4	1902-C785		DIODE:BREAKDOWN 9.09V 5%	04713	1N936
A3VR5	1902-0785		DIODE:BREAKDOWN 9.09V 5%	04713	1N936
A3VR6	1902-3203	1	DIODE BREAKDOWN:SILICON 14.7V 5%	28480	1902-3203
A3VR7	1902-3135		DIODE:BREAKDOWN 8.25V 5%	04713	S210939-15E
A3VR8	1902-3172		DIODE BREAKDOWN:11.0V 2%	28480	1902-3172
A3VR9	1902-0761		DIODE:BREAKDOWN 5.9 TO 6.5V	12954	1N821
A3VR10	1902-0761		DIODE:BREAKDOWN 5.9 TO 6.5V	12954	1N821
A3VR11	1902-1241	2	DIODE BREAKDOWN:9.0V 2% 500MW	28480	1902-1241
A3VR12	1902-3070		DIODE:BREAKDOWN 4.22V 5%	04713	S210939-74
A3XQ22	1200-0153		SOCKET:TRANSISTOR	81073	22-16-3
A4	01915-66524		ASSY:POSITIVE OUTPUT/POWER DETECTOR	28480	01915-66524
A4C1	0180-2201		C:FXD ELECT 0.68 UF 20% 75VDCW	56289	150D684X0075A2-DYS
A4C2	0150-0053	2	C:FXD CER 0.01 UF +80-20% 100VDCW	9141E	TA
A4C3	0150-0053		C:FXD CER 0.01 UF +80-20% 100VDCW	9141E	TA
A4C4	0150-0053		C:FXD CER 0.01 UF +80-20% 100VDCW	9141E	TA
A4C5	0180-0230		C:FXD ELECT 1.0 UF 20% 50VDCW	56289	150D105X0050A2-DYS
A4C6	0180-0251		C:FXD ELECT 1.0 UF 10% 35VDCW	56289	150D105X0035A2-DYS
A4C7	0150-0053		C:FXD CER 0.01 UF +80-20% 100VDCW	9141E	TA
A4C8	0150-0053	C:FXD CER 0.01 UF +80-20% 100VDCW	9141E	TA	
A4C9	0150-0053	C:FXD CER 0.01 UF +80-20% 100VDCW	9141E	TA	
A4C10	0180-2201	C:FXD ELECT 0.68 UF 20% 75VDCW	56289	150D684X0075A2-DYS	
A4C11	0150-0053	C:FXD CER 0.01 UF +80-20% 100VDCW	9141E	TA	
A4C12	0150-0053	2	C:FXD CER 0.01 UF +80-20% 100VDCW	9141E	TA
A4C13	0150-0053		C:FXD CER 0.01 UF +80-20% 100VDCW	9141E	TA
A4C14	0150-0053		C:FXD CER 0.01 UF +80-20% 100VDCW	9141E	TA
A4C15	0150-0053		C:FXD CER 0.01 UF +80-20% 100VDCW	9141E	TA
A4C16	0160-2202		C:FXD MICA 75 PF 5%	28480	0160-2202
A4C17	0160-2202		C:FXD MICA 75 PF 5%	28480	0160-2202
A4C18	0140-0152	1	C:FXD MICA 68 PF 5%	28480	0140-0152
A4C19	0160-2308		C:FXD MICA 36 PF 5%	28480	0160-2308
A4C20	0140-0152		C:FXD MICA 68 PF 5%	28480	0140-0152
A4C21	0150-0053		C:FXD CER 0.01 UF +80-20% 100VDCW	9141E	TA
A4C22	0150-0053		C:FXD CER 0.01 UF +80-20% 100VDCW	9141E	TA
A4C23	0150-0053	C:FXD CER 0.01 UF +80-20% 100VDCW	9141E	TA	
A4C24	0150-0053	C:FXD CER 0.01 UF +80-20% 100VDCW	9141E	TA	
A4C25	0150-0053	C:FXD CER 0.01 UF +80-20% 100VDCW	9141E	TA	
A4C26	0180-2201	C:FXD ELECT 0.68 UF 20% 75VDCW	56289	150D684X0075A2-DYS	
A4C27	0150-0053	2	C:FXD CER 0.01 UF +80-20% 100VDCW	9141E	TA
A4C28	0150-0053		C:FXD CER 0.01 UF +80-20% 100VDCW	9141E	TA
A4C29	0180-0251		C:FXD ELECT 1.0 UF 10% 35VDCW	56289	150D105X0035A2-DYS
A4C30	0150-0053		C:FXD CER 0.01 UF +80-20% 100VDCW	9141E	TA
A4C31	0180-0251		C:FXD ELECT 1.0 UF 10% 35VDCW	56289	150D105X0035A2-DYS
A4C32	0150-0053		C:FXD CER 0.01 UF +80-20% 100VDCW	9141E	TA
A4C33	0180-2201	C:FXD ELECT 0.68 UF 20% 75VDCW	56289	150D684X0075A2-DYS	
A4C34	0150-0053	C:FXD CER 0.01 UF +80-20% 100VDCW	9141E	TA	
A4C35	0140-0151	C:FXD MICA 820 PF 2%	28480	0140-0151	
A4C36		NOT ASSIGNED			
A4CR1	1901-0514	2	DIODE:SI 15 WV 125 MA	28480	1901-0514
A4CR2	1901-0514		DIODE:SI 15 WV 125 MA	28480	1901-0514
A4CR3	1901-0514		DIODE:SI 15 WV 125 MA	28480	1901-0514
A4CR4	1901-0514		DIODE:SI 15 WV 125 MA	28480	1901-0514
A4CR5	1901-0514		DIODE:SI 15 WV 125 MA	28480	1901-0514

See introduction to this section for ordering information

Table 6-2. Replaceable Parts (Cont'd)

Reference Designation	HP Part Number	Qty	Description	Mfr Code	Mfr Part Number
A4CR6	1901-C514		DIODE:SI 15 WV 125 MA	28480	1901-0514
A4CR7	1901-C514		DIODE:SI 15 WV 125 MA	28480	1901-0514
A4CR8	1901-C514		DIODE:SI 15 WV 125 MA	28480	1901-0514
A4CR9	1901-C05C		DIODE:SI 200 MA AT 1V	07263	FDA 6308
A4CR10	1901-G05C		DIODE:SI 200 MA AT 1V	07263	FBA 6308
A4CR11	1901-C05C		DIODE:SI 200 MA AT 1V	07263	FDA 6308
A4CR12	1901-005C		DIODE:SI 200 MA AT 1V	07263	FDA 6308
A4CR13	1901-CC5C		DIODE:SI 200 MA AT 1V	07263	FDA 6308
A4CR14	1901-051C		DIODE:SI 60 WV 10MA	28480	1901-0510
A4CR15			NCT ASSIGNED		
A4CR16	1901-C175		DIODE:SILICON 15WV	28480	1901-0179
A4CR17	1901-C175		DIODE:SILICON 15WV	28480	1901-0179
A4J1	1250-C257		CONNECTOR:RF 50 OHM PC MOUNT	28480	1250-0257
A4J2	1250-C257		CONNECTOR:RF 50 OHM PC MOUNT	28480	1250-0257
A4L1	9100-2256		COIL/CHOKE 0.56 UH 10%	13019	09-4426-3K
A4L2	9100-2276		COIL/CHOKE 100 UH 10%	28480	9100-2276
A4L3	9100-2276		COIL/CHOKE 100 UH 10%	28480	9100-2276
A4L4	9100-2276		COIL/CHOKE 100 UH 10%	28480	9100-2276
A4L5	9100-2276		COIL/CHOKE 100 UH 10%	28480	9100-2276
A4L6	9100-2276		COIL/CHOKE 100 UH 10%	28480	9100-2276
A4L7	9100-2276		COIL/CHOKE 100 UH 10%	28480	9100-2276
A4L8	9100-2276		COIL/CHOKE 100 UH 10%	28480	9100-2276
A4L9	9100-2252		COIL/CHOKE 0.27 UH 10%	28480	9100-2252
A4MP1	1205-0073		HEAT SINK:DUAL (A4Q17)	13103	22108
A4MP2	1205-CC55		HEAT SINK:TRANSISTOR (A4Q19)	13103	22258
A4MP3	1205-C231		HEAT SINK (A9Q14)	28480	1205-0231
A4MP4	1205-0055		HEAT SINK:TRANSISTOR (A4Q18)	13103	22258
A4MP5	1205-CC73		HEAT SINK:DUAL (A4Q7)	13103	22108
A4MP6	1205-0073		HEAT SINK:DUAL (A4Q9)	13103	22108
A4MP7	1205-0231		HEAT SINK (A4Q12)	28480	1205-0231
A4MP8	1205-CC73		HEAT SINK:DUAL (A4Q16)	13103	22108
A4MP9	1205-CC73		HEAT SINK:DUAL (A4Q15)	13103	22108
A4MP10	1205-0073		HEAT SINK:DUAL (A4Q21)	13103	22108
A4MP11	1205-0073		HEAT SINK:DUAL (A4Q2)	13103	22108
A4MP12	1205-0231		HEAT SINK (A4Q1)	28480	1205-0231
A4MP13	1205-CC73		HEAT SINK:DUAL (A4Q10)	13103	22108
A4MP14	1205-0231		HEAT SINK (A4Q11)	28480	1205-0231
A4MP15	1205-0073		HEAT SINK:DUAL (A4Q8)	13103	22108
A4MP16	1205-0231		HEAT SINK (A4Q13)	28480	1205-0231
A4Q1	1854-C363		TSTR:SI NPN	80131	2N5262
A4Q2	1854-C233		TSTR:SI NPN	80131	2N3866
A4Q3	1853-0034		TSTR:SI PNP(SELECTED FROM 2N3251)	28480	1853-0034
A4Q4	1854-C241		TSTR:SI NPN	28480	1854-C241
A4Q5	1853-C201		TSTR:SI PNP	28480	1853-0201
A4Q6	1854-C233		TSTR:SI NPN	80131	2N3866
A4Q7	1853-C205		TSTR:SI PNP	28480	1853-0209
A4Q8	1853-C205		TSTR:SI PNP	28480	1853-0209
A4Q9	1853-C205		TSTR:SI PNP	28480	1853-0209
A4Q10	1853-C205		TSTR:SI PNP	28480	1853-0209
A4Q11	1853-C205		TSTR:SI PNP	28480	1853-0209
A4Q12	1853-C205		TSTR:SI PNP	28480	1853-0209
A4Q13	1853-C205		TSTR:SI PNP	28480	1853-0209
A4Q14	1853-C205		TSTR:SI PNP	28480	1853-0209
A4Q15	1853-C210		TSTR:SI PNP	28480	1853-0210
A4Q16	1853-C210		TSTR:SI PNP	28480	1853-0210
A4Q17	1853-C210		TSTR:SI PNP	28480	1853-0210
A4Q18	1853-C210		TSTR:SI PNP	28480	1853-0210
A4Q19	1853-C210		TSTR:SI PNP	28480	1853-0210
A4Q20	1853-0034		TSTR:SI PNP(SELECTED FROM 2N3251)	28480	1853-0034
A4Q21	1853-C210		TSTR:SI PNP	28480	1853-0210
A4Q22	1853-CC6C	4	TSTR:SI PNP	80131	2N4888
A4Q23	1854-CC23		TSTR:SI NPN(SELECTED FROM 2N2484)	28480	1854-0023
A4Q24	1853-CC10		TSTR:SI PNP(SELECTED FROM 2N3251)	28480	1853-CC10
A4Q25	1854-CC23		TSTR:SI NPN(SELECTED FROM 2N2484)	28480	1854-0023
A4Q26			NCT ASSIGNED		
A4Q27	1853-CC36		TSTR:SI PNP	80131	2N3906
A4Q28	1853-CC36		TSTR:SI PNP	80131	2N3906
A4Q29	5080-56CC	1	TSTR:SI NPN (MATCHED PAIR)	28480	5080-9600
A4Q30			N.S.R. PART OF A4Q29(MATCHED PAIR)		
A4Q31	1853-CC36		TSTR:SI PNP	80131	2N3906
A4R1	0698-3113	1	R:FXD COMP 100 OHM 5% 1/8W	28480	0698-3113
A4R2	C757-C1E1		R:FXD NET CX 150 OHM 2% 1/2W	28480	0757-0181
A4R3	0698-5565		R:FXD NET CX 1500 OHM 2% 1W	28480	0698-5565
A4R4	0698-3111		R:FXD COMP 30 OHM 5% 1/8W	28480	0698-3111

See introduction to this section for ordering information

Table 6-2. Replaceable Parts (Cont'd)

Reference Designation	HP Part Number	Qty	Description	Mfr Code	Mfr Part Number
A4R5	0760-C014		R:FXD MET OX 1K OHM 2% 1W	28480	0760-0014
A4R6	0758-C014		R:FXD MET FLM 180 OHM 5% 1/2W	28480	0758-CC14
A4R7	0698-3113		R:FXD CARBON 100 OHM 5% 1/8W	28480	0698-3113
A4R8	0698-3113		R:FXD CARBON 100 OHM 5% 1/8W	28480	0698-3113
A4R9	0757-C934		R:FXD FLM 2.7K OHM 2% 1/8W	28480	0757-0934
A4R10	0757-C904		R:FXD FLM 150 OHM 2% 1/8W	28480	0757-C904
A4R11	0698-3378		R:FXD CARBON 51 OHM 5% 1/8W	28480	0698-3378
A4R12	0698-3378		R:FXD CARBON 51 OHM 5% 1/8W	28480	0698-3378
A4R13	0698-7056		R:FXD COMP 10 OHM 10% 1/8W	01121	BB 1001
A4R14	0698-7056		R:FXD COMP 10 OHM 10% 1/8W	01121	BB 1001
A4R15	0698-3111		R:FXD COMP 30 OHM 5% 1/8W	28480	0698-3111
A4R16	0698-3111		R:FXD COMP 30 OHM 5% 1/8W	28480	0698-3111
A4R17	0698-3111		R:FXD COMP 30 OHM 5% 1/8W	28480	0698-3111
A4R18	0698-3111		R:FXD COMP 30 OHM 5% 1/8W	28480	0698-3111
A4R19	0698-7033		R:FXD MET OX 47 OHM 2% 1W	28480	0698-7033
A4R20	0698-7033		R:FXD MET OX 47 OHM 2% 1W	28480	0698-7033
A4R21	0698-7033		R:FXD MET OX 47 OHM 2% 1W	28480	0698-7033
A4R22	0698-7033		R:FXD MET OX 47 OHM 2% 1W	28480	0698-7033
A4R23	0698-7033		R:FXD MET OX 47 OHM 2% 1W	28480	0698-7033
A4R24	0698-7033		R:FXD MET OX 47 OHM 2% 1W	28480	0698-7033
A4R25	0698-7033		R:FXD MET OX 47 OHM 2% 1W	28480	0698-7033
A4R26	0698-7033		R:FXD MET OX 47 OHM 2% 1W	28480	0698-7033
A4R27	0698-6724	2	R:FXD FLM 47 OHM 2% 1/8W	28480	0698-6724
A4R28	0698-6724		R:FXD FLM 47 OHM 2% 1/8W	28480	0698-6724
A4R29	0698-7029		R:FXD FLM 39 OHM 2% 1/8W	28480	0698-7029
A4R30	0757-C857	1	R:FXD FLM 75 OHM 2% 1/8W	28480	0757-C857
A4R31	0757-C853		R:FXD FLM 51 OHM 2% 1/8W	28480	0757-C853
A4R32	0757-C965		R:FXD FLM 51K OHM 2% 1/8W	28480	0757-C965
A4R33	0757-C935		R:FXD FLM 3K OHM 2% 1/8W	28480	0757-C935
A4R34	0757-C935		R:FXD FLM 3K OHM 2% 1/8W	28480	0757-C935
A4R35	0757-C935		R:FXD FLM 3K OHM 2% 1/8W	28480	0757-C935
A4R36	0757-C935		R:FXD FLM 3K OHM 2% 1/8W	28480	0757-C935
A4R37	0757-C935		R:FXD FLM 3K OHM 2% 1/8W	28480	0757-C935
A4R38	0757-C935		R:FXD FLM 3K OHM 2% 1/8W	28480	0757-C935
A4R39	0757-C935		R:FXD FLM 3K OHM 2% 1/8W	28480	0757-C935
A4R40	0757-C935		R:FXD FLM 3K OHM 2% 1/8W	28480	0757-C935
A4R41	0757-C935		R:FXD FLM 3K OHM 2% 1/8W	28480	0757-C935
A4R42	0757-C935		R:FXD FLM 3K OHM 2% 1/8W	28480	0757-C935
A4R43	0757-C931		R:FXD FLM 2K OHM 2% 1/8W	28480	0757-C931
A4R44	0757-C931		R:FXD FLM 2K OHM 2% 1/8W	28480	0757-C931
A4R45	0757-C931		R:FXD FLM 2K OHM 2% 1/8W	28480	0757-C931
A4R46	0757-C931		R:FXD FLM 2K OHM 2% 1/8W	28480	0757-C931
A4R47	0757-C931		R:FXD FLM 2K OHM 2% 1/8W	28480	0757-C931
A4R48	0698-7031		R:FXD MET CX 43 OHM 2% 1W	28480	0698-7031
A4R49	0698-7031		R:FXD MET OX 43 OHM 2% 1W	28480	0698-7031
A4R50	0698-7031		R:FXD MET CX 43 OHM 2% 1W	28480	0698-7031
A4R51	0698-7031		R:FXD MET OX 43 OHM 2% 1W	28480	0698-7031
A4R52	0698-7031		R:FXD MET CX 43 OHM 2% 1W	28480	0698-7031
A4R53	0698-7031		R:FXD MET OX 43 OHM 2% 1W	28480	0698-7031
A4R54	0698-7031		R:FXD MET OX 43 OHM 2% 1W	28480	0698-7031
A4R55	0698-7031		R:FXD MET OX 43 OHM 2% 1W	28480	0698-7031
A4R56	0757-C948		R:FXD FLM 10K OHM 2% 1/8W	28480	0757-C948
A4R57	2100-2522		R:VAR CERMET 10K OHM 10% LIN 1/2W	28480	2100-2522
A4R58	0757-C939		R:FXD FLM 4.3K OHM 2% 1/8W	28480	0757-C939
A4R59	0757-C946		R:FXD FLM 8.2K OHM 2% 1/8W	28480	0757-C946
A4R60	0757-C939		R:FXD FLM 4.3K OHM 2% 1/8W	28480	0757-C939
A4R61	0761-C049		R:FXD MET OX 200 OHM 5% 1W	28480	0761-C049
A4R62	0757-C907		R:FXD FLM 200 OHM 2% 1/8W	28480	0757-C907
A4R63	0757-C917		R:FXD FLM 510 OHM 2% 1/8W	28480	0757-C917
A4R64	0757-0526		R:FXD FLM 1.2K OHM 2% 1/8W	28480	0757-0526
A4R65	0698-7187		R:FXD COMP 2 MEGOHM 5% 1/8W	01121	BB 2055
A4R66	0698-7185		R:FXD COMP 220K OHM 5% 1/8W	01121	BB 2245
A4R67	0757-C948		R:FXD FLM 10K OHM 2% 1/8W	28480	0757-C948
A4R68	0757-C959	3	R:FXD FLM 30K OHM 2% 1/8W	28480	0757-C959
A4R69	0757-C948		R:FXD FLM 10K OHM 2% 1/8W	28480	0757-C948
A4R70	0757-C924		R:FXD MET FLM 1K OHM 2% 1/8W	28480	0757-C924
A4R71	0757-C943		R:FXD FLM 6.2K OHM 2% 1/8W	28480	0757-C943
A4R72			NGT ASSIGNED		
A4R73	0757-C948		R:FXD FLM 10K OHM 2% 1/8W	28480	0757-C948
A4R74	0757-C948		R:FXD FLM 10K OHM 2% 1/8W	28480	0757-C948
A4R75	0757-C972		R:FXD FLM 100K OHM 2% 1/8W	28480	0757-C972
A4R76	0757-C972		R:FXD FLM 100K OHM 2% 1/8W	28480	0757-C972
A4R77	0757-C917		R:FXD FLM 510 OHM 2% 1/8W	28480	0757-C917
A4R78	0757-C917		R:FXD FLM 510 OHM 2% 1/8W	28480	0757-C917
A4R79	0757-C951		R:FXD FLM 13K OHM 2% 1/8W	28480	0757-C951

See introduction to this section for ordering information

Table 6-2. Replaceable Parts (Cont'd)

Reference Designation	HP Part Number	Qty	Description	Mfr Code	Mfr Part Number
A4R80	0757-C951		R:FXD FLM 13K OHM 2% 1/8W	28480	0757-0951
A4R81	0757-C910		R:FXD MET FLM 270 OHM 2% 1/8W	28480	0757-0910
A4R82	0757-C966		R:FXD FLM 56K OHM 2% 1/8W	28480	0757-0966
A4R83	0757-C943		R:FXD FLM 6.2K OHM 2% 1/8W	28480	0757-0943
A4R84	0757-C924		R:FXD MET FLM 1K OHM 2% 1/8W	28480	0757-0924
A4R85	2100-2216		R:VAR CERMET 5000 OHM 10% LIN 1/2W	28480	2100-2216
A4R86	0757-C941		R:FXD FLM 5.1K OHM 2% 1/8W	28480	0757-C941
A4R87			NOT ASSIGNED		
A4R88	2100-1738		R:VAR FLM 10K OHM 10% LIN 1/2W	28480	2100-1738
A4TP1	0360-C124		TERMINAL:SOLDER LUG	28480	0360-0124
A4TP2	0360-0124		TERMINAL:SOLDER LUG	28480	0360-0124
A4TP3	0360-C124		TERMINAL:SOLDER LUG	28480	0360-0124
A4VR1	1902-C551		DIODE BREAKDCWN:6.19V 5%	28480	1902-C551
A4VR2	1902-3048		DIODE BREAKDCWN:SILICON 3.48V 5%	28480	1902-3048
A4VR3	1902-C551		DIODE BREAKDCWN:6.19V 5%	28480	1902-C551
A4VR4	1902-C785		DIODE:BREAKDCWN 9.09V 5%	04713	1N936
A4VR5	1902-C785		DIODE:BREAKDCWN 9.09V 5%	04713	1N936
A4VR6	1902-3203		DIODE BREAKDCWN:SILICON 14.7V 5%	28480	1902-3203
A4VR7	1902-3114	1	DIODE BREAKDCWN:6.19V 2%	28480	1902-3114
A4VR8	1902-3172		DIODE BREAKDCWN:11.0V 2%	28480	1902-3172
A4VR9	1902-C761		DIODE:BREAKDCWN 5.9 TO 6.5V	12954	1N821
A4VR10	1902-C761		DIODE:BREAKDCWN 5.9 TO 6.5V	12954	1N821
A4VR11	1902-1241		DIODE BREAKDCWN:9.0V 2% 500MW	28480	1902-1241
A4VR12	1902-3070		DIODE:BREAKDCWN 4.22V 5%	04713	S210939-74
A4XQ22	1200-C153		SOCKET:TRANSISTOR	81073	22-16-3
A5	01915-66525	1	ASSY:TRANSITION TIME CONTROL	28480	01915-66525
A5C1	0160-2555	4	C:FXD CER 1000 PF +100-0% 600VDCW	56289	C067K102E102ZE19
A5C2	0160-2555		C:FXD CER 1000 PF +100-0% 600VDCW	56289	C067K102E102ZE19
A5C3	0180-2203		C:FXD ELECT 1.0 UF 20% 35VDCW	37942	TIM105M035POW
A5C4	0180-2202	2	C:FXD ELECT 0.1 UF 20% 35VDCW	28480	0180-2202
A5C5	0160-2555		C:FXD CER 1000 PF +100-0% 600VDCW	56289	C067K102E102ZE19
A5C6	0160-2555		C:FXD CER 1000 PF +100-0% 600VDCW	56289	C067K102E102ZE19
A5C7	0180-2203		C:FXD ELECT 1.0 UF 20% 35VDCW	37942	TIM105M035POW
A5C8	0180-2203		C:FXD ELECT 1.0 UF 20% 35VDCW	37942	TIM105M035POW
A5C9	0180-2203		C:FXD ELECT 1.0 UF 20% 35VDCW	37942	TIM105M035POW
A5C10	0180-2203		C:FXD ELECT 1.0 UF 20% 35VDCW	37942	TIM105M035POW
A5C11	0180-2203		C:FXD ELECT 1.0 UF 20% 35VDCW	37942	TIM105M035POW
A5C12	0180-2203		C:FXD ELECT 1.0 UF 20% 35VDCW	37942	TIM105M035POW
A5C13	0180-2203		C:FXD ELECT 1.0 UF 20% 35VDCW	37942	TIM105M035POW
A5C14	0170-CC40	1	C:FXD MY 0.047 UF 10% 200VDCW	56289	192P47392-PTS
A5C15	0170-CC66	1	C:FXD MY 0.027 UF 10% 200VDCW	56289	192P27392-PTS
A5C16	0160-C161	1	C:FXD MY 0.01 UF 10% 200VDCW	56289	192P10392-PTS
A5C17	0160-C157	1	C:FXD MY 0.0047 UF 10% 200VDCW	56289	192P47292-PTS
A5C18	0160-C300	1	C:FXD MY 0.0027 UF 200VDCW	56289	192P27292-PTS
A5C19	0160-C153	1	C:FXD MY 0.001 UF 10% 200VDCW	56289	192P10292-PTS
A5C20	0140-C145	2	C:FXD MICA 470 PF 5%	72136	DM15F471J35
A5C21	0140-C206	1	C:FXD MICA 270 PF 5%	72136	RDM15F2715 500V
A5C22	0160-2203	1	C:FXD MICA 91 PF 5%	72136	RDM15F910J3C
A5C23	0160-2307	1	C:FXD MICA 47 PF 5%	28480	0160-2307
A5C24	0180-2203		C:FXD ELECT 1.0 UF 20% 35VDCW	37942	TIM105M035POW
A5C25	0180-2203		C:FXD ELECT 1.0 UF 20% 35VDCW	37942	TIM105M035POW
A5C26	0160-3451	2	C:FXD CER .01UF +80-20% 100 VDCW	56289	C023B101F103ZS25-CDH
A5C27	0160-2940	2	C:FXD MICA 470 PF 5% 300 VDCW	72136	RDM15F471J3C
A5C28	0160-3451		C:FXD CER .01 UF +80-20% 100 VDCW	56289	C023B101F103ZS25-CDH
A5C29	0160-2940		C:FXD CER 470 PF 5% 300 VDCW	72136	RDM15F471J3C
A5CR1	1901-C040		DIODE:SILICON 30MA 30WV	07263	FDG1088
A5CR2	1901-0533	2	DIODE:HYBRID HCT CARRIER	28480	1901-0533
A5CR3	1901-0533		DIODE:HYBRID HGT CARRIER	28480	1901-0533
A5CR4	1901-C040		DIODE:SILICON 30MA 30WV	07263	FDG1088
A5CR5	1901-C050		DIODE:SI 200 MA AT 1V	07263	FDA 6308
A5CR6	1901-C050		DIODE:SI 200 MA AT 1V	07263	FDA 6308
A5CR7	1901-C050		DIODE:SI 200 MA AT 1V	07263	FBA 6308
A5CR8	1901-C050		DIODE:SI 200 MA AT 1V	07263	FBA 6308
A5CR9	1901-C050		DIODE:SI 200 MA AT 1V	07263	FDA 6308
A5CR10	1901-C050		DIODE:SI 200 MA AT 1V	07263	FDA 6308
A5CR11	1901-C050		DIODE:SI 200 MA AT 1V	07263	FDA 6308
A5CR12	1901-C050		DIODE:SI 200 MA AT 1V	07263	FDA 6308
A5CR13	1901-0040	1	DIODE:SILICON 0.75A 50PIV	04713	SR1358-6
A5CR14	1901-0040		DIODE:SILICON 30MA 30WV	07263	FDG1088
A5CR15	1901-0040		DIODE:SILICON 30MA 30WV	07263	FDG1088
A5K1	0490-0735	1	RELAY:DPDT 2A	77342	HP11D-24V
A5L1	9100-2276		COIL/CHCKE 100 UH 10%	28480	9100-2276
A5L2	9100-2276		COIL/CHCKE 100 UH 10%	28480	9100-2276
A5L3	9100-2267	1	COIL/CHCKE 18 UH	28480	9100-2267
A5L4	9100-1653	1	COIL:MOLDED CHCKE 910.0 UH 5%	28480	9100-1653
A5L5	9100-2257	2	COIL/CHCKE:0.82UH 10%	82142	09-4426-5K
A5L6	9100-2257		COIL/CHCKE:0.82UH 10%	82142	09-4426-5K
A5MP1	1205-CC37	5	HEAT SINK:TRANSISTOR (A5Q2)	28480	1205-0037
A5MP2	1205-CC55		HEAT SINK:TRANSISTOR (A5Q10)	13103	22258

See introduction to this section for ordering information

Table 6-2. Replaceable Parts (Cont'd)

Reference Designation	HP Part Number	Qty	Description	Mfr Code	Mfr Part Number
A5MP3	1205-0037		HEAT SINK:TRANSISTOR (A5Q1)	28480	1205-0037
A5MP4	1205-0037		HEAT SINK:TRANSISTOR (A5Q3)	28480	1205-0037
A5MP5	1205-0037		HEAT SINK:TRANSISTOR (A5Q4)	28480	1205-0037
A5MP6	1205-0037		HEAT SINK:TRANSISTOR (A5Q8)	28480	1205-0037
A5MP7	1205-0055		HEAT SINK:TRANSISTOR (A5Q7)	13103	22258
A5MP8	1205-0055		HEAT SINK:TRANSISTOR (A5Q6)	13103	22258
A5MP9	1205-0055		HEAT SINK:TRANSISTOR (A5Q5)	13103	22258
A5Q1	1853-0203		TSTR:SI PNP	28480	1853-0203
A5Q2	1854-0019		TSTR:SI NPN	28480	1854-0019
A5Q3	1853-0203		TSTR:SI PNP	28480	1853-0203
A5Q4	1854-0019		TSTR:SI NPN	28480	1854-0019
A5Q5	1853-0006		TSTR:SI PNP	80131	2N3134
A5Q6	1854-G213	2	TSTR:SI NPN	80131	2N2538
A5Q7	1853-0006		TSTR:SI PNP	80131	2N3134
A5Q8	1855-0020	1	TSTR:SI FET N-CHANNEL	28480	1855-0020
A5Q9	1854-0213		TSTR:SI NPN	80131	2N2538
A5Q10	1854-0344	1	TSTR:SI NPN	28480	1854-0344
A5Q11	1854-0215		TSTR:SI NPN	80131	2N3904
A5Q12	1854-0215		TSTR:SI NPN	80131	2N3904
A5Q13	1854-0215		TSTR:SI NPN	80131	2N3904
A5Q14	1854-0215		TSTR:SI NPN	80131	2N3904
A5Q15	1854-0215		TSTR:SI NPN	80131	2N3904
A5Q16	1854-0215		TSTR:SI NPN	80131	2N3904
A5Q17	1854-0215		TSTR:SI NPN	80131	2N3904
A5Q18	1854-0215		TSTR:SI NPN	80131	2N3904
A5Q19	1854-0215		TSTR:SI NPN	80131	2N3904
A5Q20	1854-0215		TSTR:SI NPN	80131	2N3904
A5Q21	1854-0215		TSTR:SI NPN	80131	2N3904
A5Q22	1854-0215		TSTR:SI NPN	80131	2N3904
A5Q23	1854-0215		TSTR:SI NPN	80131	2N3904
A5Q24	1854-0215		TSTR:SI NPN	80131	2N3904
A5Q25	1854-0215		TSTR:SI NPN	80131	2N3904
A5Q26	1854-0215		TSTR:SI NPN	80131	2N3904
A5Q27	1854-0215		TSTR:SI NPN	80131	2N3904
A5Q28	1854-0215		TSTR:SI NPN	80131	2N3904
A5Q29	1854-0215		TSTR:SI NPN	80131	2N3904
A5Q30	1855-0057		TSTR:SI FET N-CHANNEL	28480	1855-0057
A5Q31	1854-0365		TSTR:SI NPN	80131	2N441C
A5Q32	1853-0062	2	TSTR:SI PNP	80131	2N3645
A5Q33	1853-0062		TSTR:SI PNP	80131	2N3645
A5Q34	1853-0034		TSTR:SI PNP(SELECTED FROM 2N3251)	28480	1853-0034
A5Q35	1853-0037		TSTR:SI PNP	04713	SS 2109
A5Q36	1854-0215		TSTR:SI NPN	80131	2N3904
A5Q37	1854-0215		TSTR:SI NPN	80131	2N3904
A5Q38	1854-0022	2	TSTR:SI NPN	C7263	S17843
A5Q39	1853-0036		TSTR:SI PNP	80131	2N3906
A5Q40	1853-0036		TSTR:SI PNP	80131	2N3906
A5R1	0757-C930		R:FXD FLM 1.8K OHM 2% 1/8W	28480	0757-C930
A5R2	0757-C9C1	1	R:FXD FLM 110 OHM 2% 1/8W	28480	0757-09C1
A5R3	0757-C936	1	R:FXD FLM 3.3K OHM 2% 1/8W	28480	0757-0936
A5R4	0698-3618	1	R:FXD MET OX 82 OHM 5% 2W	28480	0698-3618
A5R5	0675-1021		R:FXD CARBON 1K OHM 10% 1/8W	28480	0675-1021
A5R6	0811-2639	1	R:FXD WW 125 OHM 1% 3W	28480	0811-2639
A5R7	0675-1021		R:FXD CARBON 1K OHM 10% 1/8W	28480	0675-1021
A5R8			NGT ASSIGNED		
A5R9	0757-C932	1	R:FXD MET FLM 2.2K OHM 2% 1/8W	28480	0757-C932
A5R10	0811-264C	1	R:FXD WW 220 OHM 1% 3W	28480	0811-264C
A5R11*	0698-3380	2	R:FXD CARBON 75 OHM 5% 1/8W (FACTORY SELECTED VALUE)	28480	0698-3380
A5R12*	0698-3378		R:FXD CARBON 51 OHM 5% 1/8W (FACTORY SELECTED VALUE)	28480	0698-3378
A5R13	0757-C927	6	R:FXD FLM 1.3K OHM 2% 1/8W	28480	0757-0927
A5R14	0675-1021		R:FXD CARBON 1K OHM 10% 1/8W	28480	0675-1021
A5R15	2100-2413	2	R:VAR FLM 200 OHM 10% LIN 1/2W	28480	2100-2413
A5R16	0757-C931		R:FXD FLM 2K OHM 2% 1/8W	28480	0757-0931
A5R17	0757-C952		R:FXD FLM 15K OHM 2% 1/8W	28480	0757-0952
A5R18	0698-3380		R:FXD CARBON 75 OHM 5% 1/8W	28480	0698-3380
A5R19	0698-7028		R:FXD COMP 27 OHM 10% 1/8W	01121	88 2701
A5R20	0698-5426	1	R:FXD COMP 10K OHM 10% 1/8W	28480	0698-5426
A5R21	0758-0014		R:FXD MET FLM 180 OHM 5% 1/2W	28480	0758-0014
A5R22	0757-0902	1	R:FXD MET FLM 120 OHM 2% 1/8W	28480	0757-0902
A5R23	2100-2413		R:VAR FLM 200 OHM 10% LIN 1/2W	28480	2100-2413
A5R24	0757-0927		R:FXD FLM 1.3K OHM 2% 1/8W	28480	0757-0927
A5R25	0757-C949	2	R:FXD FLM 11K OHM 2% 1/8W	28480	0757-C949
A5R26	0698-3620	2	R:FXD MET CX 100 OHM 5% 2W	28480	0698-3620
A5R27	0698-3620		R:FXD MET OX 100 OHM 5% 2W	28480	0698-3620
A5R28	0698-7026	1	R:FXD COMP 91 OHM 10% 1/8W	01121	88 9101

See introduction to this section for ordering information

Table 6-2. Replaceable Parts (Cont'd)

Reference Designation	HP Part Number	Qty	Description	Mfr Code	Mfr Part Number
A5R29	0675-1C21		R:FXD CARBGN 1K OHM 10% 1/8W	28480	0675-1021
A5R30	0675-1C21		R:FXD CARBGN 1K OHM 10% 1/8W	28480	0675-1021
A5R31	0675-1C21		R:FXD CARBGN 1K OHM 10% 1/8W	28480	0675-1021
A5R32	0675-1C21		R:FXD CARBGN 1K OHM 10% 1/8W	28480	0675-1021
A5R33	0675-1C21		R:FXD CARBGN 1K OHM 10% 1/8W	28480	0675-1021
A5R34	0675-1C21		R:FXD CARBGN 1K OHM 10% 1/8W	28480	0675-1021
A5R35	0675-1C21		R:FXD CARBGN 1K OHM 10% 1/8W	28480	0675-1021
A5R36	0675-1C21		R:FXD CARBGN 1K OHM 10% 1/8W	28480	0675-1021
A5R37	0675-1C21		R:FXD CARBGN 1K OHM 10% 1/8W	28480	0675-1021
A5R38	0658-7C27	9	R:FXD COMP 10 MEGOHM 10% 1/8W	01121	BB 1061
A5R39	0658-7C27		R:FXD COMP 10 MEGOHM 10% 1/8W	01121	BB 1061
A5R40	0658-7C27		R:FXD COMP 10 MEGOHM 10% 1/8W	01121	BB 1061
A5R41	0658-7C27		R:FXD COMP 10 MEGOHM 10% 1/8W	01121	BB 1061
A5R42	0658-7C27		R:FXD COMP 10 MEGOHM 10% 1/8W	01121	BB 1061
A5R43	0658-7C27		R:FXD COMP 10 MEGOHM 10% 1/8W	01121	BB 1061
A5R44	0658-7C27		R:FXD COMP 10 MEGOHM 10% 1/8W	01121	BB 1061
A5R45	0658-7C27		R:FXD COMP 10 MEGOHM 10% 1/8W	01121	BB 1061
A5R46	0658-7C27		R:FXD COMP 10 MEGOHM 10% 1/8W	01121	BB 1061
A5R47	0658-5422		R:FXD CCMP 5600 OHM 10% 1/8W	01121	BB 5621
A5R48	0658-5422		R:FXD CCMP 5600 OHM 10% 1/8W	01121	BB 5621
A5R49	0698-5422		R:FXD CCMP 5600 OHM 10% 1/8W	01121	BB 5621
A5R50	0698-5422		R:FXD CCMP 5600 OHM 10% 1/8W	01121	BB 5621
A5R51	0698-5422		R:FXD CCMP 5600 OHM 10% 1/8W	01121	BB 5621
A5R52	0757-C931		R:FXD FLM 2K OHM 2% 1/8W	28480	0757-0931
A5R53	0757-C931		R:FXD FLM 2K OHM 2% 1/8W	28480	0757-0931
A5R54	0757-C931		R:FXD FLM 2K OHM 2% 1/8W	28480	0757-0931
A5R55	0757-C931		R:FXD FLM 2K OHM 2% 1/8W	28480	0757-0931
A5R56	0757-C934		R:FXD FLM 2.7K OHM 2% 1/8W	28480	0757-0934
A5R57	0757-C923		R:FXD FLM 910 OHM 2% 1/8W	28480	0757-0923
A5R58	0658-4C73		R:FXD CCMP 1.0 MEGOHM 10% 1/8W	01121	BB 1051
A5R59	0757-C92E		R:FXD FLM 1.5K OHM 2% 1/8W	28480	0757-0928
A5R60	0757-C942		R:FXD FLM 5.6K OHM 2% 1/8W	28480	0757-0942
A5R61	0757-C923		R:FXD FLM 910 OHM 2% 1/8W	28480	0757-0923
A5R62	0757-C942		R:FXD FLM 5.6K OHM 2% 1/8W	28480	0757-0942
A5R63	0757-C952		R:FXD FLM 15K OHM 2% 1/8W	28480	0757-0952
A5R64	0757-C92C	1	R:FXD FLM 680 OHM 2% 1/8W	28480	0757-0920
A5R65	0757-C921	1	R:FXD MET FLM 750 OHM 2% 1/8W	28480	0757-0921
A5R66	0757-C927		R:FXD FLM 1.3K OHM 2% 1/8W	28480	0757-0927
A5R67	0757-C92E		R:FXD FLM 1.5K OHM 2% 1/8W	28480	0757-0928
A5R68	0757-0465	1	R:FXD FLM 100K OHM 2% 1/8W	28480	0757-0465
A5R69			NOT ASSIGNED		
A5R70	0757-C942		R:FXD FLM 5.6K OHM 2% 1/8W	28480	0757-0942
A5R71*	0757-0938	2	R:FXD FLM 3.9K OHM 2% 1/8W	28480	0757-0938
A5R72			NOT ASSIGNED		
A5R73	0757-C94E		R:FXD FLM 10K OHM 2% 1/8W	28480	0757-0948
A5R74	0757-C927		R:FXD FLM 1.3K OHM 2% 1/8W	28480	0757-0927
A5R75	0757-C931		R:FXD FLM 2K OHM 2% 1/8W	28480	0757-0931
A5R76	0757-0465		R:FXD FLM 100K OHM 2% 1/8W	28480	0757-0465
A5R77			NOT ASSIGNED		
A5R78	0757-C942		R:FXD FLM 5.6K OHM 2% 1/8W	28480	0757-0942
A5R79*	0757-0938		R:FXD FLM 3.9K OHM 2% 1/8W	28480	0757-0938
A5R80			NOT ASSIGNED		
A5R81	0757-C94E		R:FXD FLM 10K OHM 2% 1/8W	28480	0757-0948
A5TP1	0360-0124		TERMINAL:SCLDER LUG	28480	0360-0124
A5TP2	0360-0124		TERMINAL:SCLDER LUG	28480	0360-0124
A5TP3	0360-0124		TERMINAL:SCLDER LUG	28480	0360-0124
A5TP4	0360-0124		TERMINAL:SCLDER LUG	28480	0360-0124
A5TP5	0360-0124		TERMINAL:SCLDER LUG	28480	0360-0124
A5TP6	0360-0124		TERMINAL:SCLDER LUG	28480	0360-0124
A5TP7	0360-0124		TERMINAL:SCLDER LUG	28480	0360-0124
A5VR1	1902-3182	1	DIODE BREAKDOWN: SILICON 12.1V 5%	28480	1902-3182
A5VR2	1902-064E		DIODE: BREAKDOWN 6.81V 5%	04713	SZ10939-134
A5VR3*	1902-0C45	1	DIODE: BREAKDOWN 6.19V 5% (FACTORY SELECTED VALUE)	04713	SZ10939-122
A5VR4*	1902-31C4	1	DIODE: BREAKDOWN 5.62V 5% (FACTORY SELECTED VALUE)	04713	SZ10939-110
A5VR5	1902-32C3		DIODE BREAKDOWN: SILICON 14.7V 5%	28480	1902-3203
A6			NOT ASSIGNED		
A7	01915-665C7	1	ASSY: OFFSET, POWER SUPPLY	28480	01915-66507
A7C1	0150-CC53		C:FXD CER 0.01 UF +80-20% 100VDCW	91418	TA
A7C2	0150-CC53		C:FXD CER 0.01 UF +80-20% 100VDCW	9141E	TA
A7C3	0180-2202		C:FXD ELECT 0.1 UF 20% 35VDCW	28480	0180-2202
A7C4	0150-CC53		C:FXD CER 0.01 UF +80-20% 100VDCW	91418	TA
A7C5	0180-CC51		C:FXD ELECT 1.0 UF 10% 35VDCW	56289	150D105X9035A2-DYS
A7C6	0150-CC53		C:FXD CER 0.01 UF +80-20% 100VDCW	91418	TA
A7C7	0150-CC53		C:FXD CER 0.01 UF +80-20% 100VDCW	9141E	TA
A7C8	0180-0116	2	C:FXD TA 6.8 UF 10% 35 VDCW	56289	150D685X9035B2-DYS
A7C9	0180-0116		C:FXD TA 6.8 UF 10% 35 VDCW	56289	150D685X9035B2-DYS
A7CR1	1901-C025	6	DIODE: SILICON 100MA/1V	07263	FD 2387
A7CR2	1901-C025		DIODE: SILICON 100MA/1V	07263	FD 2387

See introduction to this section for ordering information

Table 6-2. Replaceable Parts (Cont'd)

Reference Designation	HP Part Number	Qty	Description	Mfr Code	Mfr Part Number
A7CR3	1901-0025		DIODE:SILICON 100MA/1V	07263	FD 2387
A7CR4	1901-0025		DIODE:SILICON 100MA/1V	07263	FD 2387
A7CR5	1901-0025		DIODE:SILICON 100MA/1V	07263	FD 2387
A7CR6	1901-0025		DIODE:SILICON 100MA/1V	07263	FD 2387
A7CR7	1901-0040		DIODE:SILICON 30MA 30WV	07263	FDG1088
A7CR8	1901-0040		DIODE:SILICON 30MA 30WV	07263	FDG1088
A7CR9	1901-0050		DIODE:SI 200 MA AT 1V	07263	FDA 6308
A7CR10	1901-0050		DIODE:SI 200 MA AT 1V	07263	FDA 6308
A7J1	1250-0257		CONNECTOR:RF 50 OHM PC MCUNT	28480	1250-0257
A7K1		1	REED RELAY:CONSISTS OF; REED ASSY:50 OHM	28480	01915-61901
A7K1E1	01915-61901				
A7K1L1	0490-0305	1	COIL:REED RELAY 12V	71707	SP-12P
A7L1	9100-1645	1	COIL/CHCKE 390.0 UH 5%	82142	19-1331-25J
A7MP1	1205-0231		HEAT SINK (A7Q7)	28480	1205-0231
A7MP2	1205-0231		HEAT SINK (A8Q8)	28480	1205-0231
A7MP3	1205-0231		HEAT SINK (A7Q9)	28480	1205-0231
A7MP4	1205-0231		HEAT SINK (A7Q10)	28480	1205-0231
A7MP5			NOT ASSIGNED		
A7MP6	1205-0226		HEAT SINK:SEMICON FOR TD-5 CASE (A7Q12)	13103	11158
A7MP7	1205-0231		HEAT SINK (A7Q14)	28480	1205-0231
A7MP8	1205-0231		HEAT SINK (A7Q16)	28480	1205-0231
A7Q1	1854-0022		TSTR:SI NPN	07263	S17843
A7Q2	1853-0080		TSTR:SI PNP	80131	2N4888
A7Q3	1853-0080		TSTR:SI PNP	80131	2N4888
A7Q4	1854-0365		TSTR:SI NPN	80131	2N4410
A7Q5	1853-0080		TSTR:SI PNP	80131	2N4888
A7Q6	1854-0365		TSTR:SI NPN	80131	2N4410
A7Q7	1853-0226	2	TSTR:SI PNP	28480	1853-0226
A7Q8	1854-0355	2	TSTR:SI NPN	28480	1854-0355
A7Q9	1853-0226		TSTR:SI PNP	28480	1853-0226
A7Q10	1854-0355		TSTR:SI NPN	28480	1854-0355
A7Q11	1854-0022		TSTR:SI NPN(SELECTED FROM 2N2484)	28480	1854-CC23
A7Q12	1853-0210		TSTR:SI PNP	28480	1853-0210
A7Q13	1854-0362		TSTR:SI NPN	28480	1854-0362
A7Q14	1853-0210		TSTR:SI PNP	28480	1853-0210
A7Q15	1853-0210		TSTR:SI PNP	28480	1853-0210
A7Q16	1854-0362		TSTR:SI NPN	28480	1854-0362
A7R1	0757-0949		R:FXD FLM 11K OHM 2% 1/8W	28480	0757-0949
A7R2	0757-0942		R:FXD FLM 5.6K OHM 2% 1/8W	28480	0757-0942
A7R3	0757-0941		R:FXD FLM 5.1K OHM 2% 1/8W	28480	0757-0941
A7R4	0757-0941		R:FXD FLM 5.1K OHM 2% 1/8W	28480	0757-0941
A7R5	0757-0935		R:FXD FLM 3K OHM 2% 1/8W	28480	0757-0935
A7R6	0757-0935		R:FXD FLM 3K OHM 2% 1/8W	28480	0757-0935
A7R7	0757-0935		R:FXD FLM 3K OHM 2% 1/8W	28480	0757-0935
A7R8	0757-0935		R:FXD FLM 3K OHM 2% 1/8W	28480	0757-0935
A7R9	0698-3378		R:FXD CARBON 51 OHM 5% 1/8W	28480	0698-3378
A7R10	0698-3378		R:FXD CARBON 51 OHM 5% 1/8W	28480	0698-3378
A7R11	0698-3113		R:FXD CARBON 100 OHM 5% 1/8W	28480	0698-3113
A7R12	0698-3113		R:FXD CARBON 100 OHM 5% 1/8W	28480	0698-3113
A7R13	0757-0942	2	R:FXD MET FLM 100 OHM 1% 1/2W	28480	0757-0942
A7R14	0757-0942		R:FXD MET FLM 100 OHM 1% 1/2W	28480	0757-0942
A7R15	0757-0941		R:FXD FLM 5.1K OHM 2% 1/8W	28480	0757-0941
A7R16	0757-0941		R:FXD FLM 5.1K OHM 2% 1/8W	28480	0757-0941
A7R17	0757-0912	1	R:FXD MET FLM 330 OHM 2% 1/8W	28480	0757-0912
A7R18	0757-0924		R:FXD MET FLM 1K OHM 2% 1/8W	28480	0757-0924
A7R19	0757-0924		R:FXD MET FLM 1K OHM 2% 1/8W	28480	0757-0924
A7R20	0757-0898		R:FXD FLM 82 OHM 2% 1/8W	28480	0757-0898
A7R21	0757-0917		R:FXD FLM 510 OHM 2% 1/8W	28480	0757-0917
A7R22	0757-0942		R:FXD FLM 5.6K OHM 2% 1/8W	28480	0757-0942
A7R23	0811-2641		R:FXD WW 65 OHM 1% 3W	28480	0811-2641
A7R24	0757-0925	2	R:FXD FLM 1.1K OHM 2% 1/8W	28480	0757-0925
A7R25			NOT ASSIGNED		
A7R26	0757-0739	2	R:FXD FLM 2K OHM 2% 1/8W	28480	0757-0739
A7R27	0757-0925		R:FXD FLM 1.1K OHM 2% 1/8W	28480	0757-0925
A7R28			NOT ASSIGNED		
A7R29	0757-0739		R:FXD FLM 2K OHM 2% 1/8W	28480	0757-0739
A7R30	0758-0008	1	R:FXD MET FLM 390 OHM 5% 1/4W	28480	0758-0008
A7TP1	0360-0124		TERMINAL:SOLDER LUG	28480	0360-0124
A7TP2	0360-0124		TERMINAL:SOLDER LUG	28480	0360-0124
A7TP3	0360-0124		TERMINAL:SOLDER LUG	28480	0360-0124
A7TP4	0360-0124		TERMINAL:SOLDER LUG	28480	0360-0124
A7VR1	1902-0574	1	DIODE:BREAKDOWN 64.9V 5% 1W	28480	1902-0574
A7VR2	1902-0547	2	DIODE BREAKDOWN:23.7V 5% 1W	28480	1902-3547
A7VR3	1902-0547		DIODE BREAKDOWN:23.7V 5% 1W	28480	1902-3547
A7VR4	1902-0590	2	DIODE BREAKDOWN:4.42V 5% 1W	28480	1902-0590
A7VR5	1902-0590		DIODE BREAKDOWN:4.42V 5% 1W	28480	1902-0590

See introduction to this section for ordering information

Table 6-2. Replaceable Parts (Cont'd)

Reference Designation	HP Part Number	Qty	Description	Mfr Code	Mfr Part Number
A7W1	01915-61603	1	CABLE:RELAY, NEGATIVE OUTPUT	28480	01915-61603
A7W1P1	1250-0872	5	CONNECTOR:RF 50 OHM SNAP ON TYPE	98291	51-328-3188
A7W2	01915-61604	1	CABLE:RELAY, POSITIVE OUTPUT	28480	01915-61604
A7W2P1	1250-0872	1	CONNECTOR:RF 50 OHM SNAP ON TYPE	98291	51-328-3188
A8	01915-66516	1	ASSY:DUMMY PGM	28480	01915-66516
A8R1	0757-0927		R:FXD FLM 1.3K OHM 2% 1/8W	28480	0757-0927
A8R2	0757-0917		R:FXD FLM 510 OHM 2% 1/8W	28480	0757-0917
A8R3	0757-0931		R:FXD FLM 2K OHM 2% 1/8W	28480	0757-0931
A9	01915-26517	1	ASSY:DUMMY PGM	28480	01915-26517
A10	01915-66510	1	ASSY:POWER CONNECTOR	28480	01915-66510
A10S1	3101-0973	1	SWITCH:SLIDE DPDT 0.5A 125V AC/DC	79727	G126-0018
AT1	01915-61501	1	LOAD ASSY	28480	01915-61501
AT1E1	01915-07601	1	CONTACT:NEGATIVE OUTPUT	28480	01915-07601
AT1E2	01915-07603	1	CONTACT:POSITIVE OUTPUT	28480	01915-07603
AT1E3	01915-07602	1	CONTACT:GROUND	28480	01915-07602
AT1MP1	01915-04101	1	COVER	28480	01915-04101
AT1MP2	01915-27701	1	BODY	28480	01915-27701
AT1MP3	01915-45401	1	INSULATOR PAD	28480	01915-45401
AT1R1	1810-0026	1	R:DUAL FLM 50 OHM	28480	1810-0026
AT1W1	01915-61605	2	CABLE ASSY:POSITIVE TERMINATION	28480	01915-61605
AT1W1P1	1250-0872		CONNECTOR:RF 50 OHM SNAP ON TYPE	98291	51-328-3188
AT1W2	01915-61605		CABLE ASSY:NEGATIVE TERMINATION	28480	01915-61605
AT1W2P1	1250-0872		CONNECTOR:RF 50 OHM SNAP ON TYPE	98291	51-328-3188
DS1	1450-0377	1	LIGHT:INDICATOR 12V AT 40 MA	03797	CFD3-WCS-2174
E1	5060-0461	1	BOARD EXTENDER:15 PIN	28480	5060-0461
E2	5060-0460	1	BOARD EXTENDER:22 PIN	28480	5060-0460
E3	5060-0459	1	BOARD EXTENDER:24 PIN	28480	5060-0459
J1	1250-0118	1	CONNECTOR:BNC (DRIVE INPUT)	24931	2BJR-128-1
MP1	01915-04102	1	COVER:TOP	28480	01915-04102
MP2	01917-67405	1	KNOB ASSY:WIDTH	28480	01917-67405
MP3	01915-67402	1	KNOB ASSY:TRANSITION TIME	28480	01915-67402
MP4	01915-67403	1	KNOB ASSY:AMPLITUDE	28480	01915-67403
MP5	01915-67404	1	KNOB ASSY:OFFSET	28480	01915-67404
MP6	01915-67405	1	KNOB ASSY:POLARITY	28480	01915-67405
MP7	01905-67404	5	KNOB ASSY:VERNIER	28480	01905-67404
MP8	1450-0375	1	LENS:CAP. RED (OVERLOAD)	03797	D86 SRC
MP9	1390-0160	2	FASTENER:PANEL ASSY	08524	DHP-7500-10-C-5
MP10	01915-00201	1	PANEL:FRONT	28480	01915-00201
MP11	01915-20201	1	FRAME:PANEL	28480	01915-20201
MP12	01915-20102	1	DECK ASSY	28480	01915-20102
MP13	01900-00504	1	GUSSET:RIGHT SIDE	28480	01900-00504
MP14	01900-00505	1	GUSSET:LEFT SIDE	28480	01900-00505
MP15	01900-01203	1	BRACKET:CONNECTOR	28480	01900-01203
MP16	5040-0170	14	GUIDE:PLUG-IN PC BOARD	28480	5040-0170
MP17	1400-0076	1	CLIP:FUSE, BRONZE (TERMINATION STORAGE)	75915	101002
MP18	01915-22201	1	BEZEL:BNC (DRIVE INPUT)	28480	01915-22201
MP19	5020-0518	1	BEZEL:BNC (OUTPUT)	28480	5020-0518
Q1	1853-0252	1	TSTR:SI PNP	04713	SJ1798
Q2	1854-0264	1	TSTR:SI NPN	80131	2N3715
Q3	1854-0365	1	Q:SI NPN	80131	2N4410
Q4	1853-0065	1	Q:SI PNP	28480	1853-0065
R1	2100-2629	2	R:VAR CERMET 25K OHM 20% LIN 2W (WIDTH VERNIER)	28480	2100-2629
R2	2100-2704	2	R:VAR CERMET 50K OHM 20% 10 CLOG 2W (LEADING EDGE VERNIER)	28480	2100-2704
R3	2100-2629		R:VAR CERMET 25K OHM 20% LIN 2W (OFFSET VERNIER)	28480	2100-2629
R4	2100-2704		R:VAR CERMET 50K OHM 20% 10 CLOG 2W (TRAILING EDGE VERNIER)	28480	2100-2704
R5	2100-2630	1	R:VAR CERMET 12K OHM 20% LIN 2W (AMPLITUDE VERNIER)	28480	2100-2630
R6	0757-0970	1	R:FXD FLM 82K OHM 2% 1/8W	28480	0757-0970
R7	0757-0927	1	R:FXD FLM 1.3K OHM 2% 1/8W	28480	0757-0927
R8	0684-1031	2	R:FXD COMP 10K OHMS 10% 1/4W	01121	CB1031
R9	0684-2231	2	R:FXD COMP 22K OHMS 10% 1/4W	01121	CB2231
R10	0684-2231	2	R:FXD COMP 22K OHMS 10% 1/4W	01121	CB2231
R11	0684-1031	2	R:FXD COMP 10K OHMS 10% 1/4W	01121	CB1031
S1	3100-1399	1	SWITCH:ROTARY (WIDTH)	28480	3100-1399
S2	3100-1398	1	SWITCH:ROTARY (OFFSET)	28480	3100-1398
S3	3100-1397	1	SWITCH:ROTARY (TRANSITION TIME)	28480	3100-1397
S4	3100-1400	1	SWITCH:ROTARY (POLARITY)	28480	3100-1400
S5	3100-1396	1	SWITCH:ROTARY DUAL (AMPLITUDE)	28480	3100-1396
VR1	1902-3256	2	VR:DIODE BREAKDOWN SI 23.7V 5% 400 MW	28480	1902-3256
VR2	1902-3256	2	VR:DIODE BREAKDOWN SI 23.7V 5% 400 MW	28480	1902-3256
W1	01915-61601	2	CABLE:MAIN	28480	01915-61601
W1C1	0180-0291	1	C:FXD ELECT 1.0 UF 10% 35 VDCW	56289	150D105X9035A2-DYS
W1C2	0180-0097	1	C:FXD ELECT 47 UF 10% 35 VDCW	56289	159D476X9035SS-DYS
W1J1			NOT ASSIGNED		
W1J2			NOT ASSIGNED		
W1J3	1251-0159	3	CONNECTOR:30 CONTACT	28480	1251-0159
W1J4	1251-0335	2	CONNECTOR:PC 48 CONTACT	95238	K600-13-PCGD 24
W1J5	1251-0233	2	CONNECTOR:PC 44 CONTACT	28480	1251-0233
W1J6	1251-0159		CONNECTOR:30 CONTACT	28480	1251-0159
W1J7	1251-0233		CONNECTOR:PC 44 CONTACT	28480	1251-0233
W1J8	1251-0335		CONNECTOR:PC 48 CONTACT	95238	K600-13-PCGD 24
W1J9	1251-0159		CONNECTOR:30 CONTACT	28480	1251-0159
W2	01915-61602	2	CABLE ASSY:OUTPUT	28480	01915-61602
W2J1	1250-0872		CONNECTOR:RF 50 OHM SNAP ON TYPE	98291	51-328-3188
W2J2	1250-0252	1	BODY:RF CONNECTOR BULKHEAD (OUTPUT)	28480	1250-0252
XDS1	1450-0376	1	LAMPHOLDER ASSY (OVERLOAD)	03797	DH0-10Y

See introduction to this section for ordering information

Table 6-3. List of Manufacturers' Codes

MFR NO.	MANUFACTURER NAME	ADDRESS	ZIP CODE
01121	ALLEN BRADLEY CO.	MILWAUKEE, WIS.	53204
03797	ELDEMA CORP.	COMPTON, CALIF.	90220
04713	MOTOROLA SEMICONDUCTOR PROD. INC.	PHOENIX, ARIZ.	85008
07263	FAIRCHILD CAMERA & INST. CORP. SEMICONDUCTOR DIV.	MOUNTAIN VIEW, CALIF.	94040
08524	DEUTSCH FASTENER CORP.	LOS ANGELES, CALIF.	90061
12954	DICKSON ELECTRONIC CORP.	SCOTTSDALE, ARIZ.	85252
13019	AIRCC SUPPLY CO. INC.	WICHITA, KANS.	67211
13103	THERMALLOY CO.	DALLAS, TEX.	75247
24931	SPECIALTY CONNECTOR CO. INC.	INDIANAPOLIS, IND.	46227
28480	HEWLETT-PACKARD COMPANY	PALO ALTO, CALIF.	94304
37942	NO M/F DESCRIPTION FOR THIS MFG NUMBER		
56289	SPRAGUE ELECTRIC CO.	N. ADAMS, MASS.	01247
71707	COTO COIL CO. INC.	PROVIDENCE, R.I.	02905
72136	ELECTRO MOTIVE MFG. CO. INC.	WILLIMANTIC, CONN.	06226
72982	ERIE TECHNOLOGICAL PROD. INC.	ERIE, PA.	16512
75915	LITTELFUSE INC.	DES PLAINES, ILL.	60016
77342	AMERICAN MACHINE & FOUNDRY CO. POTTER & BRUMFIELD DIV.	PRINCETON, IND.	47570
79727	CONTINENTAL-WIRT ELECTRONICS CORP.	PHILADELPHIA, PA.	19144
80131	ELECTRONIC INDUSTRIES ASSOCIATION	WASHINGTON D.C.	20006
81073	GRAYHILL	LA GRANGE, ILL.	60525
82142	AIRCO SPEER ELECT. COMP.	DU BOIS, PA.	15801
91418	RADIO MATERIALS CO.	CHICAGO, ILL.	60646
95238	CONTINENTAL CONNECTOR CORP.	WOODSIDE, N.Y.	11377
98291	SEAELECTRO CORP.	MAMARONECK, N.Y.	10544

SECTION VII MANUAL CHANGES AND OPTIONS

7-1. INTRODUCTION.

7-2. This section contains information required to backdate or update this manual for a specific instrument. Descriptions of special options and standard options are also in this section.

7-3. MANUAL CHANGES.

7-4. This manual applies directly to the instrument having a serial prefix as shown on the manual title page. If the serial prefix of the instrument is not the same as the one on the title page, refer to Table 7-1 for changes necessary to backdate the manual to the instrument. When making changes from Table 7-1, make the change with the highest number first. If the serial prefix of the instrument is not listed either in the title page or in Table 7-1, refer to an enclosed MANUAL CHANGES sheet for updating information. Also, if a MANUAL CHANGES sheet is supplied, make all indicated ERRATA corrections.

Table 7-1. Manual Changes

Serial Prefix	Make Changes
1102A	1
0984A-	1
983-00431	1, 2
983-	1 thru 3
971-	1 thru 4
960-	1 thru 5
946-	1 thru 5
936-	1 thru 6
925-	1 thru 7
918-	1 thru 8
915-	1 thru 9
906-	1 thru 10
903-	1 thru 11
838-	1 thru 12
835-	1 thru 13

CHANGE 1

Page 5-10, Paragraph 5-27,
NEGATIVE POWER DETECTOR LEVEL ADJUSTMENT A3R85: Change reference designator for this adjustment to A5R80 (this adjustment is located on transition time circuit board assembly A5 and is labeled -PD).

Page 5-13, Paragraph 5-30,
POSITIVE POWER DETECTOR LEVEL ADJUSTMENT A4R85: Change reference designator for this adjustment to A5R72 (this adjustment is located on transition time circuit board assembly A5 and is labeled +PD).

Table 6-2,
Delete: Q3, Q4, R8, R9, R10, R11, VR2.
A3: Change to HP Part No. 01915-66503; A: NEGATIVE OUTPUT/POWER DETECTOR.
Add: A3C36; HP Part No. 0180-1735; C:FXD ELECT 0.22 UF 10% 35 VDCW.
A3R85: Change to HP Part No. 0757-0939; R:FXD MET FLM 4300 OHM 2% 1/8W.
Add: A3R87; HP Part No. 0698-7029; R:FXD MET FLM 39 OHM 2% 1/8W.
A4: Change to HP Part No. 01915-66504; A: POSITIVE OUTPUT/POWER DETECTOR.
Add: A4C36; HP Part No. 0180-1735; C:FXD ELECT 0.22 UF 10% 35 VDCW.
A4R85: Change to HP Part No. 0757-0939; R:FXD MET FLM 4300 OHM 2% 1/8W.
Add: A4R87; HP Part No. 0698-7029; R:FXD MET FLM 39 OHM 2% 1/8W.
A5: Change to HP Part No. 01915-66505; A: TRANSITION TIME CONTROL.
Delete: A5C26 thru A5C29.
A5R68: Change to HP Part No. 0757-0959; R:FXD MET FLM 30K OHM 2% 1/8W.
Add: A5R69; HP Part No. 0757-0915; R:FXD MET FLM 430 OHM 2% 1/8W.
A5R71: Change to HP Part No. 0757-0937; R:FXD MET FLM 3600 OHM 2% 1/8W.
Add: A5R72; HP Part No. 2100-2489; R:VAR FLM 5000 OHM 10% LIN 1/2W.
A5R76: Change to HP Part No. 0757-0959; R:FXD MET FLM 30K OHM 2% 1/8W.
Add: A5R77; HP Part No. 0757-0915; R:FXD MET FLM 430 OHM 2% 1/8W.
A5R79: Change to HP Part No. 0757-0937; R:FXD MET FLM 3600 OHM 2% 1/8W.
Add: A5R80; HP Part No. 2100-2489; R:VAR FLM 5000 OHM 10% LIN 1/2W.
Delete: A7C8, A7C9.

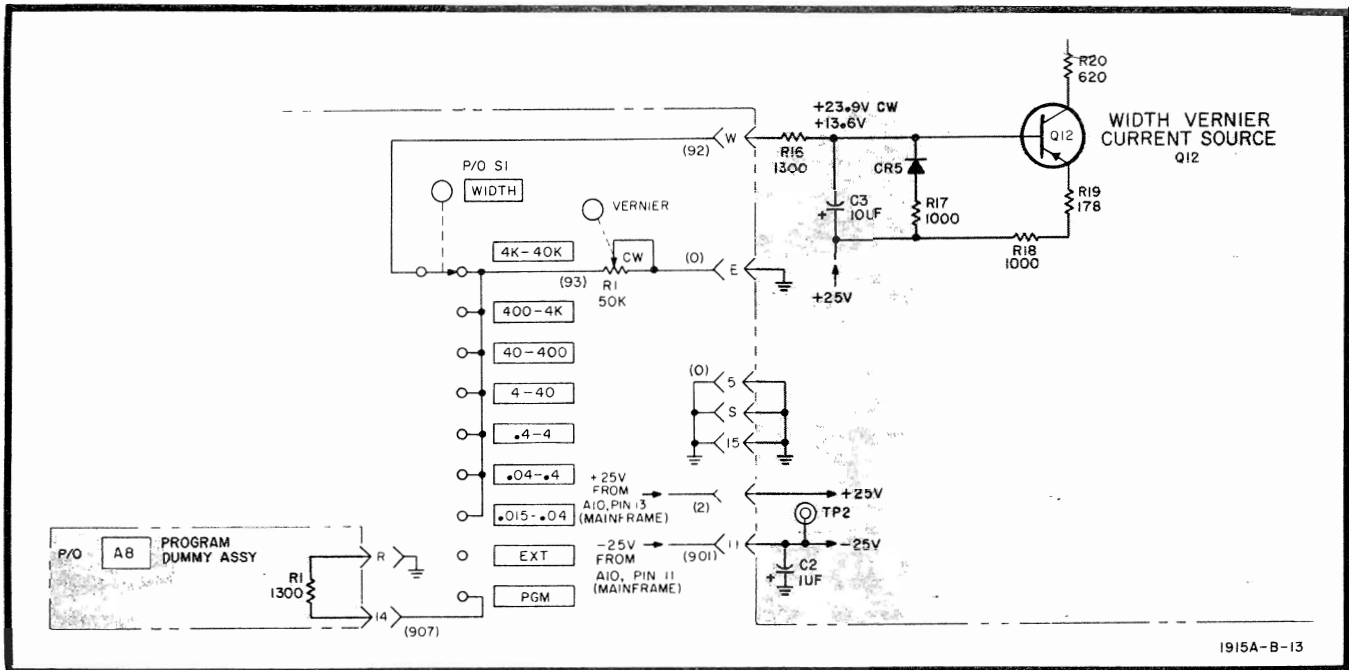

Figure 7-1. Input and Width Assembly, A2, Schematic Correction

A7R26: Change to HP Part No. 0757-0955; R:FXD MET FLM 20K OHM 2% 1/8W.

A7R29: Change to HP Part No. 0757-0955; R:FXD MET FLM 20K OHM 2% 1/8W.

Page 8-19, Figure 8-13,

Delete: Q3, Q4, R8 thru R11, VR1, VR2.

Page 8-25/8-26, Figure 8-23,

Make the schematic changes shown in Figure 7-2.

Page 8-27, Figure 8-25,

Make the schematic changes shown in Figure 7-3.

Page 8-29, Figure 8-29,

Delete: A7C8, A7C9.

A7R26: Change value to 20K.

A7R29: Change value to 20K.

CHANGE 2

Table 6-2,

A2C3: Add HP Part No. 0180-2204; C: FXD TA 10 UF 10% 10 VDCW.

W1C2: Delete.

Page 8-15, Figure 8-8,

Delete W1C2 from A2 Pin C to ground.

Add A2C3, 10 UF, in parallel with A2R17.

CHANGE 3

Table 6-2,

MP1: Delete.

7-2

CHANGE 4

Table 6-2,

A2: Change to HP Part No. 01915-66502; ASSY: WIDTH CONTROL AND AMPLITUDE VERNIER.
A2C7: Add HP Part No. 0140-0193; C: FXD MICA 82 PF 5% 300 VDCW.

A2CR5: Add HP Part No. 1901-0050; CR: SI

A2R16: Add HP Part No. 0757-0927; R: FXD METFLM 1300 OHMS 2% 1/4W.

A2R19: Add HP Part No. 0698-3439; R: FXD METFLM 178 OHMS 1% 1/8W.

A2R20: Change to HP Part No. 0757-0919; R: FXD METFLM 620 OHMS 2% 1/4W.

Delete: A2R91 and A2R92.

A8: Change to HP Part No. 01915-66508; ASSY: DUMMY PGM.

A9: Change to HP Part No. 01915-66509, ASSY: DUMMY PGM.

R1: Change to HP Part No. 2100-2704; R: VAR CERMET 50K OHMS 20% 2W (WIDTH)

R7: Delete.

Page 8-14, Figure 8-6,

Delete Figure 8-6, replace with Figure 7-4.

Page 8-15, Figure 8-8,

Change schematic as shown in Figure 7-1.

CHANGE 5

Table 6-2,

A2MP1, A2R90, A7MP6, A7R30: Delete.

Page 8-14, Figure 8-6,

A2MP1: Delete.

Page 8-28, Figure 8-26,

A7MP6: Delete.

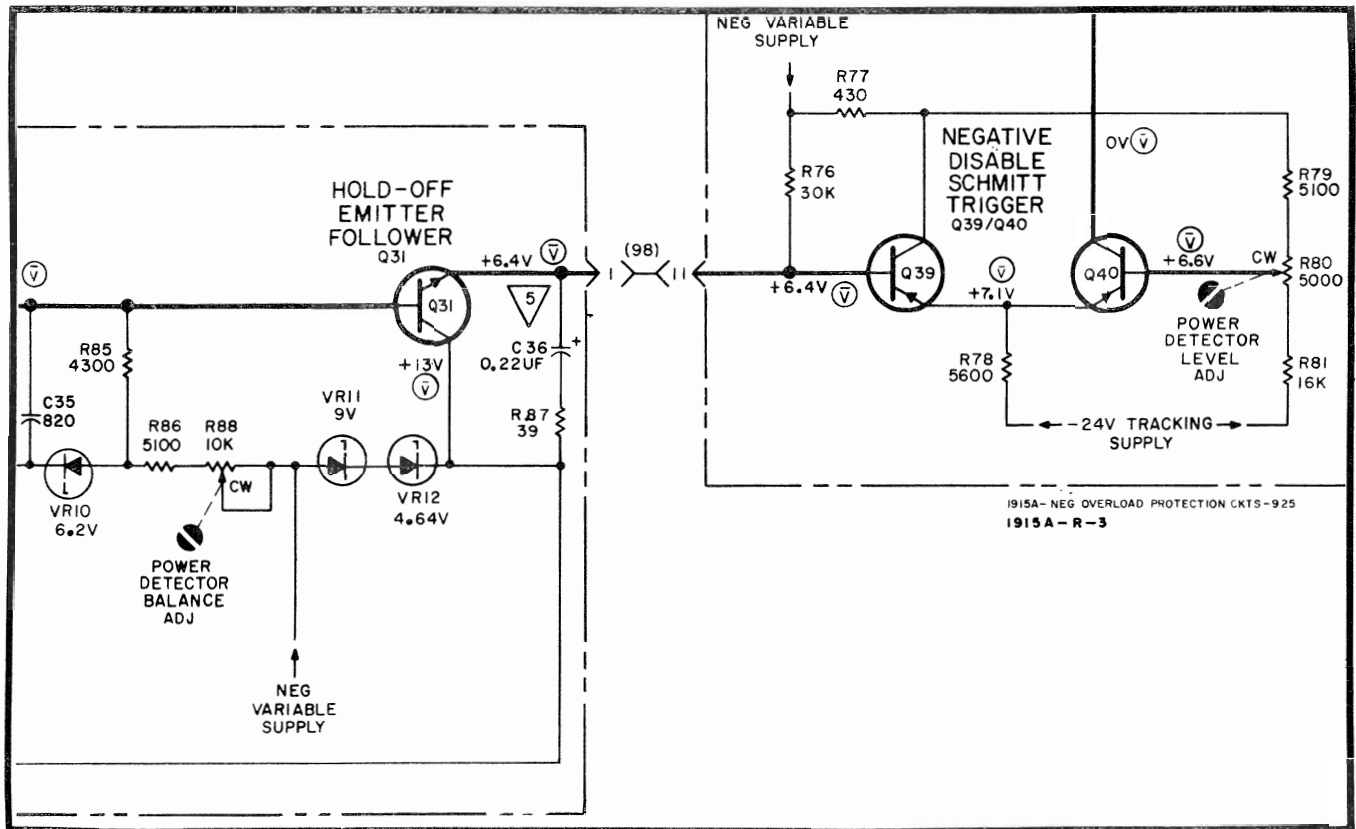

Figure 7-2. Negative Overload Protection Schematic Corrections

Page 8-29, Figure 8-29,
A2R90, A7R30: Delete.

CHANGE 6

Table 6-2,

- A3VR11: Change to HP Part No. 1902-0785; VR: DIODE BREAKDOWN SI 9.0V 5% 400 MW.
- A3VR12: Change to HP Part No. 1902-3082; VR: DIODE BREAKDOWN SI 4.64V 5% 400 MW.
- A4VR11: Change to HP Part No. 1902-0785; VR: DIODE BREAKDOWN SI 9.0V 5% 400 MW.
- A4VR12: Change to HP Part No. 1902-3082; VR: DIODE BREAKDOWN SI 4.64V 5% 400 MW.
- A5CR2: Change to HP Part No. 1901-0050; CR: SI.
- A5CR3: Change to HP Part No. 1901-0050; CR: SI.

Page 8-25/8-26, Figure 8-23,

A3VR12: Change breakdown voltage to 4.64V.

Page 8-27, Figure 8-25,

A4VR12: Change breakdown voltage to 4.22V.

CHANGE 7

Table 6-2,

- A3Q29: Change to HP Part No. 1853-0075; Q: SI PNP DUAL.
- A3Q30: Change to HP Part No. 1853-0075; Q: SI PNP DUAL.

A4Q29: Change to HP Part No. 1854-0280; Q: SI NPN DUAL.

A4Q30: Change to HP Part No. 1854-0280; Q: SI NPN DUAL.

A5R71: Change to HP Part No. 0757-0941; R: FXD METFLM 5100 OHMS 2% 1/4W.

A5R73: Change to HP Part No. 0757-0953; R: FXD METFLM 16K OHMS 2% 1/4W.

A5R79: Change to HP Part No. 0757-0941; R: FXD METFLM 5100 OHMS 2% 1/4W.

A5R81: Change to HP Part No. 0757-0953; R: FXD METFLM 16K OHMS 2% 1/4W.

Page 8-25/8-26, Figure 8-23,

A5R79: Change value to 5100 ohms.

A5R81: Change value to 16K ohms.

Page 8-27, Figure 8-25,

A5R71: Change value to 5100 ohms.

A5R73: Change value to 16K ohms.

CHANGE 8

Table 6-2,

A3C36: Change to HP Part No. 0180-2202; C: FXD TA 0.1 UF 10% 35 VDCW.

A3L1: Change to HP Part No. 9100-2252, L: CHOKE .27 UH 10%.

A3R6: Change to HP Part No. 0698-7030; R: FXD METFLM 160 OHMS 2% 1/2W.

A3R73: Change to HP Part No. 0757-0951; R: FXD METFLM 13K OHMS 2% 1/4W.

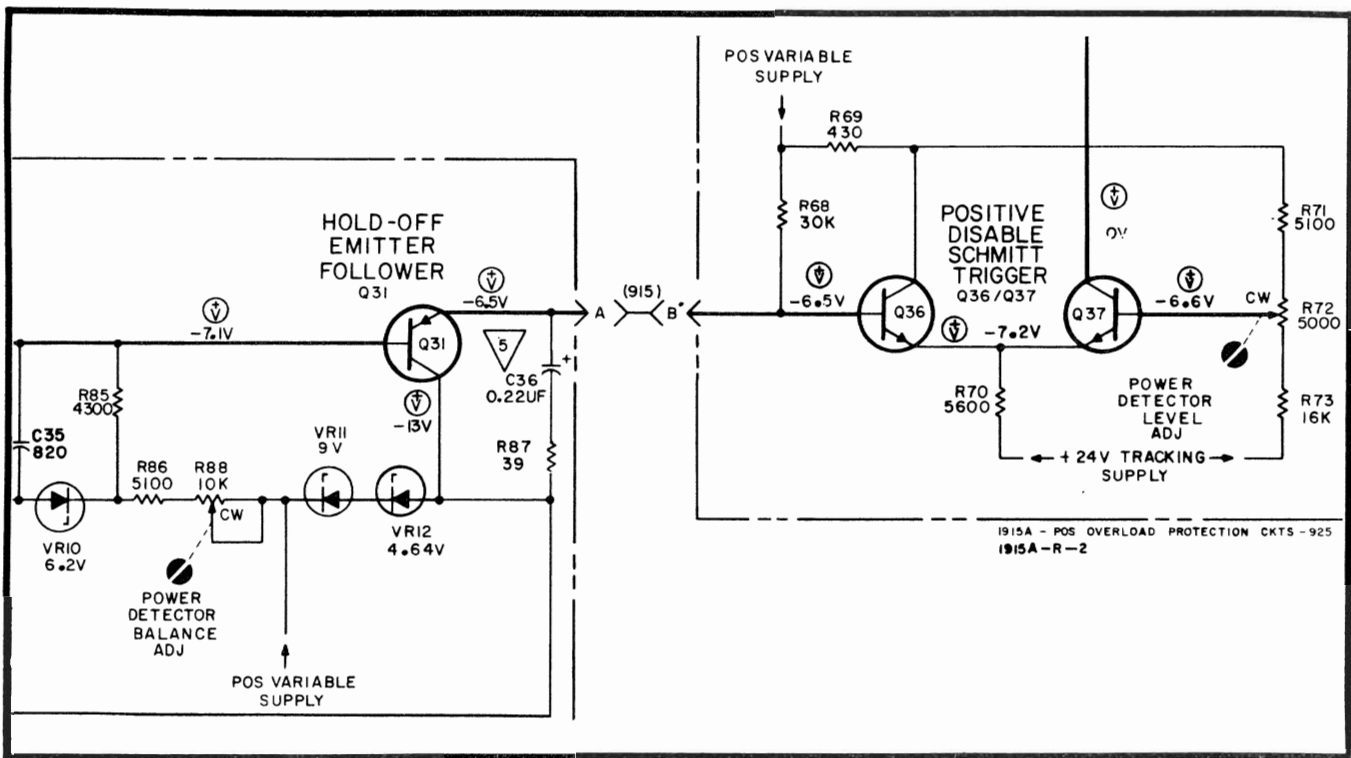

Figure 7-3. Positive Overload Protection Schematic Corrections

- A3R74: Change to HP Part No. 0757-0951; R: FXD METFLM 13K OHMS 2% 1/4W.
- A4C36: Change to HP Part No. 0180-2202; C: FXD TA 0.1 UF 10% 35 VDCW.
- A4L1: Change to HP Part No. 9100-2252; L: CHOKE .27 UH 10%.
- A4R6: Change to HP Part No. 0698-7030; R: FXD METFLM 160 OHMS 2% 1/2W.
- A4R73: Change to HP Part No. 0757-0951; R: FXD METFLM 13K OHMS 2% 1/4W.
- A4R74: Change to HP Part No. 0757-0951; R: FXD METFLM 13K OHMS 2% 1/4W.
- A5R8: Change to HP Part No. 0757-0970; R: FXD METFLM 82K OHMS 2% 1/4W.
- A5R69: Change to HP Part No. 0757-0908; R: FXD METFLM 220 OHMS 2% 1/4W.
- A5R77: Change to HP Part No. 0757-0908; R: FXD METFLM 220 OHMS 2% 1/4W.
- R4: Change to HP Part No. 2100-2709; R: VAR CERMET 25K OHMS 20% 2W.
- R6: Delete.
- Page 8-17/8-18, Figure 8-11,
 - A5R8: Change value to 82K ohms.
 - R4: Change value to 25K ohms.
 - R6: Delete.
- Page 8-21, Figure 8-17,
 - A3L1: Change value to .27 UH.
 - A3R6: Change value to 160 ohms.
- Page 8-23/8-24, Figure 8-21,
 - A4L1: Change value to .27 UH.
 - A4R6: Change value to 160 ohms.
- Page 8-25/8-26, Figure 8-23,
 - A3C36: Change value to 0.1 UF.

- A3R73: Change value to 13K ohms.
- A3R74: Change value to 13K ohms.
- A5R77: Change value to 220 ohms.
- Page 8-27, Figure 8-25,
 - A4C36: Change value to 0.1 UF.
 - A4R73: Change value to 13K ohms.
 - A4R74: Change value to 13K ohms.
 - A5R69: Change value to 220 ohms.

CHANGE 9

- Table 6-2,
 - A2C17, A2C18: Delete.
 - A2R72: Change to HP Part No. 0758-0015; R: FXD METFLM 220 OHMS 5% 1/2W.
 - A2R73: Change to HP Part No. 0758-0015; R: FXD METFLM 220 OHMS 5% 1/2W.
 - A5R76: Change to HP Part No. 0757-0948; R: FXD METFLM 10K OHMS 2% 1/4W.
 - A5R77: Change to HP Part No. 0757-0915; R: FXD METFLM 430 OHMS 2% 1/4W.
- Page 8-19, Figure 8-13,
 - A2C17, A2C18: Delete.
 - A2R72: Change value to 220 ohms.
 - A2R73: Change value to 220 ohms.
- Page 8-25/8-26, Figure 8-23,
 - A5R76: Change value to 10K ohms.
 - A5R77: Change value to 430 ohms.

CHANGE 10

Table 6-2,

A5R68: Change to HP Part No. 0757-0948; R: FXD
METFLM 10K OHMS 2% 1/4W.

A5R69: Change to HP Part No. 0757-0915, R: FXD
METFLM 430 OHMS 2% 1/4W.

Page 8-27, Figure 8-25,

A5R68: Change value to 10K ohms.

A5R69: Change value to 430 ohms.

CHANGE 11

Table 6-2,

A7CR9, A7CR10, A7VR4, and A7VR5: Delete.

Page 8-29, Figure 8-29,

A7CR9, A7CR10, A7VR4, and A7VR5: Delete.

CHANGE 12

Table 6-2,

A3L1: Change to HP Part No. 9100-2247; L: CHOKE
0.1 UH 10%

Page 8-21, Figure 8-17,

A3L1: Change value to 0.1 UH.

CHANGE 13

Table 6-2,

A7CR7, A7CR8, A7VR2, and A7VR3: Delete.

A7R25: Add HP Part No. 0757-0933; R: FXD
METFLM 2400 OHMS 2% 1/4W.

A7R28: Add HP Part No. 0757-0933; R: FXD
METFLM 2400 OHMS 2% 1/4W.

Page 8-29, Figure 8-29,

A7CR7, A7CR8, A7VR2, and A7VR3: Delete.

Add: A7R25: 2400 ohms, from collector of A7Q13 to
Pos Variable Supply.

Add: A7R28: 2400 ohms, from collector of A7Q15 to
Neg Variable Supply.

7-5. SPECIAL OPTIONS.

7-6. Most customer special application requirements and/or specifications can be met by factory modification of a standard instrument. A standard instrument modified in this way will carry a special option number, such as Model 0000A/Option C01.

7-7. An operating and service manual and a manual insert are provided with each special option instrument. The operating and service manual contains information about the standard instrument. The manual insert for the special option describes the factory modifications required to produce the special option instrument. Amend the operating and service manual by changing it to include all manual insert information (and MANUAL CHANGES sheet information, if applicable). When these changes are made,

the operating and service manual will apply to the special option instrument.

7-8. If you have ordered a special option instrument and the manual insert is missing, notify the nearest Hewlett-Packard Sales/Service Office. Be sure to give a full description of the instrument, including the complete serial number and special option number.

7-9. STANDARD OPTIONS.

7-10. Standard options are modifications installed on HP instruments at the factory and are available on request. Contact the nearest Hewlett-Packard Sales/Service Office for information concerning standard options.

7-11. OPTION 001, ANALOG PROGRAMMING.

7-12. The Model 1915A Option 001 Program Receiver Assembly adapts the Model 1915A Variable Transition Time Output for use in a Model 1900A Option 001 Programmable Mainframe. With Option 001 installed, the WIDTH range and vernier, TRANSITION TIME range and verniers, AMPLITUDE range and vernier, OFFSET range and vernier, and POLARITY can be automatically controlled by an external program source. Range functions are controlled by contact closure to ground. Vernier functions are controlled by analog current.

7-13. A separate manual (HP Part No. 01915-90902) provides the necessary operating information, replaceable parts, adjustment procedure, and schematics for the Option 001 circuitry. The option manual pertains only to the program circuitry added to the standard Model 1915A and is used in conjunction with this manual.

7-14. OPTION 002, POSITIVE OUTPUT.

7-15. The Model 1915A Option 002 is a standard Model 1915A Variable Transition Time Output modified to provide positive-only pulse output and positive-only offset. This is accomplished by removal of circuit board A3 (HP Part No. 01915-66503). All other functions are the same as a standard instrument. Option 002 modification is identified by a metal tag mounted next to the serial tag on top of the front-panel casting.

7-16. PERFORMANCE CHECK AND ADJUSTMENTS. The performance check and adjustment procedure for the Model 1915A Option 002 is the same as for the standard Model 1915A except for the following:

- a. Omit all steps referring to NEG OUTPUT.
- b. Omit all steps referring to NEG OFFSET.

7-17. REPLACEABLE PARTS. Replaceable parts for the Model 1915A Option 002 are the same as for the standard Model 1915A except:

- a. Delete circuit board A3; 01915-66503.
- b. Delete all components listed under A3.

7-18. SCHEMATICS AND TROUBLESHOOTING. All schematics and troubleshooting information for the standard Model 1915A apply to the Model 1915A Option 002 except that portion of all schematics and troubleshooting information pertaining to circuit board A3.

7-19. OPTION 003, NEGATIVE OUTPUT.

7-20. The Model 1915A Option 003 is a standard Model 1915A Variable Transition Time Output modified to provide negative-only pulse output and negative-only offset. This is accomplished by removal of circuit board A4 (HP Part No. 01915-66504). All other functions are the same as a standard instrument. Option 003 modification is identified by a metal tag mounted next to the serial tag on top of the front-panel casting.

7-21. PERFORMANCE CHECK AND ADJUSTMENTS. The performance check and adjustment procedure for the Model 1915A Option 003 is the same as for the standard Model 1915A except:

- a. Omit all steps referring to POS OUTPUT.
- b. Omit all steps referring to POS OFFSET.

7-22. REPLACEABLE PARTS. Replaceable parts for the Model 1915A Option 003 are the same as for the standard Model 1915A except:

- a. Delete circuit board A4; 01915-66504.
- b. Delete all components listed under A4.

7-23. SCHEMATICS AND TROUBLESHOOTING. All schematics and troubleshooting information for the standard Model 1915A apply to the Model 1915A Option 003 except that portion of all schematics and troubleshooting information pertaining to circuit board A4.

7-24. OPTION 004, VOLTAGE CALIBRATION.

7-25. The Model 1915A Option 004 is a standard Model 1915A Variable Transition Time Output modified to provide AMPLITUDE calibration for VOLTS INTO 50Ω. Four ranges provide from ±2.5V to ±50V from the high Z source into a 50-ohm external load or ±1.25V to ±25V from the 50-ohm source into a 50-ohm external load. Option 004 modification is identified by a metal tag mounted next to the serial tag on top of the front-panel casting.

7-26. Electrically the Model 1915A Option 004 is identical to the standard Model 1915A. The only changes have been in front-panel nomenclature. Table 7-2 provides a cross reference from the standard instrument to the Option 004.

Table 7-2. Option 004 AMPLITUDE Cross Reference

Option 004 1915A	Standard 1915A
1.25 - 3.12V	.05 - .125A
2.5 - 6.25V	.125 - .250A
5 - 12.5V	.250 - .500A
10 - 25V	.500 - 1A

7-27. REPLACEABLE PARTS. Table 7-3 lists the replaceable parts unique to the Model 1915A Option 004 and identifies the HP Part No. for each.

Table 7-3. Option 004 Replaceable Parts

Ref Desig	HP Part No.	TQ	Description
MP4	01915-67406	1	KNOB: AMPLITUDE
MP10	01915-00203	1	PANEL: FRONT

7-28. OPTION 005, DIGITAL PROGRAMMING.

7-29. The Model 1915A Option 005 Digital Programming provides the interface circuitry necessary for adapting the Model 1915A Variable Transition Time Output for use in a Model 1900A Option 001 Programmable Mainframe. With Option 005 installed, the width, amplitude, transition time, polarity, and offset of the output pulse can be automatically controlled by an external program source.

7-30. An HP Model 6936S Multiprogrammer is needed to convert the digital information from the computer to the proper digital range signals and the necessary analog vernier currents to drive the program receiver circuits in the Model 1915A Option 005. Included are the necessary digital-to-analog converter cards for the Model 6936S Multiprogrammer.

7-31. A separate manual (HP Part No. 01915-90908) provides the necessary operating information, replaceable parts, adjustment procedure and schematics for the Option 005 circuitry. The Option Manual pertains to the added circuitry in the Model 1915A as well as the digital-to-analog converter cards for the Model 6936S and is used in conjunction with the Model 1915A and Model 6936S Operating and Service manuals.

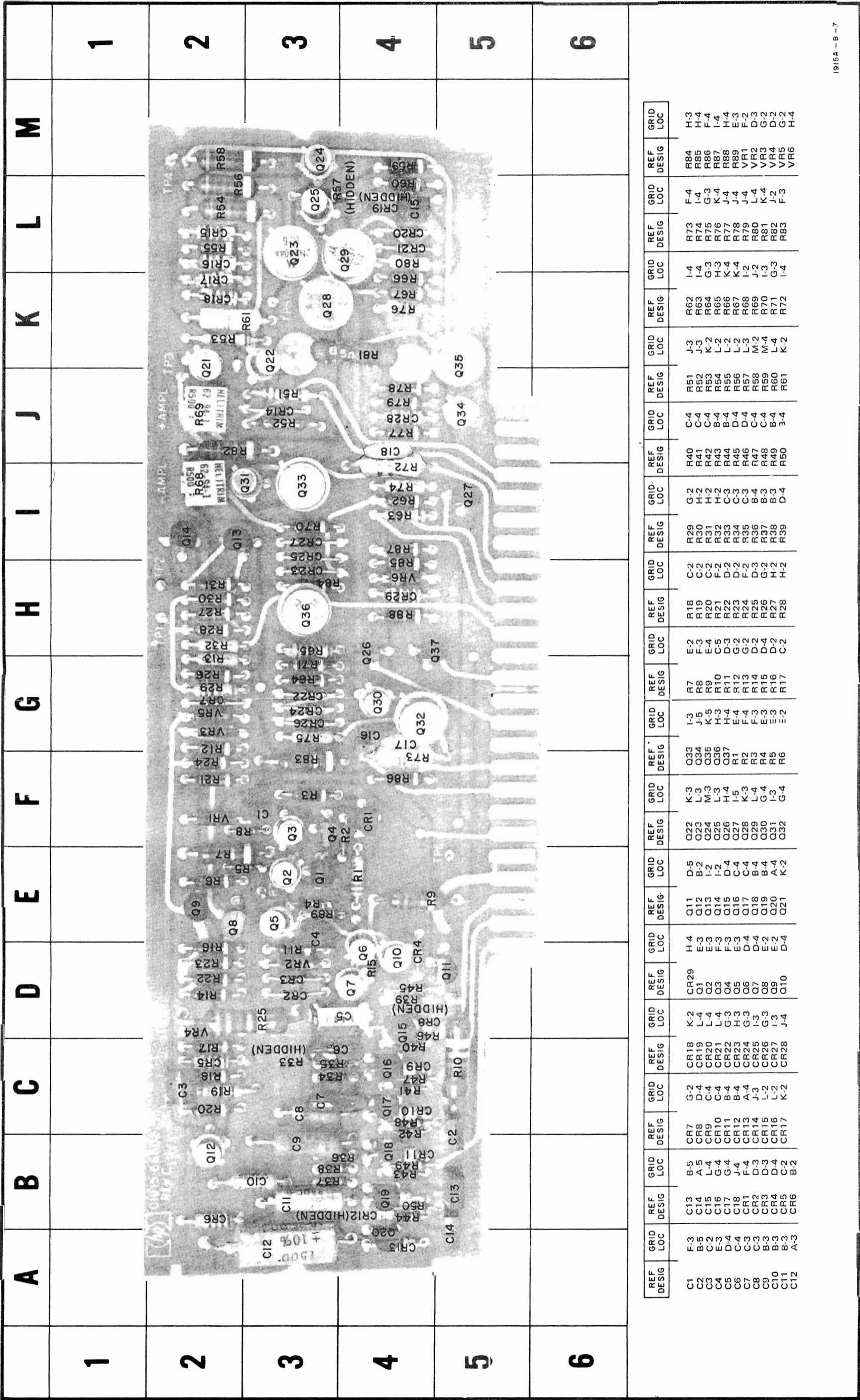

Figure 7-4. Input and Width Assembly, A2, Component Identification Page 7-7

Table 8-1. Schematic Notes

Refer to MIL-STD -15-1A for schematic symbols not listed in this table.



= Etched circuit board

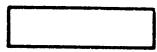

= Front-panel marking

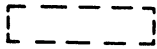

= Rear-panel marking

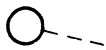

= Front-panel control



= Screwdriver adjustment

P/O

= Part of

CW

= Clockwise end of variable resistor

NC

= No connection



= Waveform test point (with number)



= Common electrical point (with letter) not necessarily ground



= Single-pin connector on board

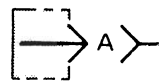

= Pin of a plug-in board (with letter or number)

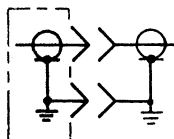

= Coaxial cable connected to snap-on jack

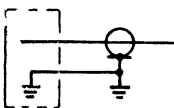

= Coaxial cable connected directly to board

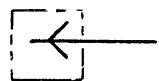

= Wire connected to pressure-fit socket on board



= Main signal path



= Primary feedback path



= Secondary feedback path



= Field-effect transistor (P-type base)



= Field-effect transistor (N-type base)



= Breakdown diode (voltage regulator)



= Tunnel diode



= Step-recovery diode



= Circuits or components drawn with dashed lines (phantom) show function only and are not intended to be complete. The circuit or component is shown in detail on another schematic.

(925) = Wire colors are given by numbers in parentheses using the resistor color code [(925) is wht-red-grn]

- | | |
|------------|------------|
| 0 - Black | 5 - Green |
| 1 - Brown | 6 - Blue |
| 2 - Red | 7 - Violet |
| 3 - Orange | 8 - Gray |
| 4 - Yellow | 9 - White |

Switch wafers are identified as follows:

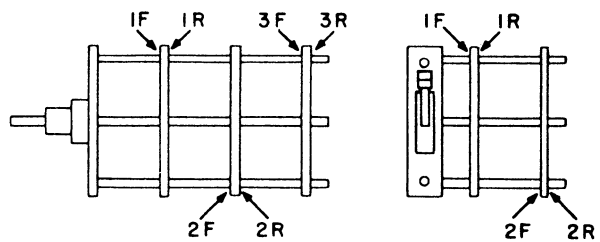

* = Optimum value selected at factory, typical value shown; part may have been omitted.

Unless otherwise indicated:
resistance in ohms
capacitance in picofarads
inductance in microhenries

SECTION VIII

SCHEMATICS AND TROUBLESHOOTING

8-1. INTRODUCTION.

8-2. This section contains schematics, repair and replacement information, component-identification illustrations, waveforms, test conditions, and troubleshooting procedures. Table 8-2 provides a guide to locating possible problems. Table 8-1 defines symbols and conventions used on the schematics.

8-3. SCHEMATICS.

8-4. Schematics are printed on fold-out pages for easy reference to the text and figures in other sections. The schematics are drawn to show the electronic function of the circuits. Any one schematic may include all or part of several different physical assemblies. Non MIL-standard symbols and conventions used in the schematics are defined in Table 8-1.

8-5. The schematics are numbered in sequence with a bold number in a box at the lower right-hand corner of each page. These numbers are used to cross reference signal connections between schematics. At each circuit breaking point, a notation is made of the signal name and a number (in bold type). This number indicates the associated schematic which contains the source or destination of the signal. To find the source or destination of any point on a given schematic, turn to the schematic referred to by number and find the name of the signal in question.

8-6. A reference designations table on each schematic lists all components shown on the schematic. Component reference designators which have been deleted from the schematic are listed below the table.

8-7. All components within the shaded areas of a schematic are physically located on etched circuit boards. Components not physically located on an etched circuit board are shown in the unshaded areas of the schematic.

8-8. REFERENCE DESIGNATION.

8-9. The unit system of reference designations used in this manual is in accordance with the provisions of the USA Standard Reference Designations for Electrical and Electronics Parts and Equipments dated March 1968. Minor variations due to design and manufacturing practices not specifically covered by the standard may be noted.

8-10. Each electrical component is identified by a class letter and number. This letter-number combination is the

basic designation for each component. Components which are separately replaceable and are part of an assembly have, in addition to the basic designation, a prefix designation indicating the assembly on which the component is physically located. Components not located on an assembly will have only the basic designation and are listed in the replaceable parts list (Section VI) under Chassis Parts.

8-11. All components within the shaded areas on the schematics are physically located on etched circuit boards and should be prefixed with the assembly number assigned to the particular board (e.g., resistor R23 on assembly A2 is referred to as A2R23). There may also be an R23 on several other assemblies but the assembly designation will always be different (A3R23, A9R23, etc.).

8-12. CIRCUIT BOARDS.

8-13. The following paragraphs provide information regarding board removal, interconnecting cables, pin numbering systems, and plug-in board extenders.

8-14. BOARD CONNECTIONS.

8-15. Circuit connections to the plug-in boards are of five general types: direct wire, coaxial cables to snap-on jacks, coaxial cables soldered directly to the board, single-pin connections, and pins at the bottom of the board that connect the etched circuitry of the board to the jack on the main chassis. The pins are not identified on the circuit board, but the connections on the mating jack are coded with both a number and a letter. Several letters (G, I, O, Q) have been omitted to avoid confusion. Table 8-1 shows the most common types of board connections used in the Model 1915A.

8-16. BOARD REMOVAL.

8-17. Circuit boards A2 through A9 are locked in place with a notched support bracket on each end of the board.

CAUTION

Allow at least 15 seconds after equipment turn-off for power supplies to discharge before installing or removing circuit boards from the chassis.

8-18. To remove a board, grasp rear portion of board, and pull up and forward. If difficulty is encountered, release the notched support bracket at each end of the board and pull up on the board. To reinstall, insert the board into

the tracks of the support brackets and press connector pins firmly into the jack.

8-19. BOARD EXTENDER.

8-20. Three plug-in board extenders (one for each different circuit board pin configuration) are provided with the Model 1915A. The extenders connect the circuit board assemblies to the instrument and raise the boards to a convenient level for circuit checks and adjustments.

8-21. COMPONENT IDENTIFICATION.

8-22. Locations of components on etched circuit boards are illustrated in photos adjacent to the schematics. Since the schematics are drawn to show function, a particular etched circuit board assembly may be shown on several schematics. The component identification photo is located next to the schematic that shows most of the circuitry on the board. Components located on the chassis are identified in Figure 8-2 through 8-4.

8-23. REPAIR AND REPLACEMENT.

8-24. Section VI provides a detailed parts list for use in ordering replacement parts. If satisfactory repair cannot be made, contact the nearest Hewlett-Packard Sales/Service Office (address at rear of manual). If shipment for repair is recommended, refer to Section II for repackaging and shipping instructions.

8-25. SERVICING ETCHED CIRCUIT BOARDS.

8-26. The Model 1915A has the multi-layer plated-through type etched circuit boards. When servicing this type of board, components may be removed or replaced by unsoldering from either side of the board.

8-27. When removing large components such as potentiometers, rotate the soldering iron tip from lead to lead while applying pressure to the part to lift it from the board. HP Service Note M-20E contains additional information on the repair of etched circuit boards. The important considerations are as follows:

- a. Do not apply excessive heat.
- b. Apply heat to component lead and remove lead with a straight pull away from the board.
- c. Use a toothpick or wooden splinter to clean hole.
- d. Do not force leads of replacement components into holes.

8-28. If the plated metal surface (conductor) lifts from the board, it may be cemented back with a quick-drying acetate-base cement (used sparingly) having good insulating properties. An alternate method of repair is to solder a good-conducting wire along the damaged area.

8-29. HEAT SINK REMOVAL.

8-30. There are five different heat sinks used in the Model 1915A. These are broken down into two main categories; friction type and screw-on type. The following paragraphs provide examples of the different types of heat sinks and how to remove them.



When removing heat sinks, use pliers with taped jaws to prevent burring or otherwise damaging the heat sink. The HP warranty concerning heat sinks will be void if they are damaged in this way.

8-31. FRICTION TYPE HEAT SINKS. There are three friction type heat sinks (e.g., A2MP1, HP Part No. 1205-0226; A3MP9, HP Part No. 1205-0095; and A5MP1, HP Part No. 1205-0037). To remove any of these, brace the transistor and carefully pull the heat sink off.

8-32. SCREW-ON TYPE HEAT SINKS. There are two different screw-on type heat sinks. To remove the first type (e.g. A3MP1, HP Part No. 1205-0073), identified by three cooling fins and a nut, remove the transistor from the circuit board. Grasp the cooling fins with the taped pliers and remove the nut with a 1/2-inch wrench.

Note

When reinstalling either screw-on type of heat sink, use a thermal compound or silicon grease on the transistor case to insure proper heat transfer from the transistor case to the heat sink. Also insure a tight mechanical connection between the heat sink and the transistor case.

8-33. To remove the second screw-on type heat sink (e.g. A3MP5, HP Part No. 1205-0231), remove the transistor from the circuit board. With a pair of taped pliers, grasp the cooling fins of the heat sink. Using a pair of long-nose pliers (e.g. Waldes Truarc Pliers No. 2), insert the tips into the two slots in the rim of the heat sink mounting core. Hold the mounting core secure and carefully unscrew the heat sink cooling fins.



If these heat sinks (HP Part No. 1205-0231) are not installed with a tight mechanical connection, the output transistors will fail.

8-34. REPLACING REED RELAY.

8-35. The reed relay located on assembly A7 consists of two separately replaceable parts, the coil and the reed. To replace either part, proceed as follows:

- a. Carefully unsolder reed leads and coil leads from the circuit board.
- b. Remove coil and reed together.
- c. Slide reed out of coil. Replace defective part, reassemble relay and resolder to circuit board.

8-36. OVERALL TROUBLESHOOTING.

8-37. The most important prerequisite for successful troubleshooting is an understanding of how the instrument is designed to operate and correct usage of front-panel controls. Often, suspected malfunctions are caused by improper control settings (such as improper adjustment of OFFSET control) or circuit connections (PGM selected when there is no program input connected). Operation Section III provides an explanation of controls and connectors, and general operating considerations. Principles of Operation Section IV provides circuit theory to satisfy this information requirement.

8-38. The following paragraphs outline procedures for locating and correcting problems in the Model 1915A.

8-39. DC VOLTAGES.

8-40. Dc voltages are indicated on some of the schematics for active components (transistor, etc.). Control setup conditions for making the voltage measurements are listed adjacent to each schematic. Since the conditions for making these measurements may differ from one circuit to another, always check the specific conditions listed adjacent to the schematic.

8-41. Dc voltage measurements are made with reference either to the positive variable power supply of the mainframe (⊕), the negative variable power supply of the mainframe (⊖), or ground (no symbol). The symbol beside the voltage notation on the schematic indicates the variable supply reference used for the measurement.

8-42. WAVEFORMS.

8-43. Typical waveform measurement points (ⓧ with a number enclosed) are placed on the schematics along main signal paths. The numbers inside the measurement point symbol (ⓧ) are keyed to corresponding waveforms adjacent to each schematic.

Note

Test points are also shown on the schematics with this symbol (TP ⊕). Test points correspond to pins protruding from the etched circuit board and do not necessarily correspond to waveform measurement points. Table 8-8 lists all the test points and their functions.

8-44. Conditions for making the waveform measurements are also listed adjacent to each schematic and, like the dc voltage measurement conditions, may vary from one circuit to another.

8-45. Voltage and waveform measurements provide an invaluable aid when troubleshooting the instrument. Applications include: checking gain of a particular stage, locating a differential amplifier unbalance, or pinpointing a faulty transistor. Also shown on the schematics are the primary signal paths. Signal paths are shown as solid, heavy lines.

8-46. INITIAL INSPECTION.

8-47. If trouble is suspected, visually inspect the instrument. Look for loose or burned components that might suggest a source of trouble. Check to see that all plug-in boards are making good contact and are not shorting to any adjacent circuit.

8-48. Severe damage to the Model 1900A mainframe can result from improper troubleshooting procedures. High output current and compactness of the instrument necessitate use of extreme caution when troubleshooting and handling the unit. Ensure adequate clearance between adjacent transistors and transistor heat sinks to avoid overheating. Use extreme care when using a probe to avoid shorting adjacent circuits. Follow the troubleshooting instructions carefully.

8-49. The troubleshooting procedure will not uncover a misadjustment of an internal control. Make the applicable adjustments (Section V) before attempting the troubleshooting procedure.

8-50. INITIAL PREPARATION.

8-51. PRECAUTIONS. Observe the following precautions when performing the troubleshooting procedure for the Model 1915A:

- a. Use an external fan while troubleshooting circuit boards on a board extender (especially when operating at high output currents).
- b. Always set AMPLITUDE control to 0 before turning power on.
- c. Allow at least 15 seconds after equipment turn-off to allow power supplies to discharge before installing or removing the plug-in from the Model 1900A mainframe, or installing or removing any circuit boards from the plug-in.

8-52. PRELIMINARY SETUP. Remove the Model 1915A from the Model 1900A mainframe, and proceed as follows:

- a. Remove connector bracket MP15 from the back of the plug-in.

Table 8-2. Overall Troubleshooting Table

MAJOR SYMPTOM	REMEDY
No Positive Output Pulse (negative ok)	See Output Troubleshooting Procedure, Paragraph 8-58. If ok, check reed relay A7K1.
No Negative Output Pulse (positive ok)	See Output Troubleshooting Procedure, Paragraph 8-58.
No Output Pulse (positive or negative)	See Output Troubleshooting Procedure, Paragraph 8-58. If output circuits check ok, follow main signal paths through Input and Width Schematic, through Transition Time and Duty Cycle Schematic to the output schematics.
No Internal Width Control (external width ok)	Check: width monostable A2Q6/Q7; internal grounding switch A2Q10; ext grounding switch A2Q11; in-ext switches A2Q8/Q9; in-ext width logic A2Q13/Q14 (Input and Width Schematic).
No External Width Control (internal width ok)	Check: width monostable A2Q6/Q7; ext-grounding switch A2Q11; int-ext switches A2Q8/Q9; int-ext width logic A2Q13/Q14 (Input and Width Schematic).
WIDTH Control Inoperative (internal and external)	Check: input amplifier A2Q1-Q4; width monostable A2Q6/Q7; int-ext switches A2Q8/Q9; int-ext width logic A2Q13/Q14 (Input and Width Schematic).
WIDTH Vernier Inoperative	Check: width vernier current source A2Q12 (Input and Width Schematic).
No LEADING EDGE Control (trailing edge ok)	Check: leading edge current source A5Q6; synchronous switch A5Q1-Q4 (Transition Time and Duty Cycle Schematic).
No TRAILING EDGE Control (leading edge ok)	Check: trailing edge current source A5Q5; synchronous switch A5Q1-Q4 (Transition Time and Duty Cycle Schematic).
No TRANSITION TIME Control (leading edge or trailing edge)	Follow main signal path through Transition Time and Duty Cycle Schematic.
No OFFSET	Check: positive and negative reference shifters A7Q1, and A7Q2; Darlington amplifiers A7Q3/Q7 and A7Q4/Q8; positive and negative offset switches A7Q5 and A7Q6 (Offset and Power Supply Schematic).
AMPLITUDE Vernier Inoperative	Follow main dc signal path through Amplitude Vernier Schematic.
OVERLOAD Light On (positive and negative polarities)	Reduce duty cycle by reducing WIDTH control, reduce AMPLITUDE control. If light is still on, check; duty cycle detector A5Q28-Q33 (Transition Time and Duty Cycle Schematic); or gate A5Q34; blinker circuit A2Q37; lamp driver A2Q36 (Negative Overload Protection Schematic).
OVERLOAD Light On (negative polarity only)	Follow main signal path through negative overload circuitry (Negative Overload Protection Schematic).
OVERLOAD Light On (positive polarity only)	Follow main signal path through positive overload circuitry (Positive Overload Protection Schematic).

- b. Remove top cover MP1 by sliding toward the rear of the plug-in.
- c. Set trigger select interface switch A10S1 (Figure 8-1) toward the front-panel for external trigger coupling.
- d. Connect internal 50-ohm terminations AT1R1A and AT1R1B (see Section III).
- e. Set Model 1915A front-panel controls as follows:

WIDTH 400-4K
 WIDTH vernier ccw
 TRANSITION TIME 10-1000
 LEADING EDGE ccw
 TRAILING EDGE ccw
 AMPLITUDE 0
 AMPLITUDE vernier ccw
 OFFSET OFF
 OFFSET vernier ccw
 POLARITY as required

- f. Using HP Model 10484A extender plug-in, install Model 1915A into Model 1900A mainframe.
- g. Connect an oscilloscope to Model 1915A OUTPUT jack to monitor any output signal.

8-53. TROUBLESHOOTING TABLE.

8-54. Table 8-2 lists major symptoms and possible remedies to correct the trouble. The major symptoms

listed are linked to front-panel control functions. The remedy listed is only designed to isolate the problem to the circuit level. From this point, use standard troubleshooting procedures in conjunction with the dc voltages and waveforms given for the schematics. Paragraph 8-56 provides a power supply check to verify that the power supplies are operating properly.

Note

If any adjustment controls are moved while troubleshooting the Model 1915A, perform the Adjustment Procedure listed in Section V of this manual.

8-55. DETAILED TROUBLESHOOTING.

8-56. POWER SUPPLY CHECK.

8-57. After performing the initial preparation described previously, make the power supply checks listed in Table 8-3. If the power supply does not check normal, make the check under Abnormal Result. If these checks do not locate the cause of the trouble, perform the Output Troubleshooting Procedure which follows. The cause is probably in the output circuits. All voltages in Table 3 are measured with respect to ground, except as noted.

Table 8-3. Power Supply Checks

POWER SUPPLY	NORMAL RESULT	ABNORMAL RESULT
-25V (A2TP2)	-25V	Check mainframe power supply.
-12V (A5TP4)	-12.8 ±.3V	Check -12V power supply A2Q34/Q35.
Neg Variable (A3TP3)	-28V	Check negative peak detector A3Q22-Q26.
-24V Tracking (A3TP2)	+24V (⊖)	Check -24V tracking supply A7Q15/Q16.
+25V (A5TP3)	+25V	Check mainframe power supply.
+12V (A5TP2)	+12.2 ±.3V	Check +12V power supply A7Q11/Q12.
Pos Variable (A4TP1)	+28V	Check positive peak detector A4Q22-Q25.
+24V Tracking (A4TP2)	-24V (⊕)	Check +24V tracking supply A7Q13/Q14.

(⊖) Voltmeter referenced to Neg Variable Supply.
 (⊕) Voltmeter referenced to Pos Variable Supply.

8-58. OUTPUT TROUBLESHOOTING PROCEDURE.

8-59. The following troubleshooting procedure uses a process of elimination technique. Its function is not to pinpoint a trouble to a specific component, but to isolate the trouble to a major circuit. At this point, use basic troubleshooting procedures to pinpoint the faulty component. Follow this procedure in the order given as succeeding steps are dependent on previous circuits operating properly.

8-60. **AMPLITUDE VERNIER CHECKS.** This check verifies that the positive current source base supply (A2TP1) and negative current source base supply (A2TP3) are operating properly. With the power turned off, proceed as follows:



Allow at least 15 seconds after equipment turn-off for power supplies to discharge before installing or removing the plug-in from the Model 1900A mainframe, or installing or removing any circuit boards from the plug-in.

- a. Remove negative output circuit board A3 and positive output circuit board A4.
- b. Set POLARITY to NEG and turn mainframe power on.
- c. With voltmeter, measure positive current source base supply voltage to ground at A2TP1. When AMPLITUDE vernier is rotated, the voltage should remain constant at +20 volts. If the voltage varies, check positive disable switch A2Q26.
- d. Set POLARITY to POS.
- e. Voltage at A2TP1 should vary from +13V to +17V as AMPLITUDE vernier is rotated.
- f. Measure negative current source base supply voltage to ground at A2TP3 as AMPLITUDE vernier is rotated. The voltage should remain constant at -20V. If the voltage varies, check negative disable switch A2Q27.
- g. Set POLARITY to NEG.
- h. Voltage at A2TP3 should vary from -13V to -17V.

8-61. **BIAS LEVEL A5R15 AND FET CURRENT A5R23 ADJUSTMENTS.** If the power supplies and the amplitude vernier circuits check out correctly, perform the bias level adjustment as described in Paragraph 5-23 and the FET current adjustment as described in Paragraph 5-24.

8-62. **A3 NEGATIVE OUTPUT CHECK.** Before installing negative output circuit board A3, visually inspect for any broken transistor leads, loose heat sinks or browned resistor.

A loose heat sink will cause early failure of its associated transistor. If any resistors are browned, check associated transistors; one or more of them could be shorted. After the visual inspection, proceed as follows:

- a. Turn mainframe power off and allow 15 seconds for power supplies to discharge.
- b. Install negative output circuit board A3 on a circuit board extender.
- c. Connect internal 50-ohm termination AT1R1B by connecting coaxial cable AT1W2 to snap-on jack A3J2 (see Figures 8-2 and 8-15).
- d. Remove A3Q22 (plug-in transistor) from its socket.
- e. Set front-panel controls as follows:
 - WIDTH 400-4K
 - WIDTH vernier ccw
 - TRANSITION TIME 10-1000
 - LEADING EDGE ccw
 - TRAILING EDGE ccw
 - AMPLITUDE 0
 - AMPLITUDE vernier ccw
 - OFFSET OFF
 - OFFSET vernier ccw
 - POLARITY NEG
- f. Turn mainframe power on.
- g. Set AMPLITUDE vernier cw.

h. Measure the supply voltages listed in Table 8-4. Voltages are referenced to ground, except as noted.

Table 8-4. Negative Output Supply Checks (Disabled)

POWER SUPPLY	TEST POINT	RESULT
Neg Variable	A3TP3	-28V
-24V Tracking	A3TP2	-4V
Neg Base Tracking	A3TP1*	+14V \overline{v}

\overline{v} Voltmeter referenced to Neg Variable Supply

*If this voltage is incorrect, check A3Q11-Q14 for base leakage. Since all bases are in parallel, the only clue besides pulling the transistor would be a browned resistor in that transistor's current source (A3R48-R55).

8-63. If all the above checks are correct, turn mainframe power off (allow 15 seconds for power supplies to discharge) and install A3Q22 in its socket. Turn mainframe power on and make the checks listed in Table 8-5. Dc voltages are referenced to ground, except as noted.

Table 8-5. Negative Output Supply Checks (Enabled)

POWER SUPPLY	TEST POINT	NO DRIVE INPUT	DRIVE INPUT (1 kHz)
Neg Variable	A3TP3*	-68V	-28V
-24V Tracking	A3TP2**	-44V	-4V
Neg Base Tracking	A3TP1***	+14V (⊖)	+14V (⊖)

(⊖) Voltmeter referenced to Neg Variable Supply

*If this voltage stays at -68V, check for proper waveform at A5TP7 (input signal to transition time circuit), also check override amplifier A3Q22 to determine if it is defective. If voltage stays at -28V, check duty cycle detector A5Q28-Q33, also check negative peak detector A3Q22-Q25.

**This voltage must track 24V below (nearer ground) the negative variable supply.

***If this voltage is not +14V with respect to the negative variable supply, set AMPLITUDE vernier cw and adjust A3R57 until this voltage is achieved.

8-64. When all the preceding checks for negative output circuit A3 are correct, connect a trigger signal to the Model 1915A DRIVE INPUT connector. With the AMPLITUDE switch set to 0, check the OUTPUT on the monitor oscilloscope.

a. Check output baseline voltage by setting the oscilloscope vertical input for dc coupling. With the AMPLITUDE switch set to 0 (OFFSET switch OFF), the output baseline voltage should be 0 ±50 mV. If the baseline voltage is not 0 or if any pulses show up, check the dc voltages across current source resistors A3R48-R55. If any voltage drop is indicated, check that current source transistor for a short.



If baseline voltage is not 0 ±50 mV, do not change AMPLITUDE switch from 0.

b. If the negative output circuit board A3 checks out ok, turn the mainframe power off (allow 15 seconds for power supplies to discharge) and install negative output circuit board A3 in the instrument.

8-65. A4 POSITIVE OUTPUT CHECK. Before installing positive output circuit board A4, visually inspect for any broken transistor leads, loose heat sinks or browned resistors. A loose heat sink will cause early failure of its

associated transistor. If any resistors are browned, check associated transistors, one or more of them could be shorted. After the visual inspection proceed as follows:

a. Turn mainframe power off and allow 15 seconds for power supplies to discharge.

b. Install positive output circuit board A4 on a circuit board extender.

c. Connect internal 50-ohm termination AT1R1B by connecting coaxial cable AT1W1 to snap-on jack A4J2 (see Figures 8-2 and 8-19).

d. Remove A4Q22 (plug-in transistor) from its socket.

e. Set front-panel controls as follows:

- WIDTH 400-4K
- WIDTH vernier ccw
- TRANSITION TIME 10-1000
- LEADING EDGE ccw
- TRAILING EDGE ccw
- AMPLITUDE 0
- AMPLITUDE vernier ccw
- OFFSET OFF
- OFFSET vernier ccw
- POLARITY POS

f. Turn mainframe power on.

g. Set AMPLITUDE vernier cw.

h. Measure the supply voltages listed in Table 8-6. Voltages are referenced to ground, except as noted.

Table 8-6. Positive Output Supply Checks (Disabled)

POWER SUPPLY	TEST POINT	RESULT
Pos Variable	A4TP1	+28V
+24V Tracking	A4TP2	+4V
Pos Base Tracking	A4TP3*	-14V (⊕)

(⊕) Voltmeter referenced to Pos Variable Supply

*If this voltage is incorrect, check A4Q11-Q14 for base leakage. Since all bases are in parallel, the only clue besides pulling the transistor would be a browned resistor in that transistor's current source (A4R48-R55).

8-66. If all the above checks are correct, turn mainframe power off (allow 15 seconds for power supplies to discharge) and install A4Q22 in its socket. Turn mainframe power on and make the checks listed in Table 8-7. Dc voltages are referenced to ground, except as noted.

Table 8-7. Positive Output Supply Checks (Enabled)

POWER SUPPLY	TEST POINT	NO DRIVE INPUT	DRIVE INPUT (1 kHz)
Pos Variable	A4TP1*	+68V	+28V
-24V Tracking	A4TP2**	+44V	+4V
Pos Base Tracking	A4TP3***	-14V \downarrow	-14V \downarrow
\downarrow Voltmeter referenced to Pos Variable Supply			

*If this voltage stays at +68V, check for proper waveform at A5TP7 (input signal to transition time circuit), also check override amplifier A4Q22 to determine if it is defective. If voltage stays at +28V, check duty cycle detector A5Q28-Q33, also check positive peak detector A4Q22-Q25.

**This voltage must track 24V below (nearer ground) the positive variable supply.

***If this voltage is not -14V with respect to the positive variable supply, set AMPLITUDE vernier cw and adjust A4R57 until this voltage is achieved.

8-67. When all the preceding checks for the positive output circuit A4 are correct, connect a trigger signal to the Model 1915A DRIVE INPUT connector. With the Model 1915A AMPLITUDE switch set to 0, check the OUTPUT on the monitor oscilloscope.

a. Check output baseline voltage by setting the oscilloscope vertical input for dc coupling. With the AMPLITUDE switch set to 0 (OFFSET switch OFF), the output baseline voltage should be 0 ± 50 mV. If the baseline voltage is not 0 or if any pulses show up, check the dc voltages across current source resistors A4R48-R55. If any voltage drop is indicated, check that current source transistor for a short.



If baseline voltage is not 0 ± 50 mV, do not change AMPLITUDE switch from 0.

b. If the positive output circuit board A4 checks out ok, turn the mainframe power off (allow 15 seconds for the power supplies to discharge) and install positive output circuit board A4 in the instrument.

Note

If any adjustment controls have been moved during this troubleshooting procedure, perform the Adjustment Procedure listed in Section V of this manual.

Circuit Board Location	Test Point Pin Number	Test Point Description
A2	1	+ Current Source Base Supply Q30
A2	2	-25-volt Supply
A2	3	- Current Source Base Supply Q33
A2	4	L.E. Comp (emitter Q24)
A2	5	T.E. Comp (emitter Q22)
A2	6	Drive Input (base Q1)
A2	7	Input Amp Out (base Q5)
A3	1	- Base Tracking Supply
A3	2	-24-volt Tracking Supply
A3	3	- Variable Supply
A4	1	+ Variable Supply
A4	2	+24-volt Tracking Supply
A4	3	+ Base Tracking Supply
A5	1	Baseline Clamp (base Q7)
A5	2	+12-volt Supply
A5	3	+25-volt Supply
A5	4	-12-volt Supply
A5	5	Duty Cycle (emitter Q32)
A5	6	Bias Level Pot. (base Q4)
A5	7	(base Q2)
A7	1	Base A7Q9
A7	2	Base Q7
A7	3	Collector A7Q5
A7	4	Collector A7Q6

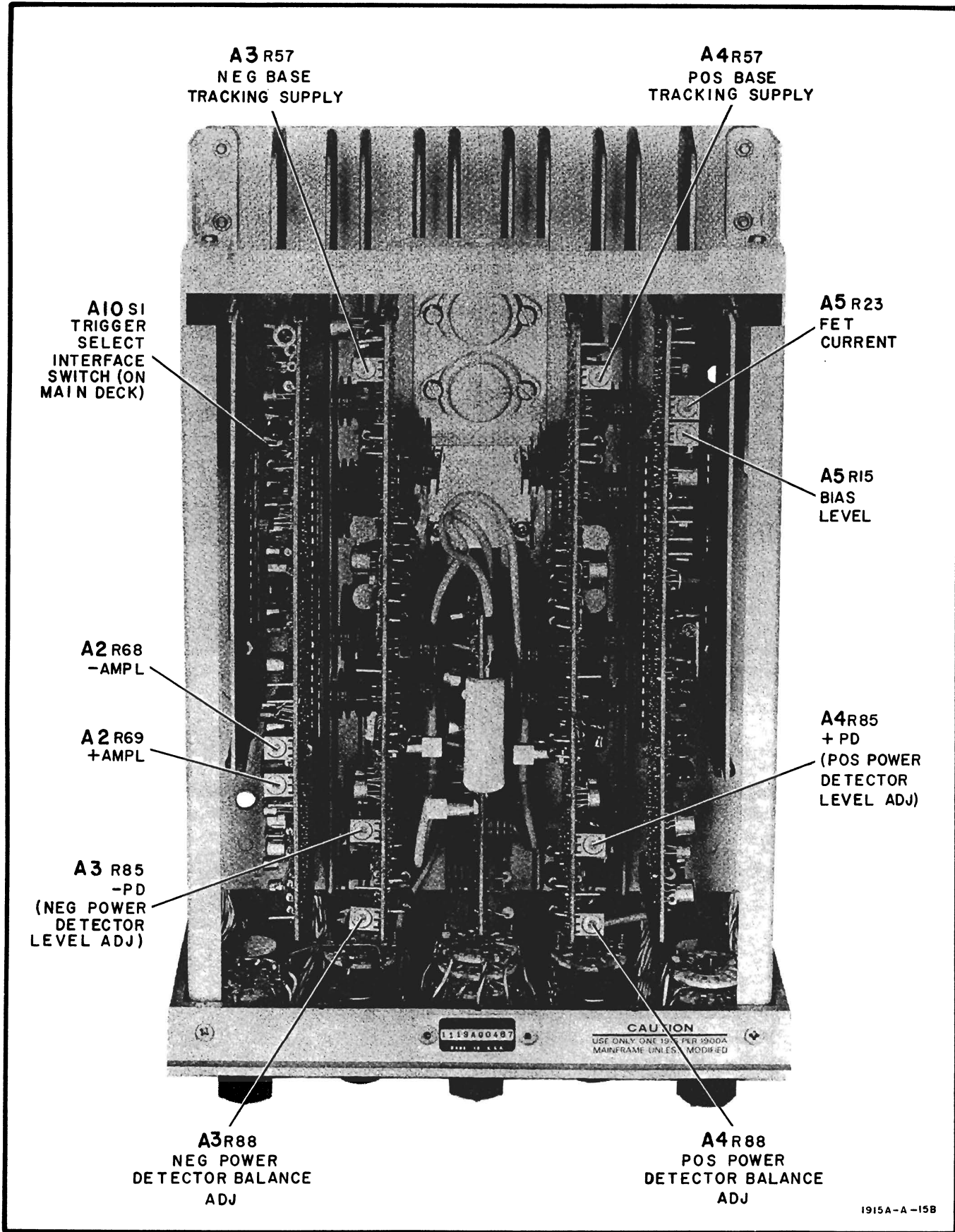

Figure 8-1. Adjustment Locations

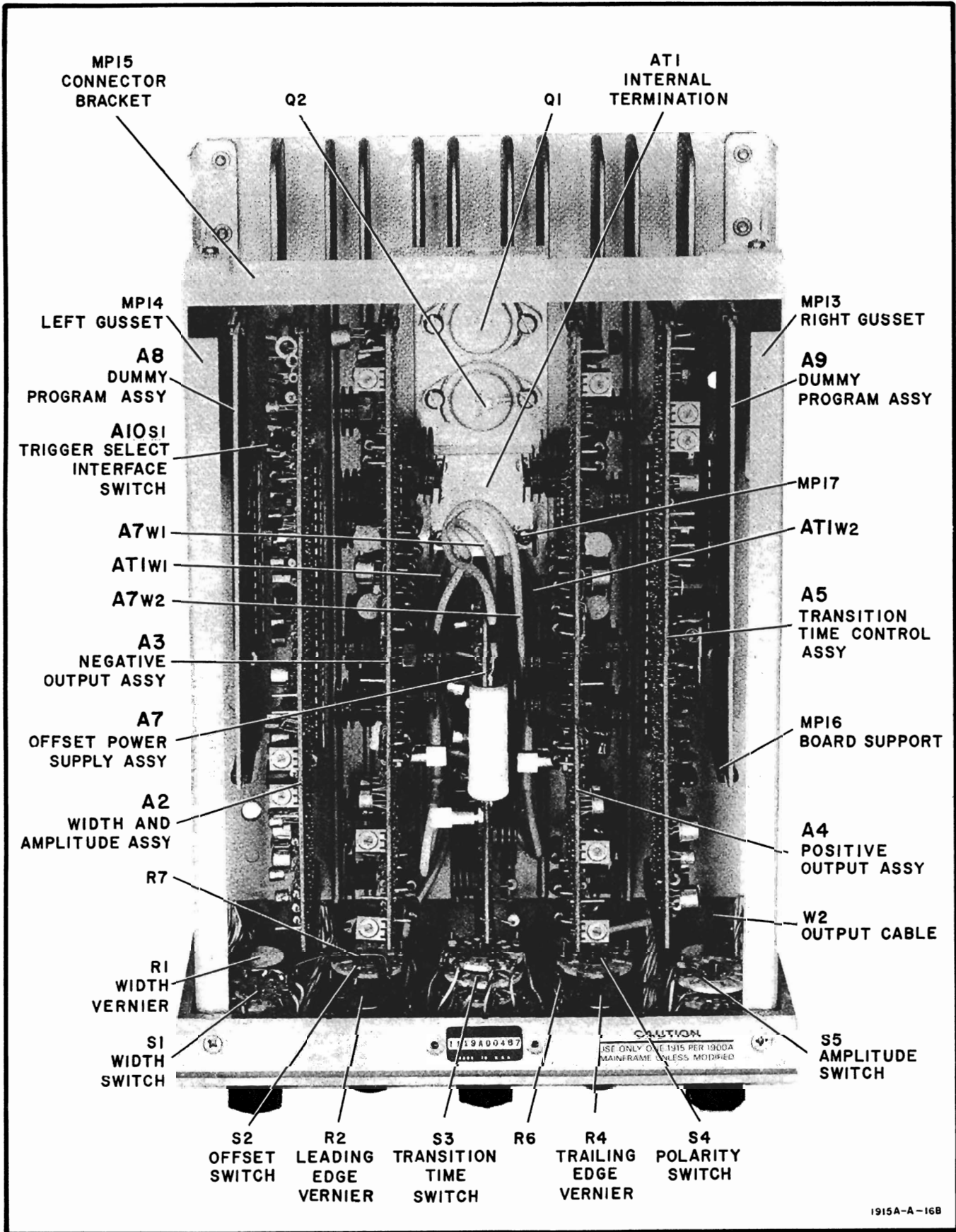

Figure 8-2. Assemblies and Chassis Mounted Parts Locations (Top View)

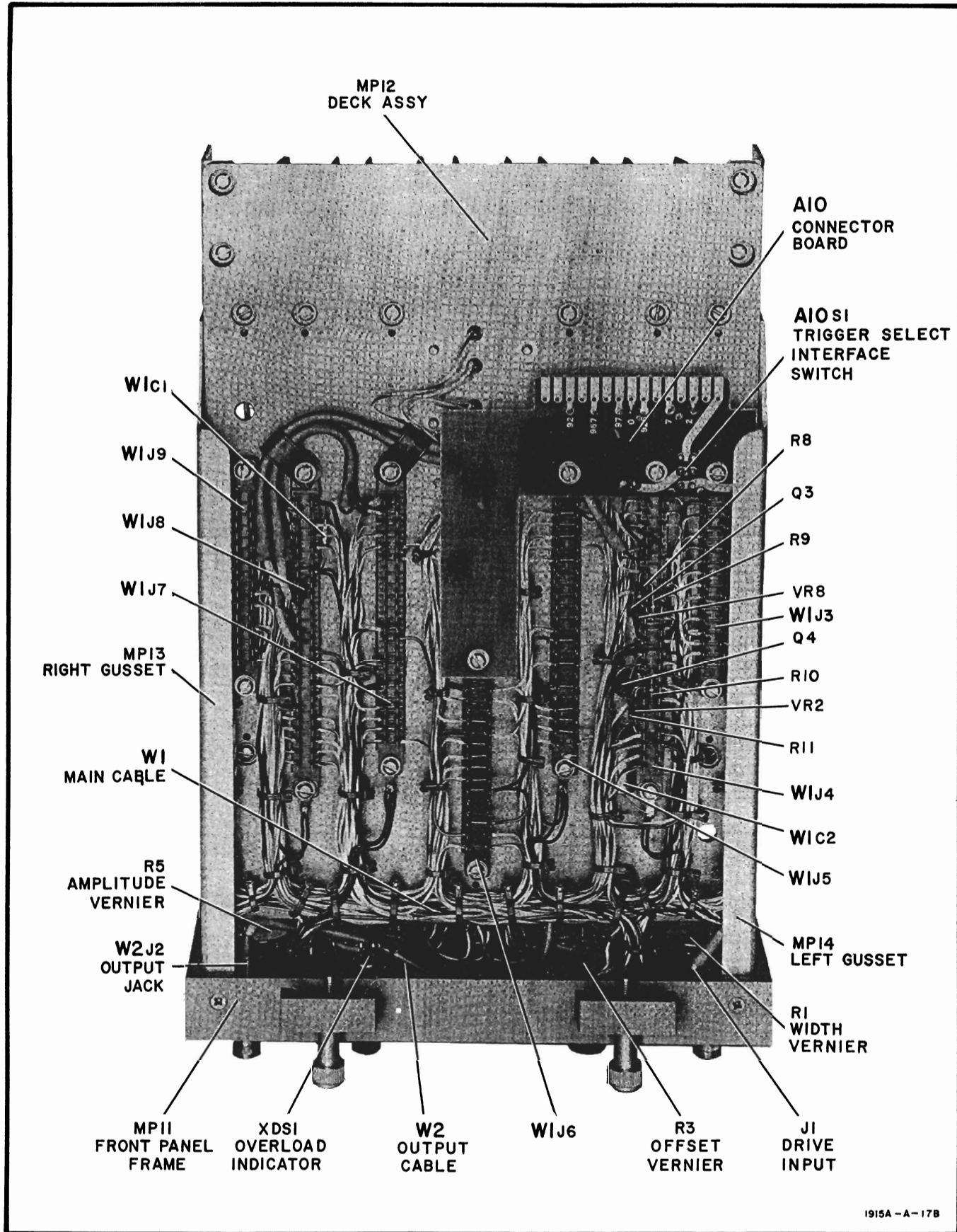
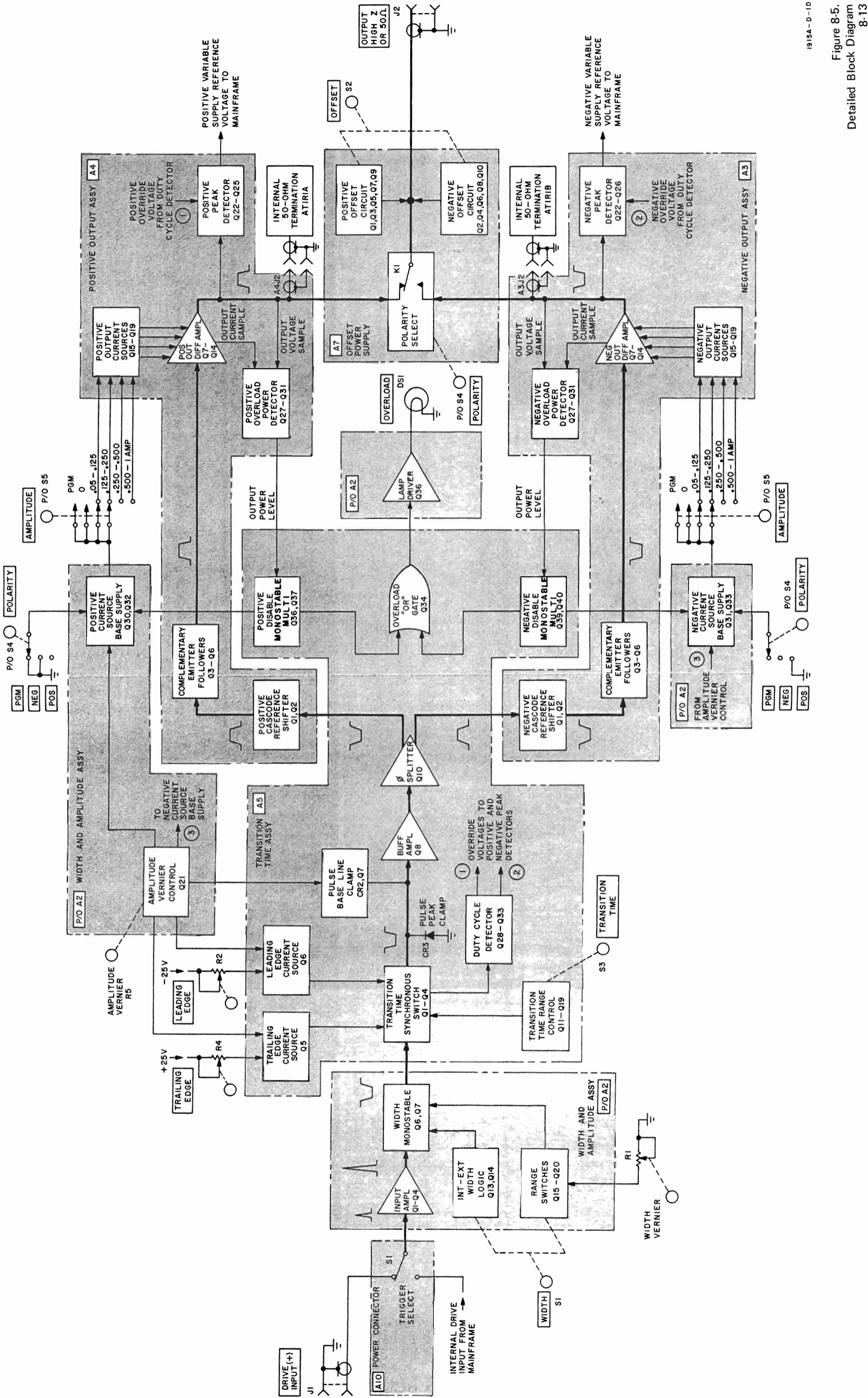

Figure 8-3. Mounted Parts Locations (Bottom View)



1915A-D-10

Figure 8-5.
Detailed Block Diagram
8-13

DC VOLTAGE MEASUREMENT CONDITIONS

WIDTH 4K-40K
 WIDTH vernier ccw (cw if indicated)
 TRANSITION TIME007-.2
 LEADING EDGE ccw
 TRAILING EDGE ccw
 AMPLITUDE 0
 AMPLITUDE vernier ccw
 OFFSET OFF
 OFFSET vernier ccw
 POLARITY NEG

Terminations

internal 50-ohm connected
 external load high impedance

No drive input trigger signal applied.

DC voltage measurements taken with voltmeter referenced to ground.

DC voltages shown on Q15 also apply to Q16 through Q20 (ON voltage applies when S1 is set to that range).

★ DC voltage measurement taken with WIDTH switch set to EXT.

WAVEFORM MEASUREMENT CONDITIONS

WIDTH04-.4
 WIDTH vernier 90° from full ccw
 TRANSITION TIME007-.2
 LEADING EDGE ccw
 TRAILING EDGE ccw
 AMPLITUDE 0
 AMPLITUDE vernier ccw
 OFFSET OFF
 OFFSET vernier ccw
 POLARITY NEG

Terminations

internal 50-ohm connected
 external load high impedance

Drive input trigger signal set for 25 kHz.

Waveforms 1, 2 and 3 taken with sampling oscilloscope. Use external trigger to delay presentation.

Waveforms 4, 5 and 6 taken with real-time oscilloscope.

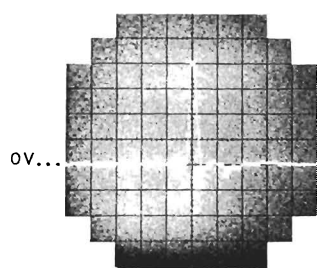

1 500 MV / DIV
20 NS / DIV

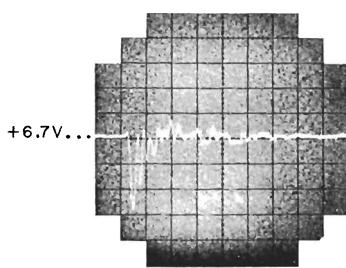

2 200 MV / DIV
20 NS / DIV

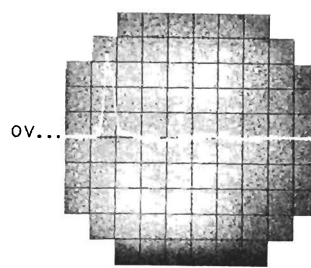

3 1V / DIV
20 NS / DIV

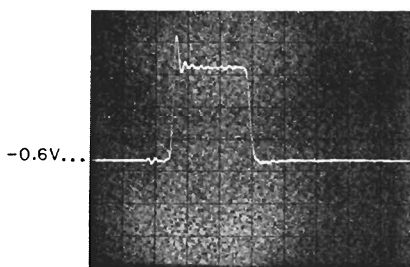

4 1V / DIV
50 NS / DIV

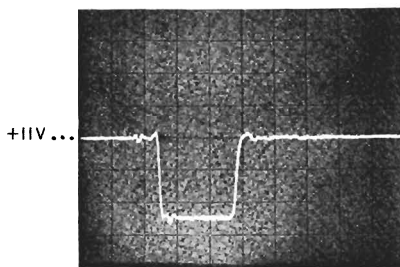

5 500 MV / DIV
50 NS / DIV

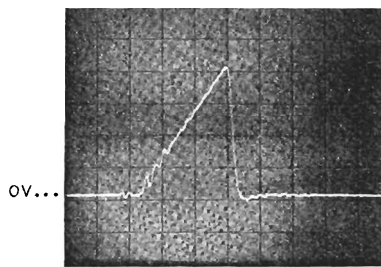

6 500 MV / DIV
50 NS / DIV

1915A-B-10A

Figure 8-7. Input and Width, A2, Waveforms and Measurement Conditions

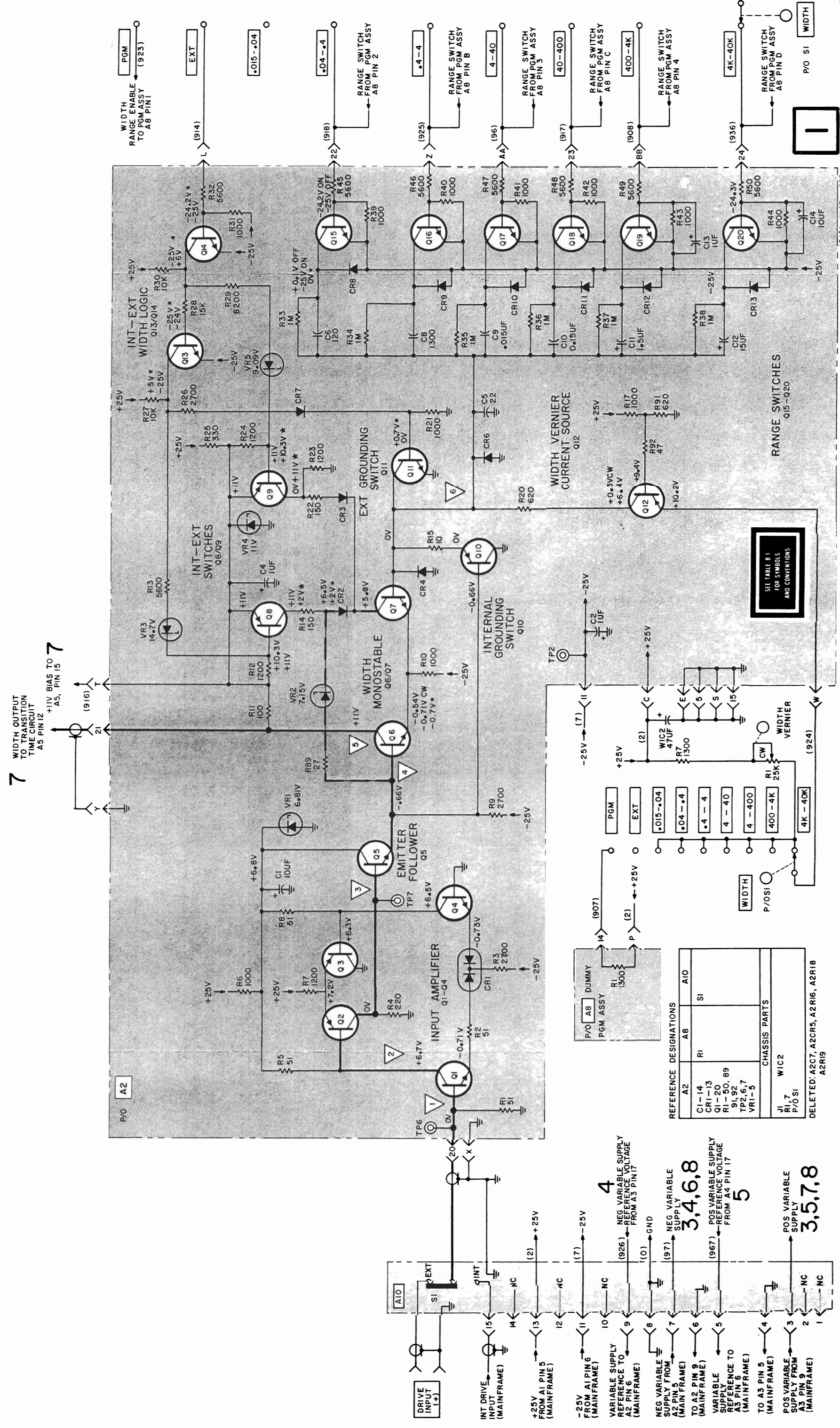

7 WIDTH OUTPUT TO TRANSITION TIME CIRCUIT A5 PIN 12
 +11V BIAS TO A5, PIN 15 (916)

P/O A2

WIDTH RANGE ENABLE TO PGM ASSY A8 PIN 1 (923)

EXT (914)

.015-.04

.04-.4

.4-4

4-40

40-400

400-4K

4K-40K

P/O SI WIDTH

7

P/O A2

WIDTH RANGE ENABLE TO PGM ASSY A8 PIN 1 (923)

EXT (914)

.015-.04

.04-.4

.4-4

4-40

40-400

400-4K

4K-40K

P/O SI WIDTH

7

P/O A2

WIDTH RANGE ENABLE TO PGM ASSY A8 PIN 1 (923)

EXT (914)

.015-.04

.04-.4

.4-4

4-40

40-400

400-4K

4K-40K

P/O SI WIDTH

Figure 8 Input and Width, A2, Schema 8.

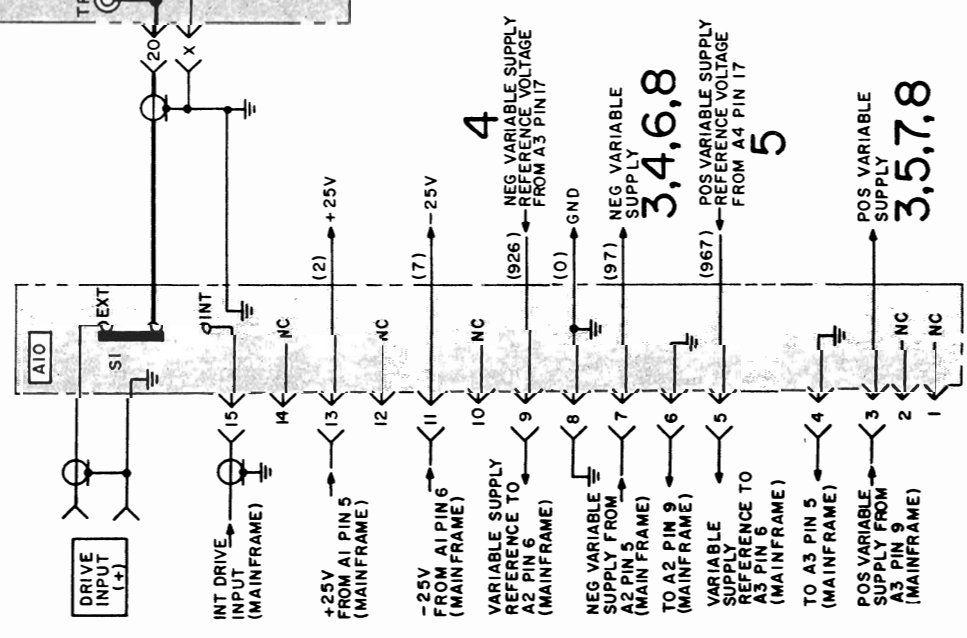

4

3,4,6,8

5

3,5,7,8

REFERENCE DESIGNATIONS	
A2	A10
C1-14	SI
CR1-13	R1
Q1-20	WIC2
R1-50, 89	P/O SI
91, 92	
TP2, 6, 7	
VR1-5	
CHASSIS PARTS	
J1, 7	
P/O SI	

DELETED: A2C7, A2CR5, A2R16, A2R18, A2R19

SEE TABLE B.1 FOR SYMBOLS AND CONVENTIONS

1915A-WIDTH-983
1915A-0-7A

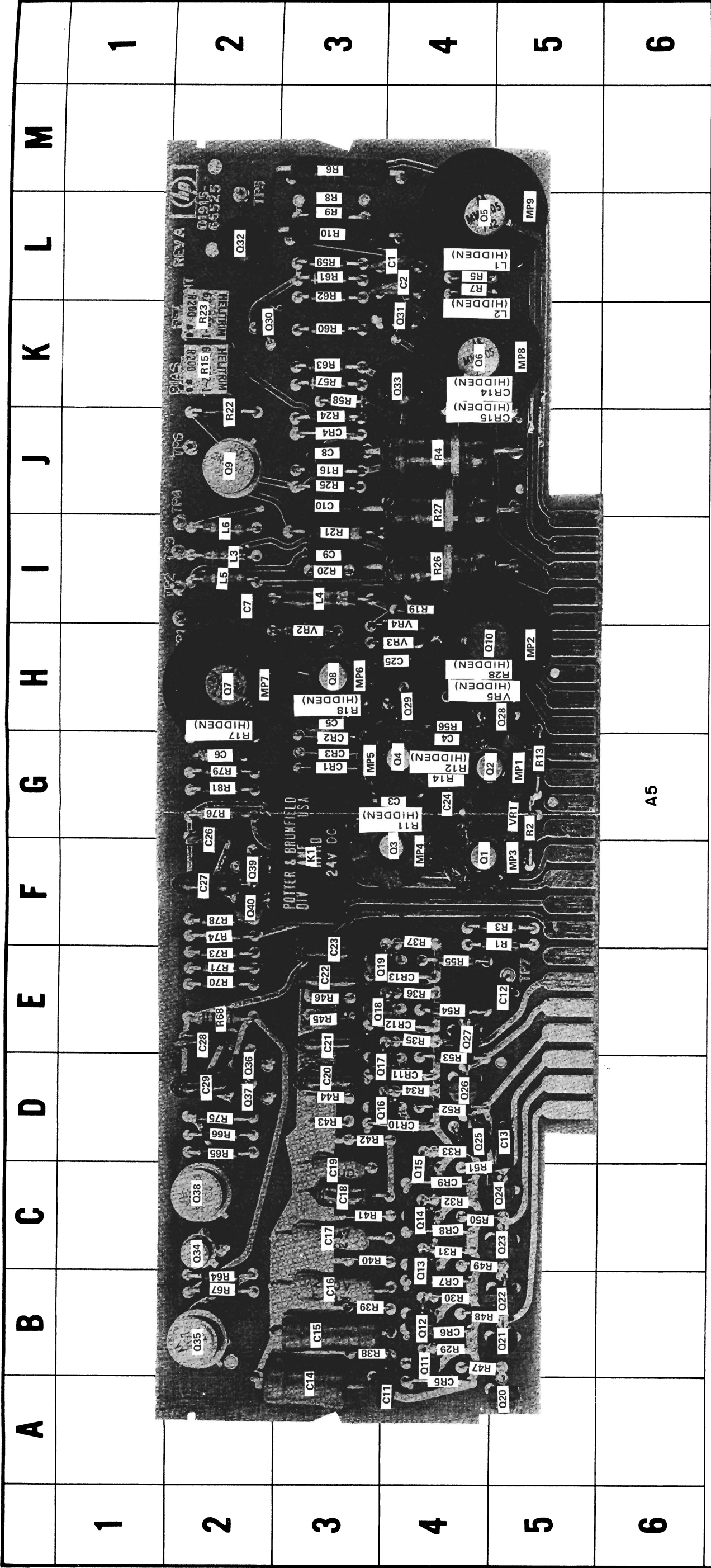

REF DESIG	GRID LOC	REF DESIG	GRID LOC	REF DESIG	GRID LOC	REF DESIG	GRID LOC	REF DESIG	GRID LOC	REF DESIG	GRID LOC	REF DESIG	GRID LOC	REF DESIG	GRID LOC	REF DESIG	GRID LOC		
C1	L-4	CR6	B-4	MP1	G-5	Q9	J-2	Q26	D-4	R3	F-5	R19	I-4	R35	E-4	R51	C-4	R67	B-2
C2	L-4	CR7	B-4	MP2	H-4	Q10	H-4	Q27	E-4	R4	J-4	R20	I-3	R36	E-4	R52	D-4	R68	E-2
C3	L-4	CR8	B-4	MP3	F-5	Q11	B-4	Q28	H-5	R5	L-4	R21	I-3	R37	F-4	R53	D-4	R70	E-2
C4	G-4	CR9	C-4	MP4	F-4	Q12	B-4	Q29	H-4	R6	M-3	R22	J-2	R38	B-3	R54	E-4	R71	E-2
C5	H-3	CR10	C-4	MP5	G-3	Q13	C-4	Q30	K-2	R7	L-4	R23	K-2	R39	B-3	R55	E-4	R72	E-2
C6	G-2	CR11	D-4	MP6	H-3	Q14	C-4	Q31	K-2	R8	L-4	R24	J-3	R40	C-3	R56	H-4	R73	E-2
C7	L-3	CR12	E-4	MP7	H-2	Q15	C-4	Q32	L-2	R9	L-3	R25	J-3	R41	C-3	R57	K-3	R74	F-2
C8	J-3	CR13	E-4	MP8	H-2	Q16	C-4	Q33	L-2	R10	L-3	R26	J-3	R42	C-3	R58	K-3	R75	D-2
C9	I-3	CR14	K-4	MP9	L-5	Q17	D-3	Q34	K-4	R11	L-3	R27	J-4	R43	D-3	R59	L-3	R76	G-2
C10	J-3	CR15	K-4	Q1	K-5	Q18	D-3	Q35	B-2	R12	G-4	R28	H-5	R44	D-3	R60	L-3	R77	G-2
C11	A-4	C28	F-2	Q2	F-4	Q19	F-3	Q36	B-2	R13	G-4	R29	H-5	R45	D-3	R61	L-3	R78	F-2
C12	E-5	C29	L-5	Q3	G-4	Q20	A-5	Q37	D-2	R14	G-4	R30	B-4	R46	E-3	R62	L-3	R79	G-2
C13	D-5	CR1	L-2	Q4	F-4	Q21	A-5	Q38	D-2	R15	G-4	R31	B-4	R47	E-3	R63	L-3	R81	G-5
C14	B-3	CR2	G-3	Q5	G-4	Q22	B-5	Q39	C-2	R16	K-2	R32	C-4	R48	B-4	R64	K-3	VR1	H-3
C15	B-3	CR3	L-4	Q6	K-4	Q23	B-5	Q40	F-2	R17	J-3	R33	C-4	R49	B-4	R65	B-2	VR2	H-4
C16	B-3	CR4	J-3	Q7	H-2	Q24	C-5	R1	F-5	R18	H-3	R34	D-4	R50	C-4	R66	D-2	VR4	H-4
C17	C-3	CR5	A-4	Q8	H-3	Q25	D-4	R2	G-5									VR5	H-5

Circuit boards have plated through component holes. This permits soldering from either side of the board.

1915A-B-8B

Figure 8-9. Transition-time Assembly, A5, Component Identification

DC VOLTAGE MEASUREMENT CONDITIONS

WIDTH4-4
 WIDTH vernier ccw
 TRANSITION TIME 10-1000
 LEADING EDGE ccw
 TRAILING EDGE ccw
 AMPLITUDE 0
 AMPLITUDE vernier ccw (cw if indicated)
 OFFSET OFF
 OFFSET vernier ccw
 POLARITY NEG

Terminations

internal 50-ohm connected
 external load high impedance

Drive input trigger signal (duty cycle detector measurements only, otherwise no input):

duty cycle detector off 25 kHz
 duty cycle detector ON no input

DC voltage measurements taken with voltmeter referenced to ground.

DC voltages on Q11 also apply to Q12 through Q20 (ON voltage applies when S3 set to that range).

WAVEFORM MEASUREMENT CONDITIONS

WIDTH04-.4
 WIDTH vernier 90° from full ccw
 TRANSITION TIME007-.2
 LEADING EDGE ccw
 TRAILING EDGE ccw
 AMPLITUDE 0
 AMPLITUDE vernier cw
 OFFSET OFF
 OFFSET vernier ccw
 POLARITY NEG

Terminations

internal 50-ohm connected
 external load high impedance

Drive input trigger signal set for 25 kHz.

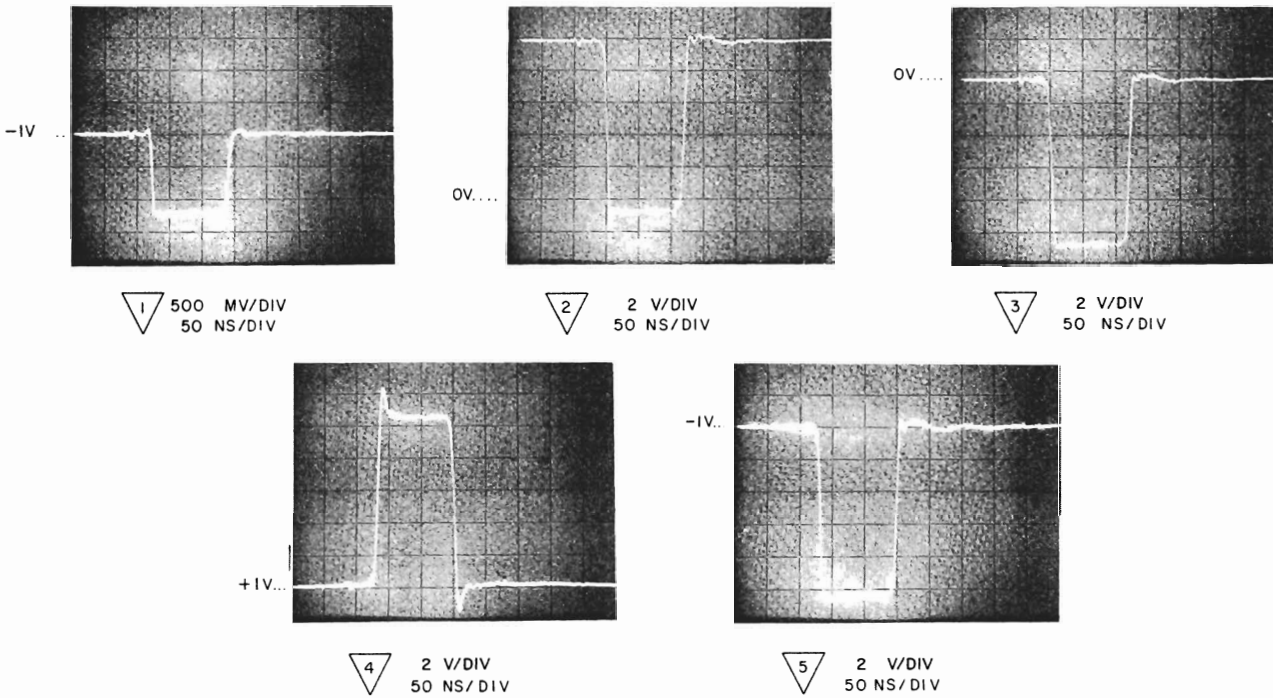
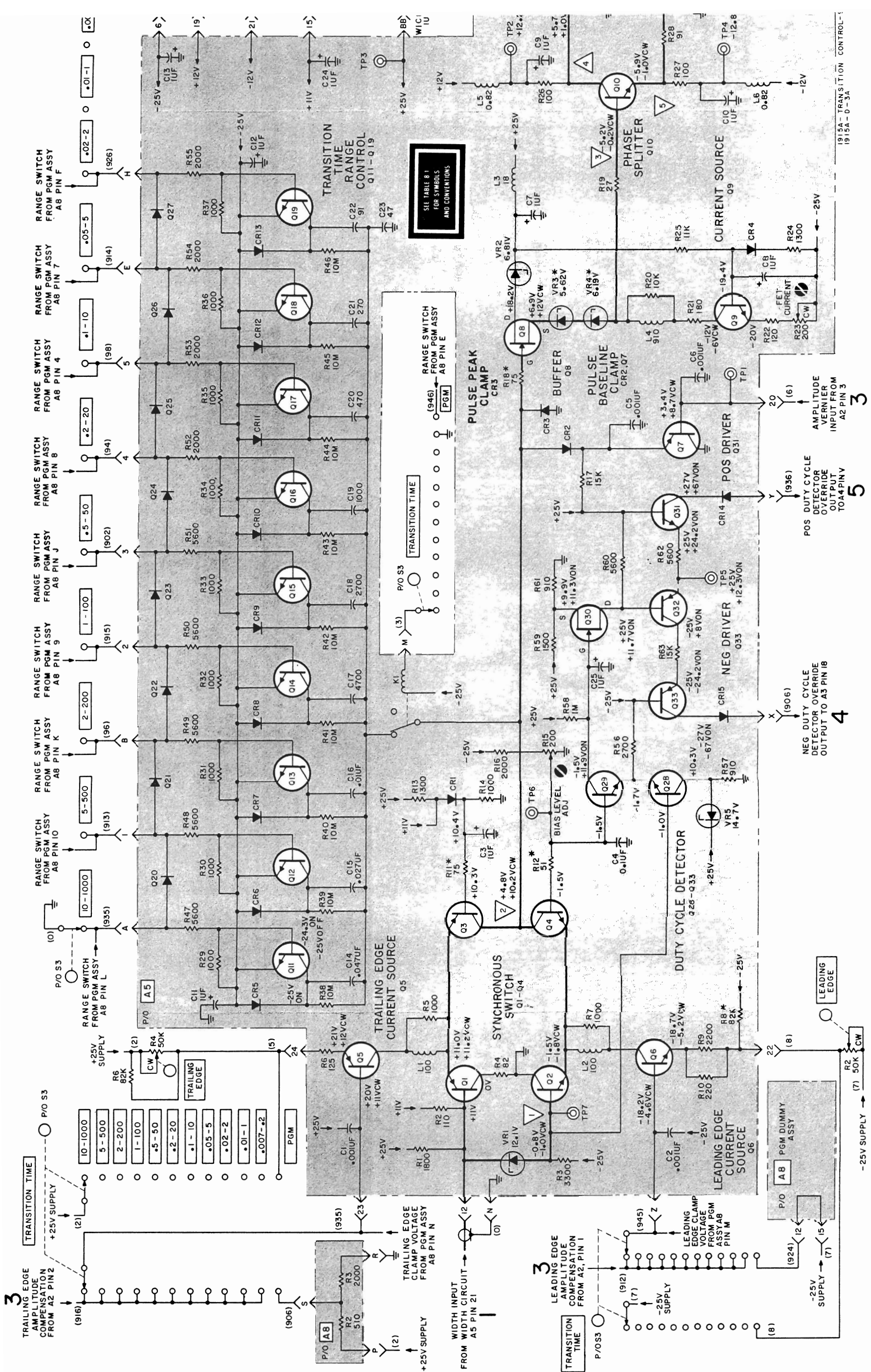

Figure 8-10. Transition-time and Duty Cycle, A5, Waveforms and Measurement Conditions



SCHEMATIC NOTES

The amplitude vernier circuit is located on the input and width assembly A2. To locate components in the amplitude vernier circuit, refer to the grid locator opposite the input and width schematic.

DC VOLTAGE MEASUREMENT CONDITIONS

WIDTH04-.4
WIDTH vernier	ccw
TRANSITION TIME007-.2
LEADING EDGE	ccw
TRAILING EDGE	ccw
AMPLITUDE05-.125
AMPLITUDE vernier	ccw (cw if indicated)
OFFSET	OFF
OFFSET vernier	ccw
POLARITY	POS for measurements taken in the positive current source base supply (except for measurements with ★). NEG for measurements taken in the negative current source base supply (except for measurements with ★).

Terminations

internal 50-ohm	connected
external load	high impedance

No drive input trigger signal applied.

DC voltage measurements taken with voltmeter referenced to ground unless otherwise indicated.

⓪ DC voltage measurement taken with voltmeter referenced to negative variable supply (A3TP3) instead of ground. The negative variable supply is fixed at -28 volts with A3Q22 removed.

Ⓢ DC voltage measurement taken with voltmeter referenced to positive variable supply (A4TP1) instead of ground. The positive variable supply is fixed at +28 volts with A4Q22 removed.

★ DC voltage measurement taken with circuit disabled (e.g. measurement with ★ in positive current source base supply taken with POLARITY switch set to NEG).

Figure 8-12. Amplitude Vernier, A2, Measurement Conditions

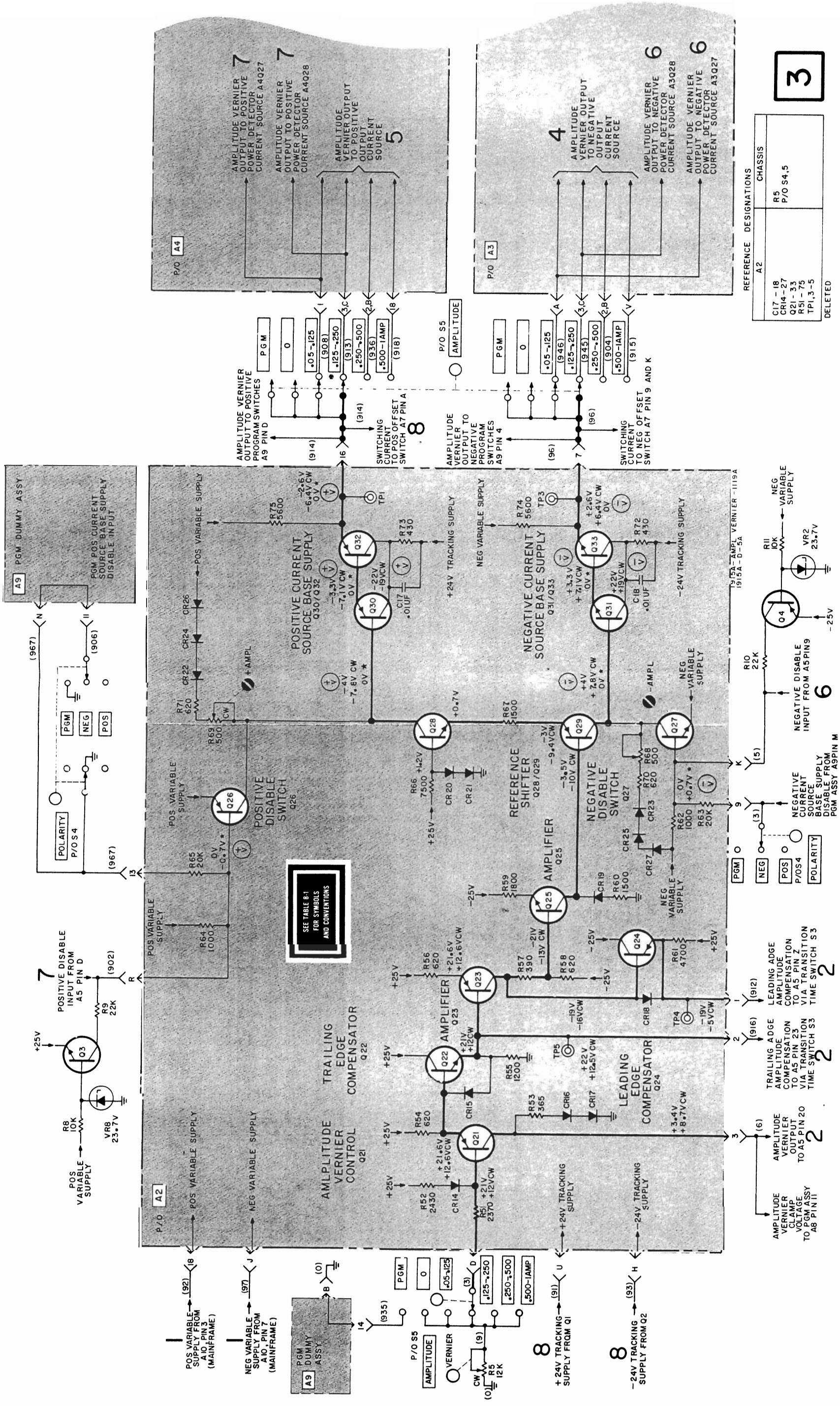
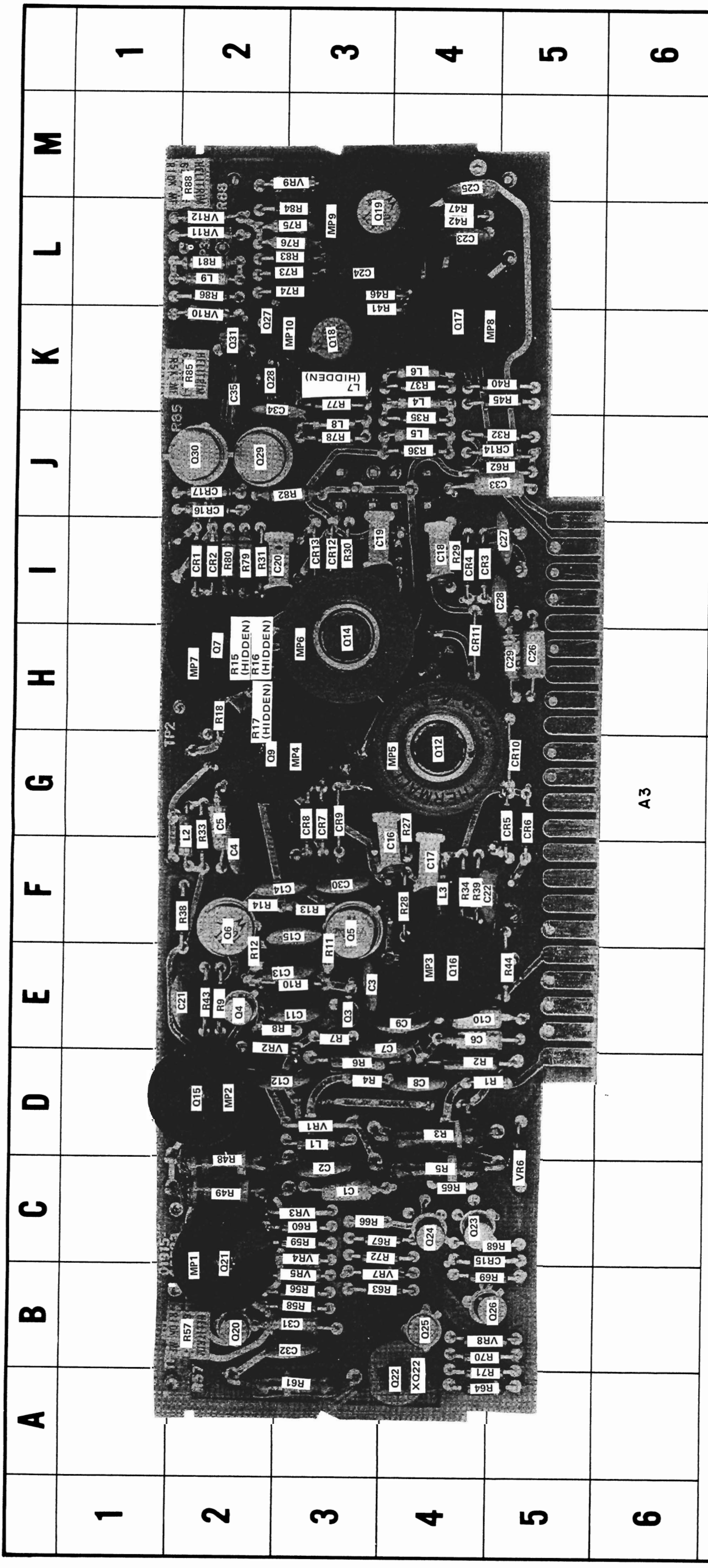

Figure 8-13.
Amplitude Vernier, A2, Schematic
8-19



REF. DESIG	GRID LOC	REF. DESIG	GRID LOC	REF. DESIG	GRID LOC	REF. DESIG	GRID LOC	REF. DESIG	GRID LOC	REF. DESIG	GRID LOC	REF. DESIG	GRID LOC	REF. DESIG	GRID LOC	REF. DESIG	GRID LOC	REF. DESIG	GRID LOC	
C1	C-3	C18	I-4	C35	K-2	CR16	J-2	MP7	H-2	Q20	B-2	R6	D-3	R31	I-2	R48	C-2	R70	B-4	
C2	C-3	C19	I-3	CR1	I-2	CR17	J-2	MP8	K-4	Q21	B-2	R7	E-3	R32	J-5	R49	C-2	R71	B-4	
C3	E-3	C20	E-2	CR2	I-2	D-3	D-3	MP9	L-3	Q22	A-4	R8	E-3	R33	G-2	R56	B-3	R72	C-3	
C4	F-2	C21	E-2	CR3	I-4	L-2	F-2	MP10	K-3	Q23	C-4	R9	E-2	R34	F-4	R57	B-2	R73	C-3	
C5	G-2	C22	F-4	CR4	I-4	L-3	F-4	O3	E-3	Q24	B-4	R10	E-3	R35	J-4	R58	B-3	R74	C-3	
C6	E-4	C23	L-4	CR5	G-5	L-4	K-4	O4	E-2	Q25	B-5	R11	E-2	R36	J-4	R59	C-3	R75	C-3	
C7	E-4	C24	L-3	CR6	G-5	L-3	J-4	O5	F-2	Q26	K-2	R12	E-2	R37	K-4	R60	C-3	R76	L-3	
C8	D-4	C25	M-4	CR7	G-3	L-3	K-4	O6	F-2	Q27	K-2	R13	F-2	R38	F-2	R61	A-3	R77	K-3	
C9	E-4	C26	H-5	CR8	G-3	L-3	K-3	O7	H-2	Q28	K-2	R14	F-2	R39	F-2	R62	J-5	R78	J-3	
C10	E-4	C27	I-5	CR9	G-3	L-3	J-3	O8	H-2	Q29	J-2	R15	H-2	R40	K-5	R63	B-4	R79	I-2	
C11	E-3	C28	I-5	CR10	G-5	L-9	L-2	O9	H-2	Q30	J-2	R16	H-2	R41	K-3	R64	A-4	R80	I-2	
C12	D-3	C29	H-5	CR11	H-4	L-9	B-2	O10	G-2	Q31	K-2	R17	H-2	R42	K-3	R65	A-4	R81	L-2	
C13	D-3	C30	F-3	CR12	H-4	L-3	B-2	O11	H-2	R1	K-2	R18	H-2	R43	L-4	R66	C-3	R82	L-2	
C14	F-3	C31	B-3	CR13	I-3	L-3	D-2	O12	H-2	R2	D-5	R19	H-2	R44	E-2	R67	C-3	R83	L-3	
C15	F-3	C32	B-3	CR14	J-4	L-4	E-4	O13	K-4	R3	D-4	R20	F-4	R45	E-5	R68	C-5	R84	L-2	
C16	F-4	C33	J-5	CR15	C-5	L-4	G-4	O14	K-3	R4	D-3	R21	I-4	R46	K-4	R69	B-4	R85	L-3	
C17	F-4	C34	K-2	CR16	H-3	L-3	H-3	O15	L-3	R5	C-4	R22	I-3	R47	L-4					
								O16				R23								
								O17				R24								
								O18				R25								
								O19				R26								
												R27								
												R28								
												R29								
												R30								
												R31								
												R32								
												R33								
												R34								
												R35								
												R36								
												R37								
												R38								
												R39								
												R40								
												R41								
												R42								
												R43								
												R44								
												R45								
												R46								
												R47								
												R48								
												R49								
												R50								
												R51								
												R52								
												R53								
												R54								
												R55								
												R56								
												R57								
												R58								
												R59								
												R60								
												R61								
												R62								
												R63								
												R64								
												R65								
												R66								
												R67								
												R68								
												R69								
												R70								
												R71								
												R72								
												R73								
												R74								
												R75								
												R76								
												R77								
												R78								
												R79								
												R80								
												R81								
												R82								
												R83								
												R84								
												R85								
												R86								
												R87								
												R88								
												R89								

Circuit boards have plated through component holes. This permits soldering from either side of the board.

1915A-B-12B

Figure 8-14. Negative Output Assembly, A3, Component Identification (Front View)

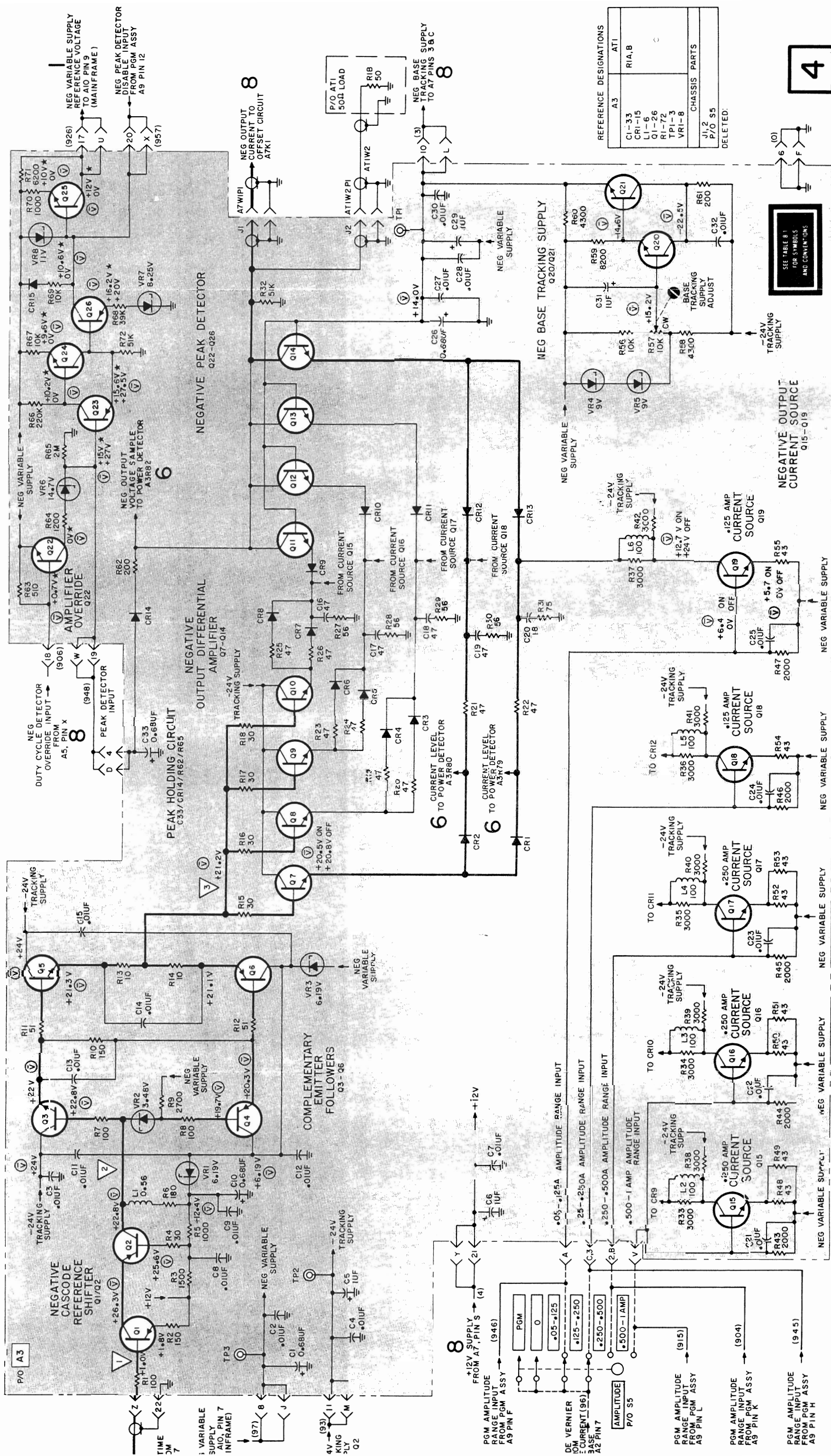

Figure 8-17. Negative Output, A3, Schematic 8-21

1915A - NEG OUTPUT AMPL - 925
1915A-9-8A

CONDITIONS

-04-.4
- 3m full ccw
-007-.2
- ... ccw
- ... ccw
-125-.250
- ... cw
- ... OFF
- ... ccw
- ... NEG

connected
50 ohms

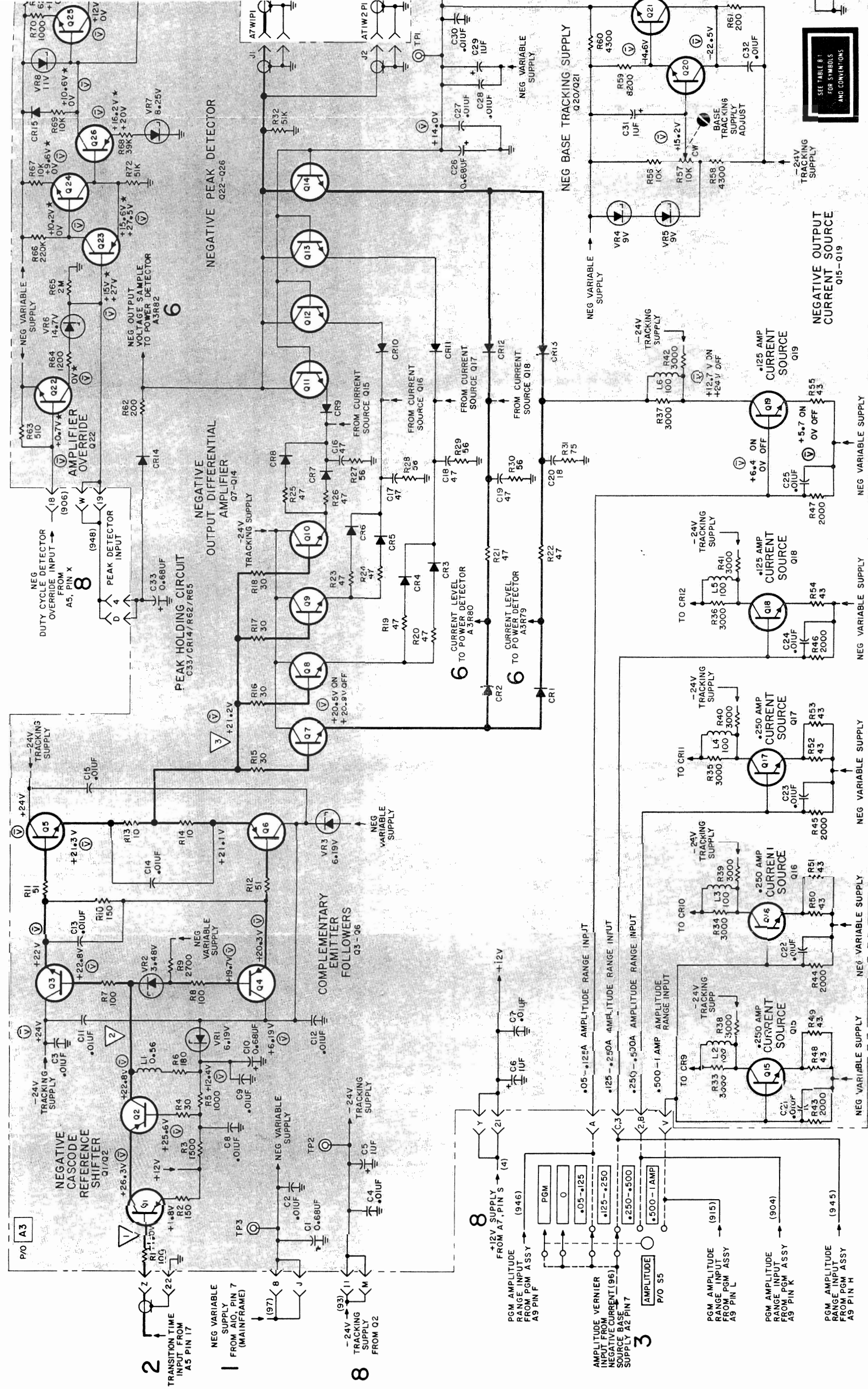

1915A-NEG OUTPUT AMPL - 925
1915A-0-8A

SEE TABLE B FOR SYMBOLS AND CONVENTIONS

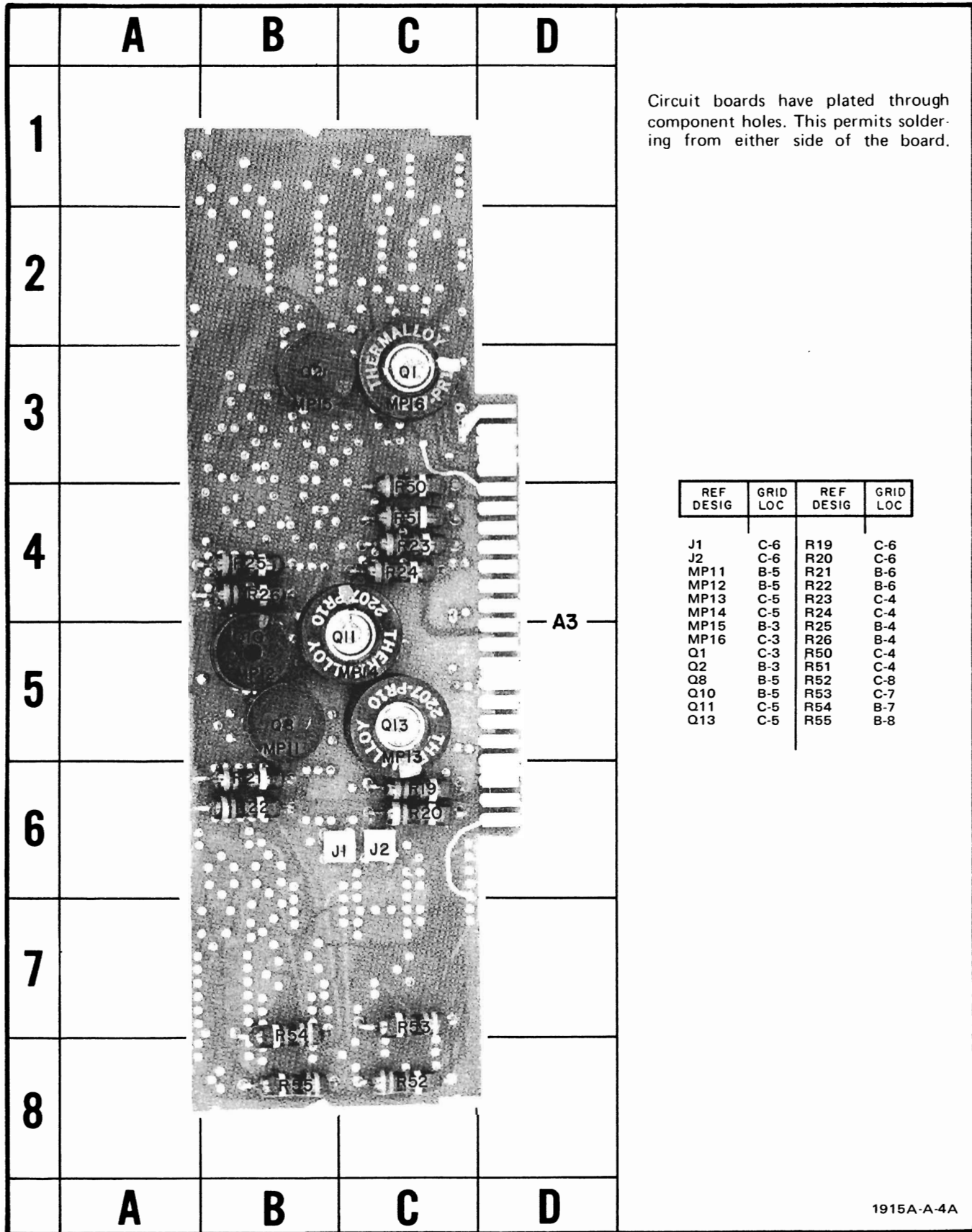

Figure 8-15. Negative Output Assembly, A3, Component Identification (Rear View)

DC VOLTAGE MEASUREMENT CONDITIONS

WIDTH04-.4
 WIDTH vernier ccw
 TRANSITION TIME007-.2
 LEADING EDGE ccw
 TRAILING EDGE ccw
 AMPLITUDE 0
 AMPLITUDE vernier cw
 OFFSET OFF
 OFFSET vernier ccw
 POLARITY NEG

Terminations
 internal 50-ohm connected
 external load high impedance

Remove A3Q22 (located in transistor socket).

No drive input trigger signal applied.

DC voltage measurements taken with voltmeter referenced to ground unless otherwise indicated.

DC voltages on Q19 also apply to Q15 through Q18 (ON voltage applies when S5 is set to that range).

DC voltages on Q7 also apply to Q8 through Q10 (ON voltage applies when current source for that range is turned ON).

Ⓣ DC voltage measurement taken with voltmeter referenced to negative variable supply (A3TP3) instead of ground.

★ These voltages taken with A3Q22 installed.

WAVEFORM MEASUREMENT CONDITIONS

WIDTH04-.4
 WIDTH vernier 90° from full ccw
 TRANSITION TIME007-.2
 LEADING EDGE ccw
 TRAILING EDGE ccw

AMPLITUDE125-.250
 AMPLITUDE vernier cw

OFFSET OFF

OFFSET vernier ccw

POLARITY NEG

Terminations
 internal 50-ohm connected
 external load 50 ohms

Drive input trigger signal set for 25 kHz.

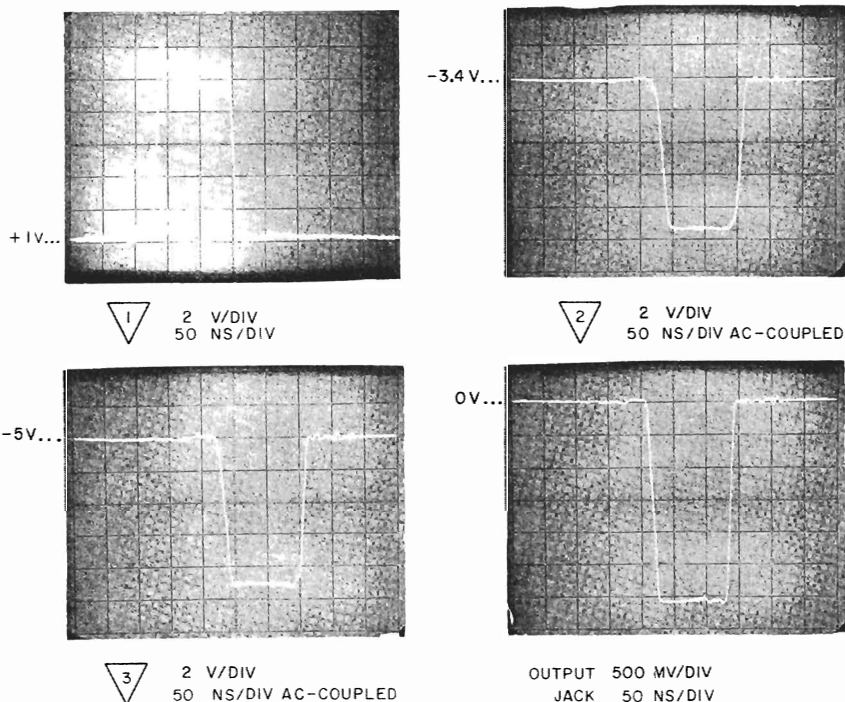

1915A - B - 4A

Figure 8-16. Negative Output Circuit, A3, Waveforms and Measurement Conditions

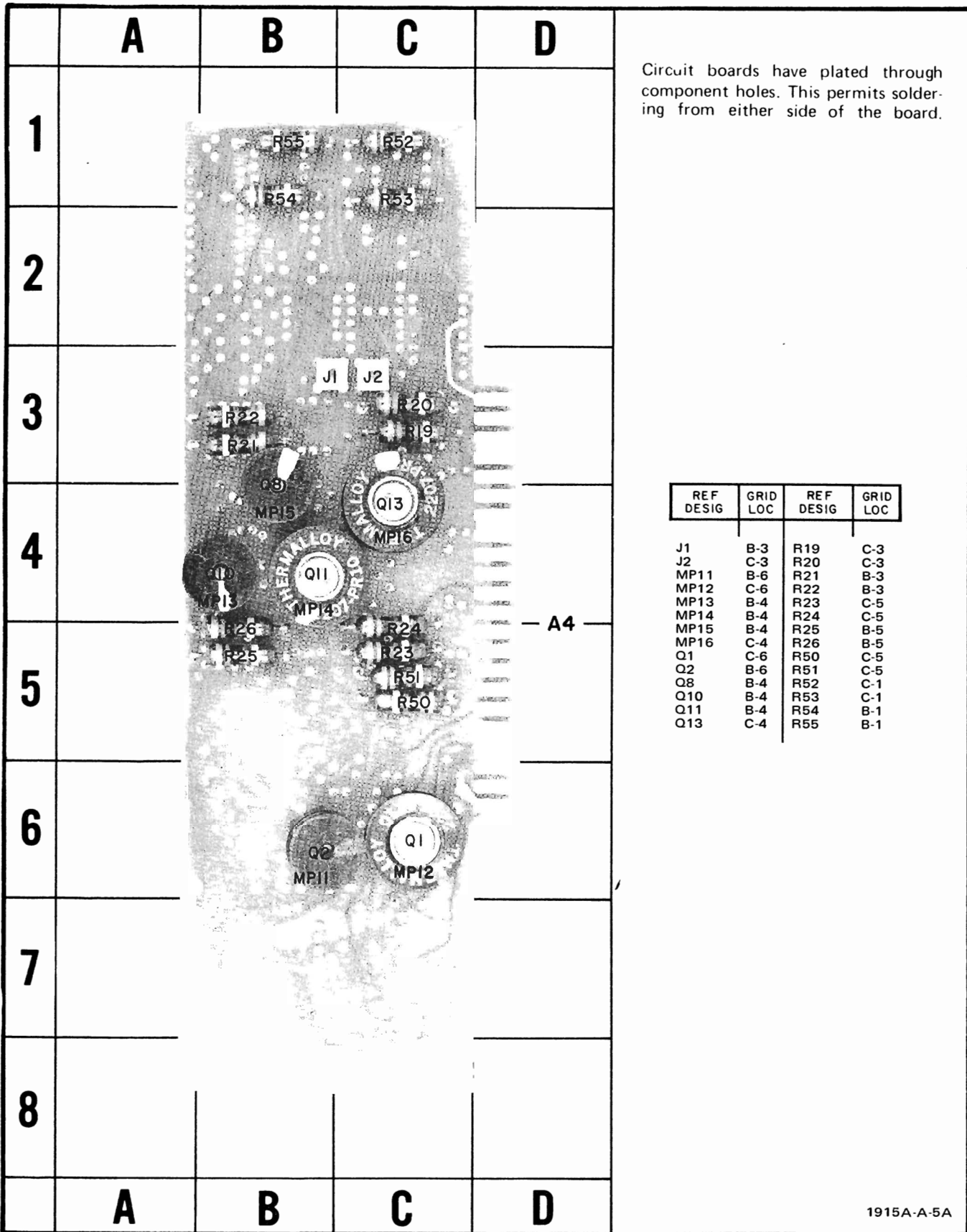

Figure 8-19. Positive Output Assembly A4, Component Identification (Rear View)

DC VOLTAGE MEASUREMENT CONDITIONS

WIDTH04-.4
 WIDTH vernier ccw
 TRANSITION TIME007-.2
 LEADING EDGE ccw
 TRAILING EDGE ccw
 AMPLITUDE 0
 AMPLITUDE vernier cw
 OFFSET OFF
 OFFSET vernier ccw
 POLARITY POS

Terminations

internal 50-ohm connected
 external load high impedance

Remove A4Q22 (located in transistor socket).

No drive input trigger signal applied.

DC voltage measurements taken with voltmeter referenced to ground unless otherwise indicated.

DC voltages on Q19 also apply to Q15 through Q18 (ON voltage applies when S5 is set to that range).

DC voltages on Q7 also apply to Q8 through Q10 (ON voltage applies when current source for that range is turned ON).

⊕ DC voltage measurement taken with voltmeter referenced to positive variable supply (A4TP1) instead of ground.

★ These voltages taken with A4Q22 installed.

WAVEFORM MEASUREMENT CONDITIONS

WIDTH04-.4
 WIDTH vernier 90° from full ccw
 TRANSITION TIME007-.2
 LEADING EDGE ccw
 TRAILING EDGE ccw
 AMPLITUDE125-.250
 AMPLITUDE vernier cw
 OFFSET OFF
 OFFSET vernier ccw
 POLARITY POS

Terminations

internal 50-ohm connected
 external load 50 ohms

Drive input trigger signal set for 25 kHz.

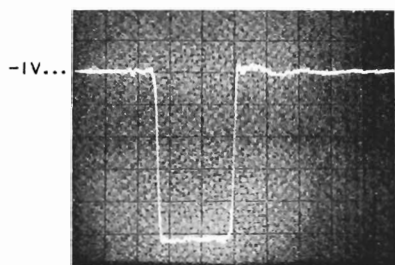

1 2 V/DIV
50 NS/DIV

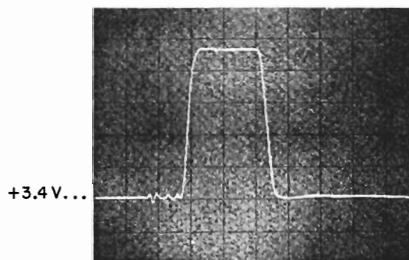

2 2 V/DIV
50 NS/DIV AC COUPLED

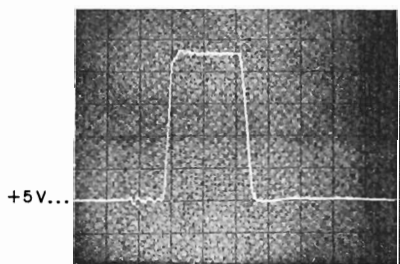

3 2 V/DIV
50 NS/DIV AC COUPLED

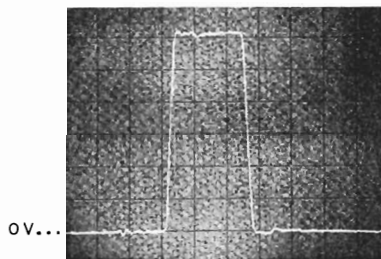

OUTPUT JACK 500 MV/DIV
50 NS/DIV

1915A-B-3A

Figure 8-20. Positive Output Circuit, A4, Waveforms and Measurement Conditions

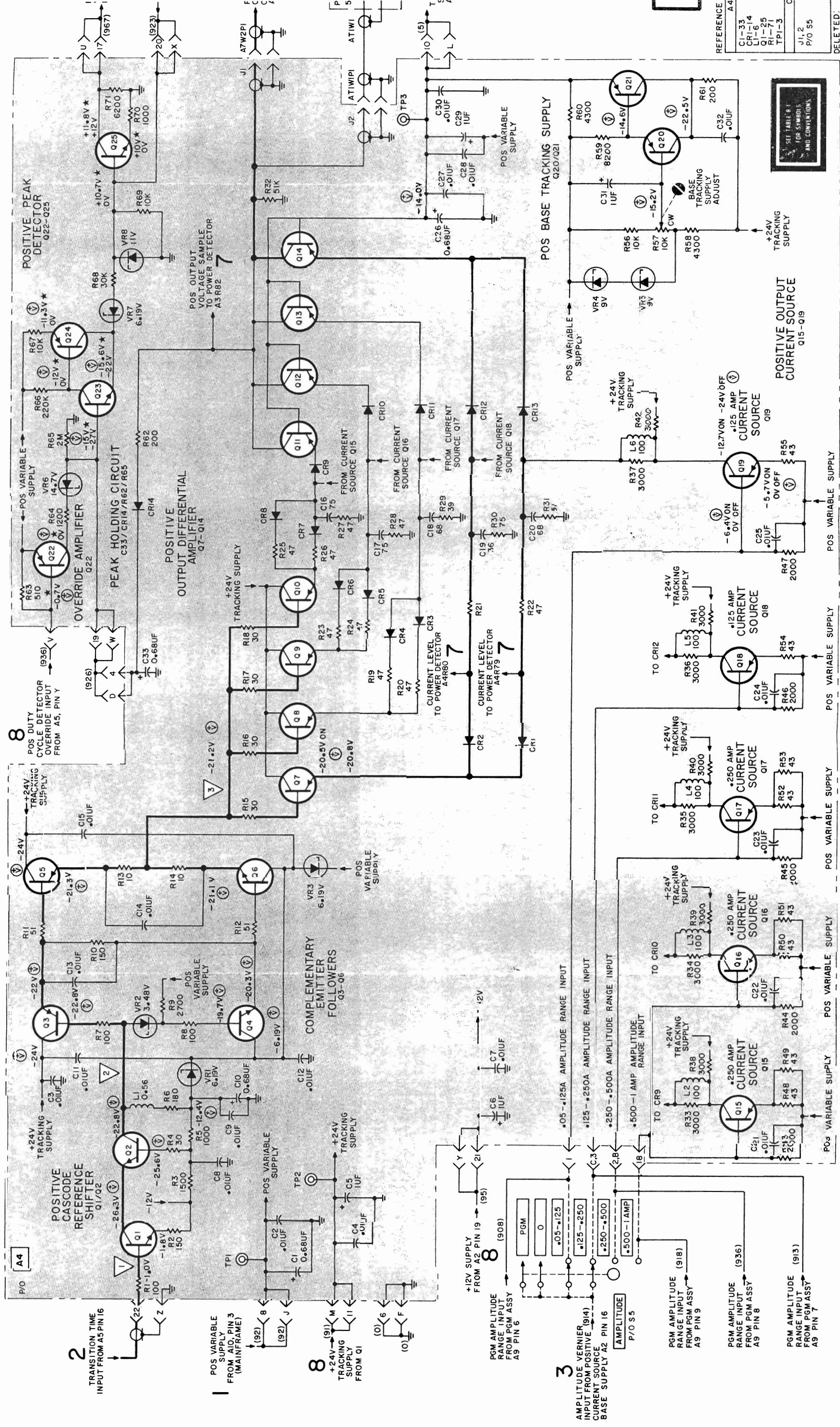

REFERENCE	A4
C1-33	
CR1-14	
L1-6	
Q1-25	
R1-71	
TPI-3	
J1, 2	
P/O S5	



915A-POS OUTPUT -AMP -925
915A-D-6A
DELETED.

Positive Out

2
TRANSITION TIME
INPUT FROM A5 PIN 16

POS VARIABLE
SUPPLY FROM A10, PIN 3
(MAINFRAME)

8
+24V TRACKING
SUPPLY FROM Q1

8
+12V SUPPLY
FROM A2 PIN 19 (95)

3
AMPLITUDE VERNIER
INPUT FROM POSITIVE
CURRENT SOURCE
BASE SUPPLY A2 PIN 16

8
PGM AMPLITUDE
RANGE INPUT FROM
PGM ASSY A9 PIN 6

3
PGM AMPLITUDE
RANGE INPUT FROM
PGM ASSY A9 PIN 9

3
PGM AMPLITUDE
RANGE INPUT FROM
PGM ASSY A9 PIN 8

3
PGM AMPLITUDE
RANGE INPUT FROM
PGM ASSY A9 PIN 7

3
PGM AMPLITUDE
RANGE INPUT FROM
PGM ASSY A9 PIN 7

3
PGM AMPLITUDE
RANGE INPUT FROM
PGM ASSY A9 PIN 7

3
PGM AMPLITUDE
RANGE INPUT FROM
PGM ASSY A9 PIN 7

3
PGM AMPLITUDE
RANGE INPUT FROM
PGM ASSY A9 PIN 7

3
PGM AMPLITUDE
RANGE INPUT FROM
PGM ASSY A9 PIN 7

3
PGM AMPLITUDE
RANGE INPUT FROM
PGM ASSY A9 PIN 7

3
PGM AMPLITUDE
RANGE INPUT FROM
PGM ASSY A9 PIN 7

3
PGM AMPLITUDE
RANGE INPUT FROM
PGM ASSY A9 PIN 7

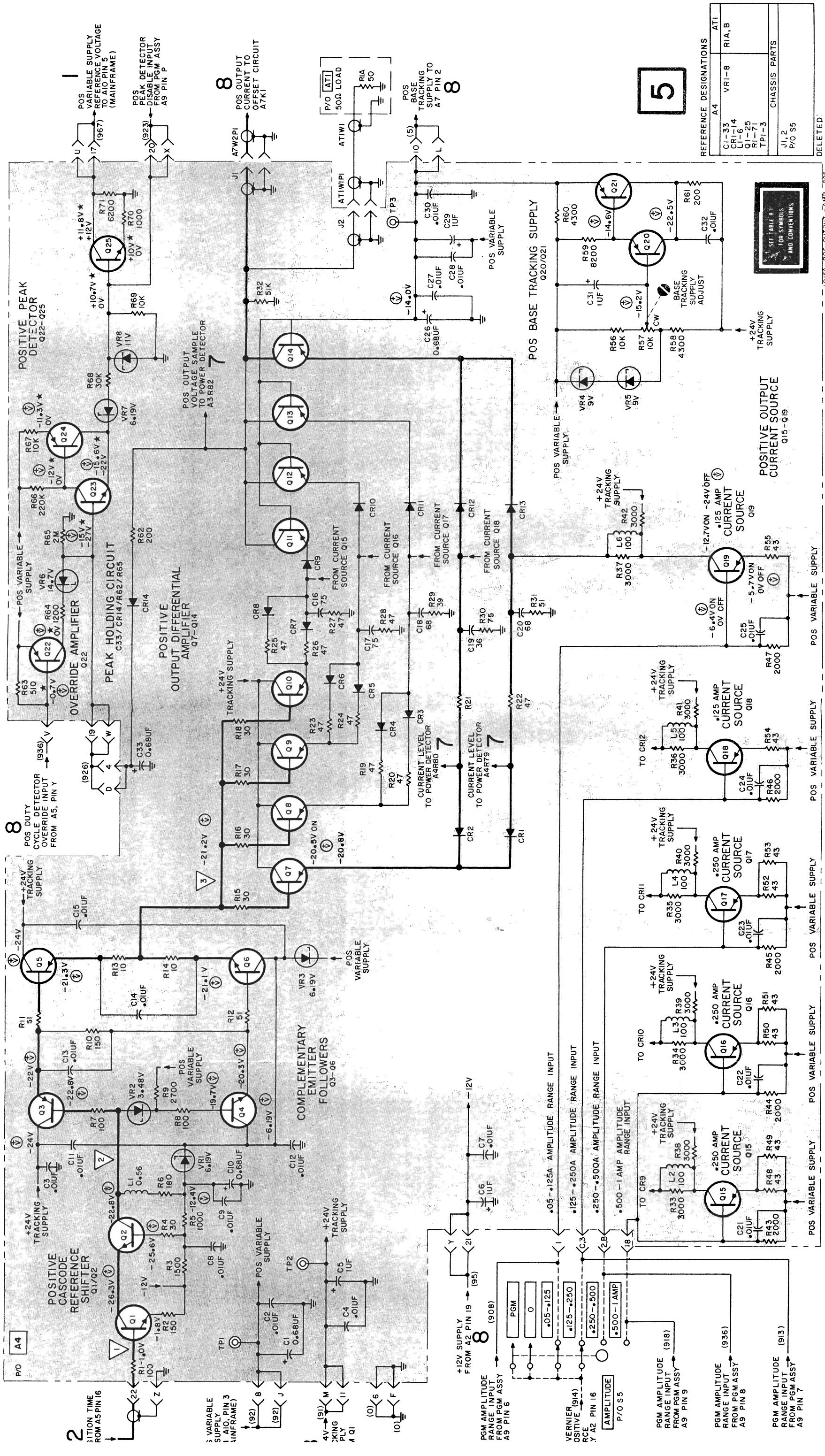

1915A-POS OUTPUT -AMP-925
1915A-D-6A

Figure 8-21.
Positive Output, A4, Schematic
8-23/8-24

REFERENCE DESIGNATIONS	
CI-33	ATI
CR1-14	RIA, B
Q1-25	VR1-8
R1-71	CHASSIS PARTS
TPI-3	J1, 2
J1, 2	P/O S5

5



SCHEMATIC NOTES

The positive overload protection circuit is located on three assemblies: positive output assembly A4, input and width assembly A2, and transition time assembly A5. To locate components on these assemblies, refer to the corresponding grid locator opposite the positive output schematic, the input and width schematic, or the transition-time schematic. Each of the grid locators can be viewed simultaneously with the positive overload protection schematic.

DC VOLTAGE MEASUREMENT CONDITIONS

WIDTH 4K-40K
 WIDTH vernier for 5 ms pulse
 TRANSITION TIME 10-1000
 LEADING EDGE cw
 TRAILING EDGE cw
 AMPLITUDE500-1 AMP
 AMPLITUDE vernier
 power detector off ccw
 power detector ON cw
 OFFSET OFF
 OFFSET vernier ccw
 POLARITY POS

Terminations
 internal 50-ohm connected
 external load high impedance

Drive input trigger signal set for 100 Hz.

DC voltage measurements taken with voltmeter referenced to ground unless otherwise indicated.

Ⓢ DC voltage measurement taken with voltmeter referenced to positive variable supply (A4TP1) instead of ground.

The positive variable supply ranges between +28 volts and +68 volts depending on the requirements of the output pulse.

WAVEFORM MEASUREMENT CONDITIONS

WIDTH 4K-40K
 WIDTH vernier for 5 ms pulse
 TRANSITION TIME 10-1000
 LEADING EDGE cw
 TRAILING EDGE cw
 AMPLITUDE500-1 AMP
 AMPLITUDE vernier cw
 OFFSET OFF
 OFFSET vernier ccw
 POLARITY POS

Termination
 internal 50-ohm connected
 external load high impedance

Drive input trigger signal set for 100 Hz.

All waveforms taken with the vertical input AC coupled. This permits use of a more sensitive vertical range while still displaying the image on screen. The DC component of the input signal is so high that with the same vertical range the display would be off screen with DC coupling.

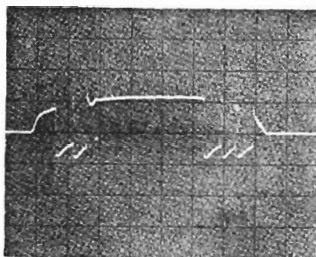

4 0.5 V/DIV
 1 MS/DIV
 VERTICAL INPUT - AC COUPLED

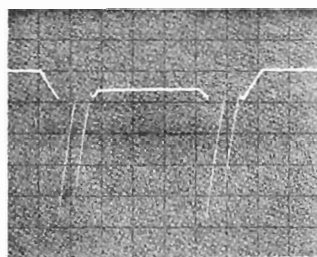

5 1 V/DIV
 1 MS/DIV
 VERTICAL INPUT - AC COUPLED

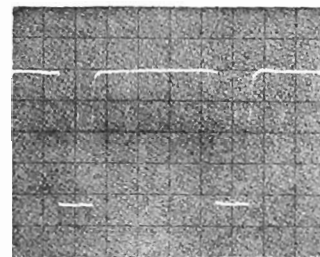

6 1 V/DIV
 1 MS/DIV
 VERTICAL INPUT - AC COUPLED

Figure 8-24. Positive Overload Protection, A2, A4, A5, Waveforms and Measurement Conditions

SCHEMATIC NOTES

The negative overload protection circuit is located on three assemblies: negative output assembly A3, input and width assembly A2, and transition time assembly A5. To locate components on these assemblies, refer to the corresponding grid locator opposite the negative output schematic, the input and width schematic, or the transition-time schematic. Each of the grid locators can be viewed simultaneously with the negative overload protection schematic.

DC VOLTAGE MEASUREMENT CONDITIONS

WIDTH 4K-40K
 WIDTH vernier for 5 ms pulse
 TRANSITION TIME 10-1000
 LEADING EDGE cw
 TRAILING EDGE cw
 AMPLITUDE500-1 AMP
 AMPLITUDE vernier
 power detector off ccw
 power detector ON cw
 OFFSET OFF
 OFFSET vernier ccw
 POLARITY NEG

Terminations
 internal 50-ohm connected
 external load high impedance

Drive input trigger signal set for 100 Hz.

DC voltage measurements taken with voltmeter referenced to ground unless otherwise indicated.

Ⓞ DC voltage measurement taken with voltmeter referenced to negative variable supply (A3TP3) instead of ground.

The negative variable supply ranges between -28 volts and -68 volts, depending on the requirements of the output pulse.

WAVEFORM MEASUREMENT CONDITIONS

WIDTH 4K-40K
 WIDTH vernier for 5 ms pulse
 TRANSITION TIME 10-1000
 LEADING EDGE cw
 TRAILING EDGE cw
 AMPLITUDE500-1 AMP
 AMPLITUDE vernier cw
 OFFSET OFF
 OFFSET vernier ccw
 POLARITY NEG

Terminations
 internal 50-ohm connected
 external load high impedance

Drive input trigger signal set for 100 Hz.

All waveforms taken with the vertical input AC coupled. This permits use of a more sensitive vertical range while still displaying the image on screen. The DC component of the input signal is so high that with the same vertical range the display would be off screen with DC coupling.

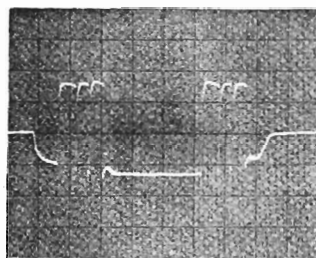

4
 0.5 V/DIV
 1 MS/DIV
 VERTICAL INPUT-AC COUPLED

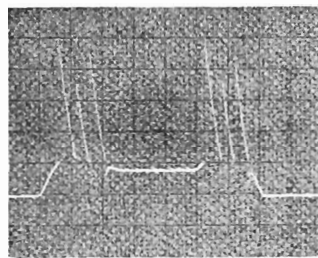

5
 1 V/DIV
 1 MS/DIV
 VERTICAL INPUT-AC COUPLED

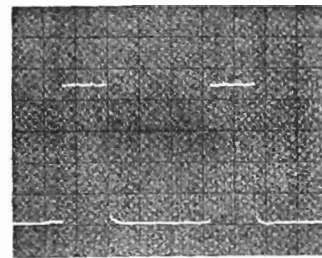

6
 1 V/DIV
 1 MS/DIV
 VERTICAL INPUT-AC COUPLED

Figure 8-22. Negative Overload Protection, A2, A3, A5, Waveforms and Measurement Conditions

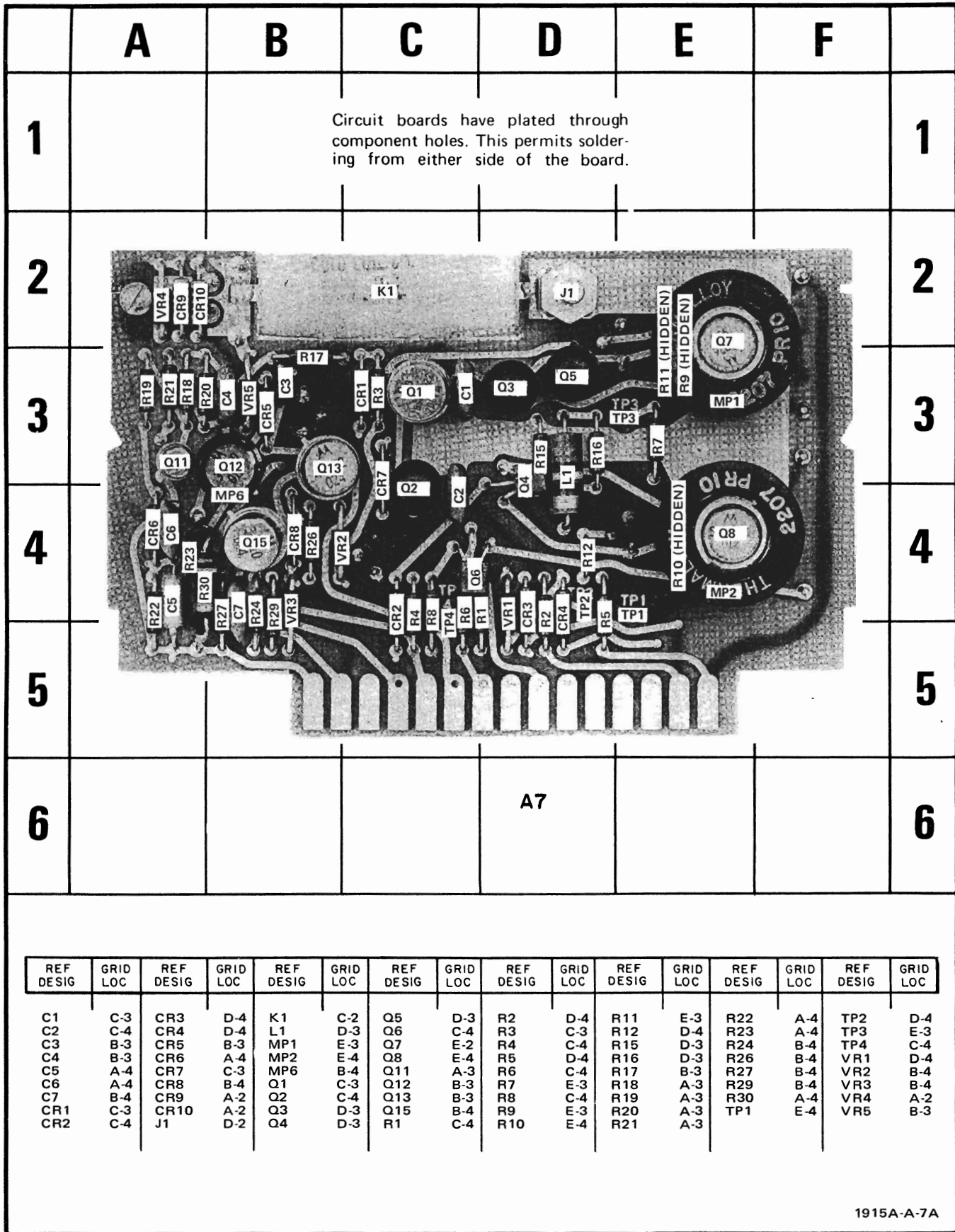

1915A-A-7A

Figure 8-26. Offset and Power Supply, A7, Component Identification (Front View)

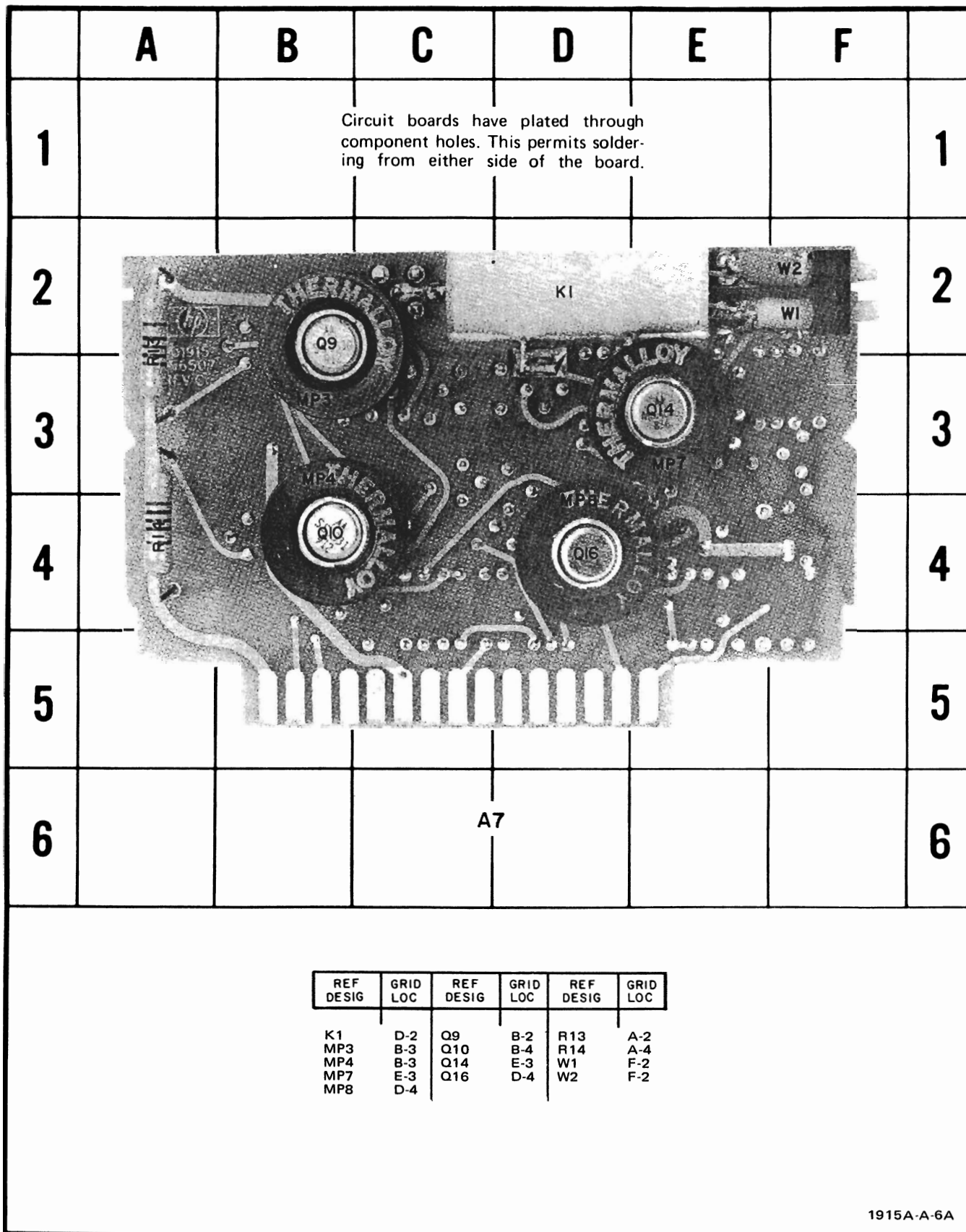

Figure 8-27. Offset and Power Supply, A7, Component Identification (Rear View)

SCHEMATIC NOTES

The -12-volt power supply is located on the input and width assembly (A2). To locate components in the -12-volt power supply, refer to the grid locator opposite the input and width schematic.

DC VOLTAGE MEASUREMENT CONDITIONS

WIDTH 4K-40K
 WIDTH vernier ccw
 TRANSITION TIME007-.2
 LEADING EDGE ccw
 TRAILING EDGE ccw
 AMPLITUDE125-.250
 AMPLITUDE vernier cw
 OFFSET POS
 OFFSET vernier ccw (cw if indicated)
 POLARITY POS

Terminations

internal 50-ohm connected
 external load high impedance

DC voltage measurements taken with voltmeter referenced to ground unless otherwise indicated.

⊖ DC voltage measurement taken with voltmeter referenced to negative variable supply (A3TP3) instead of ground. The negative variable supply is fixed at -28 volts with A3Q22 removed.

⊕ DC voltage measurement taken with voltmeter referenced to positive variable supply (A4TP1) instead of ground. The positive variable supply is fixed at +28 volts with A4Q22 removed.

☐ DC voltage measurement taken with NEG OFFSET and NEG POLARITY.

Figure 8-28. Offset and Power Supply, A2 and A7, Measurement Conditions

ELECTRONIC

SALES & SERVICE OFFICES

UNITED STATES

ALABAMA

P.O. Box 4207
2003 Byrd Spring Road S.W.
Huntsville 35802
Tel: (205) 881-4591
TWX: 810-726-2204

ARIZONA

2336 E. Magnolia St.
Phoenix 85034
Tel: (602) 252-5061
TWX: 910-951-1330

5737 East Broadway
Tucson 85716
Tel: (602) 298-2313
TWX: 910-952-1162

CALIFORNIA

1430 East Orangethorpe Ave.
Fullerton 92631
Tel: (714) 870-1000

3939 Lankershim Boulevard
North Hollywood 91604
Tel: (213) 877-1282
TWX: 910-499-2170

1101 Embarcadero Road
Palo Alto 94303
Tel: (415) 327-6500
TWX: 910-373-1280

2220 Watt Ave.
Sacramento 95825
Tel: (916) 482-1463
TWX: 910-367-2092

9606 Aero Drive
San Diego 92123
Tel: (714) 279-3200
TWX: 910-335-2000

COLORADO

7965 East Prentice
Englewood 80110
Tel: (303) 771-3455
TWX: 910-935-0705

CONNECTICUT

12 Lunar Drive
New Haven 06525
Tel: (203) 389-6551
TWX: 910-465-2029

FLORIDA

P.O. Box 24210
2806 W. Oakland Park Blvd.
Ft. Lauderdale 33307
Tel: (305) 731-2020
TWX: 510-955-4099

P.O. Box 13910
6177 Lake Ellenor Dr.
Orlando, 32809
Tel: (305) 859-2900
TWX: 810-850-0113

GEORGIA

P.O. Box 28234
450 Interstate North
Atlanta 30328
Tel: (404) 436-6181
TWX: 810-766-4890

ILLINOIS

5500 Howard Street
Skokie 60076
Tel: (312) 677-0400
TWX: 910-223-3613

INDIANA

3839 Meadows Drive
Indianapolis 46205
Tel: (317) 546-4891
TWX: 810-341-3263

LOUISIANA

P.O. Box 856
1942 Williams Boulevard
Kenner 70062
Tel: (504) 721-6201
TWX: 810-955-5524

MARYLAND

6707 Whitestone Road
Baltimore 21207
Tel: (301) 944-5400
TWX: 710-862-9157

P.O. Box 1648
2 Choke Cherry Road
Rockville 20850
Tel: (301) 948-6370
TWX: 710-828-9684

MASSACHUSETTS

32 Hartwell Ave.
Lexington 02173
Tel: (617) 861-8960
TWX: 710-326-6904

MICHIGAN

21840 West Nine Mile Road
Southfield 48075
Tel: (313) 353-9100
TWX: 810-224-4882

MINNESOTA

2459 University Avenue
St. Paul 55114
Tel: (612) 645-9461
TWX: 910-563-3734

MISSOURI

11131 Colorado Ave.
Kansas City 64137
Tel: (816) 763-8000
TWX: 910-771-2087

148 Weldon Parkway
Maryland Heights 63043
Tel: (314) 567-1455
TWX: 910-764-0830

NEW JERSEY

W. 120 Century Road
Paramus 07652
Tel: (201) 265-5000
TWX: 710-990-4951

1060 N. Kings Highway
Cherry Hill 08034
Tel: (609) 667-4000
TWX: 710-892-4945

NEW MEXICO

P.O. Box 8366
Station C
6501 Lomas Boulevard N.E.
Albuquerque 87108
Tel: (505) 265-3713
TWX: 910-989-1665

156 Wyatt Drive
Las Cruces 88001
Tel: (505) 526-2485
TWX: 910-983-0550

NEW YORK

1702 Central Avenue
Albany 12205
Tel: (518) 869-8462
TWX: 710-441-8270

1219 Campville Road
Endicott 13760
Tel: (607) 754-0050
TWX: 510-252-0890

82 Washington Street
Poughkeepsie 12601
Tel: (914) 454-7330
TWX: 510-248-0012

39 Saginaw Drive
Rochester 14623
Tel: (716) 473-9500
TWX: 510-253-5981

5858 East Molloy Road
Syracuse 13211
Tel: (315) 454-2486
TWX: 710-541-0482

1 Crossways Park West
Woodbury 11797
Tel: (516) 921-0300
TWX: 510-223-0811

NORTH CAROLINA

P.O. Box 5188
1923 North Main Street
High Point 27282
Tel: (919) 885-8101
TWX: 510-926-1516

OHIO

25575 Center Ridge Road
Cleveland 44145
Tel: (216) 835-0300
TWX: 810-427-9129

3460 South Dixie Drive
Dayton 45439
Tel: (513) 298-0351
TWX: 810-459-1925

1120 Morse Road
Columbus 43229
Tel: (614) 846-1300

OKLAHOMA

2919 United Founders Boulevard
Oklahoma City 73112
Tel: (405) 848-2801
TWX: 910-830-6862

OREGON

Westhills Mall, Suite 158
4475 S.W. Scholls Ferry Road
Portland 97225
Tel: (503) 292-9171
TWX: 910-464-6103

PENNSYLVANIA

2500 Moss Side Boulevard
Monroeville 15146
Tel: (412) 271-0724
TWX: 710-797-3650

1021 8th Avenue
King of Prussia Industrial Park
King of Prussia 19406
Tel: (215) 265-7000
TWX: 510-660-2670

RHODE ISLAND

873 Waterman Ave.
East Providence 02914
Tel: (401) 434-5535
TWX: 710-381-7573

TENNESSEE

Memphis
Tel: (901) 274-7472

TEXAS

P.O. Box 1270
201 E. Arapahoe Rd.
Richardson 75080
Tel: (214) 231-6101
TWX: 910-867-4723

P.O. Box 27409
6300 Westpark Drive
Suite 100
Houston 77027
Tel: (713) 781-6000
TWX: 910-881-2645

231 Billy Mitchell Road
San Antonio 78226
Tel: (512) 434-4171
TWX: 910-871-1170

UTAH

2890 South Main Street
Salt Lake City 84115
Tel: (801) 487-0715
TWX: 910-925-5681

VERMONT

P.O. Box 2287
Kennedy Drive
South Burlington 05401
Tel: (802) 656-4455
TWX: 510-299-0025

VIRGINIA

P.O. Box 6514
2111 Spencer Road
Richmond 23230
Tel: (703) 285-3431
TWX: 910-956-0157

WASHINGTON

433-108th N.E.
Bellevue 98004
Tel: (206) 454-3971
TWX: 910-443-2303

WEST VIRGINIA

Charleston
Tel: (304) 768-1232

FOR U.S. AREAS NOT LISTED:

Contact the regional office nearest you: Atlanta, Georgia . . . North Hollywood, California . . . Paramus, New Jersey . . . Skokie, Illinois. Their complete addresses are listed above.

*Service Only

CANADA

ALBERTA
Hewlett-Packard (Canada) Ltd.
11748 Kingsway Ave.
Edmonton
Tel: (403) 452-3670
TWX: 610-831-2431

BRITISH COLUMBIA
Hewlett-Packard (Canada) Ltd.
4519 Canada Way
North Burnaby 2
Tel: (604) 433-8213
TWX: 610-922-5059

MANITOBA
Hewlett-Packard (Canada) Ltd.
513 Century St.
Winnipeg
Tel: (204) 786-7581
TWX: 610-671-3531

NOVA SCOTIA
Hewlett-Packard (Canada) Ltd.
2745 Dutch Village Rd.
Suite 206
Halifax
Tel: (902) 455-0511
TWX: 610-271-4482

ONTARIO
Hewlett-Packard (Canada) Ltd.
1785 Woodward Dr.
Ottawa 3
Tel: (613) 255-6180, 255-6530
TWX: 610-562-1952

QUEBEC
Hewlett-Packard (Canada) Ltd.
275 Hymus Boulevard
Pointe Claire
Tel: (514) 697-4232
TWX: 610-422-3022
Telex: 01-20607

FOR CANADIAN AREAS NOT LISTED:

Contact Hewlett-Packard (Canada) Ltd. in Pointe Claire, at the complete address listed above.

CENTRAL AND SOUTH AMERICA

ARGENTINA
Hewlett-Packard Argentina
S.A.C.e.I
Lavalle 1171 - 3°
Buenos Aires
Tel: 35-0436, 35-0627, 35-0431
Telex: 012-1009
Cable: HEWPACK ARG

CHILE
Héctor Calcagni y Cia, Ltda.
Bustos, 1932-3er Piso
Casilla 13942
Santiago
Tel: 423 96
Cable: CALCAGNI Santiago

ECUADOR
Laboratorios de Radio-Ingeniería
Calle Guayaquil 1246
Post Office Box 3199
Quito
Tel: 212-496; 219-185
Cable: HORVATH Quito

NICARAGUA
Roberto Terán G.
Apartado Postal 689
Edificio Terán
Managua
Tel: 3451, 3452
Cable: ROTERAN Managua

PERU
Compañía Electro Medica S.A.
Ave. Enrique Canual 312
San Isidro
Casilla 1030
Lima
Tel: 22-3900
Cable: ELMED Lima

URUGUAY
Pablo Ferrando S.A.
Comercial e Industrial
Avenida Italia 2877
Casilla de Correo 370
Montevideo
Tel: 40-3102
Cable: RADIUM Montevideo

BRAZIL
Hewlett-Packard Do Brasil
I.e.C. Ltda.
Rua Frei Caneca 1119
Sao Paulo - 3, SP
Tel: 288-7111, 287-5858
Cable: HEWPACK Sao Paulo

COLOMBIA
Instrumentacion
Henrik A. Langebaek & Kier S.A.
Carrera 7 No. 48-59
Apartado Aereo 6287
Bogota, 1 D.E.
Tel: 45-78-06, 45-55-46
Cable: AARIS Bogota
Telex: 44400INSTCO

EL SALVADOR
Electronic Associates
Apartado Postal 1682
Centro Comercial Gigante
San Salvador, El Salvador C.A.
Paseo Escalon 4649-4° Piso
Tel: 23-44-60, 23-32-37
Cable: ELECCAS

PANAMA
Electrónico Balboa, S.A.
P.O. Box 4929
Ave. Manuel Espinosa No. 13-50
Bldg. Alina
Panama City
Tel: 230833
Telex: 3481003, Curundu,
Canal Zone
Cable: ELECTRON Panama City

PUERTO RICO
San Juan Electronics, Inc.
P.O. Box 5167
Ponce de Leon 154
Pda. 3-PTA de Tierra
San Juan 00906
Tel: (809) 725-3342, 722-3342
Cable: SATRONICS San Juan
Telex: SATRON 3450 332

VENEZUELA
Hewlett-Packard De Venezuela
C.A.
Apartado 50933
Caracas
Tel: 71.88.05, 71.88.69, 71.99.30
Cable: HEWPACK Caracas
Telex: 21146 HEWPACK

Hewlett-Packard Do Brasil
Praça Dom Feliciano 78
Salas 806/808
Porto Alegre
Rio Grande do Sul (RS)-Brasil
Tel: 25-8470
Cable: HEWPACK Porto Alegre

COSTA RICA
Lic. Alfredo Gallegos Gurdíán
Apartado 10159
San José
Tel: 21-86-13
Cable: GALGUR San José

GUATEMALA
IPESA
5a via 2-01, Zona 4
Guatemala City

PARAGUAY
Z.T. Melamed S.R.L.
Division: Aparatos y Equipos
Medicos
Salon de Exposicion y Escritorio:
Chile 482
Edificio Victoria—Planta Baja
Asuncion, Paraguay
Tel: 4-5069, 4-6272
Cable: RAMEL

MEXICO
Hewlett-Packard Mexicana, S.A.
de C.V.
622 Adolfo Prieto
Col. del Valle
Mexico 12, D.F.
Tel: 543-4232; 523-1874
Telex: 017-74-507

FOR AREAS NOT LISTED,

CONTACT:
Hewlett-Packard
INTERCONTINENTAL
3200 Hillview Ave.
Palo Alto, California 94304
Tel: (415) 493-1501
TWX: 910-373-1267
Cable: HEWPACK Palo Alto
Telex: 034-8300, 034-8493

EUROPE

AUSTRIA
Hewlett-Packard Ges.m.b.H.
Handelska 52/3
P.O. Box 7
A-1205 Vienna
Tel: (0222) 33 66 06 to 09
Cable: HEWPAK Vienna
Telex: 75923 hewpak a

BELGIUM
Hewlett-Packard Benelux
S.A./N.V.
Avenue du Col-Vert, 1
B-1170 Brussels
Tel: (02) 72 22 40
Cable: PALOBEN Brussels
Telex: 23 494

DENMARK
Hewlett-Packard A/S
Datavej 38
DK-3460 Birkerød
Tel: (01) 81 66 40
Cable: HEWPAK AS
Telex: 16640 hp as

Hewlett-Packard A/S
Torvet 9
DK-8600 Silkeborg
Tel: (06)-82-71-66
Telex: 16640 hp as
Cable: HEWPACKAS

FINLAND
Hewlett-Packard Oy
Bulevardi 26
P.O. Box 12185
SF-00120 Helsinki 12
Tel: (90) 13730
Cable: HEWPACKOY-Helsinki
Telex: 17-1563 hel

FRANCE
Hewlett-Packard France
Quartier de Courtaboeuf
Boite Postale No. 6
F-91401 Orsay
Tel: (1) 907 78 25
Cable: HEWPAK Orsay
Telex: 60048

Hewlett-Packard France
4 Quai des Etoiles
F-69321 Lyon Cedex 1
Tel: (78) 42 63 45
Cable: HEWPAK Lyon
Telex: 31617

Hewlett-Packard France
29 rue de la Gare
F-31700 Blagnac
Tel: (61) 85 82 29
Telex: 51957

GERMAN FEDERAL REPUBLIC

Hewlett-Packard Vertriebs-GmbH
Berliner Strasse 117
Postfach 560 140
D-6 Nieder-Eschbach/Ffm 56
Tel: (0611) 50-04-1
Cable: HEWPAKSA Frankfurt
Telex: 41 32 49 FRA

Hewlett-Packard Vertriebs-GmbH
Herrenbergerstrasse 110
D-7030 Böblingen, Württemberg
Tel: (07031) 66 72 87
Cable: HEPAK Böblingen
Telex: 72 65 739 bbn

Hewlett-Packard Vertriebs-GmbH
Vogelsanger Weg 38
D-4 Düsseldorf
Tel: (0211) 63 80 31/35
Telex: 85/86 533 hppd d

Hewlett-Packard Vertriebs-GmbH
Wendenstr. 23
D-2 Hamburg 1
Tel: (0411) 24 05 51/52
Cable: HEWPAKSA Hamburg
Telex: 21 53 032 hphh d

Hewlett-Packard Vertriebs-GmbH
Unterhächinger Strasse 28
ISAR Center
D-8012 Ottobrunn
Tel: (0811) 601 30 61/7
Telex: 52 49 85
Cable: HEWPAKSA München

(West Berlin)
Hewlett-Packard Vertriebs-GmbH
Wilmerdorfer Strasse 113/114
D-1000 Berlin W. 12
Tel: (0311) 3137046
Telex: 18 34 05 hpbm d

GREECE
Kostas Karayannis
18, Ermou Street
Athens 126
Tel: 3230-303
Cable: RAKAR Athens
Telex: 21 59 62 rkar gr

IRELAND
Hewlett-Packard Ltd.
224 Bath Road
Slough, SL1 4 DS, Bucks
Tel: Slough (0753) 33341
Cable: HEWPIE Slough
Telex: 84413

Hewlett-Packard Ltd.
The Griftons
Stamford New Road
Altrincham, Cheshire, England
Tel: (061) 928-8626
Telex: 668068

ITALY
Hewlett-Packard Italiana S.p.A.
Via Amerigo Vespucci 2
I-20124 Milan
Tel: (2) 6251 (10 lines)
Cable: HEWPAKMIT Milan
Telex: 32046

Hewlett-Packard Italiana S.p.A.
Piazza Marconi
I-00144 Rome - Eur
Tel: (6) 5912544/5, 5915947
Cable: HEWPAKMIT Rome
Telex: 61514

Hewlett-Packard Italiana S.p.A.
Vicolo Pastori, 3
I-35100 Padova
Tel: (49) 66 40 62
Telex: 32046 via Milan

Hewlett-Packard Italiana S.p.A.
Via Calli, 24
I-10129 Turin
Tel: (11) 53 82 64
Telex: 32046 via Milan

LUXEMBURG
Hewlett-Packard Benelux
S.A./N.V.
Avenue du Col-Vert, 1
B-1170 Brussels
Tel: (03/02) 72 22 40
Cable: PALOBEN Brussels
Telex: 23 494

NETHERLANDS
Hewlett-Packard Benelux, N.V.
Weerdestein 117
P.O. Box 7825
Amsterdam, 2 111
Tel: (020) 42 77 77
Cable: PALOBEN Amsterdam
Telex: 13 216 hepa nl

NORWAY
Hewlett-Packard Norge A/S
Box 149
Nesveien 13
N-1344 Haslum
Tel: (02)-53 83 60
Telex: 16621 hpnas n

PORTUGAL
Telectra-Empresa Tecnica de Equipamentos Electricos S.a.r.l.
Rua Rodrigo da Fonseca 103
P.O. Box 2531
P-Lisbon 1
Tel: (19) 68 60 72
Cable: TELETRA Lisbon
Telex: 1598

SPAIN
Hewlett-Packard Española, S.A.
Jerez No 8
Madrid 16
Tel: 458 26 00
Telex: 23515 hpe

Hewlett-Packard Española, S.A.
Milanesado 21-23
E-Barcelona 17
Tel: (3) 203 62 00
Telex: 52603 hpbe e

SWEDEN
Hewlett-Packard Sverige AB
Enighetsvägen 1-3
Fack
S-161 20 Bromma 20
Tel: (08) 98 12 50
Cable: MEASUREMENTS Stockholm
Telex: 10721

Hewlett-Packard Sverige AB
Hagakergatan 9C
S-431 41 Mölndal
Tel: (031) 27 68 00/01
Telex: 21 312 hpmind s

SWITZERLAND
Hewlett Packard (Schweiz) AG
Zürcherstrasse 20
P.O. Box 64
CH-8952 Schlieren Zurich
Tel: (01) 98 18 21/24
Cable: HPAG CH
Telex: 53933 hpag ch

Hewlett-Packard (Schweiz) AG
Rue du Bois-du-Lan 7
P.O. Box 85
1217 Meyrin 2 Geneva
Tel: (022) 41 54 00
Cable: HEWPAKSA Geneva
Telex: 27333 hpsa ch

TURKEY
Telekom Engineering Bureau
Saglik Sok No. 15/1
Ayaspaşa-Beyoglu
P.O. Box 437 Beyoglu
Istanbul
Tel: 49 40 40
Cable: TELEMATIK Istanbul

UNITED KINGDOM
Hewlett-Packard Ltd.
224 Bath Road
Slough, SL1 4 DS, Bucks
Tel: Slough (0753) 33341
Cable: HEWPIE Slough
Telex: 84413

Hewlett-Packard Ltd.
"The Griftons"
Stamford New Road
Altrincham, Cheshire
Tel: (061) 928-8626
Telex: 668068

SOCIALIST COUNTRIES PLEASE CONTACT:

Hewlett-Packard Ges.m.b.H.
Handelskai 52/3
P.O. Box 7
A-1205 Vienna
Ph: (0222) 33 66 06 to 09
Cable: HEWPAK Vienna
Telex: 75923 hewpak a

ALL OTHER EUROPEAN COUNTRIES CONTACT:

Hewlett-Packard S.A.
Rue du Bois-du-Lan 7
P.O. Box 85
CH-1217 Meyrin 2 Geneva
Switzerland
Tel: (022) 41 54 00
Cable: HEWPAKSA Geneva
Telex: 2.24.86

AFRICA, ASIA, AUSTRALIA

ANGOLA
Telectra Empresa Técnica de Equipamentos Eléctricos SAR
Rua de Barbosa Rodrigues
42-1°
Box 6487
Luanda
Cable: TELETRA Luanda

AUSTRALIA
Hewlett-Packard Australia Pty. Ltd.
22-26 Weir Street
Glen Iris, 3146
Victoria
Tel: 20-1371 (6 lines)
Cable: HEWPAK Melbourne
Telex: 31 024

Hewlett-Packard Australia Pty. Ltd.
Corner Bridge & West Streets
Pymble, New South Wales, 2073
Tel: 449 6566
Cable: HEWPAK Sydney
Telex: 21561

Hewlett-Packard Australia Pty. Ltd.
97 Churchill Road
Prospect 5082
South Australia
Tel: 65-2366
Cable: HEWPAK Adelaide

Hewlett Packard Australia Pty. Ltd.
2nd Floor, Suite 13
Casablanca Buildings
196 Adelaide Terrace
Perth, W.A. 6000
Tel: 25-6800
Cable: HEWPAK Perth

Hewlett-Packard Australia Pty. Ltd.
10 Woolley Street
P.O. Box 191
Dickson A.C.T. 2602
Tel: 49-8194
Cable: HEWPAK Canberra ACT

Hewlett-Packard Australia Pty. Ltd.
6 Harvard Street
P.O. Box 135
Kenmore 4069 Queensland
Tel: 70-4050

CEYLON
United Electricals Ltd.
P.O. Box 681
Yahala Building
Staples Street
Colombo 2
Tel: 26696
Cable: HOTPOINT Colombo

CYPRUS
Kypronics
19 Georgios & Xenopoulos Road
P.O. Box 1152
Nicosia
Tel: 45628/29
Cable: Kypronics Pandeis

ETHIOPIA
African Salespower & Agency Private Ltd., Co.
P. O. Box 718
58/59 Cunningham St.
Addis Ababa
Tel: 12285
Cable: ASACO Addisababa

HONG KONG
Schmidt & Co. (Hong Kong) Ltd.
P.O. Box 297
1511, Prince's Building 15th Floor
10, Chater Road
Hong Kong
Tel: 240168, 232735
Cable: SCHMIDTCO Hong Kong

INDIA
Blue Star Ltd.
Kasturi Buildings
Jamshejji Tata Rd.
Bombay 20BR, India
Tel: 29 50 21
Telex: 3751
Cable: BLUEFROST

Blue Star Ltd.
Band Box House
Prabhadevi
Bombay 25DD, India
Tel: 45 73 01
Telex: 3751
Cable: BLUESTAR

Blue Star Ltd.
14/40 Civil Lines
Kanpur, India
Tel: 6 88 82
Cable: BLUESTAR

Blue Star, Ltd.
7 Hare Street
P.O. Box 506
Calcutta 1, India
Tel: 23-0131
Cable: BLUESTAR

Blue Star Ltd.
Blue Star House,
34 Ring Road
Lajpat Nagar
New Delhi 24, India
Tel: 62 32 76
Telex: 463
Cable: BLUESTAR

Blue Star, Ltd.
Blue Star House
11/11A Magarath Road
Bangalore, 25
Tel: 51473
Telex: 430
Cable: BLUESTAR

Blue Star, Ltd.
1-1-117/1
Sarojini Devi Road
Secunderabad 3
Tel: 7 63 91, 7 73 93
Cable: BLUEFROST

Blue Star, Ltd.
23/24 Second Line Beach
Madras 1, India
Tel: 2 39 55
Telex: 379
Cable: BLUESTAR

Blue Star, Ltd.
18 Kaiser Bungalow
Dindli Road
Jamshejpur, India
Tel: 38 04
Cable: BLUESTAR

Blue Star, Ltd.
Bah Bolon Trading Coy. N.V.
Dialah Merdeka 29
Bandung
Tel: 4915; 51560
Cable: ILMU
Telex: 08-809

IRAN
Multicorp International Ltd.
Avenue Soraya 130
P.O. Box 1212
Tehran
Tel: 83 10 35-39
Cable: MULTICORP Tehran
Telex: 2893 mci tn

ISRAEL
Electronics & Engineering Div. of Motorola Israel Ltd.
17 Aminadav Street
Tel-Aviv
Tel: 36941 (3 lines)
Cable: BASTEL Tel-Aviv
Telex: MOTIL IL

JAPAN
Yokogawa-Hewlett-Packard Ltd.
Ohashi Building
1-59-1 Yoyogi
Shibuya-ku, Tokyo
Tel: 03-370-2281/92
Telex: 232-2024YHP
Cable: YHPMARKET TOK 23-724

Yokogawa-Hewlett-Packard Ltd.
Nisei Ibaragi Bldg.
2-2-8 Kasuga
Ibaragi-Shi
Osaka
Tel: (0726) 23-1641
Telex: 5332-385 YHP OSAKA

Yokogawa-Hewlett-Packard Ltd.
Ito Building
No. 59, Kotori-cho
Nakamura-ku, Nagoya City
Tel: (052) 551-0215

Yokogawa-Hewlett-Packard Ltd.
Nitto Bldg.
2-4-2 Shinhoh-Kita
Kohoku-ku
Yokohama 222
Tel: 045-432-1504
Telex: 382-3204 YHP YOK

Yokogawa-Hewlett-Packard Ltd.
Chuo Bldg.
Rm. 603, 3
2-Chome
IZUMI-CHO,
Mito, 310
Tel: 0292-25-7470

KENYA
Kenya Kinetics
P.O. Box 18311
Nairobi, Kenya
Tel: 57726
Cable: PROTON

KOREA
Amtraco Corporation
Industrial Products Div.
Seoul P.O. Box 1103
8th floor, Daekyung Bldg.
107 Sejong Ro
Chongro-Ku, Seoul
Tel: 73-8924-7
Cable: AMTRACO Seoul

LEBANON
Constantin E. Macridis
P.O. Box 7213
RI-Beirut
Tel: 220846
Cable: ELECTRONUCLEAR Beirut

MALAYSIA
MECOMB Malaysia Ltd.
2 Lorong 13/6A
Section 13
Petaling Jaya, Selangor
Cable: MECOMB Kuala Lumpur

MOZAMBIQUE
A. N. Goncalves, LDA.
4.1 Apt. 14 Av. D. Luis
P.O. Box 107
Lourenço Marques
Cable: NEGON

NEW ZEALAND
Hewlett-Packard (N.Z.) Ltd.
94-96 Dixon St.
P.O. Box 9443
Courtenay Place
Wellington, N.Z.
Tel: 56-559
Cable: HEWPAK Wellington

Hewlett Packard (N.Z.) Ltd.
Box 51092
Pukuranga
Tel: 56-9837
Cable: HEWPAK, Auckland

PAKISTAN
Mushko & Company, Ltd.
Oosman Chambers
Abdullah Haroon Road
Karachi 3
Tel: 511027, 512927
Cable: COOPERATOR Karachi

Mushko & Company, Ltd.
38B, Satellite Town
Rawalpindi
Tel: 41924
Cable: FEMUS Rawalpindi

PHILIPPINES
Electromex Inc.
5th Floor, Architects
Center Bldg.
Ayala Ave., Makati, Rizal
C.C.P.O. Box 1028
Makati, Rizal
Tel: 86-18-87, 87-76-77
Cable: ELEMEX Manila

SINGAPORE
Mechanical and Combustion Engineering Company Ltd.
9, Jalan Kilang
Red Hill Industrial Estate
Singapore 3
Tel: 642361-3; 632611
Cable: MECOMB Singapore

Hewlett-Packard Far East Area Office
P.O. Box 87
Alexandra Post Office
Singapore 3
Tel: 633022
Cable: HEWPAK SINGAPORE

SOUTH AFRICA
Hewlett Packard South Africa (Pty.), Ltd.
P.O. Box 31716
Braamfontein Transvaal
Milnerton
30 De Beer Street
Johannesburg
Tel: 725-2080, 725-2030
Telex: 0226 JH
Cable: HEWPAK Johannesburg

Hewlett Packard South Africa (Pty.), Ltd.
Breecastle House
Bree Street
Cape Town
Tel: 3-6019, 3-6545
Cable: HEWPAK Cape Town
Telex: 5-0006

Hewlett Packard South Africa (Pty.), Ltd.
641 Ridge Road, Durban
P.O. Box 99
Overport, Natal
Tel: 88-6102
Telex: 567954
Cable: HEWPAK

TAIWAN
Hewlett Packard Taiwan
39 Chung Shiao West Road
Sec. 1
Oversas Insurance Corp. Bldg. 7th Floor
Taipei
Tel: 389160, 1, 2, 375121,
Ext. 240-249
Telex: TP824 HEWPAK
Cable: HEWPAK Taipei

THAILAND
UNIMESA Co., Ltd.
Chongkoinee Building
56 Suriwongse Road
Bangkok
Tel: 37956, 31300, 31307,
37540
Cable: UNIMESA Bangkok

UGANDA
Uganda Tele-Electric Co., Ltd.
P.O. Box 4449
Kampala
Tel: 57279
Cable: COMCO Kampala

VIETNAM
Peninsular Trading Inc.
P.O. Box H-3
216 Hien-Vuong
Saigon
Tel: 20-805, 93398
Cable: PENTRA, SAIGON 242

ZAMBIA
R. J. Tibury (Zambia) Ltd.
P.O. Box 2792
Lusaka
Zambia, Central Africa
Tel: 73793
Cable: ARJAYTEE, Lusaka

MEDITERRANEAN AND MIDDLE EAST COUNTRIES NOT SHOWN PLEASE CONTACT:
Hewlett-Packard
Co-ordination Office for
Mediterranean and Middle
East Operations
Via Marocco, 7
I-00144 Rome-Eur, Italy
Tel: (6) 59 40 29
Cable: HEWPAKMIT Rome
Telex: 61514

OTHER AREAS NOT LISTED, CONTACT:
Hewlett-Packard
INTERCONTINENTAL
3200 Hillview Ave.
Palo Alto, California 94304
Tel: (415) 326-7000
(Feb. 71 493-1501)
TWX: 910-373-1267
Cable: HEWPAK Palo Alto
Telex: 034-8300, 034-8493



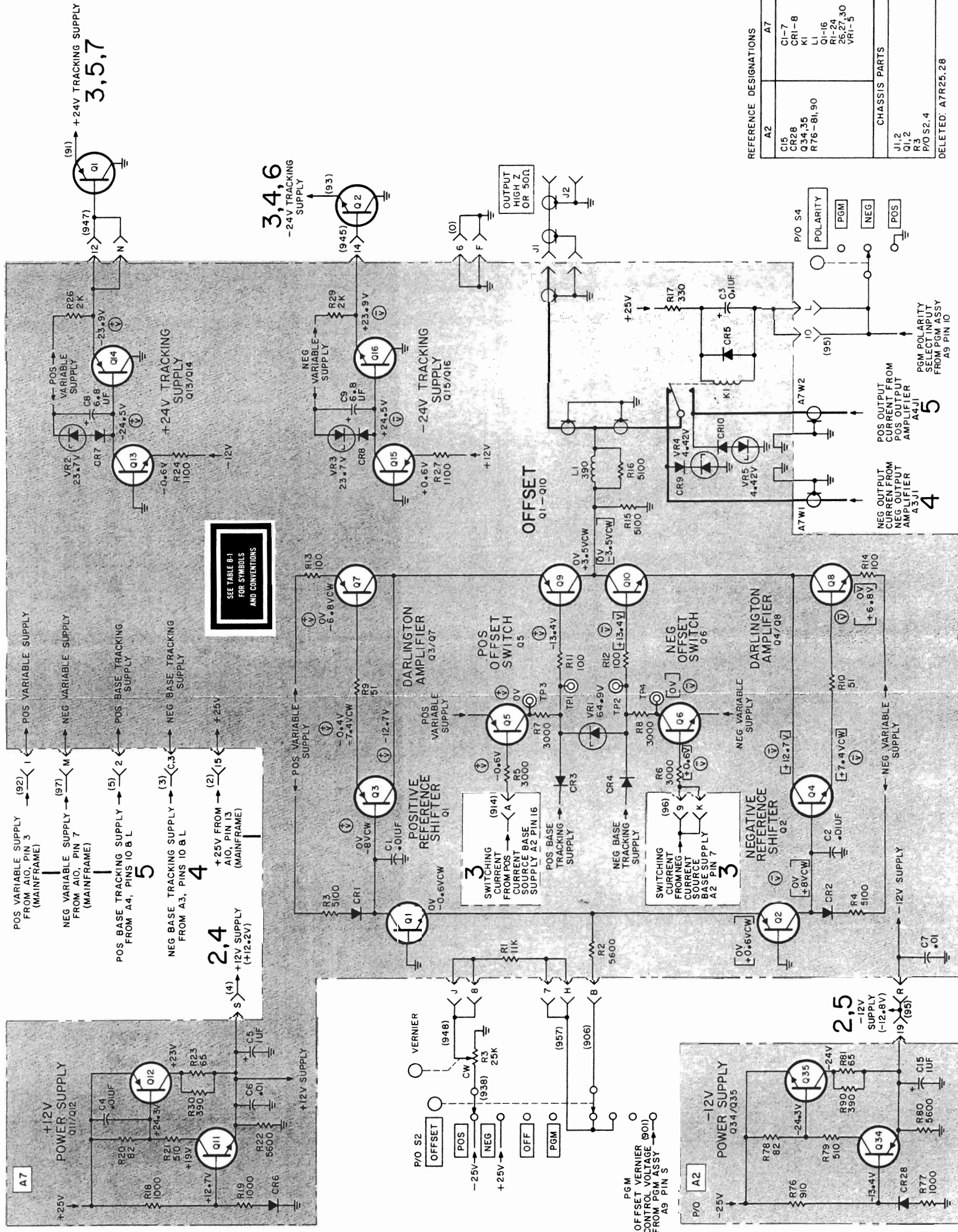

REFERENCE DESIGNATIONS	
A2	A7
C15	CR1-8
CR28	K1
Q34,35	L1
R76-81,90	Q1-16
	R1-24
	26,27,30
	VR1-5
CHASSIS PARTS	
J1,2	
Q1,2	
R3	
P/O S2,4	

DELETED: A7R25,28

Figure 8-29. Offset and Power Supply, A2 and A7, Schematic 8-29

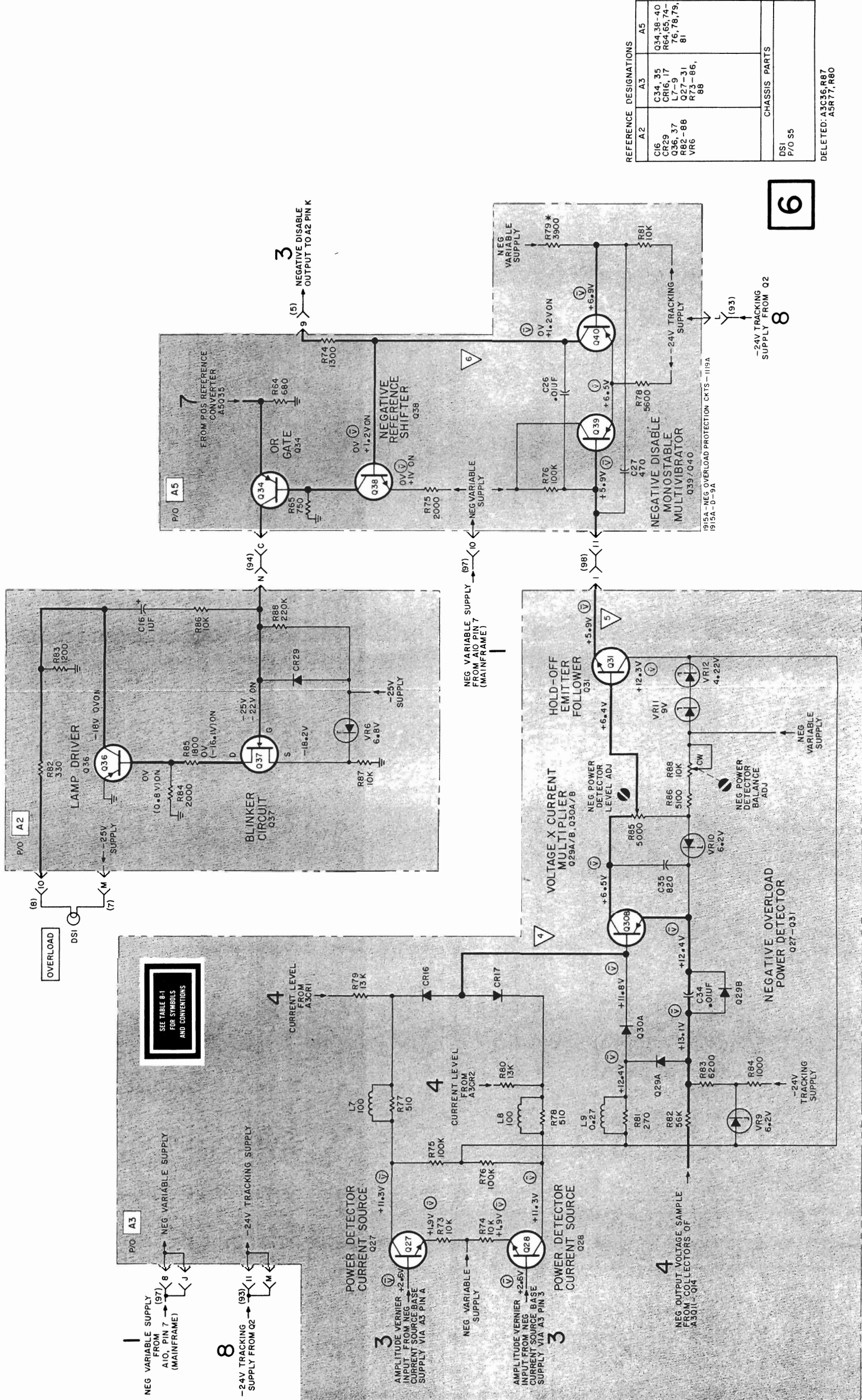
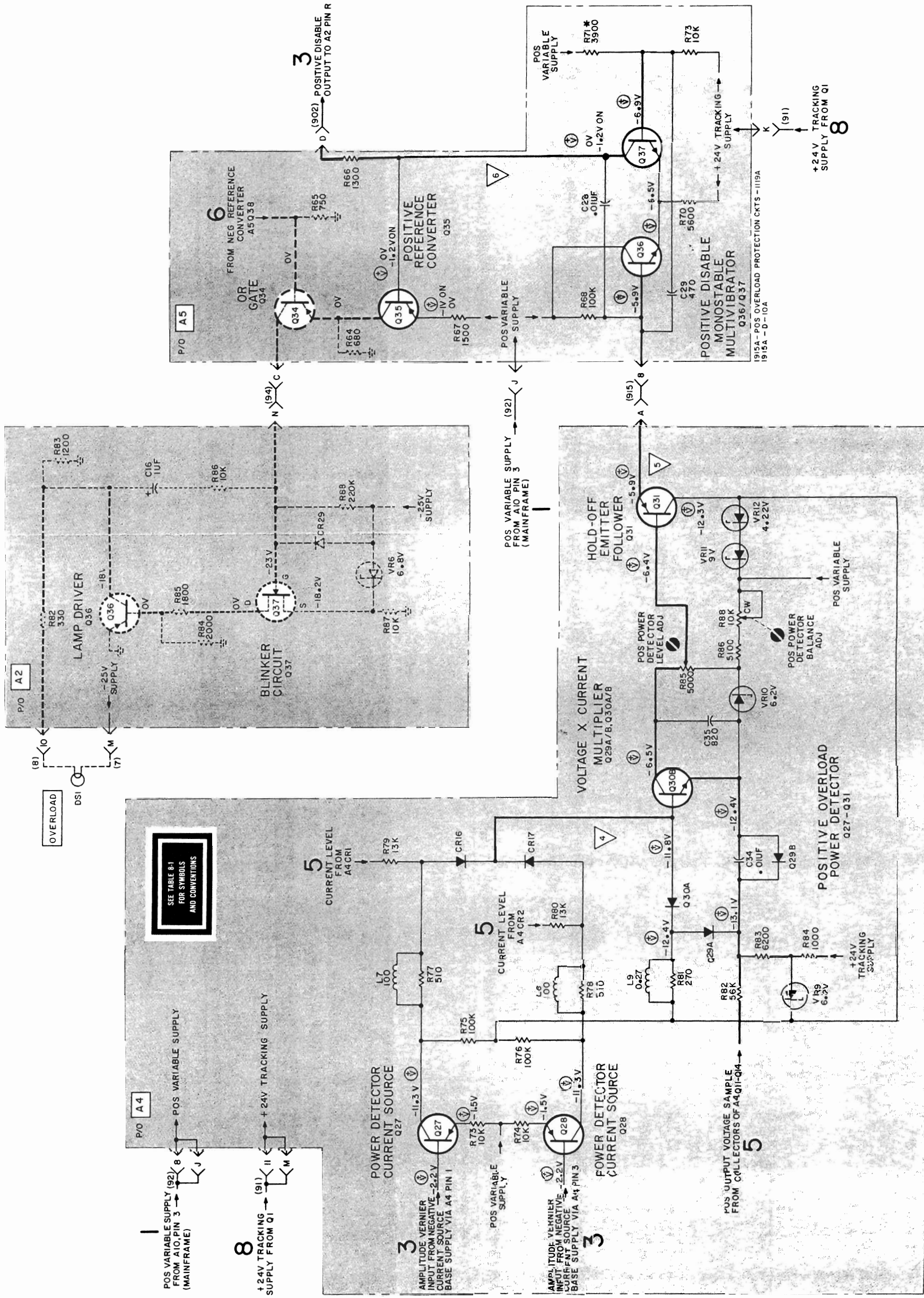

Figure 8-23. Negative Overload Protection, A2, A3, A5, Schematic 8-25/8-26



REFERENCE DESIGNATIONS	
A 4	A 5
C34-35	Q35-37
CR16, 17	R66-68
Q27, 31	R70, 71, 73
R71-86,	
88	
CHASSIS PARTS	
DS1	
P/O S5	
DELETED: A4C35, R87, A5R69, R72	

7

Figure 8-25. Positive Overload Protection, A2, A4, A5, Schematic 8-27