

Errata

Title & Document Type: 211B Square Wave Generator Operating and Service Manual

Manual Part Number: 00211-90902

Revision Date: December 1976

About this Manual

We've added this manual to the Agilent website in an effort to help you support your product. This manual provides the best information we could find. It may be incomplete or contain dated information, and the scan quality may not be ideal. If we find a better copy in the future, we will add it to the Agilent website.

HP References in this Manual

This manual may contain references to HP or Hewlett-Packard. Please note that Hewlett-Packard's former test and measurement, life sciences, and chemical analysis businesses are now part of Agilent Technologies. The HP XXXX referred to in this document is now the Agilent XXXX. For example, model number HP8648A is now model number Agilent 8648A. We have made no changes to this manual copy.

Support for Your Product

Agilent no longer sells or supports this product. You will find any other available product information on the Agilent Test & Measurement website:

www.agilent.com

Search for the model number of this product, and the resulting product page will guide you to any available information. Our service centers may be able to perform calibration if no repair parts are needed, but no other support from Agilent is available.



Agilent Technologies

211B SQUARE WAVE GENERATOR

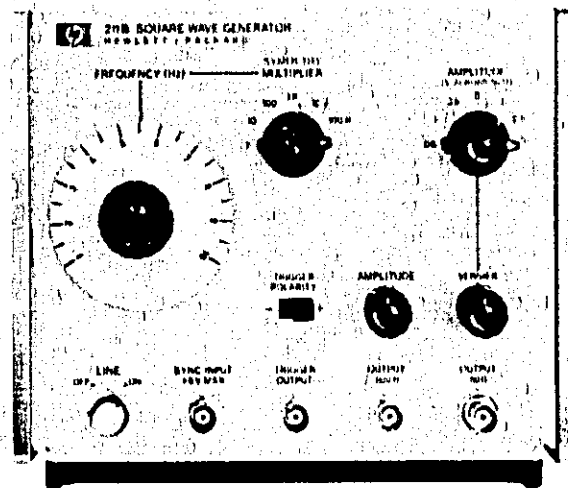



OPERATING AND SERVICE MANUAL

MODEL 211B SQUARE WAVE GENERATOR

(Including Option 580)

HP PART NUMBER 00211-90902

MICROFICHE NO. 00211-90802
SERIAL NUMBERS

This manual applies directly to instruments with serial numbers prefixed 1644A.

With changes described in Section VII, this manual also applies to instruments with serial numbers prefixed 0817A through 1538A.

For additional information about serial numbers, see **INSTRUMENTS COVERED BY MANUAL** in Section I.

HEWLETT-PACKARD COMPANY/COLORADO SPRINGS DIVISION
1900 GARDEN OF THE GODS ROAD, COLORADO SPRINGS, COLORADO, U.S.A.

Manual Part Number 00211-90902
Microfiche Part Number 00211-90802

PRINTED: DECEMBER 1976

SAFETY SUMMARY

The following general safety precautions must be observed during all phases of operation, service, and repair of this instrument. Failure to comply with these precautions or with specific warnings elsewhere in this manual violates safety standards of design, manufacture, and intended use of the instrument. Hewlett-Packard Company assumes no liability for the customer's failure to comply with these requirements.

GROUND THE INSTRUMENT.

To minimize shock hazard, the instrument chassis and cabinet must be connected to an electrical ground. The instrument is equipped with a three-conductor ac power cable. The power cable must either be plugged into an approved three-contact electrical outlet or used with a three-contact to two-contact adapter with the grounding wire (green) firmly connected to an electrical ground (safety ground) at the power outlet. The power jack and mating plug of the power cable meet International Electrotechnical Commission (IEC) safety standards.

DO NOT OPERATE IN AN EXPLOSIVE ATMOSPHERE.

Do not operate the instrument in the presence of flammable gases or fumes. Operation of any electrical instrument in such an environment constitutes a definite safety hazard.

KEEP AWAY FROM LIVE CIRCUITS.

Operating personnel must not remove instrument covers. Component replacement and internal adjustments must be made by qualified maintenance personnel. Do not replace components with power cable connected. Under certain conditions, dangerous voltages may exist even with the power cable removed. To avoid injuries, always disconnect power and discharge circuits before touching them.

DO NOT SERVICE OR ADJUST ALONE.

Do not attempt internal service or adjustment unless another person, capable of rendering first aid and resuscitation, is present.

DO NOT SUBSTITUTE PARTS OR MODIFY INSTRUMENT.

Because of the danger of introducing additional hazards, do not install substitute parts or perform any unauthorized modification to the instrument. Return the instrument to a Hewlett-Packard Sales and Service Office for service and repair to ensure that safety features are maintained.

DANGEROUS PROCEDURE WARNINGS.

Warnings, such as the example below, precede potentially dangerous procedures throughout this manual. Instructions contained in the warnings must be followed.

WARNING

**Dangerous voltages, capable of causing death, are present in this instrument.
Use extreme caution when handling, testing, and adjusting.**

TABLE OF CONTENTS

Section	Page	Section	Page
I GENERAL INFORMATION	1-1	4-32. Output Circuits	4-3
1-1. Introduction	1-1	4-39. Synchronization	4-4
1-4. Specifications	1-1	4-43. Power Supplies	4-4
1-6. Instruments Covered By Manual ..	1-1	V PERFORMANCE CHECK AND	
1-12. Description	1-2	ADJUSTMENTS	5-1
1-15. Options	1-2	5-1. Introduction	5-1
II INSTALLATION	2-1	5-3. Required Test Equipment	5-1
2-1. Initial Inspection	2-1	5-5. Performance Check	5-1
2-3. Preparation For Use	2-1	5-6. Procedure	5-1
2-4. Power Requirements	2-1	5-8. Symmetry Control Check	5-1
2-7. Three-conductor Power Cable ...	2-1	5-9. Synchronization Check	5-2
2-9. Repacking For Shipment	2-1	5-10. 600-ohm Output Check	5-3
III OPERATION	3-1	5-11. Rise Time and Fall Time	5-3
3-1. Introduction	3-1	5-12. 50-ohm Output Check	5-4
3-3. Controls and Connectors	3-1	5-14. Symmetry (10 MHz)	5-4
3-8. Operating Considerations	3-1	5-15. Trigger Output Check	5-4
3-9. External Synchronization	3-1	5-17. Adjustments	5-5
3-11. Trigger Output	3-1	5-20. Power Supply Adjustment	5-7
3-13. Operating Procedures	3-1	5-21. Frequency Adjustment	5-7
IV PRINCIPLES OF OPERATION	4-1	5-22. Synchronization Adjustment	5-7
4-1. Introduction	4-1	5-23. Pulse Amplitude 600-ohm	5-7
4-3. Block Diagram Description	4-1	Output Adjustment	5-7
4-5. Fine-frequency Control	4-1	VI REPLACEABLE PARTS	6-1
4-7. Current Sources	4-1	6-1. Introduction	6-1
4-9. Coarse-frequency Control	4-1	6-4. Ordering Information	6-1
4-11. Schmitt Trigger	4-1	6-6. Direct Mail Order System	6-1
4-13. Switching Circuitry	4-1	VII MANUAL CHANGES	7-1
4-15. Output Circuits	4-1	7-1. Introduction	7-1
4-17. Synchronization Circuit	4-1	7-3. Manual Changes	7-1
4-19. Circuit Details	4-1	VIII SCHEMATICS AND	
4-21. Coarse-frequency Control	4-1	TROUBLESHOOTING	8-1
4-25. Fine-frequency Control	4-3	8-1. Introduction	8-1
4-28. Schmitt Trigger Circuit	4-3	8-3. Component Identification	8-1
4-30. Switching Circuit	4-3	8-5. Repair and Replacement	8-1
		8-8. Troubleshooting	8-1

LIST OF ILLUSTRATIONS

Figure	Title	Page	Figure	Title	Page
2-1.	Power Receptacles	2-1	8-1.	Pulse Generator Troubleshooting Tree	8-2
3-1.	Front-panel Controls and Connectors	3-0	8-2.	-70-volts Supply Troubleshooting Tree	8-3
4-1.	Model 211B Block Diagram	4-0	8-3.	-20-volts Supply Troubleshooting Tree	8-3
4-2.	Schmitt Trigger Operation	4-2	8-4.	50 Ohms-600 Ohms Output Troubleshooting Tree	8-4
5-1.	Typical Waveform Characteristics	5-1	8-5.	Chassis Component Identification—Top View	8-4
5-2.	Symmetry Control Check Test Setup	5-2	8-6.	Chassis Component Identification—Bottom View	8-5
5-3.	Synchronization Test Setup	5-3	8-7.	Attenuator Assembly A1 Schematic	8-5
5-4.	600-ohm Output Test Setup	5-3	8-8.	Power Supply Schematic	8-5
5-5.	50-ohm Output Test Setup	5-4	8-9.	Assembly A2 Component Identification	8-6
5-6.	Trigger Output Test Setup	5-4	8-10.	Frequency Control Waveforms	8-7
5-7.	Component Adjustment Location	5-5	8-11.	Frequency Control Schematic	8-7
			8-12.	Output Circuitry Schematic	8-8
			8-13.	Output Circuitry Waveforms	8-8

LIST OF TABLES

Table	Title	Page	Table	Title	Page
1-1.	Specifications	1-1	7-1.	Manual Changes	7-1
5-1.	Required Test Equipment	5-2	8-1.	Schematic Notes	8-0
5-2.	Factory Selected Components	5-6	8-2.	Voltages with Schmitt Trigger Locked in one State	8-6
6-1.	Reference Designators and Abbreviations	6-1	8-3.	Frequency Control Measurement Conditions	8-7
6-2.	Replaceable Parts	6-2	8-4.	Output Circuitry Measurement Conditions	8-8

SECTION I

GENERAL INFORMATION

1-1. INTRODUCTION.

1-2. This Operating and Service Manual contains information required to install, operate, test, adjust, and service the Hewlett-Packard Model 211B Square Wave Generator. Instrument identification, description, options, accessories, specifications, and other basic information are provided in this section.

1-3. Listed on the title page of this manual is a Microfiche part number. This number can be used to order 4 x 6-inch microfilm transparencies of the manual. Each microfiche contains up to 96 photoduplicates of the manual pages. The microfiche package also includes the latest Manual Changes supplement.

1-4. SPECIFICATIONS.

1-5. Instrument specifications are listed in table 1-1. These specifications are the performance standards or limits against which the instrument is tested.

1-6. INSTRUMENTS COVERED BY MANUAL.

1-7. Attached to the instrument is a serial number plate. The serial number is in the form: 0000A00000. It is in two parts; the first four digits and the letter are the serial prefix and the last five digits are the suffix. The prefix is the same for all identical instruments; it changes only when a change is made to the instrument. The suffix however, is assigned sequentially and is different for each instrument. The contents of this manual apply to instruments with the serial number prefix(es) listed under SERIAL NUMBERS on the title page.

1-8. An instrument manufactured after the printing of this manual may have a serial number prefix that is not listed on the title page. This unlisted serial number prefix indicates the instrument is different from those described in this manual. The manual for this newer instrument is accompanied by a yellow Manual Changes supplement. This supplement contains "change information" that explains how to adapt the manual to the newer instrument.

Table 1-1. Specifications

<p>REPETITION RATE AND TRIGGERING</p> <p>INTERNAL</p> <p>50-ohm output: 1 Hz to 10 MHz, 7 ranges.</p> <p>600-ohm output: 1 Hz to 1 MHz, 6 ranges.</p> <p>Period Jitter: < 0.2% at any duty cycle and repetition rate setting.</p> <p>EXTERNAL</p> <p>Sync Input: sine waves or positive pulses from 1 Hz to 10 MHz; frequency of synchronizing signal must be from 105% to 140% of frequency dial setting. +5 V max.</p> <p>Sensitivity: dc coupled, positive pulses, 2 V pk; sine waves, 4 V pk-to-pk.</p> <p>Input Resistance: approximately 500 ohms.</p> <p>TRIGGER OUTPUT</p> <p>Width: 10 (±5) ns at 50% point.</p> <p>Amplitude: ±2 V into 50 ohms.</p> <p>Timing: coincident with leading edge of 50-ohm pulse.</p> <p>Polarity: positive or negative.</p> <p>OUTPUT</p> <p>Symmetry: variable from 25% to 75% duty cycle.</p> <p>Polarity: negative.</p>	<p>50-OHM SOURCE</p> <p>Pulse Shape: (measured at 5 V into 50 ohms).</p> <p>Rise Time and Fall Time: <5 ns.</p> <p>Amplitude: peak 5 V into 50 ohms, 10 V into an open circuit; output circuit protected, cannot be damaged by shorting.</p> <p>Attenuator: 0.05 V to 5 V, in a 1, 2.5, 5 sequence.</p> <p>Vernier: provides continuous adjustment between ranges.</p> <p>600-OHM SOURCE</p> <p>Rise Time and Fall Time: <70 ns into 600 ohms; <140 ns into an open circuit; decreased amplitude will improve rise time.</p> <p>Amplitude: at least 30 V peak into 600 ohms; at least 60 V into an open circuit.</p> <p>Attenuator: provides continuous adjustment from full output to less than 0.3 V into 600 ohms.</p> <p>GENERAL</p> <p>Power: 115 V or 230 V (−10%+15%), 50 to 400 Hz, 23W.</p> <p>Dimensions: 198 mm wide x 165 mm high x 299 mm deep overall (7-3/4 x 6-1/2 x 11-3/4 in.).</p> <p>Weight: net, 4 kg (9 lb).</p>
---	--

1-9. In addition to change information, the supplement may contain information for correcting errors in the manual. To keep this manual as current and accurate as possible, Hewlett-Packard recommends that you periodically request the latest Manual Changes supplement. The supplement for this manual is identified with the manual print date and part number, both of which appear on the manual title page. Complimentary copies of the supplement are available from Hewlett-Packard.

1-10. An instrument manufactured before the printing of this manual will have a serial prefix number lower than 1644A. If your instrument has such a serial prefix number, refer to Section VII.

1-11. For information concerning a serial number prefix that is not listed on the title page or in the Manual Changes supplement, contact your nearest Hewlett-Packard office.

1-12. DESCRIPTION.

1-13. The Hewlett-Packard Model 211B Square Wave Generator is a general-purpose instrument that provides negative square-wave output signals of variable frequency, width, and amplitude. In addition, trigger output signals of reversible polarity are provided for synchronizing external circuits or instruments. The Model 211B Square Wave Generator is a free-running instrument. It may be synchronized with an external signal. The frequency range is from 1 Hz to 10 MHz

when terminated in a 50-ohm load. Amplitude of the signal is variable from .05 volt to -5 volts with an adjustable pulse width of 25% to 75% of the period. With its variable pulse amplitude and width characteristics, the 211B is useful as a general-purpose laboratory or production-line instrument. Due to its compact size and ease of operation, it is an ideal single-unit instrument for test applications where synchronization triggering and pulse generator facilities are desired simultaneously.

1-14. A separate facility for trigger output pulses is also provided. Trigger output pulses are coincidental with the leading edge of the output pulses at the 50-ohm connector. The trigger output circuit is used for synchronizing external circuits or instruments. Polarity of the trigger pulses is selectable (either positive or negative) and their amplitude is greater than 2 volts. Pulse width is less than 10 nanoseconds when terminated in a 50-ohm load.

1-15. OPTIONS.

1-16. Standard options are modifications installed on HP instruments at the factory and are available on request. The following option is available on Model 211B:

OPTION 580. The standard Model 211B meets the requirements of CSA standards. This option adds two labels to the unit to acknowledge this fact. Add HP Part No. 5955-0123, LABEL, OPTION 580; and HP Part No. 7120-4835, LABEL, CSA CERTIFICATION.

SECTION II INSTALLATION

2-1. INITIAL INSPECTION.

2-2. Inspect the shipping container for damage. If the shipping container or cushioning material is damaged, it should be kept until the contents of the shipment have been checked for completeness and the instrument has been checked mechanically and electrically; procedures for checking electrical performance are given in Section V. If the contents are incomplete, if there is mechanical damage or defect, or if the instrument does not pass the Performance Tests, notify the nearest Hewlett-Packard office. If the shipping container is damaged, or the cushioning material shows signs of stress, notify the carrier as well as the Hewlett-Packard office. Keep the shipping materials for carrier's inspection. The HP office will arrange for repair or replacement at HP Option without waiting for claim settlement.

2-3. PREPARATION FOR USE.

2-4. **POWER REQUIREMENTS.** The standard Model 211B requires either a 115-Vac or 230-Vac ($-10\%+15\%$), single phase, 50- to 400-Hz power source that can deliver at least 40 VA. A rear panel LINE slide switch selects operation on either 115 V or 230 V. When the operating voltage is changed, the line fuse should also be changed to ensure instrument protection. Use a slow-blow fuse if replacement is required.

2-5. **115 V Operation.** The standard instrument, as shipped from the factory, is ready for operation on 115 Vac. The rear-panel LINE switch must display the legend 115 when operation from this voltage is intended. Fuse value for 115 V operation is marked on the rear panel.

2-6. **230 V Operation.** If the instrument is to be operated on 230 Vac, set the LINE switch to display 230. Change the fuse to the proper value for 230 V operation, as marked on the rear panel.

2-7. **THREE-CONDUCTOR POWER CABLE.** This instrument is equipped with a three-conductor power cable that, when connected to an appropriate receptacle, grounds the instrument through the offset pin. The power cable required depends on the ac input voltage, and the country in which the instrument is to

be used. Figure 2-1 illustrates the standard power receptacle (wall outlet) configurations that are used throughout the United States and in other countries. The HP part number shown adjacent to each receptacle drawing is the part number for a power cable equipped with a mating plug for that receptacle. If the appropriate power cable is not included with the instrument, notify the nearest Hewlett-Packard Sales/Service Office and a replacement cable will be provided.





HP POWER CABLE PART NUMBERS		
8120-1689	8120-1369	
		
8120-1351	8120-2104	8120-1378
		
INPUT POWER RECEPTACLE TYPES		

Figure 2-1. Power Receptacles 211B-001-12-76

2-8. When operating the 211B from a two-contact power outlet, use a three-conductor to two-conductor adapter. Preserve the safety feature by grounding the adapter flexible (third) lead.

2-9. REPACKING FOR SHIPMENT.

2-10. If Model 211B is to be shipped to an HP Sales/Service Office for service or repair, attach a tag showing owner (with address), complete instrument serial number, and a description of the service required.

2-11. Use the original shipping carton and packing material. If the original packing material is not available, the HP Sales/Service Office will provide information and recommendations on materials to be used.

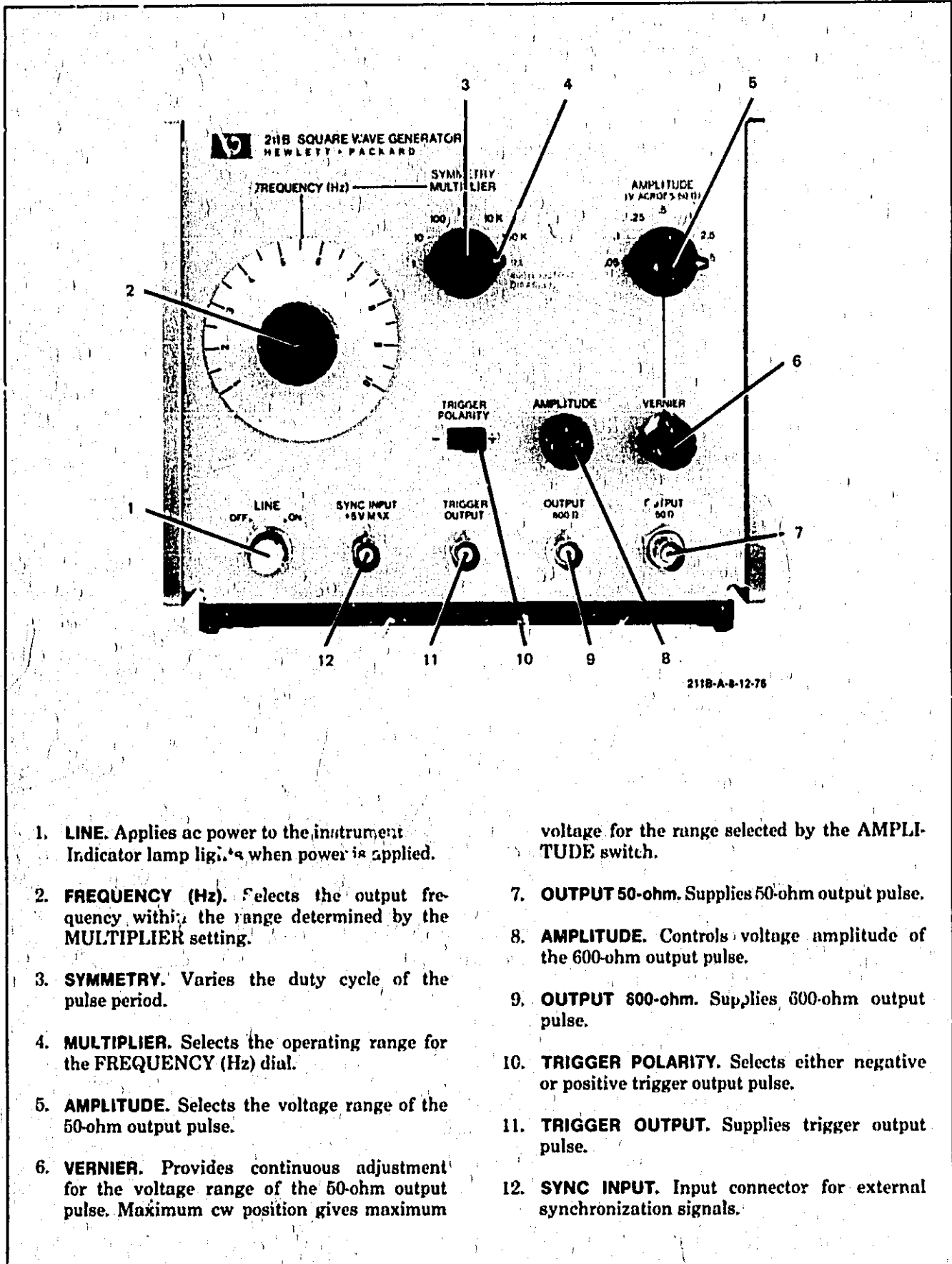

- | | |
|--|--|
| <ol style="list-style-type: none"> 1. LINE. Applies ac power to the instrument. Indicator lamp lights when power is applied. 2. FREQUENCY (Hz). Selects the output frequency within the range determined by the MULTIPLIER setting. 3. SYMMETRY. Varies the duty cycle of the pulse period. 4. MULTIPLIER. Selects the operating range for the FREQUENCY (Hz) dial. 5. AMPLITUDE. Selects the voltage range of the 50-ohm output pulse. 6. VERNIER. Provides continuous adjustment for the voltage range of the 50-ohm output pulse. Maximum cw position gives maximum | <ol style="list-style-type: none"> voltage for the range selected by the AMPLITUDE switch. 7. OUTPUT 50-ohm. Supplies 50-ohm output pulse. 8. AMPLITUDE. Controls voltage amplitude of the 600-ohm output pulse. 9. OUTPUT 600-ohm. Supplies 600-ohm output pulse. 10. TRIGGER POLARITY. Selects either negative or positive trigger output pulse. 11. TRIGGER OUTPUT. Supplies trigger output pulse. 12. SYNC INPUT. Input connector for external synchronization signals. |
|--|--|

Figure 3-1. Front-panel Controls and Connectors

SECTION III OPERATION

3-1. INTRODUCTION.

3-2. This section includes explanation of front-panel controls and adjustments, available modes of operation, triggering considerations and step-by-step operating instructions for most applications.

3-3. CONTROLS AND CONNECTORS.

3-4. Although the functions described in figure 3-1 are brief, they provide a ready reference for the operator. A more detailed description of some of the controls and connectors is given in the following paragraphs.

3-5. **Symmetry Control.** The SYMMETRY control on the front panel of the Model 211B varies the duty cycle of the output pulse without affecting the frequency. The duty cycle is variable between 25% and 75% of the pulse period and is unaffected by external triggering and repetition rate.

3-6. **50-ohm Amplitude Control.** The amplitude of the 50-ohm output pulses is controlled by an AMPLITUDE switch and a VERNIER control. The AMPLITUDE control is a seven-position attenuator switch covering an output voltage range from -0.05 volt to -5 volts. The voltage range selected by the attenuator setting is variable by the VERNIER control (from near zero volt to maximum output for the particular range selected).

3-7. **600-ohm Amplitude Control.** The amplitude of the 600-ohm output pulse is controlled by the AMPLITUDE control located directly above the 600-ohm output connector. The amplitude is continuously variable from near zero volt to -30 volts when terminated in a 600-ohm load.

3-8. OPERATING CONSIDERATIONS.

3-9. EXTERNAL SYNCHRONIZATION.

CAUTION

Input synchronization signal must not exceed 5 volts peak and power must be less than 0.25 watt.

3-10. The Model 211B may be synchronized by either a +2-volt minimum pulse or a 4-volt minimum peak sine wave applied to the SYNC INPUT connector. The frequency of the synchronization signal must be between 105% and 140% of the internal frequency setting. If difficulty is encountered when synchronizing with an external source, recheck the dial frequency setting, the synchronization frequency, and the amplitude of the synchronization signal.

3-11. TRIGGER OUTPUT.

3-12. The positive or negative trigger pulses which are available at the TRIGGER OUTPUT connector have an amplitude greater than 2 volts (across a 50-ohm load), approximately 10 nanoseconds in width, and are coincidental with the leading edge of the 50-ohm output pulse.

3-13. OPERATING PROCEDURES.

3-14. The Model 211B is capable of generating any frequency from 1 Hz to 10 MHz (maximum of 1 MHz at the 600-ohm connector). The frequency is established by setting the MULTIPLIER switch to any of seven ranges and adjusting the FREQUENCY (Hz) control to the specific frequency desired. The Model 211B is free-running at the frequency indicated by the front panel frequency controls. To operate the instrument, proceed as follows:

a. To apply power, press LINE switch; power lamp should light.

b. Set MULTIPLIER switch to correct frequency range and adjust FREQUENCY (Hz) control to desired frequency.

c. Adjust SYMMETRY control for required pulse width as observed on an oscilloscope.

d. When using the 50-ohm output circuit, select proper voltage attenuator range with AMPLITUDE selector switch. Adjust VERNIER control for exact voltage required. Refer to table 1-1 for output termination characteristics.

e. When using the 600-ohm output circuit, adjust AMPLITUDE control for required voltage amplitude. Refer to table 1-1 for termination characteristics.

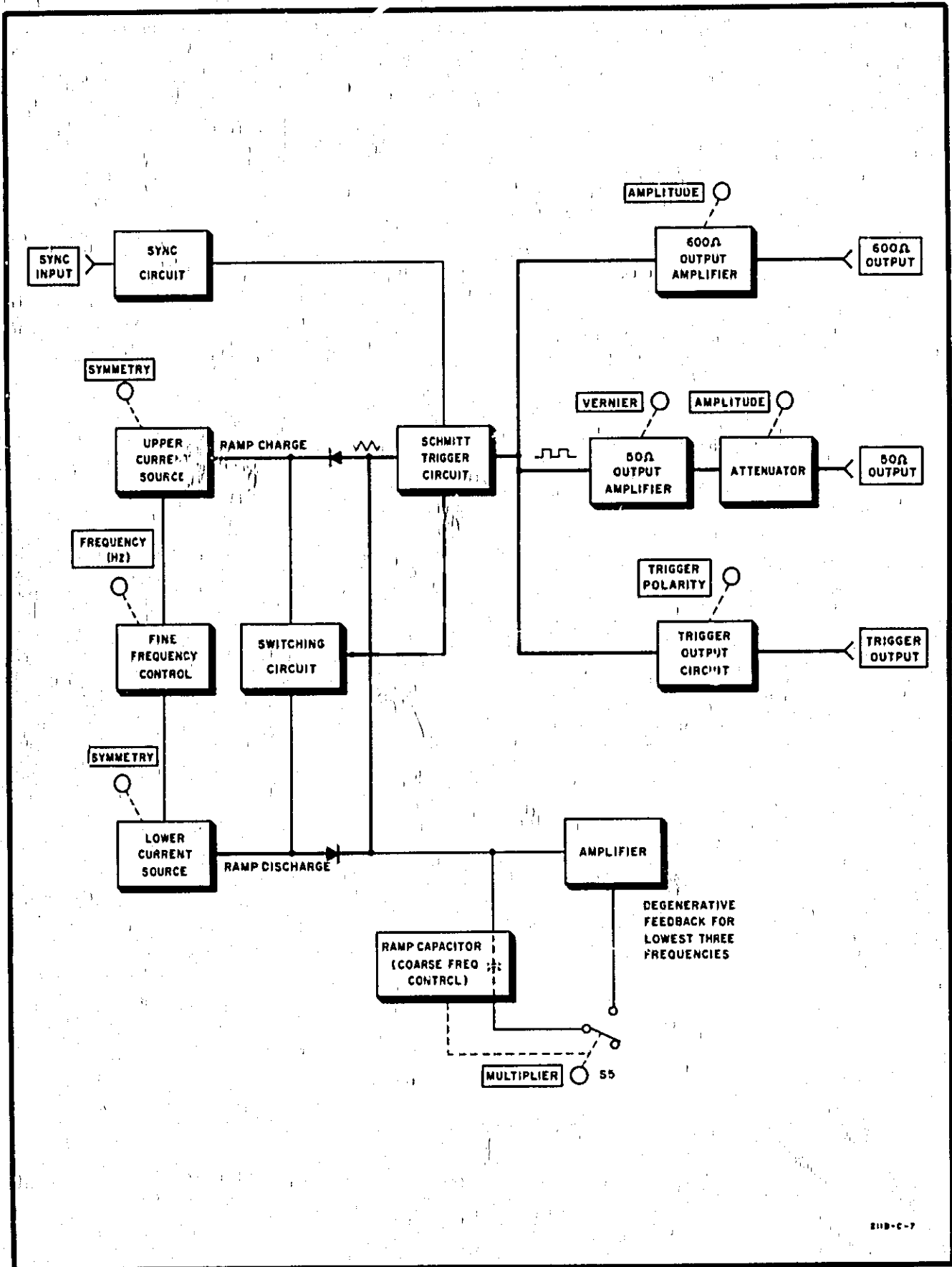

211B-C-7

Figure 4-1. Model 211B Block Diagram

SECTION IV

PRINCIPLES OF OPERATION

4-1. INTRODUCTION.

4-2. This section presents the theory of operation for the Model 211B Square Wave Generator. The first portion contains a general description of circuit functions using a block diagram (figure 4-1) to supplement the written description. The second portion provides a detailed description of the operational theory written for use with the schematics which are located in Section VIII of this manual.

4-3. BLOCK DIAGRAM DESCRIPTION.

4-4. The Model 211B consists of a fine-frequency control, two current sources, a coarse-frequency control, and a Schmitt trigger circuit. The output of the Schmitt trigger is applied to three amplifier circuits. The amplifier circuits produce symmetrical output pulses which are present at the 50-ohm, 600-ohm, and TRIGGER OUTPUT connectors.

4-5. FINE-FREQUENCY CONTROL.

4-6. The front-panel control, FREQUENCY (Hz), establishes the pulse repetition rate of the square-wave generator by adjusting the bias applied to the two current sources.

4-7. CURRENT SOURCES.

4-8. The current sources (referred to as the upper and lower current sources in the block diagram) operate as current regulators for the coarse-frequency control circuit. The upper current source provides the current for charging the selected ramp capacitor in the coarse-frequency control circuit and the lower current source establishes the rate of discharge.

4-9. COARSE-FREQUENCY CONTROL.

4-10. The MULTIPLIER switch, located on the front panel of the Model 211B, selects various resistance-capacitance networks which determine the slope of the ramp waveform. The various sawtooth waveforms developed by the ramp capacitance networks establish the repetition rate for the Schmitt trigger circuit.

4-11. SCHMITT TRIGGER.

4-12. The sawtooth waveform from the ramp capacitance network alternately crosses the upper and lower hysteresis limits of the Schmitt trigger. This results in a square-wave output at a repetition rate established by the coarse and fine frequency control circuits. The Schmitt-trigger output is applied to the output amplifiers.

4-13. SWITCHING CIRCUITRY.

4-14. The switching circuit is controlled by a signal fed back from the Schmitt trigger. It regulates the charge or discharge state of the selected ramp capacitor.

4-15. OUTPUT CIRCUITS.

4-16. The square-wave signal from the Schmitt trigger is amplified and shaped by the 50-ohm and 600-ohm output circuits. The trigger circuit differentiates the output of the Schmitt trigger and reshapes the pulses. Polarity of the trigger pulses is selectable by switch action.

4-17. SYNCHRONIZATION CIRCUIT.

4-18. The Model 211B may be synchronized from an external source. The synchronization signal is differentiated and applied to the Schmitt trigger circuit.

4-19. CIRCUIT DETAILS.

4-20. Refer to the timing sequence in figure 4-2 and the schematics located in Section VIII of this manual when using the detailed theory of operation.

4-21. COARSE-FREQUENCY CONTROL.

4-22. The coarse-frequency circuit is controlled by the seven-position MULTIPLIER switch S5. Each position of the MULTIPLIER switch selects the appropriate ramp capacitor (A2C11 through A2C16) for the designated frequency range. When the 1M frequency range is selected, a network consisting of A2C8, A2C9, A2C10 and A2R31 is used to develop the higher frequency involved.

4-23. The selected ramp capacitor will charge and discharge at a rate determined by current-source transistors A2Q6 and A2Q7. Transistor A2Q6 functions as a series regulator in the current path that charges the selected capacitor. The charging rate of the ramp capacitor forms the negative slope of the sawtooth waveform. The output current of A2Q6 is directed to the ramp capacitor by diode A2CR11. Transistor A2Q7 functions as a series regulator in the discharge path of the selected ramp capacitor. The discharging rate of the ramp capacitor forms the positive slope of the sawtooth waveform. Diode A2CR12 directs the discharge current from the ramp capacitor through A2Q to ground.

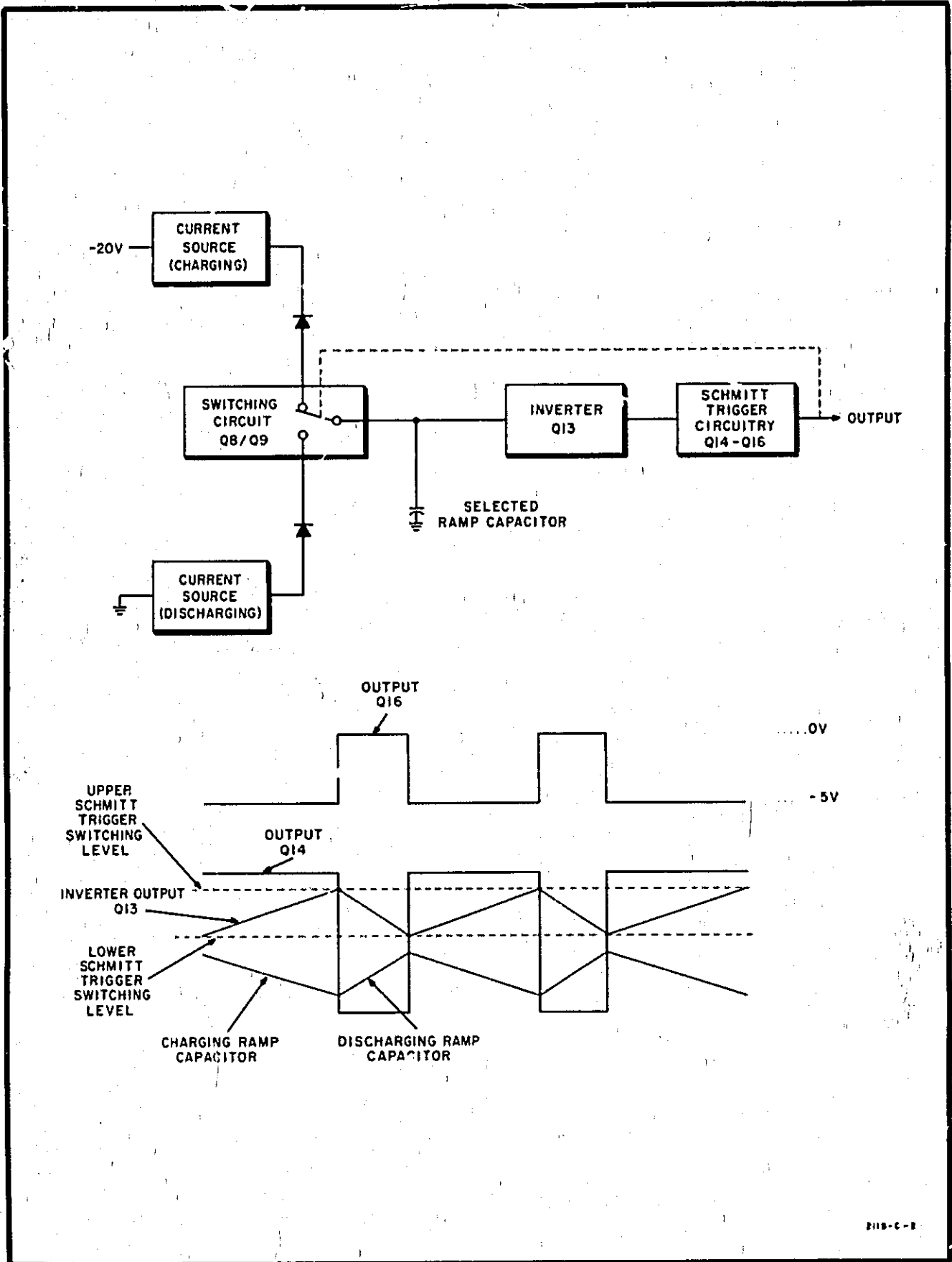

Figure 4-2. Schmitt Trigger Operation

4-24. Dual potentiometer R3 determines the duty cycle for each period of the pulse repetition rate. It controls the current in the emitter circuits of A2Q6 and A2Q7. Potentiometer R3 is adjusted by the SYMMETRY control knob on the front panel of the instrument. Varying the SYMMETRY control changes the rate at which the upper and lower hysteresis limits of the Schmitt trigger are crossed per repetition pulse. This establishes the duty cycle for each period.

4-25. FINE-FREQUENCY CONTROL.

4-26. The fine-frequency circuit of the Model 211B consists of potentiometer R2, A2R24, A2R25 and A2Q5. Potentiometer R2 is a 10:1 vernier controlled by the FREQUENCY (Hz) dial on the front panel of the instrument. The FREQUENCY (Hz) dial establishes the bias applied to current-control transistor A2Q5. The bias on A2Q5 controls the voltage developed across resistors A2R24 and A2R25. The voltages developed at A2R24 and A2R25 form the bias for charge and discharge transistors A2Q6 and A2Q7. The rate at which A2Q6 permits the ramp capacitor to charge and the rate at which A2Q7 permits it to discharge determine the repetition rate for the instrument.

4-27. On the three lower frequency ranges (controlled by A2C11, A2C12 and A2C13), a degenerative feedback network consisting of A2Q11 and A2Q12 is used to compensate for the slower charge and discharge rate required. Transistor A2Q12 inverts the emitter signal of A2Q13 and applies it to the base of A2Q11. The collector circuit of A2Q11 controls the bias on transistor A2Q10. Transistor A2Q10 forms a low-impedance ground circuit for the three lowest frequency capacitors. Variable resistors A2R33, A2R34 and A2R35 control the amplitude of the degenerative feedback signal. Refer to Section V of this manual for proper adjustments.

4-28. SCHMITT TRIGGER CIRCUIT.

4-29. Charging of the selected ramp capacitor produces the negative slope of the sawtooth waveform (figure 4-2). This signal is applied to the base of transistor A2Q13. The inverted signal developed in the collector circuit of A2Q13 is applied to the base of transistor A2Q14. Transistors A2Q14 and A2Q15 function as a Schmitt trigger circuit. When the upper hysteresis limit of A2Q14 is reached, it conducts heavily and A2Q15 is cut off. When the lower hysteresis limit of A2Q14 is reached, it is biased off and A2Q15 conducts. The square-wave signal developed by A2Q15 is inverted by transistor A2Q16 and applied to the output circuits.

4-30. SWITCHING CIRCUIT.

4-31. Synchronization of the charge and discharge functions of the current sources is accomplished by transistors A2Q8 and A2Q9. The output signal from the Schmitt trigger is coupled through diode A2VR5

to the base circuits of A2Q8 and A2Q9. Transistors A2Q8 and A2Q9 are complementary (npn-pnp). Depending on the polarity of the output pulse, one transistor will conduct while the other is cut off. When A2Q8 is conducting (positive transition of the signal from A2Q16), diode A2CR11 is back biased and the charging circuit between A2Q6 and the ramp capacitor is blocked. During the same positive transition of the signal from A2Q16, transistor A2Q9 is cut off. The discharge path from the ramp capacitor through A2CR12 and A2Q7 to ground is operational. When A2Q8 is not conducting (negative transition of the signal from A2Q16) the charge path from the ramp capacitor through A2CR11 and A2Q6 to the -20-volt source is operational. During the same negative transition of the signal from A2Q16, transistor A2Q9 is conducting. With A2Q9 conducting, diode A2CR12 is back biased and the discharge path of the ramp capacitor is blocked.

4-32. OUTPUT CIRCUITS.

4-33. **Trigger Output.** The output signal from Impedance Converter A2Q16 is applied to a differentiating circuit A2C18 and A2R45 in the trigger output circuit. The positive spike developed by the differentiator is applied to trigger amplifier A2Q17. The signal is shaped into a negative pulse having a 10-nanosecond width and greater than 2 volts in amplitude (when terminated in a 50-ohm load). The output of A2Q17 is connected to one side of trigger-polarity switch S4 and transistor A2Q18. Transistor A2Q18 inverts the negative pulse and applies it to the other side of S4. The position of S4 determines the polarity of the trigger output pulse.

4-34. **50-ohm Output Circuit.** The signal from transistor A2Q16 is also applied to transistor A2Q23. Transistor A2Q23 and A2Q25 are used to amplify and shape the square-wave pulse. The output of A2Q25 is applied to a cascode amplifier stage consisting of A2Q29, A2Q30, A2Q32 and A2Q33. The output of the cascode amplifier is connected to attenuator A1.

4-35. The amplitude of the 50 ohm signal is controlled by AMPLITUDE switch A1S1 and the VERNIER control on the front panel of the instrument. The VERNIER control varies the bias on amplitude-control transistor A2Q27. An in-phase voltage at the emitter of A2Q27 is applied as bias to the output cascode transistors A2Q32 and A2Q33. By adjusting the bias on the output transistors, the amplitude of the output signal is varied from near zero to -5 volts. Diode A2CR20 functions as a protective device against any inductive overloads.

4-36. An attenuator network is used to limit the amplitude of the output signal to from -0.05 volt to -5 volts. Attenuator A1 has three pi-type resistance networks. These networks divide the signal from the cascode amplifiers by factors of two, five and ten. Amplitude switch A1S1 selects the desired voltage

range by connecting the cascode amplifier output to selected combinations of the pi-networks. The output of the pi-networks is connected to the OUTPUT 50Ω connector on the front panel of the instrument.

4-37. 600-ohm Output. The signal from transistor A2Q16 is also applied to amplifier A2Q24 in the 600-ohm amplifier circuit. Transistors A2Q24 and A2Q26 amplify and shape the square-wave pulses before applying them to driver amplifier A2Q31. When the 1M frequency range is selected, A2Q24 is reverse biased by the addition of resistor R5 in its emitter circuit. There is no output from the 600-ohm circuit on the 1M frequency range. Variable resistor A2R88 is adjusted for a signal amplitude which results in no distortion of the output waveform.

4-38. The signal from A2Q26 is amplified by driver-amplifier A2Q31 and applied to transistors Q3 and Q4 operating in cascode. (Transistors Q3 and Q4 are located on the instrument chassis). Transistors Q3 and Q4 amplify and further shape the output signal. The amplitude of the output signal is continuously variable from zero to -30 volts by resistor R6 (AMPLITUDE). Diode A2CR21 functions as a protective device against any inductive overload.

4-39. SYNCHRONIZATION.

4-40: An external synchronization signal may be applied to the instrument at the SYNC INPUT connector J2. The synchronization signal must have an amplitude of at least +2 volts peak and a frequency of 105% to 140% of the frequency dial setting of the Model 211B. The synchronizing signal is applied to a divider bridge consisting of diodes A2CR13-A2CR16. The diode bridge configuration limits the amplitude of the input signal to +4 volts.

4-41. When the synchronizing signal produces a positive voltage at the junction of A2CR14 and A2CR16, transistor A2Q19 conducts. The negative voltage developed by A2Q19 is applied to A2Q20 through diode A2VR9. Normally, A2Q20 is forward biased and conducting. When the negative voltage from A2Q19 is applied, A2Q20 is cut off. The magnetic field produced by A2L1 when A2Q20 is conducting collapses and produces a 20-nanosecond positive pulse. Depending on the position of the SYMMETRY control, the 20-nanosecond pulse is applied to either A2Q21 or A2Q22 by switch S3. The synchronization pulses are applied to the Schmitt trigger circuit during the longer slope of the ramp waveform. When the duty cycle is below 50% of the pulse period, S3 connects the synchronizing pulses to A2Q22. When the duty cycle is greater than 50% of the pulse period, the synchronizing pulses are

connected to A2Q21. Synchronization is not possible at exactly 50% of the duty cycle.

4-42. When either A2Q21 or A2Q22 conducts (with application of a synchronization pulse) a negative 20-nanosecond pulse is produced. The negative pulse is connected to the base of either A2Q14 or A2Q15 in the Schmitt trigger circuit. Since the pulse is applied to the Schmitt trigger transistor which is conducting, the Schmitt trigger switches operating states, thus synchronizing the sawtooth waveform from the frequency control circuit to the synchronization signal.

4-43. POWER SUPPLIES.

4-44. The regulated power supply operates from 115 or 230 volts ac. The voltage is rectified to provide the dc outputs of -20 volts, -70 volts, and +6.8 volts. The two primary windings of transformer T1 are connected either in series (230 volts ac operation) or in parallel (115 volts ac operation) by switch S2.

4-45. -20-volt Power Supply. Diodes A2CR1 and A2CR2 comprise a full-wave rectifier which furnishes the negative voltage for the -20-volt power supply. The unregulated voltage is filtered by capacitor C1 and applied to series regulator Q1. Resistor A2R7, A2R8, and A2R9 form a voltage-divider network between ground and the -20-volt output. The base of error-amplifier A2Q2 is connected to the voltage-divider network and senses any change in output voltage. The change in output voltage is amplified and inverted by A2Q2 and applied to regulator-driver A2Q1. Transistor A2Q1 functions as an emitter follower and is connected to the base circuit of series regulator Q1. This regulates the bias on Q1 and maintains the output of the power supply at -20 volts.

4-46. -70-volt Power Supply. The -70-volt power supply functions in the same manner as the -20-volt power supply with the exception of the rectifier circuit. The secondary winding of transformer T1 used by the -20-volt power supply is center-tapped to ground. This enables the use of the two-diode rectifier system. The two-diode rectifier arrangement cannot be employed for the -70-volt power supply. The secondary winding of transformer T1 used for the -70-volt power supply is not center-tapped. The bridge network consisting of A2CR5 through A2CR8 is used for full-wave rectification.

4-47. +6.8-volt Power Supply. Diodes A2CR3 and A2CR4 form a full-wave rectifier which supplies the +6.8-volt power for the instrument. Capacitor A2C5 filters the rectified voltage. Resistor A2R10 reduces the voltage to the proper level and breakdown diode A2VR1 regulates the output.

SECTION V PERFORMANCE CHECK AND ADJUSTMENTS

5-1. INTRODUCTION.

5-2. This section provides adjustment procedures and a performance check for the Model 211B. The performance check may be used as an incoming inspection, or after repairs or adjustments have been made to certify that the instrument meets the specifications listed in table 1-1. When the initial performance check is made, record the indications on the Performance Check Record. These indications may be used for comparisons with equipment performance at a later date. Refer to paragraph 5-17 for adjustment procedures.

5-3. REQUIRED TEST EQUIPMENT.

5-4. Test equipment recommended for both the performance check and adjustments is listed in table 5-1. Similar equipment may be substituted provided it has the required characteristics listed in the table.

5-5. PERFORMANCE CHECK.

5-6. PROCEDURE.

5-7. Connect the Model 211B to an external power source. Turn on the equipment and allow 10 minutes

for warm up. Perform the checks and adjustments in the same sequence as they are listed. Figure 5-1 is a typical waveform which illustrates points that are described in this section.

5-8. SYMMETRY CONTROL CHECK.

a. Connect equipment as shown in figure 5-2 and set 211B controls as follows:

MULTIPLIER	10K
FREQUENCY (Hz)	1
SYMMETRY	cw
AMPLITUDE (switch)	5
VERNIER	cw

b. Set high-frequency oscilloscope controls as follows:

TIME/DIV	10 μ sec
TRIGGER	INT
MODE	NORM
VOLTS/DIV	2
TRIGGER SLOPE	(-)

c. Adjust high-frequency oscilloscope for a stable display.

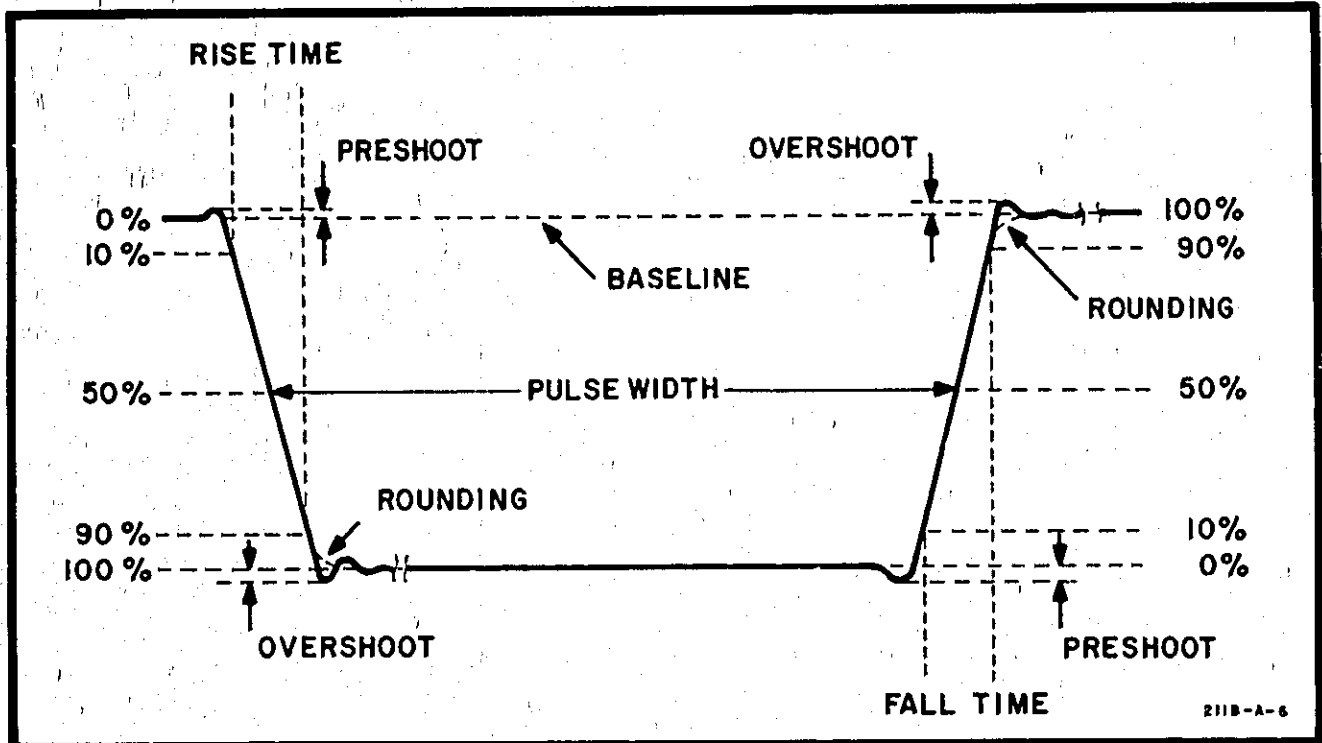

Figure 5-1. Typical Waveform Characteristics

Table 5-1. Required Test Equipment

Recommended Instrument		Required Characteristics	Required for
Type	Model		
Sampling Oscilloscope	HP 180C with 1810A	1 GHz Bandwidth	Performance Check
High-frequency Oscilloscope	HP 1740A	50 MHz Bandwidth 50 mV/cm Sensitivity	Performance Check Adjustments
Frequency Counter	HP 5245L	Period Meter Frequency Counter	Performance Check Adjustments
20 dB 50-ohm Attenuator	HP 8491	Use Recommended Equipment	Performance Check
50-ohm Load	HP 10100C	Feedthrough Load	Performance Check Adjustments
600-ohm Load		600-ohm $\pm 5\%$ 2W	Performance Check
BNC Adapter	HP 10110A	BNC male to Binding Post	Performance Check
Test Oscillator	HP 651B	10 Hz to 10 MHz 3 V Output Range	Performance Check
AC Voltmeter	HP 403B	0.003 V to 0.03 V Voltage Range	Adjustments Troubleshooting
Digital Voltmeter	HP 3465A	$\pm 0.05\%$ accuracy 4 digit display	Adjustments
Variable line Voltage Supply		100 - 128 V 200 - 255 V 25 VA	Adjustments

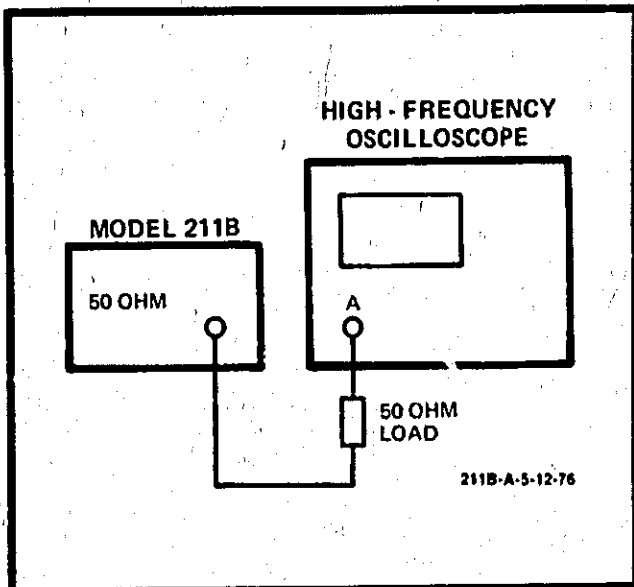

Figure 5-2. Symmetry Control Check Test Setup

d. Pulse width should be greater than 75% of the period.

e. Turn SYMMETRY control fully ccw. Pulse width should be less than 25% of the period.

5-9. SYNCHRONIZATION CHECK.

a. This procedure checks the ability of the Model 211B to synchronize on an external trigger source.

b. Connect equipment as shown in figure 5-3.

c. Set 211B controls as follows:

- MULTIPLIER 100K
- FREQUENCY (Hz) 1
- SYMMETRY ccw
- AMPLITUDE (switch) 5
- VERNIER cw

d. Set high-frequency oscilloscope controls as follows:

TIME/DIV 5 μ sec
 TRIGGER EXT
 MODE NORM
 VOLTS/DIV 2

e. Set test oscillator controls as follows:

FREQUENCY 110K
 AMPLITUDE 4 V pk-to-pk

f. Adjust high-frequency oscilloscope SWEEP VERNIER until one pulse period occupies 8 divisions on the CRT.

g. Turn SYMMETRY control slowly cw. Observe phase shift reversal at 50% duty-cycle point. (Pulse width will increase until at 50%, polarity will reverse and width will decrease.)

h. Repeat procedure with SYMMETRY control in cw position.

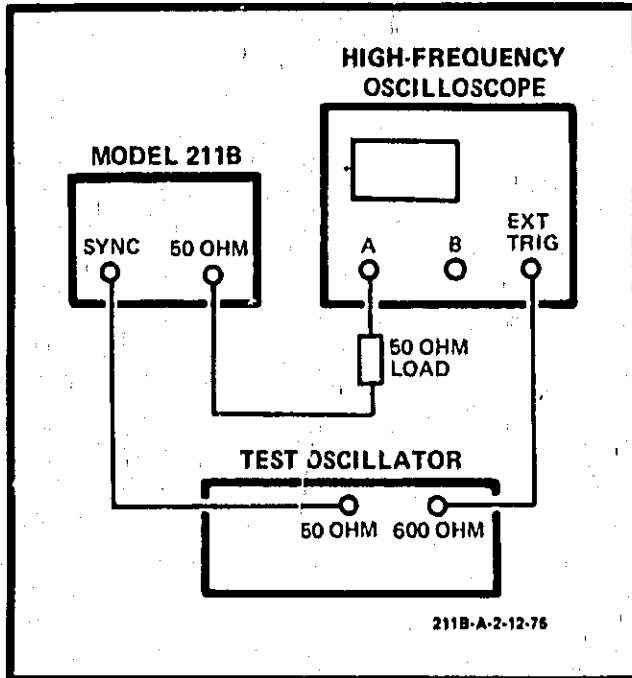

Figure 5-3. Synchronization Test Setup

5-10. 600-OHM OUTPUT CHECK.

a. See figure 5-1 for definition of pulse characteristics.

b. Connect equipment as shown in figure 5-4.

c. Set 211B controls as follows:

MULTIPLIER 10K
 FREQUENCY (Hz) 10
 SYMMETRY approximately 50%
 AMPLITUDE (600-ohm control) cw

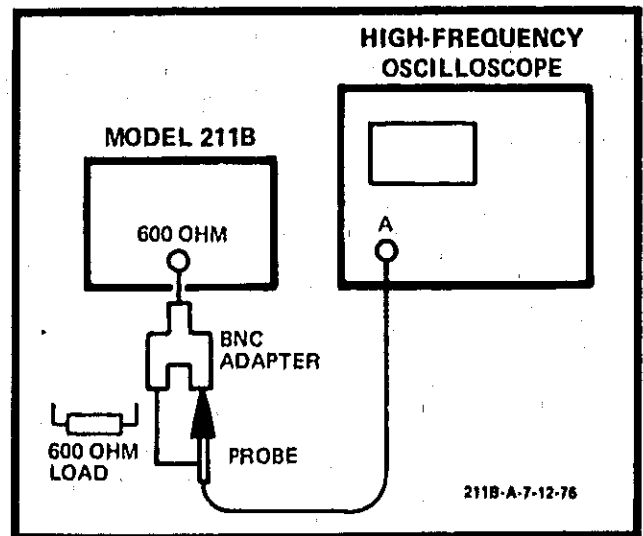

Figure 5-4. 600-ohm Output Test Setup

d. Set high-frequency oscilloscope controls as follows:

TIME/DIV 2 μ sec
 TRIGGER +, INT
 MODE NORM
 SLOPE (-)
 VOLTS/DIV 10

e. Adjust AMPLITUDE control of 211B for pulse amplitude of 60 volts (6 divisions). Overshoot should be less than 3 minor divisions (5%).

f. Connect a 600-ohm load across 600-ohm output connector of 211B. Pulse amplitude should be 30 volts (3 divisions) \pm 5%.

g. Turn AMPLITUDE (600-ohm) control fully cw.

h. Set oscilloscope VOLTS/DIV dial to .1 and adjust AMPLITUDE control of 211B for 0.3 volt (3 divisions) as indicated on oscilloscope. Overshoot should be less than 1.5 minor divisions. Disconnect 600-ohm load.

5-11. RISE TIME AND FALL TIME.

a. Set high-frequency oscilloscope TIME/DIV dial to .2 μ SEC and VOLT/DIV dial to 1. Adjust 600-ohm AMPLITUDE control on 211B for 6 divisions deflection.

b. Move leading edge of pulse to center of CRT. Set oscilloscope MAGNIFIER to X10. Rise time between 10% and 90% amplitude points should be less than 7 divisions (140 ns).

c. Change oscilloscope SLOPE to (+) and move trailing edge of pulse to center of CRT. Fall time between 10% and 90% amplitude points should be less than 7 divisions (140 ns).

d. Connect Model 211B output to a 600-ohm load.

e. Set oscilloscope VOLT/DIV dial to .5. Fall time between 10% and 90% amplitude points should be less than 3.5 divisions (70 ns).

f. Change oscilloscope SLOPE to (—) and move leading edge of pulse to center of CRT. Rise time between 10% and 90% amplitude points should be less than 3.5 divisions (70 ns). Remove 600-ohm load.

5-12. 50-OHM OUTPUT CHECK.

a. Connect equipment as shown in figure 5-5.

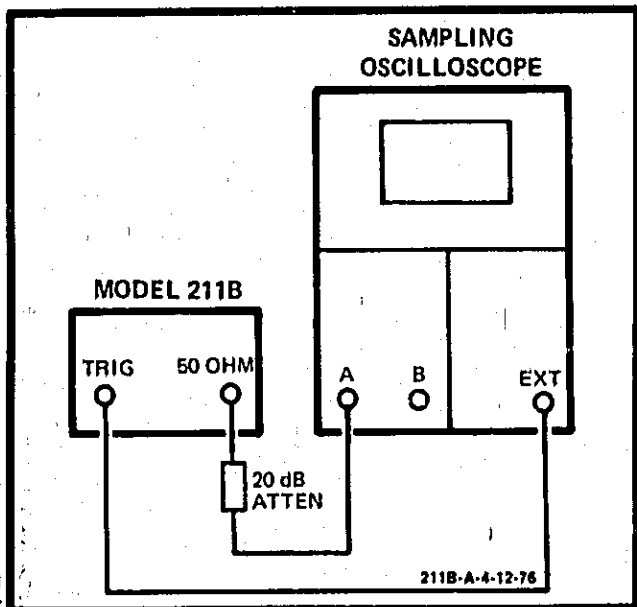

Figure 5-5. 50-ohm Output Test Setup

b. Set 211B controls as follows:

MULTIPLIER	1M
FREQUENCY (Hz)	5
SYMMETRY	50% duty cycle
AMPLITUDE (switch)	5
VERNIER	cw
TRIGGER POLARITY	(—)

c. Set the sampling oscilloscope controls as follows:

TIME/DIV	20 nSEC
MAIN SWEEP MAGNIFIER	20
MAIN SWEEP TRIGGER	NORM
MAIN SWEEP TRIGGER SLOPE	(—)
MILLIVOLTS/DIV	50
DISPLAY	NORM

d. Adjust pulse amplitude to 5 volts (10 divisions) with 211B VERNIER.

e. Move leading edge of pulse to center of CRT. Rise time should be less than 5 ns.

f. Move trailing edge of pulse to center of CRT. Fall time should be less than 5 ns.

5-13. With 211B controls set as in paragraph 5-12b, set the sampling oscilloscope controls as follows:

TIME/DIV	50 nSEC
MAIN SWEEP MAGNIFIER	2
MAIN SWEEP TRIGGER	NORM
MAIN SWEEP TRIGGER SLOPE	(—)
MILLIVOLTS/DIV	50
DISPLAY	NORM

a. Adjust pulse amplitude to 5 volts (10 divisions) with 211B amplitude VERNIER.

b. Move leading edge of pulse to center of CRT. Preshoot and overshoot of the leading edge should be no more than 5 minor divisions (5%).

c. Move trailing edge of pulse to center of CRT. Preshoot and overshoot of the trailing edge should be no more than 3 minor divisions (5%).

5-14. SYMMETRY (10 MHz).

a. Set FREQUENCY (Hz) dial of 211B to 10 and SYMMETRY control fully ccw. All other control settings to remain as in paragraph 5-13. Pulse width of displayed period should be less than 30%.

b. Turn SYMMETRY control of 211B fully cw. Pulse width of period should be more than 70%.

5-15. TRIGGER OUTPUT CHECK.

5-16. This procedure verifies trigger output characteristics of the Model 211B. Connect equipment as shown in figure 5-6.

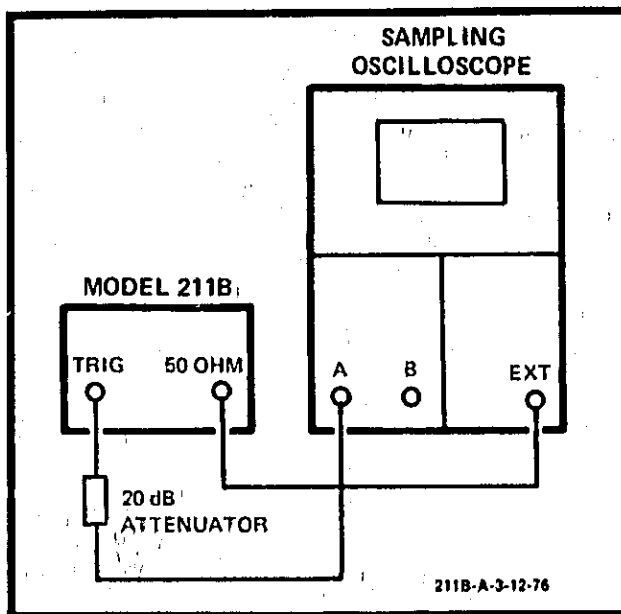

Figure 5-6. Trigger Output Test Setup

- a. Set 211B controls as follows:
 - MULTIPLIER 1M
 - FREQUENCY (Hz) 5
 - AMPLITUDE (switch) 5
 - VERNIER cw
 - TRIGGER POLARITY (-)
- b. Set sampling oscilloscope controls as follows:
 - TIME/DIV 20 nSEC
 - MAIN SWEEP MAGNIFIER 2
 - MILLIVOLTS/DIV 50
- c. Move trigger pulse to center of CRT. Pulse amplitude should be 2 volts or more (4 divisions).
- d. Adjust sampling oscilloscope plug-in unit VERNIER for full-screen display (10 divisions). Observe pulse width at 50% amplitude points. Pulse width should be approximately 10 ns (1 division).
- e. Change 211B TRIGGER POLARITY switch to (+). Pulse should be positive with same specifications as in steps c and d above.

5-17. ADJUSTMENTS.

5-18. The Model 211B contains a number of selected components which are factory installed. Selected components are indicated in the Parts List (refer to Section VI) and on the schematics by (*). Table 5-3 lists the selected components, description, ranges and the reason and method of selection. If a unit cannot be adjusted to meet the performance tests after repair and/or component replacement, check table 5-2 for possible replacement of a select component.

5-19. The following are factory adjustments and do not normally need readjusting. After instrument repair and/or component replacement, accomplish the performance checks as outlined in paragraphs 5-5 through 5-16. If an instrument does not meet the performance checks, proceed with the following adjustments. These adjustments must be performed in the sequence given below. See figure 5-7 for locations of adjustments.

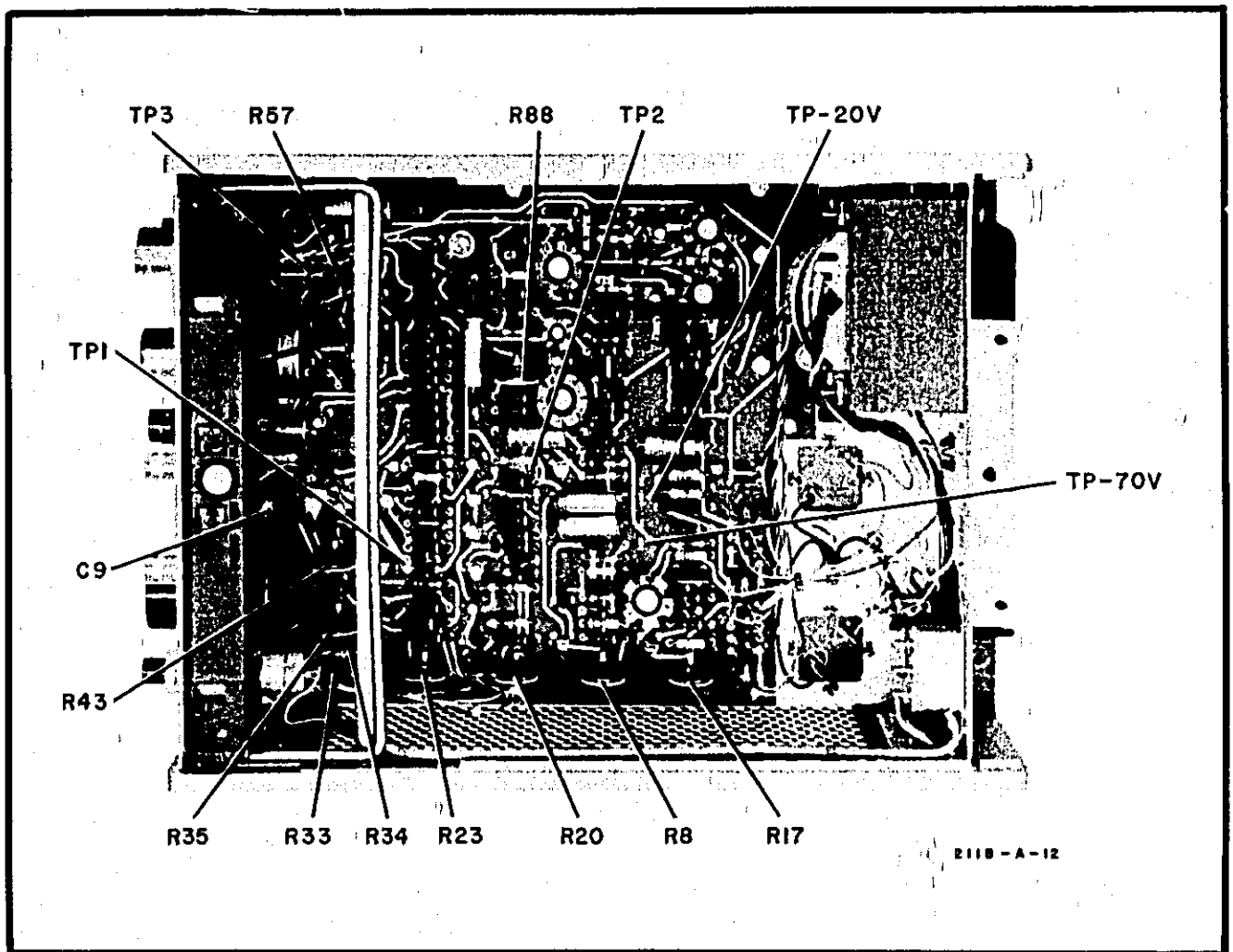

Figure 5-7. Component Adjustment Location

Table 5-2. Factory Selected Components

Ref. Desig.	Description	Reason and Method of Selection
A2C29	C: fxd. 22pF C: fxd. 24pF C: fxd. 27pF C: fxd. 30pF C: fxd. 33pF C: fxd. 36pF C: fxd. 39pF	Typical 22 pF. Selected to optimize output pulse shape. Selected with A2R84 (see elsewhere in this table).
A2R9	R: fxd. 1300 ohms	Typical 1300 ohms: -20 V adjust is critical because of high Temp coef of R8, and its resistance must be kept low. R9 is also selectable because of VR2.
A2R18 & A2R48	R: fxd. 2400 ohms R: fxd. 2700 ohms R: fxd. 3000 ohms R: fxd. 3300 ohms R: fxd. 3600 ohms	R18 typical 2400 ohms: -70 V adjust is critical because of high Temp coef of R17, and its resistance must be kept low. R18 is also selected because of VR4. R48 typical 3300 ohms: Selected for small freq. change with Symmetry. Set Freq to 10 MHz. Turn Symmetry control cw to ccw. Monitor freq with counter. Freq should change less than ±5%.
A2R19	R: fxd. 560 ohms	Typical 560 ohms: Adjusts the mechanical potentiometer path of R2 to correspond with frequency dial.
A2R31	R: fxd. 46 ohms R: fxd. 51 ohms R: fxd. 56 ohms R: fxd. 62 ohms	Typical 56 ohms: Adjust for correct freq. Set Mult. Sw. to 1 MHz. Set Freq dial to 1. Adjust C9 for 1 MHz. Set Freq dial to 10. Select R31 for 10 MHz. Recheck C9 setting.
A2R32	R: fxd. 12 ohms Range 6 ohms to 18 ohms	Typical 12 ohms: Selected to meet freq specs on the 100K range.
A2R41	R: fxd. 91 kilohms R: fxd. 120 kilohms R: fxd. 150 kilohms R: fxd. 180 kilohms R: fxd. 200 kilohms R: fxd. 220 kilohms	Typical 150 kilohms: Selected for small freq change with Symmetry. Set Mult. sw. to 10K. Set Freq dial to 1. Turn Symmetry control for 50% duty cycle. Monitor freq with counter. Frequency should not change more than ±3% when turning Symmetry control fully cw or fully ccw from 50% point.
A2R84	R: fxd. 22 ohms R: fxd. 27 ohms R: fxd. 30 ohms R: fxd. 39 ohms R: fxd. 47 ohms R: fxd. 82 ohms R: fxd. 160 ohms	Typical 82 ohms: Selected to optimize output pulse shape. Selected with A2C29.

5-20. POWER SUPPLY ADJUSTMENT.

a. Use a digital voltmeter to make the following measurements and adjustments.

b. **-20 V SUPPLY.** Measure from test point TP-20V on board assembly A2 to chassis. Adjust potentiometer A2R8 to obtain -20 volts. Vary the line voltage $\pm 10\%$ about the nominal input voltage. The -20 volts should not change more than ± 200 millivolts.

c. **-70 V SUPPLY.** Measure from test point TP-70V on board assembly A2 to chassis. Adjust potentiometer A2R17 to obtain -70 volts. Vary line voltage $\pm 10\%$ about the nominal input voltage. The -70 volts should not change more than ± 700 millivolts.

5-21. FREQUENCY ADJUSTMENT.

a. Connect equipment as shown in figure 5-2, and connect the frequency counter to 211B TRIGGER OUTPUT.

b. Set Model 211B controls as follows:

MULTIPLIER 10K
 FREQUENCY (Hz) 1
 SYMMETRY approximately 50%
 AMPLITUDE (switch) 5
 VERNIER cw

c. Set high-frequency oscilloscope controls as follows:

TIME/DIV1 mSEC
 TRIGGER INT
 MODE NORM
 VOLTS/DIV (channel A) 2
 POLARITY (+) UP
 COUPLING DC
 VOLTS/DIV (channel B)05
 COUPLING AC

d. Measure amplitude of the triangular waveform with oscilloscope test probe at test point TP1 (located on board assembly A2). Adjust amplitude of waveform with A2R43 for 1.8 volts. Remove probe.

e. Set frequency counter controls as follows:

SIGNAL INPUT AC
 SENSITIVITY (VOLTS RMS)1 V
 TIME BASE1 sec
 FUNCTION FREQUENCY

f. Set 211B FREQUENCY (Hz) dial to 10 and adjust A2R23 for 100 kHz $\pm 1\%$ as indicated on frequency counter.

g. Set FREQUENCY (Hz) dial to 1 and adjust A2R20 for 10 kHz $\pm 1\%$ as indicated on frequency counter.

h. Repeat steps (f) and (g) above if necessary, until both requirements are met.

i. Set FREQUENCY (Hz) dial to 1 and MULTIPLIER switch to 1M. Adjust capacitor A2C9 for 1 MHz $\pm 1\%$ as indicated on frequency counter.

j. Set FREQUENCY (Hz) dial to 10. Frequency should be 10 MHz $\pm 4\%$. If difficulty is encountered, check A2R31 (refer to table 5-3).

k. Set frequency counter controls as follows:

SIGNAL INPUT AC
 SENSITIVITY (VOLTS RMS) 1 V
 TIME BASE 0.1 μ sec
 FUNCTION 1 period average

l. Set 211B MULTIPLIER switch to 100 and FREQUENCY (Hz) dial to 10.

WARNING

Potentiometers A2R33, A2R34, and A2R35 are directly beneath the LINE switch (S1). Extreme care should be taken when adjusting these resistors to avoid shock.

m. Adjust A2R35 for 983 μ sec as indicated on frequency counter.

n. Set 211B MULTIPLIER switch to 10 and adjust A2R34 for 9830 μ sec as indicated on frequency counter.

o. Set MULTIPLIER switch to 1 and adjust A2R33 for 98300 μ sec as indicated on frequency counter.

p. Set 211B FREQUENCY (Hz) dial to 1 and check the 1, 10, and 100 MULTIPLIER ranges. Time change should be less than $\pm 5\%$ on each range.

5-22. SYNCHRONIZATION ADJUSTMENT.

a. Measure voltage at test point TP3 on board assembly A2 with digital voltmeter. Adjust A2R57 for indication of 0 volt dc.

5-23. PULSE AMPLITUDE 600-OHM OUTPUT ADJUSTMENT.

a. Connect equipment as shown in figure 5-4.

b. Set 211B MULTIPLIER switch to 10K, FREQUENCY (Hz) dial to 10, SYMMETRY control to 50% duty cycle, and AMPLITUDE control (600-ohm) fully clockwise. Adjust A2R88 for greatest amplitude without distortion on fall time.

**PERFORMANCE CHECK RECORD
MODEL 211B**

Serial Number _____

Date _____

Paragraph Reference	Check	Reference Standard	
		Required	Actual
5-8	Symmetry Control Check		
	Duty Cycle Symmetry - CW	>75%	_____
	Duty Cycle Symmetry - CCW	<25%	_____
5-9	Synchronization Check		
	180° Phase shift - CW	50% duty cycle	_____
	180° Phase shift - CCW	50% duty cycle	_____
5-10	600-ohm Output		
	600-ohm output Voltage - no load	>60 V	_____
	600-ohm output Voltage - load	>30 V	_____
5-11	Rise time and Fall time 600-ohm output		
	Rise time (no load)	<140 ns	_____
	Fall time (no load)	<140 ns	_____
	Rise time (load)	<70 ns	_____
	Fall time (load)	<70 ns	_____
5-12	50-ohm Output Check		
	Rise time (load)	<5 ns	_____
	Fall time (load)	<5 ns	_____
5-13	Symmetry - 10 MHz		
	Symmetry Control - ccw	Duty Cycle <30%	_____
	Symmetry Control - cw	Duty Cycle >70%	_____
5-14	Trigger Output Check		
	Amplitude (—) pulse	>2 volts	_____
	Pulse width —50% amplitude	10 ns	_____
	Amplitude (+) pulse	>2 volts	_____
	Pulse width —50% amplitude	10 ns Ref.	_____

SECTION VI REPLACEABLE PARTS

6-1. INTRODUCTION.

6-2. This section contains information for ordering replacement parts. Reference designators and abbreviations are defined in table 6-1, and table 6-2 lists the parts in alphanumeric order by reference designation. Parts identification photographs are in Section VIII.

6-3. ORDERING INFORMATION.

6-4. To order a part listed in the replaceable parts table, quote the Hewlett-Packard part number, indicate the quantity required, and address the order to the nearest Hewlett-Packard office.

6-5. To order a part that is not listed in the replaceable parts table, include the instrument model number, instrument serial number, the description and function of the part, and the number of parts required. Address the order to the nearest Hewlett-Packard office.

6-6. DIRECT MAIL ORDER SYSTEM.

6-7. Within the USA, Hewlett-Packard can supply parts through a direct mail order system. Advantages of using the system are as follows:

a. Direct ordering and shipment from the HP Parts Center in Mountain View, California.

b. No maximum or minimum on any mail order (there is a minimum order amount for parts ordered through a local HP office when the orders require billing and invoicing).

c. Prepaid transportation (there is a small handling charge for each order).

d. No invoices - to provide these advantages, a check or money order must accompany each order.

6-8. Mail order forms and specific ordering information is available through your local HP office. Addresses and phone numbers are located at the back of this manual.

Table 6-1. Reference Designators and Abbreviations

REFERENCE DESIGNATORS					
<p>A = assembly AT = attenuator, resistive termination B = motor, fan C = capacitor CP = coupling CR = diode DL = delay line DS = device signaling (lamp)</p>	<p>E = misc. electronic part F = fuse FL = filter H = hardware IC = integrated circuit J = jack K = relay L = inductor LS = speaker</p>	<p>M = meter MP = mechanical part P = plug PS = power supply Q = transistor R = resistor RT = thermistor S = switch T = transformer</p>	<p>TB = terminal board TP = test point U = microcircuit (non-repairable) V = vacuum tube, neon bulb, phototell., etc. VR = voltage regulator, (diode) W = cable X = socket Y = crystal</p>		
ABBREVIATIONS					
<p>A = ampere(s) ampl = amplifier(s) assy = assembly bd = board(s) bp = bandpass c = centi (10⁻²) car. = carbon ccw = counterclockwise cer = ceramic coax. = coaxial coef = coefficient com = common comp = composition conn = connector(s) CRT = cathode-ray tube cw = clockwise d = deci (10⁻¹) depc = deposited carbon dp = double pole dt = double throw elect. = electrolytic encap = encapsulated ext = external F = farad(s) fet = field-effect transistor(s) fixd = fixed</p>	<p>Ge = germanium G = giga (10⁹) gl = glass grd = ground(ed) H = henry(ies) Hg = mercury hr = hour(s) HP = Hewlett-Packard Hz = hertz I. = intermediate freq impreg = impregnated incand = incandescent incl = include(s) ins = insulation(ed) int = internal k = kilo (10³) lb = pound(s) lev = lever lin = linear taper log. = logarithmic taper lpf = low-pass filter(s) m = milli (10⁻³) M = mega (10⁶) metflm = metal film metox = metal oxide</p>	<p>minat = miniature mom. = momentary mtg = mounting my. = mylar n = nano (10⁻⁹) n/c = normally closed Ne = neon n/o = normally open npo = negative positive zero (zero temperature coefficient) nsr = not separately replaceable ord = order by description ox = oxide p = pico (10⁻¹²) pc = printed (etched) circuit(s) PGM = program piv = peak inverse voltage(s) p/o = part of poly = polystyrene porc = porcelain pos = position(s) pot. = potentiometer(s) pk-pk = peak-to-peak rect = rectifier(s) rf = radio frequency</p>	<p>s-b = slow-blow Se = selenium sect = section(s) semicon = semiconductor(s) Si = silicon sil = silver sl = slide sp = single pole spl = special st = single throw std = standard Ta = tantalum td = time delay TD = tunnel diode(s) tgl = toggle Ti = titanium tol = tolerance trim. = trimmer u = micro (10⁻⁶) v = volt(s) var = variable W = watt(s) w/ = with w/o = without wVdc = dc working volt(s) ww = wirewound</p>		

Table 6-2. Replaceable Parts

Ref Desig	HP Part No.	TQ	Description (Refer to Table 6-1.)
CHASSIS			
C1	0180-0047	1	C: fxd elect. 500 uF 75 wVdc
C2	0180-0214	1	C: fxd elect. 275 uF -10%+50% 200 wVdc
C3	0150-0093	7	C: fxd cer 0.01 uF +80%-20% 100 wVdc
DS1	2140-0244	1	DS:p/o S1 neon
E1	1200-0081	4	E:bushing, transistor
E2	0340-0858	2	E: Insulator Q
F1	2110-0008	1	F: cart, s-b 1/2A 125V
	2110-0018	1	F: cart, s-b 1/4A (230V operation)
H1	5040-0700	2	H: hinge
H2	0360-0042	2	H:lug, solder
J1		1	Consists of:
J1MP1	1251-4069	3	Contact: connector, ac power
J1MP2	1251-4070	1	Connector: housing, ac power
J2	1250-0083	3	J: conn BNC
J3	1250-0083		J: conn BNC
J4	1250-0140	1	J: conn BNC
J5	1250-0083		J: conn BNC
MP1	1200-0063	20	MP: clip, transistor Q3 and Q4
MP2	5000-8583	1	MP: cover, bottom
MP3	5000-8479	2	MP: cover, side, perforated
MP4	5060-8573	1	MP: cover top
MP5	01701-04109	1	MP: cover, transformer T1
MP6	3130-0038	1	MP: coupler, switch, .045 diam
MP7	1205-0008	2	MP: dissipator, heat, Q3 and Q4
MP8	00211-64001	1	MP: knob assy
MP9	0370-0077	1	MP: knob, blk w/arrow (Ampl 50-ohm)
MP10	0370-0084	2	MP: knob, blk w/arrow (Ampl 600-ohm; Vernier)
MP11	0370-0099	1	MP: knob, round (Multiplier)
MP12	0370-0134	1	MP: knob, red (Symmetry)
MP13	1205-0007	2	MP: nut, dissipator, heat, Q3 and Q4
MP14			Deleted
MP15	1490-0032	1	MP: stand. tilt
MP16	00211-10202	1	MP: panel, rear
MP17	5060-0703	2	MP: side casting
MP18	00211-10201	1	MP: panel, front
MP19	5060-0728	2	Foot assy: half module
MP20	5951-1125	1	Label: serial
MP21	7120-1254	1	Identification plate
MP22	7124-2083	1	Label: warning
MP23	00211-00101	1	Deck: main
MP24	00211-01101	2	Heat sink
Q1	1850-0098	2	Q: ge pnp
Q2	1850-0098		Q: ge pnp
Q3	1854-0711	2	Q: si npn
Q4	1854-0711		Q: si npn

Table 6-2. Replaceable Parts (Cont'd)

Ref Desig	HP Part No.	TQ	Description (Refer to Table 6-1.)
CHASSIS (Cont'd)			
R1	0757-0092	1	R: fxd metox 33 kilohms 2% 1/2W
R2	2100-0535	1	R: var 10 kilohms 10% 2W
R3	2100-0519	1	R: var 2 x 1000 ohms 3%
R4	2100-0036	1	R: var 1000 ohms 20% 1/2W
R5	0683-2035	1	R: fxd comp 20 kilohms 5% 1/4W
R6	2100-0076	1	R: var 2 x 1200 ohms 10%
S1	3101-1957	1	S: push, DPST 10.5A 250 vac
S2	3101-1234	1	S: slide, DPDT
S3		1	S: p/o S5
S4	3101-0011	1	S: slide, non-shorting, .5A, 125V
S5	3100-0507	1	S: rotary
T1	9100-0517	1	T: transformer, power
W1	8120-1378	1	W: cable assy, input power
W2	00211-61608	1	W: cable assy, 115V/230V switch connections
XF1	1400-0084	1	XF: extractor, post-type
A1			
A1	00211-63401	1	A: attenuator assy
A1R1	0757-0172	1	R: fxd metflm 37.4 ohms 1% 1/2W
A1R2	0757-0301	2	R: fxd metflm 150 ohms 1% 1/2W
A1R3	0757-0801		R: fxd metflm 150 ohms 1% 1/2W
A1R4	0757-0069	1	R: fxd metflm 121 ohms 1% 1/4W
A1R5	0757-0795	2	R: fxd metflm 75 ohms 1% 1/2W
A1R6	0757-0795		R: fxd metflm 75 ohms 1% 1/2W
A1R7	0757-0071	1	R: fxd metflm 247.5 ohms 1% 1/4W
A1R8	0757-1005	2	R: fxd inetflm 61.11 ohms 1/4% 1/2W
A1R9	0757-1005		R: fxd metflm 61.11 ohms 1/4% 1/2W
A1S1		1	S: switch NSR part of A1 assembly
A1W1	00211-61606	1	W: cable assembly input
A1W2	00211-61607	1	W: cable assembly output
A2			
A2	00211-66501	1	A: printed circuit board
A2C1	0180-0049	3	C: fxd alum 20 uF -10+75% 50 wVdc
A2C2	0180-0049		C: fxd alum 20 uF -10+75% 50 wVdc
A2C3	0180-0291	9	C: fxd Ta 1 uF 10% 35 wVdc
A2C4	0150-0121	1	C: fxd cer 0.1 uF -20%+80% 50 wVdc
A2C5	0180-0049		C: fxd alum 20 uF -10+75% 50 wVdc
A2C6	0150-0096	1	C: fxd cer 0.05 uF 20% 100 wVdc
A2C7	0180-0291		C: fxd Ta 1 uF 10% 35 wVdc
A2C8	0140-0194	1	C: fxd mica 110 pF 5% 300 wVdc
A2C9	0121-0046	1	C: var cer 9-35 pF
A2C10	0140-0147	1	C: fxd mica 180 pF 5% 500 wVdc
A2C11	0180-2207	1	C: fxd Ta 100 uF 10% 10 wVdc
A2C12	0180-0374	1	C: fxd Ta 10 uF 10% 20 wVdc
A2C13	0180-0291	1	C: fxd Ta 1 uF 10% 35 wVdc

Table 6-2. Replaceable Parts (Cont'd)

Ref Desig	HP Part No.	TQ	Description (Refer to Table 6-1.)
A2 (Cont'd)			
NOTE: (*) indicates selected value.			
A2C14	0160-0503	1	C: fxd polycarb 0.22 uF 2% 100 wVdc
A2C15	0160-0504	1	C: fxd polycarb .022 uF 1% 100 wVdc
A2C16	0140-0180	1	C: fxd mica 2000 pF 2% 300 wVdc
A2C17	0150-0093		C: fxd cer 0.01 uF -20%+80% 100 wVdc
A2C18	0150-0073	1	C: fxd cer 100 pF 10% 1000 wVdc
A2C19	0150-0071	1	C: fxd cer 400 pF 5% 500 wVdc
A2C20	0180-0291		C: fxd Ta 1 uF 10% 35 wVdc
A2C21	0180-0291		C: fxd Ta 1 uF 10% 35 wVdc
A2C22	0180-0094	2	C: fxd alum 100 uF -10+75% 25 wVdc
A2C23	0180-0094		C: fxd alum 100 uF -10+75% 25 wVdc
A2C24	0150-0093		C: fxd cer 0.01 uF -20%+80% 100 wVdc
A2C25	0180-0291		C: fxd Ta 1 uF 10% 35 wVdc
A2C26	0140-0201	1	C: fxd mica 12 pF 5% 500 wVdc
A2C27	0160-2261	1	C: fxd cer 15 pF 5% 500 wVdc
A2C28	0150-0093		C: fxd cer 0.01 uF -20%+80% 100 wVdc
A2C29*	0140-0145	1	C: fxd mica 22 pF 5% 500 wVdc
A2C30	0180-0291		C: fxd Ta 1 uF 10% 35 wVdc
A2C31	0180-0291		C: fxd Ta 1 uF 10% 35 wVdc
A2C32	0180-0291		C: fxd Ta 1 uF 10% 35 wVdc
A2C33	0150-0093		C: fxd cer 0.01 uF -20%+80% 100 wVdc
A2C34	0150-0093		C: fxd cer 0.01 uF -20%+80% 100 wVdc
A2C35	0180-0091	1	C: fxd alum 10 uF -10%+50% 100 wVdc
A2C36	0150-0079	2	C: fxd cer 3300 pF 10% 500 wVdc
A2C37	0150-0079		C: fxd cer 3300 pF 10% 500 wVdc
A2C38	0150-0093		C: fxd cer 0.01 uF -20%+80% 100 wVdc
A2CR1	1901-0158	4	CR: si
A2CR2	1901-0158		CR: si
A2CR3	1901-0158		CR: si
A2CR4	1901-0158		CR: si
A2CR5	1901-0029	4	CR: si
A2CR6	1901-0029		CR: si
A2CR7	1901-0029		CR: si
A2CR8	1901-0029		CR: si
A2CR9	1901-0025	2	CR: si
A2CR10	1901-0025		CR: si
A2CR11	1901-0040	6	CR: si
A2CR12	1901-0040		CR: si
A2CR13	1910-0016	4	CR: ge
A2CR14	1910-0016		CR: ge
A2CR15	1910-0016		CR: ge
A2CR16	1910-0016		CR: ge
A2CR17	1901-0040		CR: si
A2CR18	1901-0040		CR: si
A2CR19	1901-0040		CR: si

Table 6-2. Replaceable Parts (Cont'd)

Ref. Desig	HP Part No.	TQ	Description (Refer to Table 6-1.)
A2 (Cont'd)			
A2CR20	1901-0040		CR: si
A2CR21	1901-0050	1	CR: si
A2L1	9140-0111	1	L: fxd rf 3.3 uH
A2L2	9170-0016	7	L: bead, ferrite
A2L3	9140-0096	1	L: fxd rf 1 uH
A2L4	9170-0016		L: bead, ferrite
A2L5	9170-0016		L: bead, ferrite
A2L6	9170-0016		L: bead, ferrite
A2L7	9170-0016		L: bead, ferrite
A2L8	9170-0016		L: bead, ferrite
A2L9	9170-0016		L: bead, ferrite
A2Q1	1853-0129	4	Q: si npn
A2Q2	1853-0029		Q: si npn
A2Q3	1853-0001	2	Q: si npn
A2Q4	1853-0029		Q: si npn
A2Q5	1854-0071	3	Q: si npn
A2Q6	1854-0019	8	Q: si npn
A2Q7	1853-0009	5	Q: si npn
A2Q8	1854-0019		Q: si npn
A2Q9	1853-0009		Q: si npn
A2Q10	1853-0029		Q: si npn
A2Q11	1854-0071		Q: si npn
A2Q12	1854-0019		Q: si npn
A2Q13	1854-0019		Q: si npn
A2Q14	1854-0009	2	Q: si npn 2N709
A2Q15	1854-0009		Q: si npn 2N709
A2Q16	1854-0005	4	Q: si npn 2N708
A2Q17	1854-0005		Q: si npn 2N708
A2Q18	1853-0009		Q: si npn
A1Q19	1854-0005		Q: si npn 2N708
A2Q20	1854-0005		Q: si npn 2N708
A2Q21	1854-0019		Q: si npn
A2Q22	1854-0019		Q: si npn
A2Q23	1853-0009		Q: si npn
A2Q24	1853-0009		Q: si npn
A2Q25	1854-0019		Q: si npn
A2Q26	1853-0012	1	Q: si npn 2N2904A
A2Q27	1854-0071		Q: si npn
A2Q28	1853-0001		Q: si npn
A2Q29	1854-0267	2	Q: si npn
A2Q30	1854-0267		Q: si npn
A2Q31	1854-0019		Q: si npn
A2Q32	1854-0091	2	Q: si npn
A2Q33	1854-0091		Q: si npn
A2R1	0758-0003	8	R: fxd metfilm 1000 ohms 5% 1/4W

Table 6-2. Replaceable Parts (Cont'd)

Ref Desig	HP Part No.	TQ	Description (Refer to Table 6-1.)
A2 (Cont'd)			
NOTE: (*) indicates selected value.			
A2R2	0757-0080	3	R: fxd metflm 4700 ohms 2% 1/4W
A2R3	0758-0003		R: fxd metflm 1000 ohms 5% 1/4W
A2R4	0813-0050	2	R: fxd ww 100 ohms 5% 3W
A2R5	0813-0050		R: fxd ww 100 ohms 5% 3W
A2R6	0758-0004	1	R: fxd metflm 2700 ohms 5% 1/4W
A2R7	0758-0034	2	R: fxd metflm 2400 ohms 5% 1/4W
A2R8	2100-0520	5	R: var 250 ohms 20% lin 0.15W
A2R9*	0758-0042	1	R: fxd metflm 1300 ohms 5% 1/4W
A2R10	0761-0005	1	R: fxd metox 2200 ohms 5% 1W
A2R11	0812-0012	1	R: fxd ww 18 ohms 5% 3W
A2R12	0758-0048	1	R: fxd metflm 8200 ohms 5% 1/4W
A2R13	0758-0008	3	R: fxd metflm 390 ohms 5% 1/4W
A2R14	0758-0028	5	R: fxd metflm 270 ohms 5% 1/4W
A2R15	0758-0006	3	R: fxd metflm 10 kilohms 5% 1/4W
A2R16	0757-0080		R: fxd metflm 4700 ohms 2% 1/4W
A2R17	2100-0520		R: var 250 ohms 20% lin 0.15W
A2R18*	0758-0034		R: fxd metflm 2400 ohms 5% 1/4W
A2R19*	0757-0076	3	R: fxd flm 560 ohm 2% 1/4W
A2R20	2100-0520		R: var 250 ohms 20% lin 0.15W
A2R21	0683-1025	2	R: fxd carflm 1000 ohms 5% 1/4W
A2R22	0758-0018	1	R: fxd metflm 15 kilohms 5% 1/4W
A2R23	2100-0521	5	R: var comp 5000 ohms 20% lin 0.15W
A2R24	0757-0159	2	R: fxd metflm 1000 ohms 1% 1/2W
A2R25	0757-0159		R: fxd metflm 1000 ohms 1% 1/2W
A2R26	0758-0028		R: fxd metflm 270 ohms 5% 1/4W
A2R27	0758-0028		R: fxd metflm 270 ohms 5% 1/4W
A2R28	0758-0028		R: fxd metflm 270 ohms 5% 1/4W
A2R29	0758-0028		R: fxd metflm 270 ohms 5% 1/4W
A2R30	0758-0035	3	R: fxd metflm 3000 ohms 5% 1/4W
A2R31*	0758-0094	1	R: fxd metflm 62 ohms 5% 1/4W
A2R32*	0683-1205	1	R: fxd comp 12 ohms 5% 1/4W
A2R33	2100-0521		R: var comp 5000 ohms 20% lin 0.15W
A2R34	2100-0521		R: var comp 5000 ohms 20% lin 0.15W
A2R35	2100-0521		R: var comp 5000 ohms 20% lin 0.15W
A2R36	0758-0007	3	R: fxd metflm 150 ohms 5% 1/4W
A2R37	0758-0044	3	R: fxd metflm 2200 ohms 5% 1/4W
A2R38	0761-0057	1	R: fxd metox 560 ohm 5% 1W
A2R39	0758-0071	1	R: fxd metflm 4300 ohms 5% 1/4W
A2R40	0758-0057	1	R: fxd metflm 5600 ohms 5% 1/4W
A2R41*	0757-0779	1	R: fxd metflm 150 kilohms 1% 1/4W
A2R42	0758-0008		R: fxd metflm 390 ohms 5% 1/4W
A2R43	2100-0520		R: var 250 ohms 20% lin 0.15W
A2R44	0757-0074	1	R: fxd metflm 430 ohms 2% 1/4W
A2R45	0757-0714	1	R: fxd metflm 130 ohms 1% 1/4W
A2R46	0698-5886	1	R: fxd metflm 27 ohms 5% 1/4W

Table 6-2. Replaceable Parts (Cont'd)

Ref Desig	HP Part No.	TQ	Description (Refer to Table 6-1.)
A2 (Cont'd)			
NOTE: (*) indicates selected value.			
A2R47	0757-0712	1	R: fxd metflm 90.9 ohms 1% 1/4W
A2R48*	0758-0035	1	R: fxd metflm 3000 ohms 5% 1/4W
A2R49	0757-0076	1	R: fxd flm 560 ohms 2% 1/4W
A2R50	0758-0007	3	R: fxd metflm 150 ohms 5% 1/4W
A2R51	0757-0080	1	R: fxd metflm 4700 ohms 2% 1/4W
A2R52	0757-0500	3	R: fxd metflm 30.1 ohms 1% 1/4W
A2R53	0757-0086	2	R: fxd metflm 51 ohms 2% 1/4W
A2R54	0757-0086	1	R: fxd metflm 51 ohms 2% 1/4W
A2R55	0757-0731	1	R: fxd metflm 825 ohms 1% 1/4W
A2R56	0758-0006	1	R: fxd metflm 10 kilohms 5% 1/4W
A2R57	2100-0521	1	R: var comp 5000 ohms 20% lin 0.15W
A2R58	0758-0010	1	R: fxd metflm 3300 ohms 5% 1/4W
A2R59	0757-0756	1	R: fxd metflm 13 kilohms 1% 1/4W
A2R60	0758-0043	2	R: fxd metflm 1800 ohms 5% 1/4W
A2R61	0758-0045	1	R: fxd metflm 3900 ohms 5% 1/4W
A2R62	0698-5884	2	R: fxd metflm 22 ohms 5% 1/4W
A2R63	0757-0076	1	R: fxd flm 560 ohms 2% 1/4W
A2R64	0758-0003	1	R: fxd metflm 1000 ohms 5% 1/4W
A2R65	0683-2225	1	R: fxd carflm 2200 ohms 5% 1/4W
A2R66	0758-0003	1	R: fxd metflm 1000 ohms 5% 1/4W
A2R67	0757-0500	1	R: fxd metflm 30.1 ohms 1% 1/4W
A2R68	0758-0003	1	R: fxd metflm 1000 ohms 5% 1/4W
A2R69	0757-0500	1	R: fxd metflm 30.1 ohms 1% 1/4W
A2R70	0758-0024	1	R: fxd metflm 100 ohms 5% 1/4W
A2R71	0758-0035	1	R: fxd metflm 3000 ohms 5% 1/4W
A2R72	0758-0008	1	R: fxd metflm 390 ohms 5% 1/4W
A2R73	0758-0043	1	R: fxd metflm 1800 ohms 5% 1/4W
A2R74	0758-0003	1	R: fxd metflm 1000 ohms 5% 1/4W
A2R75*	0758-0066	1	R: fxd metflm 620 ohms 5% 1/4W
A2R76	0758-0044	1	R: fxd metflm 2200 ohms 5% 1/4W
A2R77	0758-0003	1	R: fxd metflm 1000 ohms 5% 1/4W
A2R78	0683-1025	1	R: fxd carflm 1000 ohms 5% 1/4W
A2R79	0758-0096	1	R: fxd metflm 110 ohms 5% 1/4W
A2R80	0757-0069	1	R: fxd metflm 121 ohms 1% 1/4W
A2R81	0758-0044	1	R: fxd metflm 2200 ohms 5% 1/4W
A2R82	0761-0041	2	R: fxd metox 56 ohms 5% 1W
A2R83	0761-0041	1	R: fxd metox 56 ohms 5% 1W
A2R84*	0698-5884	1	R: fxd flm 22 ohms 5% 1/4W
A2R85	0757-0198	2	R: fxd metflm 100 ohms 1% 1/2W
A2R86	0757-0198	1	R: fxd metflm 100 ohms 1% 1/2W
A2R87	0757-0719	1	R: fxd metflm 221 ohms 1% 1/4W
A2R88	2100-0520	1	R: var 250 ohms 20% lin 0.15W
A2R89	0758-0003	1	R: fxd metflm 1000 ohms 5% 1/4W
A2R90	0758-0073	1	R: fxd metflm 24 kilohms 5% 1/4W
A2R91	0758-0006	1	R: fxd metflm 10 kilohms 5% 1/4W

Table 6-2. Replaceable Parts (Cont'd)

Ref Desig	HP Part No.	TQ	Description (Refer to Table 6-1.)
A2 (Cont'd)			
A2R92	0758-0031	1	R: fxd metflm 680 ohms 5% 1/4W
A2R93	0698-3397	1	R: fxd metflm metflm 42.2 ohms 1% 1/2W
A2R94	0698-5890	2	R: fxd metflm 39 ohms 5% 1/4W
A2R95	0698-5890		R: fxd metflm 39 ohms 5% 1/4W
A2R96	0758-0007		R: fxd metflm 150 ohms 5% 1/4W
A2R97	0811-1166	1	R: fxd ww 4300 ohms 3% 3W
A2RT1	0837-0502	1	RT: thermistor 130 ohms 20% 1/2W
A2RT2	0837-0501	1	RT: thermistor 50 ohms 20% 1W
A2VR1	1902-0048	3	CR: brkdwn 6.81V 5% 400 mW
A2VR2	1902-0048		CR: brkdwn 6.81V 5% 400 mW
A2VR3	1902-3256	2	CR: brkdwn 23.7V 5% 400 mW
A2VR4	1902-3256		CR: brkdwn 23.7V 5% 400 mW
A2VR5	1902-0074	1	CR: brkdwn 7.15V 5% 400 mW
A2VR6	1902-0048		CR: brkdwn 6.81V 5% 400 mW
A2VR7	1902-0188	1	CR: brkdwn 4.12V 5% 400 mW
A2VR8	1902-3125	1	CR: brkdwn 6.98V 2% 400 mW
A2VR9	1902-3105	1	CR: brkdwn 5.62V 2% 400 mW
A2VR10	1902-0173	1	CR: brkdwn 9.53V 5% 400 mW

SECTION VII MANUAL CHANGES

7-1. INTRODUCTION.

7-2. This section contains information required to backdate this manual for a specific instrument.

7-3. MANUAL CHANGES.

7-4. This manual applies directly to instruments having the same serial prefix shown on the manual title page. If the serial prefix of your instrument is not the same as the one on the title page, find your serial prefix in table 7-1 and make all changes to the manual that are listed for that serial prefix. When making changes listed in table 7-1, make the change with the highest number first. For example, if backdating changes 1, 2, and 3 are required for your serial prefix, do change 3 first, then change 2, and finally change 1. If the serial prefix of the instrument is not listed either on the title page or in table 7-1, refer to the enclosed MANUAL CHANGES sheet for updating information. Also, if a MANUAL CHANGES sheet is supplied, make all indicated ERRATA corrections.

Table 7-1. Manual Changes

Serial Prefix	Make Changes
0817A	4 thru 1
1210A	4 thru 2
1218A	4 and 3
1538A	4

CHANGE 1

Table 6-2,
MP2: Change to HP Part No. 5000-0717, MP: cover, bottom.

MP3: Change to HP Part No. 5000-0567, MP: cover, side, perforated.
MP4: Change to HP Part No. 5060-0718, MP: cover, top.
MP16: Change to HP Part No. 00211-00207, MP: panel, rear.
Delete: MP18.

CHANGE 2

Table 6-2,
S1: Change to HP Part No. 3101-0100, S: push, SPDT 5A, 125 V.

CHANGE 3



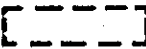









Table 6-2,
S1: Change to HP Part No. 3101-1248, S: push, SPDT illuminated.
W2: Change to HP Part No. 00211-61605, W: cable assy, 115 V/230 V switch connections.
Page 8-5, figure 8-8,
S1: Delete left-hand contacts of switch. Show wire colors (98) and (948) connected together and designated (98).





CHANGE 4

Page 2-1,
Delete: figure 2-1.
Table 6-2,
J1: Change to HP Part No. 1251-0148, J: conn ac power.
W1: Change to HP Part No. 8120-0078, W: cable assy, input power.

Table 8-1. Schematic Notes

Refer to MIL-STD-15-1A for schematic symbols not listed in this table.

-  = Etched circuit board
-  = Front panel marking
-  = Rear panel marking
-  = Front panel control
-  = Screwdriver adjustment
- P/O = Part of
- CW = Clockwise end of variable resistor
- N C = No connection
-  = Waveform test point (with number)
-  = Common electrical point (with letter) not necessarily ground
-  = Single pin connector on board
-  = Pin of a plug-in board (with letter or number)
-  = Main signal path
-  = Primary feedback path
-  = Secondary feedback path
- * = Optimum value selected at factory, average value shown; part may have been omitted.

-  = Field effect transistor (N-channel)
-  = Breakdown diode
-  = Tunnel diode
-  = Step recovery diode
-  = Circuits or components drawn with dashed lines (phantom) show function only and are not intended to be complete. The circuit or component is shown in detail on another schematic.

Unless otherwise indicated:
 resistance in ohms
 capacitance in picofarads
 inductance in microhenries

Wire colors are given by numbers in parentheses using the resistor color code [(925) is wht-red-grn].

0 - Black	5 - Green
1 - Brown	6 - Blue
2 - Red	7 - Violet
3 - Orange	8 - Gray
4 - Yellow	9 - White

Switch wafers are identified as follows:

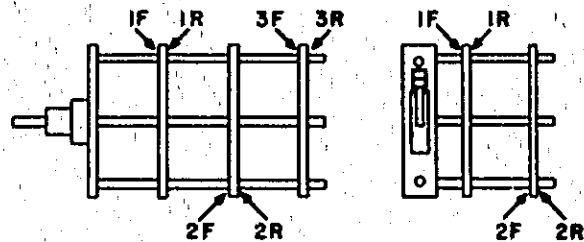

SECTION VIII

SCHEMATICS AND TROUBLESHOOTING

8-1. INTRODUCTION.

8-2. This section contains schematics, repair and replacement information, component identification illustrations and troubleshooting tips. Figures 8-1 through 8-4 provide a guide to locating common problems. Table 8-1 defines symbols and conventions used on the schematics.

8-3. COMPONENT IDENTIFICATION.

8-4. Locations of components on etched circuit boards are illustrated in photographs adjacent to the schematics. Since the schematics are drawn to show function, a particular circuit board assembly may be shown on several schematics. The component-identification photograph is located next to the schematic that shows most of the circuitry. Components located on the chassis are identified in figures 8-5 and 8-6.

8-5. REPAIR AND REPLACEMENT.

8-6. Most electrical components are accessible from the component side of the etched circuit board. Section VI provides a detailed parts list for use in ordering replacement parts.

8-7. The Model 211B has the plated-through type etched circuit boards. When servicing this type of board, components may be removed or replaced by unsoldering from either side of the board. HP Service Note M-201 contains additional information on the repair of etched circuit boards.

8-8. TROUBLESHOOTING.

8-9. The most important prerequisite for successful troubleshooting is an understanding of how the instrument is designed to operate and correct usage of front-panel controls. Often suspected malfunctions are caused by improper control settings. Operation Section III which provides an explanation of controls and connectors and general operating considerations, and Principles of Operation Section IV which explains circuit theory are intended to satisfy this information requirement.

8-10. After ensuring that the malfunction is not the result of improper control settings, proceed as follows:

a. Visually inspect instrument for loose or broken wires, charred or discolored components and any other indications of physical damage.

b. Use troubleshooting trees and waveform charts in conjunction with schematics to isolate the malfunctioning component.

8-11. **Frequency Control Network.** When the frequency control network fails to free-run, there are no waveforms to monitor, and the oscilloscope cannot be used as a troubleshooting instrument. The most effective method of troubleshooting the frequency control network in this condition is to determine which of the two states the Schmitt trigger is in and measure the dc voltages around the circuits. Table 8-2 lists the voltages of the frequency control circuits with the Schmitt trigger locked in one condition (either Q14 or Q15 emitter opened). When an erroneous voltage is located, basic troubleshooting procedures should be used to determine the exact cause.

8-12. **Dc Voltages.** Dc voltages are indicated on some of the schematics for active components (transistors, etc). Control test conditions for making the voltage measurements are listed adjacent to each schematic. Since the conditions for making these measurements may differ from one circuit to another, always check the specific conditions listed adjacent to the schematic.

8-13. **Waveforms and Test Points.** Typical waveform measurement points (∇ with a number enclosed) are placed on the schematics along main signal paths. The numbers inside the measurement point symbols (∇) are keyed to corresponding waveforms adjacent to each schematic. Test points are shown on the schematics with this symbol (TP \odot). Test points correspond to pins protruding from the etched circuit board and do not necessarily correspond to waveform measurement points.

8-14. Conditions for making the waveform measurements are listed adjacent to each schematic and like the dc voltage measurement conditions may vary slightly from one circuit to another.

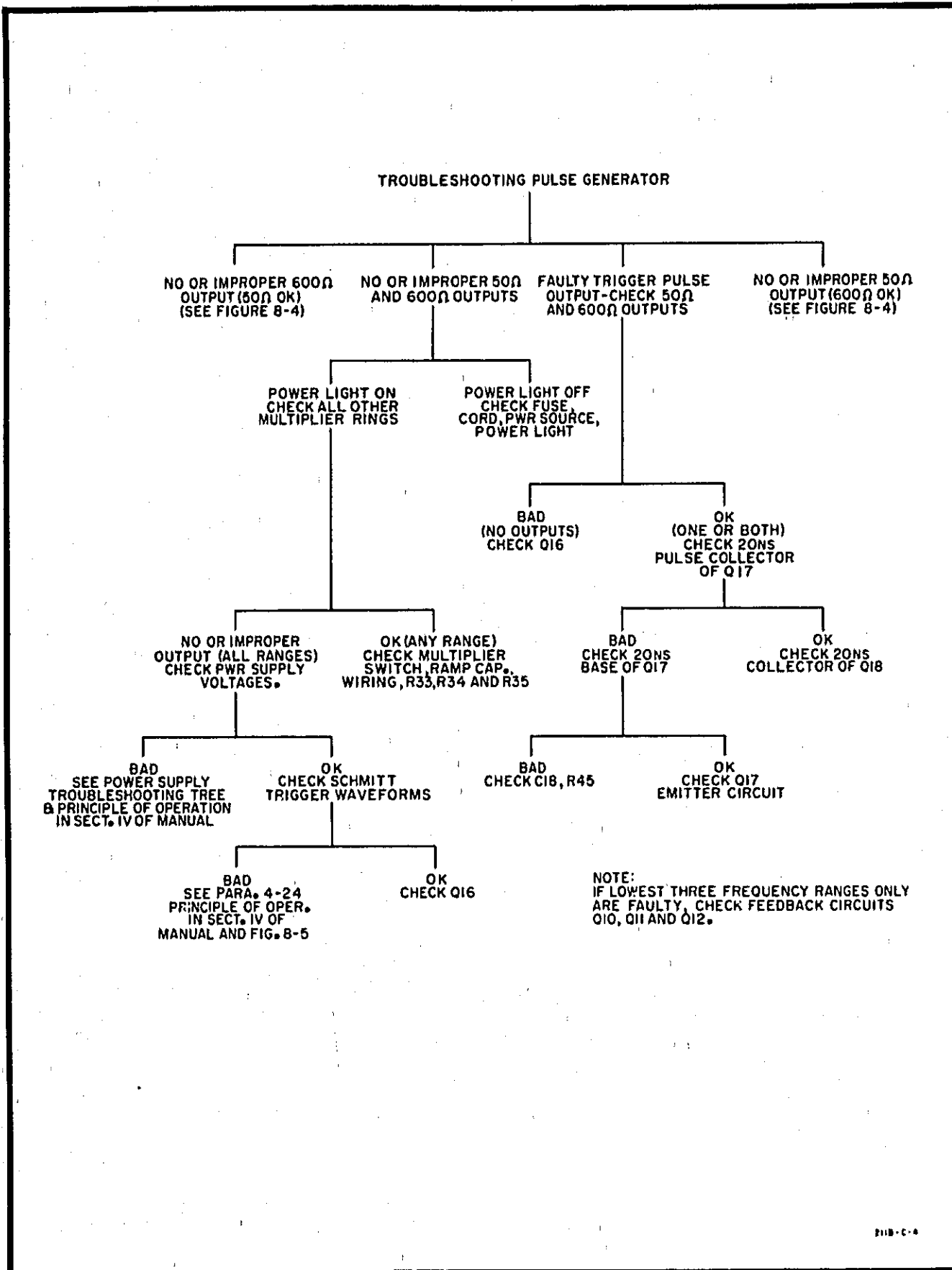

Figure 8-1. Pulse Generator Troubleshooting Tree

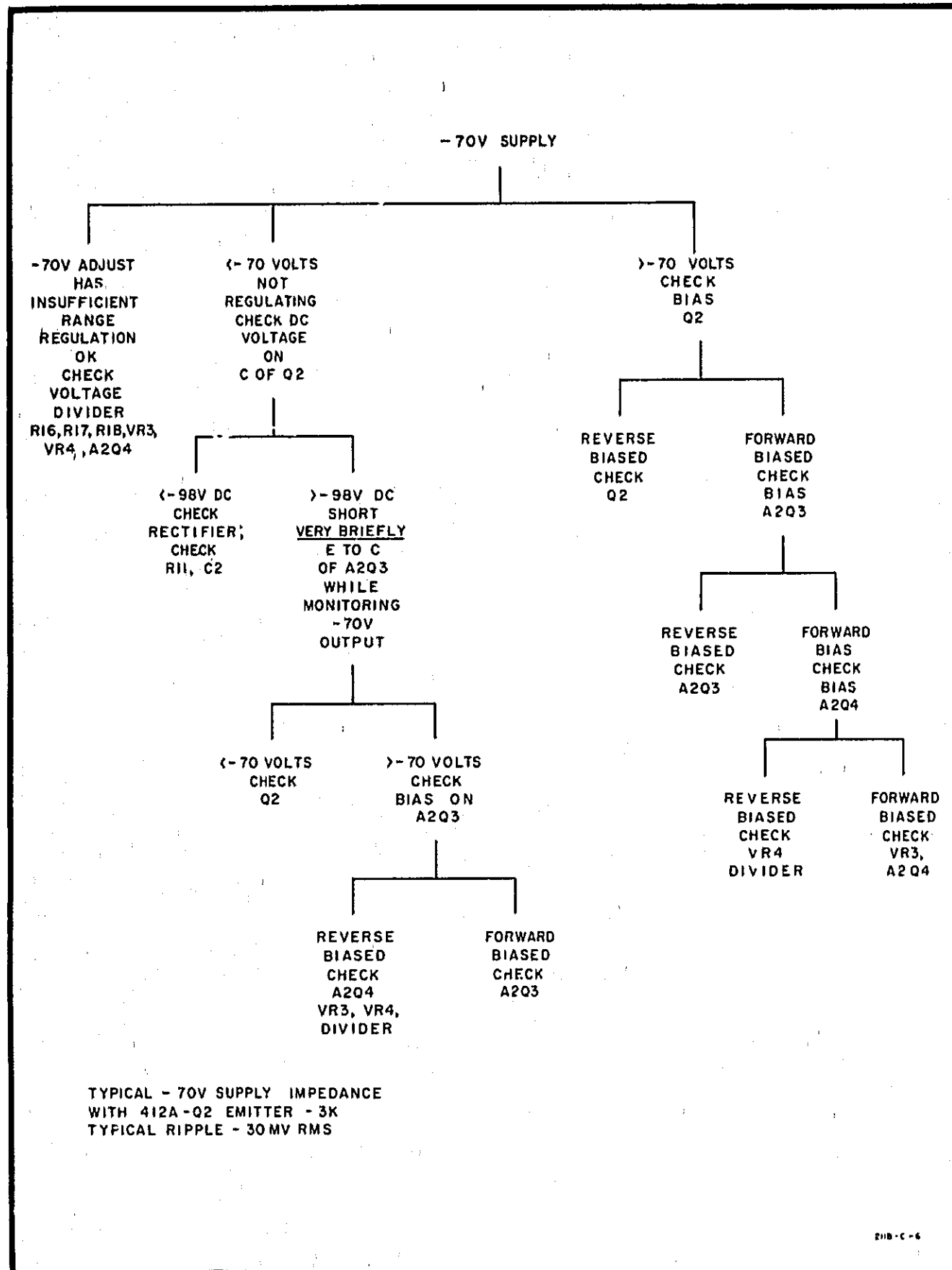

Figure 8-2. -70-volts Supply Troubleshooting Tree

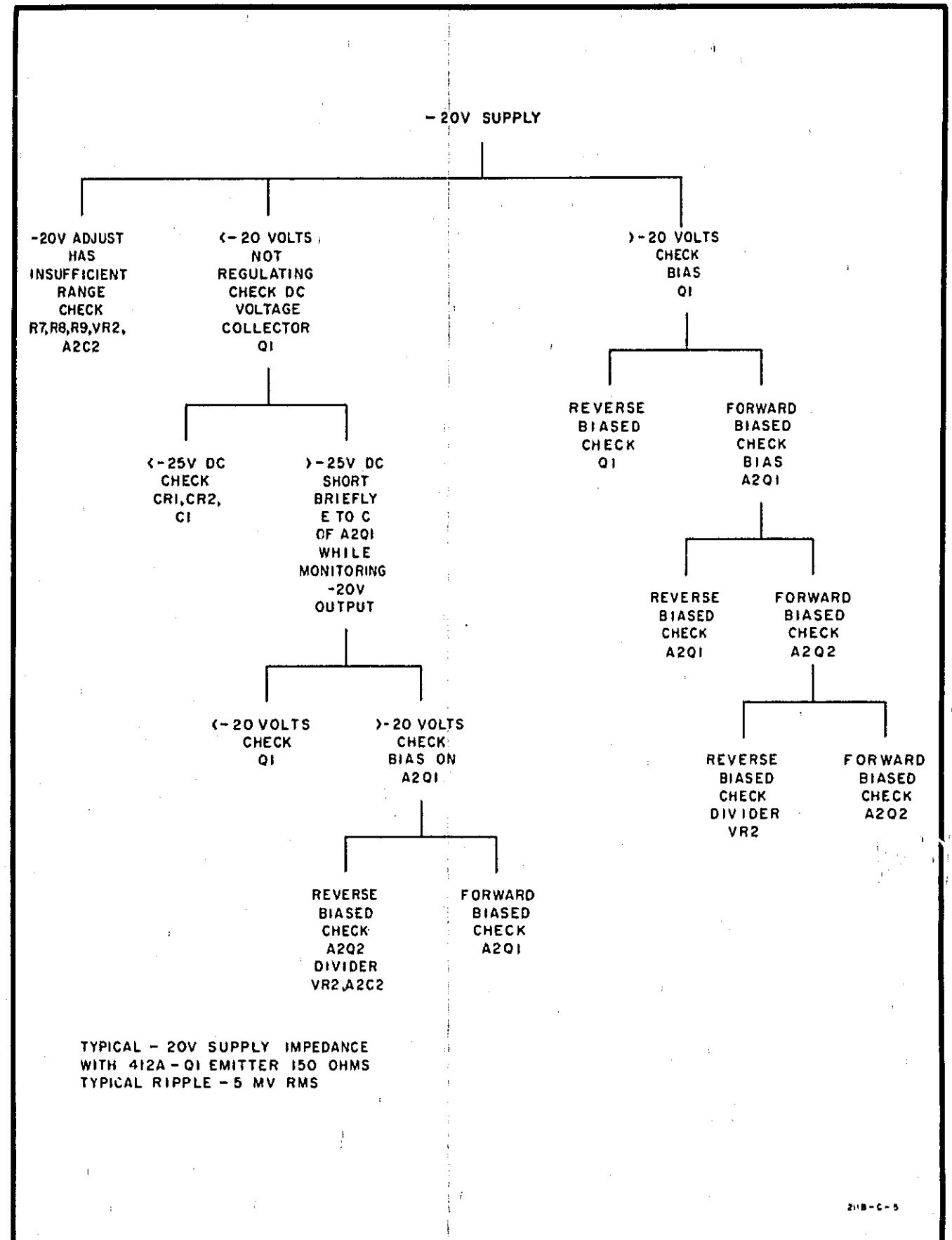

Figure 8-3. -20-volts Supply Troubleshooting Tree 8-3

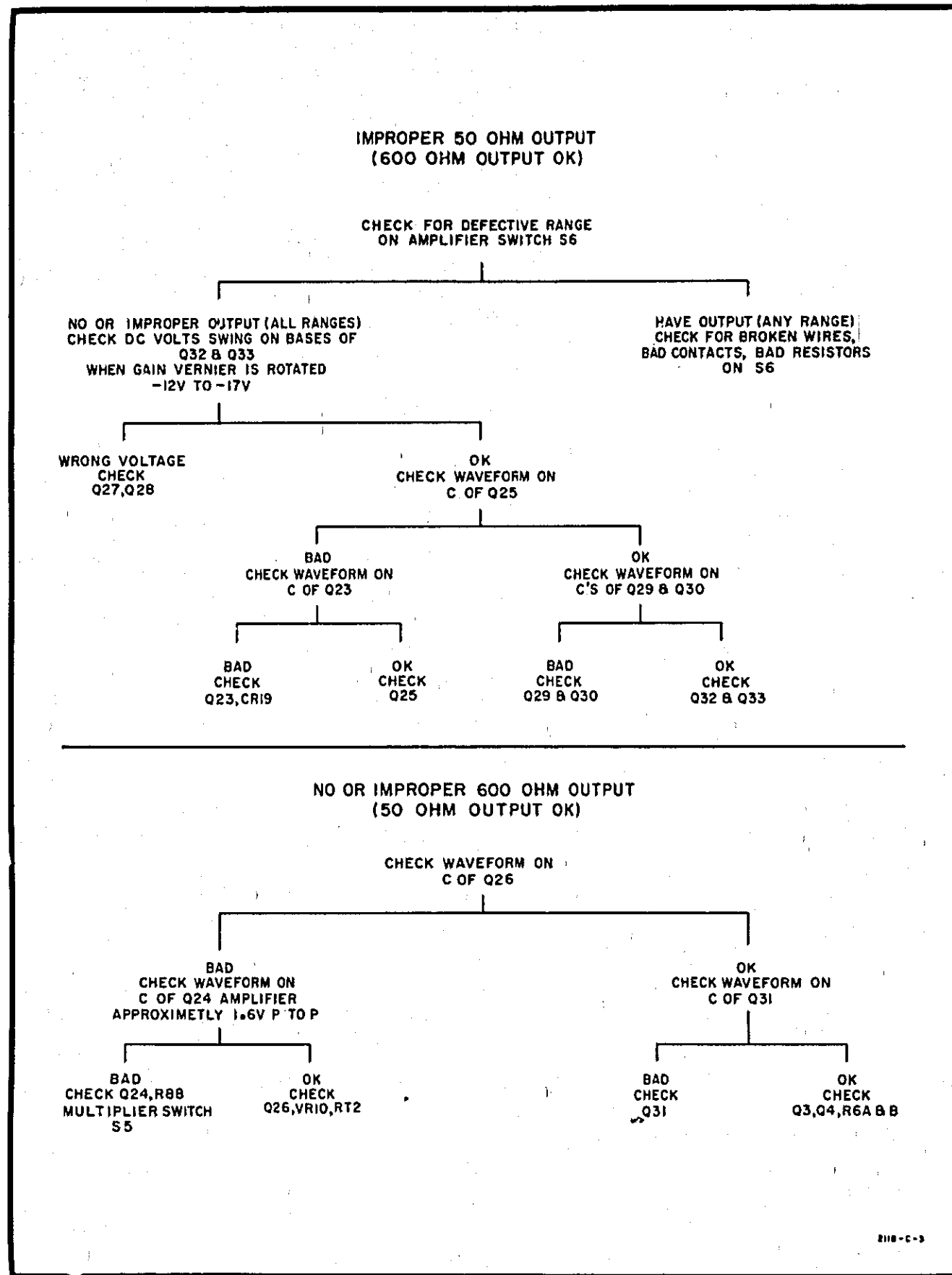

Figure 8-4. 50 Ohms—600 Ohms Output Troubleshooting Tree

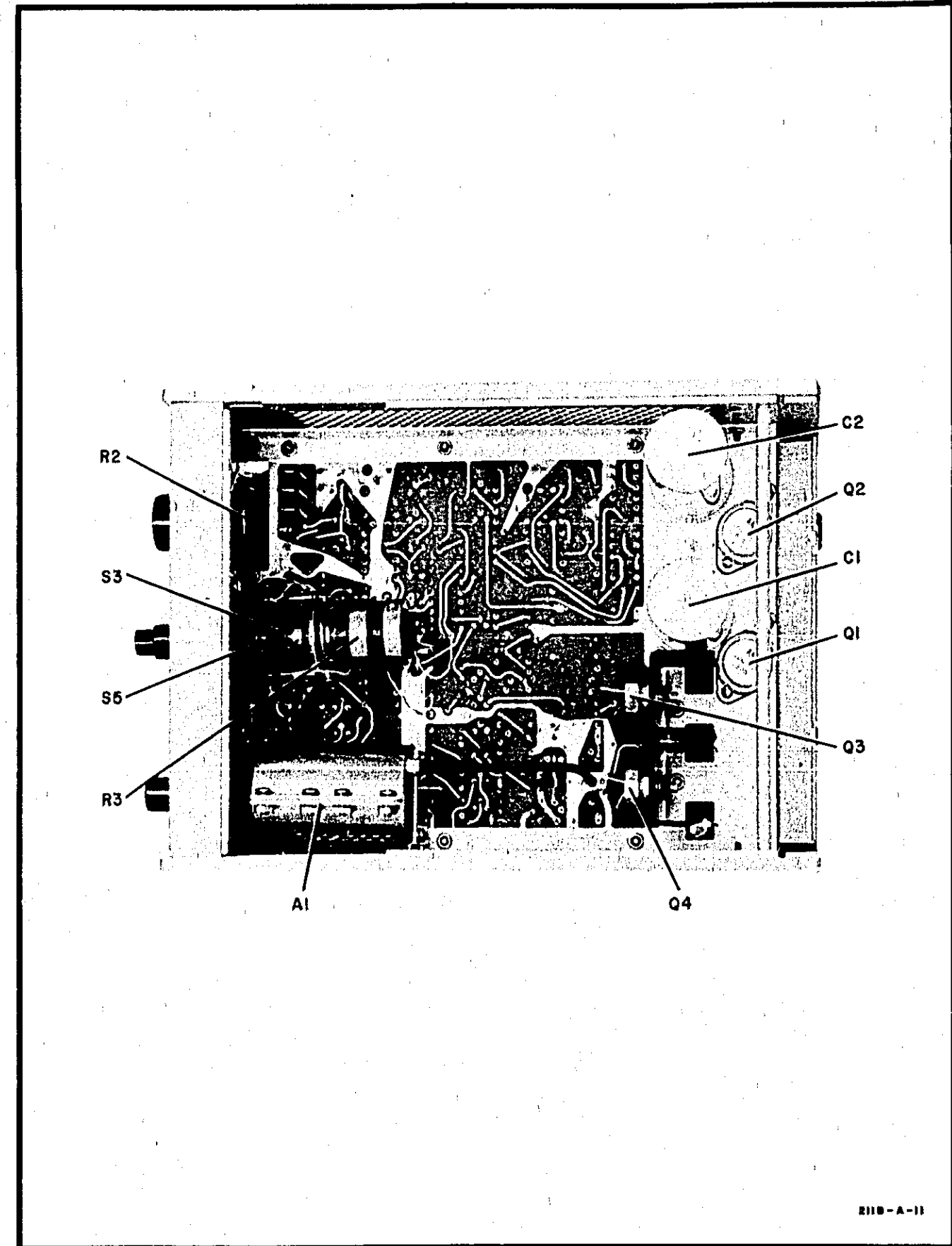

Figure 8-5. Chassis Component Identification - Top View

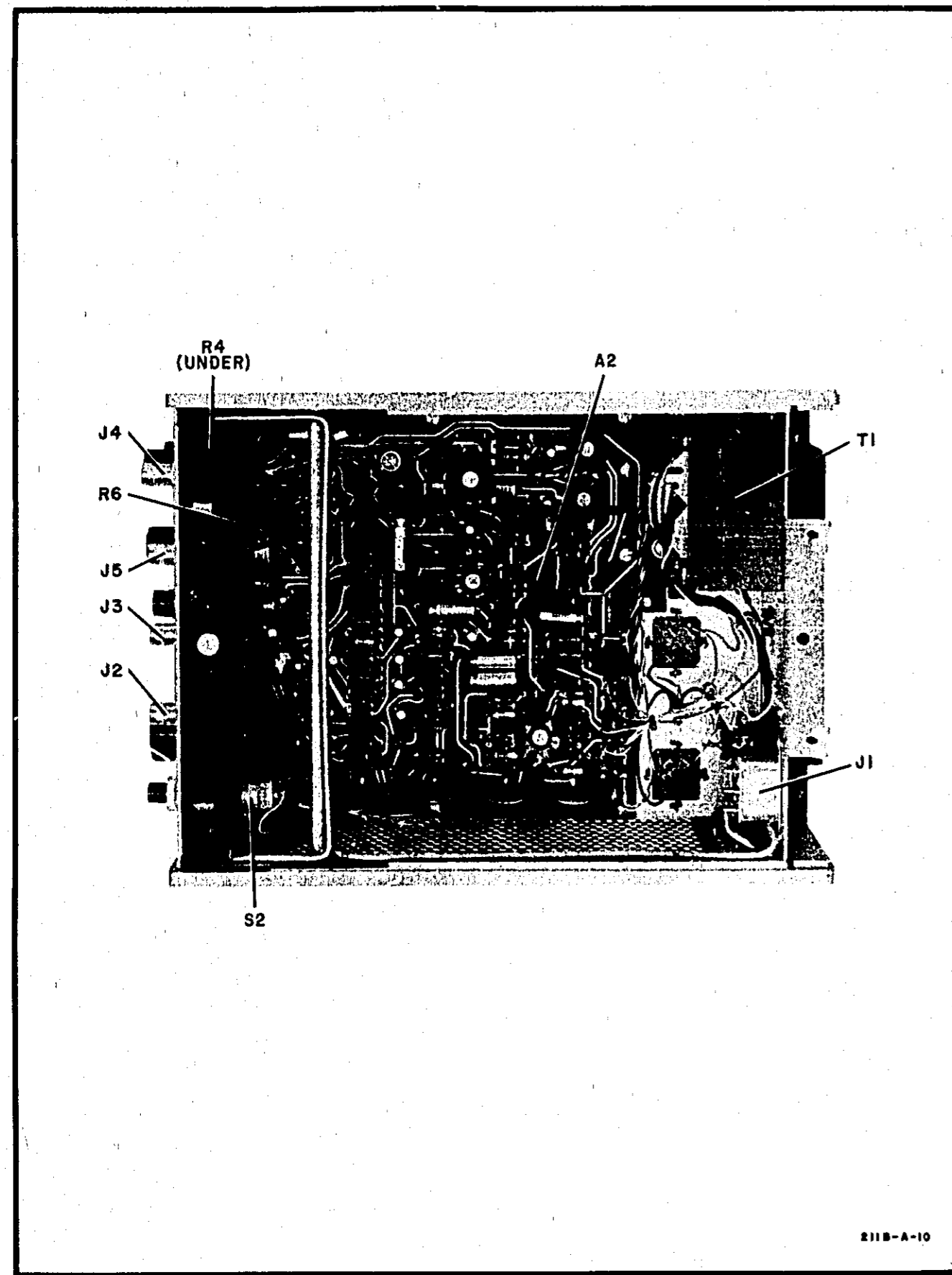

Figure 8-6. Chassis Component Identification - Bottom View

211B-A-10

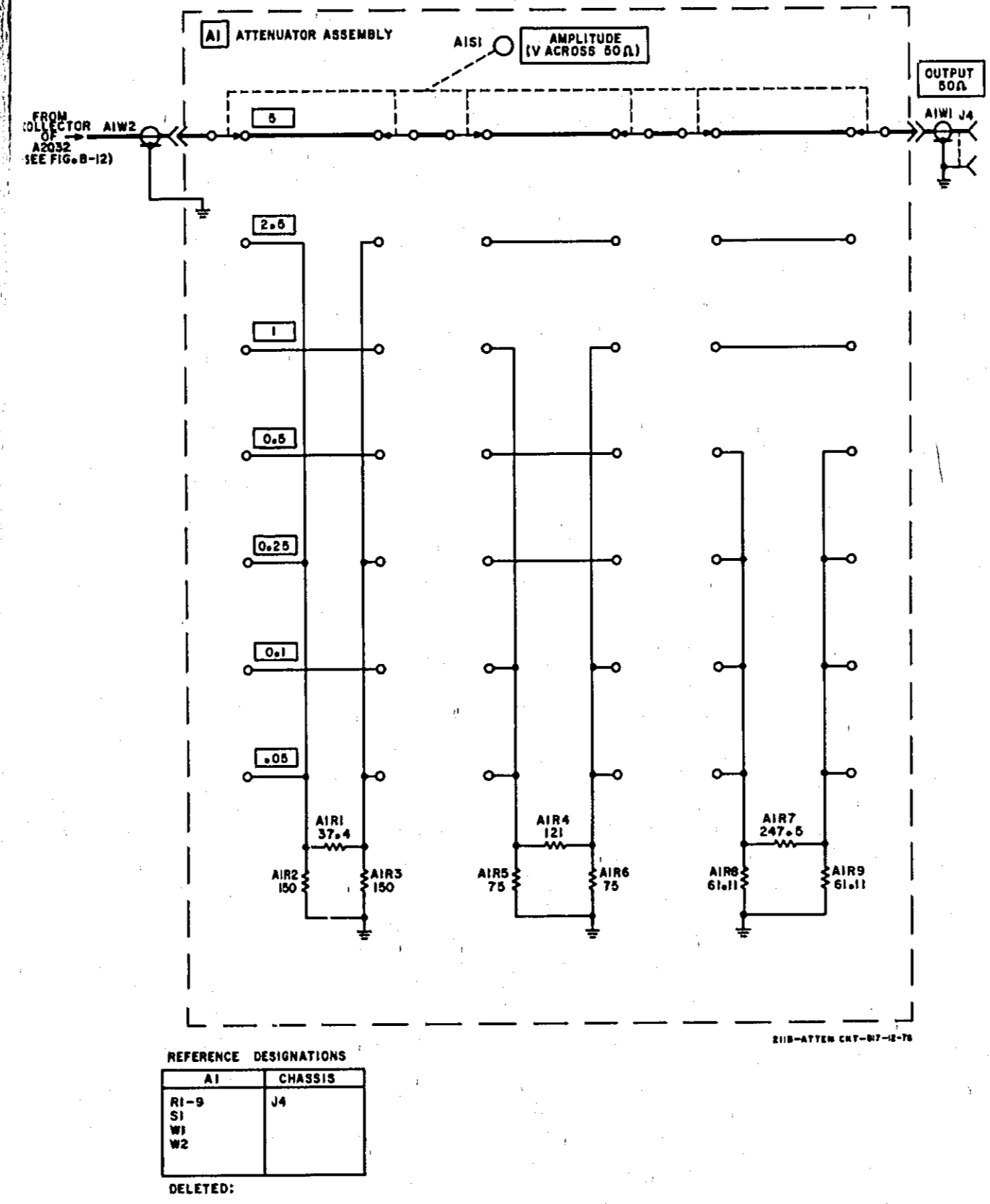

Figure 8-7. Attenuator Assembly A1 Schematic

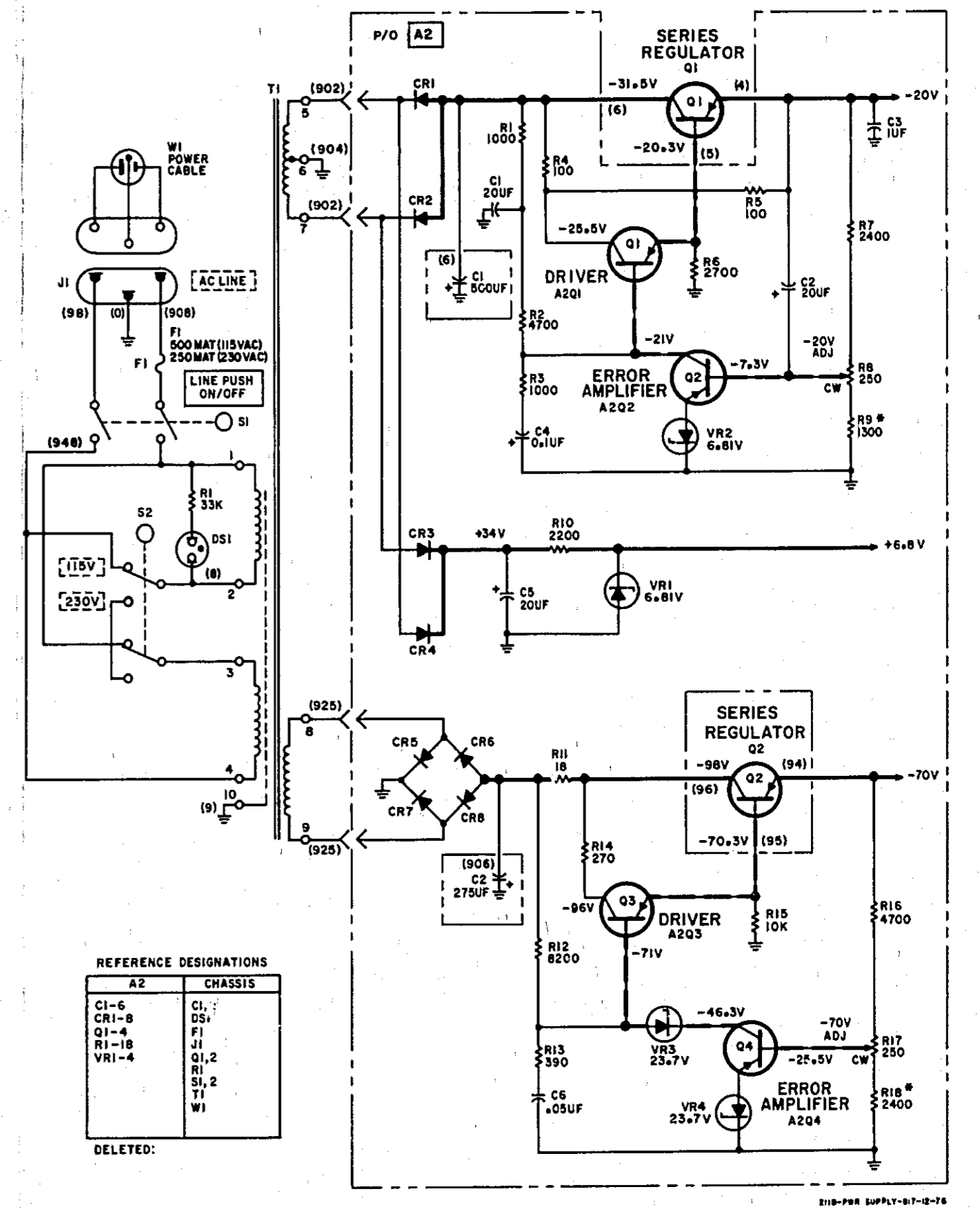

Figure 8-8. Power Supply Schematic

Table 8-2. Voltages with Schmitt Trigger Locked in One State

Transistor	Emitter of Q14 opened	Emitter of Q15 opened
Q14	Emitter open Base -3.1V Collector -0.3V	Emitter -7.1V Base -6.3V Collector -2.3V
Q15	Emitter -4.6V Base -3.8V Collector -4.0V	Emitter open Base -5.6V Collector 0V
Q16	Emitter -4.6V Base -4.0V Collector 0V	Emitter -0.7V Base 0V Collector 0V
Q13	Emitter -12.7V Base -12.1V Collector -3.1V	Emitter -8.6V Base -7.9V Collector -6.3V
Q5	Emitter -19.2V Base -18.6V Collector -0.8V	Emitter -19.2V Base -18.6V Collector -0.8V
Q6	Emitter -20.0V Base -19.2V Collector -12.5V	Emitter -20.0V Base -19.2V Collector -8.4V
Q7	Emitter -0.1V Base -0.8V Collector -11.5V	Emitter -0.1V Base -0.8V Collector -7.4V
Q8	Emitter -12.5V Base -12.0V Collector 0V	Emitter -8.4V Base -7.8V Collector 0V
Q9	Emitter -11.7V Base -12.0V Collector -20.0V	Emitter -7.4V Base -7.8V Collector -20.0V
Q12	Emitter -19.8V Base -19.2V Collector -0.2V	Emitter -16.3V Base -15.6V Collector -4.8V
Q11	Emitter -0.8V Base -0.2V Collector -0.7V	Emitter -5.3V Base -4.8V Collector -0.6V
Q10	Emitter 0V Base 0.7V Collector 0.8V	Emitter 0V Base 0.6V Collector -5.3V

Table 8-3. Frequency Control Measurement Conditions

1. Set the model 211B controls as follows:

MULTIPLIER 1K
 SYMMETRY Approx 50%
 FREQUENCY (Hz) 10
 AMPLITUDE (sw) 5
 VERNIER cw
 AMPLITUDE (dial) cw

2. Voltages and waveforms may vary slightly from one instrument to another. Unless otherwise indicated, all voltages are dc, taken with a 20,000 ohm-per-volt meter and measured to chassis ground.

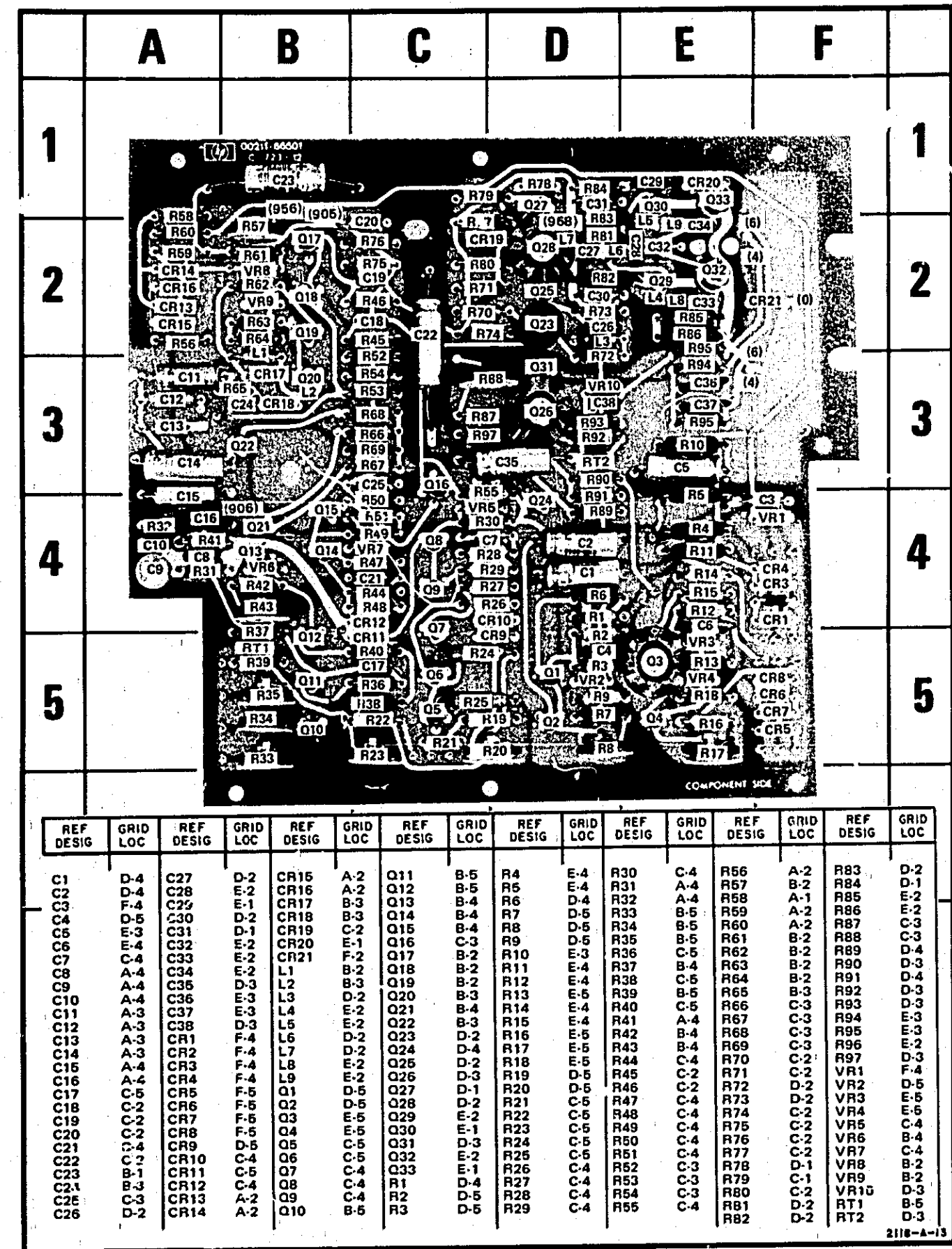

Figure 8-9. Assembly A2 Component Identification

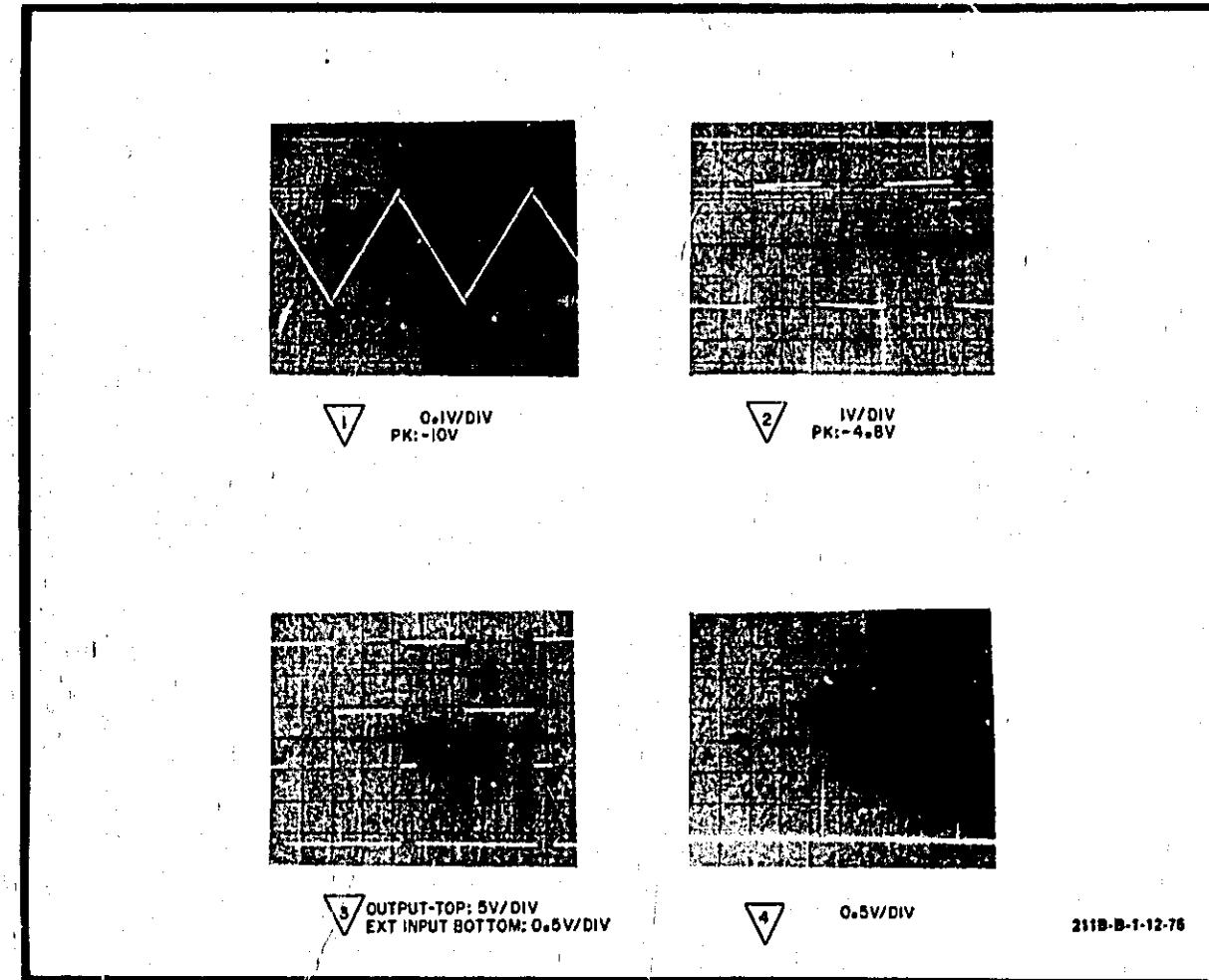

Figure 8-10. Frequency Control Waveforms

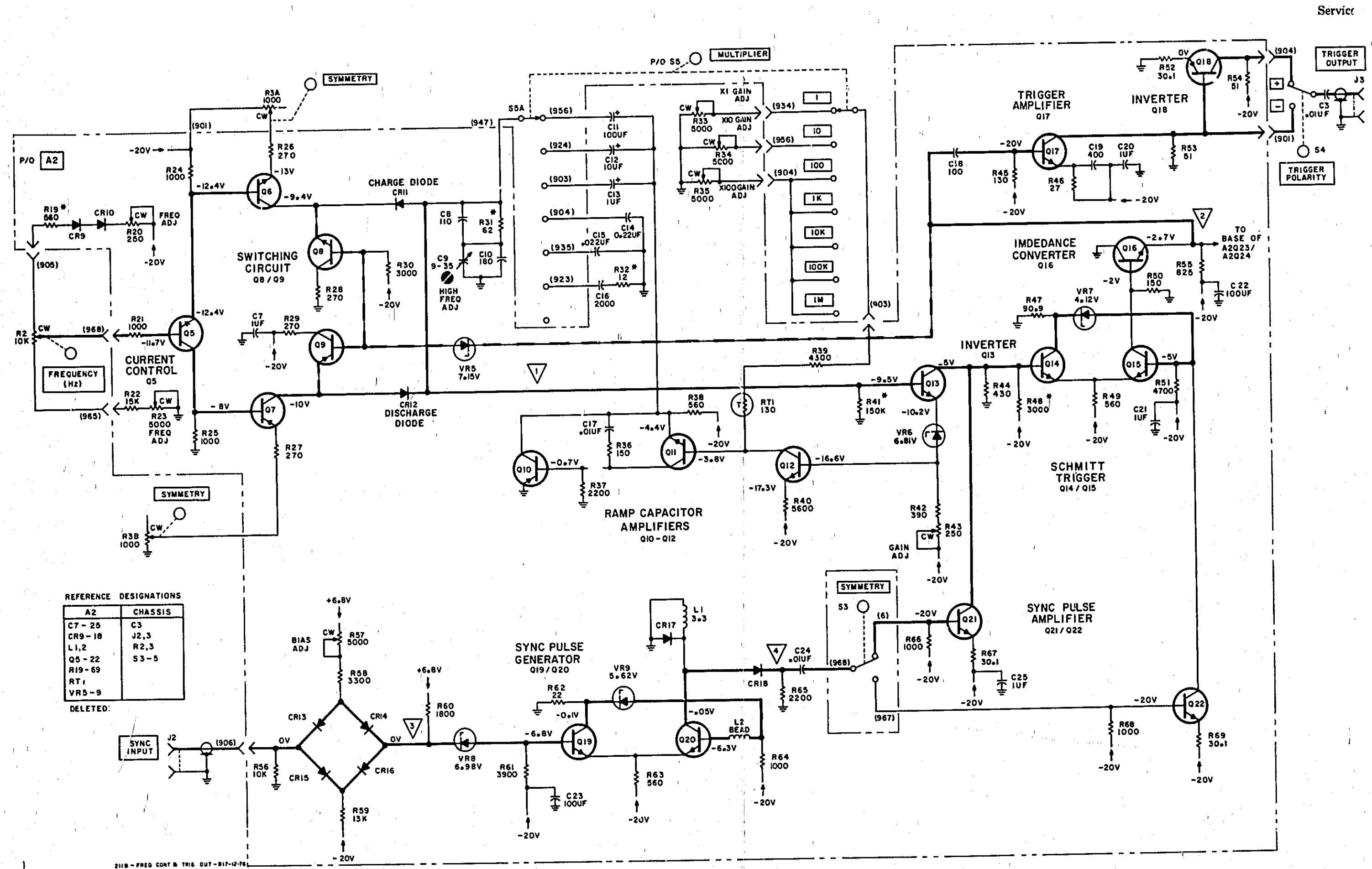

Figure 8-11. Frequency Control Schematic 8-7

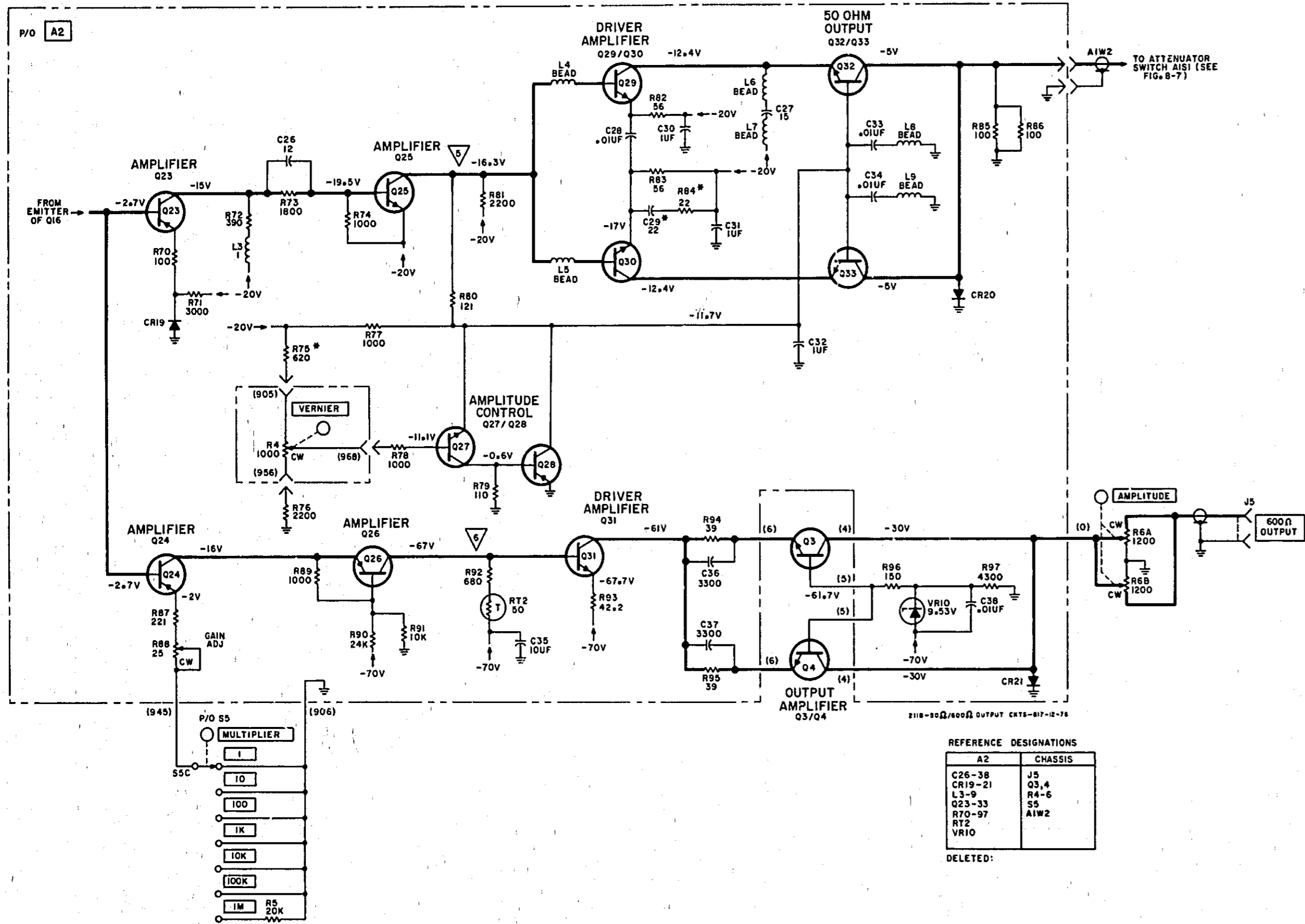

Figure 8-12. Output Circuitry Schematic

Table 8-4. Output Circuitry Measurement Conditions

- Set the model 211B controls as follows:

MULTIPLIER	1K
SYMMETRY	Approx 50%
FREQUENCY (Hz)	10
AMPLITUDE (sw)	5
VERNIER	cw
AMPLITUDE (dial)	cw
- Voltages and waveforms may vary slightly from one instrument to another. Unless otherwise indicated, all voltages are dc, taken with a 20,000 ohm-per-volt meter and measured to chassis ground.

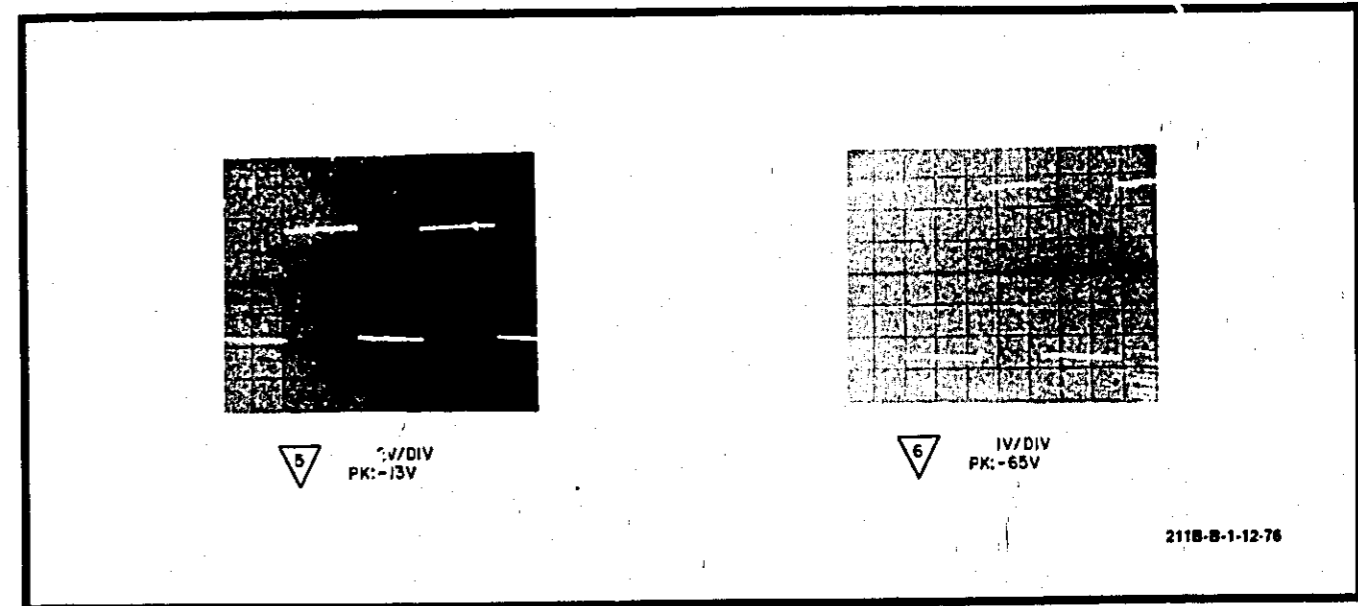

Figure 8-13. Output Circuitry Waveforms