

HP 8350A SWEEP OSCILLATOR

8350A Sweep Oscillator  
Operation and Service Manual  
January 1, 1980  
08350-90001

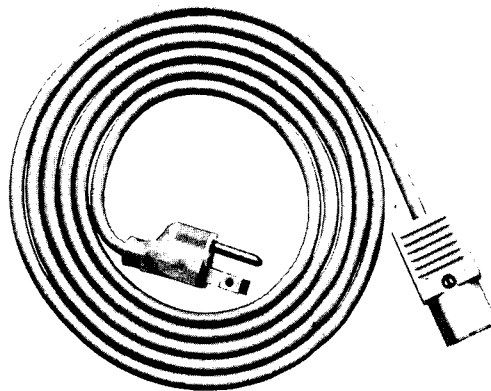

POWER CABLE\*

\*POWER CABLE/PLUG SUPPLIED DEPENDS ON COUNTRY OF DESTINATION. REFER TO SECTION II FOR PART NUMBER INFORMATION.

Figure 1-1. Model 8350A Sweep Oscillator

## SECTION I GENERAL INFORMATION

### 1-1. INTRODUCTION

1-2. This Operating and Service Manual contains information required to install, operate, test, adjust, and service the Hewlett-Packard Model 8350A Sweep Oscillator. Figure 1-1 shows the Model 8350A and power cable.

1-3. This manual is divided into eight major sections which provide the following information:

- a. SECTION I, GENERAL INFORMATION, includes a brief description of the instrument, safety considerations, specifications, supplemental characteristics, instrument identification, options available, accessories available, and a list of recommended test equipment.
- b. SECTION II, INSTALLATION, provides information for initial inspection, preparation for use, battery information, rack mounting, storage, and shipment.
- c. SECTION III, OPERATION, consists of three subsections which contain general operating information, local operation information (non-HP-IB), and remote operation information (Programming Notes which provide information on HP-IB use of the Model 8350A).
- d. SECTION IV, PERFORMANCE TESTS, presents procedures required to verify that performance of the instrument is in accordance with published specifications. Performance Tests which are general to most RF plug-in units are given in the section. Performance Test limits and other special tests related to specific RF plug-ins are supplied in each RF plug-in Operating and Service Manual. Included is a Local and Remote Operation Verification procedure.
- e. SECTION V, ADJUSTMENTS, presents procedures required to properly adjust and

align the Model 8350A Sweep Oscillator mainframe after repair. Refer to the Operating and Service Manual of the specific RF plug-in used for adjustments related to the RF plug-in.

- f. SECTION VI, REPLACEABLE PARTS, provides information required to order all parts and assemblies.
- g. SECTION VII, MANUAL BACKDATING CHANGES, provides backdating information required to make this manual compatible with earlier shipment configurations.
- h. SECTION VIII, SERVICE, provides an overall instrument block diagram with troubleshooting and repair procedures. Each assembly within the instrument is covered on a separate Service Sheet which contains a circuit description, schematic diagram, component location diagram, and troubleshooting information to aid the proper maintenance of the instrument.

1-4. Supplied with this manual is an Operating Information Supplement. This is simply a copy of the first three sections of the manual which should be kept with the instrument for use by the instrument operator.

1-5. On the front cover of this manual is a "Microfiche" part number. This number may be used to order 10- by 15-centimeter (4- by 6-inch) microfilm transparencies of the Manual. Each microfiche contains up to 60 photo duplicates of the manual pages. The microfiche package also includes the latest Manual Changes sheet as well as all pertinent Service Notes.

1-6. Refer any questions regarding this manual, the Manual Changes sheet, or the instrument to the nearest HP Sales/Service Office. Always identify the instrument by model number, complete name, and complete serial number in all correspondence. Refer to the inside rear cover of this manual for a worldwide listing of HP Sales/Service Offices.

Table 1-1. Model 8350A Specifications (1 of 2)

**SPECIFICATIONS**  
**8350A SWEEP OSCILLATOR**  
 (with RF Plug-in installed)

**FREQUENCY CONTROL FUNCTIONS**

**Range:** Determined by RF plug-in unit used.

**Linearity:** Refer to RF plug-in unit specifications.

**START/STOP Sweeps:** Sweeps up from the START frequency to the STOP frequency.

Range: START and STOP parameters are independent, fully calibrated, and continuously adjustable over the entire frequency range. STOP frequency must be greater than or equal to START frequency.

**CF/ $\Delta$ F Sweep:** Sweeps symmetrically upward in frequency, centered on the CF (Center Frequency) setting.

$\Delta$ F: Frequency width of sweep. Continuously adjustable from zero to 100% of frequency range. START/STOP and CF/ $\Delta$ F modes can be interchanged without affecting RF output.

$\Delta$ F Accuracy: Refer to RF plug-in unit specifications.

CF Accuracy: Refer to RF plug-in unit specifications.

CF Resolution: 0.024% (4096 points across band).

$\Delta$ F Resolution: 0.1% of full band (1024 points across band); 0.012% of full band for 1/8 band or less (8192 points across band); 0.0015% of full band for 1/64 band or less (16,384 points across band).

Display Resolution: 5 digits maximum.

**CW Operation:** Single frequency RF output. When changing between CF/ $\Delta$ F and CW mode, the CW frequency and the Center Frequency (CF) are equivalent.

CW Accuracy: Refer to RF plug-in unit specifications.

CW Resolution: Same as CF.

**Vernier:** Adjusts CW frequency of swept range up to  $\pm 0.05\%$  of RF plug-in band being swept. The vernier adds its value to the appropriate frequency parameter and then resets to zero when the adjustment exceeds  $\pm 0.05\%$  for continuous adjustment. The " $\neq 0$ " LED is on whenever a vernier adjustment value is present.

Vernier Resolution: 4 ppm (64 points between each CW point; 262,144 points across band).

**Offset:** Allows the CW frequency or center frequency of swept range to be offset by any amount up to the full range of the RF plug-in. After entering an offset and returning the displays to the previous mode, the " $\neq 0$ " LED will be on indicating that an offset is present; however, the display will remain unchanged.

Resolution: Same as CF.

Accuracy: Refer to RF plug-in unit specifications.

**Frequency Markers:** Five frequency markers are independently adjustable and fully calibrated over the entire sweep range. Front panel key provides for the selection of either amplitude or intensity markers.

Resolution: 0.4% of selected sweep width (250 points/sweep).

Accuracy: Refer to RF plug-in unit specifications.

Marker Output: Negative rectangular pulse available from the POS Z BLANK connector on the rear panel. Refer to Table 1-2.

Table 1-1. Model 8350A Specifications (2 of 2)

**Marker Sweep:** RF output is swept between Marker 1 and Marker 2 frequency values. The Marker 1 and Marker 2 frequency values can be entered as permanent sweep values with the SHIFT key. Pressing MKR SWEEP again returns the instrument to the last START/STOP values.

**Marker→CF:** Marker-to-Center Frequency function causes the CW or Center Frequency (CF) of the sweep output to equal the frequency of the active marker.

### SWEEP AND TRIGGER MODES

**Internal:** Sweep recurs automatically.

**Line:** Sweep triggered by ac power line frequency.

**External Trigger:** Sweep is actuated by an external trigger signal applied to pin 9 of the rear panel Programming Connector on the rear panel. Trigger signal must be  $> +2$  Vdc, wider than 0.5  $\mu$ s, and not greater than 1 MHz in frequency.

**Single:** Selects mode and triggers/aborts a single sweep.

**Sweep Time:** Continuously adjustable from 10 ms to 100 seconds. Minimum sweep time may be more than 10 ms depending upon the specific RF plug-in used and the bandwidth swept.

**Manual Sweep:** Front panel controls (knobs, keyboard, and step keys) provide continuous manual adjustment of frequency between end frequencies set in any of the sweep functions. Resolution is 0.1% of selected sweep width (980 points across sweep).

**External Sweep:** Sweep is controlled by a zero to +10 volt sweep ramp external signal applied to the front or rear panel SWEEP OUTPUT/SWEEP INPUT connectors. Resulting RF Output frequency accuracy will be a function of input sweep ramp accuracy and linearity.

**Sweep Output:** Positive-going, direct-coupled sawtooth at front and rear panel SWEEP OUTPUT/SWEEP INPUT connectors, concurrent with

swept RF output. In CW mode, dc output is proportional to the RF plug-in unit full-band frequency. Refer to Table 1-2.

### MODULATION CHARACTERISTICS

**External AM:** Refer to RF plug-in unit specifications. Rear panel BNC connector.

**Internal AM:** Square wave modulation available at all sweep speeds through front panel control. Refer to RF plug-in for On/Off ratio specifications. Refer to Table 1-2 for frequency characteristics.

**External FM:** Refer to RF plug-in unit specifications. Rear panel BNC connector.

### GENERAL SPECIFICATIONS

#### Blanking

**RF Blanking:** When enabled, RF automatically is turned off during retrace and remains off until the start of next sweep.

**Display Blanking:** POS Z BLANK; direct-coupled, positive rectangular pulse during retrace and bandswitch points of sweep. Negative intensity marker signals are also output through this connector. NEG Z BLANK; direct-coupled, negative rectangular pulse during retrace and bandswitch points of sweep. Both are rear panel BNC outputs. Refer to Table 1-2.

**Pen Lift:** Output to control the pen lift function of an X-Y recorder. Refer to Table 1-2 for maximum sink current rating.

**Counter Trigger (CNTR TRIG):** Output for controlling the external trigger input of the HP 5343A Microwave Frequency Counter. Rear panel BNC connector.

**Stop Sweep:** Input for stopping the progress of a forward sweep. Rear panel BNC connector.

Table 1-2. Model 8350A Supplemental Characteristics (1 of 2)

**SUPPLEMENTAL CHARACTERISTICS**  
**8350A SWEEP OSCILLATOR**  
 (with RF Plug-in installed)

**INPUT/OUTPUT SIGNAL CHARACTERISTICS**

**Frequency Marker Output:** Rectangular pulse, typically  $-5$  volts peak, available from the POS Z BLANK connector on the rear panel. Source impedance is approximately 1000 ohms.

**External Sweep:** Sweep is controlled by an External Sweep Input signal applied to the front or rear panel SWEEP OUTPUT/SWEEP INPUT connectors. The External Sweep Input must be zero volts at start of sweep, increasing linearly to  $+10$  volts at the end of sweep.

**Sweep Output:** Direct-coupled sawtooth, zero to approximately  $+10$  volts, at front and rear panel SWEEP OUTPUT/SWEEP INPUT connectors concurrent with swept RF output. Zero volts at start of sweep, approximately  $+10$  volts at end of sweep, regardless of sweep width. In CW mode, dc output is proportional to the RF plug-in unit full-band frequency. In SHIFT CW mode, a 0 to  $+10$  volt ramp is output, regardless of CW frequency.

**MODULATION CHARACTERISTICS**

**Internal AM:** Square wave modulation available at all sweep speeds. Factory preset to 27.8 kHz although selectable (via internal jumper) to 1000 Hz or 27.8 kHz. Refer to RF plug-in for On/Off ratio specifications.

**INSTRUMENT CONTROL**

**Control Knobs, Step Keys, and Data Entry Keyboard:** All instrument parameters, whether time, frequency, or power, may be set in three ways. The control knobs allow for continuous adjustment of any parameter. An exact function value can be entered through the Data Entry Keyboard. For incrementing or decrementing power or frequency values, the Step Keys (Step Up/Step Down) can be used. The step size can be entered by the user or the pre-programmed default values may be used. The SHIFT key is used to effect the function written in blue on the front panel.

**INSTRUMENT STATE STORAGE**

**SAVE n/RECALL n:** Up to 9 different front panel settings can be stored in the 8350A via the SAVE n ( $n=1$  through 9) function. Instrument settings are stored in memory locations 1 through 9 and can be recalled randomly or in sequence (1, . . . , 9, 1, . . .) with Step Up/Step Down keys or by contact closure to ground of the Step Up Advance (pin 22 on the rear panel Programming Connector).

**ALT n:** The ALT n function causes the RF output to alternate on successive sweeps between the current front panel setting and the setting stored in memory location n ( $n=1$  through 9).

**INSTRUMENT STATE**

**Instrument Preset:** The Instrument Preset (INSTR PRESET) key sets the 8350A into the following predetermined state: the RF output is swept over the full frequency range of the RF plug-in at the specified maximum leveled power level (an RF OFF condition can be selected by a presettable configuration switch located within the RF plug-in), the internal square wave AM is off, and the frequency markers are off. Instrument Preset also causes an internal analog and digital self-test to occur. If certain internal errors or failures are detected during the self-test or during normal operation of the 8350A, they are indicated via error code messages in the form of "Ennn" (where  $n=0$  through 9) read from the left FREQUENCY display.

**Local Operation:** The Local (LCL) key is used to return the 8350A to local control from the remotely controlled state. The REM LED indicates when the 8350A is being controlled remotely. The ADRS'D LED indicates when data is being transmitted or received over the HP-IB.

Table 1-2. Model 8350A Supplemental Characteristics (2 of 2)

**REMOTE PROGRAMMING (HP-IB)**

**Instrument Control:** All front panel controls except the line power switch may be controlled or programmed remotely. The 8350A is fully compatible with the HP-IB. The 8350A has both input and output capability, providing complete control of the instrument state. The HP-IB address can be displayed on the front panel and is selectable by the user from 0 to 30. Refer to Table 2-3 for a listing of HP-IB address codes.

**HP-IB Functions**

**Input Mode Functions:** All front panel controls except the ac power line switch are programmable. Functions that require numerical values typically have greater entry resolution than is displayed. Several special HP-IB functions are provided that are not available from the front panel.

**Frequency Resolution:** Same as  $CF/\Delta F$  plus vernier.

**Power Resolution:** Refer to RF plug-in unit specifications.

**Output Mode Functions:** The 8350A can output to a controller an instrument state message that completely describes the present instrument status (sweep mode, trigger mode, etc.) and can supply the present numerical value of any function (sweep time, marker frequencies, power levels, start/stop frequencies, etc.).

**GENERAL****Nonvolatile Memory**

**Option 001:** Continuous memory that retains the contents of all instrument state storage registers and the HP-IB address along with the current instrument state when the ac power is turned off for approximately 20 days.

**Display Blanking Outputs**

**POS Z BLANK:** Direct-coupled rectangular

pulse approximately +5 volts during retrace and bandswitch points of sweep. Intensity marker signals are also output through this rear panel BNC connector. Marker signals are -4 volt pulses with the exception of the active marker which is -8 volts.

**NEG Z BLANK:** Direct-coupled rectangular pulse approximately -5 volts during retrace and bandswitch points of sweep. No markers are output from this rear panel BNC connector.

**Pen Lift Output:** Output to control the pen lift function of an X-Y recorder. Maximum sink current is approximately 600ma.

**Rear Panel Programming Connector:** Additional control of and information on the 8350A instrument state is provided via a 25-pin rear panel connector. Output signals such as display and RF blanking, X-Y recorder pen lift, HP 8410B and HP 5343A interface signals. Input signals affect the sweep status, display and RF blanking, pen lift outputs, etc. Refer to Figure 2-7 for a complete listing of signals and voltages on the rear panel Programming Connector.

**8410B Interface Cable:** Permits multi-octave operation of HP 8410B Network Analyzer with the 8350A (order HP Part Number 08410-60146). Connects between 8410B rear panel SOURCE CONTROL and 8350A rear panel PROGRAMMING CONNECTOR.

**Furnished:** 2.29m (7.5 foot) power cable with NEMA plug.

**Operating Temperature Range:** 0°C to +55°C.

**Power:** 100, 120, 220, or 240 volts, +5% -10%, 50 to 60 Hz (Option 400; 60 to 400 Hz). Approximately 270 volt-amps including RF plug-in unit (depends upon specific RF plug-in unit used).

**Weight** (not including RF plug-in unit): Net 16.5 kg (36.4 lb) Shipping 22.7 kg (50 lb).

**Dimensions:** 425 W, 133.3 H, 422 mm D (16.75 x 5.25 x 16.6 in).

## 1-7. SPECIFICATIONS

1-8. Listed in Table 1-1 are the specifications for the Model 8350A Sweep Oscillator. These specifications are the performance standards, or limits, against which the instrument may be tested. Only the specifications for the Model 8350A Sweep Oscillator mainframe are given in this manual. Refer to the Operating and Service Manual for the specific RF plug-in used for complete specifications relating to the RF plug-in. Table 1-2 lists the sweep oscillator supplemental characteristics. Supplemental characteristics are not specifications but are typical characteristics included as additional information for the user.

## 1-9. SAFETY CONSIDERATIONS

### 1-10. General

1-11. This product and related documentation must be reviewed for familiarization with safety markings and instructions before operation. This product has been manufactured and tested in accordance with international safety standards.

### 1-12. Safety Symbols

1-13. A complete listing of the safety symbols used in this manual is given on the page preceding Figure 1-1. Included are descriptions of symbols which refer the operator to the manual from the instrument, Protective Earth Ground, Frame or Chassis Terminals, Warning, and Caution symbols.

## 1-14. INSTRUMENTS COVERED BY MANUAL

1-15. Attached to the rear panel of the instrument is a serial number plate. A typical serial number plate is shown in Figure 1-2. The serial

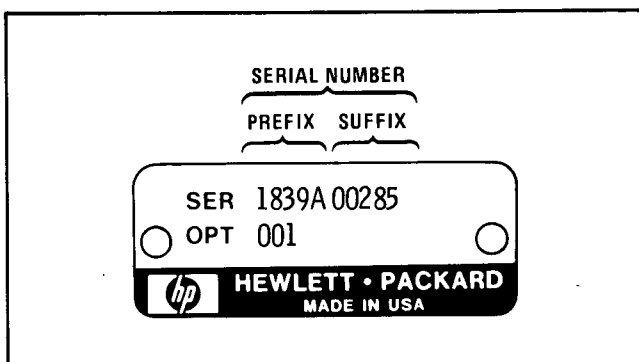

Figure 1-2. Typical Serial Number Plate

number is in two parts. The first four digits followed by a letter comprise the serial number prefix. The last five digits form the sequential suffix that is unique to each instrument. The content of this manual applies directly to instruments having the same serial number prefix as those listed on the title page of this manual under SERIAL NUMBER.

1-16. An instrument manufactured after the printing of this manual may have a serial prefix that is not listed on the title page. An unlisted serial prefix indicates that the instrument is different from those documented in this manual. The manual for the instrument is then supplied with a Manual Changes supplement that contains information that documents the differences.

1-17. In addition to change information, the Manual Changes supplement contains information for correcting errors in the manual. To keep this manual as current as possible, Hewlett-Packard recommends that you periodically request the latest Manual Changes supplement. The supplement for this manual is keyed to the manual's print date and part number, both of which appear on the title page. Complimentary copies of the Manual Changes supplement are available on request from Hewlett-Packard.

1-18. For information concerning a serial number prefix that is not listed on the title page or in the Manual Changes Supplement, contact your nearest Hewlett-Packard Sales/Service Office.

## 1-19. DESCRIPTION

1-20. The Hewlett-Packard Model 8350A Sweep Oscillator, together with an RF plug-in unit, forms a complete, solid-state, swept signal source. The Model 8350A can be used with network analyzer systems such as the HP Model 8410B Network Analyzer, the HP Model 8755 Frequency Response Test Set, and the HP Microwave Link Analyzers to provide a complete measurement system.

1-21. The front panel of the Model 8350A has been conveniently laid out to optimize the use of instrument operation function blocks. Frequency modes, sweep modes, marker operation, storage register control, and data entry controls are individually grouped for ease of operation and full control versatility on the Model 8350A Sweep Oscillator.

1-22. Upon initial turn on, or after the INSTRUMENT PRESET pushbutton is selected, the instrument automatically goes through an internal self check routine to verify proper instrument operation. If certain errors or failures are detected during the self test or in normal operation, they are indicated via error codes displayed on the far left digital display. An INSTRUMENT PRESET condition is then set which automatically presets the sweep oscillator to full RF plug-in band sweep operation.

### 1-23. Accurate High Resolution Data Entry

1-24. Accurate, high resolution digital displays indicate all major function values. Function values may be set by activating the appropriate pushbutton and using the corresponding knob, step keys, or data entry keyboard to enter the desired values.

### 1-25. Sweep and Trigger Modes

1-26. The sweep may be triggered INTERNally, through ac power LINE frequency, EXTERNally, or in SINGLE sweep operation. SWEEP TIME is continuously variable from 10 ms to 100 seconds. (Minimum sweep time may be greater than 10 ms depending upon the specific RF plug-in used and the bandwidth being swept). A MANUAL SWEEP function allows the data entry controls to provide continuous manual adjustment of frequency between the end frequencies set in any of the sweep functions. A direct coupled sawtooth sweep ramp, zero to approximately 10 volts, is available through both front and rear panel SWEEP OUTPUT/SWEEP INPUT BNC connectors.

### 1-27. START/STOP Mode

1-28. The START/STOP frequency sweep mode, selected upon Instrument Preset, is indicated by yellow LEDs located above the selected operation pushbuttons. In this mode the Model 8350A sweeps up from the START frequency to the STOP frequency. START and STOP frequencies are indicated on the FREQUENCY LED displays. START frequency or STOP frequency may then be changed through the use of the data entry controls.

### 1-29. CW Mode

1-30. When CW (Continuous Wave) mode is selected, the instrument is tuned to a single

frequency RF Output, indicated on the FREQUENCY LED display. CW mode operation is indicated by the yellow LED located above the CW pushbutton. CW frequency, when enabled, may be varied through the use of the data entry controls. When the SHIFT CW mode is selected, a 0 to 10 volt sweep ramp will be output at the front and rear panel SWEEP OUTPUT/SWEEP INPUT BNC connectors, even though the RF frequency is fixed in the CW mode.

### 1-31. CF/ $\Delta$ F Mode

1-32. The CF/ $\Delta$ F frequency sweep mode allows the instrument to sweep upward in frequency, symmetrically centered about a CF (Center Frequency) setting. CF/ $\Delta$ F sweep mode operation is indicated by the yellow LEDs centered above the CF and  $\Delta$ F pushbuttons. CF and  $\Delta$ F frequencies may be individually varied through use of the data entry controls. START/STOP and CF/ $\Delta$ F sweep modes may be interchanged without affecting the RF Output. When changing between CF/ $\Delta$ F sweep mode and CW mode, the CW frequency and the Center Frequency (CF) are equivalent.

### 1-33. Frequency Marker Operation

1-34. Five independent, continuously variable, amplitude or intensity markers are available to note significant points on the frequency sweep. Marker selection is indicated by a yellow LED located within each Marker pushbutton. Marker frequency is indicated on the FREQUENCY/TIME LED display. The frequency difference between any two markers can be displayed by the MKR $\Delta$  function. A MKR SWEEP function allows a frequency sweep using Marker 1 and Marker 2 as the START/STOP frequency limits while maintaining the original START/STOP values. For greater accuracy, marker frequencies can also be counted directly using the HP Model 5343A Microwave Frequency Counter. The sweep is momentarily stopped allowing the counter to measure the START, STOP, or activated marker frequency.

### 1-35. Instrument State Storage

1-36. Up to 9 different front panel settings can be stored and recalled in the Model 8350A via the SAVE n (n=1 through 9) function. The ALT n function causes the RF Output to alternate on successive sweeps between the current front panel setting and the setting stored in the recalled memory location (n=1 through 9). This allows the



Model 8350A to work in conjunction with the HP Model 8755 Frequency Response Test Set to allow two different measurements to be made simultaneously by utilizing two different sweep widths and/or power levels.

### 1-37. Modulation Characteristics

1-38. The Model 8350A is capable of internally square wave modulating the RF Output at a 27.8 kHz or 1 kHz (selected by an internal jumper) modulation frequency, as controlled by the front panel Square Wave Modulation pushbutton. The RF Output may also be Amplitude or Frequency modulated by an external source via the Model 8350A Sweep Oscillator rear panel inputs.

### 1-39. Remote Programming (HP-IB)

1-40. All front panel controls, except the line power switch, may be controlled or programmed remotely via the rear panel HP-IB interface connector. The Model 8350A can also output to a controller an instrument state message that completely describes the current instrument status (sweep mode, trigger mode, etc.) and can supply the present numerical value of any function (sweep time, marker frequencies, power levels, START/STOP frequencies, etc.).

### 1-41. Other Features

1-42. The Model 8350A also provides RF output blanking during sweep retrace and rear panel positive and negative polarity display blanking outputs for retrace and bandswitching points of sweep. A rear panel PEN LIFT output generates a pulse which is coincident in time with the endpoints of the sweep. A COUNTER TRIGGER output and STOP SWEEP input are also available on the rear panel to interface with the HP Model 5343A Microwave Frequency Counter. A 25-pin rear panel Programming Connector provides additional control of and information on the Model 8350A instrument state. A listing of pin configuration and signals on the Programming Connector is given in Figure 2-7. Output signals on the Programming Connector supplement other rear panel output signals such as display and RF blanking, X-Y recorder penlift, and HP Model 8410B and HP Model 5343A interface signals. Input signals on the Programming Connector affect the sweep status, display and RF blanking, penlift outputs, etc.

1-43. To have a complete operating unit, the Model 8350A Sweep Oscillator must be used in conjunction with an RF plug-in unit which operates in the desired frequency range. The HP Model 83500 Series RF Plug-in units have been specifically designed for use with the Model 8350A. With the addition of the Model 11869A RF Plug-in Adapter, the HP Model 86200 Series RF Plug-ins may also be used with the Model 8350A.

### 1-44. OPTIONS

#### 1-45. Option 001, Nonvolatile Memory

1-46. Option 001 instruments contain a battery pack (inserted in the battery holder with a battery hold down clamp) and a special A3 Microprocessor board. With Option 001 installed, the Model 8350A has a nonvolatile memory which retains the contents of all instrument state storage registers, the current instrument state, and the HP-IB address. When fully charged, the batteries will retain a sufficient charge to hold the memory contents for approximately 20 days. The batteries are charged within the instrument and a full charge is maintained when the instrument LINE switch is ON.

1-47. An Option 001 Battery Kit may be ordered for standard Model 8350A Sweep Oscillators to upgrade them to Option 001 capability by ordering HP Part Number 08350-60013. This kit contains a battery pack, a battery pack hold down clamp, and a special A3 Microprocessor board. All other necessary wiring and hardware connections have been made at the factory on all standard instruments.

#### 1-48. Option 400, 400 Hz AC Power Operation

1-49. The standard Model 8350A requires that the ac power line frequency be 50 to 60 Hz. Option 400 allows the instrument to operate with a 400 Hz ac power line frequency.

#### 1-50. Option 907, Front Handles Kit

1-51. Option 907, HP Part Number 5061-0089, contains a pair of front handles and the necessary hardware for mounting the handles to the Model 8350A. Refer to Section II of this Operating and Service Manual for a detailed description of this kit and instructions for installation.

**1-52. Option 908, Rack Mount Kit**

1-53. Option 908, HP Part Number 5061-0077, contains a pair of flanges and the necessary hardware to mount the Model 8350A in an equipment rack with 482.6 mm (19 inches) horizontal spacing. Refer to Section II of this Operating and Service Manual for a detailed description of this kit and instructions for installation.

**1-54. Option 909, Rack Mount/Front Handles Kit**

1-55. Option 909, HP Part Number 5061-0083, contains one Option 907 Front Handles Kit and one Option 908 Rack Mount Kit (see descriptions in preceding paragraphs). Refer to Section II of this Operating and Service Manual for a detailed description of this kit and instructions for installation.

**1-56. Option 910, Extra Operating and Service Manual**

1-57. The standard instrument is supplied with one Operating and Service Manual. Each Option 910 provides one additional Operating and Service Manual. To obtain additional Operating and Service Manuals after initial shipment, order by manual part number, listed on the title page and rear cover of this manual.

**1-58. ACCESSORIES SUPPLIED**

1-59. Figure 1-1 shows the Model 8350A and power cable. The power cable supplied depends upon the country of destination. Refer to Section II of this manual for HP Part Number information.

**1-60. EQUIPMENT REQUIRED BUT NOT SUPPLIED**

1-61. To have a complete operating sweep oscillator, the Model 8350A Sweep Oscillator must have an RF plug-in unit installed. The HP 83500 Series RF Plug-ins have been specifically designed for use with the Model 8350A. They provide calibrated output power levels, calibrated power sweeps, internal leveling and slope control, and full HP-IB programmability. Economical use of the HP Model 86200 Series RF Plug-ins may be utilized with the Model 8350A with the addition of the HP Model 11869A RF Plug-in Adapter. The Model 11869A mounts at the rear of the Model

86200 Series RF Plug-in and provides the interface for signals and voltages from the Model 8350A to the RF plug-in. All of the Model 8350A standard operating features including HP-IB remote programming are available, however, specific RF plug-in functions (output power level, RF on/off, etc.) cannot be controlled or remotely programmed by the Model 8350A mainframe.

1-62. To use the HP-IB capabilities of the Model 8350A, a computing controller such as the HP 9825 Desktop Computer or the HP 85 Personal Computer is needed.

**1-63. EQUIPMENT AVAILABLE****1-64. Service Accessories**

1-65. A Service Accessory Kit (HP Part Number 08350-60020) is available for servicing the 8350A and 83500-series RF plug-ins. The accessory kit includes:

- Two 44-pin printed circuit board extenders. The HP Part Number for each extender is 08350-60031. These boards have keyed slots which allow them to be used in troubleshooting the Model 83500-series RF Plug-ins as well.
- An RF Plug-in extender cable set that provides all electrical connections when the RF Plug-in is removed from the sweep oscillator. The RF Plug-in Interface Connector is extended by one cable (HP Part Number 08350-60034) and the Power Supply Interface connector is extended by the other cable (HP Part Number 08350-60035).
- One hex Balldriver (HP Part Number 8710-0523). Used to remove the hold down plate hex screws from the front panel when repair is necessary.
- One 16-pin I.C. Test Clip (HP Part Number 1400-0734) and one 20-pin I.C. Test Clip (HP Part Number 1400-0979) are provided as an aid for probing Integrated Circuits when troubleshooting.

**1-66. Model 8410B/8411A Network Analyzer**

1-67. The Model 8350A Sweep Oscillator is compatible with the HP Model 8410B Network Analyzer system. The combination of the Model

8410B Network Analyzer, the Model 8411A Frequency Converter, and an appropriate display plug-in forms a phasemeter and a ratiometer for direct phase and amplitude ratio measurement on RF voltages. These measurements can be made on single frequencies and on swept frequencies from 110 MHz to 18 GHz. Several RF plug-in units for the Model 8350A are capable of multi-octave sweeps in this range. The Model 8410B has an Auto-Frequency range mode which gives it the capability of automatically tracking the Model 8350A Sweep Oscillator over octave and multi-octave frequency bands. Two interconnections to the Model 8350A are necessary to ensure that the Model 8410B will phase lock properly. The Model 8410B Source Control Cable (HP 08410-60146) connects the Model 8410B rear panel SOURCE CONTROL connector to the Model 8350A rear panel PROGRAMMING CONNECTOR. Additionally, the sweep oscillator RF plug-in 1V/GHz output connects to the Model 8410B rear panel FREQ REF INPUT. The Model 8410B Source Control Cable connector pins and signals are illustrated in Table 1-3.

**1-68. Model 8755 Frequency Response Test Set**

1-69. The Model 8350A Sweep Oscillator is compatible with the Model 8755 Frequency Response Test Set for broadband swept scalar

measurements. The Model 8350A provides internal 27.8 kHz square wave modulation of the RF output eliminating unnecessary cable connections to the Model 8755 or the use of an external modulator. The Model 8350A can also produce alternate sweeps through use of the ALT n function which works in conjunction with the channel switching circuits in the Model 8755C. This permits Channel 1 on the Model 8755C to respond only to the Model 8350A current state and Channel 2 to the alternate state. A single cable (HP Part Number 8120-3174) connects between the Model 8350A rear panel ALT SWP INTERFACE connector and the Model 8755C front panel ALT SWP INTERFACE connector.

**1-70. Power Meters and Crystal Detectors**

1-71. Depending upon the RF plug-in unit used, the RF output can be externally leveled using the HP Model 432 Power Meter or negative polarity output crystal detectors. Refer to the Operating and Service Manual of the specific RF plug-in used for detailed information on leveling systems that may be used with the Model 8350A/RF Plug-in combination.

**NOTE**

**The Model 435A and 436A Power Meters should not be used in Model 8350A external leveling systems.**

*Table 1-3. Model 8410B Source Control Cable*

8410B Source Control Cable - HP Part Number 08410-60146				
Mnemonic	Description	8350A Connector Pin (25-pin D Type Male HP Part No. 1251-0063)	8410B Connector Pin (14-pin Micro Ribbon Male HP Part No. 1251-0142)	Wire Color Code
L SSRQ	Low = Stop Sweep Request	18	7	905
SYNC TRG	High = Synchronizing Trigger	24	1	901
GND DIG	Digital Ground	19	11	90

Table 1-4. Recommended Test Equipment<sup>1</sup> (1 of 4)

Instrument	Critical Specifications	Recommended Model	Use <sup>2</sup>
Spectrum Analyzer	Frequency Range: 0.01 to 22 GHz Residual FM: $\leq 100$ Hz Must have auxiliary IF output when used with the HP 8901A Modulation Analyzer.	HP 8565A	P,T
Oscilloscope	Dual channel X vs. Y display mode Sensitivity: $\leq 0.1 \mu\text{S}/\text{DIV}$ Horizontal Sweep Rate: $\leq 0.1 \mu\text{S}/\text{DIV}$	HP 1740A	P
Display Mainframe	Compatible with HP 8755C Swept Amplitude Analyzer and HP 8750A Storage-Normalizer	HP 182T, 180TR	P
Swept Amplitude Analyzer	Capable of transmission measurements Power Resolution: $\leq 0.25 \text{ dB}/\text{DIV}$	HP 8755C	P
Detector	Compatible with Swept Amplitude Analyzer Frequency Range: 0.01 to 12.4 GHz Power Range: $-20$ to $+10 \text{ dBm}$	HP 11664A	P
Power Splitter	Frequency Range: 0.01 to 12.4 GHz Output Port Tracking: $\leq 0.25 \text{ dB}$ Maximum Input Power: $\geq +20 \text{ dBm}$	HP 11667A	P
Storage-Normalizer	Compatible with Display Mainframe and Swept Amplitude Analyzer	HP 8750A	P
Digital Voltmeter	Accuracy: $\leq 0.005\%$ Input Impedance: $\geq 10 \text{ M}\Omega$	HP 3455A	A,T
Universal Counter	Frequency Mode Frequency Range: $\geq 30 \text{ kHz}$ Frequency Resolution: $\leq 10 \text{ Hz}$ Time Period Mode Frequency Range: $\geq 20 \text{ kHz}$ Resolution: $\leq 50 \mu\text{S}$	HP 5328A	A
Oscilloscope Probe	1 : 1 General Purpose Probe	HP 10008B	A
Modulation Analyzer	(May be used in addition to Spectrum Analyzer) Frequency Range: Must cover auxiliary IF Output frequency of Spectrum Analyzer used Residual FM: $\leq 10 \text{ Hz}$	HP 8901A	P
Power Meter	Power Range: $-20$ to $+10 \text{ dBm}$ (No substitution when used for external power meter leveling).	HP 432A	P

Table 1-4. Recommended Test Equipment<sup>1</sup> (2 of 4)

Instrument	Critical Specifications	Recommended Model	Use <sup>2</sup>
Thermistor Sensor	Frequency Range: 0.01 to 12.4 GHz Maximum SWR: $\leq 1.75$	HP 8478B	P
Frequency Counter	Frequency Range: 0.01 to 12.4 GHz Sensitivity: $\leq -20$ dBm Maximum Input Power: $\geq 0$ dBm Frequency Accuracy: $\leq 1$ kHz	HP 5343A	P
Directional Coupler	Frequency Range: 0.1 to 2.0 GHz Nominal Coupling: $\geq 20$ dB Maximum Coupling Variation: $\leq \pm 1$ dB Minimum Directivity: $\geq 32$ db	HP 778D	P
Directional Coupler	Frequency Range: 2 to 12.4 GHz Mean Output Coupling: $\geq 20$ dB Output Coupling Variation: $\leq \pm 1$ dB Minimum Directivity: $\geq 26$ dB	HP 779D	P
RMS Voltmeter	dB Range: $-20$ to $-70$ dBm (0 dBm = 1 mW into 600 Ohms) Frequency Range: 10 Hz to 10 MHz Accuracy: $\pm 5\%$ of full scale	HP 3400A	P
Function Generator	Frequency Range: 0.1 Hz to 10 MHz Output Level: 10V p-p into 50 Ohms Output Level Flatness: $\leq \pm 3\%$ from 10 Hz to 100 kHz $\leq \pm 10\%$ from 100 kHz to 10 MHz	HP 3312A	P,T
Crystal Detector	Frequency Response: 0.01 to 12.4 GHz Maximum Input Power: $\geq 100$ mW	HP 423B	P
Air Line Extension (2 required)	Impedance: 50 Ohms Frequency Range: dc to 12.4 GHz Reflection Coefficient: 0.018 + 0.001 (times the frequency in GHz)	HP 11567A	P
RF Cable	Impedance: 50 Ohms Length: 61 cm (24 in.)	HP 11170B	P
Step Attenuator	Frequency Range: dc to 12.4 GHz Incremental Attenuation: 0 to 70 dB in 10 dB steps Calibration Accuracy: $\leq \pm 0.1$ dB at all steps	HP 8495A Option 890	P

Table 1-4. Recommended Test Equipment<sup>1</sup> (3 of 4)

Instrument	Critical Specifications	Recommended Model	Use <sup>2</sup>
Attenuator	Attenuation: 3 dB $\pm$ 0.5 dB Frequency Range: 0.01 to 12.4 GHz Maximum Input Power: $\geq$ +20 dBm	HP 8491B Option 003	P
Attenuator	Attenuation: 6 dB $\pm$ 0.5 dB Frequency Range: 0.01 to 12.4 GHz Maximum Input Power: $\geq$ +20 dBm	HP 8491B Option 006	P
Attenuator	Attenuation: 10 $\pm$ 0.5 dB Frequency Range: 0.01 to 12.4 GHz Maximum Input Power: $\geq$ +20 dBm	HP 8491B Option 010	P
Attenuator	Attenuation: 20 $\pm$ 0.5 dB Frequency Range: 0.01 to 12.4 GHz Maximum Input Power: $\geq$ +20 dBm	HP 8491B Option 020	P
Adjustable Short	Frequency Range: 1.8 to 12.4 GHz Impedance: 50 $\pm$ 1.5 Ohms	Maury Microwave <sup>3</sup> 1953-2	P
Adjustable AC Line Transformer	Select to cover line voltage used 100—120 volt	General Radio <sup>4</sup> W5MTB	P
	220—240 volt	General Radio W10HM73	P
Line Voltage Monitor	To be used with above Adjustable AC Line Transformers		
	120 volt Monitor 240 volt Monitor	RCA <sup>5</sup> 120B RCA WV 503A	P P
Frequency Meters	Frequency Accuracy: $\leq$ 0.17% Calibration Increments: $\leq$ 2 MHz Select to cover Frequency range of RF plug-in		
	0.96 to 4.2 GHz 3.7 to 12.4 GHz	HP 536A HP 537A	P P
Adapter	APC-7 to Type N(m)	HP 11525A	P
Adapter	APC-3.5(f) to Type N(m)	Amphenol <sup>6</sup> 131-7018	P
Delay Line Discriminator	Refer to Figure 1-3		P

Table 1-4. Recommended Test Equipment<sup>1</sup> (4 of 4)

Instrument	Critical Specifications	Recommended Model	Use <sup>2</sup>
PC Board Extender <sup>7</sup>	44-pin, extends printed circuit boards	HP Part Number 08350-60031 (each)	T
RF Plug-in Extender Cable	Extends RF Plug-in Interface Connector (J2)	HP Part Number 08350-60034	T
RF Plug-in Extender Cable	Extends RF Plug-in Power Supply Interface Connector (J3)	HP Part Number 08350-60035	T

<sup>1</sup>Refer to the Recommended Test Equipment list in the Operating and Service Manual of the RF plug-in used for a listing of equipment specifically relating to the RF plug-in used. Not all equipment included in this list is necessary for all RF plug-ins.

<sup>2</sup>P=Performance Test; A=Adjustments; T=Troubleshooting

<sup>3</sup>Mauray Microwave Corp., 8610 Helms Ave., Cucamonga, CA 91730

<sup>4</sup>General Radio, 300 Baker Avenue., Concord, MA 01742

<sup>5</sup>RCA Distribution & Special Products Div., Dept. EM, New Holland Ave., Lancaster, PA 17604

<sup>6</sup>Amphenol North America, Bunker-Ramo Corp., RF Operations, 33 E. Franklin St., Danbury, CT 06810

<sup>7</sup>Two 44-pin printed circuit board extenders and a fuse kit are included with the Model 8350A Accessory Kit Supplied (HP Part Number 08350-60020). Refer to Figure 1-1 in this manual.

## 1-72. RECOMMENDED TEST EQUIPMENT

1-73. Equipment required for testing and adjustment of the instrument is listed in Table 1-4. Other equipment may be substituted if it meets or exceeds the critical specifications indicated in the table.

## 1-74. HEWLETT-PACKARD INTERFACE BUS. (HP-IB)

1-75. The Model 8350A is factory equipped with

a remote programming interface using the Hewlett-Packard Interface Bus (HP-IB). This provides a remote operator with the same control of the instrument available to a manual (local) operator. Remote control is maintained by a system controller (desktop computer, computer, etc.) that sends commands or instructions to and receives data from the Model 8350A using the HP-IB. The HP-IB is Hewlett-Packard's implementation of the IEEE Standard 488-1978. A complete general description of the HP-IB is provided in the manual entitled "Condensed Description of the Hewlett-Packard Interface Bus" (HP Part Number 59401-90030).

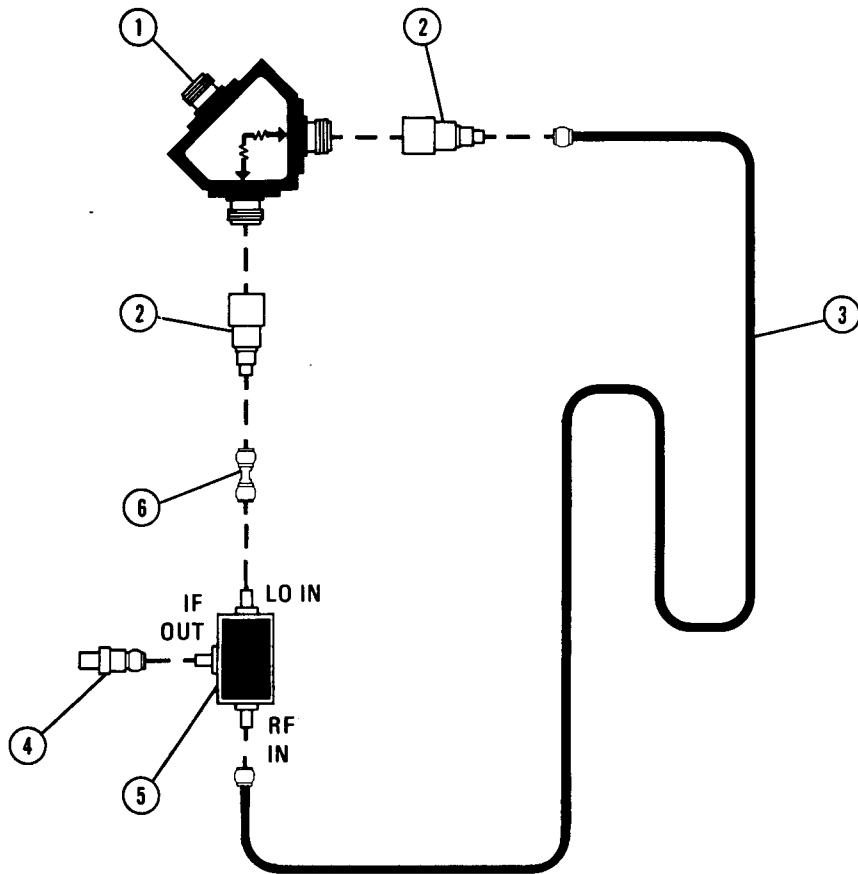

Item	Description	HP Part Number
1	Power Splitter	HP 11667A
2	Adapter: Type N Male to SMA Female (2 required)	1250-1250
3	Delay Line: >1 meter (3 feet) in length, SMA male connectors	08350-20038
4	Adapter: BNC Female to Male SMA	1250-1200
5	Mixer: Double Balanced 1 to 12 GHz: RHG Electronics Part No. DM 1-12 1 to 18 GHz: RHG Electronics Part No. DM 1-18  RHG Electronics Laboratories, Inc. Deer Park, NY 11729	0960-0451  None
6	Adapter: SMA Male to SMA Male	1250-1159

Figure 1-3. Delay Line Discriminator



## SECTION II INSTALLATION

### 2-1. INTRODUCTION

2-2. This section provides installation instructions for the Model 8350A Sweep Oscillator and its accessories. This section also includes information about initial inspection and damage claims, preparation for use, and packaging, storage, and shipment.

### 2-3. INITIAL INSPECTION

2-4. Inspect the shipping container for damage. If the shipping container or cushioning material is damaged, it should be kept until the contents of the shipment have been checked for completeness and the instrument has been checked mechanically and electrically. The contents of the shipment should be as shown in Figure 1-1. Procedures for checking electrical performance are given in Section IV, Performance Tests, of this manual. If the instrument combination does not pass the electrical Performance Tests, refer to Section V, Adjustments, of this manual. If, after the adjustments have been made, the instrument combination still fails to meet specifications, refer to Section V, Adjustments, of the Operating and Service Manual for the RF plug-in being used. If a circuit malfunction is suspected, refer to troubleshooting procedures in Section VIII, Service, of this or the RF plug-in manual. If the instrument does not pass the above electrical tests, if the shipment contents are incomplete, or if there is mechanical damage or defect, notify the nearest Hewlett-Packard office. If the shipping container is damaged, or if the cushioning material shows signs of stress, notify the carrier as well as the Hewlett-Packard office. Keep the shipping materials for carrier's inspection. The HP office will arrange for repair or replacement without waiting for claim settlement.

### 2-5. PREPARATION FOR USE

#### 2-6. Power Requirements

2-7. The Model 8350A Sweep Oscillator requires a power source of 100, 120, 220, or 240 Vac, +5% to -10%, 50 to 60 Hz, single-phase (50 to 400 Hz, single-phase for Option 400 instruments). Power consumption is approximately 270 volt-amperes, depending upon the specific RF plug-in unit used.

#### 2-8. Line Voltage and Fuse Selection

2-9. Figure 2-1 illustrates the line voltage selection card and fuse location in the Power Line Module on the rear panel of the Model 8350A. Select the line voltage and fuse as follows:

- a. Measure the ac line voltage.
- b. Refer to Figure 2-1. At the instrument rear panel power line module, select the line voltage (100, 120, 200, or 220 volts) closest to the voltage you measured in step a. Note the available line voltage must be within +5% or -10% of the line voltage selection as shown in Table 2-1. If it is not, you must use an autotransformer between the power source and the Model 8350A.

Table 2-1. Line Voltage/Fuse Selection

Measured ac Line Voltage	PC Selector Board Position	Fuse/ HP Part Number
90 to 105 volts	100	4.0A 2110-0055
108 to 126 volts	120	4.0A 2110-0055
198 to 231 volts	220	2.0A 2110-0002
216 to 252 volts	240	2.0A 2110-0002

- c. Make sure the correct fuse is installed in the fuse holder. The required fuse rating for each line voltage is indicated in Table 2-1 and below the power line module on the rear panel of the Model 8350A.

**CAUTION**

To prevent damage to the instrument, make the correct line voltage and fuse selection before connecting line power to the instrument.

**2-10. Power Cable**

2-11. In accordance with international safety standards, this instrument is equipped with a three-wire power cable. When connected to an appropriate power line outlet, this cable grounds the instrument cabinet. Table 2-2 shows the styles of plugs available on power cables supplied with HP instruments. The HP Part Numbers for the plugs are part numbers for the complete power

cables. The type of power cable/plug shipped with the instrument depends upon the country of destination.

**WARNING**

Before switching on this instrument, be sure that only the specified power cable is used. The instrument is provided with a three-wire power cord which grounds the instrument cabinet. This power cord should only be inserted in a socket outlet provided with a protective earth contact. This protective action should not be negated by the use of an extension cord (power cable) without a protective conductor (ground). Grounding one conductor of a two-conductor outlet is not sufficient protection.

2-12. The offset pin of the three-prong connector is the grounding pin. When operating the Model 8350A from a two-contact outlet, the protective grounding feature may be preserved by using a three-prong to two-prong adapter (USA connectors only, HP Part Number 1251-0048) and connecting the green wire of the adapter to ground.

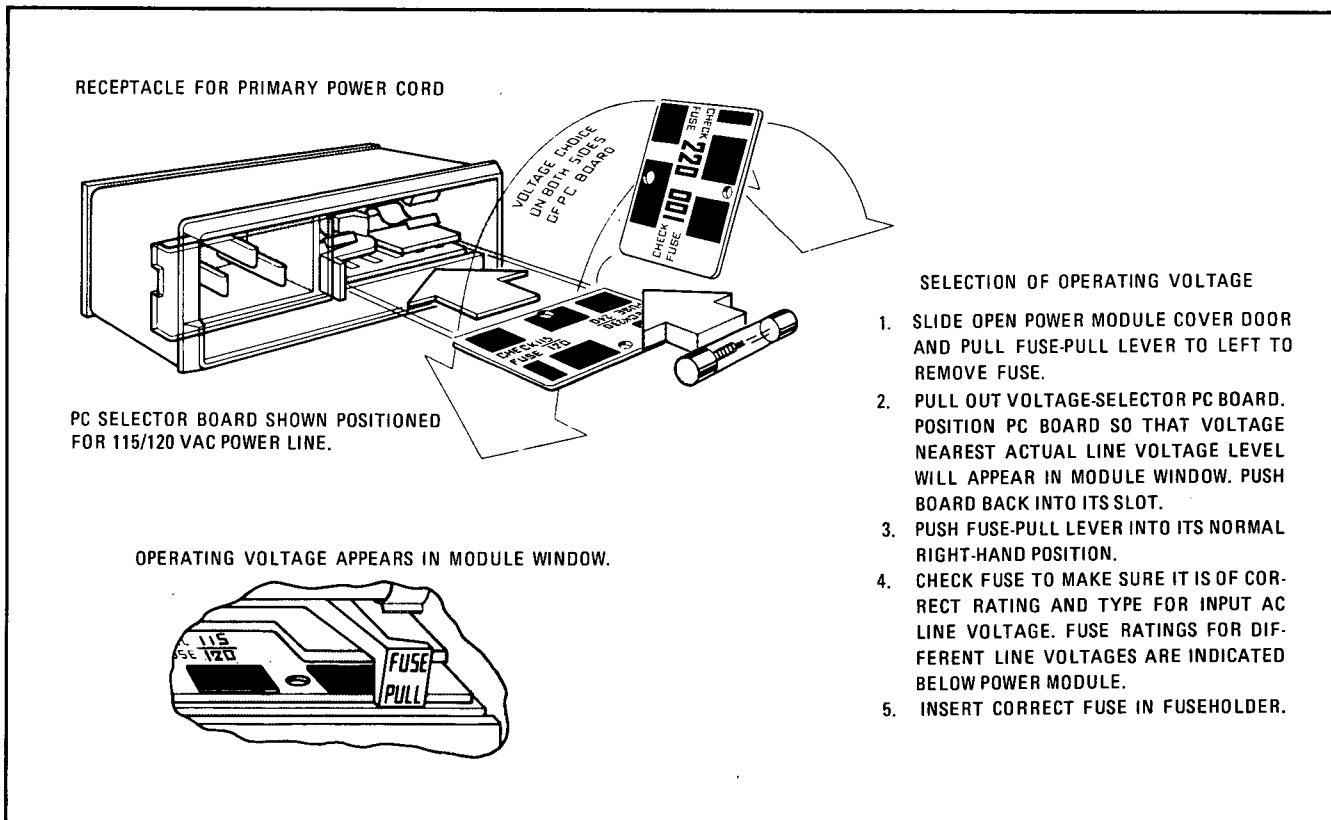
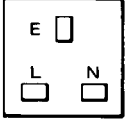
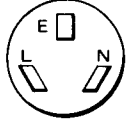
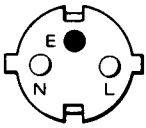
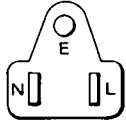
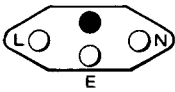
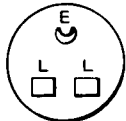
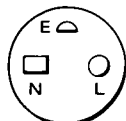
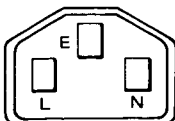

Figure 2-1. Power Line Module

Table 2-2. AC Power Cables Available

Plug Type	Cable HP Part Number	C D	Plug Description	Cable Length (inches)	Cable Color	For Use In Country
<b>250V</b> 	8120-1351 8120-1703	0 6	Straight*BS1363A 90°	90 90	Mint Gray Mint Gray	United Kingdom, Cyprus, Nigeria, Rhodesia, Singapore
<b>250V</b> 	8120-1369 8120-0696	0 4	Straight*NZSS198/ASC112 90°	79 87	Gray Gray	Australia, New Zealand
<b>250V</b> 	8120-1689 8120-1692	7 2	Straight*CEE7-Y11 90°	79 79	Mint Gray Mint Gray	East and West Europe, Saudi Arabia, Egypt So. Africa, India (unpolarized in many nations)
<b>125V</b> 	8120-1348 8120-1398 8120-1754 8120-1378 8120-1521 8120-1676	5 5 7 1 6 2	Straight*NEMA5-15P 90° Straight*NEMA5-15P Straight*NEMA5-15P 90° Straight*NEMA5-15P	80 80 36 80 80 36	Black Black Black Jade Gray Jade Gray Jade Gray	United States, Canada, Japan (100V or 200V), Mexico, Philippines, Taiwan
<b>250V</b> 	8120-2104	3	Straight*SEV1011 1959-24507 Type 12	79	Gray	Switzerland
<b>250V</b> 	8120-0698	6	Straight*NEMA6-15P			United States, Canada
<b>220V</b> 	8120-1957 8120-2956	2 3	Straight*DHCK 107 90°	79 79	Gray Gray	Denmark
<b>250 V</b> 	8120-1860	6	Straight*CEE22-VI (Systems Cabinet use)			

\*Part number shown for plug is industry identifier for plug only. Number shown for cable is HP Part Number for complete cable including plug.  
E = Earth Ground; L = Line; N = Neutral

## 2-13. HP-IB Address Selection

### WARNING

The HP-IB address switch is set with the top cover removed from the Model 8350A and should be set only by a skilled person who is aware of the hazard involved. Prior to setting the HP-IB address switch, the LINE switch should be set to OFF and the power cord should be disconnected from the ac power source for maximum safety. Capacitors inside the instrument may still be charged even when the instrument is disconnected from its ac power source. Use caution when setting the HP-IB address switch to avoid touching assemblies or components within the instrument other than the HP-IB address switch.

2-14. When the Model 8350A is used under remote control with the HP-IB, the controller on the bus refers to the Model 8350A by an HP-IB "address". The Model 8350A is differentiated from any other instrument on the bus by its own unique address. This HP-IB address is initially preset in

the Model 8350A by a 5-segment address switch A8S1, located on the A8 HP-IB Interface assembly, as shown in Figure 2-2. A diagram of A8S1 is given in Figure 2-3. Each of the 5 switches corresponds to one of the digits of the 5-digit binary equivalent of the address, as shown in Table 2-3. A8S1 switch A1 corresponds to the Least Significant Bit (LSB) of the binary address and switch A5 corresponds to the Most Significant Bit. The HP-IB address can be modified by a front panel SHIFT function.

2-15. Thirty-one different address codes are available (decimal 0 to 30). The Model 8350A is shipped from the factory preset to binary address "10011" (decimal 19), as shown in Figure 2-3. In all standard Model 8350A instruments, the HP-IB address will be read by the processor from the HP-IB address switch A8S1 upon initial power on only. This HP-IB address will remain in effect until the address is changed by modifying the A8S1 switch pattern (and turning the LINE switch OFF and ON) or by resetting the address through the front panel SHIFT LOCAL function. The HP-IB address can be read directly from the front panel by pressing SHIFT LCL. The current HP-IB address is then displayed in decimal form on the FREQUENCY/TIME display. If the HP-IB

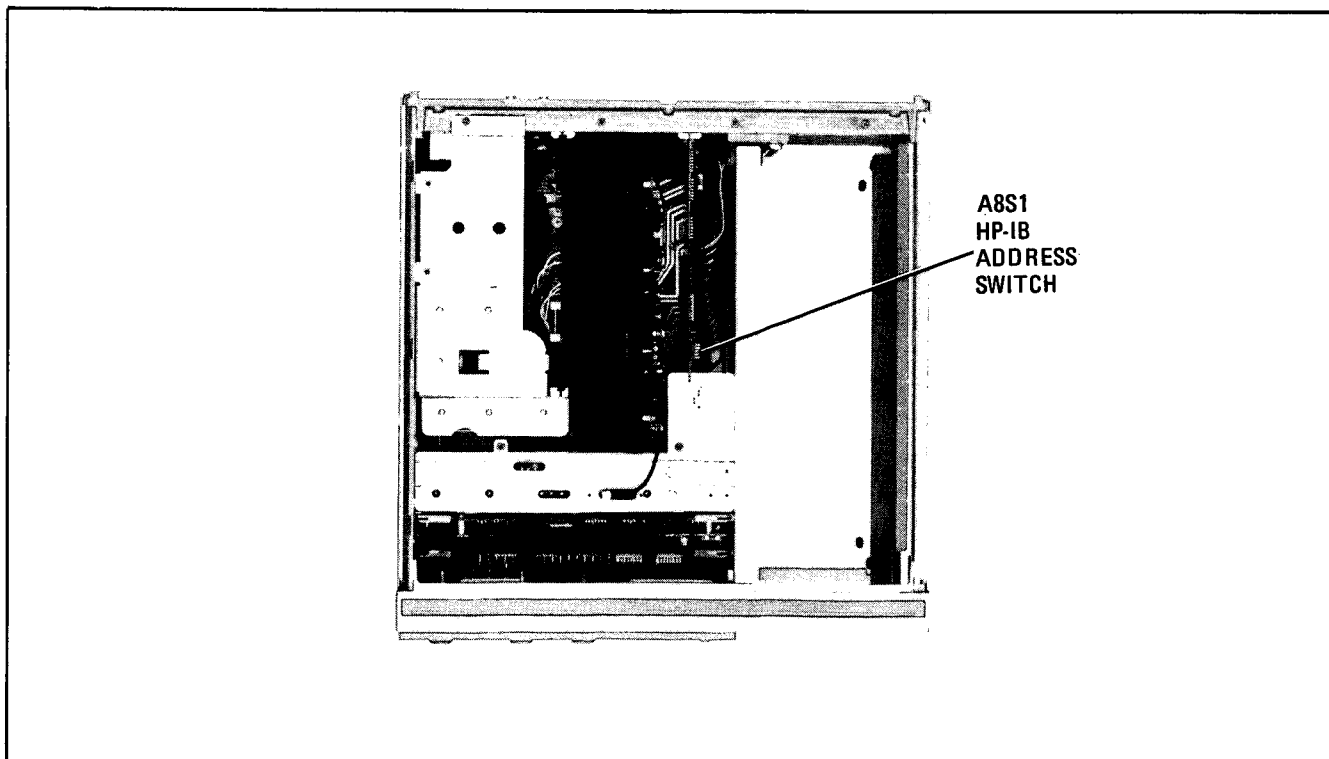

Figure 2-2. Location of A8S1 HP-IB Address Switch

address must be changed from that which is displayed, enter the new decimal equivalent of the desired HP-IB address and press **GHz** to terminate the entry. The **FREQUENCY/TIME** display should now display the new HP-IB address. This address will remain in effect until the Model 8350A **LINE** switch is turned **OFF**. When the instrument **LINE** switch is set to **ON** once again, the HP-IB address will revert back to the **A8S1** address switch setting. An **INSTRUMENT PRESET** command will not modify the current HP-IB address setting.

2-16. Option 001 Model 8350A instruments contain a battery supported memory and a special **A3** Microprocessor board. The battery option allows the instrument memory to retain the assigned HP-IB address when the instrument is turned off, regardless of the **A8S1** address switch setting. Upon initial power on, the HP-IB address will need to be set to the desired code through the front panel **SHIFT LOCAL** function. The address will be retained as long as the battery is charged to a sufficient level. Refer to the **Battery Operation (Option 001)** paragraph in this section of the manual further information on Option 001 instruments.

2-17. HP-IB address labels are available by

ordering HP Part Number 7120-6853 (each). (See Figure 2-4). These labels allow easy reference to the HP-IB address of each system component.

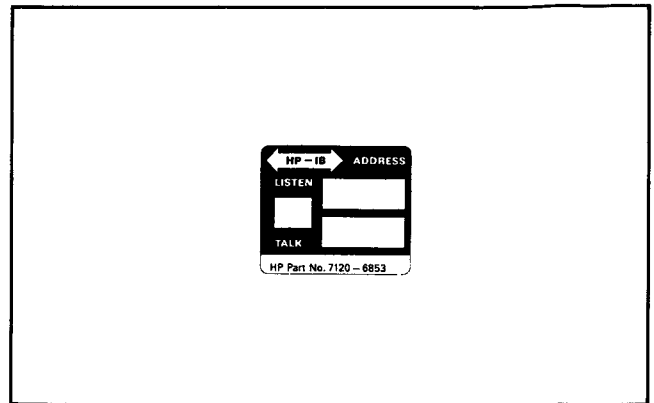

Figure 2-4. HP-IB Address Label

**2-18. 11869A Switch Settings for HP 86200 Series RF Plug-ins**

2-19. The identification switch on the Model 11869 RF Plug-in Adapter must be preset when using the adapter with HP 86200 Series RF Plug-ins in the Model 8350A. The setting of the identification switch is interrogated at power on, when the 8350A **INSTR PRESET** button is pressed, or when an HP-IB Instrument Preset

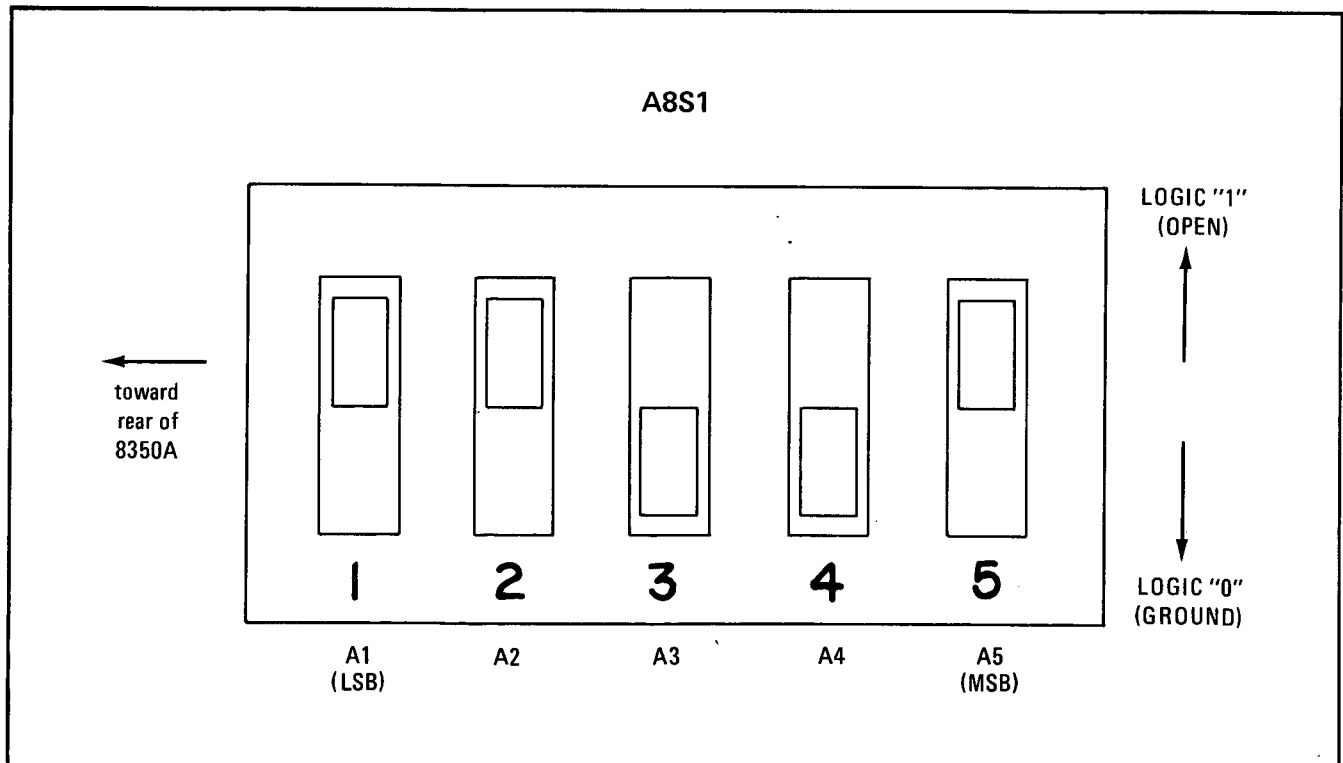

Figure 2-3. A8S1 HP-IB Address Switch

Table 2-3. HP-IB Address Codes

Address Characters		A8S1 Address Switch Settings					Address
Listen	Talk	(MSB)		(LSB)			Decimal Equivalent
		A5	A4	A3	A2	A1	
SP	@	0	0	0	0	0	0
!	A	0	0	0	0	1	1
”	B	0	0	0	1	0	1
#	C	0	0	0	1	1	3
\$	D	0	0	1	0	0	4
%	E	0	0	1	0	1	5
&	F	0	0	1	1	0	6
'	G	0	0	1	1	1	7
(	H	0	1	0	0	0	8
)	I	0	1	0	0	1	9
*	J	0	1	0	1	0	10
+	K	0	1	0	1	1	11
,	L	0	1	1	0	0	12
-	M	0	1	1	0	1	13
.	N	0	1	1	1	0	14
/	O	0	1	1	1	1	15
0	P	1	0	0	0	0	16
1	Q	1	0	0	0	1	17
2	R	1	0	0	1	0	18
3	S	1	0	0	1	1	19
4	T	1	0	1	0	0	20
5	U	1	0	1	0	1	21
6	V	1	0	1	1	0	22
7	W	1	0	1	1	1	23
8	X	1	1	0	0	0	24
9	Y	1	1	0	0	0	25
:	Z	1	1	0	1	0	26
;	[	1	1	0	1	1	27
<	/	1	1	1	0	1	28
=	]	1	1	1	0	1	29
>	^	1	1	1	1	0	30

(“IP”) command is received. If the identification switch is set incorrectly, the START/STOP frequencies will be in error. Refer to Section II, Installation, of the Model 11869A Operating and Service Manual for instructions to properly set the identification switch.

## 2-20. Internal Square Wave Modulation Frequency Selection

2-21. Internal square wave modulation is available at all sweep speeds on the Model 8350A. Internal square wave modulation is selected by the front panel  MOD pushbutton. Modu-

lation frequency is selectable by an internal jumper to be either 27.8 kHz (preset at the factory for use with Model 8755 Swept Amplitude Analyzer systems) or 1 kHz. Refer to Section V Adjustments in this manual for detailed information on how to select and adjust the internal square wave modulation frequency.

## 2-22. RF Plug-in Configuration Switch

2-23. Each RF plug-in may have a configuration switch which must be preset prior to operation in the Model 8350A. This is a multiple switch with individual switches that correspond to various RF

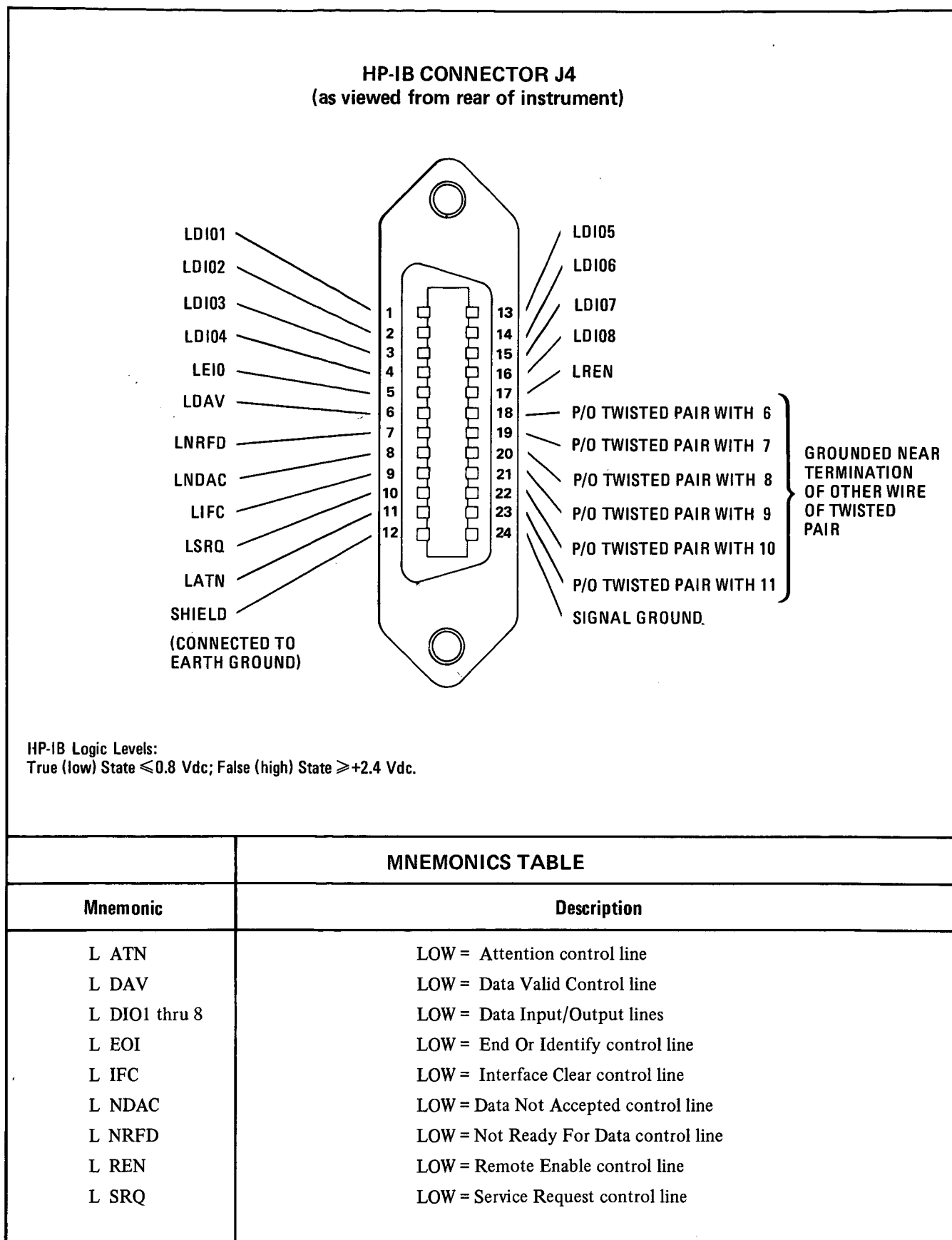

Figure 2-5. HP-IB Connector Signals and Pin Configuration

plug-in functions such as FM sensitivity selection, FM input coupling selection (direct coupled or cross-over), RF power level at instrument power on, and Option 002 Step Attenuator operation. Refer to the Operating and Service Manual of the specific RF plug-in used for detailed information on the configuration switch.

**2-24. Interconnections**

2-25. There are two RF plug-in interconnections on the Model 8350A Sweep Oscillator mainframe. These are the RF Plug-in Interface Connector (J2) and the Power Supply Interface Connector (J3). J2 and J3 are visible at the rear of the RF plug-in channel. A complete listing of pins and the associated signals and voltages for these connectors are listed on the overall instrument Wiring List in Section VIII, Service, of this manual.

**2-26. Mating Connectors**

2-27. All of the externally mounted connectors on the Model 8350A are listed in Table 2-4. Opposite each mainframe connector is an industry identification, the HP part number of a mating connector, and the part number of an alternate source for the mating connector. For HP part numbers of the externally mounted connectors themselves, refer to Section VI, Replaceable Parts, of this manual.

**2-28. HP-IB Interface Connector and Cables**

2-29. The HP-IB Interface Connector J4, located on the rear panel of the Model 8350A, allows the sweep oscillator to be connected to any other device on the HP-IB Interface Bus. A complete illustration of pin configuration and signals on the HP-IB Interface connector is given in Figure 2-5.

2-30. All instruments on the HP-IB Interface Bus are interconnected by HP-IB Interface Cables. A list of the available HP-IB Interface Cables and their part numbers is given in Figure 2-6. As many as 15 instruments can be connected in parallel on the HP-IB Interface Bus. To achieve design performance on the bus, proper voltage levels and timing relationships must be maintained. If the system cable is too long or if the accumulated cable length between instruments is too long, the data and control lines cannot be driven properly and the system may fail to perform. Therefore, the following restrictions must be observed:

- a. With two instruments in a system, the cable length must not exceed 4 meters (12 feet).
- b. When more than two instruments are connected on the bus, the cable length to each instrument must not exceed 2 meters (6 feet) per unit.
- c. The total cable length between all units cannot exceed 20 meters (65 feet).

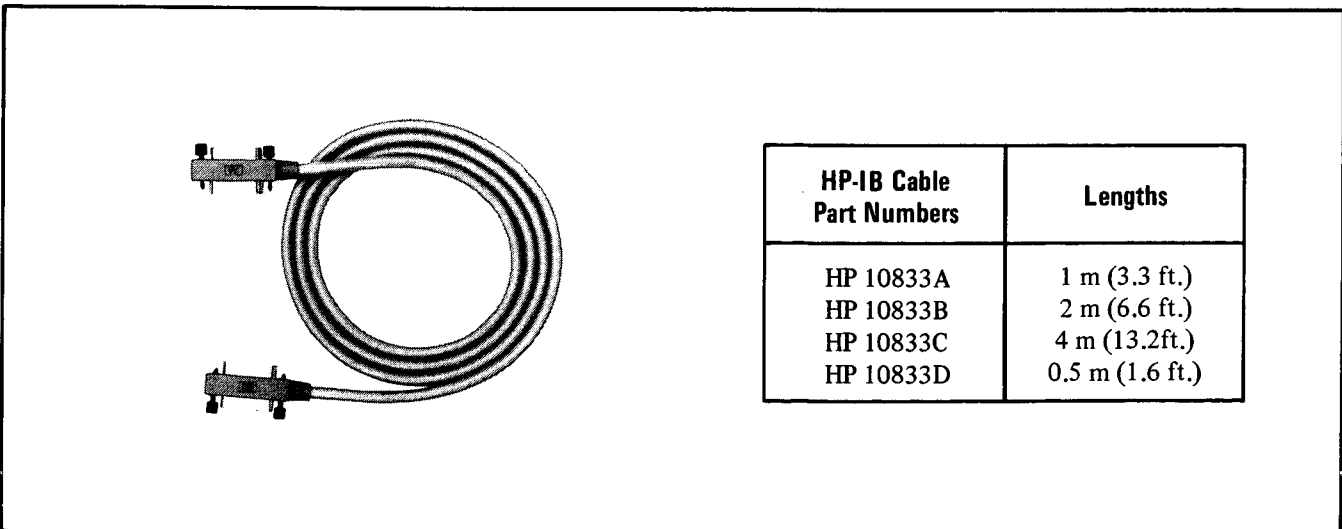

Figure 2-6. HP-IB Interface Cables Available



Table 2-4. Model 8350A Mating Connectors

8350A Connector		Mating Connector	
Connector Name	Industry Identification	HP Part Number	Alternate Source
J1 SWEEP OUTPUT/ SWEEP INPUT (front panel)	BNC	1251-0256	Specialty Connector 25-P118-1
J4 HP-IB INTERFACE BUS*	24-Pin Micro Ribbon	1251-0293	Amphenol 57-30240
J5 POS Z BLANK	BNC	1250-0256	Specialty Connector 25-P118-1
J6 NEG Z BLANK	BNC	1250-0256	Specialty Connector 25-P118-1
J7 PEN LIFT	BNC	1250-0256	Specialty Connector 25-P118-1
J8 SWEEP OUT/IN (rear panel)	BNC	1250-0256	Specialty Connector 25-P118-1
J9 CNTR TRIG	BNC	1250-0256	Specialty Connector 25-P118-1
J10 STOP SWEEP	BNC	1250-0256	Specialty Connector 25-P118-1
J11 FM INPUT	BNC	1250-0256	Specialty Connector 25-P118-1
J12 AM INPUT	BNC	1250-0256	Specialty Connector 25-P118-1
J13 PROGRAMMING CONNECTOR	25-Pin D Series	1251-0063	ITT Cannon DBM-25P
J14 ALT SWP INTERFACE**	Audio 3-Pin Connector	no HP Part Number	Switchcraft TA-3F

\*Refer to Figure 2-6 for HP-IB Interface Cable information. HP-IB Interface connector J4 signals and pin configuration are given in Figure 2-5.

\*\* A 1219 mm (48") cable assembly with a Switchcraft TA-3F Audio 3-Pin connector on each end is supplied with the Model 8755C Swept Amplitude Analyzer as the Alternate Sweep Interface Cable. The complete cable may be ordered separately as HP Part Number 8120-3174.

### 2-31. Programming Connector

2-32. The Programming Connector J13 on the rear panel of the Model 8350A provides digital control of display functions and sweep oscillator Step Up control. Figure 2-7 gives a description of all pins and signals available on the Programming Connector. When the Model 8410B/8411A Network Analyzer is used with the Model 8350A, the Model 8410B Source Control Cable (HP Part Number 08410-60146) connects the Model 8410B rear panel SOURCE CONTROL and the Model 8350A rear panel PROGRAMMING CONNECTOR. Additionally, the sweep oscillator RF plug-in 1V/GHz output connects to the Model 8410B rear panel FREQ REF INPUT to insure that the Model 8410B phase locks with the sweep oscillator properly when sweeping octave or multi-octave bands. The Model 8410B Source Control Cable connector pins and signals are illustrated in Table 1-3 of this manual.

### 2-33. Operating Environment

2-34. **Temperature.** The instrument may be operated in temperatures from 0°C to +55°C.

2-35. **Humidity.** The instrument may be operated in environments with humidity from 5% to 80% relative at +25°C to +40°C. However, the instrument should also be protected from temperature extremes which cause condensation within the instrument.

2-36. **Altitude.** The instrument may be operated at altitudes up to 4572 meters (approximately 15,000 feet).

2-37. **Cooling.** Clearances for ventilation should be at least 10 cm (4 inches) at the rear of the cabinet and 7.6 cm (3 inches) at the sides. The clearances provided by the plastic feet in bench stacking and the filler strips in rack mounting are adequate for the top and bottom cabinet surfaces. A diagram illustrating the path for cooling airflow generated by the rear panel fan is given in Figure 2-8. Insure that the air intake and exhaust venting holes are not obstructed within the limits shown in Figure 2-8.

### 2-38. RF Plug-in Installation

2-39. To operate as a completely functional sweep oscillator, the Model 8350A Sweep Oscil-

lator must have an RF plug-in unit installed. To install an HP 86200 Series RF plug-in (coupled to a Model 11869A RF Plug-in Adapter) in the Model 8350A, refer to Section II, Installation, in the Model 11869A Operating and Service Manual. To install an HP 83500 Series RF plug-in unit into the Model 8350A mainframe:

- a. Set the Model 8350A mainframe LINE switch to OFF.
- b. Remove all connectors and accessories from the front and rear panel connectors to prevent them from being damaged.
- c. Position the RF plug-in unit latching handle in the fully raised position. The latching handle should spring easily into the raised position and be held by spring tension.
- d. Insure that the mainframe RF plug-in channel is clear, align the RF unit in the channel and slide it carefully into place towards the rear of the channel. It should slide easily without binding.
- e. The drawer latch handle slot will engage with the locking pin just before the RF plug-in is fully seated in position.
- f. Press the latch handle downward, while still pushing in on the RF plug-in, until the drawer latch is fully closed and the front panel of the RF plug-in is aligned with the mainframe front panel.

### 2-40. Bench Operation

2-41. The instrument cabinet has plastic feet and a foldaway tilt stand for convenience in bench operation. The tilt stand inclines the instrument for ease of operating the front panel controls and to allow the RF plug-in to be removed easier. The plastic feet provide clearance for air circulation and make the instrument self-aligning when stacked on other Hewlett-Packard full rack-width modular instruments. The instrument is packaged at the factory with two shipping bars attached to the front sides (refer to Figure 2-12). If the instrument does not include front handle or rack mount options, replace the shipping bars with the self-adhesive trim strips supplied with the instrument.

**PROGRAMMING CONNECTOR J13**  
(as seen from rear panel)

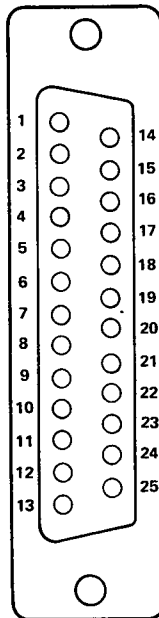

Logic Levels:\*

Low  $\leq 0.8$  Vdc  
High  $\geq 2.4$  Vdc

Control of input lines can be accomplished by contact closure to ground for a logic low level and open circuit for a logic high level.

Pin	Mnemonic	Description	In/Out
1		NO CONNECTION	
2	L MP	LOW = MARKER PULSE	OUTPUT
3	L PLRQ	LOW = PENLIFT REQUEST	INPUT
4	ALT1	ALTERNATE SWEEP 1	OUTPUT
5	L SFSRQ	LOW = STOP FORWARD SWEEP REQUEST	INPUT
6	+5VA	+5 VOLTS (100 ma MAX)	OUTPUT
7	L RFB	LOW = RF BLANK	OUTPUT
8	L RF BRQ	LOW = RF BLANK REQUEST	INPUT
9	EXT TRG	HIGH = EXTERNAL TRIGGER SWEEP	INPUT
10	PL	HIGH = PENLIFT	OUTPUT*
11	L MUTE	LOW = PEN MUTE FOR X-Y RECORDER	OUTPUT
12		NO CONNECTION	
13		NO CONNECTION	
14	L BP1	LOW = BLANKING PULSE 1	OUTPUT
15	L MRKQ	LOW = MARKER REQUEST	INPUT
16	L RTS	LOW = RETRACE STROBE	OUTPUT
17	L ALTE	LOW = ALTERNATE SWEEP ENABLE	OUTPUT
18	L SSRQ	LOW = STOP SWEEP REQUEST	INPUT
19	GND DIG	DIGITAL GROUND	
20	L BPRQ	LOW = BLANKING PULSE REQUEST	INPUT
21	L CNTR	LOW = COUNTER TRIGGER	OUTPUT
22	L STPADV	LOW = STEP ADVANCE	INPUT
23	L PL	LOW = PENLIFT	OUTPUT
24	SYNC TRG	HIGH = SYNCHRONIZING TRIGGER	OUTPUT
25		NO CONNECTION	

\* OPEN COLLECTOR OUTPUT

Figure 2-7. Programming Connector Signals and Pin Configuration

**2-42. Front Handles (Option 907)**

**CAUTION**

When installing front handles and rack mount kits, insure that the correct screws, specified in the installation figures in this section of the manual, are used. Use of a screw which is longer than the specified length may result in damage to internal components located behind the screw mounting holes in the instrument.

2-43. Instruments with Option 907 contain a Front Handle Kit. This kit supplies the necessary hardware and installation instructions for mounting two front handles on the instrument. Installation instructions are also given in Figure 2-9.

Additional Option 907 Kits may be ordered as HP Part Number 5061-0089.

**2-44. Rack Mounting (Option 908)**

2-45. Instruments with Option 908 contain a Rack Mount Kit. This kit supplies the necessary hardware and installation instructions for preparing the instrument to mount on an equipment rack with 482.6 mm (19 in.) support spacing. Installation instructions are also given in Figure 2-10. Additional Option 908 Kits may be ordered as HP Part Number 5061-0077.

**2-46. Rack Mounting with Front Handles (Option 909)**

2-47. Instruments with Option 909 contain a

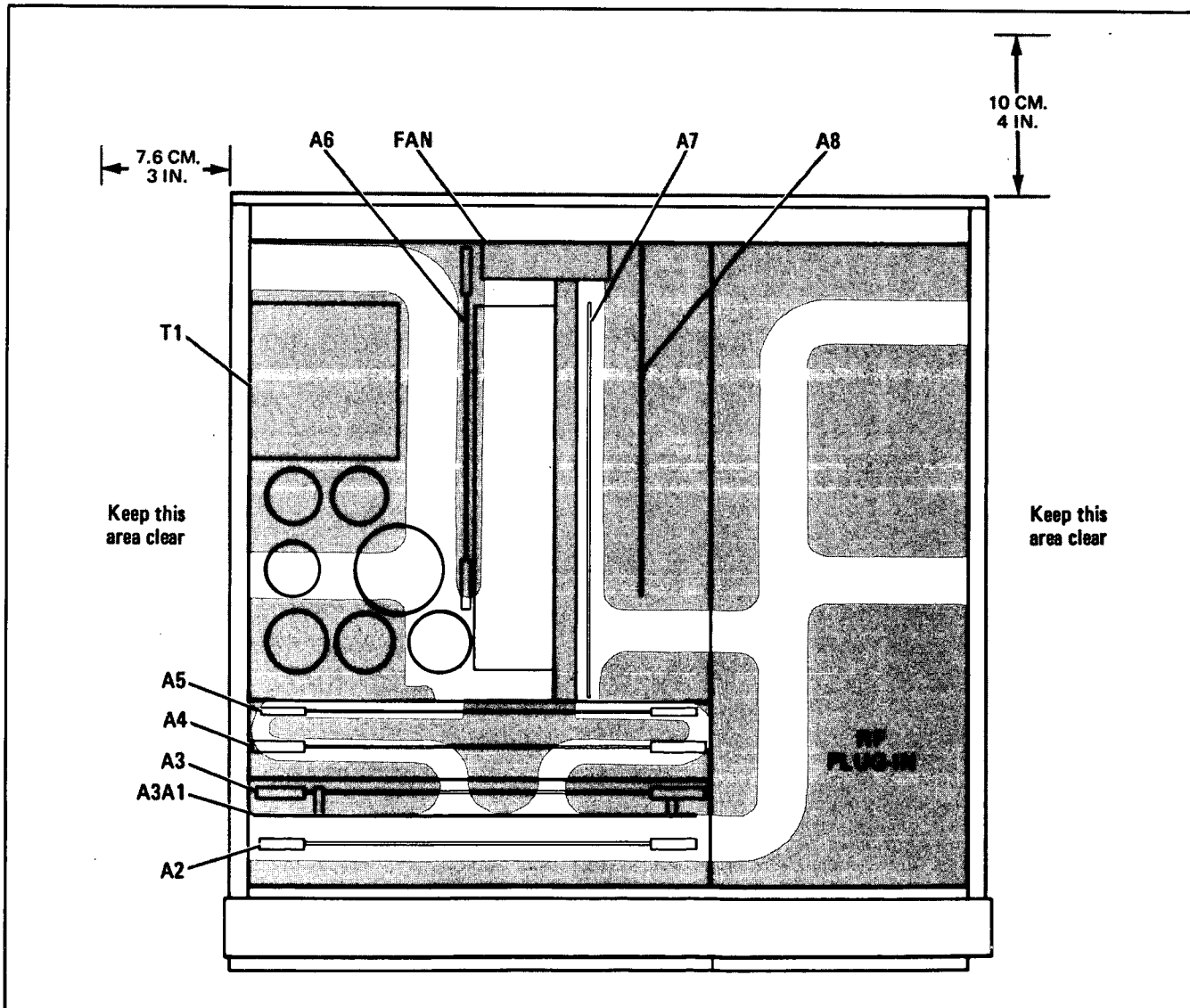
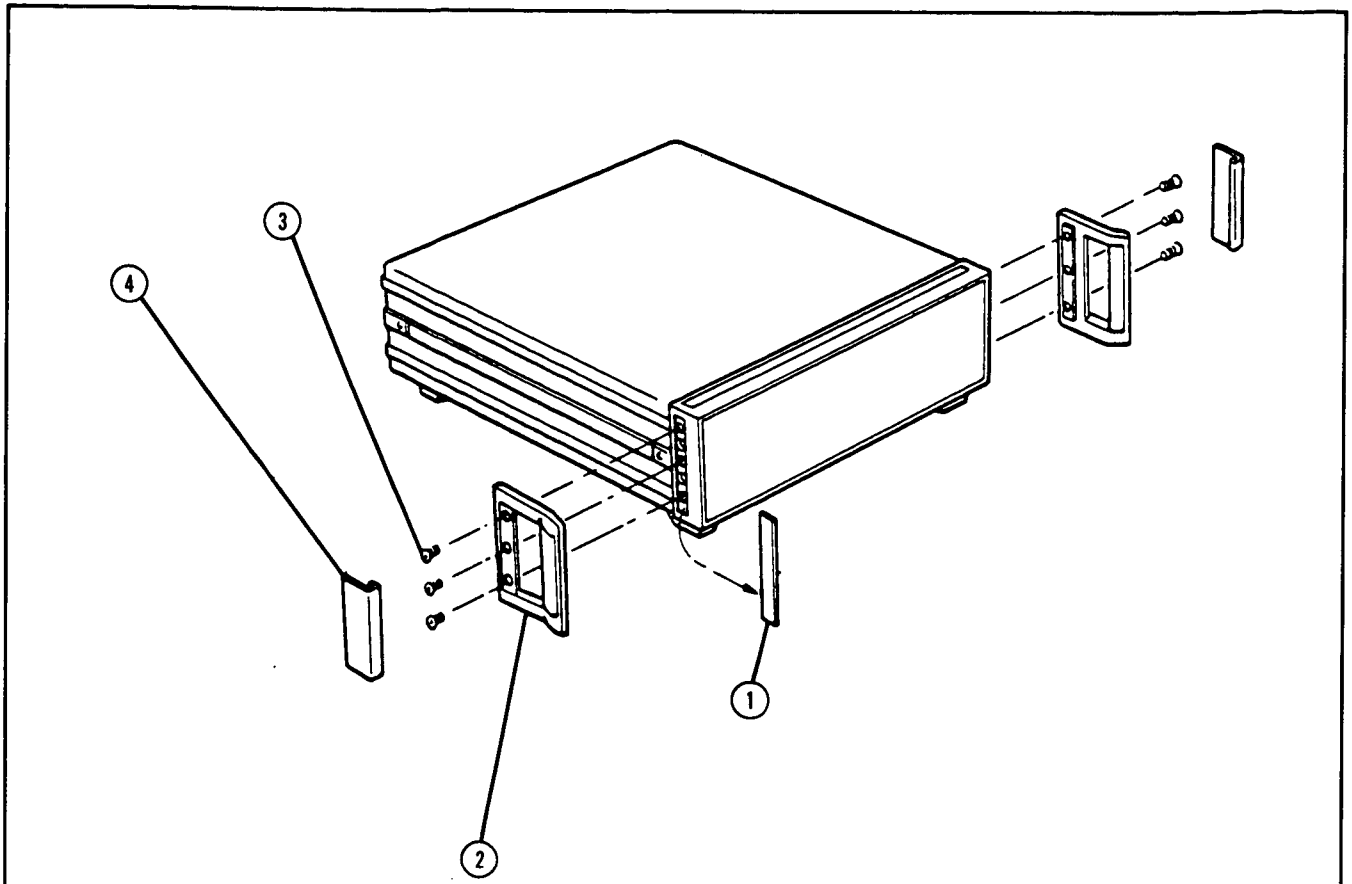

Figure 2-8. Model 8350A Ventilation Clearances and Airflow



INSTALLATION INSTRUCTIONS:

1. REMOVE SIDE TRIM STRIPS ① .
2. ATTACH FRONT HANDLE ASSEMBLY ② WITH THREE #8-32 x 3/8 SCREWS ③ PER SIDE.
3. PRESS FRONT HANDLE TRIM ④ IN PLACE.

OPTION 907 (HP Part No. 5060-0089) CONTENTS

Item	Qty.	HP Part No.	C D	Description
2	2	5060-9899	6	Front Handle Assembly
3	6	2510-0195	9	#8-32 x 3/8 Screw
4	2	5020-8896	7	Front Handle Trim

Figure 2-9. Option 907 Front Handles Kit

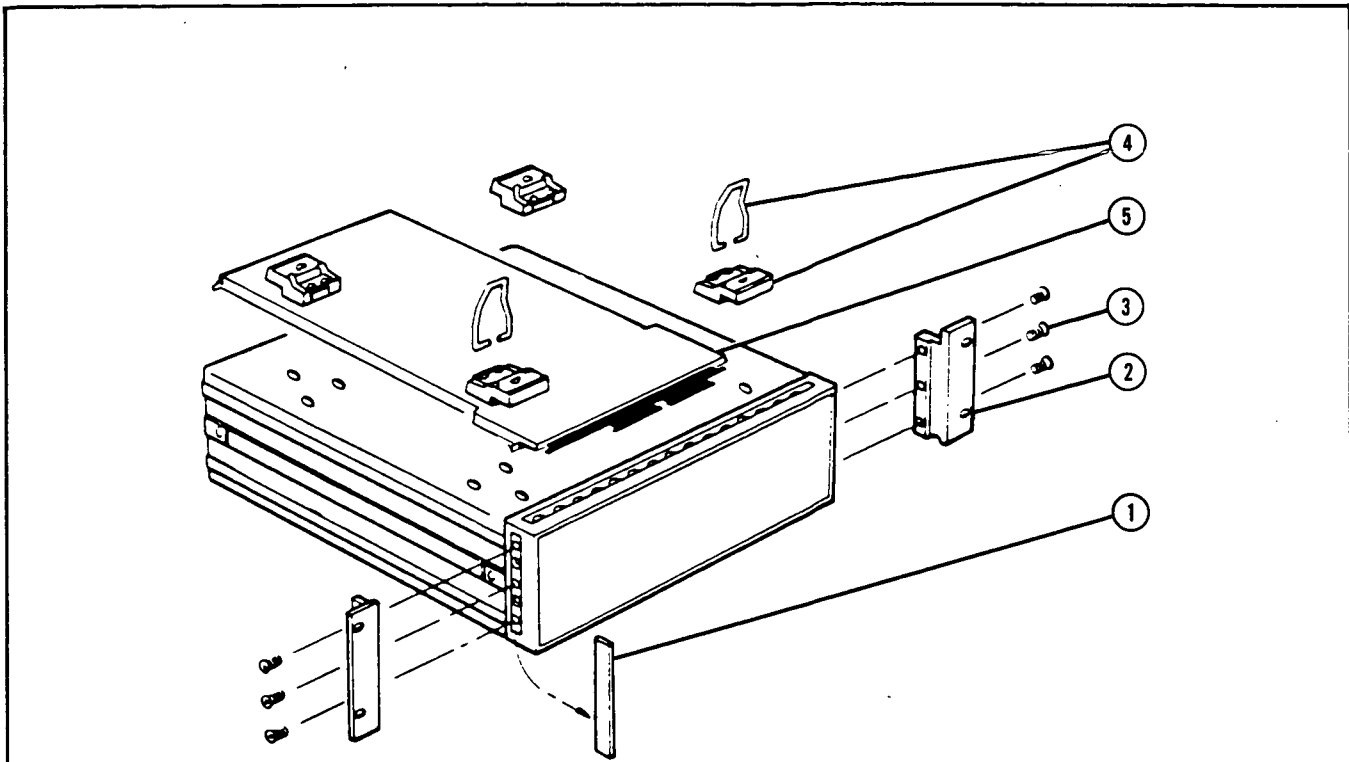

**INSTALLATION INSTRUCTIONS:**

1. REMOVE SIDE TRIM STRIPS ① .
2. ATTACH RACK MOUNT FLANGE ② WITH 8-32 x 3/8 SCREWS ③ .
3. REMOVE FEET AND TILT STANDS ④ BEFORE RACK MOUNTING. THIS ALSO REMOVES INFORMATION CARD TRAY ⑤ . TO RETAIN USE OF INFORMATION CARDS, DO NOT REMOVE FEET, AND WHEN RACK MOUNTING, ALLOW APPROXIMATELY 2CM (3/4 INCH) BELOW INSTRUMENT TO ACCOMMODATE THE TRAY. (NO FILLER STRIP IS PROVIDED.)

**OPTION 908 (HP Part No. 5061-0077) CONTENTS**

Item	Qty.	HP Part No.	C D	Description
2	2	5020-8862	7	Rack Mount Flange
3	6	2510-0913	9	#8-32 x 3/8 Screw

Figure 2-10. Option 908 Rack Mount Kit

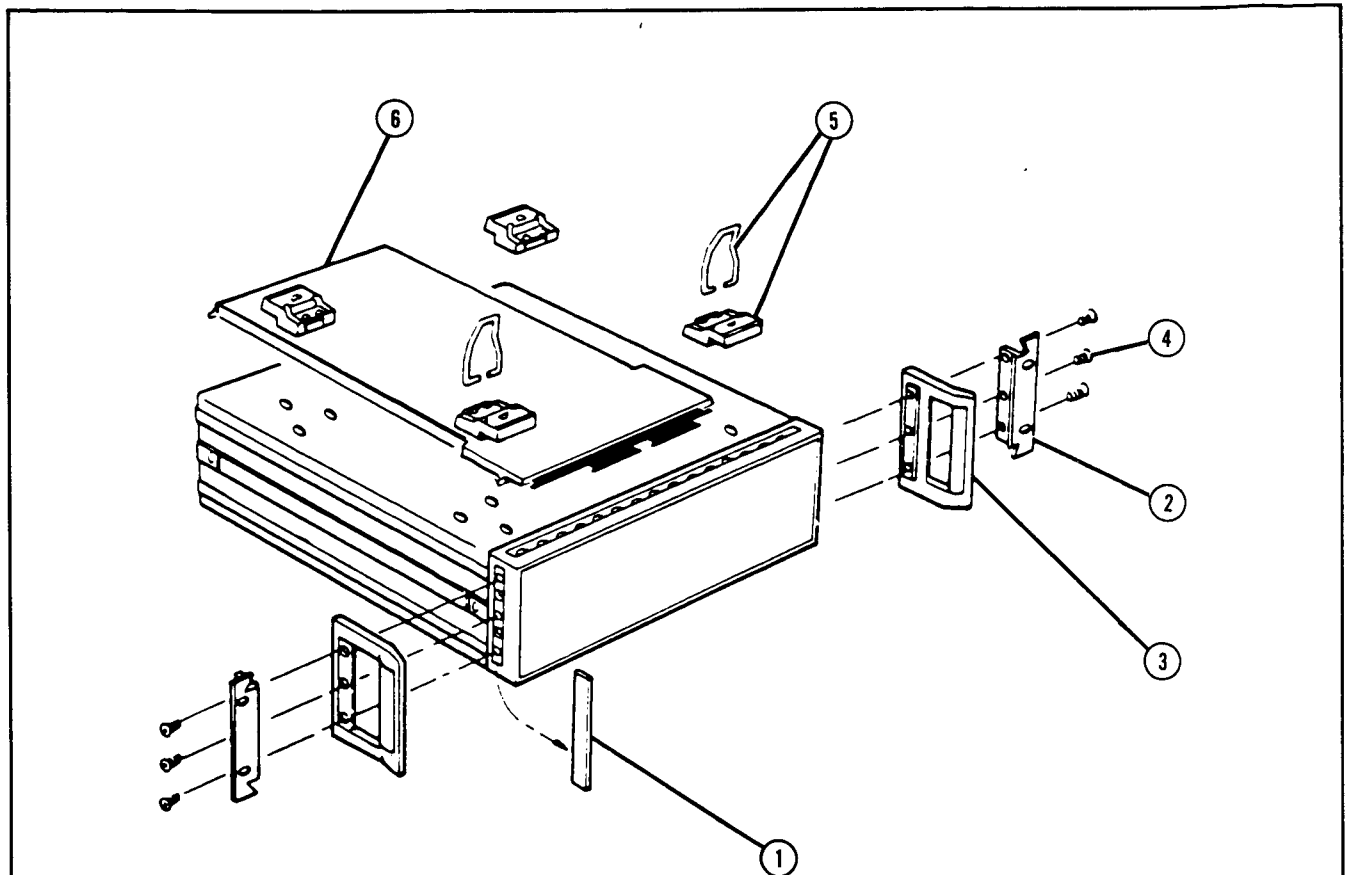

**INSTALLATION INSTRUCTIONS:**

1. REMOVE SIDE TRIM STRIPS ① .
2. ATTACH RACK MOUNT FLANGE ② AND FRONT HANDLE ASSEMBLY ③ WITH THREE 8-32 x 5/8 SCREWS ④ PER SIDE.
3. REMOVE FEET AND TILT STANDS ⑤ BEFORE RACK MOUNTING. THIS ALSO REMOVES INFORMATION CARD TRAY ⑥ . TO RETAIN USE OF INFORMATION CARDS, DO NOT REMOVE FEET, AND WHEN RACK MOUNTING, ALLOW APPROXIMATELY 2CM (3/4 INCH) BELOW INSTRUMENT TO ACCOMODATE THE TRAY. (NO FILLER STRIP IS PROVIDED.)

**OPTION 909 (HP Part No. 5061-0083) CONTENTS**

Item	Qty.	HP Part No.	C D	Description
2	2	5020-8874	1	Rack Mount Flange
3	2	5060-9899	6	Front Handle Assembly
4	6	2510-0194	8	#8-32 x 5/8 Screw

Figure 2-11. Option 909 Rack Mount Kit with Handles

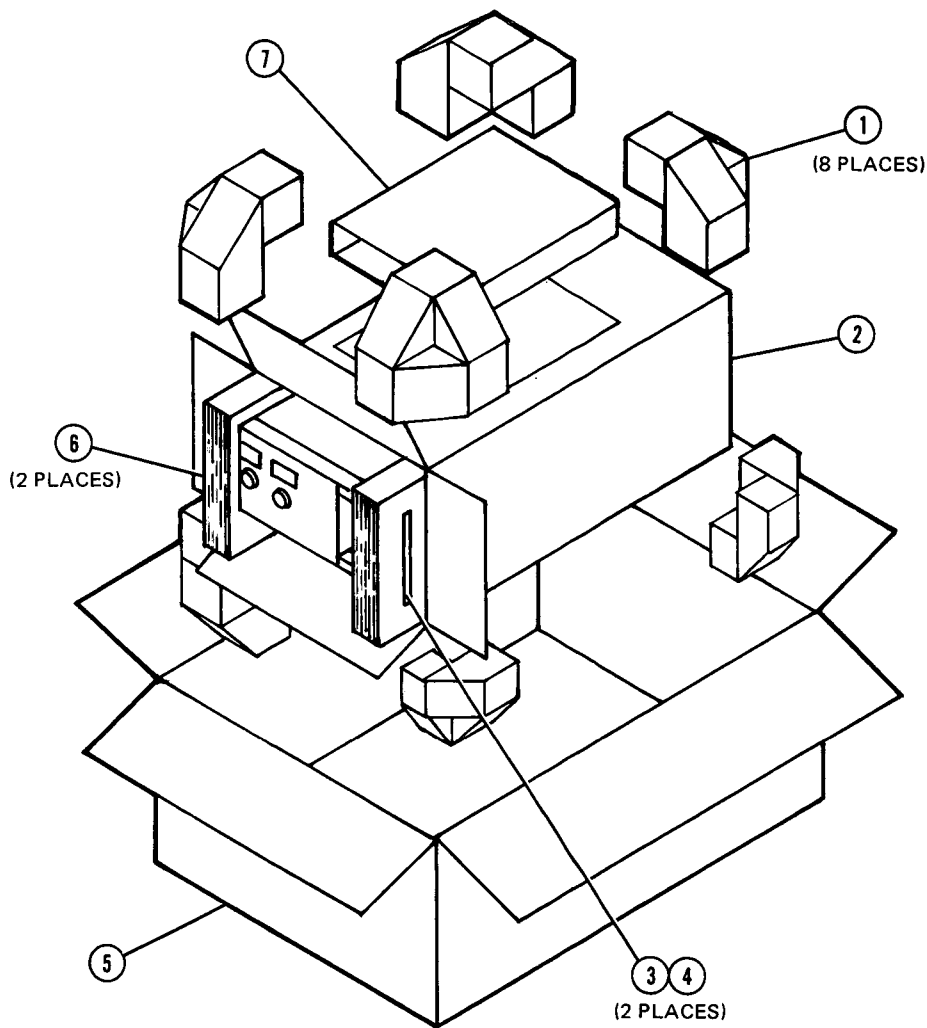

Item	Qty	HP Part No.	C D	Description
1	8	9220-2733	7	FOAM PADS - TOP CORNERS; BOTTOM CORNERS
2	1	9211-3462	2	CARTON - INNER
3	2	4040-1738	3	BARS - SHIPPING, NYLON
4	4	2510-0103	9	SCREW - FOR ATTACHING SHIPPING BARS
5	1	9211-3463	3	CARTON - OUTER
6	2	9220-3365	3	SIDE PADS - CORRUGATED CARDBOARD
7	1	9220-2950	0	SLEEVE - FOR MANUAL PROTECTION
8	1	9222-0484	5	POLY BAG - TO COVER INSTRUMENT (NOT SHOWN)

Figure 2-12. Packaging for Shipment using Factory Packaging Materials



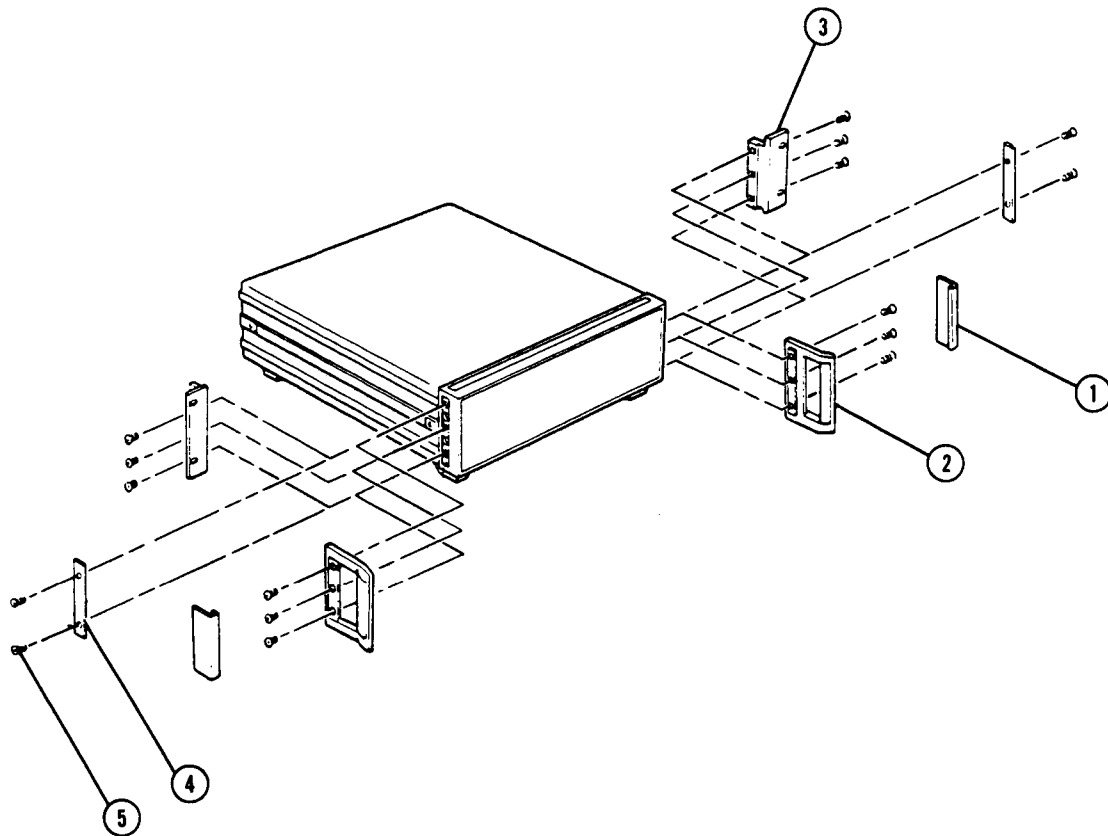

1. REMOVE RACK MOUNT FLANGE ③ AND/OR FRONT HANDLE ASSEMBLY. ① ②.
2. ATTACH SHIPPING BARS\* ④ WITH TWO 8-32 x 3/8 SCREWS ⑤.

\*Refer to Figure 2-12 for Part Numbers of Shipping Bars and Screws.

Figure 2-13. Preparation of Instrument for Shipment

Rack Mount Kit with Front Handles, a combination of the Option 907 Kit and the Option 908 Kit. This kit supplies the necessary hardware and installation instructions for preparing the instrument to mount on equipment rack with 482.6 mm (19 in.) support spacing, with the addition of front handles. Installation instructions are also given in Figure 2-11. Additional Option 909 Kits may be ordered as HP Part Number 5061-0083.

## 2-48. Battery Operation (Option 001)

2-49. Instruments with Option 001 contain a battery pack (inserted in the battery holder with a battery hold down clamp) and a modified A3 Microprocessor board. With Option 001 installed, the instrument has a nonvolatile memory which retains the contents of all instrument state storage registers, the current instrument state, and the HP-IB address. When shipped from the factory, the batteries are fully charged. The batteries will retain a sufficient charge to hold the memory contents for approximately 20 days from the date at which they were fully charged. The batteries are charged within the instrument, and a full charge is maintained at all times when the instrument LINE switch remains ON. The batteries do not charge when the instrument LINE switch is OFF. When fully discharged, the batteries will typically take approximately 33 hours to obtain a full charge. Allow the instrument to be on for at least 24 hours when new or when the instrument has been turned off for a sufficiently long enough period of time that the batteries might have become discharged to a level where memory contents may have been lost. Additional Option 001 Battery Kits may be ordered for the Model 8350A to upgrade a standard instrument to an Option 001 instrument by ordering HP Part Number 08350-60013. This Option 001 Battery Kit contains a battery pack, a battery pack hold down clamp, and a special A3 Microprocessor board. All other necessary wiring and hardware connections have been made at the factory on all standard instruments. Refer to Section VI Replaceable Parts in this manual for information and part numbers required to order individual battery packs.

## 2-50. STORAGE AND SHIPMENT

### 2-51. Environment

2-52. The instrument may be stored or shipped in environments within the following limits:

Temperature . . . . .  $-40^{\circ}\text{C}$  to  $+75^{\circ}\text{C}$   
 Humidity . . . . . 5% to 95% relative at  $0^{\circ}$   
 to  $+40^{\circ}\text{C}$   
 Altitude . . . . . Up to 15240 meters  
 (approximately 50,000 feet)

2-53. The instrument should also be protected from temperature extremes which may cause condensation in the instrument.

### 2-54. Packaging

2-55. **Original Packaging.** Containers and materials identical to those used in factory packaging are available through Hewlett-Packard offices. A complete diagram and listing of packaging materials used for the Model 8350A is shown in Figure 2-12. Prior to shipping in the factory packaging materials, the shipping bars should replace the front handles or rack mount flanges, as shown in Figure 2-13, to hold the instrument securely in the packaging material. If the instrument is being returned to Hewlett-Packard for servicing, attach a tag indicating the type of service required, return address, model number, and full serial number (located on rear panel serial plate). Mark the container FRAGILE to assure careful handling. In any correspondence, refer to the instrument by model number and full serial number.

2-56. **Other Packaging.** The following general instructions should be used for repackaging with commercially available packaging materials:

- a. Wrap the instrument in heavy paper or plastic. If shipping to a Hewlett-Packard Office or Service Center, attach a tag indicating the type of service required, return address, model number, and full serial number.
- b. Use a strong shipping container.
- c. Use enough shock-absorbing material around all sides of the instrument to provide a firm cushion and to prevent movement inside the container. Protect the control panel with cardboard.
- d. Seal the shipping container securely.
- e. Mark the shipping container FRAGILE to assure careful handling.
- f. In any correspondence, refer to the instrument by model number and full serial number.

# 8350A SWEEP OSCILLATOR

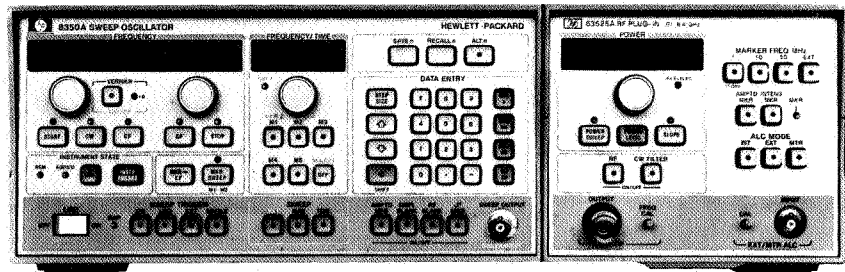

# 8350A SWEEP OSCILLATOR

©Copyright                      HEWLETT-PACKARD COMPANY                      1980  
1400 FOUNTAIN GROVE PARKWAY, SANTA ROSA, CALIFORNIA 95404

MANUAL PART NO. 08350-90001  
Microfiche Part No. 08350-90002

Printed: AUGUST 1980



**HEWLETT  
PACKARD**

## SECTION III OPERATING INFORMATION

### 3-1. INTRODUCTION

3-2. This subsection contains an index of keys and functions which refer to the figured functional blocks at the end of this subsection. Included in this section are descriptions of all front panel controls, connectors and indicators, operator's checks, operating instructions, and operator's maintenance.

### 3-3. SAFETY

3-4. Before applying power, refer to SAFETY CONSIDERATIONS in Section I of this manual.

3-5. The information, cautions, and warnings in this manual must be followed to ensure safe operation and to keep the instrument safe.

#### WARNING

Before the instrument is switched on, all protective earth terminals, extension cords, auto-transformers and devices connected to it should be connected to a protective earth grounded socket. Any interruption of the protective earth grounding will cause a potential shock hazard that could result in personal injury.

Only fuses with the required rated current and specified type should be used. Do not use repaired fuses or short circuited fuseholder. To do so could cause a shock or fire hazard.

#### CAUTION

Before the instrument is switched on, it must be set to the voltage of the power source, or damage to the instrument may result.

### 3-6. OPERATING CHARACTERISTICS

3-7. Table 3-1 briefly summarizes the major operating characteristics of the Sweep Oscillator. The table is not intended to be an in-depth listing of all operations and ranges. For more infor-

mation on Sweep Oscillator capabilities, refer to Specifications Table 1-1, and Supplemental Information Table 1-2.

### 3-8. Panel Features

3-9. Figure 3-1 Front Panel features provides a reference to a functional block figure number which provides a complete description of each control within the function block.

3-10. Rear Panel features are described in Figure 3-2.

### 3-11. OPERATOR'S CHECKS

3-12. The local operator's check (Figure 3-3) allows the operator to make a quick check of the main instrument functions prior to use. This check assumes that an RF plug-in is installed in the Sweep Oscillator and that a 10 dB attenuator, oscilloscope, and appropriate crystal detector are available. If these items are not available the preliminary self test may still be performed.

3-13. The remote operator's check (Figure 3-4) allows the operator to make a quick check to the main remote functions prior to use. This test is shown in program statements for HPL and BASIC and a general flow chart.

### 3-14. OPERATING INSTRUCTIONS

3-15. Located underneath the Sweep Oscillator is a pullout information card which contains information on general operating instructions, some remote programming information, and some plug-in usage information.

3-16. For a complete reference of each function refer to the function group index (Table 3-2).

### 3-17. LOCAL OPERATION

3-18. The operation of the 8350A Sweep oscillator in the Local mode is described in the Local Operation handbook and by functional block figures indexed in the table of contents and Table 3-2.

### FRONT PANEL FEATURES

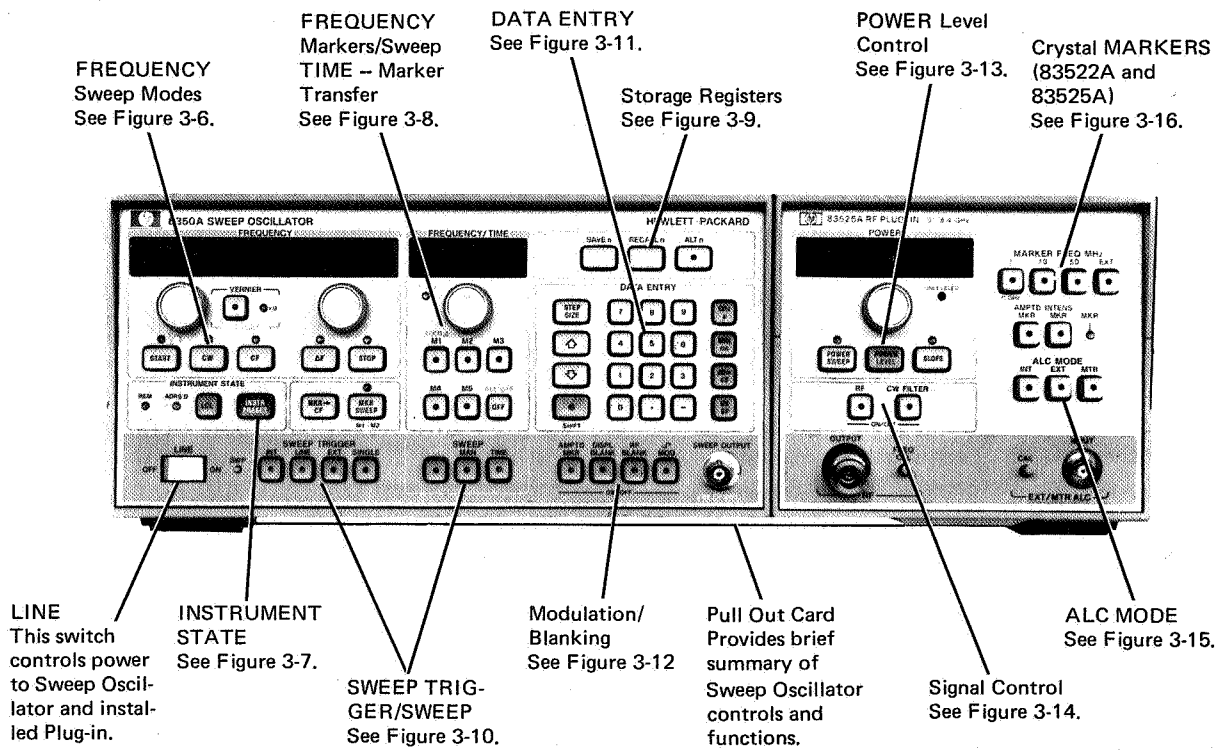
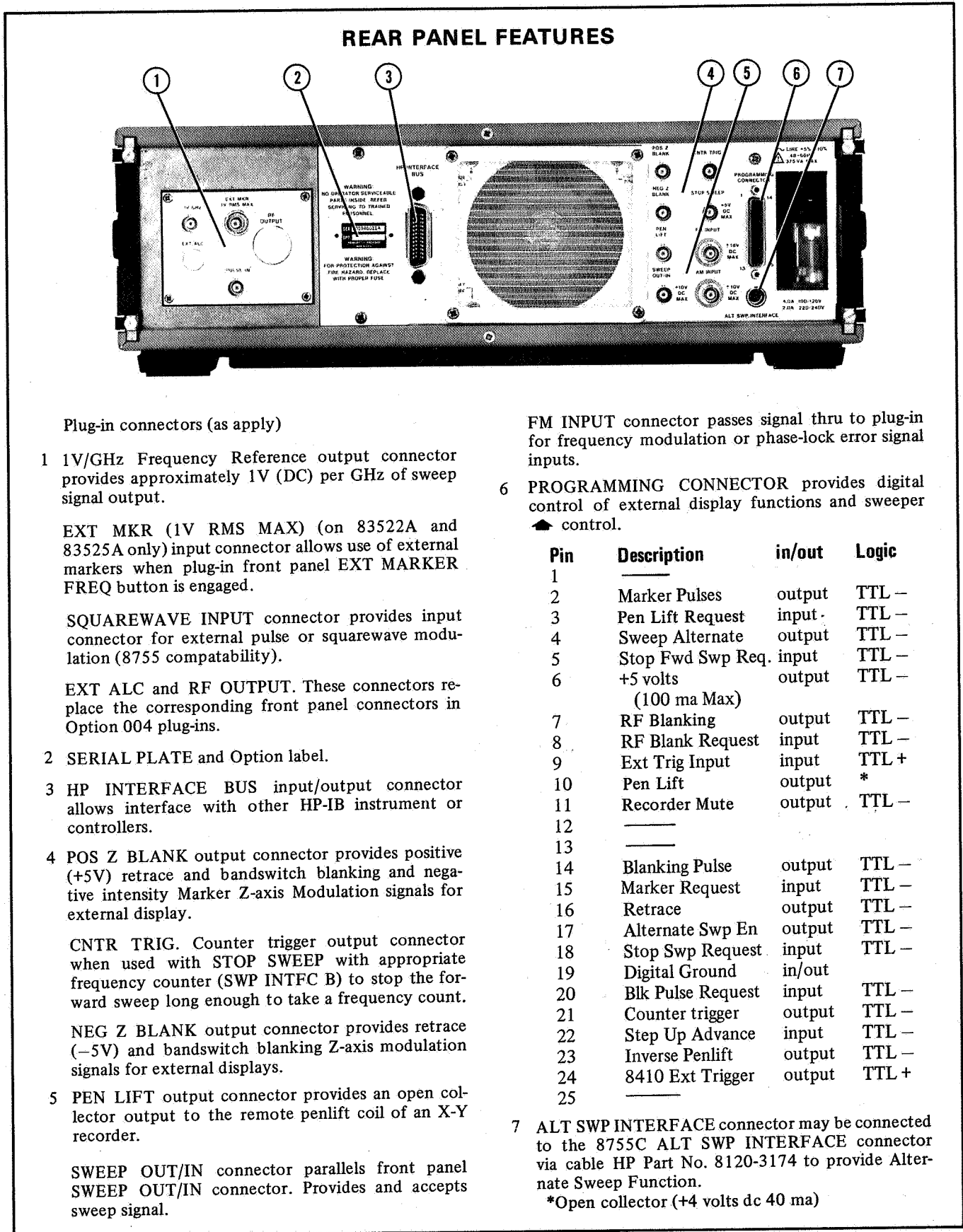

Figure 3-1. Front Panel Features



Plug-in connectors (as apply)

- 1 1V/GHz Frequency Reference output connector provides approximately 1V (DC) per GHz of sweep signal output.

EXT MKR (1V RMS MAX) (on 83522A and 83525A only) input connector allows use of external markers when plug-in front panel EXT MARKER FREQ button is engaged.

SQUAREWAVE INPUT connector provides input connector for external pulse or squarewave modulation (8755 compatibility).

EXT ALC and RF OUTPUT. These connectors replace the corresponding front panel connectors in Option 004 plug-ins.

- 2 SERIAL PLATE and Option label.

- 3 HP INTERFACE BUS input/output connector allows interface with other HP-IB instrument or controllers.

- 4 POS Z BLANK output connector provides positive (+5V) retrace and bandswitch blanking and negative intensity Marker Z-axis Modulation signals for external display.

CNTR TRIG. Counter trigger output connector when used with STOP SWEEP with appropriate frequency counter (SWP INTFC B) to stop the forward sweep long enough to take a frequency count.

NEG Z BLANK output connector provides retrace (-5V) and bandswitch blanking Z-axis modulation signals for external displays.

- 5 PEN LIFT output connector provides an open collector output to the remote penlift coil of an X-Y recorder.

SWEEP OUT/IN connector parallels front panel SWEEP OUT/IN connector. Provides and accepts sweep signal.

FM INPUT connector passes signal thru to plug-in for frequency modulation or phase-lock error signal inputs.

- 6 PROGRAMMING CONNECTOR provides digital control of external display functions and sweeper control.

Pin	Description	in/out	Logic
1			
2	Marker Pulses	output	TTL -
3	Pen Lift Request	input	TTL -
4	Sweep Alternate	output	TTL -
5	Stop Fwd Swp Req.	input	TTL -
6	+5 volts (100 ma Max)	output	TTL -
7	RF Blanking	output	TTL -
8	RF Blank Request	input	TTL -
9	Ext Trig Input	input	TTL +
10	Pen Lift	output	*
11	Recorder Mute	output	TTL -
12			
13			
14	Blanking Pulse	output	TTL -
15	Marker Request	input	TTL -
16	Retrace	output	TTL -
17	Alternate Swp En	output	TTL -
18	Stop Swp Request	input	TTL -
19	Digital Ground	in/out	
20	Blk Pulse Request	input	TTL -
21	Counter trigger	output	TTL -
22	Step Up Advance	input	TTL -
23	Inverse Penlift	output	TTL -
24	8410 Ext Trigger	output	TTL +
25			

- 7 ALT SWP INTERFACE connector may be connected to the 8755C ALT SWP INTERFACE connector via cable HP Part No. 8120-3174 to provide Alternate Sweep Function.

\*Open collector (+4 volts dc 40 ma)

Figure 3-2. Rear Panel Features

Table 3-1. Sweep Oscillator Operating Characteristics

FREQUENCY RANGE	Set automatically when plug-in installed
SWEEP MODES	START-STOP CENTER FREQUENCY- $\Delta$ F Marker→Center frequency Marker Sweep CW Frequency
MARKERS	5 settable frequency markers amplitude and intensity
SWEEP TIME	Range .01–100 seconds
POWER	Control power level with 83500 Series Plug-ins

Table 3-2. Functional Block Index (1 of 2)

Function	Function Block Index	Page
ALC Mode	ALC Mode .....	41
ALL OFF	Frequency Markers.....	26
Alternate Sweep	Storage Registers.....	30
Amplitude Mkr Plug-in	Crystal Markers.....	43
Amplitude Markers 8350A	Modulation/Blanking.....	36
Back Space	Data Entry .....	34
Blanking Display	Modulation/Blanking.....	36
Modulation/Blanking RF	Modulation/Blanking.....	36
Center Frequency	Frequency Sweep Mode.....	21
Crystal Markers	Crystal Markers.....	43
CW Mode	Frequency Sweep Mode.....	21
CW Filter	Signal Control.....	40
Data Entry	Data Entry .....	34
dB—dBm	Data Entry .....	34
Delta $\Delta$ Frequency	Frequency Sweep Mode.....	21
Display Blanking	Modulation/Blanking.....	36
Down $\blacktriangledown$ step	Data Entry .....	34
External ALC	ALC Mode .....	41
External Sweep	Sweep/Sweep Trigger.....	32
External Plug-in Markers	Crystal Markers.....	43
Frequency Sweep Modes	Frequency Sweep Mode.....	21
Frequency Markers 8350A	Frequency Markers.....	26
Frequency Markers Plug-in	Crystal Markers.....	43
GHz	Data Entry .....	34
HP-IB Only Functions	HP-IB Special Functions .....	45
Instrument Preset	Instrument State .....	24
Intensity Crystal Markers	Crystal Markers.....	43



Table 3-2. Functional Block Index (2 of 2)

Function	Function Block Index	Page
Intensity Markers 8350A	Frequency Markers.....	26
Internal ALC	ALC Mode.....	41
Internal Sweep Trigger	Sweep/Sweep Trigger.....	32
Learn String	HP-IB Only Functions.....	45
Level Power	Power Control.....	38
Line Sweep Trigger	Sweep/Sweep Trigger.....	32
Local key	Instrument State.....	24
Manual Sweep	Sweep/Sweep Trigger.....	32
M1 to M5	Frequency Markers.....	26
Markers Crystal	Crystal Markers.....	43
Marker Delta	Frequency Markers.....	26
Marker Sweep	Frequency Markers.....	26
Marker→Center Frequency	Frequency Markers.....	26
Meter ALC	ALC Mode.....	41
Millisecond	Data Entry.....	34
MHz	Data Entry.....	34
Network Analyzer Trigger	HP-IB Only functions.....	45
Offset	Frequency Sweep Mode.....	21
Output Active Parameter	HP-IB Only Functions.....	45
Power Level	Power Control.....	38
Power Sweep	Power Control.....	38
Recall n	Storage Registers.....	30
RF	Power Control.....	38
Save n	Storage Registers.....	30
Shift	Data Entry.....	34
Single Sweep Trigger	Sweep/Sweep Trigger.....	32
Slope	Power Control.....	38
Slope Cal	Power Control.....	38
Square Wave $\square$ Modulation	Blanking/Modulation.....	36
Start Sweep	Frequency Sweep Mode.....	21
Step Size	Data Entry.....	34
Stop Sweep	Frequency Sweep Mode.....	21
Time Sweep	Frequency Markers.....	26
UP $\blacktriangle$ Step key	Data Entry.....	34
Vernier	Frequency Sweep Mode.....	21

### LOCAL OPERATOR'S CHECKS

#### DESCRIPTION

The Preliminary check provides assurance that most of the internal functions of the Sweep Oscillator are working. The main check provides a general check of the overall functions of the Sweep Oscillator.

#### PRELIMINARY CHECK

(Self test) Each time the Sweep Oscillator is turned on or INSTR PRESET button is engaged the instrument performs a series of self tests taking about one second to complete. When the self test is complete the instrument will be in the preset mode if a plug-in is installed or the left-most frequency display will have an E001 error code indicating no plug-in is installed. If error code E016 is observed refer to paragraph 3-103. If another error code is noted the Sweep Oscillator requires service refer to paragraph 3-107. Plug-in related error information (E050 to E059) is in the plug-in manual.

1. Set LINE switch to ON. Observe display in START/STOP mode with display frequency equaling plug-in range or E001 if no plug-in is installed.

#### MAIN CHECK

##### Equipment:

- RF Plug-in ..... HP 83500 series or HP 86200 series with adapter HP 11869A (18 GHz or less)
- Oscilloscope..... HP 1220A or HP 1740A
- Crystal Detector ..... HP 8473C or a crystal detector that will cover frequency range of interest.
- Attenuator 10 dB ..... 8491B Option 010
- Cables BNC to BNC (3)..... 10503A (123 cm)

##### Setup:

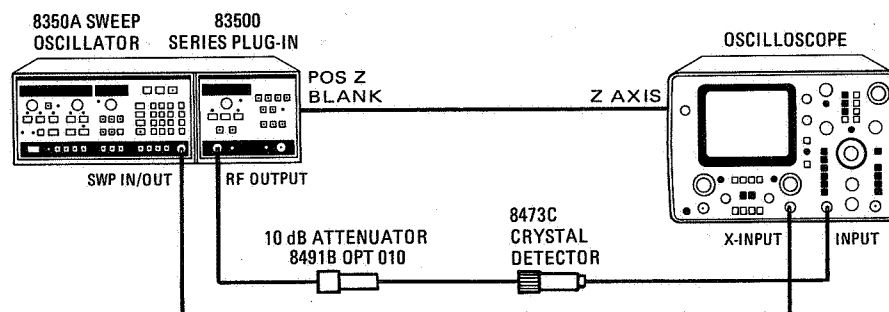

Connect the equipment listed above as shown in above diagram.

Figure 3-3. Local Operator's Check (1 of 2)

**LOCAL OPERATOR'S CHECKS (Cont'd)****CAUTION**

**BEFORE CONNECTING LINE POWER**, ensure that all devices connected to this instrument are connected to the protective (earth) ground.

**BEFORE SWITCHING ON THIS INSTRUMENT**, ensure that the line power plug is connected to a three-conductor line power outlet that has a protective (earth) ground. (Grounding one conductor of a two-conductor outlet is not sufficient.)

**NOTE**

**BEFORE SWITCHING ON THIS INSTRUMENT**, ensure that the power transformer primary is matched to the available line voltage, the correct fuse is installed, and the safety precautions are taken. See **Power Requirements, Line Voltage Selection, Power Cables**, and associated warnings and cautions in Section II.

**Procedure:**



1. Set **LINE** switch to **ON** position. Observe that **LEDs** above **START** and **STOP** buttons are on with the frequency range of installed plug-in displayed above them. Oscilloscope trace should show detected **RF** signal output below zero-volt reference with no discontinuities in swept trace across band.
2. Press **CW** button. Observe **LED** above **CW** on and trace is reduced to dot at center of **CRT** with display at center of plug-in frequency range.
3. Press **CF** button. Observe **LED** above **CF** and **ΔF** buttons on, that displayed center frequency is at center of plug-in frequency range and **ΔF** display is equal to frequency span.
4. Press **MI** button. Observe button **LED** on an blinking and a intensity dot at approximately the center of the trace.
5. Press **SWEEP TIME** button then press **DATA ENTRY**  button a few times and observe sweep getting slower. Press **DATA ENTRY**  button a few times and observe sweep getting faster.
6. Press **DATA ENTRY**  **1** **GHz/s** and observe **FREQUENCY/TIME** display is 0.100 sec.

Figure 3-3. Local Operator's Check (2 of 2)

REMOTE OPERATOR'S CHECK			
Flowchart	HPL Statements <sup>1</sup>	BASIC Statements <sup>2</sup>	Visual Indicators
<p>START</p> <p>--REMOTE</p> <p>Send REN command to ensure instrument is in remote enable state.</p> <p>--DATA</p> <p>Program sweep oscillator to Instrument Preset.</p> <p>Print Start and Stop frequencies.</p> <p>Switch to CW. Print CW.</p> <p>Switch to CF ΔF. Change sweep time to 10 seconds.</p> <p>--LOCAL</p> <p>Switch to local.</p>	<pre>rem 719  wrt 719,"IP"  wrt 719,"OPFA" red 719,A wrt 719,"OPFB" red 719,B prt "START FREQ",A prt "STOP FREQ",B  wrt 719,"CWOPCW" red 719,C prt "CW",C  wrt,"CFST10SC,"  lcl 719</pre>	<pre>REMOTE 719  OUTPUT 719;"IP"  OUTPUT 719;"OPFA" ENTER 719,A OUTPUT 719;"OPFB" ENTER 719,B PRINT"START FREQ";A PRINT"STOP FREQ";B  OUTPUT 719;"CWOPCW" ENTER 719,C PRINT"CW";C  OUTPUT 719;"CFST10SC"  LOCAL 719</pre>	<p>Remote LED on</p> <p>Instrument START/STOP condition preset sweep</p> <p>Printout equals plug-in frequency range</p> <p>CW LED on printout CW frequency</p> <p>CF and ΔF, TIME LEDS on, 10 second sweep time</p> <p>Remote lamp out</p>
<p>1 Typical Statements for the HP 9825 Series Desktop Computer.</p> <p>2 Typical Statements for the HP 9835, 9845, and 85 Series Desktop Computers.</p>			

Figure 3-4. Remote Operator's Check

**3-19. REMOTE OPERATION: HEWLETT-PACKARD INTERFACE BUS**

3-20. The 8350A Sweep Oscillator can be operated remotely via the Hewlett-Packard Interface Bus (HP-IB). Bus compatibility, programming capability, and data formats are described in the following paragraphs. For complete information on specific program code syntax, functions, limits, etc., please see Functional Block Index Table 3-2.

3-21. All front panel functions except for the LINE switch and Set HP-IB Address are programmable through the HP-IB. Also provided are special HP-IB only functions to aid the programmer. Complete descriptions of all HP-IB programmable functions are contained within the functional blocks.

3-22. To verify that the Sweep Oscillator's HP-IB interface is functional, a quick check is provided in Figure 3-4 Remote Operators' Check. This tests that the 8350A can respond and send to the controller the fundamental HP-IB bus messages. The following information gives a general de-

scription of the HP-IB and defines the terms, concepts, and messages used in an HP-IB system.

3-23. For more information about the HP-IB, refer to any of the following documents:

IEEE Interface Standard 488-1975

ANSI Interface Standard MC1.1

"Improving Measurements in Engineering and Manufacturing" (HP Part No. 5952-0058)

"Condensed Description of the Hewlett-Packard Interface Bus" (HP Part No. 59401-90030)

**3-24. General HP-IB Description**

3-25. The HP-IB is a parallel bus of 16 active signal lines grouped into three sets according to function, to interconnect up to 15 instruments. Figure 3-5 is a diagram of the interface connections and bus structure. Table 3-3 defines the function of each signal line.

*Table 3-3. The Bus Signals*

Name	Nmemonic	Description
Data Input/Output	DIO1-8	The eight data lines for the byte of data.
Data Valid	DAV	Indicates the data lines have a valid byte of data.
Not Ready for Data	NRFD	Indicates that the listening devices are not ready to accept further data.
Not Data Accepted	NDAC	Indicates that the listening devices have not completely accepted the present byte of data.
Attention	ATN	Enables a device to interpret data on the bus as a controller command (command mode) or data transfer (data mode).
Interface Clear	IFC	Initializes the HP-IB system to an idle state (no activity on the bus).
Service Request	SRQ	Alerts the controller to a need for communication.
Remote Enable	REN	Places instruments under remote program control
End Or Identify	EOI	Indicates last data transmission during a data transfer sequence; used with ATN to poll devices for their status.

3-26. Eight signal lines form the first set and are termed "data" lines. The data lines carry coded messages which represent addresses, program data, measurements, and status bytes. The same data lines are used for input and output messages in bit-parallel, byte-serial form. Normally, a seven-bit ASCII code represents each piece (byte) of data, leaving the eighth bit available for parity checking.

3-27. Data transfer is controlled by means of an interlocked "handshake" technique which permits data transfer (asynchronously) at the rate of the slowest device participating in that particular conversation. The three data byte transfer control lines which implement the handshake (DAV, NRFD, NDAC) form the second set of lines.

3-28. The remaining five general interface management lines form the third set and are used in such ways as activating all the connected devices at once, clearing the interface, allowing a device to request service, etc.

**3-29. Definition of HP-IB Terms and Concepts**

3-30. The following list defines the terms and concepts that describe HP-IB system operations.

**Byte:** A unit of information consisting of 8 binary digits (bits).

**Device:** Any unit that is compatible with the IEEE Standard 488-1975.

**Device Dependent:** An action a device performs in response to information sent on the HP-IB. The action is characteristic of an individual devices' design and may vary from device to device.

**Addressing:** The set of characters sent by a controller to specify which device will send information on the bus and which device(s) will receive that information. A device may also have its address fixed so that it may receive information (listen only) or send information (talk only).

**Polling:** The process by which a controller can identify a device that needs interaction with it. The controller may poll devices for their operational condition one at a time, which is termed a serial poll, or as groups of devices simultaneously, which is termed a parallel poll.

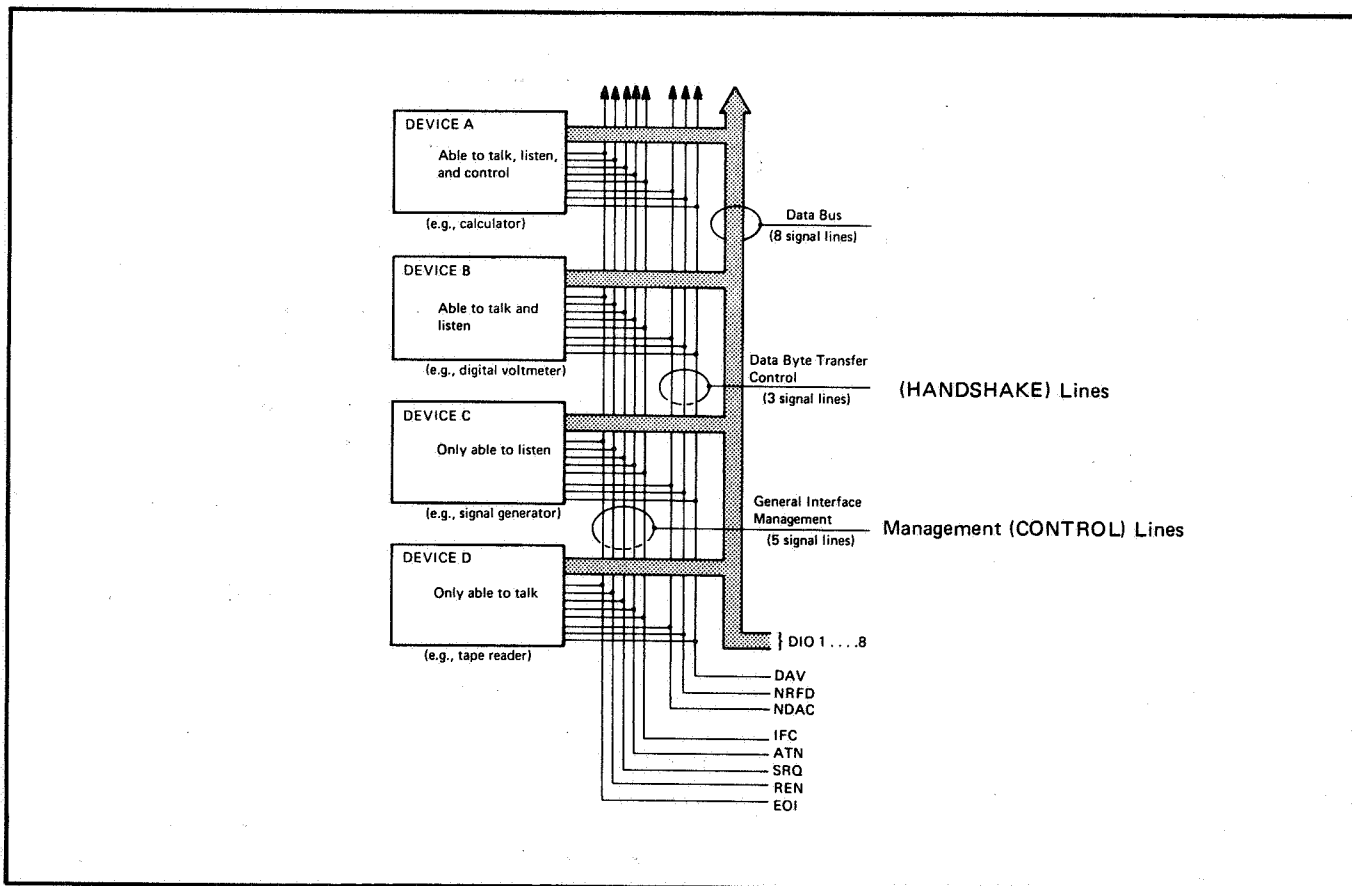

Figure 3-5. Interface Connections and Bus Structure

### 3-31. Basic Device Communication Capability

3-32. Devices which communicate along the interface bus fall into three basic categories.

**Talkers:** Devices which send information on the bus when they have been addressed.

**Listeners:** Devices which receive information sent on the bus when they have been addressed.

**Controllers:** Devices that can specify the talker and listener(s) for an information transfer. The controller can be an active controller or a system controller. The active controller is defined as the current controlling device on the bus. The system controller can take control of the bus even if it is not the active controller. Each system can have only one system controller, even if several controllers have system control capability.

### 3-33. HP-IB System Messages

3-34. The transfer of information via the HP-IB occurs from one device to one or more devices, thus consider the information to be a message. There are twelve types of messages on the HP-IB. The following describes each of the HP-IB System Messages.

- a. **The Data Message:** The actual information which is sent from the talker to one or more listeners on the HP-IB. The information or data can be numeric or a string of characters.
- b. **The Trigger Message:** This causes the listening device(s) to perform a device-dependent action when addressed.
- c. **The Clear Message:** This causes either the listening device(s) or all of the devices on the bus to return to a predefined device-dependent state.
- d. **The Remote Message:** This causes the listening device(s) to switch from local front panel control to remote program control when addressed to listen. This message remains in effect so that devices subsequently addressed to listen will go into remote operation.
- e. **The Local Message:** This clears the remote message from listening device(s) and returns the device(s) to local front panel control.
- f. **The Local Lockout Message:** This prevents the user of a device from manually inhibiting remote program control.
- g. **The Clear Lockout/Set Local Message:** This causes all devices on the bus to be removed from local lockout and revert to local. This message also clears the remote message for all devices on the bus.
- h. **The Require Service Message:** A device can send this message at any time to signify that the device needs some type of interaction with a controller. The message is cleared by sending the device's Status Byte message if the device no longer needs service.
- i. **The Status Byte Message:** A byte that represents the status of a single device on the bus. Within this byte, the seventh most significant bit (bit 6 of bits 0 through 7) indicates whether the device has sent a Require Service message. The remaining bits indicate the present operational conditions defined by the device. This byte is sent from a talking device in response to a serial poll operation performed by a controller.
- j. **The Status Bit Message:** A byte that represents the operational conditions of a group of devices on the bus. Each device responds on a particular bit of the byte thus identifying a device-dependent condition. This bit is typically sent by devices in response to a parallel poll operation by a controller.
- k. **The Pass Control Message:** This transfers the bus management responsibilities from the active controller to another controller.
- l. **The Abort Message:** The system controller sends this message to unconditionally assume control of the bus. This message terminates all bus communications but does not implement the Clear message.

This message can also be used by a controller to specify the particular bit and logic level that a device will respond with when a parallel poll operation is performed. Thus more than one device can respond on the same bit.

A summary of the twelve bus messages, their related commands and mnemonics are provided in Table 3-4.

Table 3-4. The Twelve Bus Messages (1 of 2)

HP-IB Message	Applicable	8350A Response	Related Comments	Interface Function	Message Type	Sample Statements	
						HPL (9825)	BASIC (9835,9845,85)
Data	Yes	Input data controls all front panel functions (except the Line switch) plus special HP-IB only functions. Output data includes information as to present instrument state, values of selected functions, and the instrument status.		T6 L4 AH1 SH1	Input Data	wrt 719; "..."	OUTPUT 719; "..."
					Output Data	red 719,A;...	ENTER 719;A,...
Trigger	Yes	Responds by triggering a sweep if and only if in the single sweep trigger mode.	GET	DT1	System Trigger	trg 7	TRIGGER 7
					Device Trigger	trg 719	TRIGGER 719
Clear	Yes	Clears the instrument status byte and the extended status byte.	DCL SDC	DC1	System Clear	clr 7	RESET 7
					Device Clear	clr 719	CLEAR 719
Remote	Yes	Removes the 8350A from local front panel control to remote HP-IB control. All functions remain the same as in local and the keyboard is non-responsive except the LOCAL key.	REN	RL1	System Remote	rem 7	REMOTE 7
					Device Remote	rem 719	REMOTE 719
Local	Yes	Removes the 8350A from remote HP-IB control to local front panel control. All functions remain the same as in the remote state.	GTL	RL1	System Local	lcl 7	LOCAL 7
					Device Local	lcl 719	LOCAL 719
Local Lockout	Yes	Functions the same as the remote message except that the entire front panel is disabled including the LOCAL key.	LLO	RL1		llo 7	LOCAL LOCKOUT 7
Clear Lockout/ Set Local	Yes	Removes the 8350A from local lockout and remote HP-IB control to local front panel control. All functions remain the same as in the remote state.	REN	RL1		lcl 7	LOCAL 7
Require Service	Yes	The 8350A can set the HP-IB SRQ (Service Request) line if one of the following instrument conditions exists and has been enabled by the Request Mask value. Testable conditions include: parameter value altered, syntax error, end of sweep, power failure, and RF un-leveled.	SRQ	SR1		rds(719)→A, if bit (6,A) =1; gto "SRQ"	STATUS 719; A IF BIT (A,6)=1 THEN Srq



Table 3-4. The Twelve Bus Messages (2 of 2)

HP-IB Message	Applicable	8350A Response	Related Comments	Interface Function	Message Type	Sample Statements	
						HPL (9825)	BASIC (9835,9845,85)
Status Byte	Yes	Responds to a Serial Poll with one 8-bit byte with the seventh most significant bit (bit 6 of bits 0 through 7) set if the 8350A is Requesting Service. Bit 2 indicates a status change has occurred that can be detected only by analyzing the extended status byte which is accessible with the Output Status function only.	SPE SPD	T6		rds(719)→A	STATUS 719; A or A=S POLL (719)
Status Bit	No	The 8350A does not respond to a Paralell Poll.	PPØ				
Pass Control	No	The 8350A does not have the ability to take or pass control of the HP-IB.	CØ				
Abort	Yes	Responds by terminating all Listener or Talker functions.	IFC	T6 L4		cli 7	ABORT TO 7

### 3-35. HP-IB Addressing

3-36. Certain messages require that a specific talker and listener be designated. Each instrument on the bus has its own distinctive listen and/or talk address which distinguishes it from other devices. Devices can be listen only, talk only, and both talker and listener.

3-37. Addressing usually takes the form of "universal unlisten command, device talk address, device(s) listen address(es)". The universal unlisten command removes all listeners from the bus, thereby allowing only the listener(s) designated by the device(s) listen address(es) to receive information. The information is sent by the talker designated by the talk address. The system controller may designate itself as either talker or listener.

3-38. Table 3-5 lists all the possible talk and listen addresses on the bus. The device address is

typically set via five binary bits which are the same for both listen and talk addresses, with the sixth and seventh bits used to determine when the address is listen (bits are 0,1) or talk (bits are 1,0). Some controllers distinguish between listen and talk automatically, requiring only the 5-bit code equivalent to designate a device.

### 3-39. 8350A HP-IB MESSAGE RESPONSES

3-40. The 8350A responds to the twelve bus messages as shown in Table 3-4.

### 3-41. 8350A HP-IB Compatibility.

3-42. Table 3-6 lists the 8350A Sweep Oscillators' HP-IB capability, which are compatible with IEEE Standard 488-1975.

Table 3-5. Possible HP-IP Addresses

ASCII Listen Address	Characters Talk Address	Address Code (Binary)					Equivalent Decimal Value
		5	4	3	2	1	
SP	@	0	0	0	0	0	00
!	A	0	0	0	0	1	01
"	B	0	0	0	1	0	02
#	C	0	0	0	1	1	03
\$	D	0	0	1	0	0	04
%	E	0	0	1	0	1	05
&	F	0	0	1	1	0	06
'	G	0	0	1	1	1	07
(	H	0	1	0	0	0	08
)	I	0	1	0	0	1	09
*	J	0	1	0	1	0	10
+	K	0	1	0	1	1	11
,	L	0	1	1	0	0	12
-	M	0	1	1	0	1	13
.	N	0	1	1	1	0	14
/	O	0	1	1	1	1	15
0	P	1	0	0	0	0	16
1	Q	1	0	0	0	1	17
2	R	1	0	0	1	0	18
3	S	1	0	0	1	1	19
4	T	1	0	1	0	0	20
5	U	1	0	1	0	1	21
6	V	1	0	1	1	0	22
7	W	1	0	1	1	1	23
8	X	1	1	0	0	0	24
9	Y	1	1	0	0	1	25
:	Z	1	1	0	1	0	26
;	[	1	1	0	1	1	27
<	\	1	1	1	0	0	28
=	]	1	1	1	0	1	29
>	↑	1	1	1	1	0	30

Table 3-6. 8350A Interface Functions

Code	Function
SH1	Source handshake capability
AH1	Acceptor handshake capability
T6	Basic talker; Serial Poll; Unaddress to talk if addressed to listen
L4	Basic listener; Unaddressed to listen if addressed to talk
SR1	Service Request capability
RL1	Remote; Local capability
PP0	No Parallel Poll capability
DC1	Device clear capability
DT1	Device trigger capability
C0	No controller capability
E1	Open collector bus drivers

**3-43. Compatible Universal and Addressed HP-IB Commands.**

3-44. The 8350A will respond to the following universal and addressed commands, which are sent in the command modes (ATN true).

Mnemonic	Command	ASCII Code
Universal:		
DCL	Device Clear	DC4
LLO	Local Lockout	DC1
MLA	My Listen Address	(selectable)
MTA	My Talk Address	(selectable)
SPD	Serial Poll Disable	EM
SPE	Serial Poll Enable	CAN
UNL	Unlisten	?
UNT	Untalk	-
Addressed:		
GET	Group Execute Trigger	BS
GTL	Go to Local	SOH
SDC	Selected Device Clear	EOT

**3-45. Remote Mode.**

3-46. Remote Capability. The 8350A communicates on the bus in both remote and local modes. In remote, its front panel controls are disabled except the LINE switch and LCL key. The 8350A can be addressed to listen or talk. When addressed to listen, the 8350A will automatically stop talking and respond to the following bus messages: Data, Trigger, Clear, Remote, Local, Local Lockout, Clear Lockout/Set Local, and Abort. When addressed to talk, the 8350A will automatically stop listening and send one of the following messages: Data, Require Service, or Status Byte.

3-47. Displays. The REM light is on when the 8350A is in the remote mode. The ADRS'D light is on when the 8350A is currently addressed to talk or listen. All other displays function the same as in local front panel control.

3-48. Local-to-Remote Change. The 8350A switches to remote upon receipt of the two part Remote message. The two parts of the Remote message are:

- Remote Enable (REN)
- Addressed to Listen (MLA)

3-49. The Sweep Oscillator's output signal and all control settings remain unchanged with the local-to-remote transition.

**3-50. Local Mode.**

3-51. Local Capability. In local, the 8350A can send a Require Service message, send a Status Byte, and respond to the Remote message.

**NOTE**

**The 8350A can respond to all HP-IB messages except the Data Message while in local. However, most of these messages would not normally be used in the local mode.**

3-52. Remote-to-Local Change. The 8350A returns to local control upon receipt of the Local or Clear Lockout/ Set Local message. It can also be set to local by pressing the front panel LCL key (assuming that local lockout is not in effect). The Sweep Oscillator's output signal and all control settings remain unchanged with the remote-to-local transition.

3-53. Local Lockout. When a data transmission is interrupted, which can happen by returning the 8350A to local with the front panel LCL key, the data could be lost. This would leave the 8350A in an unknown state. To prevent this, a local lockout is recommended to disable the LCL key. Local lockout remains in effect until the 8350A is returned to the local state by either turning the LINE switch off/on or by programming the Local Message.

**3-54. 8350A Address Assignment Information.**

3-55. The 8350A has a primary address that is determined by an internal storage register. The register is initialized upon power turn on by reading the address bits A5 through A1 from switches located on the 8350A A8 HP-IB Assembly. Note that these switches are factory preset to decimal 19 (Listen address of "3", Talk address of "S"). The 8350A HP-IB address can be dynamically changed from the front panel in local mode by executing the "Set HP-IB Address" function (Shift Local).

The present 8350A HP-IB address can be found by pressing the SHIFT followed by the LCL key.

3-56. The decimal equivalent of the talk/listen address will be displayed in the FREQUENCY/TIME display. Refer to Table 3-5 for interpretation of the equivalent decimal value into separate talk and listen address characters. To change the address refer to Figure 3-7 "Instrument State" for further information.

**3-57. Receiving The Data Message**

3-58. The 8350A accepts program codes that contain information for programming all of the front panel and special HP-IB only functions (except the LINE switch). The 8350A will respond to the Data message when in remote and addressed to listen.

3-59. Input Syntax. The 8350A responds to program codes in a Data message in the order in which they are received. Each function is programmed with a string of ASCII coded characters that follow one of the following sequences:

[Function Code] [Numeric Value] [Units Terminator] [EOS]  
 [Function Code] [Numeric Value] [EOS]  
 [Function Code] [EOS]

3-60. Function Codes. Function codes are typically 2 to 4 character mnemonics. For functions that have a numeric value associated with it, passing the function code only will enable and activate the function for further data entry.

3-61. Numeric Value. These are either a single decimal digit, a set of 14 characters or less representing a number, or a string of binary bytes. If the numeric value is a single digit (0 through 9), it represents a storage register. A string of 14 characters maximum can be expressed in exponential, decimal, or integer form. Acceptible numeric formats are referenced in further sections by the following format syntax:

Exponential	±d***d.d***E±dd
Decimal	±d***d.d***d
Integer	±d***d
Single Digit	d
Binary String	b***b
Binary Byte	b

Where the character 'd' indicates a leading or trailing zero, a space, or a numeric digit (0 through 9). The Characters "\*\*\*" indicate a variable number of the previous characters. The character 'b' indicates an 8-bit binary byte. Numeric values that are not binary in nature are scaled by the appropriate units terminator.

3-62. Units Terminator. These are 2 character codes that terminate and scale the associated numeric value. Frequency values can be entered in GHz, MHz, kHz, or Hz. Sweep time values can be entered in Seconds or milliseconds. Power values can be entered in dBm or dB. If a units terminator is not passed, the 8350A assumes the numeric value is in the fundamental units of Hz or Seconds.

3-63. End Of String Message (EOS). This can be the ASCII character Line Feed (LF, decimal 10), the bus END command (EOI and ATN true), or another function code string.

**NOTE**

The HP-IB program code syntax typically mirrors that of the local front panel keystroke sequence.

3-64. Valid Characters. The alpha program codes can be either upper or lower case since the 8350A can accept either type. Spaces, unnecessary signs (+, -), leading zeroes, and carriage returns (CR) are ignored.

3-65. Program Codes. See Table 3-7 for the summary of input programming codes that are acceptable via the Data message.

**3-66. Sending The Data Message.**

3-67. The 8350A can send Data messages when in remote and addressed to talk. The available output modes are:

- Learn String
- Micro Learn String
- Mode String
- Interrogate Function
- Active Function
- Status

3-68. Each function is activated by the 8350A receiving a Data message with the appropriate function code (refer to Table 3-7). The Learn String, Micro Learn String, Mode String, and Status functions send a Data message consisting of a string of 8-bit binary bytes terminated using the bus END command (EOI and ATN true) with the last byte. The Interrogate and Active functions send a Data message consisting of a 14 character ASCII string representing the numeric value and terminated with a Carriage Return/Line Feed (CR/LF).

3-69. Binary Syntax. [b\*\*\*b] [EOI]

3-70. Numeric Syntax. [ $\pm$ d.dddddE $\pm$ dd][CR][LF]

3-71. The character 'b' indicates an 8-bit binary byte and 'd' indicates a decimal digit (0 through 9). The Characters '\*\*\*' indicate a variable number of the previous characters. Note that the binary output format could have bytes that could be misinterpreted as Carriage Returns and/or Line Feeds so the user should defeat the ASCII CR/LF as a valid character string terminator.

### 3-72. Receiving The Trigger Message.

3-73. The 8350A responds to the Group Execute Trigger (GET) command to the HP-IB bus select code and a Selective Device Trigger to the 8350A HP-IB address. The effect of the GET command is to trigger the sweep if presently in the External Sweep Trigger mode only, otherwise no action is taken. The response is as if a Data message consisting of the Single Sweep Trigger (T4) program code were transmitted.

### 3-74. Receiving The Clear Message

3-75. The 8350A responds to both Device Clear (DCL) and Selective Device Clear (SDC) by resetting all HP-IB handshake lines to the inactive state. The effect is to remove the 8350A from any Talker or Listener control functions. The 8350A responds by clearing the Status Byte and the Extended Status Byte.

### 3-76. Receiving The Remote Message.

3-77. The Remote message causes the 8350A to switch to remote mode. It has two parts: 1) remote enable and 2) address-to-listen. The Sweep Oscillator's output and all other controls do not change with the local-to-remote transition.

3-78. The REM light turns on only when the 8350A is in remote mode and after receiving its first Data Message. The ADRS'D light turns on when the 8350A is addressed to talk or listen.

### 3-79. Receiving The Local Message.

3-80. The 8350A returns to front panel control when it receives the Local message. Its output and all other controls do not change with the remote-to-local transition.

3-81. When the 8350A goes to local mode, the front panel REM indicator turns off. However, the ADRS'D indicator would still illuminate if the 8350A were addressed.

3-82. The local message is the means by which the controller sends the Go To Local (GTL) bus command. The front panel LCL key can also return the 8350A to local mode. However, pressing the LCL key might interrupt a Data message to the 8350A and this would leave the 8350A in a state unknown to the controller. This situation could be avoided by sending the Local Lockout message which disables the LCL key.

### 3-83. Receiving The Local Lockout Message.

3-84. After receiving the Local Lockout message, the 8350A front panel LCL key is disabled in addition to all the other front panel keys. With local lockout in effect, the 8350A can be returned to local only by the controller or by turning the 8350A front panel LINE switch off/on.

### 3-85. Receiving The Clear Lockout/Set Local Message.

3-86. The 8350A responds to the Clear Lockout/Set Local message in the same way as to the Local message. Hence it returns to local front panel control. The 8350A need not be addressed to listen to receive this message.

### 3-87. Sending The Request Service Message.

3-88. The 8350A sends a Request Service message (RQS) whenever one of the following conditions exist and if it has been preprogrammed

Table 3-7. HP-IB Program Codes

Code	Description	Code	Description
AKm	Amplitude Marker On/Off	MPm	Marker 1-2 Sweep On/Off
ALmn	Alternate Sweep On/Off	MS	Milliseconds
A1	Internal Leveling	MZ	MHz
A2	External Crystal Leveling	M0	Marker Off
A3	External Power Meter Leveling	M1	Marker #1
BK	Backspace	M2	Marker #2
CAM	Amplitude Crystal Marker On/Off (83522/83525 Only)	M3	Marker #3
CF	Center Frequency	M4	Marker #4
Clm	Intensity Crystal Marker On/Off (83522/83525 Only)	M5	Marker #5
CW	CW Frequency	NT	Network Analyzer Trigger (8410B)
C1	1 MHz Crystal Marker Frequency (83522/83525 Only)	OA	Output Active Parameter
C2	10 MHz Crystal Marker Frequency (83522/83525 Only)	OL	Output Learn String
C3	50 MHz Crystal Marker Frequency (83522/83525 Only)	OM	Output Mode String
C4	External Crystal Marker Frequency (83522/83525 Only)	OP	Output Interrogated Parameter
DF	Delta F Frequency Span	OS	Output Status bytes
DM	dBm	OX	Output Micro Learn String
DN	Step Down/Decrement	PL	Power Level
DPM	Display Blanking On/Off	PSm	Power Sweep On/Off
DUm	Display Update On/Off	RCn	Recall Register
E	Exponent Power Of 10	RFm	RF Power On/Off
FA	Start Frequency	RM	Service Request Mask
FB	Stop Frequency	RPm	RF Blanking On/Off
FIm	CW Filter In/Out	RS	Reset Sweep
F1	-20 MHz/V FM	SC	Seconds
F2	-6 MHz/V FM	SF	Frequency Step Size
GZ	GHz	SH	Shift Function
HZ	Hz	SLm	Slope On/Off
IL	Input Learn String	SM	Manual Sweep
IP	Instrument Preset	SP	Power Step Size
IX	Input Micro Learn String	SS	Step Size
KZ	KHz	ST	Sweep Time
MC	Marker To Center Frequency	SVn	Save Register
MDm	Square Wave Amplitude Modulation On/Off	SX	external Sweep
MO	Marker Off	TS	Take Sweep
		T1	Internal Sweep Trigger
		T2	Line Sweep Trigger
		T3	External Sweep Trigger
		T4	Single Sweep
		UP	Step Up/Increment
		VR	CW Vernier
		0-9 + -	Acceptable Numeric Data

NOTES

1. Program codes of the form "XXm" use "m" to turn the function On or Off (1 or 0). For the storage register functions the "n" is 1 through 9.
2. The 8350A ignores spaces, plus signs, negative signs (except when valid) and any unexpected characters. Program codes can be upper or lower case alpha characters.

to send the message by the Service Request Mask (RM) function:

- Error in syntax
- Parameter value modified to default value
- Hardware failure
- End of sweep

3-89. The 8350A can send a Require Service message in either the local or remote mode. Further information pertaining to the instrument state can be obtained by conducting a Serial Poll or by executing the Output Status function, both of which access Status Byte information. The RQS state and the bus SRQ line are cleared only by executing a Serial Poll.

**3-90. Sending The Status Byte Message.**

3-91. After receiving a Serial Poll Enable command (SPE) and when addressed to talk, the 8350A responds by sending its Status Byte message as indicated in Table 3-8. A second status byte is available but must be accessed via the Output Status function. When the seventh most significant bit (bit 6, Request Service) of the Status Byte is true (one), an SRQ has occurred. See Service Request for the conditions causing a Service Request. Bit 4 indicates whether a change has occurred in the Extended Status Byte. If Bit 4 is

true, then the second status byte should be accessed via the Output Status function to determine the cause of the status change. All other bits indicate the present status of the noted function. The bits are true (one) if and only if the associated function/condition is true. To select an SRQ for a particular set of circumstances, both Status Bytes can be masked with the Service Request Mask function. The mask for each byte is determined by summing the decimal values of each selected function/condition that is desired. The default Service Request Mask Value is '00000000', or decimal 0. See Table 3-8 for decimal values of each Status Byte bit.

**3-92. Sending The Status Bit Message.**

3-93. The 8350A does not respond to the Parallel Poll Enable (PPE) bus command and thus cannot send a Status Bit message.

**3-94. Receiving The Pass Control Message.**

3-95. The 8350A does not have the ability to take or pass control thus it cannot respond to the Pass Control message.

**3-96. Receiving The Abort Message.**

3-97. The 8350A responds to the Abort message (IFC true) by stopping all Talker or Listener functions.

Table 3-8. Status Byte Information

STATUS BYTE (#1)								
BIT #	7	6	5	4	3	2	1	0
DECIMAL VALUE	128	64	32	16	8	4	2	1
FUNCTION	N/A	REQUEST SERVICE (RQS)	SRQ on Syntax Error	SRQ on End of Sweep	N/A	SRQ on Change in Extended Status Byte	N/A	SRQ on Numeric Parameter Altered to Default Value
EXTENDED STATUS BYTE (#2)								
BIT #	7	6	5	4	3	2	1	0
DECIMAL VALUE	128	64	32	16	8	4	2	1
FUNCTION	Airflow Failure	*RF Unleveled	Power Failure/on	N/A	N/A	N/A	N/A	Self Test Failed

\*Bit/Functions not usable with 86200 Series Plug-ins and 11869A Adapter.

### 3-98. OPERATOR'S MAINTENANCE

3-99. Operator's maintenance consists of replacing defective fuses, cleaning the air filter, and cleaning the plug-in interface connectors. These items are discussed in the following paragraphs.

#### 3-100. Fuses

3-101. There are twelve fuses in the 8350A. Only the ac line fuse located at the back of the instrument may be replaced by the Operator. The value for the ac fuse is printed on the rear panel of the instrument below the power module. The value and HP part number for the ac fuse may be found in Sections II (Installation) and IV (Replaceable Parts).

#### WARNING

For continued protection against fire hazard, replace only with 250 V fuses of the same current rating and type (normal blow).

3-102. To replace the ac fuse the Line switch should be switched off then the ac line cord removed from the power source and instrument. With the line cord removed, access may be gained to the fuse compartment. The fuse may be removed by pulling the lever inside the fuse compartment. The internal fuses should only be replaced by a qualified service technician.

#### WARNING

It is important that the following maintenance procedures be executed to retain the safety features which have been designed into the instrument.

#### 3-103. Air Filter

3-104. The cooling fan located on the rear panel has a metal filter attached which will require periodic cleaning. Due to the variety of environmental conditions the interval between cleanings cannot be estimated. Error signal E016 indicates reduced air flow through an increase in temperature in the cooling system. When this error is noted on display a clogged filter may be the reason. To clean the filter refer to Section 8 of the manual.

#### 3-105. Plug-in Interconnect

3-106. If plug-ins are changed frequently and/or the interconnectors are dirty the 8350A plug-in interconnect connector may require cleaning to avoid voltage losses (tune voltage).

#### 3-107. Service Tag Information

3-108. If the Sweep Oscillator requires service and the operators maintenance is not sufficient the instrument may be sent as per Section 2 to your local HP service organization. Before sending the instrument back, fill out and attach one of the blue service tags. If a sweep oscillator error code is noticed when a failure occurs, note that error code in the failure symptoms/special control settings section of the tag.



## FREQUENCY Sweep Mode

### DESCRIPTION

This function block contains the keys to select one of the three desired modes (START/STOP, CW, CF/ $\Delta$ F) or a modification of the mode (VERNIER, OFFSET). The two displays provide a visual display of the frequencies in the mode selected. The rotary control knobs provide a variable control to change the frequency of the function selected.

### PANEL LAYOUT

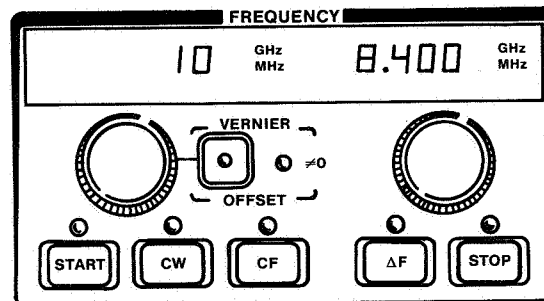

### FUNCTIONS/INDICATORS

**START:** Enables START/STOP mode and allows selection of the lower frequency limit of sweep.

**STOP:** Enables START/STOP mode and allows selection of the upper frequency limit of sweep.

**CW:** Enables single frequency (CW) mode and allows selection of the frequency.

**Swept CW:** Enables CW mode with full SWEEP OUTPUT voltage (0-10 volts).

**CF:** Enables center frequency/delta frequency mode and allows selection of the center frequency.

**$\Delta$ F:** Enables center frequency/delta frequency mode and allows selection of the total frequency span.

**VERNIER:** Provides high resolution adjustments to values of the effective sweep center and CW frequencies. Range is 0.1 percent of plug-in frequency band.

**OFFSET:** Offset RF frequency by entered value. START/STOP, CF/ $\Delta$ F, and CW displays do not indicate the change. Light indicates non-zero OFFSET value.

**$\neq 0$ :** This lamp indicates when a non-zero frequency vernier or offset value is in effect. To zero the vernier or offset, enter 0 MHz.

Figure 3-6. Frequency Sweep Mode (1 of 3)

**LIMITATIONS/CONCERNS**

1. The range of frequencies input to mainframe is determined by the plug-in (will accept values to  $\pm 2\%$  out of range).
2. CW resolution equals 4096 points per band (includes  $\pm 2\%$  overrange) except in VERNIER. Example; using a 2 to 8.4 GHz plug-in, 1.6 MHz is the resolution. The display range is 1 MHz to 99.99 GHz.
3. The order in which START/STOP or CF $\Delta$ F are entered is not important.
4. START frequency must be lower than STOP frequency. Entering a START frequency greater than the STOP frequency causes the STOP frequency to equal the START frequency. If the START frequency is greater than the STOP, then START equals the new STOP frequency.
5. Lights except as noted indicate active values/function.
6. Frequency values entered do not change when mode is changed.
7. Sweep Out provides a 0 to 10 volt ramp for all sweeps with 0 volts corresponding to the effective start frequency and 10 volts to the stop frequency. In CW mode the voltage out is equal to the percent of band (except swept CW).
8. Vernier value can "roll over" if knob or step causes the vernier value to exceed the maximum value then the CW/CF value is changed and the vernier value reset to 0 MHz (or appropriate value).

*Figure 3-6. Frequency Sweep Mode (2 of 3)*

**LOCAL FUNCTION PROCEDURES:**

Function	Activate	Data Forms				Range and Resolution
		On/Off	Knob	Step	Keyboard <sup>1</sup>	
Start Frequency	START		X	X	X	Range: See plug-in  Resolution: ±0.24% of band
Stop Frequency	STOP		X	X	X	
Continuous Wave	CW		X	X	X	
Swept CW	SHIFT ΔF		X	X	X	
Center Frequency	CF		X	X	X	
Delta Frequency	ΔF		X	X	X	
Offset	SHIFT VERNIER		X	X	X	Range: ±0.05% of plug-in  Resolution: ±.0008% of band
Vernier	VERNIER		X	X	X	

<sup>1</sup> Values must end with terminator (GHz or MHz).

**REMOTE FUNCTION PROCEDURES:**

Mode	Function	Program Code				
		Suffix	Scale	Resolution	Range	Resolution
START/STOP	Start	FA	Plug-in	±0.24%	GZ MZ KZ HZ	X10 <sup>9</sup> X10 <sup>6</sup> X10 <sup>3</sup> X1
	Stop	FB				
CW	CW	CW				
	Swept CW	SH CW				
CF/ΔF	Center Frequency	CF				
	Delta Frequency	DF				
OFFSET	Frequency Offset	SH VR				
VERNIER	Frequency Vernier	VR	±0.05% of band	±.0008%		

<sup>1</sup> Depends on plug-in used: 1KHz if <2 GHz in 83525 or 83522.

Figure 3-6. Frequency Sweep Mode (3 of 3)

## INSTRUMENT STATE

### DESCRIPTION

This function block contains two LEDs one that indicates whether Sweep Oscillator is in the remote mode, and another indicates when it is addressed to talk or listen. The local key when not in local lockout will switch the Sweep Oscillator from remote to local (front panel) control. The Instrument Preset key when engaged will first run the Sweep Oscillator self test then set the controls to the preset condition.

### PANEL LAYOUT



### FUNCTIONS/INDICATORS

**LCL:** Returns Sweep Oscillator control to front panel from remote operation unless a Local Lockout has been executed. The 8350A retains the same control settings when switched from remote to local.

**Select HP-IB Address:** Provides a way to see and change the current HP-IP address code (0 to 30). The code is displayed in the FREQUENCY/TIME display.

**INSTR PRESET:** The following two steps take place when instrument preset is engaged or the sweep oscillator is switched on. Plug-in related error (E050 to E059) information is found in the plug-in manual.

1. A self test of the entire instrument is begun that takes approximately 1½ seconds to complete. If an error is found the test stops and an error code is displayed. Section 8 has a list of error codes and failures.
2. After self test the sweep oscillator presets the controls as follows:

**SWEEP MODE:** START/STOP, over the full frequency range of the plug-in

**SWEEP TIME:** fastest allowable for plug-in

**Markers/Modulation:** off, Marker frequency values reset to center of band

**Vernier/Offset:** 0 MHz

**SAVE/RECALL:** all registers set to INSTR PRESET value (if Opt. 001 Non-volatile memory, values unchanged)

When using 83500 series plug-ins:

**POWER LEVEL:** maximum leveled value

**RF, CW Filter:** on

**ALC MODE:** INT

**CRYSTAL MARKERS:** off (50MHz lamp on)

*Figure 3-7. Instrument State (1 of 2)*

**REMOTE:** Sets Sweep Oscillator into remote HP-IB operation.

**LIMITATIONS/CONCERNS**

1. Local key will not function if a Local Lockout has been implemented.
2. Allowable HP-IB addresses are from 0 thru 30. However the value 21 is typically reserved for the controller and should be avoided.
3. The HP-IB address set remains in effect until line power is turned off. At power turn on the internal HP-IB address switches are read and used as the address unless 8350A Option 001 is used. If Option 001 is used, the HP-IB address will remain unchanged.
4. If an instrument problem occurs Section 8 of the manual contains some operator initiated tests. These tests may isolate problems to enable service (via blue tag) to repair them faster.

**LOCAL FUNCTION PROCEDURE:**

Function	Activate	Data Forms				Range and Resolution
		On/Off	Knob	Step	Keyboard	
Local Key	LCL	X				
Select HP-IB Address	SHIFT LCL				X <sup>1</sup>	Integers from 0 to 30
Instrument Preset	INSTR PRESET	X				
Remote	Not Available					

<sup>1</sup> Address entered only after pressing the GHz, MHz, or dBm keys.

**REMOTE FUNCTION PROCEDURE:**

Mode	Function	Program Code				Resolution
		Prefix				
Local	Use HP - IB Command					
Select HP-IB Address	Not Available					
Instrument Preset	Instrument Preset	IP				
Remote	Use HP - IB Command					

Figure 3-7. Instrument State (2 of 2)

## FREQUENCY Markers/Sweep TIME-Marker Transfer

### DESCRIPTION

The frequency marker functions consist of up to five independent and continuously variable frequency markers. The Marker  $\Delta$  function displays the difference frequency between any two markers. MKR  $\rightarrow$  CF sets the effective sweep center frequency (CF) equal to the active marker frequency. MARKER SWEEP initiates/exits sweep between Marker 1 and Marker 2. After exit, sweep returns to original sweep limits. The FREQUENCY/TIME display will display active marker frequency, Marker  $\Delta$  frequency, Sweep Time, or frequency in manual sweep mode.

### PANEL LAYOUT

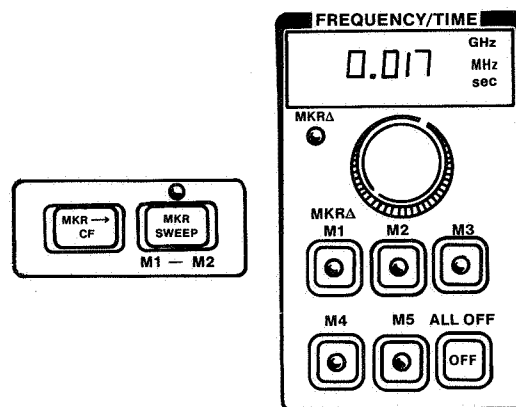

### FUNCTIONS/INDICATORS

**Markers 1 to 5:** Each marker (M1 through M5) can be enabled and a frequency value defined. The last marker engaged is the active marker and it is the one modifiable by the control, step keys, keyboard, or remote control. Lamp off indicates marker off, lamp on, indicates marker on and lamp flickering indicates marker is active.

**Active marker off:** Turns off the active frequency marker and saves previous previous value. The value is recalled when marker is turned on later.

**All Markers Off:** Turns off all frequency markers saving the values of each to be recalled later when markers are turned on.

**Marker Delta:** Selects the MKR  $\Delta$  mode where the FREQUENCY/TIME display indicates the frequency difference between the active frequency marker and the previously active frequency marker. The active marker is still active and modifiable via the FREQUENCY/TIME knob, step keys, keyboard or remotely. If in intensity marker mode the display trace is intensified between the two selected frequency markers.

**Marker to Center Frequency:** This function takes the value of the presently active frequency marker and reassigns it to the CW frequency, Center Frequency, or effective center frequency of the Start/Stop sweep. The frequency marker value is unchanged, the previous center frequency value is lost.

Figure 3-8. Frequency Markers/Sweep Time – Marker Transfer (1 of 4)

**Marker Sweep:** This function temporarily uses the values of Markers 1 and 2 and reassigns them to the Start and Stop frequencies respectively. The previous values of the Start and Stop frequencies are saved and reassigned when exiting Marker Sweep mode. If Marker 1 is greater than Marker 2 (or M2 less than M1) the lower frequency is used for the Start frequency, and the higher value for the Stop frequency. Note that the values of Markers 1 and 2 and hence the temporary Start and Stop frequency values can be modified in marker sweep mode by using either the start or the stop controls or M1 or M2 controls. The new values of M1 and M2 are retained upon exiting Marker Sweep mode.

**Marker 1 to Start, Marker 2 to Stop:** This functions the same as marker sweep except that the Start and Stop frequencies are permanently reassigned and not restorable to their previous values.

**Counter Interface Enable and Disable:** When Sweep Oscillator is used in swept mode this function enables the use of the 5343A Microwave Frequency Counter to count Start, Stop, or Marker frequencies.

### LIMITATIONS/CONCERNS

1. All frequency markers are initialized to the value of the center frequency of the frequency range of the plug-in at power on.
2. Frequency markers if active and the present value is out of the present sweep frequency range, will be reassigned the value of the present effective center frequency when the FREQUENCY/ TIME knob is first turned.
3. If no markers are presently active when entering MKR  $\Delta$ , Markers 1 and 2 are assumed the active and previously active markers respectively.
4. If Marker 1 frequency is higher than Marker 2 frequency then these values are permanently interchanged in Marker Sweep mode.
5. Start and Stop values are modified to correspond to the new center frequency and old sweep width in MKR  $\rightarrow$  CF. Likewise the  $\Delta$  Frequency Span and Start/Stop may be modified so that the new frequency sweep is within the frequency range of the plug-in.
6. If no marker is presently active the previously active marker is assumed. At power on Marker 1 is assumed to be the active marker.
7. If Marker 1 and/or Marker 2 are not on when entering Marker Sweep mode, they are turned on and their previous values used. At power on, all markers are assigned the value of the effective center frequency of the plug-in frequency range.
8. If sweep width is out of range when MKR  $\rightarrow$  CF is engaged it will automatically scale down the  $\Delta$  Frequency to be within plug-in frequency range.
9. The plug-in and markers have the capability of 2 percent frequency overrange, if this occurs a flickering of the GHz or MHz indicators will occur.

**LOCAL FUNCTION PROCEDURE:**

Function	Activate	Data Forms				Range and Resolution
		On/Off	Knob	Step	Keyboard <sup>1</sup>	
Markers	M1 to M5		X	X	X	
Marker Δ	SHIFT M1		X	X	X	
Marker to Center Frequency	MKR - CF		X	X	X	Range See plug-in Resolution: .024% of band
Marker Sweep	MKR SWEEP	X	X	X	X	
Permanent Marker Sweep	SHIFT MKR SWEEP		X	X	X	
Turn Off Active Marker	OFF	X				
Turn Off All Markers	SHIFT OFF	X				
Counter Interface Enable	[function] SHIFT M2	X				
Counter Interface Disable	SHIFT M3	X				

<sup>1</sup> Values must end with terminator (GHz or MHz).

Figure 3-8. Frequency Markers/Sweep Time - Marker Transfer (3 of 4)



**REMOTE FUNCTION PROCEDURE:**

Mode	Function	Program Code				
		Prefix	Range	Resolution	Suffix	Scale
Markers	Select and Position Markers	M1 to M5	Plug-in	.024%		
Δ Marker	Displays Difference Frequency	SH M1			GZ MZ KZ HZ	X10 <sup>9</sup> X10 <sup>6</sup> X10 <sup>3</sup> X <sup>1</sup>
MKR + CF	Active Marker To	MC				
MARKER SWEEP	Sweep ON M1 and M2 OFF	MP1 MP0				
MARKER SWEEP	Permanent Marker Sweep	SH MP				
OFF	Active Marker Off	M1 to M5			MO MO	
ALL OFF	All Markers Off	SH			MO MO	
Counter Interface Enable	Counting End Points or Marker On Swept Frequency	FA, FB, or M1 to M5 SH M2				
Counter Interface Disable	Disables Swept Counting	SH M3				

Figure 3-8. Frequency Markers/Sweep Time – Marker Transfer (4 of 4)

## Storage Registers

### DESCRIPTION

The Save n function allows all the control settings to be stored in one of the nine internal registers. The Recall n function will implement the previously stored settings. Alternate n function alternates between current state and register selected on successive sweeps.

### PANEL LAYOUT

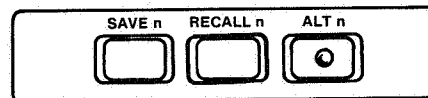

### FUNCTIONS/INDICATORS

**SAVE :** Enables current settings (modes, frequencies etc.) to be stored in a register. Nine registers are available for storage (1 through 9).

**RECALL:** Enables a resetting of one of the nine stored register modes. When enabled the registers may be incremented with the UP control or decremented with the down control. Registers not previously stored will contain the instrument preset settings.

**Alternate:** Alternates between current state and selected stored register on successive sweeps. If used with appropriate HP 8755C, current state response is on channel 1 and selected state response is on channel 2.

### LIMITATIONS/CONCERNS

1. Unused registers have instrument preset values stored until new new values are stored.
2. The instrument preset function sets all registers to instrument preset settings except in Option 001 instruments which retain stored settings even with AC power off.
3. Remote Step Up Advance (Programming Connector) or Auto Step allows cycling of storage registers.

Figure 3-9. Storage Registers (1 of 2)

**LOCAL FUNCTION PROCEDURE:**

Function	Activate	Data Forms				Range and Resolution
		On/Off	Knob	Step	Keyboard	
Store Settings	SAVEN				X	Integers 1 to 9
Recall Settings	RECALLn			X <sup>1</sup>	X	Integers 1 to 9
Alternate Sweep Settings	ALn			X <sup>1</sup>	X	Integers 1 to 9
Alternate Sweep Off	ALn	X			X	

<sup>1</sup> Step keys activated only after a number has been entered.

**REMOTE FUNCTION PROCEDURE:**

Mode	Function	Program Code				
		Prefix	Range	Resolution	Suffix	Scale
SAVE	Store Current Settings	SV	Register 1 to 9			
RECALL	Resets Stored Settings	RC	Register 1 to 9			
ALTERNATE	Successive Sweep Selected and Current	AL1	Register 1 to 9			
	Alternate Off	ALO				

Figure 3-9. Storage Registers (2 of 2)

## SWEEP/SWEEP TRIGGER

### DESCRIPTION

This function Block contains seven keys for control of sweep source and time. This block also has a SWP LED to indicate sweep in progress. The SWEEP type keys enable selection of EXT, MAN or TIME sweep controls. The SWEEP TRIGGER keys enable selection of INTERNAL, LINE, EXTERNAL and SINGLE sources of sweep triggering. Lights on keys indicate active function.

### PANEL LAYOUT

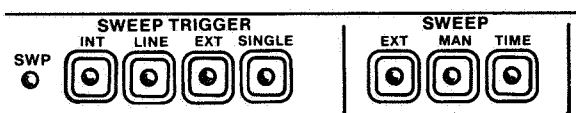

### FUNCTIONS/INDICATORS

**SWEEP EXTERNAL:** Enables sweep input via front or rear panel SWP input BNC (SWP INPUT 0 to 10 volts) to externally tune plug-in oscillator.

**SWEEP MANUAL:** Enable manual control of sweep voltage via frequency inputs. Manual frequency is displayed on FREQUENCY/TIME display.

**SWEEP TIME:** Enables internally timed sweep. The triggering for TIME may be one of the following sweep trigger modes.

**INT:** Enables internal sweep triggering (free run, auto).

**LINE:** Enables triggering by power line frequency.

**SWEEP TRIGGER EXT:** Enables external triggering of sweep via rear panel auxiliary connector pin 9. A two volt trigger (20 volts max) must be supplied to auxiliary connector.

**SINGLE:** Selects and/or triggers or aborts single sweep.

### LIMITATIONS/CONCERNS

1. SWEEP TRIGGER controls work only in TIME sweep mode.
2. Using the step keys with sweep time forces specific values in a 1,2,5 sequence such as 10ms, 20ms, 50ms, 100ms, etc. No step value can be set for sweep time.
3. When first engaged, single sweep is selected if in a different sweep trigger mode. If presently in single sweep, this triggers a new sweep.

*Figure 3-10. Sweep/Sweep Trigger (1 of 2)*

**LOCAL FUNCTION PROCEDURE:**

Function	Activate	Data Forms				Range and Resolution
		On/Off <sup>3</sup>	Knob	Step	Keyboard <sup>1</sup>	
SWEEP TYPE External	EXT	X				
Manual	MAN		X	X	X	Range: Present Sweep Width Resolution: 0.01% of present sweep
Time	TIME		X	X <sup>2</sup>	X	Range: 0.01 to 100 sec. <sup>4</sup> . Resolution: 0.001 sec.
SWEEP TRIGGER Internal	INT	X				
Line	LINE	X				
External Volts	EXT	X				2 to 5 Volts Input
Single Activates	SINGLE					Key and Triggers

<sup>1</sup> Values must end with terminator (GHz, MHz, S, or mS).

<sup>2</sup> The step size may not be set for time.

<sup>3</sup> Each mode (except TIME) disables other modes.

<sup>4</sup> The limit for broad band sweeps is higher than 0.01 second.

**REMOTE FUNCTION PROCEDURE:**

Mode	Function	Program Code				
		Prefix	Range	Resolution	Suffix	Scale
Sweep Type	External	SX				
	Manual	SM	Frequency		GZ MZ KZ HZ	X10 <sup>9</sup> X10 <sup>6</sup> X10 <sup>3</sup> X1
	Time	ST	0.01–100 second	0.001 second	SC MS	X1 second X10 <sup>-3</sup> seconds
Sweep Trigger	Internal	T1				
	Line	T2				
	External	T3				
	Single	T4				

Figure 3-10. Sweep/Sweep Trigger (2 of 2)

## DATA ENTRY-Step Keys/Keyboard

### DESCRIPTION

This function block contains the step key function, numeric entry keyboard and terminators which allow modification of many of the values of functions. This function block has a back key which works like an erase or rubout of the last entry. Also in this function block is a shift key (blue) which enables shift key functions.

### PANEL LAYOUT

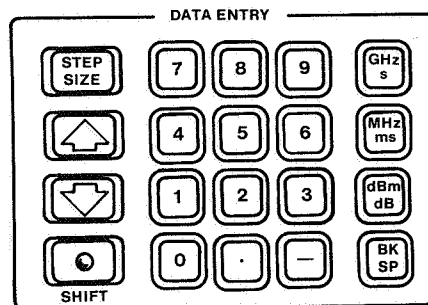

### FUNCTIONS/INDICATORS

**STEP SIZE:** This function allows the setting of the frequency or power level step size.

**▲ (step up):** This function increments the presently active parameter value by the appropriate step size.

**▼ (step down):** This function decrements the presently active parameter value by the appropriate step size.

**0-9, -, .:** Numeric digits, sign, and decimal point useable to input data for active function.

**BACK SPACE:** This function performs a character back space, or rubout, to erase the last digit entered on the present numeric entry. Function enabled only when entering a number and units terminator have not been entered.

**GHz/s:** Units terminator for Gigahertz frequency data or seconds time data.

**MHz/ms:** Units terminator for Megahertz frequency data or millisecond time data.

**dBm/dB:** Units terminator for dbm or dB power data.

**SHIFT (blue key):** This function enables the "shift" functions that are labeled in blue on the front panel or required key code in remote HP-IB.

### LIMITATIONS/CONCERNS

1. Step size not settable for sweep time. It is a 1,2,5 data progression like 10 msec, 20 msec, 50 msec, 100msec, etc.
2. No visible data display for step size values.
3. Step size entry is differentiated via units terminator (ie. frequency or power step).
4. All numeric entries are not input/entered until the appropriate units terminator is entered.
5. Auto Step via depressing up or down key causes the active parameter to be stepped as long as the key is depressed.
6. The dBm/dB key will be a default value of Hz or sec.

*Figure 3-11. Data Entry- Step Keys/Keyboard (1 of 2)*

7. Negative numeric data must be entered with negative sign first.
8. Blank and unnecessary negative signs are ignored by the sweep oscillator.
9. Some shift functions are not labeled on the front panel, References Shift Function section.
10. Shift key indicator on until a correct shift function key stroke is entered.
11. The default Step Size values are 0.1% of the present  $\Delta F$  for frequency parameters, 1 dB for power parameters.

**LOCAL FUNCTION PROCEDURE:**

Function	Activate	Data Forms				Range and Resolution
		On/Off	Knob	Step	Keyboard	
STEP SIZE Frequency	(Frequency Parameter) <b>STEP SIZE</b>		X	X	X	Range: See plug-in frequency limits. Resolution: 1 MHz
STEP SIZE Power	(Power Parameter) <b>STEP SIZE</b>		X X	X X	X X	Range: See plug-in power limits Resolution: 0.01 dB
Reset to default STEP SIZE	<b>SHIFT</b> <b>STEP SIZE</b>	X				

**REMOTE FUNCTION PROCEDURE:**

Mode	Function	Program Code				
		Prefix	Range	Resolution	Suffix	Scale
STEP SIZE	Frequency Step Size	SF	See Plug-in Frequency Limits	1 MHz	GZ MZ KZ HZ	X10 <sup>9</sup> X10 <sup>6</sup> X10 <sup>3</sup> X1
	Power Step Size	SP	See Plug-in	0.1 dB	DM	
STEP INCREMENT	Step Up (▲)	UP				
STEP DECREMENT	Step Down (▼)	DN				
BACK SPACE	Back Space	BK				
Default STEP SIZE	Reset to default STEP SIZE	SH SS				

Figure 3-11. Data Entry – Step Keys/Keyboard (2 of 2)

## Modulation/Blanking

### DESCRIPTION

This function block controls the frequency marker display mode, RF power and external CRT control. Mainframe frequency markers can be RF amplitude dips or CRT intensity dots (via Z-axis control). The RF power can be turned off during the retrace sweep. The CRT display retrace sweep can be blanked. The internal squarewave amplitude modulation can be enabled. The squarewave frequency is 27.8 KHz standard for proper operation with the HP 8755 Frequency Response Test Set or internally selectable (see Section IV) for 1 KHz for proper operation with the HP 415 SWR Meter and other instruments. The sweep input/output connector is also in this block.

### PANEL LAYOUT

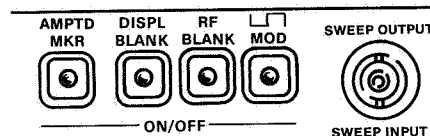

### FUNCTIONS/INDICATORS

**AMPLITUDE MARKER:** This function when engaged (light on) sets the mainframe frequency markers into RF amplitude dips instead of CRT intensity dots (via Z-axis control).

**DISPLAY BLANKING:-** This function when engaged (light on) blanks the retrace sweep on CRT displays via Z-axis control.

**RF BLANKING:** This function when engaged (light on) blanks (turns off) the RF power during the retrace sweep.

**□ SQUAREWAVE MODULATION:** This function when engaged (light on) enables the internal amplitude modulation squarewave. The standard squarewave frequency is 27.8 KHz, internally selectable to 1 KHz.

**SWEEP OUTPUT/INPUT:** When Sweep Oscillator is in manual or time sweep mode this connector provides a linear ramp voltage from 0 to 10 volts that is synchronous with RF sweep. In external sweep mode connector is input for a sweep ramp from 1 to 10 volts.

### LIMITATIONS/CONCERNS

1. Changing frequency of modulation (1 or 27.8 KHz) requires removal of a jumper (see Adjustment section).
2. Plug-in frequency markers are controlled from plug-in for CRT intensity dots or RF amplitude dips.

Figure 3-12. Modulation/Blanking (1 of 2)



3. Internal squarewave modulation and a External AM signal can be used simultaneously.
4. CRT Z-axis control is provided with both positive and negative polarity control for blanking (via rear panel POS Z-BLANK or NEG Z-BLANK). Mainframe frequency markers, when used in the CRT intensity dot mode are useable with positive polarity Z-axis control only.

**LOCAL FUNCTION PROCEDURE:**

Function	Activate	Data Forms				Range and Resolution
		On/Off	Knob	Step	Keyboard	
Amplitude Markers	AMPTD MKR	X				
Display Blanking	DSPL BLANK	X				
RF Blanking	RF BLANK	X				
Squarewave Modulation	□ MOD	X				

**REMOTE FUNCTION PROCEDURE:**

Mode	Function	Program Code				
		Prefix	Range	Resolution	Suffix	Scale
Amplitude Markers	Amplitude Marker On	AK1				
	Amplitude Marker Off	AK0				
Blanking	Display Blanking On	DP1				
	Display Blanking Off	DP0				
Blanking	RF Blanking On	RP1				
	RF Blanking Off	RP0				
Modulation	□ Modulation On	MD1				
	□ Modulation Off	MD0				

Figure 3-12. Modulation/Blanking (2 of 2)

## POWER Control

### DESCRIPTION

This function block contains all functions relating to the RF output power level. The desired power level can be set. To compensate for a linear loss through a device (like a cable) on the output of the plug-in, a slope compensation can be set to level the output. To provide a ramp of output power, a power sweep width can be set and the Power Sweep function enabled. Power Sweep starts the RF output power at the Power Level setting then ramps up the specific Power Sweep width.

### PANEL LAYOUT

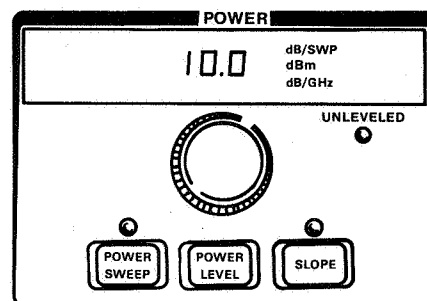

### FUNCTIONS/INDICATORS

**POWER LEVEL:** This function when enabled (light on) allows setting of the output power level for all ALC modes. Calibrated power level in internal leveling mode only.

**POWER SWEEP:** This function when enabled (light on) allows setting of the power sweep width (in dB) for the power sweep function. Power Sweeps from Power Level to Power level plus Power Sweep width.

**SLOPE:** This function when engaged (light on) allows setting of the frequency slope compensation in dB/GHz. Allows compensation for lossy devices to achieve a flat, leveled output power at output of device/cable by increasing the output power at higher frequencies.

**UNLEVELED Light:** Light is on when all or portion of sweep is unleveled.

**POWER Display:** Provides digital display of Power Level and Power Sweep to a tenth of a dB and Slope to 0.01 dB. The units for power level are dBm, for power sweep dB, and for slope it is dB/GHz.

Figure 3-13. Power Control (83500 series Plug-ins) (1 of 2)

**LIMITATIONS/CONCERNS**

1. Power level control is calibrated over a 10 dB range, typically 15 dB. Power Level range up to 80 dB with plug-in Option 001 (70 dB Step Attenuator).
2. The total combined Slope and Power Sweep range is 15 dB.
3. Power Sweep will not cross a Step Attenuator boundary.
4. Power Sweep and Slope values may not be negative.

**LOCAL FUNCTION PROCEDURE:**

Function	Activate	Data Forms				Range and Resolution
		On/Off	Knob	Step	Keyboard <sup>1</sup>	
Power Level	POWER LEVEL		X	X	X	Range: See plug-in Resolution: 0.024 dB
Power Sweep	POWER SWEEP		X	X	X	
Slope	SLOPE		X	X	X	

<sup>1</sup> Values must end with terminator (dBm or dB).

**REMOTE FUNCTION PROCEDURE:**

Mode	Function	Program Code				
		Prefix	Range	Resolution	Suffix	Scale
Power	Level	PL	10-15 dB	0.01dBm	DM	X1 dBm X1 dB
Power	Sweep On	PS1	25.5 dB			
	Sweep Off	PS0				
	Slope On	SL1	5 dB/GHz			
Slope Off	SLO					

Figure 3-13. Power Control (83500 series Plug-ins) (2 of 2)

### Signal Control

#### DESCRIPTION

This function block controls the signal purity and switches the signal RF off or on. The CW Filter, when enabled, reduces the oscillator tuning voltage noise and hence Residual FM. The CW Filter is inactive in sweep modes.

#### PANEL LAYOUT

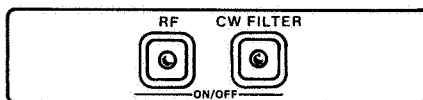

#### FUNCTIONS/INDICATORS

**RF ON/OFF:** This function switches RF power on (light on) or off ( $\geq 30\text{dB}$  attenuation).

**CW FILTER ON/OFF:** This function enables (light on) or disables the oscillator tune voltage filter when in CW or manual sweep modes only.

#### LIMITATIONS/CONCERNS

1. CW filter not enabled during sweeps.

#### LOCAL FUNCTION PROCEDURE:

Function	Activate	Data Forms				Range and Resolution
		On/Off	Knob	Step	Keyboard	
RF Power	<b>RF</b>	X				
CW Filter	<b>CW FILTER</b>	X				

#### REMOTE FUNCTION PROCEDURE:

Mode	Function	Program Code				
		Prefix	Range	Resolution	Suffix	Scale
RF	Power On Power Off	RF1 RF0				
CW Filter	Filter On Filter Off	FI1 FI0				

Figure 3-14. Signal Control (83500 series plug-ins)

## ALC MODE

### DESCRIPTION

This functional block controls all Automatic Leveling Control (ALC) functions of the output power. Several modes of ALC can be selected, these are Internal, External via a Crystal/Detector, or external via a Power Meter.

### PANEL LAYOUT

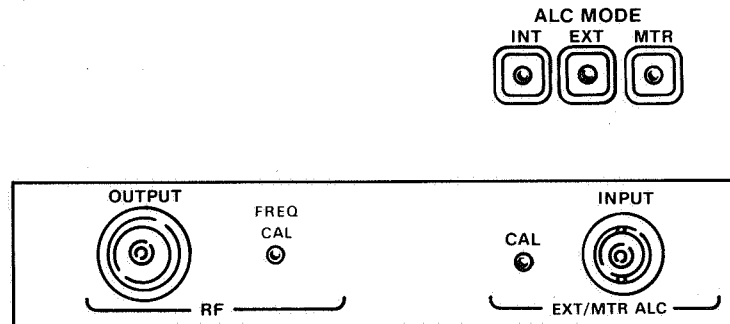

### FUNCTIONS/INDICATORS

**INTERNAL ALC:** This selects the internal crystal detector/coupler for leveling the output power at the front panel output connector.

**EXTERNAL ALC:** This selects the external crystal detector for leveling with the detector output applied to the front panel External ALC BNC input connector.

**METER ALC:** This selects the external power meter for leveling with the power meter output applied to the front panel External ALC input connector.

**EXT/MTR/ALC INPUT:** Input connector for External crystal detector and power meter outputs.

**ALC CAL:** Used to adjust external leveling gain when using EXTERNAL leveling. Clockwise rotation increases gain.

**FREQUENCY CAL:** Adjustment that allows calibrating the RF plug-in frequency using the crystal markers, frequency marker indicator, and a CW or Start Frequency value.

### LIMITATIONS/ CONCERNS

1. Only crystal detectors of negative polarity ( $-10$  to  $-150$  millivolts) can be used.
2. Only power meter outputs of 0 to 1 volts can be used. The HP 431 and 432 series are compatible, the HP 435 and 436 are not.

Figure 3-15. ALC Mode (83500 series plug-ins) (1 of 2)

**LOCAL FUNCTION PROCEDURE:**

Function	Activate	Data Forms				Range and Resolution
		On/Off <sup>1</sup>	Knob	Step	Keyboard	
Internal Leveling	INT	X				
External Leveling	EXT	X				
Power Meter Leveling	MTR	X				

<sup>1</sup> Each mode disables all other appropriate modes.

**REMOTE FUNCTION PROCEDURE:**

Mode	Function	Program Code				
		Prefix <sup>1</sup>	Range	Resolution	Suffix	Scale
ALC Leveling	INTERNAL	A1				
	External Crystal	A2				
	External Power Meter	A3				

<sup>1</sup> Mode disables all other possible modes.

**FREQUENCY MARKER INDICATOR:** Lamp lites when RF output frequency is coincident with the selected crystal marker frequency.

Figure 3-15. ALC Mode (83500 series plug-ins) (2 of 2)

## Crystal MARKER FREQUENCY

### DESCRIPTION

This functional block controls the crystal frequency markers by selection of the marker crystal frequency and the marker display mode (intensity or amplitude). Crystal frequency combs of 1 MHz (usable below 1 GHz), 10 MHz, 50 MHz, or an external frequency may be input to the rear panel External Marker input. The crystal frequency markers can be displayed independent of the mainframe frequency markers in their CRT intensity dot (via Z-axis control) and/or RF amplitude dips.

### PANEL LAYOUT

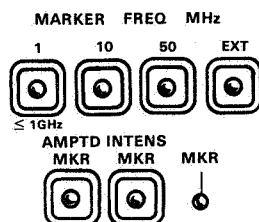

### FUNCTIONS/INDICATORS

**1 MHz CRYSTAL:** Selects (light on) a crystal frequency comb of markers at harmonics of 1 MHz.

**10 MHz CRYSTAL:** Selects (light on) a crystal frequency comb of markers at harmonics of 10 MHz.

**50 MHz CRYSTAL:** Selects (light on) a crystal frequency comb of markers at harmonics of 50 MHz.

**EXTERNAL FREQUENCY:** Selects frequency markers at the RF frequencies that are input to the rear panel External Marker input to the rear panel External Marker input. Allowable RF power range at input is  $-10$  dBm minimum to  $+10$  dBm maximum.

**INTENSITY MARKER:** Sets the marker display mode to CRT intensity dots via Z-axis control.

**AMPLITUDE MARKER:** Sets the marker display mode to RF amplitude dips.

**EXTERNAL MARKER INPUT:** Rear panel input for external frequency marker. Maximum drive range  $-10$  to  $+10$  dBm.

Figure 3-16. Crystal Marker Frequency (83500 series plug-ins) (1 of 2)

**LIMITATIONS/CONCERNS**

1. Plug-in markers display modes are independent of the 8350A mainframe markers. Hence any combination of intensity or amplitude markers will work.
2. Intensity markers obtainable using the positive polarity Z-axis output only.
3. Maximum drive level of External Marker Input is +10 dBm.
4. Plug-in markers can be intensity and amplitude variety simultaneously.

**LOCAL FUNCTION PROCEDURE:**

Function	Activate	Data Forms				Range and Resolution
		On/Off	Knob	Step	Keyboard	
1 MHz Marker	1	X				
10 MHz Marker	10	X				
50 MHz Marker	50	X				
External	EXT	X				
Amplitude Markers	AMPTD MKR	X				
Intensity Markers	INTENS MKR	X				

**REMOTE FUNCTION PROCEDURE:**

Mode	Function	Program Code				
		Prefix	Range	Resolution	Suffix	Scale
Crystal Marker Frequency	1 MHz <sup>1</sup>	C1				
	10 MHz <sup>1</sup>	C2				
	50 MHz <sup>1</sup>	C3				
	External Input <sup>1</sup>	C4				
Crystal Marker	Amplitude MKR On Amplitude MKR Off	CA1 CA0				
	Intensity MKR On Intensity MKR Off	CI1 CI0				

<sup>1</sup> Mode disables the previous mode.

Figure 3-16. Crystal Marker Frequency (83500 series plug-ins) (2 of 2)



## HP-IB ONLY FUNCTIONS

### DESCRIPTION

This section describes functions which are only accessible via the HP-IB. These functions allow the HP-IB user to learn about the present instrument state, setup the instrument state, and enable some special functions to improve HP-IB operation.



### FUNCTIONS

**INPUT/OUTPUT LEARN STRING:** A string of 90 bytes of binary data that completely describes the present instrument state (does not include the storage registers) of the 8350A and 83500 Series Plug-in. This information is packed and encoded for minimal storage requirements thereby making data analysis difficult. If data analysis is necessary, use the Output Mode String and Output Interrogated Parameter functions instead. When output from the 8350A and stored in an ASCII character data string, the Learn String can later be input to the 8350A to restore that instrument state. The length of the Learn String is fixed, independent of the functions selected and the plug-in used.

The Output Learn String function learns the present sweeper settings only. To learn the storage register settings, sequentially recall each storage register then learn the present sweeper settings. Likewise to restore the storage registers, input the learn string for the appropriate storage register then save the present sweeper settings in the proper register.

**INPUT/OUTPUT MICRO LEARN STRING:** A string of 8 bytes of binary data that completely describes the present CW Frequency, Vernier, Sweep Output voltage, and Power Level of the 8350A and 83500 Series Plug-in. This information is packed and encoded for minimal storage requirements thereby making data analysis difficult. When output from the 8350A and stored in an ASCII character data string, the Micro Learn String can later be input to the 8350A to restore the instrument state for rapid CW frequency programming. The length of the Micro Learn String is fixed, independent of the functions selected and the plug-in used.

In this mode the 8350A numeric displays are blanked and the Micro Learn String bytes are used to pre-load the appropriate internal DAC's. For proper operation the 8350A must be in the CW mode and the plug-in CW Filter capacitor should be off. Since the Micro Learn String overrides the present values of the 8350A when it is input, do not program any functions while in this mode. If a function is programmed one of two things may occur: 1) the 8350A may exit the Input Micro Learn String mode with the previous sweeper settings restored, or 2) the 8350A may interpret the program codes as another Micro Learn String and cause the instrument to enter a non-predicable state. The only function that is valid for execution while the Micro Learn String is in effect is the Network Analyzer Trigger function.

To output the Micro Learn String: 1) program the desired CW frequency, 2) program the "OX" code, then 3) read the 8 byte string.

To input the Micro Learn String: program the "IX" code and the 8 byte string. When the user desires to exit the Input Micro Learn String mode and return to the normal mode of operation, the user must exit properly. When in the Input Micro Learn String mode the 8350A accepts the input program code/bytes in a special binary entry mode. The mode is exited by programming

Figure 3-17. HP-IB Only Functions (1 of 7)

the 8350A with a function code that does not start with a number (0–9) or the letters A through F since these are interpreted as possible Micro Learn String data characters. It is suggested that the user exit this mode by using the “M0” code as the mode terminator then restore the numeric displays via the “CW”, “ST”, and “PL” function codes.

**OUTPUT MODE STRING:** A string of 25 bytes of binary data that describes all of the presently active functions of the 8350A and 83500 Series Plug-in. This information is not packed thus allowing simple data analysis. The information passed indicates only which functions are presently active functions with no numeric values included. By determining the decimal value of each byte the user can determine which function is active. To determine the actual numeric value of some functions use the Output Interrogated Parameter function. The length of the Mode String is fixed, independent of the functions selected and the plug-in used.

**OUTPUT INTERROGATED PARAMETER:** The 8350A outputs the present numeric value of the instructed parameter that is to be interrogated. Any parameter that has a numeric value associated with it such as Start Frequency, Sweep Time, etc., can be interrogated. The units of the output data are Hz, dBm, dB, or sec., implied with the function selected.

**OUTPUT ACTIVE PARAMETER:** The 8350A outputs the numeric value of the parameter that is presently active, ie. enabled for value modification from the step keys or data entry. The units of the output data are Hz, dBm, dB, or sec., implied with the function selected.

**OUTPUT STATUS:** The 8350A outputs 2 sequential bytes, 8 bits wide, that indicate the present instrument status. The first status byte is equivalent to the Status Byte of the Serial Poll (the Status Byte Message), the second status byte is the Extended Status Byte which provides additional information. See the Status Byte Information table for a description of each Status Byte. Status Byte values are cleared upon execution of a Serial Poll (the Status Byte Message), Device Clear (the Clear Message), and/or Instrument Preset function command.

*Status Byte Information Table*

STATUS BYTE (#1)								
BIT #	7	6	5	4	3	2	1	0
DECIMAL VALUE	128	64	32	16	8	4	2	1
FUNCTION	N/A	REQUEST SERVICE (RQS)	SRQ on Syntax Error	SRQ on End of Sweep	N/A	SRQ on Change in Extended Status Byte	N/A	SRQ on Numeric Parameter Altered to Default Value

EXTENDED STATUS BYTE (#2)								
BIT #	7	6	5	4	3	2	1	0
DECIMAL VALUE	128	64	32	16	8	4	2	1
FUNCTION	Airflow Failure	*RF Unleveled	Power Failure/on	N/A	N/A	N/A	N/A	Self Test Failed

\*Bit/Functions not usable with 86200 Series Plug-ins and 11869A Adapter.

*Figure 3-17. HP-IB Only Functions (2 of 7)*

**SERVICE REQUEST MASK:** This determines which bits within the 8350A Status Byte (byte #1) can cause the 8350A to send a Request Service (RQS) Message to the HP-IB controller. The Request Mask is a one 8-bit byte value where with each bit position corresponds to the same bit position as in the 8350A Status Byte. If in the Request Mask byte a bit is set (logical '1') then this condition is enabled for RQS generation. If the bit value is cleared (logical '0') then the bit is ignored. The Request Mask value ranges from decimal 0 to 255 where the decimal value can be determined by summing the decimal values of each Status Byte bit to be enabled (the user need not select the RQS bit). The default at power on is a Request Mask byte of '00000000' or decimal 0. The Request Mask is reset to the default value at power on only and is not affected by an Instrument Preset.

**NETWORK ANALYZER TRIGGER (8410B):** This causes an external trigger pulse to be generated for the HP 8410B Microwave Network Analyzer to re-phase lock on the present RF signal. This is used to insure proper HP-IB operation in stepped CW frequency sweeps to guarantee that the 8410B is phase-locked at the proper RF frequency after CW settling.

**RESET SWEEP:** This aborts the present single sweep that is in progress and resets the sweep so that it can be triggered again. This function is enabled only if the 8350A is in the Single Sweep Trigger mode and has the same effect as programming a single sweep trigger ("T4").

**TAKE SWEEP:** This triggers a single sweep. This function is enabled only if the 8350A is in the Single Sweep Trigger mode and has the same effect as programming a single sweep trigger ("T4").

**DISPLAY UPDATE ON/OFF:** This selects whether or not the 8350A updates its numeric displays upon further programming of any parameter with a numeric value. The function reduces the amount of time involved in programming the 8350A numerically related parameters (ie. CW Frequency) and aids in producing faster stepped CW frequency sweeps. The default at power on and Instrument Preset is the Display Update On state. When in the Display Update Off state, the 8350A numeric displays will be blanked.

**FM SENSITIVITY (83500 Series Plug-ins Only):** This selects the External FM Input sensitivity of -20 MHz per volt or -6 MHz per volt. This function is normally selected with an internal plug-in switch but can be overridden via the HP-IB. Note that the FM sensitivity is reset to the switch position after an Instrument Preset is executed. Thus the user should select the desired sensitivity after every Instrument Preset.

#### **LIMITATIONS/CONCERNS**

1. When using the Micro Learn String (both Input and Output), the 8350A must be in the CW mode and the plug-in CW Filter capacitor should be off.
2. You must exit the Input Micro Learn String mode with the "M0" code only. The numeric displays will still be blanked until the appropriate functions are re-activated.

Figure 3-17. HP-IB Only Functions (3 of 7)

3. All Learn String and Micro Learn String characters must be retained and re-input to the 8350A. If the 8350A does not receive the expected number of characters it will undergo an Instrument Preset.
4. The valid functions for the Output Interrogated Parameter are: FA, CW, CF, DF, FB, VR, SHVR, M1, M2, M3, M4, M5, SHM1, SF, SM, ST, PL, PS, SL, and SP.
5. The Request Mask byte value is reset only when another value is programmed. It is unaffected by Instrument Preset.
6. The plug-in FM Sensitivity range is reset after an Instrument Preset to the value selected by the internal switch.
7. The Output Learn String, Output Micro Learn String, Output Mode String, and Output Status functions send a Data message consisting of a string of 8-bit binary bytes terminated using the bus END command (EOI and ATN true) with the last byte. The Output Interrogated Parameter and Output Active functions send a Data message consisting of a 14 character ASCII string representing the numeric value in exponential form terminated with a Carriage Return/Line Feed (CR/LF).

Binary Syntax: [b\*\*\*b] [EOI]

Numeric Syntax: [+d.dddddE+dd] [CR] [LF]

Where the character 'b' indicates an 8-bit binary byte and 'd' indicates a decimal digit (0 through 9). Note that the binary output format could have bytes that may be misinterpreted as Carriage Returns and/or Line Feeds so the user should defeat the ASCII CR/LF as valid character string terminators and rely on the byte count.

**REMOTE FUNCTION PROCEDURE:**

Mode	Function	Input		8350A Output Response To Input	Notes
		Prefix	Data		
Display Update On/Off	DISPLAY UPDATE ON	DU1			
	DISPLAY UPDATE OFF	DU0			
FM Sensitivity	-20 MHz/V	F1			
	-6 MHz/V	F2			

Figure 3-17. HP-IB Only Functions (4 of 7)

**REMOTE FUNCTION PROCEDURE:**

Mode	Function	Input		8350A Output Response To Input	Notes
		Prefix	Data		
Learn String	OUTPUT LEARN STRING	OL		90 bytes [EOI]	
	INPUT LEARN STRING	IL	90 bytes		
Micro Learn String	OUTPUT MICRO LEARN STRING	OX		8 bytes [EOI]	
	INPUT MICRO LEARN STRING	IX	8 bytes		
Mode String	OUTPUT MODE STRING	OM		25 bytes [EOI]	
Output Interrogated Parameter	OUTPUT INTERROGATE	OP	(Function Prefix)	$\pm d.dddddE\pm dd$ [CR/LF]	Valid Functions: FA, CW, CF, DF, FB, M1, M2, M3, M4, M5, VR, SHVR, SHM1, SS, ST, SM, PL, PS, SL, SP
Output Active Parameter	OUTPUT ACTIVE	OA		$\pm d.dddddE\pm dd$ [CR/LF]	
Output Status Bytes	OUTPUT STATUS	OS		2 bytes [EOI]	
Request Mask	REQUEST MASK	RM	1 byte		
Reset Sweep	RESET SWEEP	RS			
Take Sweep	TAKE SWEEP	TS			

Figure 3-17. HP-IB Only Functions (5 of 7)

MODE STRING (1 of 2)			
Byte #	Bit Usage 76543210	Example	Description
1	00000000 00000001 00000010	0 1 2	SWEEP MODE: Start/Stop CW CF/ $\Delta$ F
2	00000000 00000001 00000010 00000011	0 1 2 3	SWEEP TRIGGER: Int Line Ext Single
3	00000000 00000001 00000010	0 1 2	SWEEP SOURCE: Time Man Ext
4	0000----1 0000--1- 0000-1-- 00001---	On On On On	MODULATION/BLANKING: Amplitude Mkr On/Off (On=1, Off=0) Display Blanking On/Off RF Blanking On/Off Sq. Wave Modulation On/Off
5	00000000 00000001 00000010 00000011 00000100	0 1 2 3 4	ACTIVE MARKER #: M1 M2 M3 M4 M5
6	00000000 00000001 00000010 00000011 00000100	0 1 2 3 4	REFERENCE MAKRER #: M1 M2 M3 M4 M5
7	000----1 000--1- 000-1-- 000-1--- 0001----	On On On On On	MARKERS ON/OFF: M1 (On=1, Off=0) M2 M3 M4 M5
8	00000000 00000001 00000010	0 1 2	COUNTER TRIGGER PARAMETER: Start Freq. Stop Freq. Marker Freq.
9	-----1 -----1- -----1-- ----1--- ---1---- --1----- -1----- 1-----	On On Yes Yes On On On On	SPECIAL CONDITIONS: Non-Swept CW On/Off (On=1, Off=0) Default Step Size On/Off Vernier Negative Yes/No (Yes=1, No=0) Offset Negative Yes/No Mkr $\Delta$ Mode On/Off Mkr Sweep Mode On/Off Counter Trigger On/Off Alt. Sweep On/Off
10	00000000 00000001 00000010 00000011 00000100 00000101 00000110	0 1 2 3 4 5 6	KEYBOARD ASSIGNMENT: Start Stop CW/CF $\Delta$ F Vernier Offset Markers

Figure 3-17. HP-IB Only Functions (6 of 7)

MODE STRING (2 of 2)			
Byte #	Bit Usage 76543210	Example	Description
10 (Cont'd)	00000111	7	Step Size
	00001000	8	Sweep Time
	00001001	9	Manual Sweep
	00001010	10	Save/Recall/Alt
	00001011	11	Hex Entry Address
	00001100	12	Hex Entry Data
	00001101	13	Key Test
	00001110	14	HP-IB Address
	01111111	127	None
	01000000	128	Power Level
	01000001	129	Power Sweep
01000010	130	Slope	
11	00000000	0	ALTERNATE REGISTER #: 0
	00000001	1	1
	00000010	2	2
	00000011	3	3
	00000100	4	4
	00000101	5	5
	00000110	6	6
	00000111	7	7
	00001000	8	8
00001001	9	9	
12	00000000	0	NOT DEFINED
13	00000000	0	ALC Mode: Int
	00000001	1	Ext
	00000010	2	Mtr
14	000000-1	On	POWER CONTROL: CW Filter On/Off (On=1, Off=0)
	0000001-	On	Power Sweep On/Off
15	000000-1	On	POWER FUNCTIONS: Slope On/Off (On=1, Off=0)
	0000001-	On	Power Sweep On6Off
16	000000-1	On	CRYSTAL MARKER MODES: Amplitude Mkr On/Off (On=1, Off=0)
	0000001-	On	Intensity Mkr On/Off
17	00000000	0	CRYSTAL MARKER FREQUENCY: 1 MHz
	00000001	1	10 MHz
	00000010	2	50 MHz
	00000011	3	Ext Freq
18	00000000	0	FM INPUT SENSITIVITY: -20 MHz/V
	00000001	1	-6 MHz/V
19	00000000	0	NOT DEFINED
20	00000000	0	
21	00000000	0	
22	00000000	0	
23	00000000	0	
24	00000000	0	
25	00000000	0	
END OF MODE STRING			

Figure 3-17. HP-IB Only Functions (7 of 7)





LOCAL OPERATION

# 8350A SWEEP OSCILLATOR

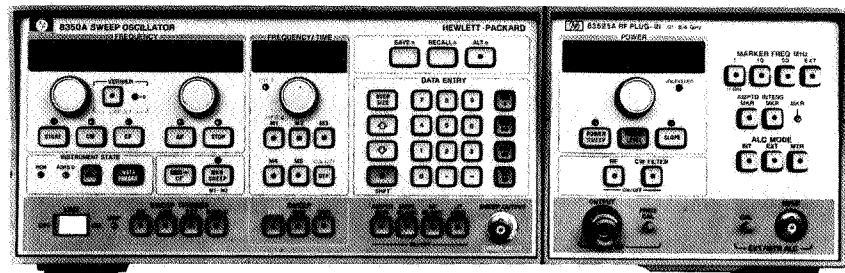

 **HEWLETT  
PACKARD**

# 8350A SWEEP OSCILLATOR

© Copyright                      HEWLETT-PACKARD COMPANY                      1980  
1400 FOUNTAIN GROVE PARKWAY, SANTA ROSA, CALIFORNIA 95404

MANUAL PART NO. 08350-90001  
Microfiche Part No. 08350-90002

Printed: AUGUST 1980



**HEWLETT  
PACKARD**

## LOCAL OPERATION

### INTRODUCTION

This Local Operation handbook provides information on the local use (non HP-IB) of the 8350A Sweep Oscillator with 83500 series Plug-ins. Throughout this handbook are blocks of example procedures on implementing some of the information. The front panel controls are divided into function groups. These groups and other information topics are arranged in the following sequence:

- GETTING STARTED – Brief example of control usage.
- INSTRUMENT PRESET – Error codes and preset conditions.
- DATA ENTRY – Numeric, step, units, and shift keys.
- FREQUENCY – Mode selection, vernier and offset.
- FREQUENCY/TIME – Markers and sweep control.
- SAVEn/RECALLn/ALTn – Storage Registers, Step Up Advance.
- DISPLAY FUNCTIONS – Blanking, Modulation, and Sweep Out/In.
- 83500 SERIES PLUG-INS – Power, signal, and crystal markers.
- USE WITH SPECIFIC MEASUREMENT EQUIPMENT:
  - HP 8755S Frequency Response Test Set
  - HP 8410B Network Analyzer
  - HP 7010B and other X-Y Recorders
  - HP 5343A Frequency Counter
- APPENDIX 1 – Rear panel connector information.
- APPENDIX 2 – Use of 86200 series Plug-Ins with 11869A Adapter.
- APPENDIX 3 – Summary of Sweep Oscillator front panel controls with fold-out front panel drawing.

### GETTING STARTED

#### NOTE

If a 86200 series RF Plug-in and 11869A Adapter are used, the plug-in coding on the adapter must be set properly to get the correct frequency display.

When the 8350A is turned on or when the INSTR PRESET key is pressed the front panel of the 8350A is set to the following pre-determined state: The RF output is swept over the full frequency range of the plug-in at the maximum specified leveled output power, minimum sweep time for the RF Plug-in installed, and the internal square wave amplitude modulation is off.

## Example:

## 8350A with 83525A 0.01-8.4 GHz Plug-in

To change from the INSTR PRESET state to 4.2 to 6.2 GHz sweep (in START/STOP mode), 0.20 second sweep time, +4.5 dBm output power, 27.8 KHz square wave modulation on RF output:

1. Press the **START** key and then rotate the START control clockwise to increase the start frequency until the display above the START key reads 4.200 GHz
2. Rotate the STOP control counterclockwise to decrease the STOP frequency to 6.500 GHz.
3. Press the **TIME** key, then turn the FREQUENCY/TIME control clockwise to increase the sweep time to 0.2 second (displayed on the FREQUENCY/TIME display).
4. Press **MOD** key to activate the internal 27.8 KHz square wave modulation. The lamp in the center of the key will be on.
5. Press the **POWER LEVEL** key, then turn the plug-in POWER control until the display reads +4.5 dBm.

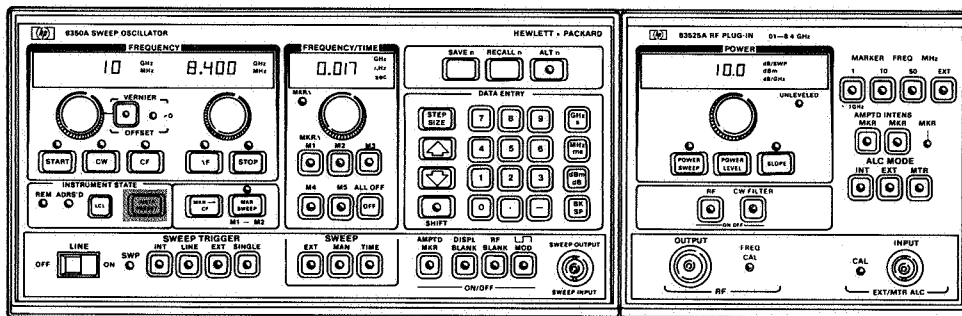

## INSTRUMENT PRESET

This condition occurs when the power is turned on or when the INSTR PRESET key is pressed.

INSTR PRESET causes an internal self test to occur after which the instrument will be set to the preset condition. If certain internal errors or failures are detected during the self test or during normal operation of the 8350A they are indicated via error codes in the form "Ennn" (where  $n=0, \dots, 9$ ) read from the left FREQUENCY display. For a complete description of the error code listing see the Operating and Service Manual Section 8. The error codes are:

- E001 Plug-in interface failure. Check plug-in.
- E002 Sweep voltage DAC/Marker voltage DAC failure
- E003 Tuning voltage DAC/Marker voltage DAC failure

Figure 1. Instrument Preset Key (1 of 2)

- E004 Power supply failure
- E005 Instrument interface bus failure
- E006 Front panel bus failure
- E007 ROM failure
- E008
- E009
- E010
- E011 RAM failure
- E012
- E013
- E014
- E015 Microprocessor failure
- E016 Insufficient cooling. Check fan.

If the self test completes without errors the instrument presets to:

SWEEP MODE: START/STOP, over full frequency range of plug-in

SWEEP TIME: fastest allowable for plug-in

MARKERS: off

MODULATION: off

SWEEP TRIGGER/SWEEP: INT, TIME

VERNIER/OFFSET: 0 MHz

DISPLAY BLANKING: on

SAVE/RECALL: Initial power on sets all memory locations to INSTR PRESET state, if using 8350A Option 001 (Non-Volatile Memory) or if instrument is already on, the memory values remain unchanged when INSTR PRESET is pressed.

ALL OTHER FUNCTIONS: off

When using 83500 series Plug-ins:

POWER LEVEL: maximum specified leveled value

RF and CW FILTER: on

ALC MODE: INT

CRYSTAL MARKERS: off (83522A, 83525A only)

ALL OTHER FUNCTIONS: off

Figure 1. Instrument Preset Key (2 of 2)

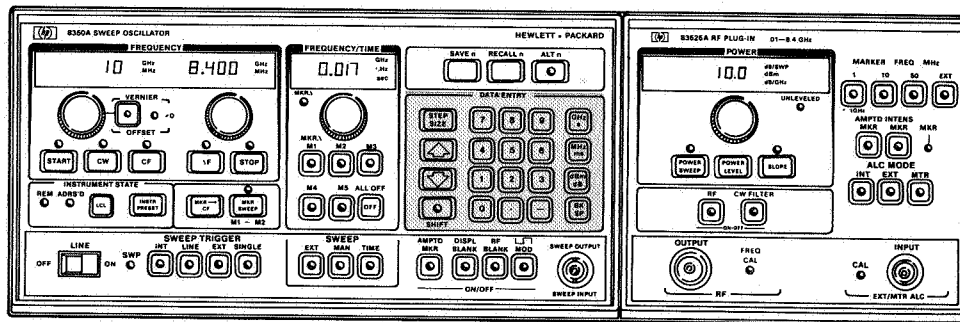

## DATA ENTRY

This section contains the numeric keyboard, terminators (i.e., GHz, seconds, dBm), step size/up/down, backspace and shift keys. In addition to using the appropriate control, a function value can be set to an exact value or incremented by a specific amount via the keyboard.

### Number/unit keys

These keys are used to enter values of frequency, time or power. Holding a number key down causes it to repeat.

Example:

To enter a START frequency of 1.870 GHz:

Press **START** **1** **.** **8** **7** **GHz/sec**

or

**START** **1** **8** **7** **0** **MHz/ms**

to enter the equivalent frequency in MHz.

**Backspace Key BK SP.** Prior to pressing a units key the value entered from the keyboard may be changed via the BK SP key without effecting the current instrument state. The backspace key allows the user to alter digits already entered.

### Step UP and Step DOWN keys

These keys increment or decrement the active parameter (including memory registers) by the STEP SIZE or preset amount. By holding either key down the 8350A will continue to step

Figure 2. Data Entry (1 of 2)

therefore eliminating the need for the user to repeatedly press the step keys. The STEP UP function may be engaged via the remote STEP UP ADVANCE on the rear panel Programming Connector. The STEP UP ADVANCE is incremented by supplying contact closure to ground or logical 0 to pin 22.

### STEP SIZE

This key is used to enter a frequency or power increment to be used with the UP or DOWN key. The STEP SIZE key is pressed before the quantity is entered. A frequency step that is entered is common for START, STOP, CF, CW,  $\Delta F$ , VERNIER, OFFSET, MARKER and MANUAL SWEEP parameters. A power step is used for varying POWER LEVEL, POWER SWEEP and SLOPE. Default values are assigned at power on and instrument preset for step sizes until new values are entered. Note that a step size cannot be set for sweep time. The keyboard and step keys affect the last active function. The entered Step Size is not displayed.

Example:

To set a 250 MHz step size:

Press **STEP SIZE** **2** **5** **0** **MHz/ms**

After this, each time the UP or DN key is pressed the active frequency parameter will change by 250 MHz.

### SHIFT key (BLUE)

This key is used to activate the functions coded in blue and some special functions. The lamp in the center of this key is on when the key is active.

Example:

Press **M1** **M2** **M3** **M4** **M5**

(MARKERS) ALL OFF. Pressing SHIFT, OFF turns off all markers.

The SHIFT key is also used to set the HP-IB address. Press **SHIFT** **LCL**; the **FREQUENCY/TIME** display will indicate the present HP-IB address number. The address may be changed to any value between 0 and 30 by using the keyboard to enter a number and the **GHz**, **MHz** or **dBm** key as a terminator. The 8350A is factory preset for an HP-IB address of 19.

### NOTE

Address number 21 is normally reserved for calculator addressing and HP-IB interface functions and should not be used.

Figure 2. Data Entry (2 of 2)

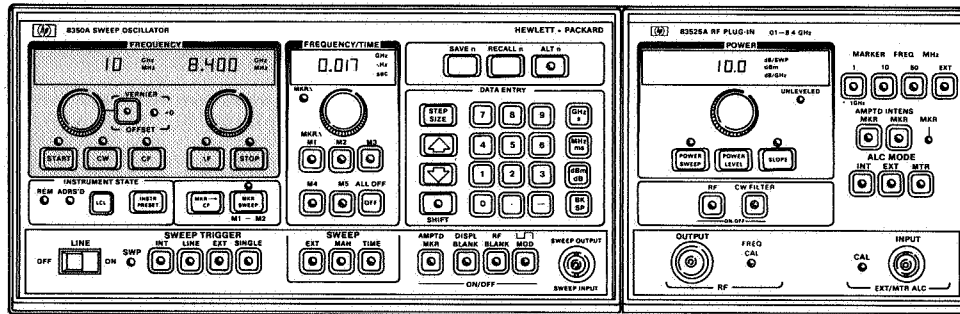

## FREQUENCY

This section controls the sweep mode and frequency limits.

### START/STOP

When either the **START** or **STOP** key is pressed the sweep oscillator is put in **START/STOP** mode. Swept RF output begins at **START** frequency and ends at **STOP** frequency. The **START** frequency must be less than or equal to the **STOP** frequency. The vernier and offset can be used to change the effective center frequency of the sweep. Left **FREQUENCY** display is start frequency of sweep; right **FREQUENCY** display is stop frequency. Frequencies may be changed in three ways.

- Frequency controls — Provides continuous adjustment. Clockwise rotation increases frequency.
- Data entry — Can enter specific frequency values from the number/units keyboard.
- Step up/down — enter step size (in GHz or MHz) using **DATA ENTRY** keyboard section. By first pressing the appropriate key (**START** or **STOP**) and then the **UP** or **DOWN** key can now increment or decrement the appropriate frequency sweep limit. If a step size has not been entered the function will change by the default value when **UP** or **DOWN** is pressed.

### CF (CF/ $\Delta$ F)

Puts display in mode where swept output is read as a center frequency and frequency sweep width. Output is swept from  $CF - \Delta F/2$  (start frequency) to  $CF + \Delta F/2$  (stop frequency). When changing between **CF/ $\Delta$ F** and **START/STOP** modes only the method of display changes, the swept RF output remains the same.

When either **CF** or  $\Delta F$  is activated the left display is center frequency (**CF**), the right display is delta frequency ( $\Delta F$ ). Both the **CF** and  $\Delta F$  can be changed via the appropriate control, number/units keyboard and step size keys.

### CW

When activated causes the 8350A to output a constant frequency. The value of the **CW** frequency is displayed on left **FREQUENCY** display. The **CW** frequency is the same as the center frequency (**CF**) of the previous swept range. The **CW** frequency value can be changed using the

Figure 3. Frequency Controls (1 of 2)



control, data entry keyboard or step keys. In CW mode, the SWEEP OUT voltage is equal to percent of full band. Pressing SHIFT, CW enters a "swept" CW mode with the SWEEP OUT being a 0 to 10 volt ramp that results in the display trace being a flat horizontal line. This is often useful when reading values (e.g., dB of attenuation) from a CRT screen when at a CW frequency.

### FREQUENCY VERNIER

The effective center frequency of any mode (CW or swept) may be adjusted with high resolution up to  $\pm 0.05\%$  of the frequency band being used with the vernier. Pressing the VERNIER key activates the function and sets the left FREQUENCY display to read the vernier value in MHz.

1. " $\neq 0$ " light is on whenever a frequency vernier or frequency offset is present in any mode. After setting vernier, to return to the previous mode, press the appropriate key (e.g., START, CF, etc.) and the display will return to reading the appropriate frequencies and the " $\neq 0$ " lamp will be lit.
2. Frequency vernier can be set by the control, data entry keyboard or step keys.
3. The displayed vernier adjustment can be up to  $\pm 0.05\%$  of the frequency band being swept. When in a sub-band of a multiband plug-in (for example, the 0.01-2 GHz band of the 83525A .01-8.4 GHz plug-in) the adjustment range will be  $\pm 0.05\%$  of the sub-band. This feature allows for better frequency resolution than would otherwise be possible with the vernier when using a multiband plug-in.
4. The vernier adds its value to the appropriate frequency parameter and then resets to zero when the adjustment exceeds  $\pm 0.05\%$  for continuous adjustment.
5. ZEROING VERNIER. To set the vernier to zero, press VERNIER 0 MHz/ms and the " $\neq 0$ " lamp will turn off.

### FREQUENCY OFFSET

The frequency offset feature allows the CW frequency and/or the effective center frequency of the swept range to be shifted by any amount up to the full range of the plug-in.

1. To enter an offset press SHIFT VERNIER and enter the offset by either the left FREQUENCY control or data entry keyboard. The amount of offset (in GHz or MHz) will be shown in the left FREQUENCY display and the " $\neq 0$ " lamp will be lit.
2. To exit the displayed offset mode press the appropriate mode key (i.e., START, CW, etc.). The sweep limits displayed will appear to be unchanged, however the " $\neq 0$ " lamp will be on indicating the offset is present and the actual RF output frequency will be shifted.
3. To return display or adjustment the frequency offset press SHIFT VERNIER. To zero the offset press SHIFT VERNIER 0 MHz.

### OVERRANGE

The 8350A will permit frequency sweeps beyond the specified range of the plug-in by  $\pm 2.0\%$  of the plug-in bandwidth. However, plug-in performance in the overrange condition is unspecified.

As a warning of the frequency overrange condition the GHz or MHz annunciator will flicker in the appropriate function display.

Figure 3. Frequency Controls (2 of 2)

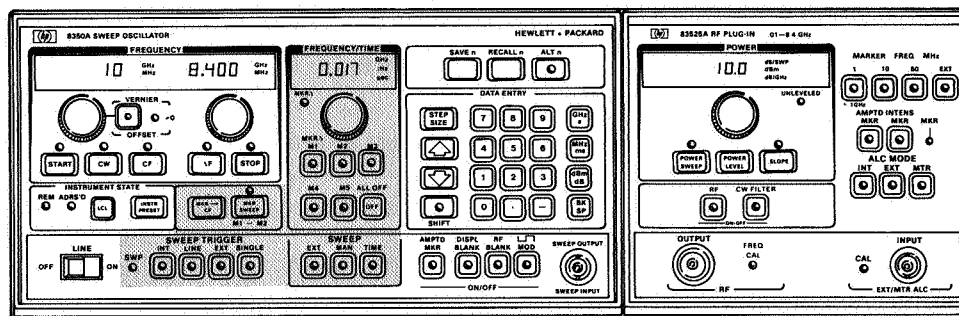

## FREQUENCY/TIME

This display will read either GHz, MHz or sec depending upon the presently active function and range. This section controls five mainframe markers, manual sweep, and the sweep time. The five independent frequency markers can be displayed simultaneously as intensified dots on a CRT using the Z-axis or amplitude dips on the RF output.

## SWEEP

Controls the rate at which the RF output is swept.

**TIME.** When the TIME key is pressed the output is swept at the user-specified or default rate. If time key is lit but display reads GHz/MHz or is blank, press TIME key again and display will read seconds. The mainframe can allow sweep times from 100 seconds to 0.01 second although the minimum sweep time is dependent on the plug-in being used and bandwidth being swept.

When display reads seconds, sweep time can be adjusted with the control knob or data entry keyboard. The step keys can be used to adjust the sweep time in a 1-2-5 sequency.

**MANUAL SWEEP(MAN).** FREQUENCY/TIME display will read GHz/MHz. By using the FREQUENCY/TIME control, step keys or data entry keyboard, it is possible to manually sweep the frequency range with the display indicating the present output frequency.

**EXTERNAL SWEEP(EXT).** The 8350A can be swept via an external voltage. Apply 0 to 10 volts into sweep output/input (can use BNC connector on front or rear panel) with 0V input corresponding to the lower frequency limit of the sweep range and 10V corresponding to the upper limit. DC sweep input voltages will cause CW frequency outputs. Markers and blanking outputs are disabled when in external sweep mode.

## SWEEP TRIGGER

Controls when the sweep will begin in the timed sweep mode. The sweep light, SWP, is lit when the sweep is occurring.

**INT.** Sweep triggered internally, free running.

**LINE.** Sweep triggered by power line frequency.

Figure 4. Frequency/Time Controls (1 of 3)

**EXT.** The sweep can be triggered externally by applying a positive going signal from 0 to 2 volts minimum, +20 volts maximum to Programming Connector pin 9. The trigger signal must be wider than 0.5 microsecond at less than a 1 MHz repetition rate.

**SINGLE.** This key selects single sweep mode and aborts present sweep when first pressed. Subsequent keying will trigger or abort single sweeps at current sweep time.

### MARKERS

Any or all of the five markers (M1 through M5) may be enabled by pressing the marker key corresponding to the marker desired. When a marker is activated it is set to its last active frequency unless INSTRUMENT PRESET has been activated in which case the marker will be set to the center of the fullband sweep. A marker can be in one of three states:

- ACTIVE – Lamp in center of key flashing.
- ON – Lamp on.
- OFF – Lamp off.

Only one marker at a time (the “active” marker) can have its value altered. The five mainframe markers are normally supplied through the positive Z-axis blanking pulses connector on the rear panel. By pressing the AMPTD MKR key the markers may be displayed as amplitude dips on the RF output.

- When a marker is active the keyboard, FREQUENCY/TIME control and step keys can be used to modify its value. The value of the active marker in GHz/MHz is displayed.
- By pressing OFF, the active marker only will be turned off. If multiple markers are on, the remaining lamps will remain lit although the display will go blank.
- A marker may be initially activated or returned to active state by pressing the corresponding marker key.
- All markers may be turned off simultaneously by pressing SHIFT, OFF.

#### Example:

Press **M3** (Note M3 lamp flashing other lamps off.)

Press **M5** (Note M5 lamp flashing, M3 lamp on and other lamps off.)

**MKR (Marker) SWEEP.** In this mode the RF output is swept between markers M1 and M2. The lamp over the key will be on. Marker 1 must be less than or equal to Marker 2 in frequency (if M1 is greater than M2 the values of M1 and M2 are permanently interchanged). By varying the active marker (1 or 2) or by turning the START/STOP controls the sweep limits can be altered. When both M1 and M2 are not on, the sweep occurs between the most recent values of M1 and M2. To exit this mode press **MKR SWEEP** and the lamp over the key will go out. Pressing **SHIFT, MKR SWEEP** causes the values of M1 and M2 to become the START/STOP frequency values permanently.

**MARKER-TO-CENTER FREQUENCY (MKR→CF).** When this key is pressed the frequency of the active marker becomes the center frequency of the swept output. The frequency span remains unchanged if within the frequency limits of the plug-in. If original frequency span exceeds plug-in limits, the frequency span will be reduced to retain symmetry.

**MKR Δ.** This function allows the frequency difference between any two markers to be displayed and the trace between them intensified (if intensity markers are selected).

1. Press **SHIFT M1** the display shows the frequency difference between the currently active marker and the one that was previously active.
2. The **FREQUENCY/TIME** control, keyboard and step keys can change the active marker value.
3. To exit **MKR Δ** mode press **OFF**.

Example:

1. Press **M4** and set frequency via **DATA ENTRY** keyboard or Control to 2 GHz.
2. Press **M2** and set frequency via **DATA ENTRY** keyboard or Control to 2.4 GHz.
3. Press **SHIFT MKR Δ** (Note Frequency/Time display reads difference between Marker 4 and Marker 2, 400 MHz).

Figure 4. Frequency/Time Controls (3 of 3)

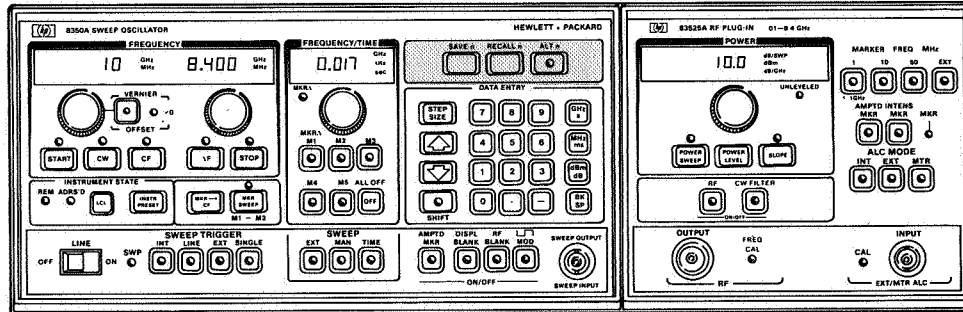

**SAVEN/RECALLn/ALTn**

**SAVEN/RECALLn**

The 8350A is equipped with memory registers which allow up to nine complete front panel settings (frequency range, markers, power level, etc.) to be stored and later recalled. Instrument settings are stored in memory locations 1 through 9 by pressing SAVEn and 1, . . . , or 9. To recall a stored instrument setting press RECALLn and 1, . . . , or 9. The STEP keys may be used to step through the stored registers. The instrument settings stored in memory may be recalled remotely in sequence by using the Step Up Advance on pin 22 of the Programming Connector on the rear panel of the 8350A. A contact closure to ground or logic 0 is used to implement this function.

**ALTn**

ALTn causes the 8350A to alternate between the current instrument state and the setting stored in memory location n (where n=1, . . . ,9) on successive sweeps. When the 8350A is in this mode the lamp will be on and the SAVEn and RECALLn keys disabled. To exit from the ALTn mode press the key again, the lamp will turn off and the SAVEn/RECALLn keys will become operational. When using the 8350A with an HP 8755C Swept Amplitude Analyzer, channel 1 displays the current instrument state and channel 2 displays the stored setting (provided the 8350A/8755C ALT SWP INTERFACE cable is connected).

Figure 5. Save n, Recall n, and ALT n Keys

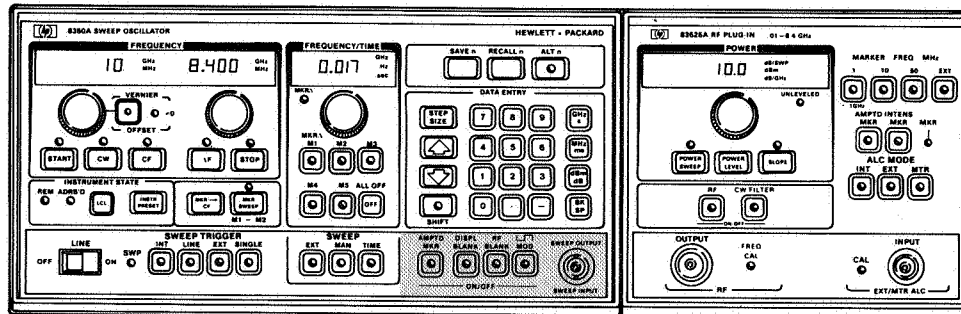

## DISPLAY FUNCTIONS

AMPTD MKR, DISPL BLANK, RF BLANK. (Function in effect when lamp in center of key is lit)

**DISPL BLANK ON/OFF.** Blanks the display during the retrace via the POS Z BLANK or NEG Z BLANK outputs.

**RF BLANK ON/OFF.** Blanks (turns off) the RF power during the retrace.

**LMOD ON/OFF.** Activates the internal 27.8 KHz square wave amplitude modulation of the RF output. This feature makes the 8350A directly compatible with the HP 8755 Frequency Response Test Set. The 8350A may be modified via an internal jumper to provide 1000 Hz square wave amplitude modulation for instruments like the HP 415E SWR Meter (refer to the Operating and Service Manual, Section 5).

### SWP (Sweep) OUTPUT/SWP (Sweep) INPUT (BNC connection).

**SWP (Sweep) OUTPUT.** Supplies a 0 to 10 Volt signal when 8350A is in MAN or TIME sweep mode. 0V output is at the start frequency of sweep, 10V output is at the stop frequency of sweep. In CW mode the output is a dc voltage proportional to the percent of full band. Can be used to drive the X-axis on a CRT or X-Y recorder.

**SWP (Sweep) INPUT.** Used when in EXT SWEEP mode. Supplying a dc voltage will tune RF where 0 volts tunes to the lower frequency of the set sweep and 10 volts tunes to the upper frequency. The input can be a ramp for a swept output or DC for a CW frequency. The display and RF blanking must be off when externally sweeping.

Figure 6. Display Function Keys

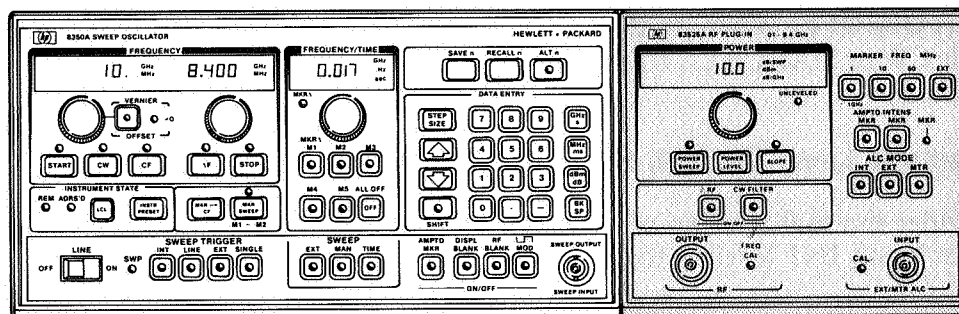

## 83500 SERIES PLUG-IN

### Power Control

**POWER LEVEL.** When pressed, the plug-in display indicates the RF output power. The output power may be varied using the POWER control, keyboard or step size keys. Note that the internal leveling must be on and the unlevel'd light out for calibrated output power. The power is typically calibrated over a 15 dB range (80 dB with plug-in Option 002, Step Attenuator).

**SLOPE.** Compensates for high frequency power losses in external RF cables by increasing the power at higher frequencies. This compensation provides a flat RF signal output at the end of a cable or test set. Press SLOPE and the display will indicate the dB per GHz of the present sweep of compensation desired. Use the POWER control, keyboard or step keys to enter the amount of slope. Press SLOPE again to remove all compensation.

**POWER SWEEP.** This function enables the output power to be swept up. The maximum calibrated power sweep range is typically 10 dB. Note that when using plug-ins with Option 002 Step Attenuator, the power cannot be swept across the internal attenuator switch points. The procedure for performing a power sweep is:

1. After selecting the output frequency (sweep range or "swept" CW mode) use the power level to set the starting value for the power sweep.
2. Press the POWER SWEEP key, the display will now read the dB/SWP. By using the POWER control, data entry keyboard or step keys set the desired sweep range. Press the POWER SWEEP key again to turn the power sweep off.

Figure 7. Plug-in Controls (1 of 2)

**Signal Control**

**RF ON/OFF.** Turns the RF power on and off.

**CW FILTER ON/OFF.** When on, this filters the internal oscillator's tuning voltage to provide a more stable CW or MANUAL SWEEP frequency output. During swept operation this filter is always disabled.

**ALC (Automatic Level Control) Mode: INT, EXT, MTR**

**INT.** Provides internal leveling of output power at the output connector. The 83500 series Plug-in must be on INT leveling for calibrated output power.

**EXT.** This setting is used when leveling with an external crystal/diode detector. The front panel EXT ALC input accepts negative voltages in the  $-25$  to  $-250$  millivolt range (typically).

**MTR.** Used when leveling output power with an HP 432A/B/C Power Meter.

**CAL.** Adjusts the ALC gain so the display can be calibrated by an external power meter or detector.

**CRYSTAL MARKERS (83522A, 83525A Plug-ins only)**

50, 10, and 1 MHz crystal frequency marker combs are available. The 50 and 10 MHz are available at frequencies less than 2 GHz while the 1 MHz markers are available under 1 GHz.

**AMPTD/INTENS.** The markers can be set to be amplitude dips (on the RF output) and/or intensified spots (on the Z-axis of the CRT) or both. They are independent of the mainframe markers.

**EXT (External Marker).** An external frequency marker can be input through the rear panel of the plug-in. The marker appears when the RF output frequency equals the marker frequency. The external marker input power should be between  $-10$  dBm and  $+10$  dBm.

**MKR Lamp.** When the 8350A is in CW or manual/external sweep mode the MKR Lamp will light when the CW frequency is at a marker frequency. Useful when an accurate CW frequency reference is desired and to calibrate plug-ins.

**RF OUTPUT CONNECTOR**

Type N female. The 83570A 18 to 26.5 GHz Plug-in is equipped with a WR-42 waveguide output connector.

Figure 7. Plug-in Controls (2 of 2)



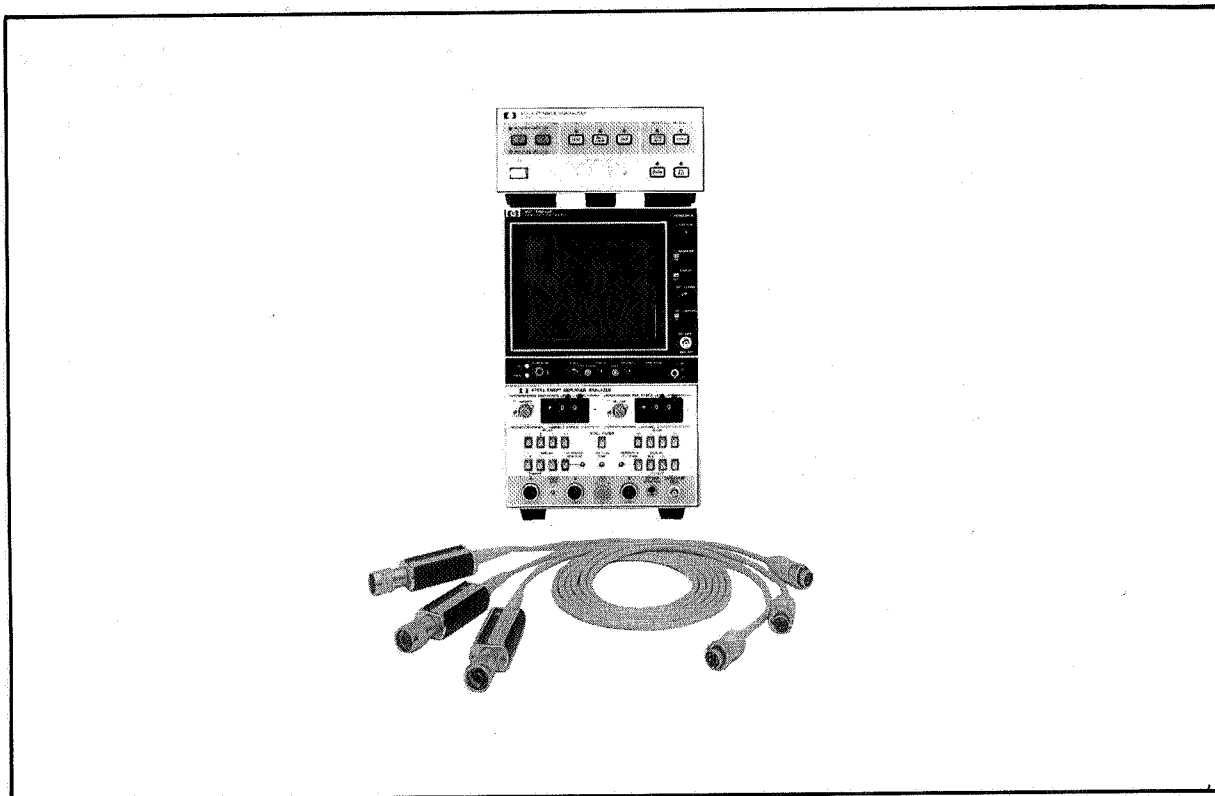

Figure 8. Frequency Response Test Set

## INTERFACING THE 8350A WITH SPECIFIC MEASUREMENT EQUIPMENT

### 8755S FREQUENCY RESPONSE TEST SET

The 8755S consist of:

- 8755C Swept Amplitude Analyzer
- 182T Oscilloscope
- 11664A Detectors (3 each)
- 8750A Storage-Normalizer

The 8755S is used for scalar transmission and reflection measurements requiring up to 60 dB of dynamic range and for absolute power measurement from  $-50$  dBm to  $+10$  dBm.

The 8350A has the following features designed specifically for use with the 8755S Frequency Response Test Set:

**RF Square-wave Modulation.** By engaging the  $\square$  MOD key an internally generated squarewave modulation of the RF output is available thus eliminating the need for external modulating equipment. A jumper internal to the 8350A enables the square wave modulation frequency to be changed to 1 KHz (see section 5 of the Operating and Service manual for details).

**Alternate Sweep Function.** The ALTn function of the 8350A allows two different frequency and power settings to be swept on successive sweeps. The front panel setting and the setting stored in a memory register location n ( $n=1, \dots, 9$ ) can be selected for alternate sweeps. The Alternate Sweep Function will not work properly with the 8755A or 8755B. See Figure 9 for a sweep display of the ALTn function when used to view a bandpass response at different resolutions and offsets.

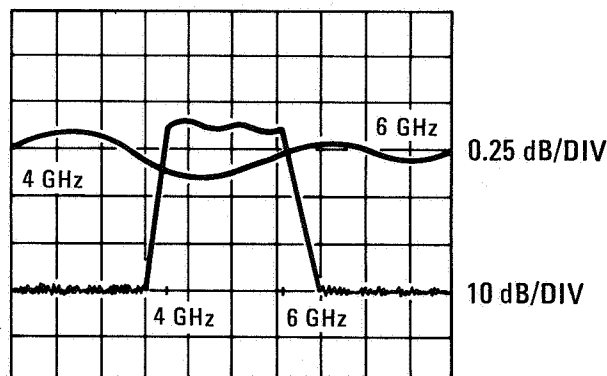

Figure 9. Alternate Sweep Function Display

Some other features enhancing the convenience and versatility of the 8755S are:

**Marker  $\Delta$ .** The MKR  $\Delta$  function is useful when using alternate sweep in overlapping different sweep widths. The overlapping portion of one of the sweeps can have an increased intensity. The 8750A Storage-Normalizer will need to be in BYPASS mode to view Z-axis modulation on the oscilloscope.

**Power Sweep.** The RF output power may be ramped up when the sweeper is in the swept or "swept" CW mode by using the POWER SWEEP function. See Figure 10 for a gain compression display using power sweep.

**Save and Recall.** This function allows the storage and recall of nine complete instrument settings.

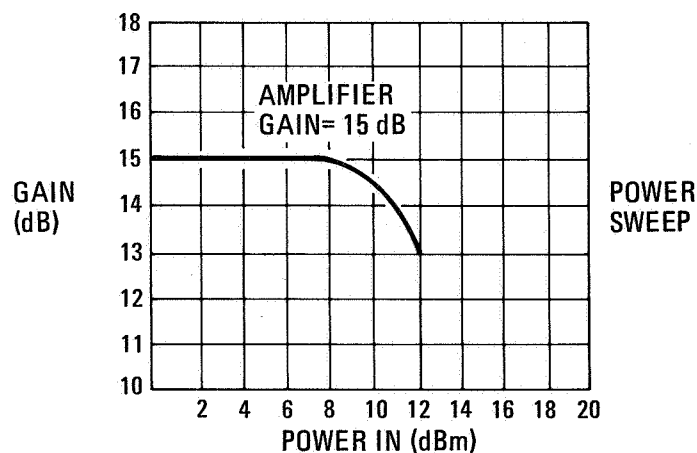

Figure 10. Gain Compression Display

Figure 11 outlines the general procedure used in making a scalar transmission and reflection measurement. The 11692D Dual-Directional Coupler is used in the example but if a 11666A Reflectometer Bridge is available it may be used instead of the Coupler and two detectors (8755S Option 002).

To keep the following procedure brief the 8750A will not be used (switched to BYPASS) in the procedure. The following anomalies exist when using the 8750A with the 8350A Sweep Oscillator:

- The 8350A DISPL BLANK must be engaged to ensure triggering 8750A updating.
- Intensity markers are changed to amplitude markers. In MKR  $\Delta$  mode they appear as a level shift over the MKR  $\Delta$  range.
- If an 8755 channel is switched off the trace goes to the reference line (bottom of CRT).

## Example:

1. Connect the equipment as shown in Figure 11. Initially, the 8350A should be set by pressing **INSTR PRESET** and **LT MOD** (Set to 27.8 KHz) which will set the front panel instrument state and activate the internal square wave modulation.

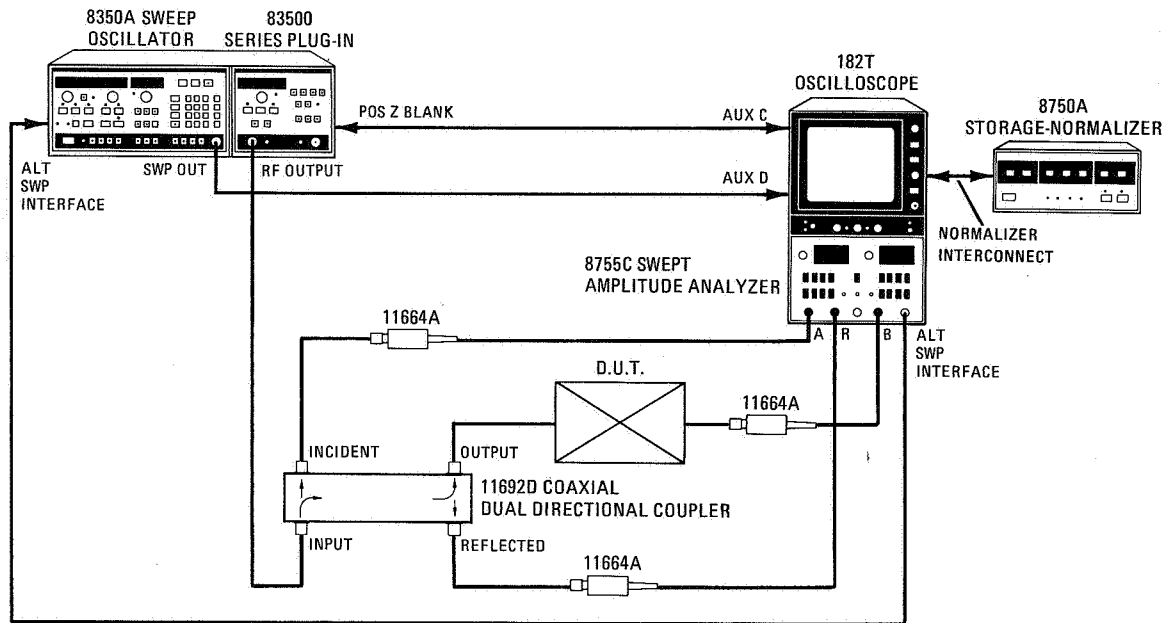

## Notes on connections:

- Either the front or rear panel SWEEP OUT/IN may be used.
  - When in ALTn mode both channels 1 and 2 (on 8755) must be on and receiving inputs.
2. Turn off channel 1 on the 8755C by releasing the display pushbutton. Set the 8350A controls as desired. On channel 2 set the function, dB/DIV and Offset desired for viewing the current sweep setting.
  3. Set the 8350A controls as desired then store the current 8350A sweep setting in any available memory location. Then turn off channel 2 by releasing its display pushbuttons.
  4. Turn on Channel 1 of the 8755C and set the function, dB/DIV and Offset as desired. Set 8350A controls as desired.
  5. Turn on channel 2. Press **ALTn**, **n** and the 8350A will alternate between the two settings on successive sweeps.

Channel 1 now displays the response due to the current front panel setting while channel 2 displays the response to the setting stored in memory location n. The front panel controls of the 8350A are enabled and the current sweep setting may be altered if necessary.

Figure 11. Typical Test Setup Using 8755S

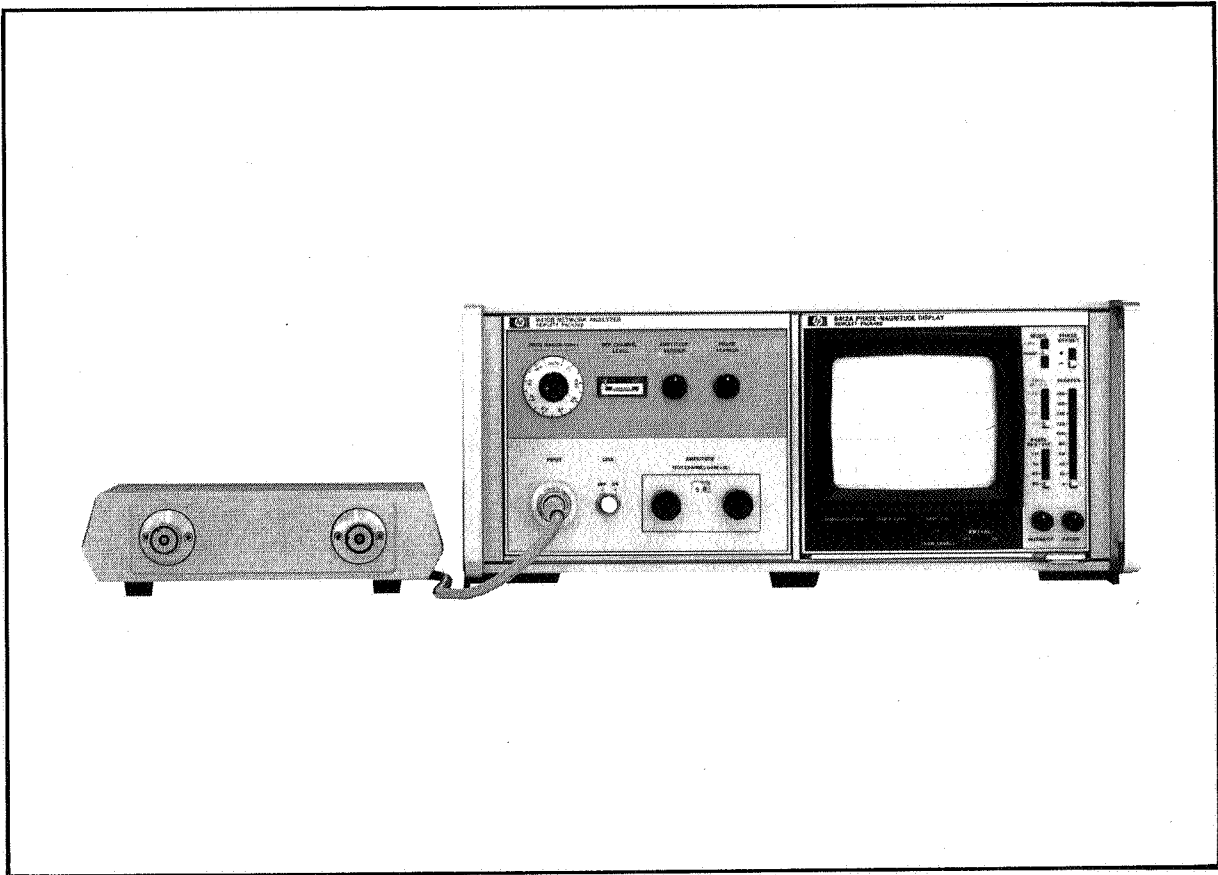

Figure 12. 8410B Network Analyzer

### 8410B NETWORK ANALYZER

The 8350A is compatible with the 8410B Network Analyzer systems and accessories. The Source Control Cable (HP P/N 08410-60146) synchronizes the two instruments to provide continuous multi-octave coaxial magnitude and phase measurement capability from 110 MHz to 18 GHz with 65 dB dynamic range. The frequency markers can be displayed in polar format as intensity dots (Z-axis). Frequency markers derived from crystal oscillators allow frequency measurements to be made with an accuracy of five parts per million.

Waveguide measurements between 18 and 26.5 GHz can be made with the K8747A Reflection/Transmission Test Unit which is designed for use with the 8410B. This test system utilizes two 8350A Sweep Oscillators and 83570A 18 to 26.5 GHz RF Plug-ins. One sweeper is used as a local oscillator while the second is used to sweep the desired frequency range.

See Figure 13 for an example measurement set up using the 8410B with a single 8350A and 83500 series Plug-in.

The 8410B FREQ RANGE should be set to AUTO. In addition, the sweep time on the 8350A should be slow enough and/or sweep range narrow enough to insure phase locking over entire sweep range.

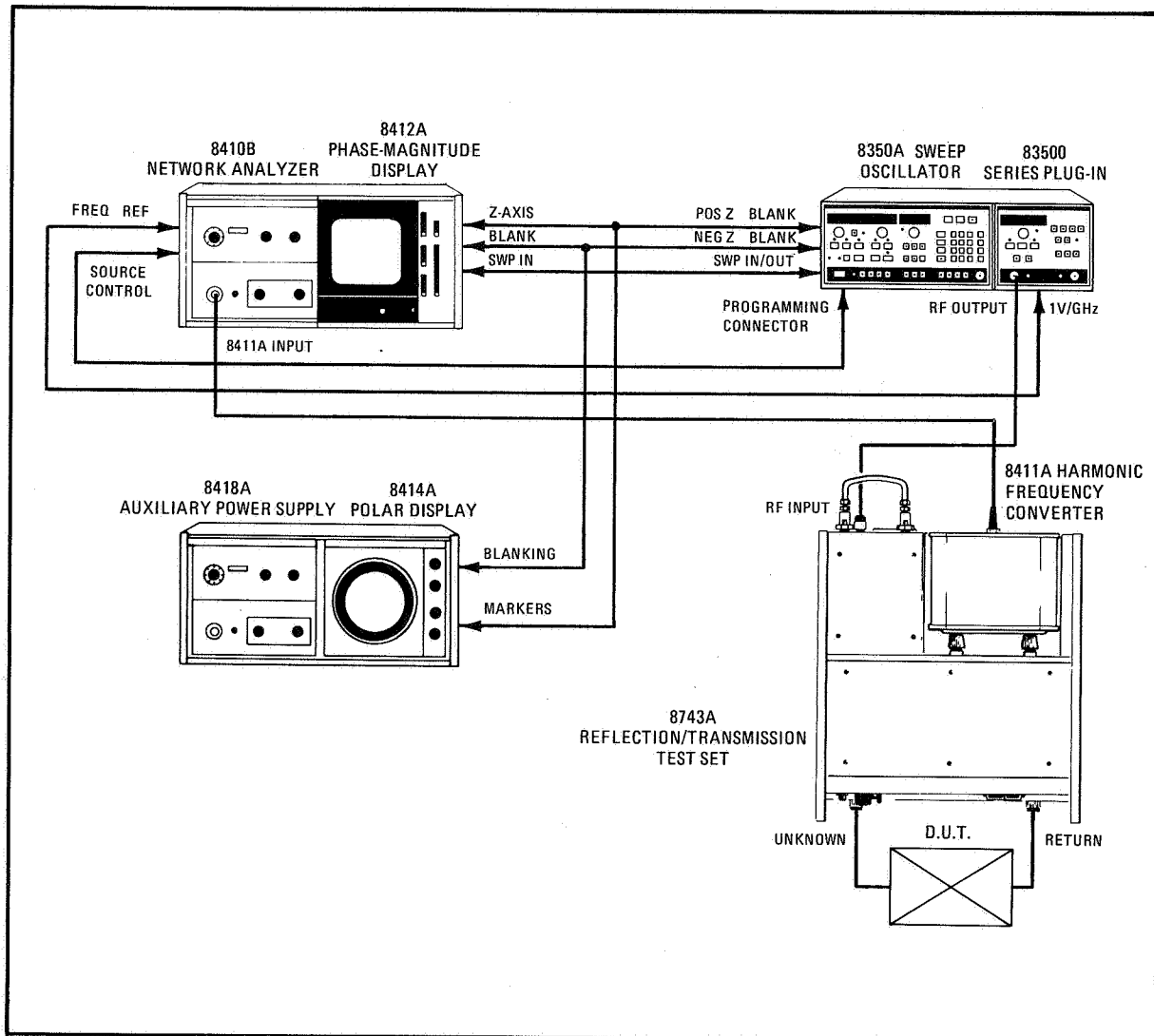

Figure 13. 8350A Connections to 8410

Notes on connections:

- FREQ REF output of the 83500 or 86200 series Plug-ins provides a 1-volt-per-GHz output so that the 8410B may synchronize with the sweep.
- The 8410B display units (8412A, 8414A) require that the NEG Z BLANK from the 8350A be used as the blanking signal.
- POS Z BLANK (from the 8350A line contains the Z-axis markers. This line connects to the MARKERS input on the 8414A Polar Display and to the Z AXIS input on the 8412A Phase-Magnitude Display.
- SWEEP OUT/IN outputs a 0 to +10 volt signal in proportion to the swept or CW frequency output. 0V corresponds to the lower frequency sweep limit; +10V to the upper. Swept RF output causes a ramp voltage out; CW output causes a dc voltage out. This connection is necessary only when using 8412A Phase-Magnitude Display.
- 8350A/8410B SOURCE CONTROL CABLE. Provides "handshake" lines for synchronization between 8350A and 8410B (HP Part No. 08410-60146).

**X-Y RECORDERS**

The 8350A is equipped with outputs for controlling X-Y analog recorders.

Some of the HP X-Y recorders that may be used with the 8350A are:

- 7010B/7015B
- 7035B
- 7004B/7034A
- 7044/7045/7046/7047

The available/required signals for proper operation with an X-Y recorder are:

**X INPUT** – Typically SWEEP IN/OUT. Supplied by BNC connector on front or rear panel.

**Y INPUT** – Y axis voltage. On 8755S Frequency Response Test Set this would be AUX A for channel 1 or AUX B for channel 2. For 8410B systems, the 8412A display provides amplitude and phase outputs.

**PEN LIFT** – Signal line for controlling remote pen up/down. Pen up is open contact or +5 volts. Pen down (current sink) is contact closure to ground or 0 volt. Supplied by BNC connector on rear panel or pin #10 on 8350A Programming Connector.

**RECORDER (SERVO) MUTE** – 7044/7045/7047 only. Control line that mutes the power to the recorder servos for 100 ms at bandswitch (when using multi-band plug-ins) or designated points. Pin #1 on the 8350A Programming Connector.

**PEN LIFT REQUEST** – Allows a pen lift to be initiated by remote control independent of the present pen lift status. Pin #3 on the 8350A Programming Connector.

**INVERSE PEN LIFT** – Inverse function of Pen Lift, pin #23 on 8350A Programming Connector.

The pen lift control line is assigned to a pin on the Remote Control connector of the X-Y recorder. For a complete pin assignment listing refer to the Operating Manual for the particular X-Y recorder being used.

Pen lift pin location on X-Y recorders:

Recorder	Pen Lift Pin No.
7010B/7015B	3
7035B	18
7004B/7034A	18
7044A/45A/47A	1
7046A	34

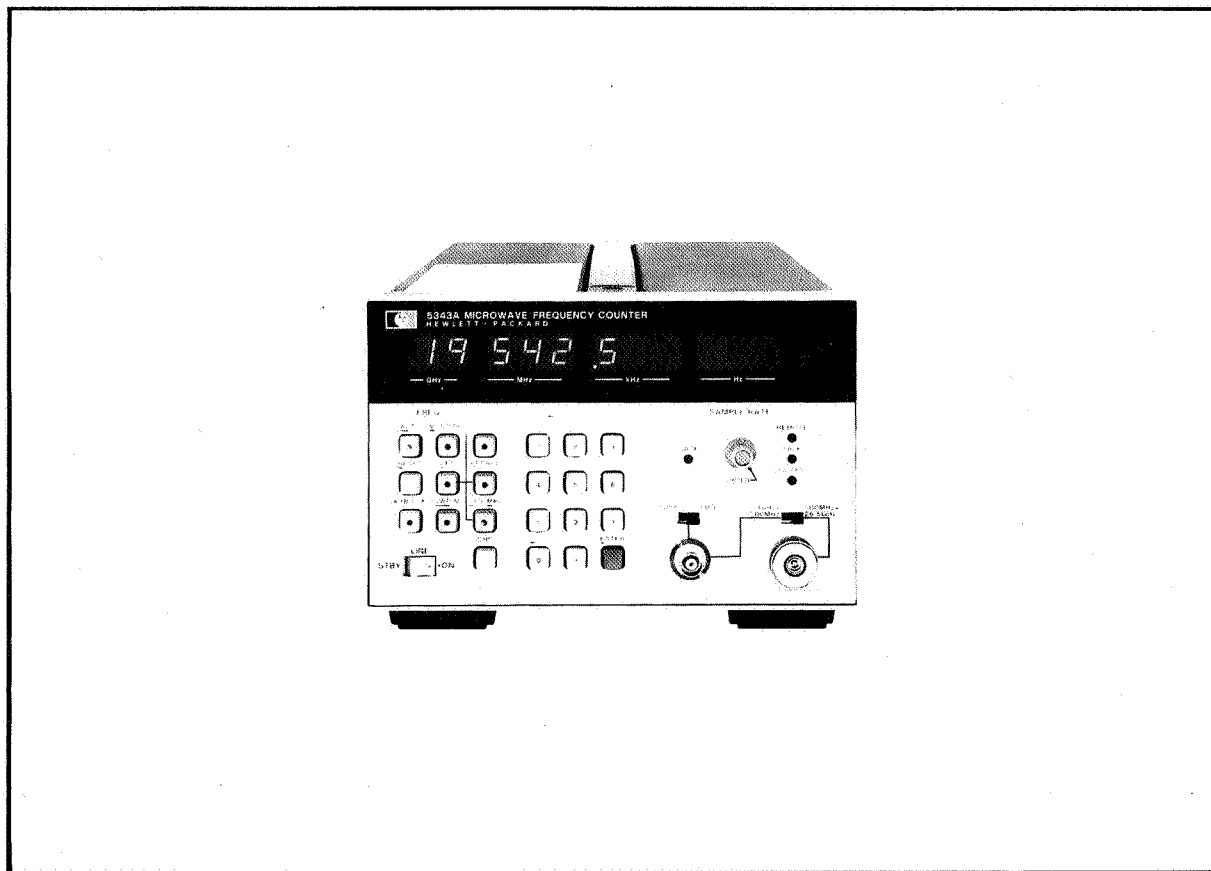

Figure 14.. 5343A Microwave Frequency Counter

### 5343A FREQUENCY COUNTER

The 5343A Microwave Frequency Counter can be used with the 8350A to measure frequencies in swept mode in addition to normal CW frequency measurements.

During swept operation the 5343A will stop the 8350A sweep and count a selected frequency parameter such as the START frequency, STOP frequency or any frequency markers in the sweep range. To accomplish this, the 8350A and 5343A communicate via two signal lines (Counter Trigger, Stop Sweep on the 8350A and Sweep Interface A and B on the 5343A) that enable the 8350A to externally trigger the 5343A and then allow the 5343A to stop the sweep long enough to gate and count the selected frequency parameter.

See Figure 15 for the test set up.

#### Measuring CW frequencies

When measuring CW frequencies the CNTR TRIG and STOP SWEEP connections are not necessary. The 5343A should be in the AUTO mode and the internal square wave modulation on the 8350A must be off.

#### Auxiliary Output

The auxiliary output of an RF Plug-in (if available) may be used with the 5343A. When using the auxiliary output of a multi-band plug-in such as the 83592A (0.01-20 GHz) the frequency multiplier feature of the 5343A may be used so that the proper RF frequency is displayed.



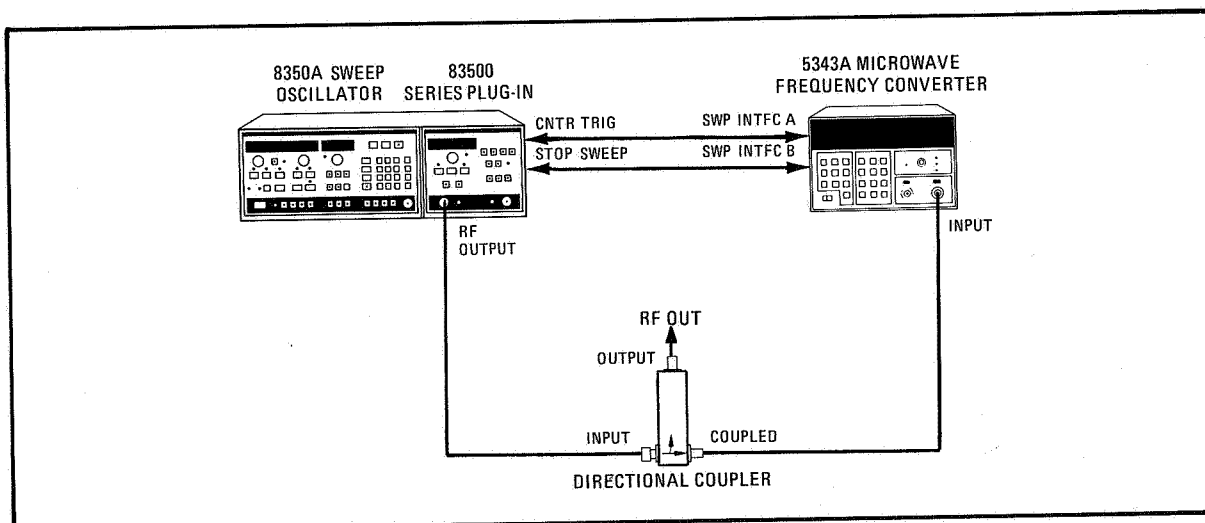

Figure 15. 5343A Test Setup

Notes on connections:

- A power splitter or directional coupler may be used as long as the input to the 5343A does not exceed +7 dBm or go below the minimum sensitivity.
- CNTR TRIG (Counter Trigger): Output for controlling the HP 5343A Microwave Frequency Counter. This allows a frequency count of the selected marker, START or STOP frequency of the present sweep. Connects to the SWP INTFC A (sweep interface, on the rear panel of the 5343A) to externally trigger the counter.
- STOP SWEEP: Input for stopping the progress of the forward sweep. When connected to the SWP INTFC B (sweep interface, on the rear panel of the 5343A) the 5343A stops the sweep long enough for the counter to gate and measure the selected frequency marker, START or STOP frequency. If the internal modulation on the 8350A is on, it is momentarily disabled so that the counter may measure the frequency.

To measure a START, STOP, or marker frequency during a sweep:

**5343A:** Set to AUTO, SWP M and set desired frequency resolution. Set the rear panel ACQ TIME switch to MED or FAST.

**8350A:** Select the frequency parameter to be measured by pressing the appropriate key, START, STOP, or any marker Mn (where n=1, ..., 5) and then press SHIFT M2

If the sweep setting is changed or it is desired to exit this mode, disable the 5343A by pressing SHIFT M3 on the 8350A front panel.

Example:

To measure the START frequency.

1. Connect equipment as shown in Figure 15. Set the 5343A to AUTO, SWP M and set desired frequency resolution.
2. Press the 8350A INSTR PRESET START SHIFT and M2 keys. The 5343A will temporarily stop the sweep, measure the frequency and display it at the desired resolution.

## APPENDIX 1 REAR PANEL CONNECTIONS.

For a diagram of the rear panel see Figure 16.

**POS Z BLANK.** Positive Z axis blanking signal. Supplies a rectangular pulse of approximately +5V into 2500 ohms during the retrace and bandswitch points of the RF output. Also supplies a -5V (-8 volts for active marker) pulse when the RF is coincident with a marker frequency if intensity markers are selected.

**NEG Z BLANK.** Negative Z-axis blanking signal. Supplies a negative rectangular pulse (-5V into 2500 ohms) during the retrace and bandswitch points of the RF output.

**PEN LIFT.** Output to control the pen lift function of an X-Y recorder. Maximum pen-up level is +40V and maximum pen-down sink current is 500 mA (at +0.7V).

**SWEEP OUT/IN.** Wired in parallel with sweep out/in BNC connector on front panel. See Display Functions Control group for a description.

**CNTR TRIG.** Counter Trigger (HP 5343A Frequency Counter only). Output for controlling the external trigger input of the HP 5343A frequency counter.

**STOP SWEEP.** Input for stopping the progress of a forward sweep. When input is 0 to 0.8 volt, sweep is stopped - RF output is a constant CW frequency. Sweep continues when input voltage returns to greater than 2 volts or open circuit. Usable with the HP 5343A Frequency Counter and CNTR TRIG to select and measure frequency points along the sweep.

**FM INPUT.** Input for frequency modulation or phase lock error signal for the plug-in. This input is passed through to the plug-in and processed by the plug-in only. See plug-in specifications for frequency deviation and sensitivity.

**AM INPUT.** Input for external amplitude modulation of the plug-in. This input is passed through to the plug-in. See plug-in specifications for amplitude input range.

**ALT SWP INTERFACE.** Connects via cable HP Part No. 8120-3174 to 8755C to provide Alternate Sweep function.

**PROGRAMMING CONNECTOR.** See Figure 16 for pin designation.

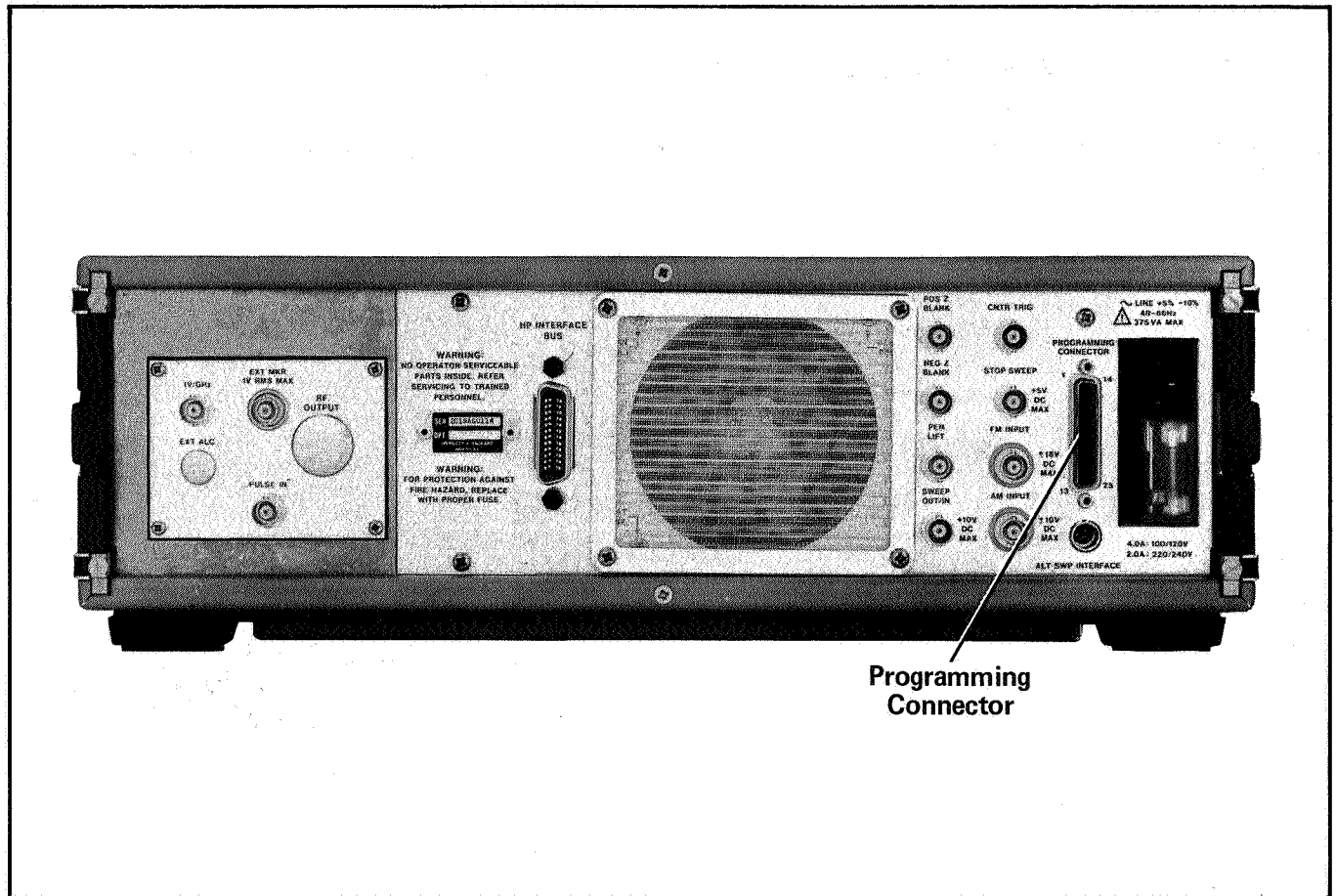

Programming Connector

**PROGRAMMING CONNECTOR**

Pin No.	Description	Pin No.	Description
1		15 -	Marker Pulse Request (I)
2 -	Marker Pulse (O)	16 -	Retrace (O)
3 -	Pen Lift Request (I)	17 -	Alternate Sweep Enable (O)
4 -	Sweep Alternate (O)	18 -	Stop Sweep Request (I)
5 -	Stop Fwd. Sweep Request (I)	19	Digital Ground (I/O)
6	+5 Volt (100 ma MAX) (O)	20 -	Blanking Pulse Request (I)
7 -	RF Blanking (O)	21 -	Counter Trigger (O)
8 -	RF Blank Request (I)	22 -	Step Up Advance (I)
9 -	Ext. Trigger Input (I)	22 -	Inverse Pen Lift (O)
10 +	Pen Lift (O)	23 -	8410 Ext. Trigger (O)
11 -	Recorder Mute (O)	24 +	
12	- (O)	25	-
13	- (O)		
14 -	Blanking (O)		

- Negative Logic (True is logical "0")  
 + Positive Logic

(I) Input  
 (O) Output

Figure 16. Rear Panel Connections

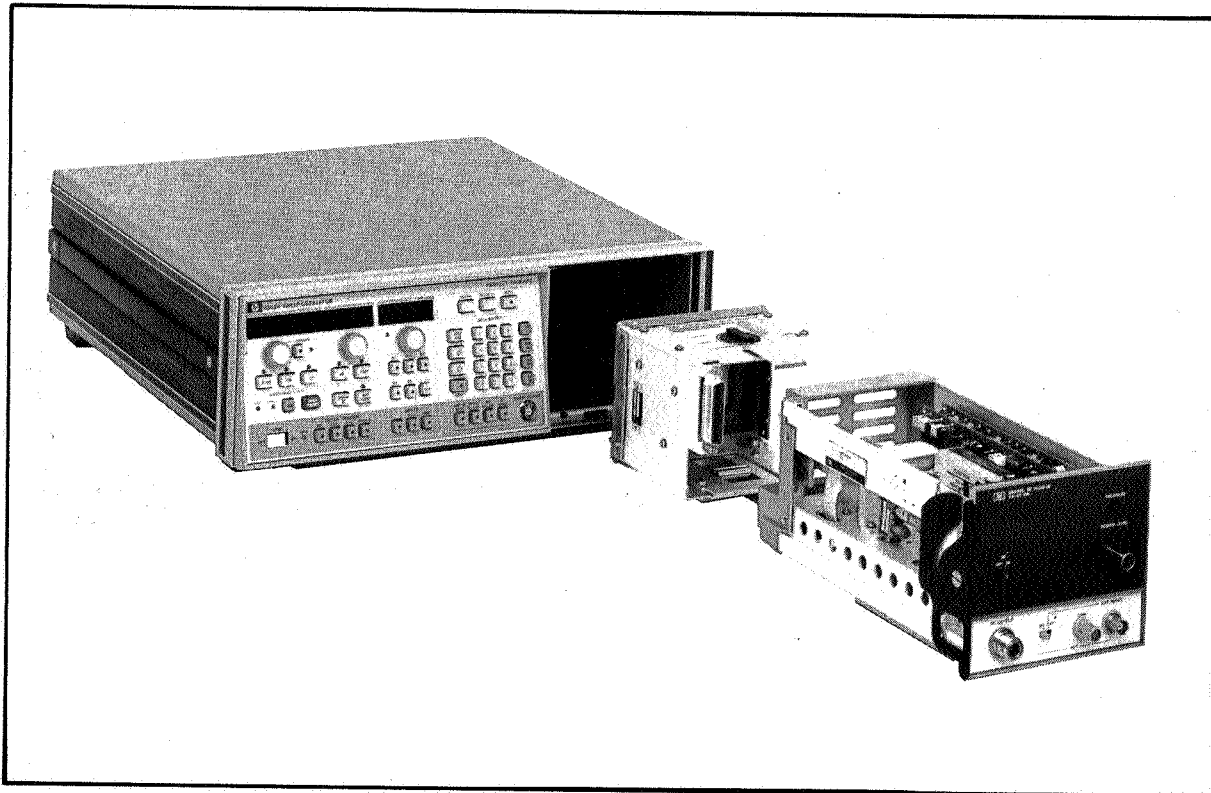
**APPENDIX 2:****86200 SERIES PLUG-INS WITH 11869A ADAPTER**

*Figure 17. Connecting 11869A Adapter to 86200 series Plug-in*

Although designed for the 8620 Sweep Oscillator, the 86200 series RF Plug-ins can be used in the 8350A Sweep Oscillator with the addition of the 11869A Adapter.

The 11869A Adapter provides the electrical and mechanical interface between the 8350A and an 86200 series Plug-in. A switch on the 11869A allows the user to select the appropriate interface code (from the code listing on the adapter) so that an 86200 series Plug-in can be used in the 8350A.

All of the standard performance and control of the 8350A is available when using an 86200 Plug-in with the 11869A Adapter. However, plug-in functions (e.g. output power, RF on/off, plug-in markers) will not be programmable and will not respond to keyboard and step keys. On the rear panel of the 11869A Adapter are several hole plugs that allow connections to be made to the back panel of the plug-in. 11869A Option 004 provides two semi-rigid cables to allow connection of 86200 series rear panel RF output to 11869A rear panel.

**Special Plug-ins: (Plug-ins with Option HXX)**

When using 86200 series Plug-ins that have been factory modified for a non-standard frequency range, a PROM obtained from the factory must be used in the 11869A Adapter. The PROM is inserted in the 16-pin socket on the PC board of the adapter and is needed for proper interfacing and controlling of a non-standard plug-in.

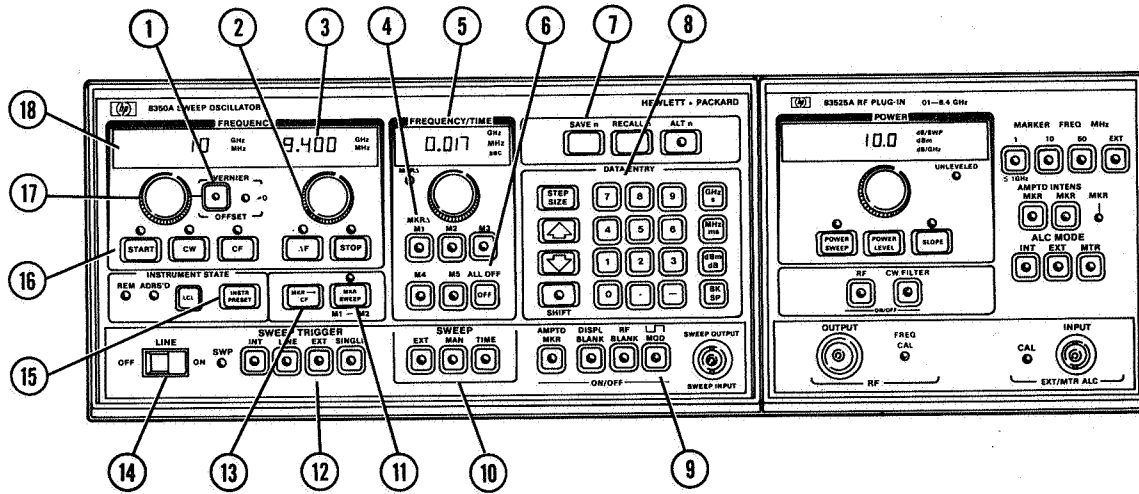

### APPENDIX 3 FRONT PANEL CONTROLS SUMMARY

1. **Vernier/Offset.** Vernier function offsets sweep ranges, CW or CF frequencies. ≠0 lamp lit when non-zero offset or vernier present.
2. **Right Frequency Control.** Adjusts ΔF or STOP frequency.
3. **Right Frequency Display.** Displays STOP or ΔF frequency in GHz or MHz.
4. **MKR-Δ.** Allows user to display frequency difference between any two markers and intensifies the appropriate portion of the display.
5. **Frequency/Time Display.** Display Marker or manual sweep frequency in GHz or MHz. Sweep Time in seconds and HP-IB address.
6. **Markers.** Controls the five independent, mainframe supplied frequency markers.
7. **Save n/Recall n/Alt n.** Can save and recall up to nine different settings.
8. **Data Entry Keyboard.** Can enter exact values or step sizes for most sweep parameters via the keyboard.
9. **Output Controls.** Can control marker display mode, RF and display blanking and internal square wave modulation (of the RF output).
10. **Sweep Mode.** Selects External, Manual, or Timed sweep mode.
11. **MARKER SWEEP.** Causes Marker 1 frequency to temporarily become start of sweep, Marker 2 frequency to become stop of sweep.
12. **Sweep Trigger.** Determines how sweep will trigger.
13. **MKR→CF.** Causes center frequency of sweep to be shifted to the frequency of the currently active marker.
14. **Line switch.** Turns on/off 8350A mainframe and plug-in.
15. **Instrument Preset.** Selects a pre-determined instrument state.
16. **START/CF/CW/ΔF/STOP Sweep mode keys.** Selects mode of output and display.
17. **Left frequency Control.** Adjusts START, CW, CF, VERNIER or OFFSET.
18. **Left Frequency Display.** Displays START, CW, CF, VERNIER or OFFSET frequency in GHz or MHz, depending on mode selected, plus self test error codes.

Figure 18. Front Panel Controls



**HEWLETT  
PACKARD**

# 8350A SWEEP OSCILLATOR

IV PERFORMANCE TESTS  
V ADJUSTMENTS

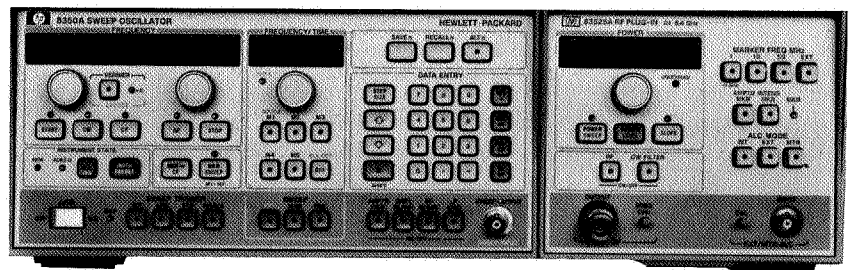

## SECTION IV PERFORMANCE TESTS

### 4-1. INTRODUCTION

4-2. The procedures in this section test the electrical performance of the 8350A Sweep Oscillator/83500 series RF Plug-in combination with the specifications of the Plug-in used as the performance standards. These specifications may be found in Section I of the manual for the Plug-in being tested. Performance of the 8350A is verified if the RF Plug-in meets its specifications. However, complete verification of the 8350A requires the use of a multiband plug-in (i.e. 83525A or 83592A). None of the tests require access to the interior of the 8350A Sweep Oscillator.

#### NOTE

Allow the 8350A Sweep Oscillator and RF Plug-in to warm up for one hour prior to doing any performance tests.

### 4-3. EQUIPMENT REQUIRED

4-4. Equipment required to test any Plug-in with an output frequency up to 12.4 GHz is listed in the Recommended Test Equipment table in Section I of this manual. The RF Plug-in manual Recommended Test Equipment table lists only the test equipment for that particular plug-in. Any equipment that satisfies the critical specifications given in the tables may be substituted for the recommended model.

### 4-5. OPERATION VERIFICATION

4-6. Operation Verification consists of performing the tests listed on paragraph 4-13 steps 1 to 13 and paragraph 4-14 steps 1 to 15. Operation Verification of the HP-IB functions may be done

by executing the program listed on Table 4-1 HP-IB Operation Verification Program using the 9825A/B Desktop Computer. These tests provide reasonable assurance that the sweep oscillator and plug-in are functioning properly and should meet the needs of an incoming inspection (80% verification).

### 4-7. TEST RECORD

4-8. Results of the performance test may be tabulated on the Test Record Card at the end of Section IV in the Plug-in manual. The Test Record Card lists all of the tested specifications and their acceptable limits.

### 4-9. TEST SEQUENCE

4-10. Table 4-2 lists the sequence of the performance tests and the major test equipment required for each test. The performance tests should be performed in the order listed. The performance test for crystal markers and other unique plug-in functions are in the plug-in manual.

### 4-11. CALIBRATION CYCLE

4-12. The performance tests in this section should be performed in intervals of one year or less for the 8350A. For plug-in calibration cycle see respective plug-in manual.

#### NOTE

Plug-ins with output frequencies greater than 12.4 GHz will require use of the Performance Test in the plug-in manual.



Table 4-1. HP-IB Operation Verification Program Using The 9825A/B Desktop Computer

```

0: "HP-IB Operation Verification Test. 18 Sept 80.":
1: "Change Address in Line 3 If Needed.":
2: dim A#[3],B#[3]
3: dev "8350",719
4: "Check REM Line.":
5: rem "8350"
6: dsp "Check REM Light. [CONT] If ON.";stp
7: "Check Handshake Line":
8: on err "HP-IB"
9: time 3000
10: wrt "8350","IP OPST"
11: red "8350",A
12: jmp 2
13: "HP-IB":dsp "Handshake or ATN Line Error.";stp
14: "Check Programmability and Read Output":
15: wrt "8350","ST 100 MS"
16: wrt "8350","OPST";red "8350",A
17: if A=.1;jmp 2
18: "READ":dsp "Programmability or Read Error";stp
19: "Check Data Lines.":
20: wrt "8350","RM"&char(170)
21: wrt "8350","SH 00 M1 0114 M3"
22: red "8350",A#;wait 20
23: wrt "8350","M0 RM"&char(85)
24: wrt "8350","SH 00 M1 0114 M3"
25: red "8350",B#;wait 20
26: if A#[1,2]="AA" and B#[1,2]="55";jmp 2
27: dsp "Data Bus Error.";stp
28: "Check Service Request Capability.":
29: wrt "8350","M0 RM"&char(96)
30: oni 7,"SYN"
31: eir 7
32: wrt "8350","XYZ"
33: wait 500
34: dsp "SRQ Line Error.";stp
35: "SYN":jmp 1
36: wrt "8350","IP"
37: lcl "8350"
38: dsp "End of Test. HP-IB is Verified.";stp
39: end
*28191

```

Table 4-2. Performance Test

Paragraph	Title	Major Equipment
4-13	Frequency Range and CW Accuracy Frequency Range CW accuracy Swept Frequency Accuracy Marker accuracy	Frequency Counter
4-14	Output Amplitude Power Meter Leveling Maximum Leveled Power Power variations Power level accuracy Power Sweep Slope Compensation	Power Meter Frequency Response Test Set
4-15	Frequency Stability With Line Voltage With Power Level With Time (10 minutes) With Load Impedance	Frequency Counter Directional Coupler Adjustable Short Adjustable AC Line Transformer
4-16	Residual FM At 10 kHz bandwidth	Spectrum Analyzer
4-17	Spurious Signals Harmonic Non-Harmonic	Spectrum Analyzer
4-18	Output VSWR	Directional Coupler Detector Oscillator Air Line
4-19	Residual AM	RMS Voltmeter
4-20	External FM Deviation	Spectrum Analyzer Function Generator Frequency Counter Oscilloscope Delay Line Discriminator Power Splitter
4-21	FM Response	Oscilloscope Function Generator Delay Line Discriminator
4-22	AM ON/OFF Ratio and Square Wave Symmetry	Spectrum Analyzer
4-23	Attenuator Accuracy (Option 002)	Spectrum Analyzer Step Attenuator

PERFORMANCE TESTS

4-13. FREQUENCY RANGE AND ACCURACY TEST

SPECIFICATION:

See Performance Test Record Card in section IV of the plug-in manual for frequency range and accuracy specifications.

DESCRIPTION:

A frequency counter is used to check frequency range and accuracy in the CW mode. The frequency counter is also used to check swept frequency accuracy and markers in the START/STOP mode.

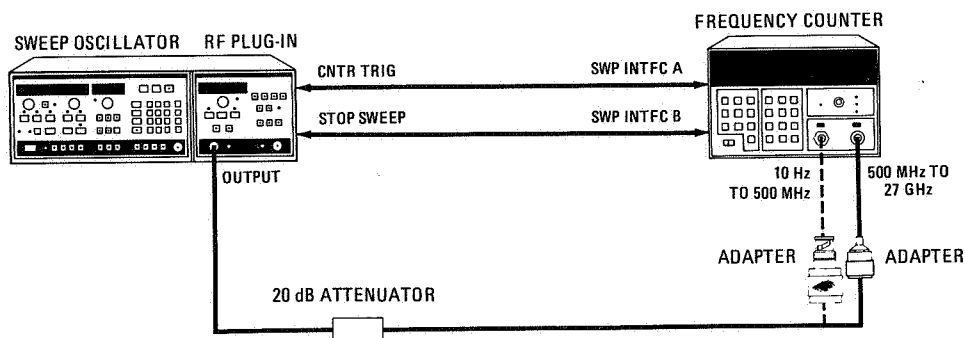

Figure 4-1. Frequency Range and CW Accuracy Test Setup

EQUIPMENT:

- Plug-in ..... HP 83500 series
- Frequency Counter ..... HP 5343A\*
- 20-dB Attenuator ..... HP 8491B, Option 020
- Adapter ..... Type-N, male to APC 3.5, female
- Adapter ..... Type-N, male to BNC male

\*If another counter is used the swept frequency measurements will require the use of additional test equipment. This equipment is listed in the Alternate Swept Frequency Test at the end of this paragraph.

PROCEDURE:

NOTE

Plug-ins having a **FREQ CAL** adjustment on the front panel require performing the **FREQ CAL** procedure in section 3 of the plug-in manual prior to performance of this test.

1. Connect equipment as shown in Figure 4-1.

PERFORMANCE TESTS

**4-13. FREQUENCY RANGE AND ACCURACY TEST (Cont'd)**

2. Set controls as follows:

Frequency Counter

LINE ..... ON  
 SAMPLE RATE ..... minimum (full CCW)  
 Range connector ..... 500 MHz to 27 GHz except as noted  
 Impedance Switch ..... 50Ω  
 ACQ TIME (rear panel) ..... FAST

3. Press 8350A INSTR PRESET key. Note sweep oscillator display of START and STOP frequencies equals the frequency range on the test card.

Frequency Range

4. Press 8350A CW key and enter the previously noted start frequency (If start frequency is below 500 MHz use the 10 Hz to 500 MHz counter input connector). If the frequency observed on frequency counter is greater than the start frequency rotate 8350A CW control counterclockwise until frequency on counter is at or below the specified start frequency. Enter the frequency counter reading on the test card step 4.
5. Enter the previously noted stop frequency. If frequency observed on frequency counter is lower than the specified high frequency rotate the 8350A CW control clockwise until the frequency counter reading is higher or equals the specified high frequency. Enter the frequency counter reading on the test card step 5.

Frequency Accuracy

6. Check frequency accuracy by setting the CW frequency on the 8350A and recording the frequency observed on the frequency counter at the three points on each band as shown on the test card step 6. Follow the sequence of frequencies on the test card to avoid band crossover problems.

Swept Frequency Accuracy

7. Press frequency counter RESET, SWP M (Light on), Blue Key, 1KHz. Press 8350A INSTR PRESET and set sweep time to 105 msec.
8. Press 8350A START, SHIFT, then M2. Check and record the frequency counter reading on the test card step 8.
9. Press 8350A STOP, SHIFT, then M2. Check and record the frequency counter reading on the test card step 9.
10. For multiband plug-ins repeat steps 8, and 9 using the start and stop frequencies on test card step 10.

PERFORMANCE TESTS

4-13. FREQUENCY RANGE AND ACCURACY TEST (Cont'd)

Frequency Marker Accuracy

11. Press 8350A INSTR PRESET and set sweep time to 105 msec.
12. Set the 8350A frequency markers to the frequencies listed and record the frequency counter readings on the test card step 12.
13. For multiband plug-ins set the start and stop frequencies on the test card step 13 and repeat the previous step with the markers set as shown on the test card step 13.

Alternate Swept Frequency and Marker Accuracy Test

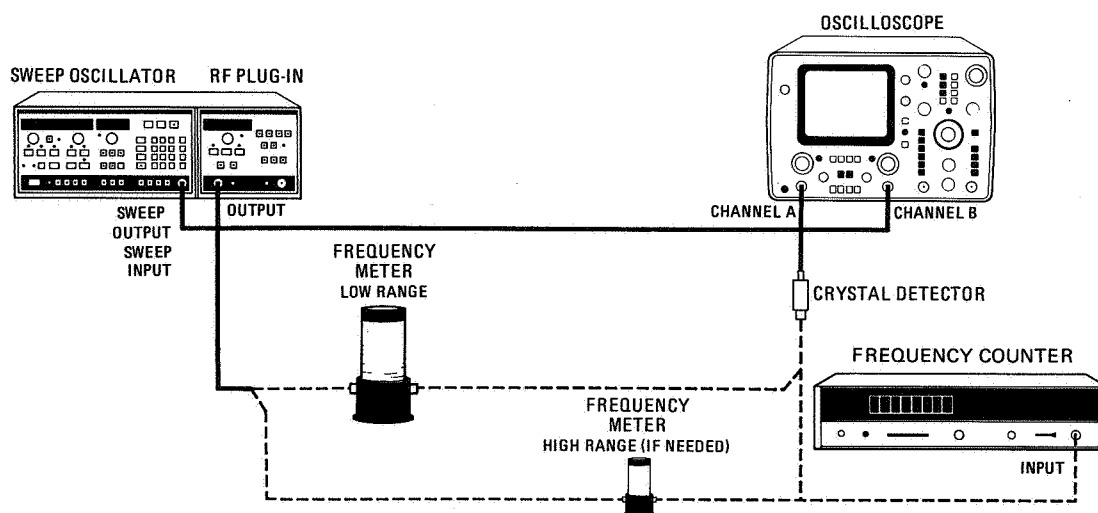

Figure 4-2. Alternate Swept Frequency Accuracy Test Setup

EQUIPMENT:

Plug-in.....	HP 83500 series
Crystal Detector .....	HP 8470B
Frequency Counter .....	HP 5340A
Oscilloscope .....	Any general purpose oscilloscope such as HP 1222A or 1740A
Frequency Meters as needed to cover frequency range of plug-in)	
0.96 to 4.2 GHz.....	HP 536A
3.7 to 12.4 GHz .....	HP 537A

NOTE

The low frequency limit of the Frequency Meters is 0.96 GHz which limits the RF Plug-ins with output frequencies lower than 1 GHz to a swept frequency check of 1.00 GHz or using the 5343A.

---

**PERFORMANCE TESTS**

---

**4-13. FREQUENCY RANGE AND ACCURACY TEST (Cont'd)**

7A. Connect equipment as shown in Figure 4-2. Use Frequency Meter/s necessary to cover the high and low frequency range of the installed plug-in. Press 8350A **INSTR PRESET** key then set sweep time to 105 msec. If start frequency displayed is lower than 1 GHz the start frequency must be changed to 1 GHz. Set oscilloscope to A vs. B and MAG X10 mode.

**NOTE**

To use the frequency meters for swept and marker frequency accuracy first calibrate the frequency meters. Calibrate meters by using the frequency counter to set the 8350A swept CW frequency to each frequency listed on the test card steps 8, 9, 10, 12, and 13 then connect the oscilloscope and adjust the frequency meter to dip trace. Record difference between actual and frequency meter reading.

8A. Adjust frequency meter to move notch on oscilloscope to start frequency. Check and record corrected Frequency Meter reading on test card step 8A.

9A. Adjust frequency meter to move notch on oscilloscope to Stop Frequency. Check and record corrected Frequency Meter reading on test card Step 9.

10A. For multiband plug-ins repeat steps 8 and 9 using the start and stop frequencies on test card step 10A.

11A. Press 8350A **INSTR PRESET** and set sweep time to 105 msec.

12A. Set the 8350A frequency markers to the frequencies listed on the test card. Adjust the frequency meter notch over each marker and record the corrected frequency meter reading on the test card step 12.

13A. For multiband plug-ins set the start and stop frequencies on the test card step 13 and repeat the previous step with the markers set as shown on the test card step 13.

---

**4-14. OUTPUT AMPLITUDE TEST****SPECIFICATION:**

See Performance Test Record Card in section IV of the appropriate plug-in manual for output amplitude specifications.

**DESCRIPTION:**

A Power Meter is used to check maximum power and power variations in power meter leveling. A Swept Amplitude Analyzer is used to check power variations at maximum leveled power internally leveled, power level accuracy, and power sweep.

PERFORMANCE TESTS

4-14. OUTPUT AMPLITUDE TEST (Cont'd)

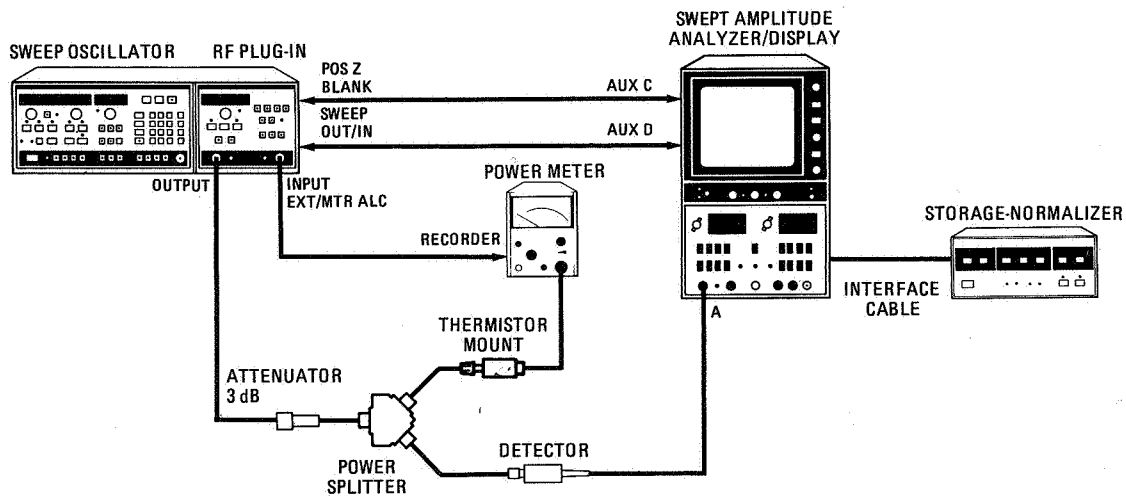

Figure 4-3. Output Amplitude Test Setup

EQUIPMENT:

NOTE

If a Storage-Normalizer 8750A is not available use a grease pencil to record the detector response on the CRT.

Plug-in .....	HP 83500 series
Power Meter .....	HP 432A
Thermistor Mount .....	HP 8478B
Oscilloscope .....	HP 182T
Swept Amplitude Analyzer .....	HP 8755C
Detector .....	HP 11664A
Power Splitter .....	HP 11667A
3 dB Attenuator .....	HP 8491B Opt 003
Storage-Normalizer .....	HP 8750A

PROCEDURE:

NOTE

If oscilloscope will not synchronize on CRT it may be due to the  $\square$  MOD frequency being set to 1 kHz. To change the frequency to 27.8 kHz refer to section VIII of this manual.

PERFORMANCE TESTS

4-14. OUTPUT AMPLITUDE TEST (Cont'd)

1. Connect equipment as shown in Figure 4-3. Turn on Storage-Normalizer and Swept Amplitude Analyzer. Adjust GAIN and REFERENCE POSITION controls as per the Amplitude Analyzer manual. Adjust Storage-Normalizer per its operation section to match the Swept Amplitude Analyzer using the Network Analyzer card.
2. Press INSTR PRESET and SHIFT CW then engage  $\Gamma$  MOD on the 8350A. Set plug-in POWER LEVEL display to specified maximum leveled power and ALC mode to MTR.
3. Adjust power meter CALIBRATION FACTOR to the value on the thermistor mount corresponding to the frequency displayed on the 8350A. Set power meter RANGE switch and adjust plug-in EXT/MTR ALC CAL for a power meter reading 12 dB below plug-in displayed power. The 12 dB is due to the following losses: Power Splitter=6 dB, Attenuator=3 dB, and  $\Gamma$  MOD=3 dB.
4. Press SELECT CH 1, and BYPASS on storage-normalizer.
5. Set amplitude analyzer controls as follows:

VIDEO FILTER..... OFF

CHANNEL 1  
 DISPLAY..... A  
 dB/DIV..... 10  
 VERNIER..... ON  
 OFFSET..... -00

CHANNEL 2  
 DISPLAY..... All buttons out

6. Adjust CH 1 REFERENCE LEVEL VERNIER to center trace. Change dB/DIV to 0.25 and center trace again using REFERENCE VERNIER.

7. Set 8350A controls to:

SWEEP TIME..... 100 sec  
 SWEEP TRIGGER..... SINGLE  
 Sweep Mode..... START/STOP(full plug-in range)

8. Engage INPUT and STORE INPUT keys on storage-normalizer.

Power Meter Leveling

NOTE

If plug-in is multiband allow a small discontinuity (typically <0.25 dB) at the band switching point/s listed on the test card step 9.

9. Press 8350A SWEEP TRIGGER SINGLE key to start sweep while observing that the SWP light goes on. Observe and record power meter peak-to-peak meter fluctuations on test record card step 9.



## PERFORMANCE TESTS

**4-14. OUTPUT AMPLITUDE TEST (Cont'd)**

10. To store the observed trace in the 8750A (STORE light off) a trigger signal may be needed. To get a trigger signal press the 8350A **SINGLE** key once and wait until the 8750A store light goes off. Then press the **SINGLE** key again to stop the sweep.

**NOTE**

**System irregularities can be checked by exchanging the thermistor and detector and sweeping again with the storage-normalizer in INPUT-MEM.**

11. Set the following controls:

Plug-in  
ALC MODE..... INT

8350A  
SWEEP TIME..... 10 msec  
SWEEP TRIGGER..... INT  
SWEEP MODE..... SHIFT CW

Storage-Normalizer  
DISPLAY..... INPUT-MEM

Plug-in  
Connect power meter to plug-in OUTPUT, turn off **□ MOD**. Adjust **POWER LEVEL** control until power meter reads the specified maximum leveled power. Reconnect attenuator and power splitter to plug-in and turn on **□ MOD**.

Amplitude Analyzer  
Adjust **VERNIER** until trace (mid-point in frequency sweep) lies on the center line. This calibrates center line of Amplitude Analyzer for specified maximum leveled absolute power.

**Power Level Accuracy**

12. Press the **POWER LEVEL** key on the plug-in then via the 8350A Data Entry keys enter the specified maximum leveled output power. Press the **START** key on the 8350A. Check and record that the amplitude analyzer peak-to-peak power variations are within the limits shown on the test record card step 12.

**Calibrated Range**

13. Press the **POWER LEVEL** key on the plug-in, then press the 8350A **▼** key to reduce plug-in power by 1 dB. Reduce amplitude analyzer **REFERENCE LEVEL** switch setting by 1 dB. Check and record that peak-to-peak power variations are within the limits shown on test record card step 13. Repeat this step for the power levels on the test card to verify power level accuracy over the entire range.

## PERFORMANCE TESTS

**4-14. OUTPUT AMPLITUDE TEST (Cont'd)**

14. Press the **POWER LEVEL** key on the plug-in then via the 8350A Data Entry keyboard enter the maximum specified output power. Switch the **REFERENCE LEVEL** switch to  $-00$  dBm.

**Maximum Internally Leveled Output Power and Variation**

15. Use Power Level control to adjust power level such that the minimum power point across the sweep lies exactly on the center line (See example on Figure 4-4). The minimum power on the full sweep is then at the specified maximum power. Check and record the peak power across the whole band on the test record card step 15.

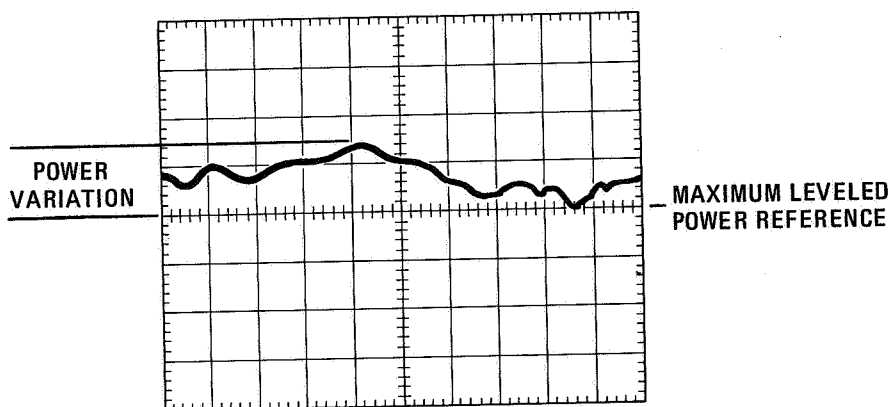

Figure 4-4. Typical Maximum Leveled Power and Variation

16. Press **BYPASS** on the storage-normalizer. Engage the 10 dB/DIV button on the amplitude analyzer.

**Power Sweep Check**

17. Press **START** on 8350A. Press **POWER LEVEL** on plug-in and adjust power control to the value shown on the performance test card step 17. Engage **POWER SWEEP** and adjust **POWER** control clockwise until the **UNLEVELED** light turns on. Turn **POWER** control counterclockwise until the unleveled light remains off. Check the **POWER SWEEP** display and amplitude analyzer display to verify the amplitude change from beginning to end of sweep is at least the level specified on the test card step 17.

**4-15. FREQUENCY STABILITY TEST****SPECIFICATION:**

See Performance Test Record Card in section IV of the plug-in manual used for Frequency Stability specifications.

**DESCRIPTION:**

A frequency counter is used to check frequency change due to line voltage changes, time (10 minutes), output power level changes, and load impedance changes.

PERFORMANCE TESTS

4-15. FREQUENCY STABILITY TEST (Cont'd)

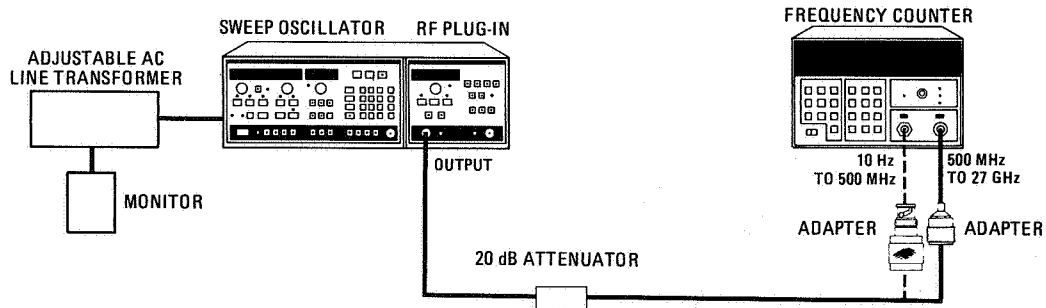

Figure 4-5. Frequency Change with Line Voltage Change

EQUIPMENT:

NOTE

More than one model number is listed for some test equipment. Use only the equipment needed to cover the line voltage used.

RF Plug-in.....	HP 83500 series
Frequency Counter.....	HP 5343A
20 dB Attenuator.....	HP 8491B Option 020
Adapter.....	Type-N, male to APC 3.5, female
Directional Coupler.....	HP 778D
Adjustable AC Line Transformer and monitor (Select for line voltage needed)	
100-120 volt.....	General Radio W5MTB
120 V Monitor.....	RCA WV 120B
220-240 volt.....	General Radio W10HM73
240V Monitor.....	RCA WV 503A
3 dB Attenuator.....	HP 8491B Opt. 003
Adjustable Short.....	Maury Microwave 1953-2

PROCEDURE:

Frequency Change with Line Voltage Change

1. Connect equipment as shown in Figure 4-5 and set 8350A LINE switch to ON.

PERFORMANCE TESTS

4-15. FREQUENCY STABILITY TEST (Cont'd)

2. Set adjustable line transformer using suitable monitor to the line voltage set on the 8350A power module. Press the 8350A **INSTR PRESET** and **CW** key and enter the 8350A frequency shown on the test card (Frequency Stability Step 2). Rotate frequency counter **SAMPLE RATE** knob to **HOLD**, press **SET**, **OFS MHZ**, **Blue Key**, then rotate the Frequency Counter **SAMPLE RATE** knob counter-clockwise back to the normal position.

Table 4-3. High and Low Line Voltage Selection Table

Nominal Line Voltage	100V	115/120V	220V	240V
Low Line Voltage	90V	108V	198V	216V
High Line Voltage	105V	126V	231V	252V

3. Set adjustable line transformer to the low line voltage using suitable monitor which corresponds to the selected nominal voltage in Table 4-3. Check and record on the test record card step 3 the difference frequency displayed on counter.
4. Set adjustable line transformer using suitable monitor to the high line voltage using suitable monitor which corresponds to the selected nominal voltage. Check and record on the test record card step 4 the difference frequency displayed on counter.

Frequency Change with Time (10 minutes)

5. Set adjustable line transformer voltage to nominal. Set Plug-In RF power and CW frequency to that shown on test card step 5 (wait one minute for frequency counter and oscillator to settle).
6. Rotate the frequency counter **SAMPLE RATE** knob to **HOLD**, press **SET**, **OFS MHZ**, **Blue Key**, then rotate the Frequency Counter **SAMPLE RATE** knob counter-clockwise back to the normal position. The counter is now indicating frequency change with time.
7. Wait 10 minutes while observing frequency count for maximum frequency change and record this maximum change on the performance test record card step 7.
8. If the Plug-in is a multiband unit repeat steps 6 and 7 for the other frequencies shown on the test card.

Frequency Change With 10 dB Power Level Change

9. Set output power and CW frequency as indicated on test record card step 9.

## PERFORMANCE TESTS

## 4-15. FREQUENCY STABILITY TEST (Cont'd)

10. Rotate the frequency counter SAMPLE RATE knob to HOLD, press SET, OFFSET, Blue Key, then rotate the frequency counter SAMPLE RATE knob counter-clockwise back to the normal position. Reduce the output power to the level shown on the test card (-10 dB) and record the frequency change on the test card step 10.
11. If the Plug-in is a multiband unit repeat step 10 for the other frequencies shown on the test card step 11.

## Frequency Change With 3:1 Load SWR

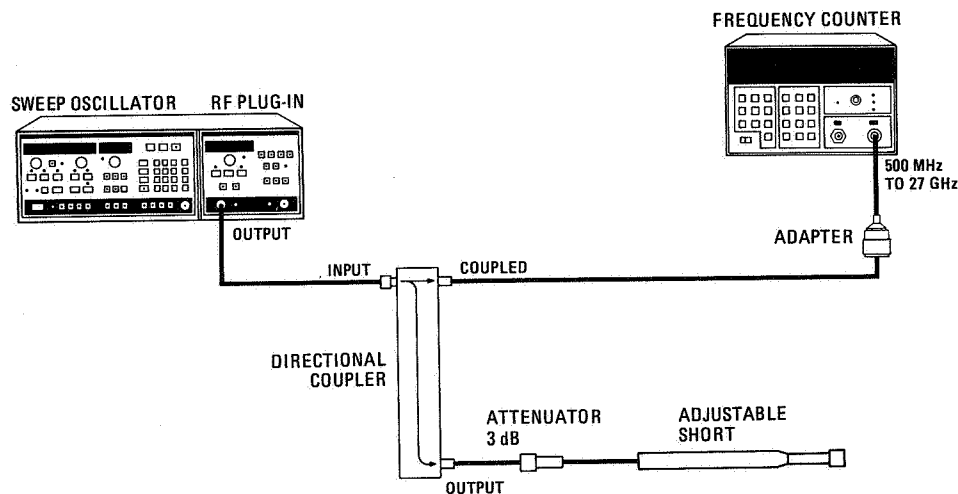

Figure 4-6. Frequency Change with 3:1 Load SWR Test Setup

12. Connect equipment as shown in Figure 4-6. Press the 8350A INSTR PRESET key then the CW key.
13. Enter the 8350A display frequency and power noted on the test card (step 13). On counter rotate the SAMPLE RATE knob clockwise to HOLD, press SET OFS MHZ Blue Key, then rotate the SAMPLE RATE knob counter-clockwise to the normal position on the Frequency Counter.
14. Adjust the adjustable short through its range while observing the frequency counter for the greatest plus and minus frequency change. Check and record the sum of the maximum plus and minus frequency change on the test card step 14.
15. If the Plug-in is a multiband unit the test should be repeated for the other band/s by repeating steps 13 and 14. for the other frequency/ies on the Plug-in test card. Record on test card step 15.

PERFORMANCE TESTS

4-16. RESIDUAL FM TEST

SPECIFICATION:

See Performance Test Record Card in section IV of plug-in manual for residual FM specification.

DESCRIPTION:

RF output signal is displayed on a spectrum analyzer with the option of direct readings using the modulation analyzer. Without the modulation analyzer the residual FM is observed on the storage display by displaying five superimposed traces.

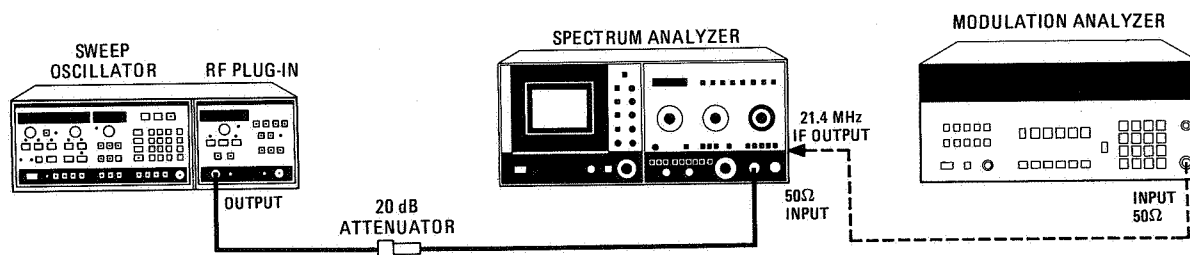

Figure 4-7. Residual FM Test Setup

EQUIPMENT:

NOTE

The modulation analyzer listed below is not required for the test. It is included to make the test convenient.

Sweep Oscillator.....	HP 8350A
Spectrum Analyzer .....	HP 8565A
Modulation Analyzer .....	HP 8901A
20 dB Attenuator .....	HP 8491B, Option 020

PROCEDURE:

1. Connect equipment as shown in Figure 4-7.
2. Press 8350A INSTR PRESET, CW. Enter frequency shown on test card step 2.

NOTE

To minimize drift allow 5 minutes before continuing with test.

## PERFORMANCE TESTS

## 4-16. RESIDUAL FM TEST (Cont'd)

3. Tune spectrum analyzer to CW frequency set for plug-in. Set spectrum analyzer resolution bandwidth to 10 kHz and frequency span per division to 10 kHz while keeping signal centered on CRT display. Auto stabilizer should be on.
4. Select spectrum analyzer linear (LIN) amplitude scale and adjust reference level controls for a full eight division vertical display. Set scan time per division to 20 msec.
5. Set spectrum analyzer sweep trigger to single sweep. Set persistence control fully clockwise and erase the trace. Push spectrum analyzer start/reset pushbutton five times within a two second interval and store resultant traces on CRT screen. Display should be similar to that shown in Figure 4-8. Note the peak-to-peak residual FM across the top of the trace and divide it by two to get the peak. Record the peak residual FM on the test card step 5.
6. If plug-in is a multiband unit repeat steps 3, 4, and 5 at the frequency/ies on the test card step 6.

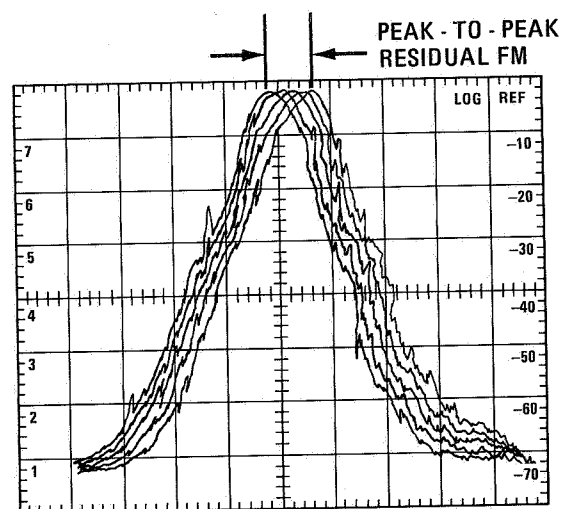

Figure 4-8. Residual FM Display on Spectrum Analyzer

#### With optional Modulation Analyzer

- 5A. Set spectrum analyzer to 1 MHz bandwidth, and 0 spanwidth. Adjust the spectrum analyzer fine frequency control for maximum amplitude. The spectrum analyzer is now being used as a down converter only. Set 8901A high pass filter to 50 Hz and low pass filter to 15 kHz. Press 8901A FM, AUTOMATIC OPERATION, PEAK +, and PEAK HOLD keys on Modulation Analyzer. Check and record the displayed Residual FM on the test card step 5.
- 6A. If plug-in is a multiband unit, repeat steps 3, 4, and 5A using the frequency/ies on the test card step 6.

PERFORMANCE TESTS

4-17. SPURIOUS SIGNALS TEST

SPECIFICATION:

See Performance Test Record Card in section IV of plug-in manual for harmonic and non-harmonic spurious signals specifications.

DESCRIPTION:

RF output signal from sweep oscillator is displayed on a spectrum analyzer to verify that harmonic and non-harmonic spurious signals are at or below the specified level.

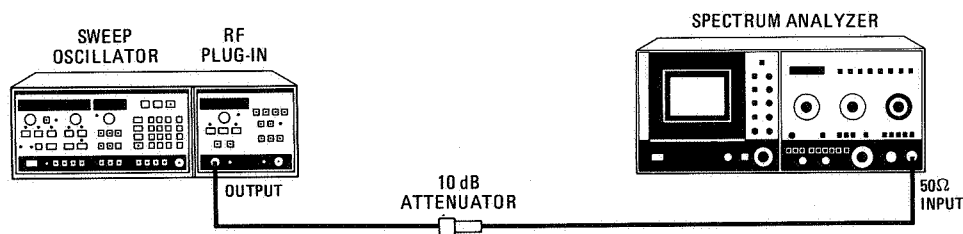

Figure 4-9. Spurious Signals Test Setup

EQUIPMENT:

- RF Plug-in..... HP 83500 series
- Spectrum Analyzer ..... HP 8565A
- 10 dB Attenuator ..... HP 8491B, Option 010

PROCEDURE:

1. Connect equipment as shown in Figure 4-9.
2. Set controls as follows:

8565A:  
 Set all Normal Settings (controls marked with green)  
 FREQUENCY BAND GHz..... .01-1.8  
 INPUT ATTEN ..... 10 dB  
 REF LEVEL dBm .... Set for same level as plug-in maximum leveled power  
 FREQUENCY SPAN MODE..... FULL BAND

8350A  
 Press INSTR PRESET, CW, and enter the low frequency limit of the plug-in used.

Plug-in  
 POWER ..... maximum specified  
 CW FILTER ..... ON



---

**PERFORMANCE TESTS**

---

**4-17. SPURIOUS SIGNALS TEST (Cont'd)****NOTE**

The spectrum analyzer originates some mixing products that may appear on the display. If a signal is in question, increase the spectrum analyzer input attenuation by 10 dB, note if signal decreases in amplitude by 10 dB, then return the attenuator to the original position. If the signal in question comes from an external source, it will change by 10 dB. If the signal in question originates in the spectrum analyzer, the level will either change by greater or less than 10 dB or may not change at all.

The 8350A CW control when being rotated may generate some noise spikes.

If a spurious signal is found that appears out of specifications check the fundamental signal amplitude to ensure it is at maximum specified power. Then check spurious level by substituting a known amplitude signal on the spectrum analyzer.

3. Adjust the 8350A CW control through the entire range of the RF plug-in and check for harmonic and non-harmonic spurious signals. The specifications for harmonic and non-harmonic signals are on the performance test record card step 3.
4. Change the spectrum analyzer to each of the next higher frequency bands and repeat the previous step.

---

**4-18. OUTPUT VSWR TEST****SPECIFICATION:**

See Performance Test Record Card in section IV of plug-in manual for output VSWR specifications.

**DESCRIPTION:**

The RF Output signal is measured using a directional coupler, crystal detector, and oscilloscope. The signal at the oscilloscope contains (1) the incident signal from the oscillator, and (2) the reflected signal. The reflected signal is developed as follows: The incident signal travels down the 20 cm air lines (2 to 18 GHz) or 3 to 6 metres of coaxial cable (.01 to 2 GHz), encounters the open end, and is reflected back to the source. If the reflected signal at the RF OUTPUT connector encounters a perfect 50-ohm source match, no signal is reflected back. However, the greater the mismatch, the greater the reflected signal. This reflected signal either adds to or subtracts from the incident signal. This variation is displayed on the oscilloscope.

PERFORMANCE TESTS

4-18. OUTPUT VSWR TEST (Cont'd)

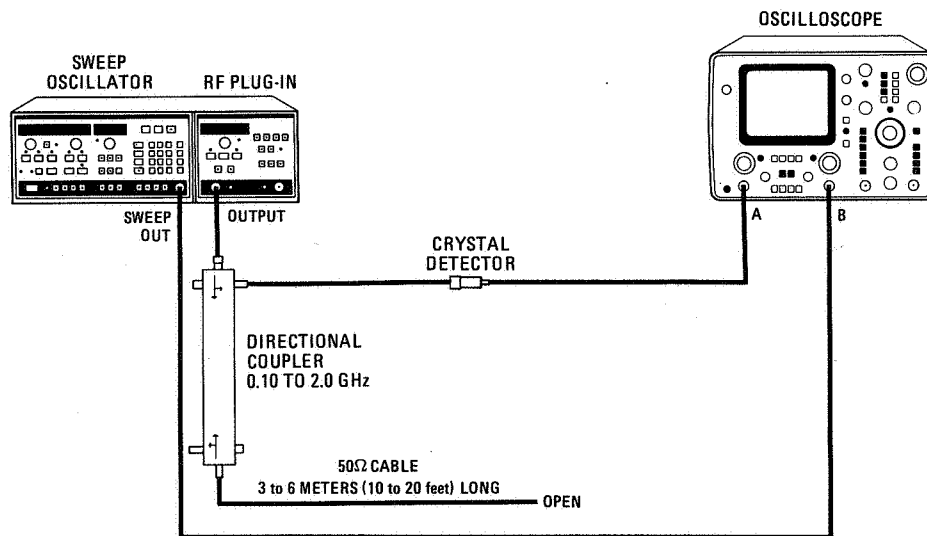

Figure 4-10. Low Frequency Output VSWR Test Setup

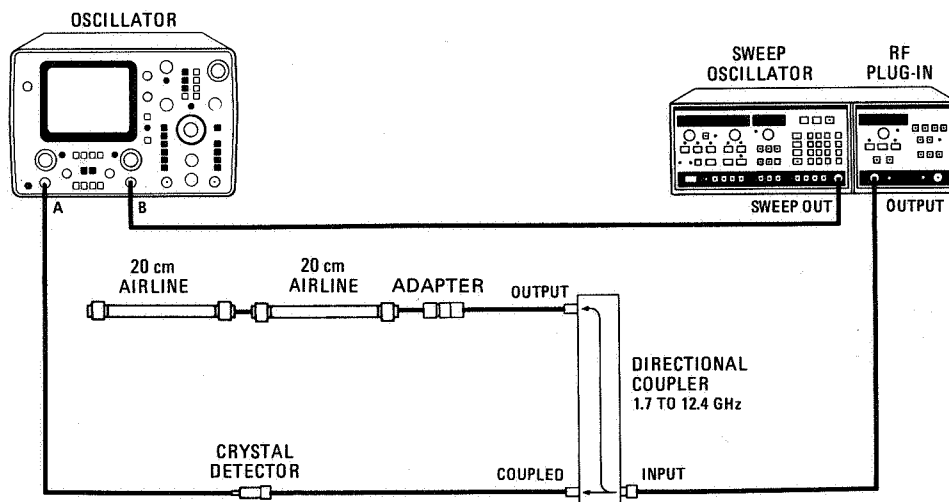

Figure 4-11. High Frequency Output VSWR Test Setup

## PERFORMANCE TESTS

## 4-18. OUTPUT VSWR TEST (Cont'd)

## EQUIPMENT:

RF Plug-in.....	HP 83500 series
Oscilloscope.....	Any general purpose oscilloscope such as HP 1222A or 1740A
Crystal Detector.....	423B
Directional couplers	
0.10 to 2 GHz.....	HP 778D
1.7 to 12.4 GHz.....	HP 779D
Cable	
0.01 to 2 GHz.....	3 to 6 metres (10 to 20 feet) see Table 4-4
2 to 18.....	HP 11567A 20-cm Air Lines (2 required)
Adapter APC-7 to Type-N male.....	HP 11525AC

## PROCEDURE:

## Low Frequency Output VSWR Test

## NOTE

A single section of 3 to 6 metre (10 to 20 feet) 50-ohm cable is required to avoid mismatch of connector when performing the low frequency VSWR test.

1. If the specified output frequency range of the plug-in under test is lower than 2 GHz connect equipment as shown in Figure 4-10 if not go to step 7.
2. Press INSTR PRESET, STOP, 2, GHZ/s on 8350A. Set DISPL BLANK off and RF BLANK on.
3. Adjust POWER level control on plug-in for an maximum output power of -25 millivolts peak trace on oscilloscope display in order to keep crystal in square law output range.
4. Select several points on trace and calculate  $V_{MAX}/V_{MIN}$  (see Figure 4-12).

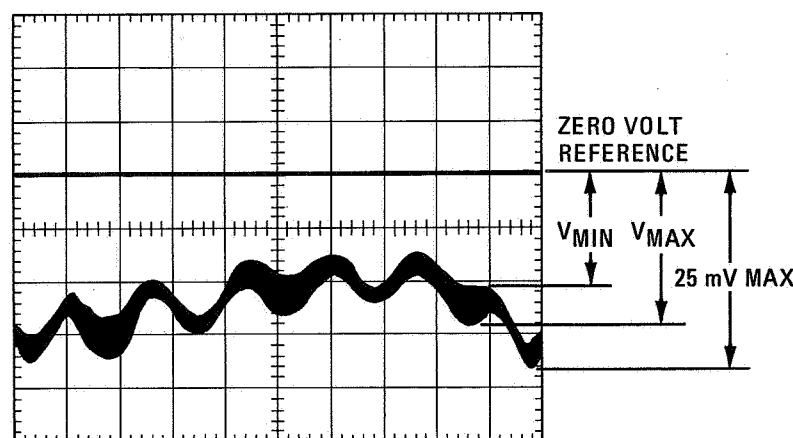

Figure 4-12. Typical Low Frequency Swept VSWR Measurement.

## PERFORMANCE TESTS

**4-18. OUTPUT VSWR TEST (Cont'd)**

5. Determine the loss at selected frequency of the length of coaxial cable (between coupler end and cable open end), using manufacturer's specifications for loss/foot. (Refer to Table 4-4.)
6. Convert  $V_{MAX}/V_{MIN}$  ratio noted in step 5 into source match SWR, using Figure 4-13 and the cable loss calculated in step 5. The SWR should be less than noted on the performance test card step 6.

**High Frequency Output VSWR Test**

7. Connect equipment as shown in Figure 4-11.
8. Press **INSTR PRESET**, **START**, **2**, **GHz/s** on 8350A. Set **DISPL BLANK** off and **RF BLANK** on.
9. Adjust **POWER** control on plug-in for a maximum output power of -25 millivolts peak trace on oscilloscope display in order to keep crystal in square law output range.
10. Select points on trace where  $V_{MAX}/V_{MIN}$  appear to have greatest separation and calculate  $V_{MAX}/V_{MIN}$  for each point.
11. Convert greatest  $V_{MAX}/V_{MIN}$  ratio noted in step 10 into source match SWR using Figure 4-13 on the 0 dB loss line. The SWR should be less than noted on the performance test record card step 11.

Table 4-4. Loss in Coaxial Cable

RG Cable Type	Attenuation (dB/100 ft.) at Selected Frequency					
	0.1 GHz	0.2 GHz	0.4 GHz	0.6 GHz	1 GHz	3 GHz
58/U	2.4	3.6	5.2	6.6	8.8	16.7
98/U	2.3	3.4	5.2	6.5	9.0	17.0
55A/U	4.8	7.0	10.5	13.0	17.0	32.0
58A/U	6.2	9.2	14.0	17.5	23.5	45.0
58C/U	6.2	9.2	14.0	17.5	23.5	45.0
177/U	0.95	1.5	2.4	3.2	4.5	9.5
212/U	2.4	3.6	5.2	6.6	8.8	16.7
213/U	2.1	3.1	5.0	6.5	8.8	17.5
214/U	2.3	3.4	5.2	6.5	9.0	17.0
215/U	2.1	3.1	5.0	6.5	8.8	16.7
217/U	1.5	2.3	3.5	4.4	6.0	11.7
218/U	0.95	1.5	2.4	3.2	4.5	9.5
219/U	0.95	1.5	2.4	3.2	4.5	9.5
220/U	0.69	1.12	1.85	—	3.6	7.7
221/U	0.69	1.12	1.85	—	3.6	7.7
223/U	4.8	7.0	10.5	13.0	17.0	32.0
224/U	1.5	2.3	3.5	4.4	6.0	11.7

PERFORMANCE TESTS

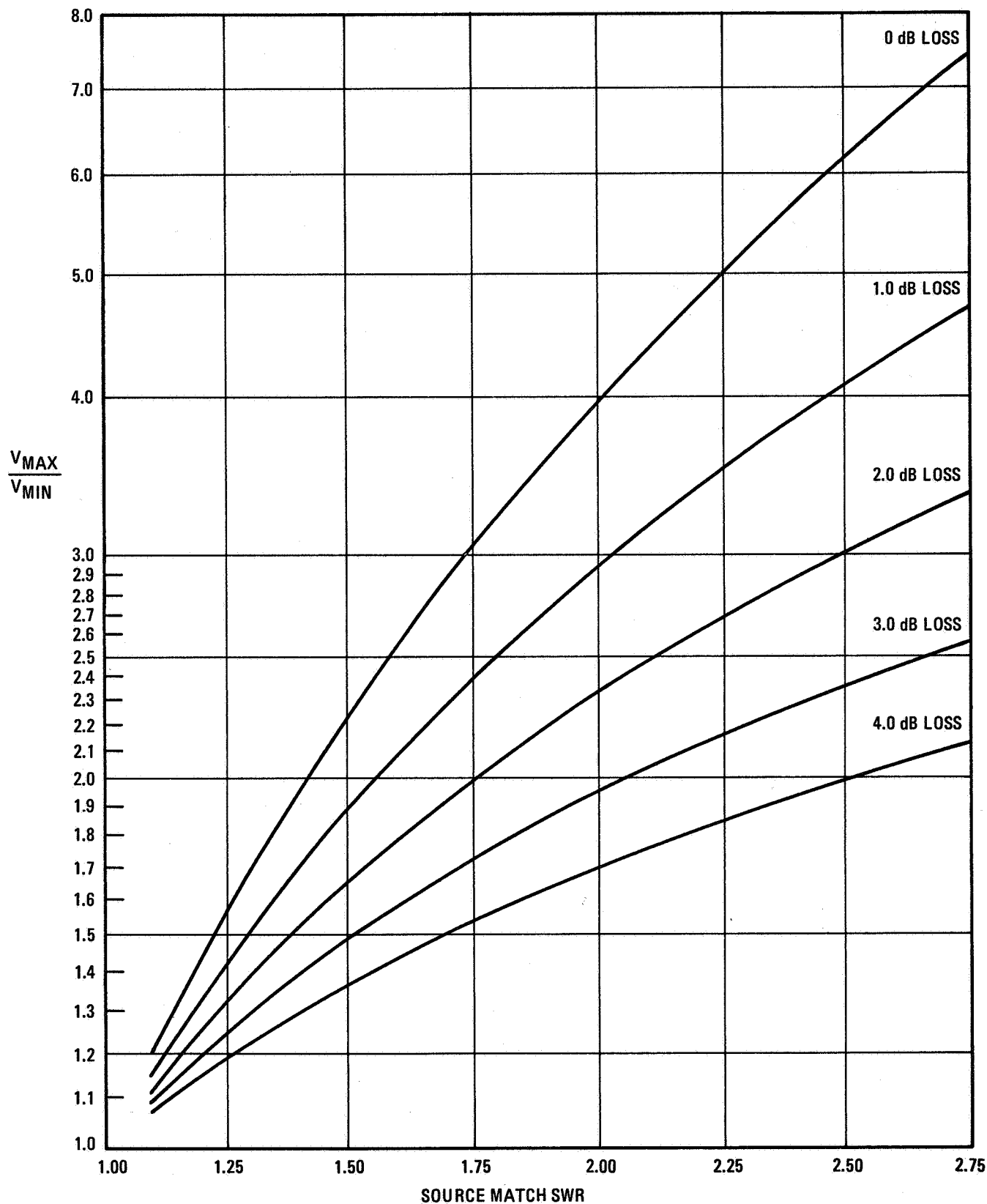

Figure 4-13. Conversion of Oscilloscope Trace to Source Match SWR

PERFORMANCE TESTS

4-19. RESIDUAL AM

SPECIFICATION:

See Performance Test Record Card in section IV of plug-in manual for Residual AM specification.

DESCRIPTION:

The RF Output signal from RF Plug-in is amplitude modulated with square wave from the 8350A. This modulated signal is used to establish a reference on the RMS voltmeter that is 9 dB below actual carrier signal. The 9 dB reduction occurs because of voltmeter response to square wave and square-law response of crystal detector. Modulation is then removed and magnitude of Residual AM component is measured with respect to established reference.

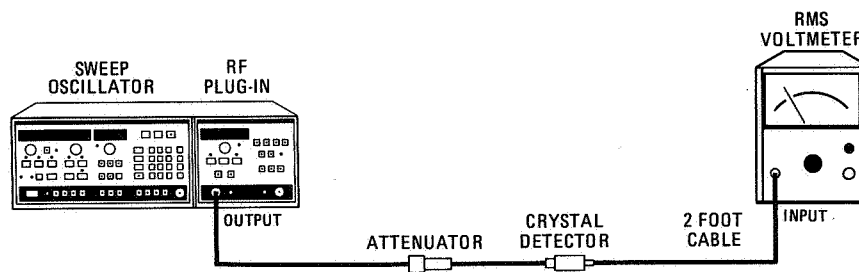

Figure 4-14. Residual AM Test Setup

EQUIPMENT:

RF Plug-in.....	HP 83500 series
RMS Voltmeter.....	HP 3400A
Crystal Detector.....	HP 423B
Attenuator.....	Refer to PROCEDURE
60 cm (24 in) cable (Limits bandwidth to approximately 100 kHz).....	HP11170B

PROCEDURE:

1. Connect equipment as shown in Figure 4-14 using a 20 dB attenuator.
2. Press **INSTR PRESET**, **CW**, engage **□ MOD** (1 kHz or 27.8 kHz), disengage **DISPL BLANK**.

NOTE

A 41 dB decrease in the RMS voltmeter indication corresponds to a 50-dB reduction in signal level. A correction factor of 9 dB is added because of the RMS voltmeter response to a square wave and the square-law response of the crystal detector.

## PERFORMANCE TESTS

**4-19. RESIDUAL AM (Cont'd)**

3. Enter frequency and power shown on test card step 3.
4. Vary attenuation using 3 dB, 6 dB, and 10 dB attenuators until reading on RMS voltmeter is  $-28 \text{ dB} \pm 3 \text{ dB}$ . Note voltmeter reading.
5. Disengage  $\square$  MOD. Change RMS voltmeter range switch to obtain an on-scale indication. Calculate the difference between this reading and the indication noted in step 4. Add 9 dB to compensate for square-law inequities, and record this number on the test record card step 5.
6. Engage  $\square$  MOD. If plug-in is a multiband unit repeat steps 4 and 5 for frequency/ies shown on test card step 6.

**4-20. EXTERNAL FREQUENCY MODULATION TEST****SPECIFICATION:**

See Performance Test Record Card in section IV of plug-in manual for External FM deviation specifications.

**DESCRIPTION:**

The RF Output is modulated with an external signal at 100 Hz, 1 MHz, 2 MHz and 10 MHz. The 100 Hz deviation is measured directly on a spectrum analyzer. The deviation at the higher frequencies is found by using a delay line discriminator to observe an increase in the modulation on an oscilloscope until distortion is observed. This frequency change is measured on a frequency counter.

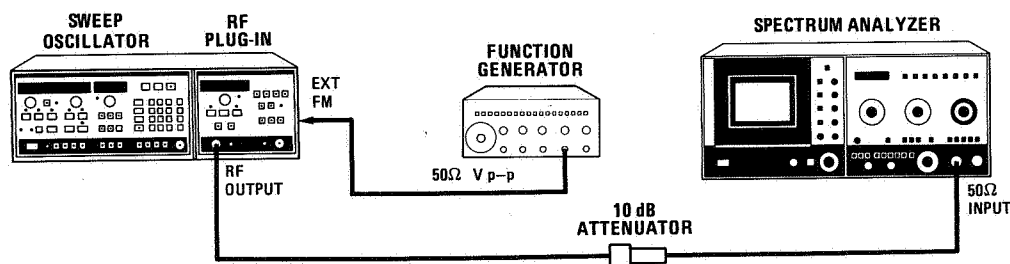

Figure 4-15. 100 Hz External Frequency Modulation Test Setup

## PERFORMANCE TESTS

## 4-20. EXTERNAL FREQUENCY MODULATION TEST (Cont'd)

## EQUIPMENT:

RF Plug-in.....	HP 83500 series
Spectrum Analyzer .....	HP 8565A
Frequency Counter .....	HP 5343A
Function Generator.....	HP 3312A
Oscilloscope .....	Any general purpose oscilloscope such as HP 1222A* or 1740A
10 dB Attenuator.....	HP 8491B, Opt. 010
Power Splitter .....	HP 11667A
Delay Line Discriminator .....	(See Figure 1-3)

\*Add a 50 $\Omega$  load and BNC Tee to each oscilloscope input.

## PROCEDURE:

## 100 Hz Modulation

1. Ensure that modulation sensitivity is set to  $-20$  MHz/volt and modulation coupling to DC. Refer to section III of the plug-in manual for information on FM switch position. Connect equipment as shown in Figure 4-15.
2. Press 8350A **INSTR PRESET**, **CW** and disengage the **DISPL BLANK** key. Disengage RF plug-in **CW FILTER** key. Center fundamental signal on spectrum analyzer CRT display. Set function generator frequency to 100 Hz sinewave and amplitude to full counterclockwise. Adjust function generator amplitude control slowly clockwise while monitoring display on spectrum analyzer. Deviation from center line should be symmetrical at first then become non-symmetrical as deviation increases.
3. Note point at which deviation becomes non-symmetrical. Record the highest symmetrical observed deviation frequency on the test card step 3.
4. Turn 8350A **LINE** switch to off. Remove RF plug-in and switch modulation coupling to cross-over (refer to plug-in manual section III). Install the RF plug-in and turn the 8350A **LINE** switch to on. Then repeat steps 2 and 3 and record the deviation on test card step 4.

## &gt;100 Hz FM Modulation



## PERFORMANCE TESTS

## 4-20. EXTERNAL FREQUENCY MODULATION TEST (Cont'd)

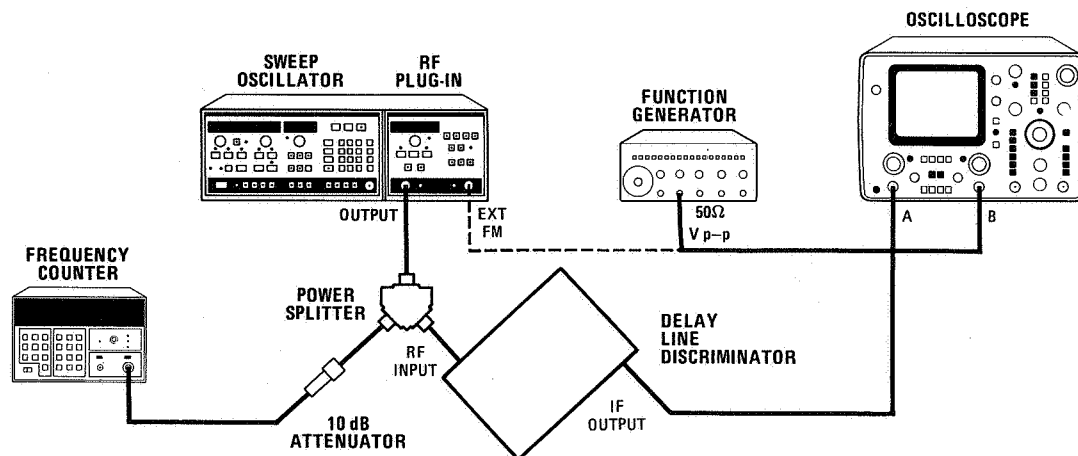

Figure 4-16. >100Hz Frequency Modulation Test Setup

5. Set function generator frequency to 1 MHz. Set both oscilloscope inputs to 50Ω.
6. Set function generator output amplitude to 0.1 volt p-p output. Connect equipment as shown in Figure 4-16 with function generator output not connected. Adjust CW and CW VERNIER for a delay line discriminator output of '0' volts as observed on oscilloscope. Note frequency counter reading on test card step 6.
7. Connect function generator output to 8350A FM INPUT (rear panel) and adjust oscilloscope for a clear display of the function generator sinewave.
8. Increase the function generator output amplitude until the deviation becomes non-symmetrical or distorted. Use oscilloscope B input to monitor function generator output. If the output is offset the test is invalid.
9. Mark peak of sinewave on oscilloscope with grease pencil. Remove function generator output from FM INPUT and adjust CW/CW VERNIER to the grease pencil mark. Calculate the difference between the present frequency counter reading and the previous reading (step 6). Record on the test card step 9.
10. Set the function generator to 2 MHz then 10 MHz repeating steps 6 through 9 for each frequency and record the results on the test card step 10.
11. Change mode of plug-in modulation coupling and repeat steps 6 through 10. Record the results on the test card step 11.

PERFORMANCE TESTS

4-21. FM FREQUENCY RESPONSE TEST

SPECIFICATION:

See Performance Test Record Card in section IV of plug-in manual for FM Response specifications.

DESCRIPTION:

FM deviation of the RF Plug-in is compared to a known voltage reference using a delay line discriminator, and the difference is measured with an oscilloscope. Since the oscilloscope is calibrated so that four major divisions are equal to 100 percent, each minor division is equal to 5 percent. A difference of +41, -29 percent is approximately equal to  $\pm 3$  dB, and a difference of +18, -16 percent is approximately equal to  $\pm 1.5$  dB.

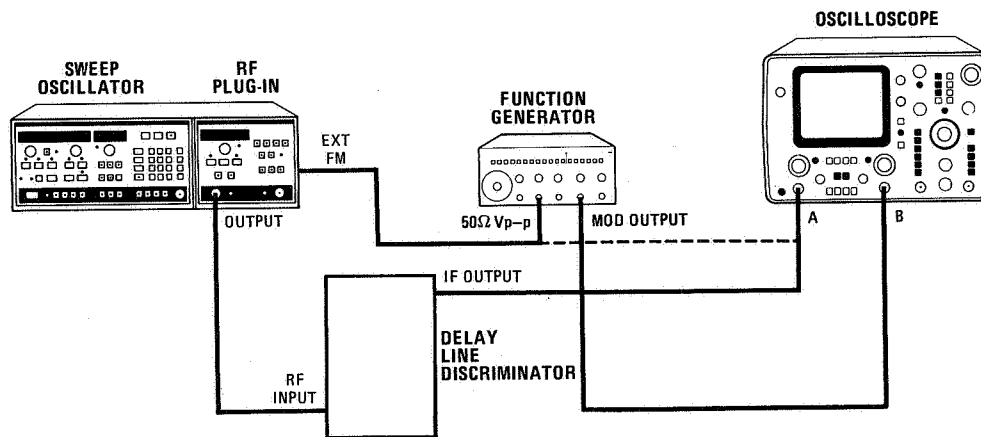

Figure 4-17. FM Frequency Response Test Setup

EQUIPMENT:

- RF Plug-in..... HP 83500 series
- Oscilloscope..... Any general purpose oscilloscope  
such as HP 1222A\* or 1740A
- Function Generator..... HP 3312A
- Delay Line Discriminator..... (See Figure 1-3)

\*Add a 50Ω load and BNC Tee to oscilloscope Channel A input.

PROCEDURE:

1. Connect equipment as shown in Figure 4-17. Press 8350A INSTR PRESET, CW and disengage DISPL BLANK, and plug-in CW FILTER.

---

**PERFORMANCE TESTS**

---

**4-21. FM FREQUENCY RESPONSE TEST (Cont'd)**

2. Set controls as follows:

Oscilloscope	
CHAN A	
VOLTS/DIV .....	0.02(CAL)
Input .....	50 $\Omega$
Mode .....	A vs. B
CHAN B volts/DIV .....	1
Function Generator:	
RANGE Hz .....	100
FREQUENCY .....	10
FUNCTION .....	~
OFFSET .....	CAL
SYM .....	CAL
MODULATION .....	SWP
SWP START .....	Fully counterclockwise
RANGE Hz VERNIER .....	Best display

3. Adjust the oscilloscope with GND reference switched in for a trace on center line then reset oscilloscope to 50 $\Omega$  input. Connect the function generator output to Channel A and adjust output for 100 mv peak-to-peak on CRT. Reconnect the equipment as shown in Figure 4-17. Check GND reference on oscilloscope. Return oscilloscope to 50 $\Omega$  input. Adjust CW and CW Vernier control to center trace on CRT.
4. Set Oscilloscope Channel A Volts/DIV to .005 (CAL). Adjust the oscilloscope CAL control for a four-division discriminator output display on the oscilloscope.
5. Vary function generator frequency from 0.1 Hz to 2 MHz. Record maximum amplitude deviations of trace on the performance test record card step 5.

---

**4-22. AM ON/OFF RATIO AND SQUARE WAVE SYMMETRY TEST**
**SPECIFICATION:**

See Performance Test Record Card in section IV of plug-in manual for AM on/off ratio and square wave symmetry specifications.

**DESCRIPTION:**

The AMON/OFF ratio is checked on the amplitude axis of a video triggered spectrum analyzer display. The symmetry is checked by calculating the on/off time ratio on the frequency axis.

---

PERFORMANCE TESTS

4-22. AM ON/OFF RATIO AND SQUARE WAVE SYMMETRY TEST (Cont'd)

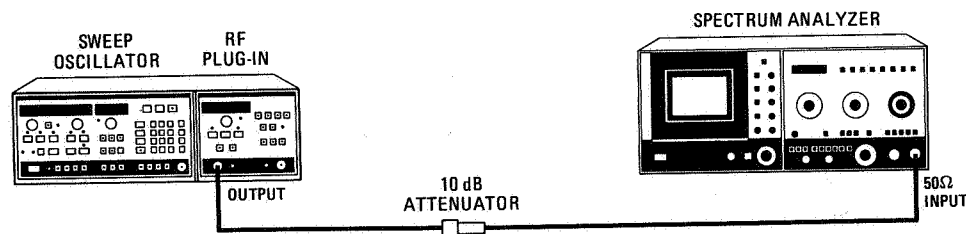

4-18. AM ON/OFF Ratio and Square Wave Symmetry Test Setup

**EQUIPMENT:**

- RF Plug-in..... HP 83500 series
- 10 dB Attenuator..... HP 8491B, Opt. 010
- Spectrum Analyzer ..... HP 8565A

**PROCEDURE:**

1. Connect equipment as shown in Figure 4-18. Press 8350A **INSTR PRESET**, **CW** and engage **MOD**. Set 8350A frequency as shown on test card step 1. Set plug-in to maximum rated output power.

2. Set controls as follows:

8565A:

Set all Normal Settings (controls marked with green)

- FREQUENCY BAND GHz ..... To cover CW set
- INPUT ATTENUATION..... 10 dB
- REFERENCE LEVEL ..... 10 dBm
- FREQUENCY SPAN MODE ..... ZERO SPAN
- SWEEP TRIGGER ..... VIDEO
- RESOLUTION BW..... 3 MHz
- AUTO STABILIZER ..... OFF
- SWEEP TIME/DIV..... .1 msec for 1 kHz  
5 μsec for 27.8 kHz

3. Adjust spectrum analyzer **TUNING** control to observe signal on CRT. Adjust **REFERENCE LEVEL** to set signal on top trace. Record AM ON/OFF ratio on test card step 3.
4. Record the symmetry of the observed signal on the test card step 4.
5. Set CW frequency as indicated on test record card step 5. Repeat steps 3 and 4 and record results on test record card steps 5.

PERFORMANCE TESTS

**4-23. STEP ATTENUATOR ACCURACY TEST (OPTION 002)**

**SPECIFICATION:**

If plug-in is Option 002 see Performance Test Record Card in section IV of plug-in manual for Attenuator Accuracy specifications.

**DESCRIPTION:**

The plug-in RF output is compared to a specially calibrated attenuator and displayed on a spectrum analyzer.

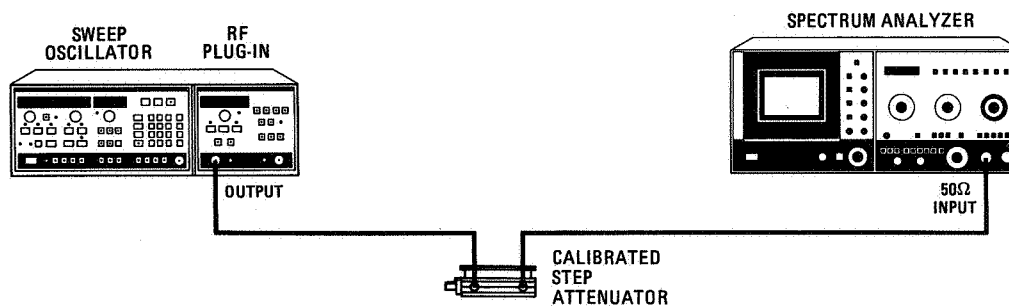

Figure 4-19. Attenuator Accuracy Test Setup

**EQUIPMENT:**

- RF Plug-in..... HP 83500 series
- Calibrated Step Attenuator ..... HP 8495A Opt. 890
- Spectrum Analyzer ..... HP 8565A

**PROCEDURE:**

**NOTE**

Frequency may be set to any value listed on Calibration Report within Plug-in frequency. Use Calibration Report data for frequency of plug-in output.

1. Connect equipment as shown in Figure 4-19. Press 8350A INSTR PRESET , CW . Enter the frequency and power level shown on the test card step 1.
2. Set controls as follows:

Step Attenuator  
ATTENUATION ..... As shown on test card step 2

PERFORMANCE TESTS

**4-23. STEP ATTENUATOR ACCURACY TEST (OPTION 002) (Cont'd)**

Spectrum Analyzer

Set all normal settings (controls marked with green)

INPUT ATTEN ..... 10 dB  
 REFERENCE LEVEL..... -50 dBm  
 RESOLUTION BANDWIDTH ..... 1 MHz  
 FREQUENCY SPAN/DIV ..... 5 MHz  
 FREQUENCY SPAN MODE..... FULL BAND  
 VIDEO FILTER..... Adjust as necessary  
 FREQUENCY BAND ..... Select to cover frequency in step 1

3. Press 8350A **POWER LEVEL**, **STEP SIZE**, 1, 0, and dBm/dB.
4. Note the actual attenuation values on the calibrated step attenuator's (Option 890) calibration report at the frequency and attenuation steps used. Calculate the Reference Attenuator Error for each step as shown below. Record this error in the test card **Atten. Error** column.

$$\text{Attenuation Error} = (\text{Cal. Ref. Atten.} - \text{Cal. Step Atten.}) - (\text{Ref. Setting} - \text{Step Setting})$$

For example, if the Reference setting is 70 dB, the calculation for the 30 dB step setting would be as follows:

Example Calibration Report values:

70 dB setting is actually 69.55 dB  
 30 dB setting is actually 30.80 dB

$$\text{Attenuation Error} = (69.55 \text{ dB} - 30.80 \text{ dB}) - (70 \text{ dB} - 30 \text{ dB}) = -1.25 \text{ dB}$$

**NOTE**

The actual attenuation stepped in this example is 38.75 dB (69.55 dB - 30.80 dB).

5. Adjust spectrum analyzer **TUNING** control to center notch on sweep oscillator output signal. Reduce spectrum analyzer **FREQUENCY SPAN/DIV** to 0.2 MHz and recenter **TUNING** control. Press **FREQUENCY SPAN MODE ZERO SPAN** key and adjust **FINE TUNING** to peak signal on spectrum analyzer display. Adjust spectrum analyzer **REFERENCE LEVEL VERNIER** for a trace at the center graticule line. Press 1 dB/DIV and recenter trace.
6. Press the 8350A  key and decrease the reference attenuation by 10 dB.
7. Record the power level variation from the center graticule (reference) on the spectrum analyzer display (be sure to designate the direction of the change: + is above and - is below the reference).
8. Algebraically add the Attenuation Error and Deviation from 0 reference and record the sum on the test record card. Repeat steps 6 and 7 for the other attenuation values.

## SECTION V ADJUSTMENTS

### 5-1. INTRODUCTION

5-2. This section provides adjustment procedures for the Model 8350A Sweep Oscillator. These procedures should not be performed as routine maintenance but should be used (1) after replacement of a part or component, or (2) when performance tests show that the specifications of Table 1-1 cannot be met. Table 5-1 lists all of the adjustments by reference designation, adjustment name, adjustment paragraph, performance test paragraph, and description. Each procedure includes a test setup illustration and one or more adjustment location illustrations.

#### NOTE

Allow the 8350A Sweep Oscillator to warm up for 30 minutes prior to making any adjustments.

### 5-3. SAFETY CONSIDERATIONS

5-4. Although this instrument has been designed in accordance with international safety standards, this manual contains information, cautions, and warnings which must be followed to ensure safe operation and to retain the instrument in safe condition. Service and adjustments should be performed only by a skilled person who is aware of the hazard involved.

#### WARNING

Adjustments in this section are performed with power supplied to the instrument while protective covers are removed. There are voltages at points in the instrument which can, if contacted, cause personal injury. Be extremely careful. Adjustments should be performed only by a skilled person who is aware of the hazard involved.

#### WARNING

Capacitors inside the instrument may still be charged, even if the instrument has been disconnected from its power supply source.

#### NOTE

Use a non-metallic adjustment tool whenever possible.

### 5-5. EQUIPMENT REQUIRED

5-6. Table 1-4 lists the equipment required for the adjustment procedures. If the test equipment recommended is not available, other equipment may be used if its performance meets the Critical Specifications listed in Table 1-4. The specific equipment required for each adjustment is referenced in each procedure.

### 5-7. FACTORY-SELECT COMPONENTS

5-8. Table 5-2 contains a list of factory-selected components that include the reference designation, the related performance test, the allowable range of values, and the basis of selection. Nominal values are given for the factory-selected components, designated by an asterisk (\*), on the schematic diagram and in the replaceable parts list. HP Part Numbers for selected values are given in Table 5-3. Check Digit information is given as an ordering convenience.

### 5-9. RELATED ADJUSTMENTS

5-10. Interactive adjustments are noted in the adjustment procedures. Table 5-4 indicates, by paragraph numbers, the adjustments that must be performed if an assembly has been repaired or replaced or if an adjustment has been made on an assembly. Table 5-5 lists the adjustment procedures included in this section.

Table 5-1. Adjustable Components

Reference Designation	Adjustment Name	Adjustment Paragraph	Description
A4R2	$\Delta F$ OFFSET	5-19	Sets low end of band frequency accuracy (OFFSET) in $\Delta F$ sweep mode.
A4R15	$\Delta F2$	5-19	Sets frequency accuracy (GAIN) in $\Delta F$ sweep mode for $\Delta F$ settings $<1/8$ and $\geq 1/64$ of RF plug-in band.
A4R18	$\Delta F3$	5-19	Sets frequency accuracy (GAIN) in $\Delta F$ sweep mode for $\Delta F$ settings $<1/64$ of RF plug-in band.
A4R22	VERNIER	5-19	Sets symmetry (GAIN) of VERNIER control at low end of VERNIER range.
A4R25	$\Delta F1$	5-19	Sets high end of band frequency accuracy (GAIN) in $\Delta F$ sweep mode for $\Delta F$ settings $\geq 1/8$ of RF plug-in band.
A4R27	CW	5-19	Sets frequency accuracy (GAIN) in CW sweep mode.
A4R28	MKR	5-20	Sets marker frequency accuracy (GAIN).
A4R44	CW OFFSET	5-19	Sets symmetry (OFFSET) of VERNIER at high end of VERNIER range.
A4R59	+10V REF	5-14	Adjusts +10V REF DAC power supply.
A5R2	10 mSEC	5-15	Sets sweep time accuracy for sweep times $<1$ second.
A5R25	1 SEC	5-15	Sets sweep time accuracy for sweep times from 1 second to 100 seconds.
A5R43	MANUAL	5-16	Sets sweep ramp accuracy in MANUAL sweep mode.
A5R51	SQUARE WAVE	5-18	Sets internal AM 27.8/1 kHz oscillator frequency accuracy.
A7R10	+20V	5-11	Adjusts +20V REG power supply
A7R21	-10V	5-11	Adjusts -10V REG power supply
A7R39	-40V	5-11	Adjusts -40V REG power supply
A7R58	AIRFLOW BAL	5-12	Adjusts airflow detection circuit temperature threshold.

Table 5-2. Factory Select Components

Reference Designator	Adjustment Paragraph	Allowable Range of Values	Basis of Selection
A5R70	5-17	not critical	Selected to set the retrace time for a 10 ms sweep to insure repetitive sweeps on LINE SWEEP TRIGGER.
A7R76	5-13	not critical	Selected to set the output voltage level of the +5VB power supply under a no load condition.



Table 5-3. HP Part Numbers of Standard Value Replacement Components

RESISTORS								
RANGE: 10 to 464K Ohms TYPE: Fixed-Film WATTAGE: .125 at 125°C TOLERANCE: ±1.0%								
Value (Ω)	HP Part Number	C D	Value (Ω)	HP Part Number	C D	Value (Ω)	HP Part Number	C D
10.0	0757-0346	2	464	0698-0082	7	21.5K	0757-0199	3
11.0	0757-0378	0	511	0757-0416	7	23.7K	0698-3158	4
12.1	0757-0379	1	562	0757-0417	8	26.1K	0698-3159	5
13.3	0698-3427	0	619	0757-0418	9	28.7K	0698-3449	6
14.7	0698-3428	1	681	0757-0419	0	31.6K	0698-3160	8
16.2	0757-0382	6	750	0757-0420	3	34.8K	0757-0123	3
17.8	0757-0294	9	825	0757-0421	4	38.3K	0698-3161	9
19.6	0698-3429	2	909	0757-0422	5	42.2K	0698-3450	9
21.5	0698-3430	5	1.0K	0757-0280	3	46.4K	0698-3162	0
23.7	0698-3431	6	1.1K	0757-0424	7	51.1K	0757-0458	7
26.1	0698-3432	7	1.21K	0757-0274	5	56.2K	0757-0459	8
28.7	0698-3433	8	1.33K	0757-0317	7	61.9K	0757-0460	1
31.6	0757-0180	2	1.47K	0757-1094	9	68.1K	0757-0461	2
34.8	0698-3434	9	1.62K	0757-0428	1	75.0K	0757-0462	3
38.3	0698-3435	0	1.78K	0757-0278	9	82.5K	0757-0463	4
42.2	0757-0316	6	1.96K	0698-0083	8	90.9K	0757-0464	5
46.4	0698-4037	0	2.15K	0698-0084	9	100K	0757-0465	6
51.1	0757-0394	0	2.37K	0698-3150	6	110K	0757-0466	7
56.2	0757-0395	1	2.61K	0698-0085	0	121K	0757-0467	8
61.9	0757-0276	7	2.87K	0698-3151	7	133K	0698-3451	0
68.1	0757-0397	3	3.16K	0757-0279	0	147K	0698-3452	1
75.0	0757-0398	4	3.48K	0698-3152	8	162K	0757-0470	3
82.5	0757-0399	5	3.83K	0698-3153	9	178K	0698-3243	8
90.0	0757-0400	9	4.22K	0698-3154	0	196K	0698-3453	2
100	0757-0401	0	4.64K	0698-3155	1	215K	0698-3454	3
110	0757-0402	1	5.11K	0757-0438	3	237K	0698-3266	5
121	0757-0403	2	5.62K	0757-0200	7	261K	0698-3455	4
133	0698-3437	2	6.19K	0757-0290	5	287K	0698-3456	5
147	0698-3438	3	6.81K	0757-0439	4	316K	0698-3457	6
162	0757-0405	4	7.50K	0757-0440	7	348K	0698-3458	7
178	0698-3439	4	8.25K	0757-0441	8	383K	0698-3459	8
196	0698-3440	7	9.09K	0757-0288	1	422K	0698-3460	1
215	0698-3441	8	10.0K	0757-0442	9	464K	0698-3260	9
237	0698-3442	9	11.0K	0757-0443	0			
261	0698-3132	4	12.1K	0757-0444	1			
287	0698-3443	0	13.3K	0757-0289	2			
316	0698-3444	1	14.7K	0698-3156	2			
348	0698-3445	2	16.2K	0757-0447	4			
383	0698-3446	3	17.8K	0698-3136	8			
422	0698-3447	4	19.6K	0698-3157	3			

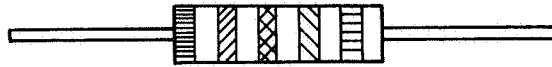

Table 5-4. Related Adjustments

Assembly Changed or Repaired		Related Assemblies	Perform the Following Paragraph Number
A1	Front Panel	A1	None
A2	Front Panel Interface	A2	None
A3	Microprocessor	A3	None
A3A1	PROM	A3A1	None
A4	Scaling and Marker	A4, A5	5-14, 5-16, 5-19, 5-20
A5	Sweep Generator	A6, A7	5-14, 5-15, 5-16, 5-17, 5-18
A6	Rectifier	A6, A7	5-11, 5-12, 5-13
A7	Regulator	A7	5-11, 5-12, 5-13
A8	HP-IB Interface	A8	None

Table 5-5. Adjustments

Paragraph	Adjustment
5-11	+20V, -40V, and -10V POWER SUPPLY ADJUSTMENTS
5-12	AIRFLOW DETECTOR ADJUSTMENT
5-13	+5VB POWER SUPPLY ADJUSTMENT
5-14	+10V REF DAC POWER SUPPLY ADJUSTMENT
5-15	SWEEP TIME ADJUSTMENTS
5-16	MANUAL SWEEP ADJUSTMENT
5-17	SWEEP RETRACE TIME ADJUSTMENTS
5-18	28.8/1 kHz OSCILLATOR ADJUSTMENT
5-19	FREQUENCY CONTROL ADJUSTMENTS
5-20	MARKER DAC ADJUSTMENT

## ADJUSTMENTS

### 5-11. +20V, -40V, AND +10V POWER SUPPLY ADJUSTMENTS

#### REFERENCE:

A7 Regulator

#### DESCRIPTION:

The -20V, +40V, and +10V power supplies are adjusted under load for the proper voltage levels with an HP 83500 Series RF plug-in or HP 11869A RF Plug-in Adapter installed.

ADJUSTMENTS

5-11. +20V, -40V, and -10V POWER SUPPLY ADJUSTMENTS (Cont'd)

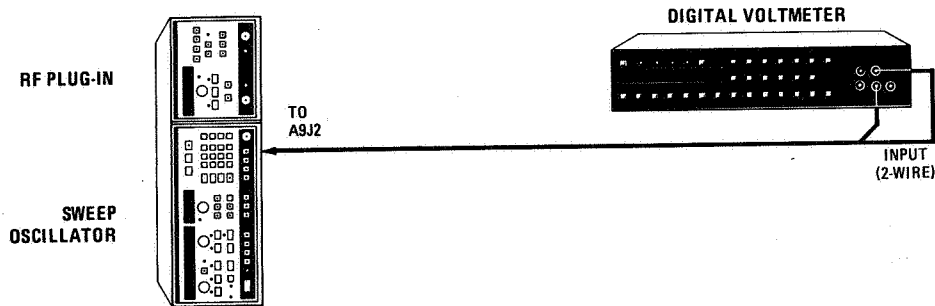

Figure 5-1. +20V, -40V, and -10V Power Supply Adjustments Setup.

EQUIPMENT:

- Sweep Oscillator..... HP 8350A
- RF Plug-in..... any HP 83500 Series RF Plug-in or  
HP 11869A RF Plug-in Adapter
- Digital Voltmeter (DVM) ..... HP 3455A

PROCEDURE:

1. Install an HP 83500 Series RF plug-in (or the HP 11869A RF Plug-in Adapter) in the HP 8350A mainframe.
2. Set LINE switch to ON and allow the sweep oscillator to warm up for 30 minutes.
3. Position the sweep oscillator on its side as shown in Figure 5-1 and remove the top and bottom covers.
4. Connect the DVM to the bottom of the A9 Motherboard connector A9J2 pin 7 (+20V RETURN SENSE) and A9J2 pin 6 (+20V SENSE). A7DS2 (green LED) should be lit. Refer to Figure 5-2 for A7 Regulator component locations.
5. Adjust A7R10 +20V ADJ for a DVM reading of  $20.000 \pm 0.001$  Vdc. Refer to Figure 5-2 for adjustment location.
6. Connect the DVM to the bottom of the A9 Motherboard connector A9J2 pin 16 (-40V RETURN SENSE) and A9J2 pin 15 (-40V SENSE). A7DS4 should be lit. Refer to Figure 5-2 for A7 Regulator component locations.
7. Adjust A7R39 -40V ADJ for a DVM reading of  $-40.000 \pm 0.002$  Vdc. Refer to Figure 5-2 for adjustment location.
8. Connect the DVM to the bottom of the A9 Motherboard connector A9J2 pin 12 (-10V RETURN SENSE) and A9J2 pin 11 (-10V SENSE). A7DS3 should be lit. Refer to Figure 5-2 for A7 Regulator component locations.
9. Adjust A7R21 -10V ADJ for a DVM reading of  $-10.000 \pm 0.001$  Vdc. Refer to Figure 5-2 for adjustment location.

ADJUSTMENTS

5-11. +20V, -40V, and -10V POWER SUPPLY ADJUSTMENTS (Cont'd)

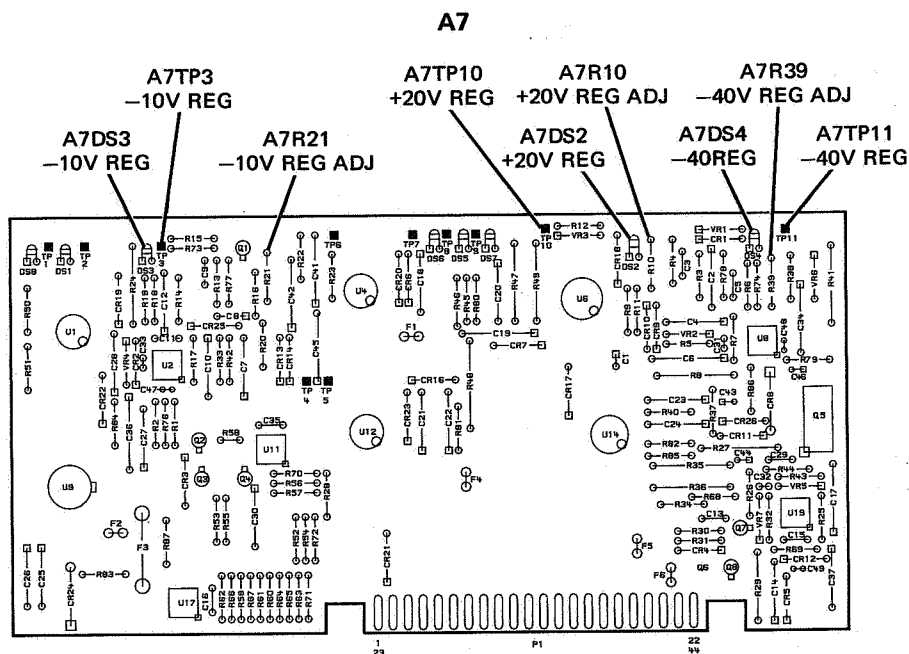
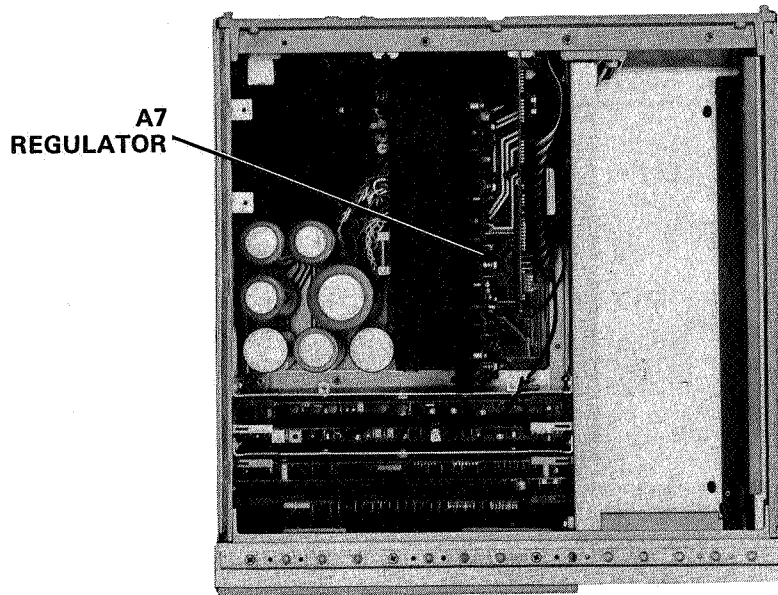

Figure 5-2. Location of +20V, -40V, and -10V Power Supply Adjustments.

---

**ADJUSTMENTS**

---

**5-12. AIRFLOW DETECTOR ADJUSTMENT****REFERENCE:**

A7 Regulator

**DESCRIPTION:**

The Airflow Detection circuit senses the internal air flow generated by fan B1 and flags the A3 Microprocessor if the airflow is restricted. The instrument is allowed to warm up to operating temperature and A7R53 is jumpered by a short to remove the hysteresis from comparator A7U11. A7R58 is then adjusted until the inputs are balanced which will then cause A7U11 output LPST (LOW POWER SUPPLY TEMPERATURE) to oscillate. LPST is monitored by the A3 Microprocessor and the state of the Airflow Detection circuit is sent to the Status Buffer at hexadecimal location 1000H. A Hexadecimal Data Read command (M3) is entered which then displays the current Status Buffer state on the FREQUENCY/TIME LEDs. When the display LEDs oscillate between 00H and 02H, indicating LPST is oscillating, A7R58 is adjusted correctly.

**PROCEDURE:**

1. Remove the RF plug-in from the sweep oscillator mainframe.
2. Set the LINE switch to ON and allow the sweep oscillator to warm up for 30 minutes.
3. Position the sweep oscillator upright and remove the top cover.
4. Short A7TP4 and A7TP5 together. This removes the hysteresis from comparator A7U11. Refer to Figure 5-3 for the location of A7TP4 and A7TP5.
5. Replace the top cover and allow the instrument to operate with top cover in place for 5 minutes.
6. Press **INSTRPRESET SHIFT 0 0 M1 1 0 0 0 M3**. This enables the hexadecimal data in the Status Buffer (at address location 1000H) to be displayed on the front panel FREQUENCY/TIME LEDs. The LED display should now read 1000 00 or 1000 02.
7. Adjust A7R58 AIRFLOW BAL until the LED display oscillates between 1000 00 and 1000 02. Refer to Figure 5-3 for A7R58 adjustment location.

**NOTE**

**A7R58 AIRFLOW BAL adjust pot is accessible through the hole in the left support of the RF plug-in opening. This adjustment MUST be made with the 8350A at normal operating temperature and all covers in place.**

8. Wait 1 minute after adjustment to insure that the display still oscillates. If it does not, and has settled at 1000 00 or 1000 02, repeat steps 6 and 7.
  9. Remove jumper from A7TP4 and A7TP5.
  10. Verify that the display indicates 1000 00.
-

ADJUSTMENTS

5-12. AIRFLOW DETECTOR ADJUSTMENT (Cont'd)

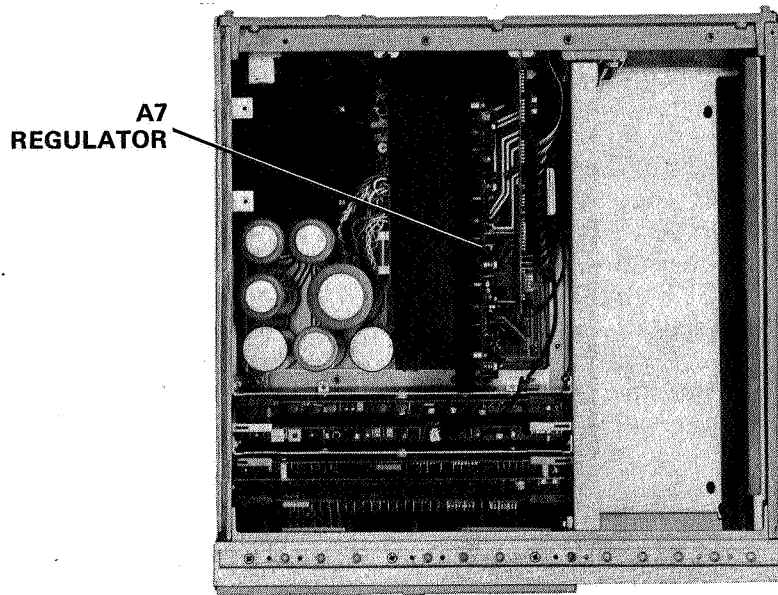

A7

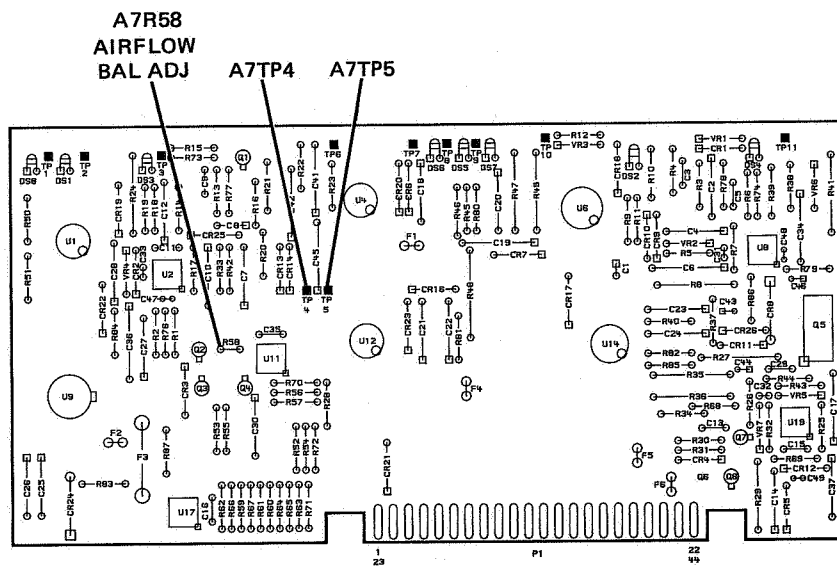

Figure 5-3. Location of AIRFLOW BALance Adjustment.

ADJUSTMENTS

5-13. +5VB POWER SUPPLY ADJUSTMENT

REFERENCE:

A7 Regulator Assembly

DESCRIPTION:

A7R76\* is selected to set the output of A7U10 (+5VB REG) to  $5.33 \pm 0.03$  Vdc in a no load condition (without an RF plug-in installed).

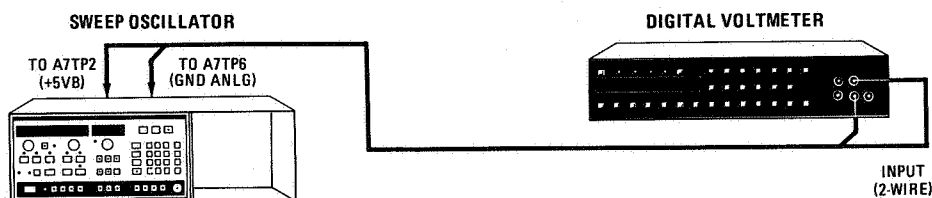

Figure 5-4. +5VB Power Supply Adjustment Setup.

EQUIPMENT:

Sweep Oscillator.....	HP 8350A
Digital Voltmeter (DVM).....	HP 3455A

PROCEDURE:

1. Remove the RF plug-in from the sweep oscillator mainframe.
2. Set the LINE switch to ON and allow the sweep oscillator to warm up for 30 minutes.
3. Position the sweep oscillator upright as shown in Figure 5-4 and remove the top cover.
4. Connect a shorting jumper from the anode of A7CR22 (+5VB GND REF) to A7TP6 (GND ANLG).
5. Connect the DVM to A7TP2 (+5VB REG) and A7TP6 (GND ANLG). A7DS1 (green LED) should be lit.
6. The DVM should indicate  $5.33 \pm 0.03$  Vdc. If it does not, A7R76\* must be changed as necessary to achieve the proper level. Refer to Table 5-2 for the range of values allowable for A7R76\*. Refer to Figure 5-5 for A7R76\* component location.

NOTE

Decreasing A7R76\* to the next lower recommended value shown in Table 5-3 will decrease the level of the +5VB power supply. Inversely, increasing the value of A7R76\* to the next higher recommended value will increase the level of the +5VB power supply.

ADJUSTMENTS

5-13. +5VB POWER SUPPLY ADJUSTMENT (Cont'd)

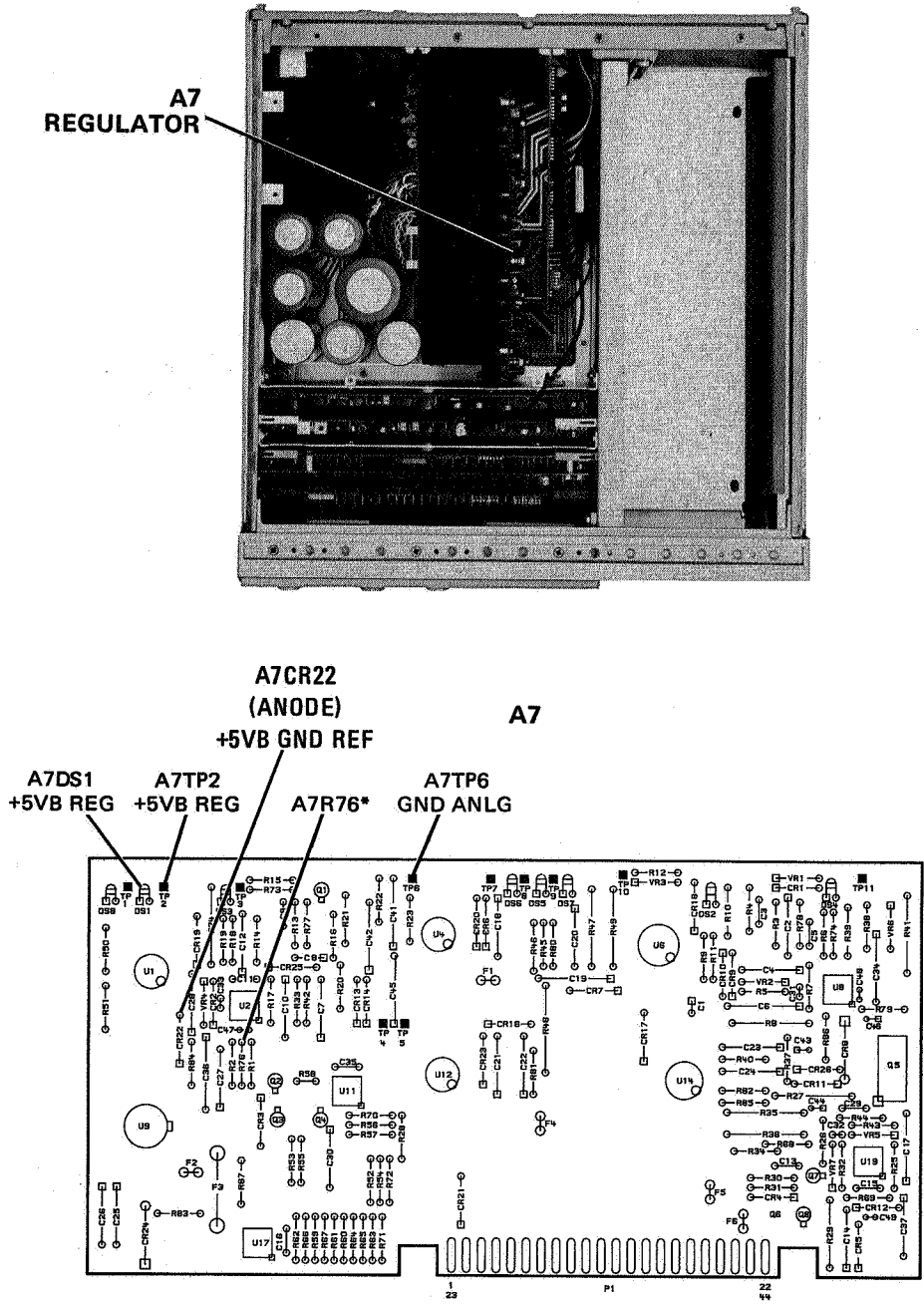

Figure 5-5. Location of +5VB Power Supply Adjustment.



ADJUSTMENTS

**5-14. +10V REF DAC POWER SUPPLY ADJUSTMENT**

REFERENCE:

A4 Scaling and Marker Assembly

DESCRIPTION:

A4R59 +10V REF ADJ is adjusted for the proper voltage level to provide an accurate reference voltage for all Digital-to-Analog Converters (DACs) in the 8350A mainframe.

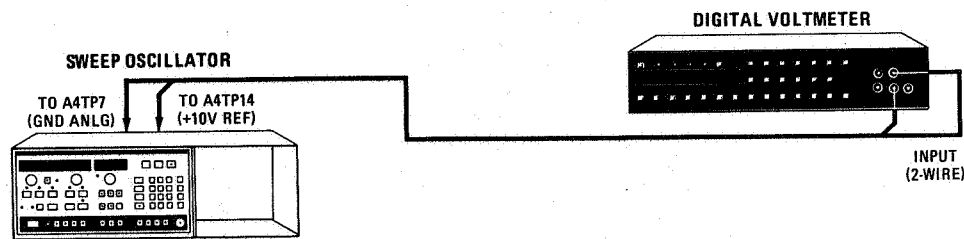

Figure 5-6. +10V REF DAC Power Supply Adjustment Setup.

EQUIPMENT:

Sweep Oscillator.....	HP 8350A
Digital Voltmeter (DVM).....	HP 3455A

PROCEDURE:

1. Remove the RF plug-in from the sweep oscillator mainframe.
2. Set the LINE switch to ON and allow the sweep oscillator to warm up for 30 minutes.
3. Position the sweep oscillator upright as shown in Figure 5-6 and remove the top cover and the A4/A5 shield cover.
4. Connect the DVM to A4TP14 (+10V REF) and A4TP7 (GND ANLG) as shown in Figure 5-6.
5. Adjust A4R59 +10V REF ADJ for a DVM reading of  $10.0000 \pm 0.0001$  Vdc. Refer to Figure 5-7 for location of adjustment.

ADJUSTMENTS

5-14. +10V REF DAC POWER SUPPLY ADJUSTMENT (Cont'd)

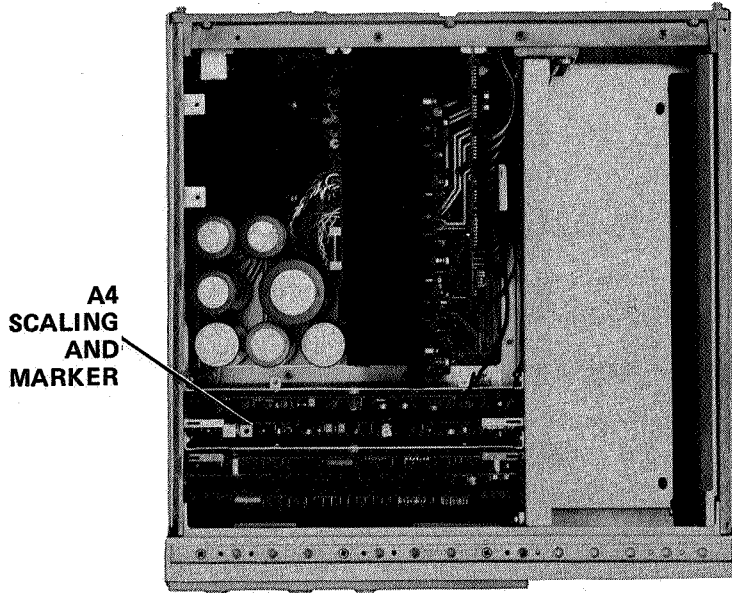

A4

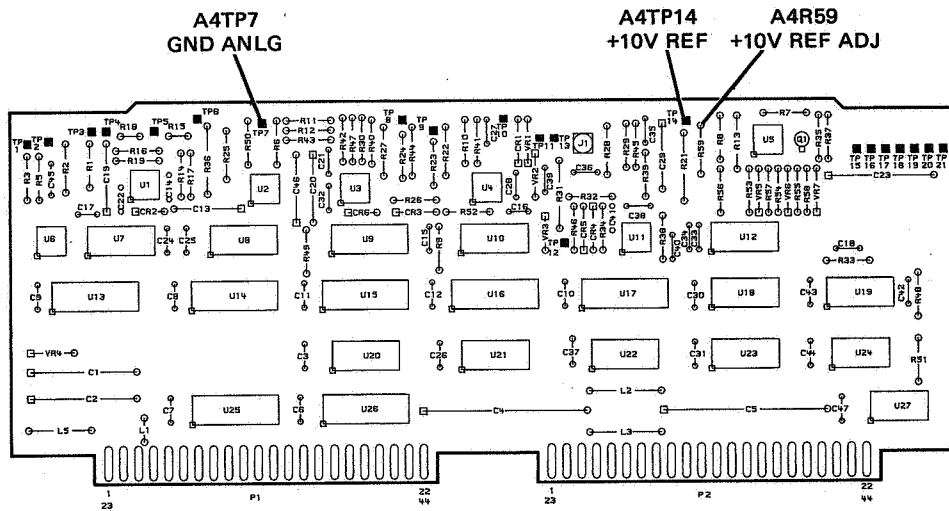

Figure 5-7. Location of +10V REF DAC Power Supply Adjustment.

ADJUSTMENTS

5-15. SWEEP TIME ADJUSTMENTS

REFERENCE:

A5 Sweep Generator

DESCRIPTION:

Programmable current source A5U2 is a 10-bit Digital-to-Analog Converter (DAC) whose output current determines the sweep time (slope) of the sweep ramp. Input reference current is supplied by the +10V REF power supply through A5R4 and 10 mSEC ADJ pot A5R2 for sweep times < 1 second, and additionally, through A5R28 and 1 SEC ADJ pot A5R25 for sweep times from 1 second to 100 seconds. 8350A rear panel POS Z BLANK BNC output goes low during the forward sweep time and is monitored by a time interval counter (returns high during sweep retrace). A5R2 is adjusted during a 10 ms sweep and A5R25 is adjusted during a 1 second sweep to give the proper forward sweep times for a fast and slow sweep.

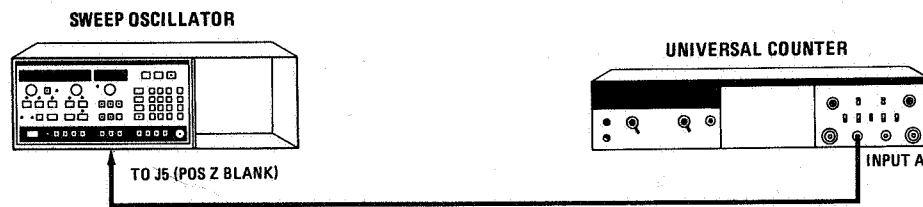

Figure 5-8. Sweep Time Adjustments Setup.

EQUIPMENT:

Sweep Oscillator.....	HP 8350A
Universal Counter.....	HP 5328A

PROCEDURE:

1. Remove the RF plug-in from the sweep oscillator mainframe.
2. Set the 8350A LINE switch to ON and allow the sweep oscillator to warm up for 30 minutes.

NOTE

The validity of this adjustment procedure is based in part on the accuracy of the +10V REF DAC power supply. Proper adjustment of the +10V REF DAC power supply is necessary before proceeding with this adjustment procedure.

## ADJUSTMENTS

## 5-15. SWEEP TIME ADJUSTMENTS (Cont'd)

3. Connect the POS Z BLANK BNC output connector on the rear panel of the 8350A to the INPUT A connector on the 5328A Universal Counter and set the 5328A controls as follows:

FUNCTION.....	TI A→B
SAMPLE RATE.....	CCW
OSC (rear panel).....	INT
ARM ON/OFF (rear panel).....	OFF
STORAGE ON/OFF (rear panel).....	ON
POWER.....	ON
Input Amplifier Control Switch.....	COM A
Channel A SLOPE.....	-
Channel A Coupling.....	DC
Channel A ATTEN.....	X10
Channel A Trigger LEVEL A.....	CW
Channel B SLOPE.....	+
Channel B Coupling.....	DC
Channel B ATTEN.....	X10
Channel B Trigger LEVEL B.....	CW

4. Position the sweep oscillator upright as shown in Figure 5-8 and remove the top cover.
5. Press **INSTR PRESET SWEEP TIME 1 0 ms**.
6. Set the 5328A FREQUENCY RESOLUTION, N control to 10 KHz  $10^2$ . From the CW position, adjust Channel A and B trigger LEVELS CCW until just past the point where both triggering LEDs blink.

## NOTE

The setting of the 5328A triggering controls is critical for an accurate time interval measurement.

7. Adjust A5R2 10 mSEC ADJ for a counter reading of  $10.000 \pm 0.020$  ms. Refer to Figure 5-9 for location of adjustment.
8. Press **INSTR PRESET SWEEP TIME 1 s**.
9. Adjust A5R25 1 SEC ADJ for a counter reading of  $1000 \pm 5$  ms. Refer to Figure 5-9 for location of adjustment.

ADJUSTMENTS

5-15. SWEEP TIME ADJUSTMENTS (Cont'd)

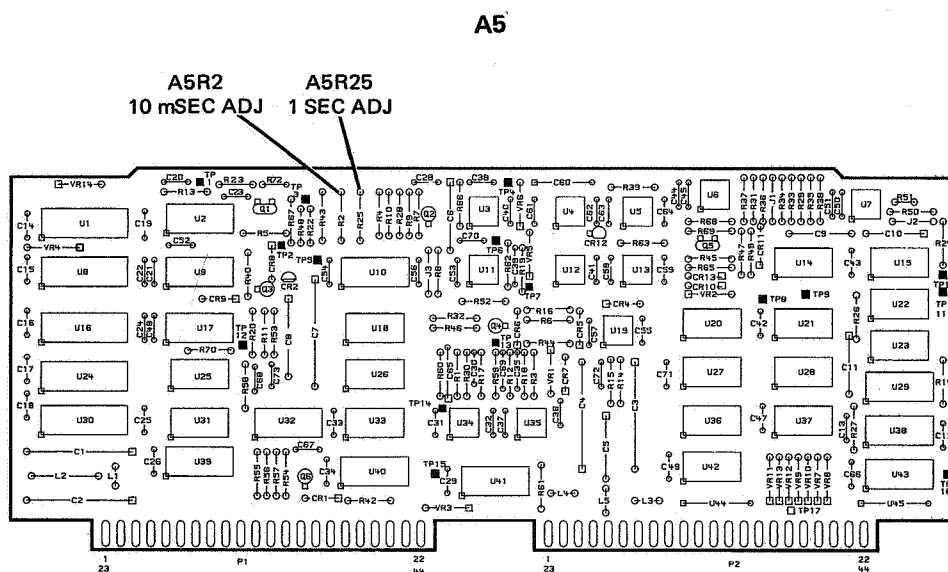
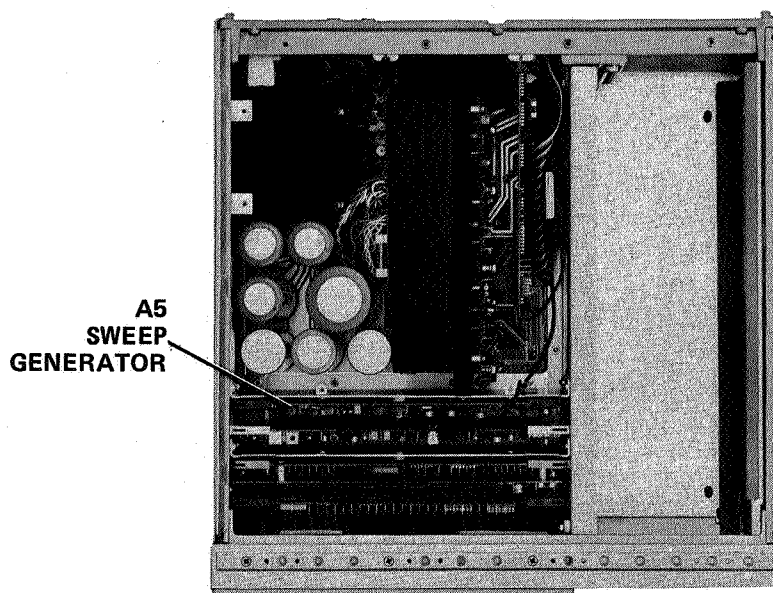

Figure 5-9. Location of Sweep Time Adjustments.

## ADJUSTMENTS

## 5-16. MANUAL SWEEP ADJUSTMENT

## REFERENCE:

A4 Scaling and Marker  
A5 Sweep Generator

## DESCRIPTION:

A5R43 MANUAL sweep adjust sets the gain of sweep ramp generator output amplifier A5U3 (when operating in a linear mode during MANUAL SWEEP). The adjustment is made with the A5 Sweep Generator sweep ramp DAC A5U2 at the high end of its range so that the upper limit of the manual sweep voltage is the same as the +10V clamped level which limits normal sweeps. The output is monitored at A4TP11 (VTUNE) which is the point at which the reference sweep voltage is sent to the RF plug-in.

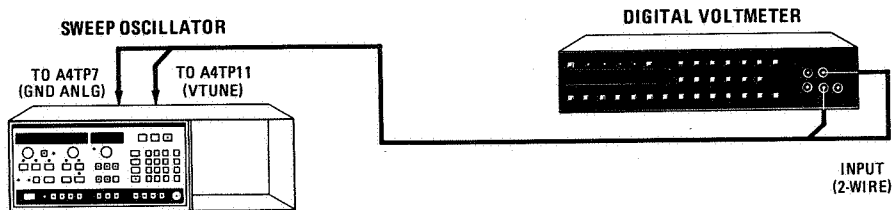

Figure 5-10. Manual Sweep Adjustment Setup.

## EQUIPMENT:

Sweep Oscillator.....	HP 8350A
Digital Voltmeter (DVM).....	HP 3455A

## PROCEDURE:

1. Remove the RF plug-in from the sweep oscillator mainframe.
2. Set the LINE switch to ON and allow the sweep oscillator to warm up for 30 minutes.
3. Position the sweep oscillator upright as shown in Figure 5-10 and remove the top cover.

## NOTE

The validity of this adjustment procedure is based in part on the accuracy of the sweep time adjustments. Proper adjustment of the forward sweep times is necessary before proceeding with this adjustment procedure.

4. Connect the DVM to A4TP11 (VTUNE) and A4TP7 (GND ANLG).
5. Press INSTR PRESET.
6. Press SHIFT 0 0 M1 2 0 1 6 M2 GHz 9. The FREQUENCY/TIME display should indicate C9. This sets the control line outputs from A5U8 to the A5 Sweep Generator circuits for a manual sweep condition.

ADJUSTMENTS

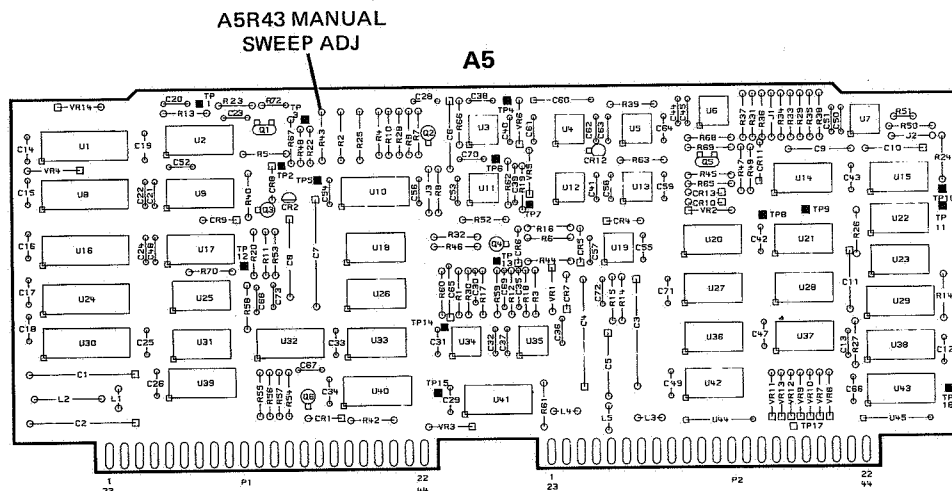
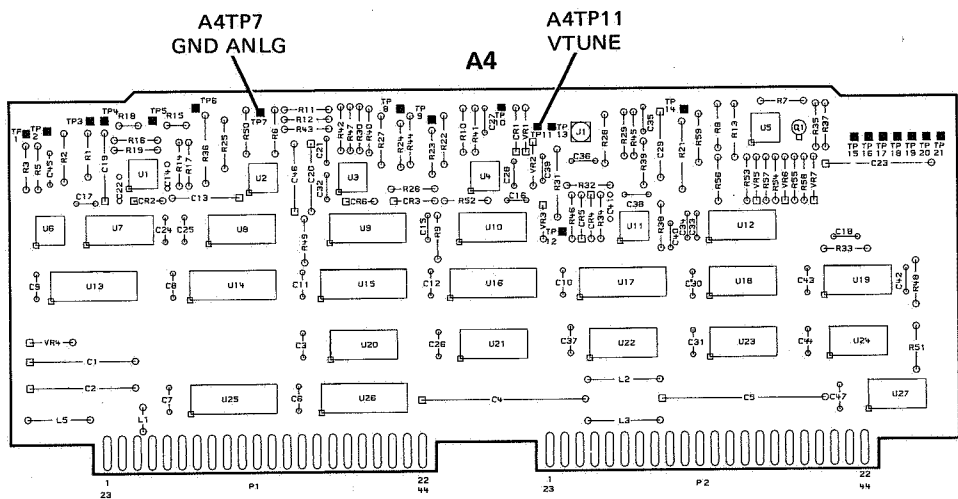
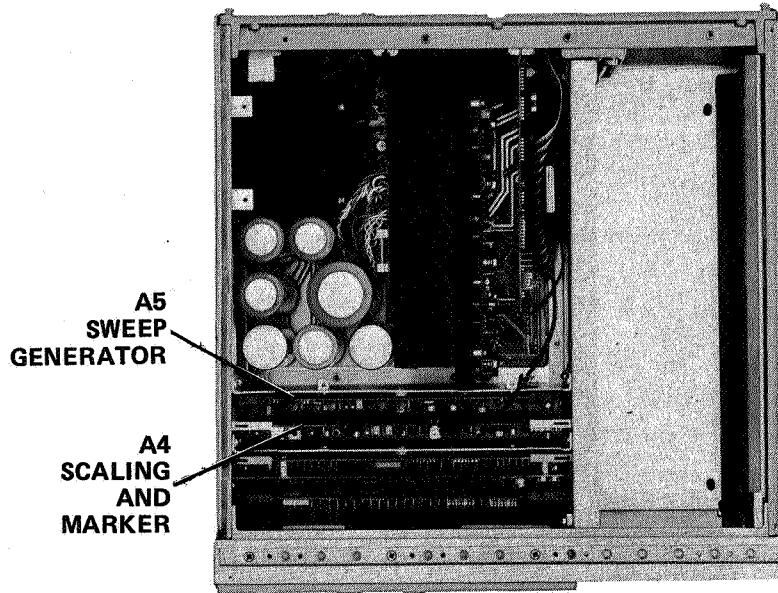

Figure 5-11. Location of Manual Sweep Adjustment.

## ADJUSTMENTS

## 5-16. MANUAL SWEEP ADJUSTMENT (Cont'd)

7. Press **M1 2 0 1 7 M2 BK SP dBm**. The FREQUENCY/TIME display should indicate FE. This sets the sweep ramp generator DAC A5U2 to 4 bits below its maximum level.
8. Adjust A5R43 MANUAL adjust until the voltage clamps at the upper limit. The adjustment is correctly set at the point just when the voltage clamps at the maximum level (typically about +10 Vdc). Refer to Figure 5-11 for location of manual sweep adjustment.

## 5-17. SWEEP RETRACE TIME ADJUSTMENTS

## REFERENCE:

A5 Sweep Generator

## DESCRIPTION:

The integrating capacitors, which are used to generate the sweep ramp on the A5 Sweep Generator, discharge through A5R70\* and A5R20 during sweep retrace. By monitoring forward sweep time plus retrace time at the rear panel POS Z BLANK BNC output (high=sweep retrace, low=forward sweep) with a time interval counter, A5R70\* is selected during a 10 ms sweep to give a total sweep plus retrace time of  $15.85 \pm 0.20$  ms. This insures that the sweep oscillator will trigger on the line frequency repetitively.

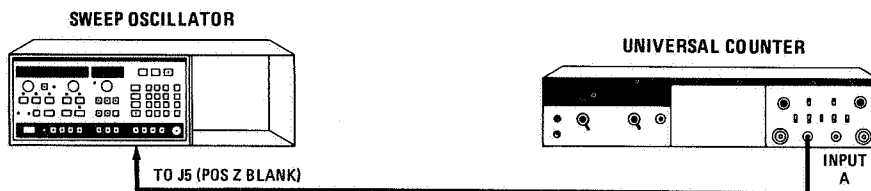

Figure 5-12. Sweep Retrace Time Adjustments Setup.

## EQUIPMENT:

Sweep Oscillator .....	HP 8350A
Universal Counter .....	HP 5328A

## PROCEDURE:

1. Remove the RF plug-in from the sweep oscillator mainframe.
2. Set the 8350A LINE switch to ON and allow the sweep oscillator to warm up for 30 minutes.

## NOTE

The validity of this adjustment procedure is based in part on the accuracy of the sweep time adjustments. Proper adjustment of the forward sweep times is necessary before proceeding with this adjustment procedure.



ADJUSTMENTS

5-17. SWEEP RETRACE TIME ADJUSTMENTS (Cont'd)

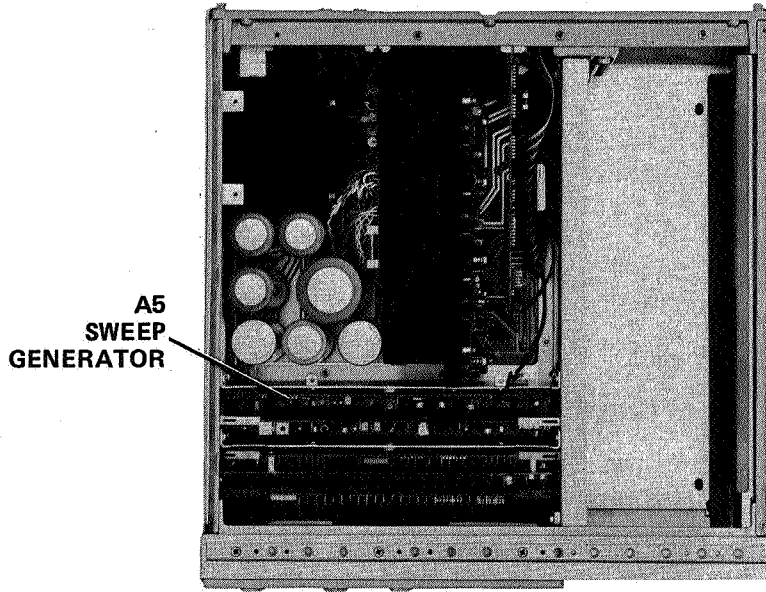

A5

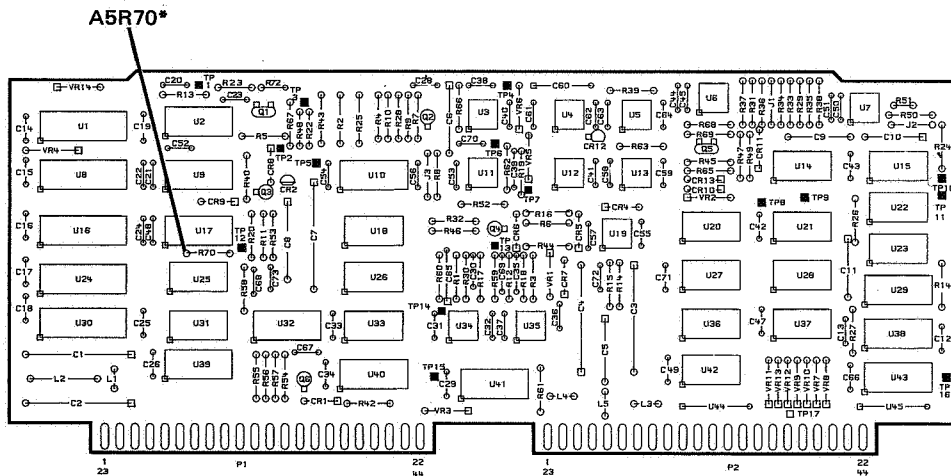

Figure 5-13. Location of Sweep Retrace Time Adjustments.

## ADJUSTMENTS

**5-17. SWEEP RETRACE TIME ADJUSTMENTS (Cont'd)**

3. Connect the POS Z BLANK BNC output connector on the rear panel of the 8350A to the INPUT A connector on the 5328A Universal Counter and set the 5328A controls as follows:

FUNCTION .....	PER A
SAMPLE RATE .....	CCW
OSC (rear panel) .....	INT
ARM ON/OFF (rear panel) .....	OFF
STORAGE ON/OFF (rear panel) .....	ON
POWER .....	ON
Input Amplifier Control Switch .....	SEP
Channel A SLOPE .....	-
Channel A Coupling .....	DC
Channel A ATTEN .....	X10
Channel A Trigger LEVEL A .....	CW

4. Position the sweep oscillator upright as shown in Figure 5-12.
5. Press **INSTR PRESET SWEEP TRIGGER INT SWEEP TIME 1 0 ms.**
6. Set the 5328A FREQUENCY RESOLUTION, N control to 10 KHz 10<sup>2</sup>. Adjust Channel A trigger LEVEL until the Channel A triggering LED blinks.
7. A5R70\* is selected to give a counter reading of 15.85 ± 0.20 ms. Refer to Table 5-2 for the range of values allowable for A5R70\*. Refer to Figure 5-13 for A5R70\* component location.

**NOTE**

Decreasing A5R70\* to the next lower recommended value shown in Table 5-3 will decrease the sweep retrace time by approximately 0.15 ms. Inversely, increasing A5R70\* to the next higher recommended value will increase the sweep retrace time by approximately 0.15 ms.

ADJUSTMENTS

**5-18. 27.8/1 kHz OSCILLATOR ADJUSTMENT**

REFERENCE:

A5 Sweep Generator Assembly

DESCRIPTION:

The internal AM 27.8/1 kHz oscillator frequency is adjusted for optimum center frequency at either 27.8 kHz or 1 kHz. A jumper on the A5 Sweep Generator Assembly selects the oscillator frequency which will then be used to modulate the RF Output frequency when SQUARE WAVE MODulation is selected by the front panel  $\square$  key.



Figure 5-14. 27.8/1 kHz Oscillator Adjustment Setup.

EQUIPMENT:

Sweep Oscillator.....	HP 8350A
Universal Counter.....	HP 5328A
1:1 Probe.....	HP 10008B

PROCEDURE:

1. Remove the RF plug-in from the sweep oscillator mainframe.
2. Position the sweep oscillator upright as shown in Figure 5-14 and remove the top cover and the A4/A5 shield cover.
3. Set the 5328A controls as follows:

FUNCTION.....	FREQ A
SAMPLE RATE.....	CCW
OSC (rear panel).....	INT
ARM ON/OFF (rear panel).....	OFF
STORAGE ON/OFF.....	ON
POWER.....	ON
Input Amplifier Control Switch.....	SEP
Channel A SLOPE.....	+
Channel A Coupling.....	AC
Channel A ATTEN.....	X10
Channel A Trigger LEVEL A.....	CW

## ADJUSTMENTS

**5-18. 27.8/1 kHz OSCILLATOR ADJUSTMENT (Cont'd)****NOTE**

When **SQUARE WAVE MODULATION** is selected, the internal AM 27.8/1 kHz oscillator frequency will be determined by the position of the A5J2 frequency select jumper. If the oscillator has been initially calibrated for one frequency and the jumper is moved to the alternate frequency position, the oscillator must be recalibrated for the new frequency setting. Calibration for each frequency is thus independent for each jumper setting. Steps 4 through 8 adjust the oscillator for 1 kHz modulation. Steps 9 through 13 adjust the oscillator for 27.8 kHz modulation.

**1kHz Oscillator Adjustment**

4. Set the 8350A LINE switch to OFF, remove the A5 Sweep Generator assembly and set the frequency select jumper A5J2 to the 1kHz position. Refer to Figure 5-15 for A5J2 jumper location. Replace the A5 Sweep Generator assembly in the 8350A mainframe.
5. Connect the equipment as shown in Figure 5-15.
6. Set the 8350A LINE switch to ON and press **INSTR PRESET** **FL MOD**.
7. Set the 5328A FREQUENCY RESOLUTION,N control to 1 Hz  $10^6$ . Adjust Channel A Trigger LEVEL until the Channel A triggering LED blinks.
8. Adjust A5R51 SQUARE WAVE MODULATION FREQUENCY adjust for a counter reading of  $1000 \pm 10$  Hz.

**27.8 kHz Oscillator Adjustment**

9. Set the 8350A LINE switch to OFF, remove the A5 Sweep Generator assembly and set the frequency select jumper A5J2 to the 27.8 kHz position. Refer to Figure 5-15 for A5J2 jumper location. Replace the A5 Sweep Generator in the 8350A mainframe.
10. Connect the equipment as shown in Figure 5-14.
11. Set the 8350A LINE switch to ON and press **INSTR PRESET** **FL MOD**.
12. Adjust the 5328A Channel A Trigger LEVEL until the Channel A triggering LED blinks.
13. Adjust A5R51 SQUARE WAVE MODULATION FREQUENCY adjust for a counter reading of  $27800 \pm 100$  Hz.

ADJUSTMENTS

5-18. 27.8/1 kHz OSCILLATOR ADJUSTMENT (Cont'd)

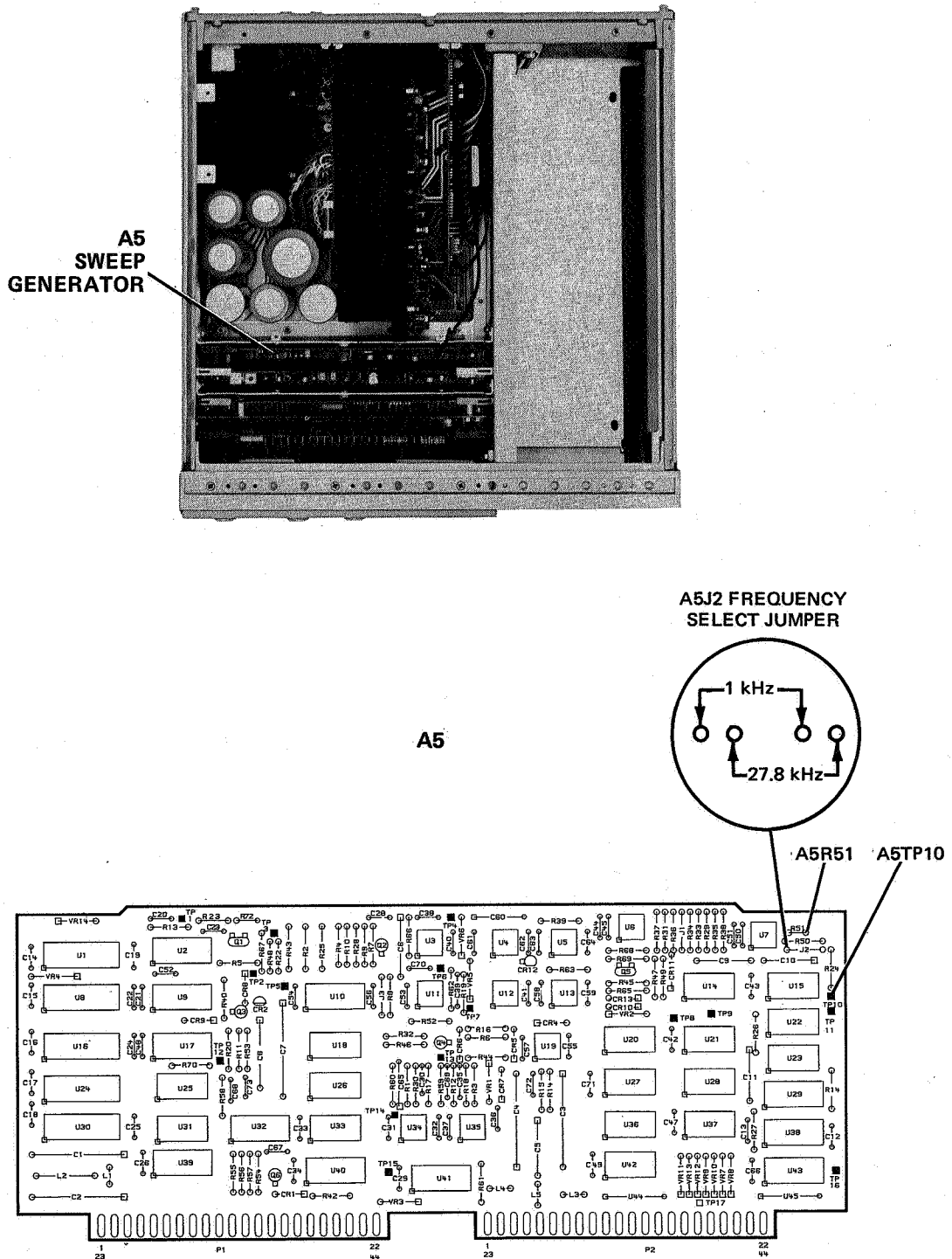

Figure 5-15. Location of 27.8/1 kHz Oscillator Adjustment.

ADJUSTMENTS

5-19. FREQUENCY CONTROL ADJUSTMENTS

REFERENCE:

A4 Scaling and Marker Assembly

DESCRIPTION

The A4U10 VERNIER DAC is first calibrated for symmetrical frequency operation with no RF plug-in installed. With the 8350A set to -200 MHz in CW mode, A4R44 CW OFFSET is set to adjust the accuracy of the low end of the VERNIER frequency range. A4R22 VERNIER is then adjusted to set the accuracy of the high end of the VERNIER frequency range. The 8350A is then tuned to a CW frequency of 10.2 GHz and A4R27 CW is adjusted to set the CW frequency accuracy at the high end of the frequency band. The A4 ΔF Generation circuits are then adjusted for frequency accuracy on each of three ΔF frequency ranges (full-band range, 1/8-band range, and 1/64-band range in ΔF sweeps). The high and low end accuracy of the full RF plug-in band ΔF range is adjusted by A4R2 ΔF OFFSET and A4R25 ΔF1. The VERNIER then adjusts the center frequency to the exact center of the band in a 0 GHz ΔF sweep mode. At this point, the ΔF sweep range is narrowed to 1.299 GHz, just below the switch point at 1.3 GHz where the resolution scaling of the A4 ΔF Generation circuits change from full-band to < 1/8-band range. A4R15 ΔF2 is then adjusted to calibrate the resolution accuracy for ΔF sweeps in this range. The ΔF sweep range is narrowed again to 162.4 MHz, just below the switch point at 162.5 MHz where the resolution scaling of the A4 ΔF Generation circuits changes to < 1/64-band range. A4R18 ΔF3 is then adjusted to calibrate the resolution accuracy in the narrowest ΔF sweep range.

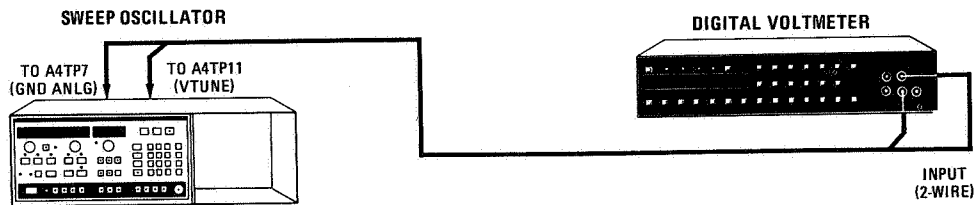

Figure 5-16. Frequency Control Adjustments Setup.

EQUIPMENT:

- Sweep Oscillator..... HP 8350A
- Digital Voltmeter (DVM)..... HP 3455A

PROCEDURE:

1. Remove the RF plug-in from the sweep oscillator mainframe.
2. Position the sweep oscillator upright as shown in Figure 5-16 and remove the top cover.
3. Set the LINE switch to ON and allow the sweep oscillator to warm up for 30 minutes.

## ADJUSTMENTS

## 5-19. FREQUENCY CONTROL ADJUSTMENTS (Cont'd)

## VERNIER Calibration

## NOTE

The validity of this adjustment procedure is based in part on the accuracy of the +10V REF DAC power supply. Proper adjustment of the +10V REF DAC power supply is necessary before proceeding with this adjustment procedure.

4. Connect the DVM to A4TP11 (VTUNE) and A4TP7 (GND ANLG).
5. Press **INSTR PRESET CW - 2 0 0 MHz**. This sets the sweep ramp circuits at the start of sweep.
6. Press **SHIFT 0 0 M1 3 0 0 0 M2 0 1**. The FREQUENCY/TIME display should indicate 01. This sets Digital-to-Analog Converter (DAC) A4U10 to 01H.
7. Adjust A4R44 CW OFFSET for a DVM reading of  $-0.20508 \pm 0.00002$  Vdc. Refer to Figure 5-17 for adjustment location.
8. Press **BK SP BK SP**. The FREQUENCY/TIME display should indicate FF. This sets A4U10 DAC to its maximum level.
9. Adjust A4R22 VERNIER for a DVM reading of  $-0.19492 \pm 0.00002$  Vdc. Refer to Figure 5-17 for adjustment location.
10. Press **8 0**. The FREQUENCY/TIME display should indicate 80. This sets A4U10 DAC to midrange.
11. Check to insure that the DVM reading is  $-0.20000 \pm 0.00002$  Vdc.
12. Press **INSTR PRESET CW 1 0 . 2 GHz**.
13. Remove A4/A5 shield cover and adjust A4R27 CW for a DVM reading of  $10.2000 \pm 0.0001$  Vdc. Refer to Figure 5-17 for adjustment location.

 $\Delta$ F GENERATION Adjustments

## NOTE

The validity of this adjustment is based in part on the accuracy of the VSW1 input from the A5 Sweep Generator assembly. Proper adjustment of the A5 Sweep Generator circuits is necessary before proceeding with this adjustment procedure.

ADJUSTMENTS

5-19. FREQUENCY CONTROL ADJUSTMENTS (Cont'd)

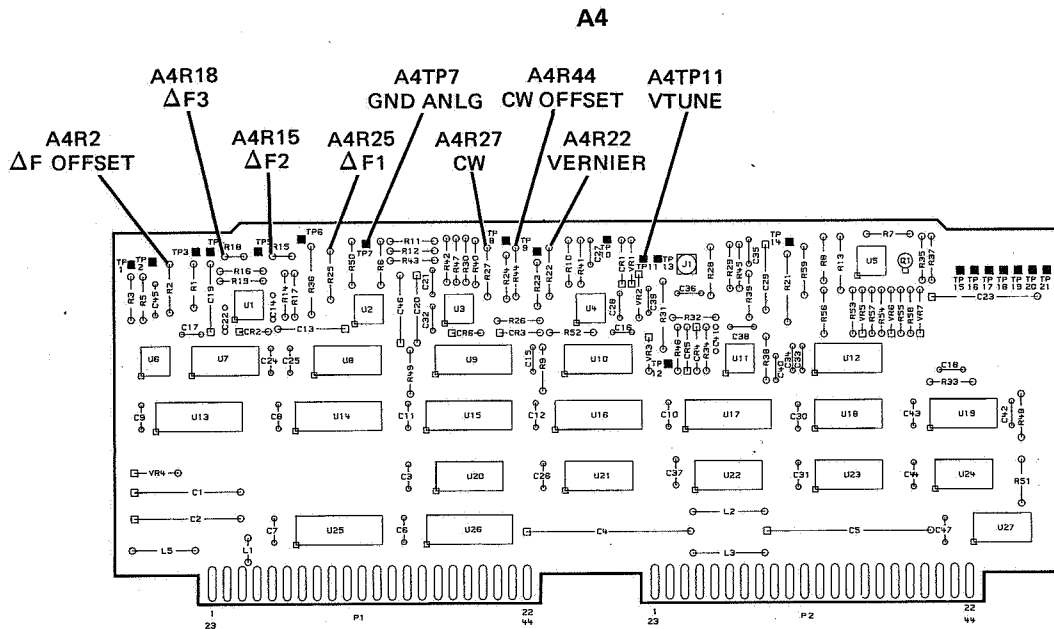
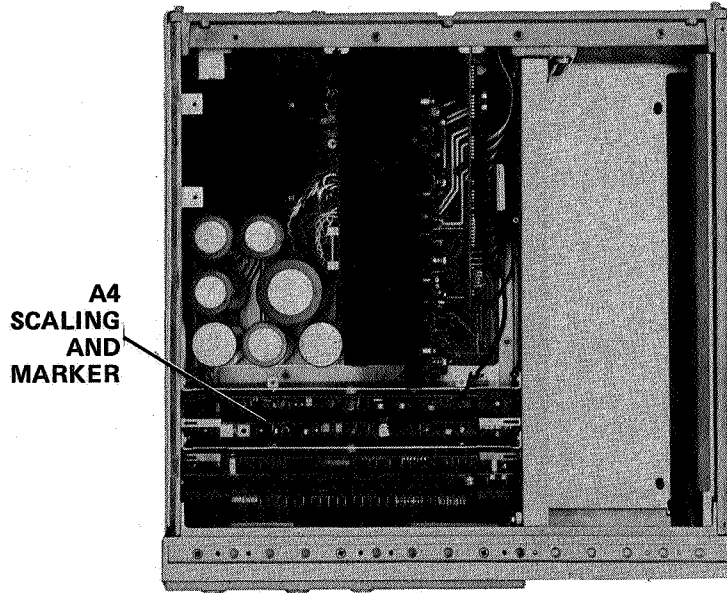

Figure 5-17. Location of Frequency Control Adjustments.



## ADJUSTMENTS

**5-19. FREQUENCY CONTROL ADJUSTMENTS (Cont'd)**

14. Press INSTR PRESET  $\Delta F$  1 0 . 4 GHz SWEEP MAN 1 0 . 2 GHz.
15. Adjust A4R25  $\Delta F1$  for a DVM reading of  $10.2000 \pm 0.0001$  Vdc. Refer to Figure 5-17 for adjustment location.
16. Press - 2 0 0 MHz.
17. Adjust A4R2  $\Delta F$  OFFSET for a DVM reading of  $-0.2000 \pm 0.0001$  Vdc. Refer to Figure 5-17 for adjustment location.
18. Press  $\Delta F$  0 GHz.
19. Check to insure the DVM reading is  $5.00000 \pm 0.00005$  Vdc. If it is not, press VERNIER, rotate CW VERNIER until the DVM reading is  $5.00000 \pm 0.00005$  Vdc.
20. Press  $\Delta F$  1 . 2 9 9 GHz.
21. Adjust A4R15  $\Delta F2$  for a DVM reading of  $4.35064 \pm 0.00005$  Vdc. Refer to Figure 5-17 for adjustment location.
22. Press  $\Delta F$  1 6 2 . 4 MHz.
23. Adjust A4R18  $\Delta F3$  for a DVM reading of  $4.91883 \pm 0.00005$  Vdc. Refer to Figure 5-17 for adjustment location.

ADJUSTMENTS

5-20. MARKER DAC ADJUSTMENT

REFERENCE:

A4 Scaling and Marker Assembly

DESCRIPTION:

The 8350A is set, without an RF plug-in installed, for a stop frequency of 10 GHz with a single marker set to 10 GHz also. The rear panel POS Z BLANK BNC output (high=sweep retrace, low=forward sweep) is monitored by a time interval counter and A4R28 MKR is adjusted to set the reference voltage for marker DAC A4U12 so that the marker DAC output is calibrated to match the end of the sweep ramp.

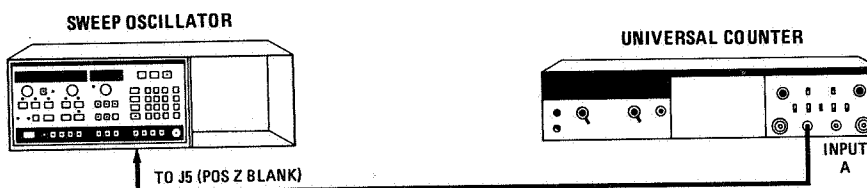

Figure 5-18. Marker DAC Adjustment Setup

EQUIPMENT:

Sweep Oscillator.....	HP 8350A
Universal Counter.....	HP 5328A

PROCEDURE:

1. Remove the RF plug-in from the sweep oscillator mainframe.
2. Set the 8350A LINE switch to ON and allow the sweep oscillator to warm up for 30 minutes.
3. Connect the POS Z BLANK BNC output connector on the rear panel of the 8350A to the INPUT A connector on the 5328A Universal Counter and set the 5328A controls as follows:

FUNCTION.....	TI A→B
SAMPLE RATE.....	CCW
OSC (rear panel).....	INT
ARM ON/OFF (rear panel).....	OFF
STORAGE ON/OFF (rear panel).....	ON
POWER.....	ON
Input Amplifier Control Switch.....	COM A
Channel A SLOPE.....	-
Channel A Coupling.....	DC
Channel A ATTEN.....	X10
Channel A Trigger LEVEL A.....	CCW
Channel B SLOPE.....	+

ADJUSTMENTS

5-20. MARKER DAC ADJUSTMENT (Cont'd)

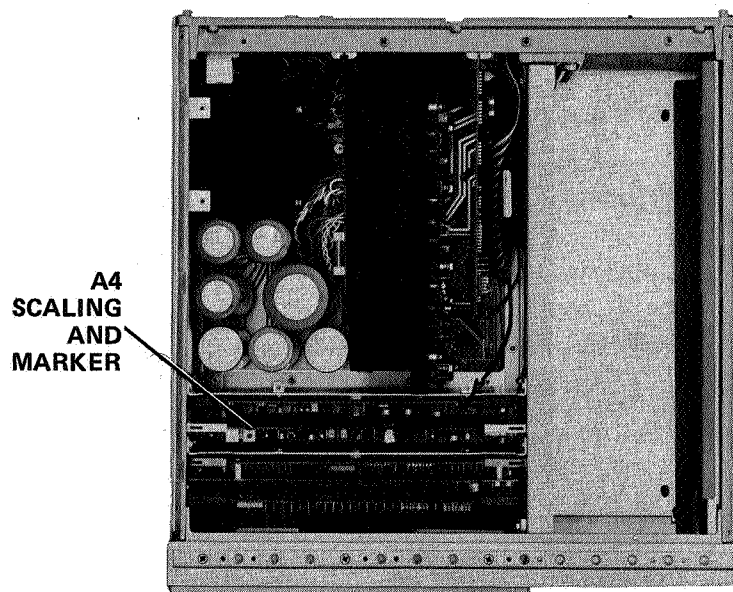

A4

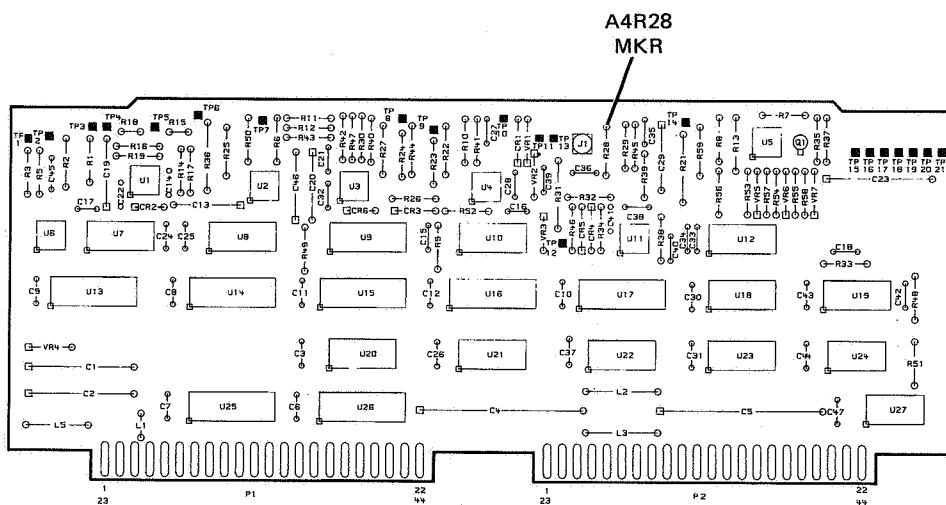

Figure 5-19. Location of Marker DAC Adjustment

## ADJUSTMENTS

## 5-20. MARKER DAC ADJUSTMENT (Cont'd)

Channel B Coupling .....	DC
Channel B ATTEN .....	X10
Channel B Trigger LEVEL B .....	CCW

- Position the sweep oscillator upright as shown in Figure 5-18 and remove the top cover.
- Press INSTR PRESET STOP 1 0 GHz M1 1 0 GHz SWEEP TIME 1 s. This sets marker M1 at the STOP frequency of 10 GHz.
- Preset A4R28 MKR fully clockwise to insure that a marker will occur before the end of the sweep ramp is reached.
- Set the 5328A FREQUENCY RESOLUTION, N control to 0.1 MHz 10. From the CCW position, adjust Channel A and B trigger LEVELS CW until just past the point where both triggering LEDs blink. This should typically occur at the 10 o'clock position on both trigger LEVEL controls. The counter should now read approximately 4000 us.

## NOTE

The setting of the 5328A triggering controls is critical for an accurate time interval measurement.

- Adjust A4R28 MKR counterclockwise for a counter reading of  $500 \pm 100$  us. This sets the width of the -8 volt marker pulse as shown in Figure 5-20. Refer to Figure 5-19 for adjustment location.

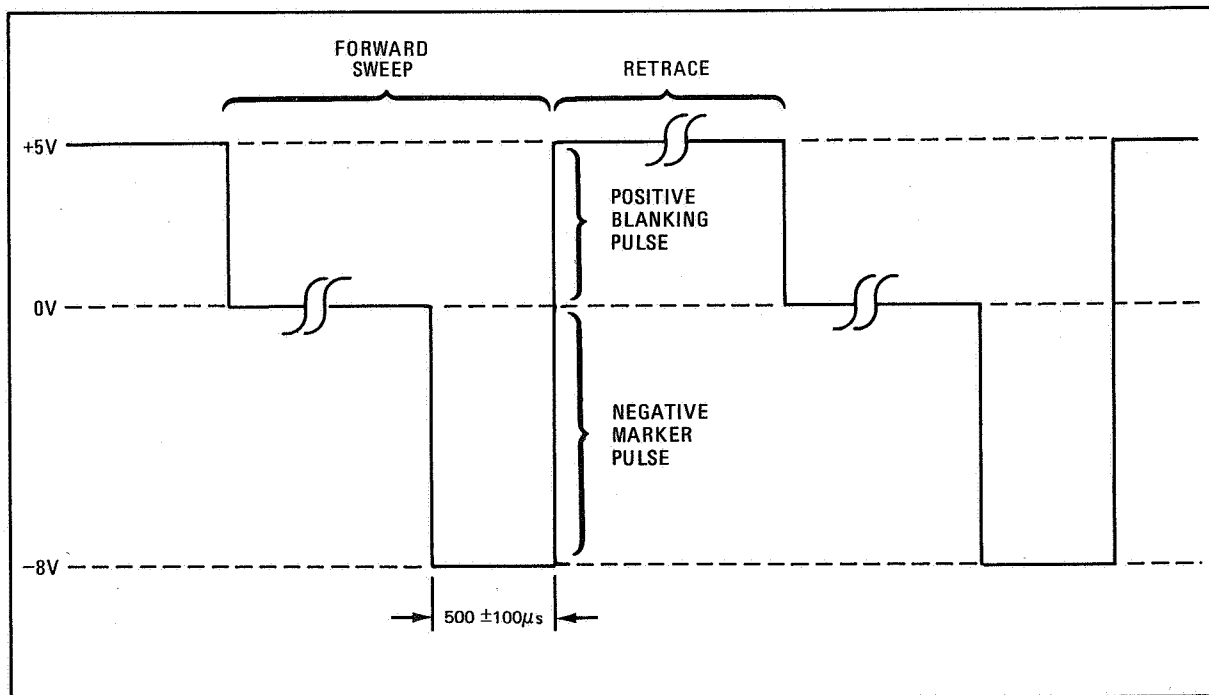

Figure 5-20. Marker DAC Adjustment Waveform



**MANUAL SUPPLEMENT**

**8350A**  
**SWEEP OSCILLATOR**  
**Modification Kit (08350-60099)**  
**for 8350B firmware update**

USE THIS SUPPLEMENT WITH  
MANUAL PART NUMBER 08350-90001  
PRINTED JANUARY 1981

34 pages plus 1 foldout



## GENERAL INFORMATION

### INTRODUCTION

This manual supplement describes the difference between a factory equipped 8350A Sweep Oscillator and an 8350A Sweep Oscillator equipped with Modification Kit 08350-60099. In addition, this supplement describes changes to the 8350A Operating and Service Manual (08350-90001) necessary to document the addition of the 08350-60099 Modification Kit.

### DESCRIPTION

The 08350-60099 Modification Kit allows the HP 8350A Sweep Oscillator to be fully compatible with the HP 8756A Scalar Network Analyzer. Other features are listed below:

- Non-volatile memory.
- Increased resolution in CW mode. CW resolution is 0.00038% of band. This resolution is available via Control Knob (RPG), Data Entry Keyboard, HP-IB Interface, or direct control of the CW DAC (Digital to Analog Converter) with Hex Entry commands.
- Coarse or fine CW Control Knob resolution.
- Save/Recall memory lock. Write protects the contents of all Save/Recall registers.
- Display Frequency Multiplier and Offset. Allows modification of displayed frequency so the 8350A display will reflect the actual frequencies being produced by an external frequency upconverter or harmonic multiplier.
- Faster Microprocessor operation

### MANUAL CHANGES FOR MODEL 8350A

Changes to be made to the 8350A Operating and Service Manual in order to document the 08350-60099 Modification Kit are described under the following headings: GENERAL INFORMATION, OPERATION, ADJUSTMENTS, REPLACEABLE PARTS, and SERVICE. Change the 8350A Manual as listed here.

### MANUAL CHANGES

**NOTE:** Any information regarding Option 001 are applicable to any HP 8350A equipped with a 08350-60099 Modification Kit.

**NOTE:** With the addition of Battery Pack (BT1) and Battery Clamp, this modification kit equips the 8350A with non-volatile memory. Non-volatile memory allows the 8350A to retain all control settings in memory when the instrument is turned off. The control settings are restored when the instrument is turned on.

**NOTE:** All references to "8350B" in the material supplied in this manual supplement are applicable to any 8350A equipped with Modification Kit 08350-60099.

## GENERAL

Page 1-2, Table 1-1:

Add a third paragraph to **START/STOP Sweeps**: "START/STOP Resolution: Same as DF resolution."

Change CF Resolution to read: "0.00038% of band (262,144 points across band)."

Change Vernier Resolution to read: "Same as CW/CF resolution."

Page 1-4, Table 1-2:

Add to the end of **SAVEN/RECALLn**: "All Save registers may be write protected (locked) by pressing **[SHIFT] [SAVEN]**. This command makes it impossible to change the contents of the memory registers until they are unlocked by pressing **[SHIFT] [RECALLn]**. The locked/unlocked status is retained even with ac power off."

Page 1-5, Table 1-2:

Under **HP-IB Functions**: Change Frequency Resolution to read: "Dependent upon Frequency Sweep Mode. See Table 1-1 for the resolution of the appropriate Sweep Mode."

Page 1-6, Paragraph 1-19:

Change the second sentence to read: "The Model 8350A can be used with network analyzer systems such as the HP Model 8756A Scalar Network Analyzer, the HP Model 8410C Network Analyzer, the HP Model 8755 Frequency Response Test Set, and the HP Microwave Link Analyzers to provide a complete measurement system."

Page 1-7, Paragraph 1-30:

Add the following after paragraph 1-30:

**"1-30A. Fine/Coarse CW Control Knob Resolution.**

1-30B. The CW control knob resolution may be increased from 0.0015% of band (16,384 points across band) to 0.00038% of band (262,144 points across band) by pressing **[SHIFT] [DF]**. To return to coarse control knob resolution press **[SHIFT] [CF]**. The resolution of HP-IB entries and entries using the data entry keyboard are both 0.00038% of band. Due to display resolution limitations, small changes to CW frequency may not be shown in the CW Frequency display. The CW Vernier mode will allow small changes in CW frequency to be displayed."

Page 1-7, 1-8, Paragraph 3-36:

Change the last sentence of paragraph 1-36 to read:

"This allows the Model 8350A to work in conjunction with the HP Model 8756A Scalar Network Analyzer or HP Model 8755 Frequency Response Test Set to perform two simultaneous measurements utilizing different sweep widths and/or power levels."

Add the following after paragraph 1-42:

**"1-42A. Displayed Frequency Multiplier**

1-42B. The frequency information of the 8350A front panel display may be modified by entering a numeric multiplication factor with the command **[n] [SHIFT] [M4]**. The displayed frequency information now reflects the actual RF frequencies produced by an external harmonic multiplier

**1-42C. Displayed Frequency Offset**

1-42D. The frequency information on the 8350A front panel may be modified by entering a numeric offset value with the command **[n] [SHIFT] [M5]**. The displayed frequency information may now reflect the actual RF frequencies produced by an external upconverter."



Page 1-10, Paragraph 1-69:

Add the following after paragraph 1-69:

**"1-69A. Model 8756A Scalar Network Analyzer**

1-69B. The Model 8350A Sweep Oscillator, when equipped with Modification Kit 08350-60099, is compatible with the HP 8756A Scalar Network Analyzer for broadband swept scalar measurements. The 8756A operates in the RF and microwave frequency ranges depending on the detector used. The 8756A utilizes a versatile digitized CRT and employs built-in storage and normalization features. The 8756A CRT simultaneously displays swept scalar information, a softkey menu, channel number, mode of operation, scale factor, and reference level information of selected channel(s). The 8756A is equipped with advanced HP-IB interfacing capabilities which allow it to display the 8350A START and STOP frequencies as well as the above mentioned information. The 8756A HP-IB features also allow the user to control many 8350A functions directly from the 8756A front panel. The Model 8350A provides internal 27.8kHz square wave modulation of the RF output thereby eliminating the use of an external modulator."

**OPERATION**

**SECTION III, OPERATING INFORMATION**

Replace the **OPERATING INFORMATION** manual in Section III with the **OPERATING INFORMATION** manual from this manual supplement.

**SECTION III, LOCAL OPERATION:**

Page 1, **INTRODUCTION:**

Under "USE WITH SPECIFIC MEASUREMENT EQUIPMENT:" add the following to the top of the list: "HP 8756A Scalar Network Analyzer".

Page 6 and 7, Figure 3:

Insert after "**CW**" description:

**"CW Coarse/Fine Control Knob Resolution**

CW control knob resolution is coarse when CW mode is activated after an Instrument Preset command. To change from coarse control knob resolution (0.0015% of band, 16,384 points across band) to fine control knob resolution (0.00038% of band, 262,144 points across band) press [**SHIFT**] [**DF**]. To return to coarse control knob resolution press [**SHIFT**] [**CF**]."

Insert after "**FREQUENCY OFFSET**" description:

**"Display Multiplier:** Modifies front panel display only. This feature allows the FREQUENCY LED displays to show the final RF output when a frequency multiplier is used. The FREQUENCY/TIME display (not pictured above) contains the selected multiplication factor. Allowable multiplication factors are 1 to 99 (integers only).

**Display Offset:** Modifies front panel display only. This feature allows the FREQUENCY LED displays to show the final RF output when a frequency up-converter is used. The FREQUENCY/TIME display (not pictured above) contains the selected offset value. Allowable offset values are 0 to 999 GHz."

Page 11, Figure 5:

Insert after the "SAVEN/RECALLn" description:

**"SAVE REGISTER LOCK:**

All SAVE registers may be write protected (locked) by pressing **[SHIFT] [SAVEN]**. This command makes it impossible to change the contents of any register until it is unlocked by pressing **[SHIFT] [RECALLn]**. Since the 8350A memory is non-volatile when equipped with Retrofit Kit 08350-60099, the contents of SAVE registers and the locked/unlocked status are retained even with line power off. If a SAVEn command is attempted after SAVE-LOCK is engaged an Error 30 (E030) is displayed."

Pages 31, 32, and 33:

Insert pages 7 through 9 of this manual supplement at the end of the LOCAL OPERATION manual: **ADJUSTMENTS.**

Page 5-4, Table 5-4:

Delete reference to assembly A3A1.

**REPLACEABLE PARTS**

Page 6-8 through 6-10, Table 6-2:

Substitute the attached A3 Microprocessor Board Assembly Replaceable Parts List.

Page 6-10 and 6-11, Table 6-2:

Delete all references to A3A1 PROM Assembly.

Page 6-14, Table 6-2:

Add A5CR14 HP Part Number 1901-0954, CD6, QTY 1, DIODE-CUR RGLTR 1N5285 270uA DO-7, 28480, 1901-0954.

Change A5CR2 to HP Part Number 1906-0268, CD5, QTY 1, D 2-GP 30V 20mA 71, 28480, 1906-0268.

Page 6-15 Table 6-2:

Delete A5R23.

Page 6-16, Table 6-2:

Delete A5R72.

Page 6-17, Table 6-2:

Delete A5VR14.

Page 6-21, Table 6-2:

Change A8U6 HP and Mfr Part Number to 1820-2748 CD8.

**SERVICE**

Page 8-1, Table 8-1:

Delete all references to A3A1 Assembly.

Page 8-28 and 8-41, **Front Panel Interrupt Timer and Interrupt Control:**

Delete reference to A3TP29 and replace with: "L IBIRQ (A3P2-33)"

Delete reference to A3TP31 and replace with: "L PIIRQ (A3P2-20)"

Page 8-44 through 8-56, **A3 MICROPROCESSOR CIRCUIT DESCRIPTION:**

Replace the **A3 MICROPROCESSOR CIRCUIT DESCRIPTION** with the **A3 MICROPROCESSOR CIRCUIT DESCRIPTION** from this manual supplement.

Page 8-57 and 8-58:

Replace Figures 8-25 through 8-29 with Figures 8-25 through 8-29 from this manual supplement.

Delete **A3A1 PROM BOARD CIRCUIT DESCRIPTION**, including Table 8-23 and Figure 8-30.

Page 8-59, Figure 8-30A:

Delete *Figure 8-30A. A3A1 PROM Assembly, Schematic Diagram.*

Page 8-75, Figure 8-43 (1 of 2):

Replace part of Block D, SWEEP RAMP GENERATOR, with *P/O Figure 8-43 (1 of 2), A5 Sweep Generator, Schematic Diagram, Block D (Replacement A)* from this manual supplement.

Replace part of Block D, SWEEP RAMP GENERATOR, with *P/O Figure 8-43 (1 of 2), A5 Sweep Generator, Schematic Diagram, Block D (Replacement B)* from this manual supplement.

Delete A5TP17 in Block D.

Replace part of Block E SWEEP TRIGGER with *P/O Figure 8-43 (1 of 2), A5 Sweep Generator, Schematic Diagram, Block E* from this manual supplement.

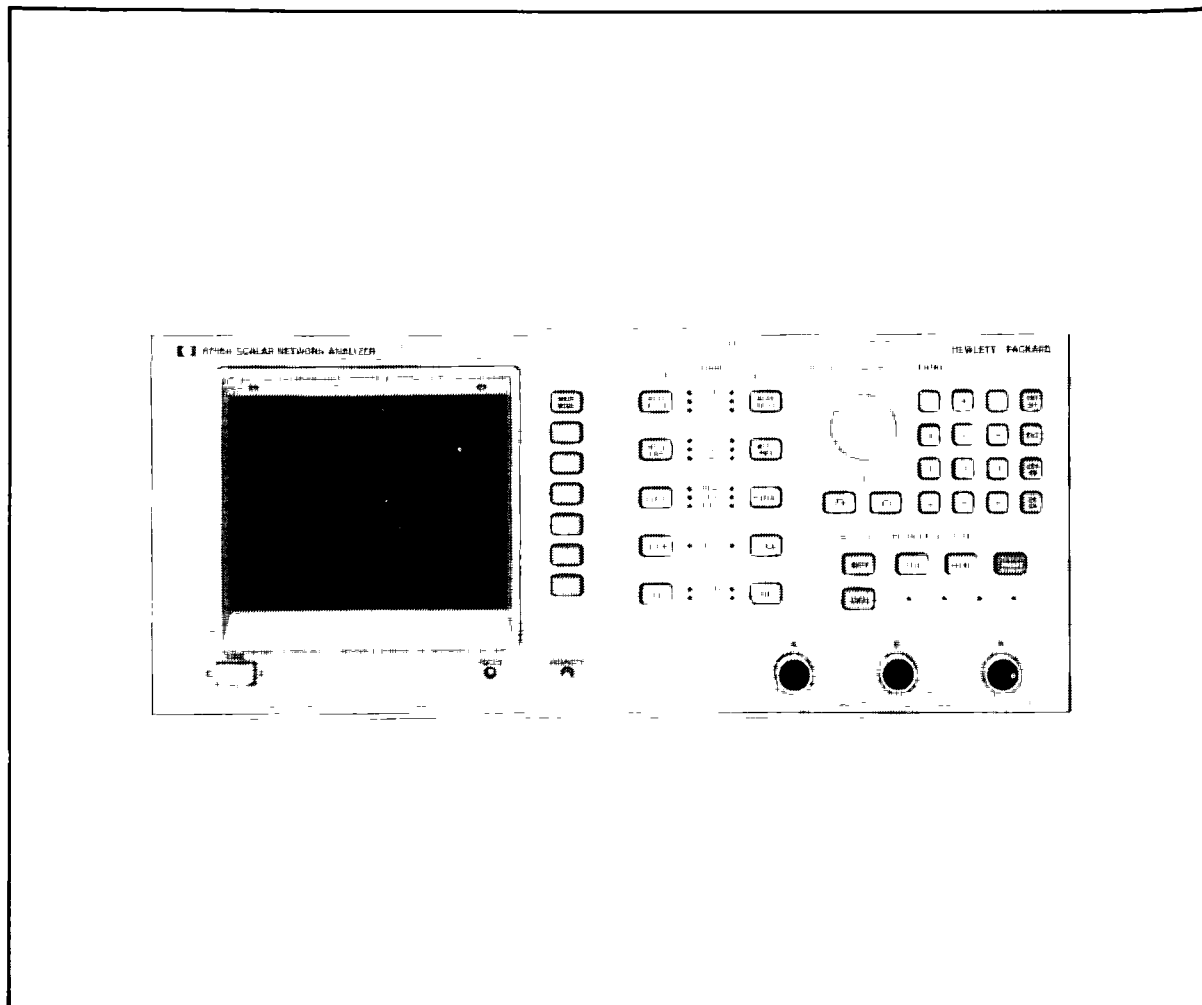

Figure 19 8756A Scalar Network Analyzer

## INTERFACING THE 8350B WITH SPECIFIC MEASUREMENT EQUIPMENT

### 8756A SCALAR NETWORK ANALYZER

The 8756A is used for scalar transmission and reflection measurements, with 60 dB of dynamic range for ratio measurements, and absolute power measurement from  $-50$  dBm to  $+10$  dBm.

The 8350B has the following features designed for use with the 8756A Scalar Network Analyzer

**RF Square-wave Modulation.** By engaging the  $\square$  MOD key an internally generated squarewave modulation of the RF output is available thus eliminating the need for external modulating equipment. A jumper internal to the 8350B enables the square wave modulation frequency to be changed to 1 KHz (see section 5 of the Operating and Service manual for details).

**Alternate Sweep Function.** The ALTn function of the 8350B allows two different frequency and power settings to be swept on successive sweeps. The front panel setting and the setting stored in a memory register location n ( $n=1, \dots, 9$ ) can be selected for alternate sweeps. See Figure 20 for a sweep display of the ALTn function when used with a bandpass response at different resolutions and offsets.

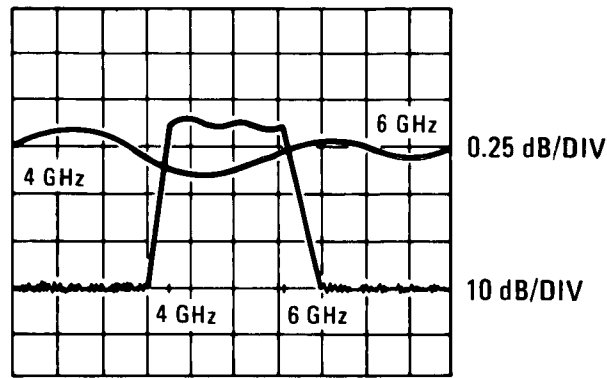

Figure 20. Alternate Sweep Function Display

Some other features enhancing the convenience and versatility of the 8756A are.

**Marker  $\Delta$ .** The MKR  $\Delta$  function reduces the trace intensity between the Active and the previously Active Markers

**Power Sweep.** The RF output power may be ramped up when the sweeper is in the swept or "swept" CW mode by using the POWER SWEEP function. See Figure 21 for a gain compression display using power sweep.

**Save and Recall.** This function allows the storage and recall of nine complete instrument settings.

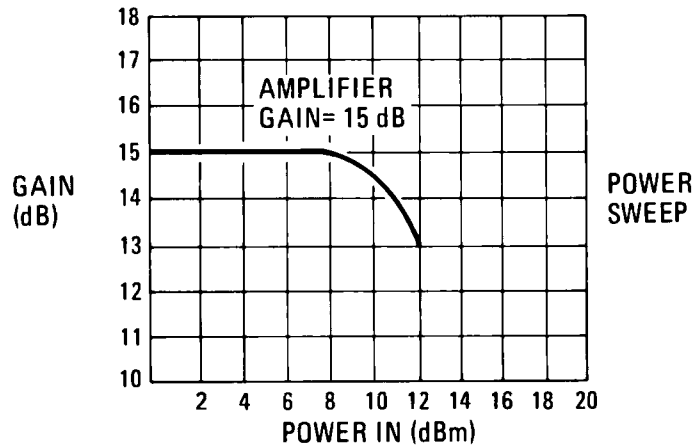

Figure 21. Gain Compression Display

Figure 22 outlines the general procedure used in making a scalar transmission and reflection measurement. The 11692D Dual-Directional Coupler is used in the example but if an 11666A Reflectometer Bridge, a 85020A/B, or a 85021 A/B Directional Bridge is available, it may be used instead of the Coupler and two detectors.

For more information and additional features of the 8756A with the 8350B, refer to the Operating Section of the 8756A Operating and Service Manual.

## Example:

1. Connect the equipment as shown in the diagram below. Initially, the 8350B should be set by pressing [**PRESET**] on the 8756A. The sweep time will be set to 150 ms, the 8350B internal square wave modulation and the 8350B INSTR PRESET will be activated.

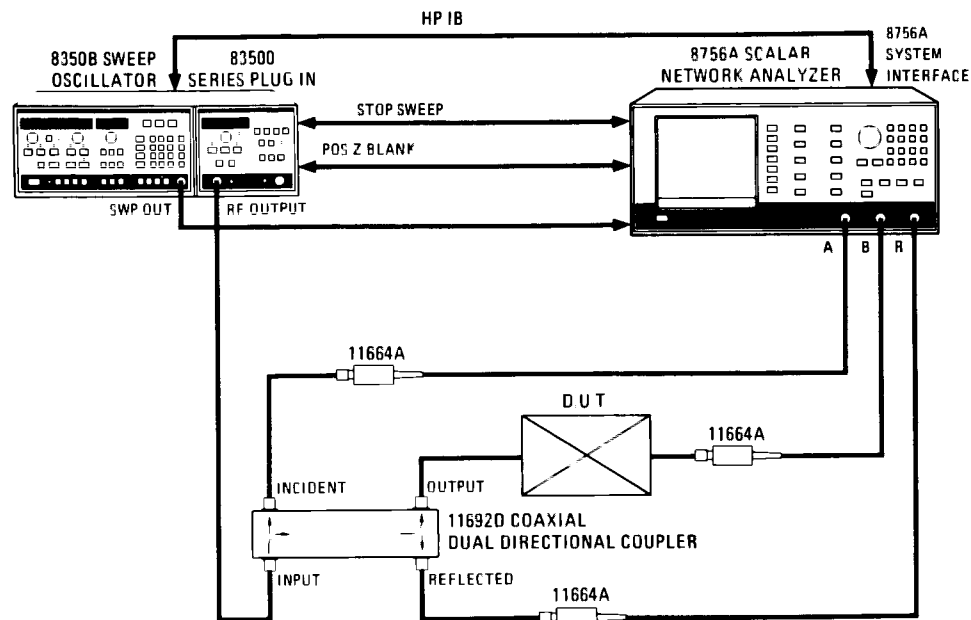

## Notes on connections:

- Either the front or rear panel SWEEP OUT/IN may be used.
  - When in ALTn mode both channels 1 and 2 (on 8756A) must be on and receiving inputs.
2. Turn off channel 1 on the 8756A by pressing [**SHIFT**] [**MEAS RATIO**]. Set the 8350B controls as desired. On channel 2 set the function, dB/DIV and Offset desired for viewing the current sweep setting.
  3. Set the 8350B controls as desired then store the current 8350B sweep setting in any available memory location. Then turn off channel 2 of the 8756A by pressing the [**SHIFT**] [**MEAS RATIO**] pushbuttons.
  4. On Channel 1 of the 8756A, set the function, dB/DIV and Offset as desired. Set 8350B controls as desired.
  5. Turn on channel 2. Press [**ALTn**] [**n**] and the 8350B will alternate between the two settings on successive sweeps.

Channel 1 now displays the response due to the current front panel setting while channel 2 displays the response to the setting stored in memory location n. The front panel controls of the 8350B are enabled and the current sweep setting may be altered if necessary.

Figure 22. Typical Test Setup Using 8756A

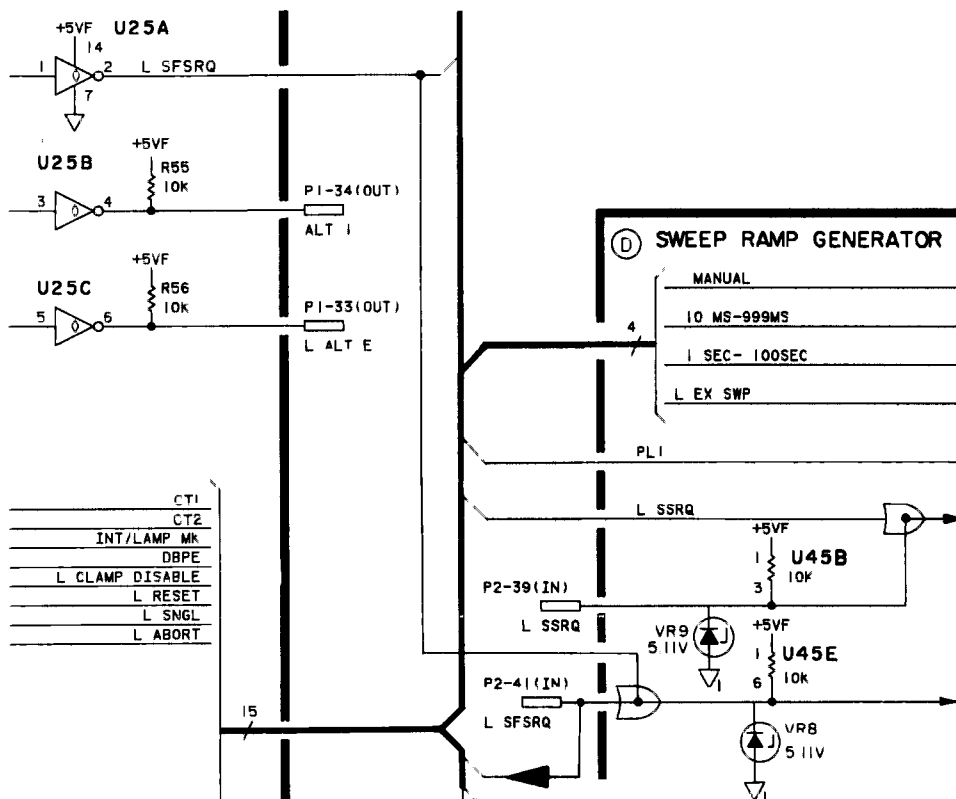

P/O Figure 8-43 (1 of 2), A5 Sweep Generator, Schematic Diagram, Block D (Replacement A)

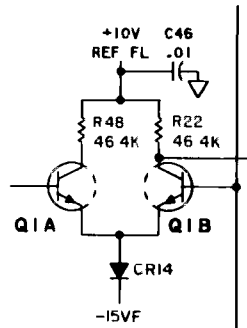

*P/O Figure 8-43 (1 of 2), A5 Sweep Generator, Schematic Diagram, Block D (Replacement B)*

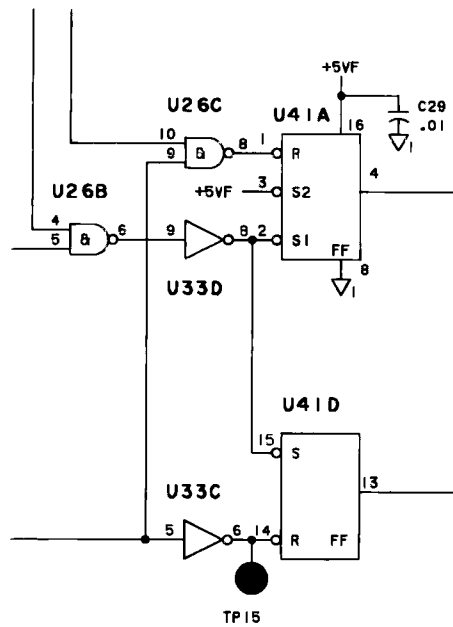

*P/O Figure 8-43 (1 of 2), A5 Sweep Generator, Schematic Diagram, Block E*



Table 6-2 Replaceable Parts

Reference Designation	HP Part Number	C D	Qty	Description	Mfr Code	Mfr Part Number
H3	00250-60061	4	1	PCB ASSEMBLY-MICROPROCESSOR	25420	00250-60061
H3C1	0180-2214	4		CAPACITOR-F D 900F+75-10% 16VDC HL	56289	200706G016002
H3C2	0180-2214	4		CAPACITOR-F D 900F+75-10% 16VDC HL	56289	300706G016002
H3C3	0180-0229	7		CAPACITOR-F D 330F+10% 10VDC TH	56289	150D736 9010B2
H3C4	0160-2055	9		CAPACITOR-F D 010F +80-20% 100VDC CEP	28480	0160-2055
H3C5	0160-2308	5	2	CAPACITOR-F D 36PF ±5% 300VDC NICA	28480	0160-2308
H3C6	0160-2308	5		CAPACITOR-F D 36PF ±5% 300VDC NICA	28480	0160-2308
H3C7	0160-2055	9		CAPACITOR-F D 010F +80-20% 100VDC CEP	28480	0160-2055
H3C8	0160-2055	9		CAPACITOR-F D 010F +80-20% 100VDC CEP	28480	0160-2055
H3C9	0160-2055	9		CAPACITOR-F D 010F +80-20% 100VDC CEP	28480	0160-2055
H3C10	0140-0192	9	4	CAPACITOR-F D 68PF ±5% 300VDC NICA	72136	D015E680T0300WVDC
H3C11	0140-0192	9		CAPACITOR-F D 68PF ±5% 300VDC NICA	72136	D015E680T0300WVDC
H3C12	0160-3456	6		CAPACITOR-F D 1000PF ±10% 11VDC CEP	28480	0160-3456
H3C13	0160-3456	6		CAPACITOR-F D 1000PF ±10% 11VDC CEP	28480	0160-3456
H3C14	0160-4084	8		CAPACITOR-F D 1UF ±20% 50VDC CEP	28480	0160-4084
H3C15	0160-2055	9		CAPACITOR-F D 010F +80-20% 100VDC CEP	28480	0160-2055
H3C16	0160-2055	9		CAPACITOR-F D 010F +80-20% 100VDC CEP	28480	0160-2055
H3C17	0160-2055	9		CAPACITOR-F D 010F +80-20% 100VDC CEP	28480	0160-2055
H3C18	0160-2055	9		CAPACITOR-F D 010F +80-20% 100VDC CEP	28480	0160-2055
H3C19	0160-2055	9		CAPACITOR-F D 010F +80-20% 100VDC CEP	28480	0160-2055
H3C20	0160-2055	9		CAPACITOR-F D 010F +80-20% 100VDC CEP	28480	0160-2055
H3C21	0160-2055	9		CAPACITOR-F D 010F +80-20% 100VDC CEP	28480	0160-2055
H3C22	0160-2055	9		CAPACITOR-F D 010F +80-20% 100VDC CEP	28480	0160-2055
H3C23	0160-2055	9		CAPACITOR-F D 010F +80-20% 100VDC CEP	28480	0160-2055
H3C24	0160-2055	9		CAPACITOR-F D 010F +80-20% 100VDC CEP	28480	0160-2055
H3C25	0160-2055	9		CAPACITOR-F D 010F +80-20% 100VDC CEP	28480	0160-2055
H3C26	0160-2055	9		CAPACITOR-F D 010F +80-20% 100VDC CEP	28480	0160-2055
H3C27	0160-2055	9		CAPACITOR-F D 010F +80-20% 100VDC CEP	28480	0160-2055
H3C28	0160-2055	9		CAPACITOR-F D 010F +80-20% 100VDC CEP	28480	0160-2055
H3C29	0160-2055	9		CAPACITOR-F D 010F +80-20% 100VDC CEP	28480	0160-2055
H3C30	0160-3456	6		CAPACITOR-F D 1000PF ±10% 11VDC CEP	28480	0160-3456
H3C31	0160-2055	9		CAPACITOR-F D 010F +80-20% 100VDC CEP	28480	0160-2055
H3C32	0160-2055	9		CAPACITOR-F D 010F +80-20% 100VDC CEP	28480	0160-2055
H3C33	0160-2055	9		CAPACITOR-F D 010F +80-20% 100VDC CEP	28480	0160-2055
H3C34	0160-2055	9		CAPACITOR-F D 010F +80-20% 100VDC CEP	28480	0160-2055
H3C35	0160-2055	9		CAPACITOR-F D 010F +80-20% 100VDC CEP	28480	0160-2055
H3C36	0160-2055	9		CAPACITOR-F D 010F +80-20% 100VDC CEP	28480	0160-2055
H3C37	0140-0192	9		CAPACITOR-F D 68PF ±5% 300VDC NICA	72136	D015E680T0300WVDC
H3C38	0140-0192	9		CAPACITOR-F D 68PF ±5% 300VDC NICA	72136	D015E680T0300WVDC
H3CF1	1901-0050	3	12	DIODE-SWITCHING 80V 200MA 2MS DO-35	28480	1901-0050
H3CF2	1901-0050	3		DIODE-SWITCHING 80V 200MA 2MS DO-35	28480	1901-0050
H3CF3	1901-0050	3		DIODE-SWITCHING 80V 200MA 2MS DO-35	28480	1901-0050
H3CF4	1901-0050	3		DIODE-SWITCHING 80V 200MA 2MS DO-35	28480	1901-0050
H3DS1	1990-0486	6	4	LED-LAMP LUH-INT=INCD IF=20MA-MA VWR=5V	28480	5082-4684
H3DS2	1990-0486	6		LED-LAMP LUH-INT=INCD IF=20MA-MA VWR=5V	28480	5082-4684
H3DS3	1990-0486	6		LED-LAMP LUH-INT=INCD IF=20MA-MA VWR=5V	28480	5082-4684
H3DS4	1990-0486	6		LED-LAMP LUH-INT=INCD IF=20MA-MA VWR=5V	28480	5082-4684
H3T1	1251-6135	5	1	CONNECTOR 11-PIN II POST TYPE	28480	1251-6135
H3T2	1251-6616	0	1	CONNECTOR 3-PIN II POST TYPE	28480	1251-6616
H3T4	1251-5041	3	1	CONNECTOR 5-PIN II POST TYPE	28526	65500-105
H3L1	08503-80001	9		COIL-TOROID	28480	08503-80001
H3Q1	1853-0405	9	2	TRANSISTOR PNP SI PD=300MH FT=850MHZ	04713	204209
H3Q2	1853-0405	9		TRANSISTOR PNP SI PD=300MH FT=850MHZ	04713	204209
H3Q3	1854-0019	3	2	TRANSISTOR NPN SI TO-18 PD=360MH	28480	1854-0019
H3Q4	1854-0019	3		TRANSISTOR NPN SI TO-18 PD=360MH	28480	1854-0019
H3Q5	1853-0281	9		TRANSISTOR PNP 202907H SI TO-18 PD=400MH	04713	202907H
H3Q6	1853-0281	9		TRANSISTOR PNP 202907H SI TO-18 PD=400MH	04713	202907H
H3Q7	1854-0477	7		TRANSISTOR NPN 202222H SI TO-18 PD=500MH	04713	202222H
H3P1	0757-0416	7	9	RESISTOR 511 1% 125W F TC=0±100	24546	C4-1 8-T0-511R-F
H3P2	0757-0416	7		RESISTOR 511 1% 125W F TC=0±100	24546	C4-1 8-T0-511R-F
H3P3	0698-2155	1	2	RESISTOR 4 64 1% 125W F TC=0±100	24546	C4-1 8-T0-4641-F
H3P4	0698-2155	1		RESISTOR 4 64 1% 125W F TC=0±100	24546	C4-1 8-T0-4641-F
H3P5	0757-0280	7	14	RESISTOR 1 1% 125W F TC=0±100	24546	C4-1 8-T0-1001-F
H3P6	0757-0280	3		RESISTOR 1 1% 125W F TC=0±100	24546	C4-1 8-T0-1001-F
H3P7	0698-3430	5	4	RESISTOR 21 5 1% 125W F TC=0±100	03888	PHE55-1 8-T0-21P5-F
H3P8	0698-3430	5		RESISTOR 21 5 1% 125W F TC=0±100	03888	PHE55-1 8-T0-21P5-F
H3P9	0698-3430	5		RESISTOR 21 5 1% 125W F TC=0±100	03888	PHE55-1 8-T0-21P5-F
H3P10	0698-3430	5		RESISTOR 21 5 1% 125W F TC=0±100	03888	PHE55-1 8-T0-21P5-F
H3P11	0757-0401	0	10	RESISTOR 100 1% 125W F TC=0±100	24546	C4-1 9-T0-101-F

See introduction to this section for ordering information  
 \*Indicates factory selected value

Table 6-2. Replaceable Parts

Reference Designation	HP Part Number	C D	Qty	Description	Mfr Code	Mfr Part Number
R3P12	0757-0442	9		RESISTOR 100 1% 125W F TC=0±100	2454e	C4-1 8-TN-1002-F
R3P13	0757-0442	9		RESISTOR 100 1% 125W F TC=0±100	2454e	C4-1 8-TN-1002-F
R3P14	0757-0442	9		RESISTOR 100 1% 125W F TC=0±100	2454e	C4-1 8-TN-1002-F
R3P15	0757-041e	7		RESISTOR 511 1% 125W F TC=0±100	2454e	C4-1 8-TN-511F-F
R3P16	0757-0401	11		RESISTOR 100 1% 125W F TC=0±100	2454e	C4-1 8-TN-101-F
R3P17	0757-0401	6		RESISTOR 100 1% 125W F TC=0±100	2454e	C4-1 8-TN-101-F
R3P18	0678-3437	2	2	RESISTOR 100 1% 125W F TC=0±100	2454e	C4-1 8-TN-102F-F
R3P19	0757-041e	7		RESISTOR 511 1% 125W F TC=0±100	2454e	C4-1 8-TN-511F-F
R3P20	0757-0442	9		RESISTOR 100 1% 125W F TC=0±100	2454e	C4-1 8-TN-1002-F
R3P21	0757-0442	9		RESISTOR 100 1% 125W F TC=0±100	2454e	C4-1 8-TN-1002-F
R3P22	0757-0442	9		RESISTOR 100 1% 125W F TC=0±100	2454e	C4-1 8-TN-1002-F
R3P23	0757-0442	9		RESISTOR 100 1% 125W F TC=0±100	2454e	C4-1 8-TN-1002-F
R3P24	0757-0442	9		RESISTOR 100 1% 125W F TC=0±100	2454e	C4-1 8-TN-1002-F
R3P25	0757-0442	9		RESISTOR 100 1% 125W F TC=0±100	2454e	C4-1 8-TN-1002-F
R3S1	3101-2243	6		SWITCH-PWR DIP-PWR-RES. 8-14 05W 30VDC	2643H	3101-2243
R3TP1 - R3TP32	0260-0535	11		TERMINAL TEST POINT PCB	00000	ORDER BY DESCRIPTION
R3U1	1810-0203	5	1	NETWOPI-RES 8-SIP10 0 OHM 7	01121	2104103
R3U2	1820-1959	7		IC CHTR TTL LS BIII DUAL 4-BIT	07267	74LS273PC
R3U3	1820-1197	9		IC GATE TTL LS NAND QUAD 2-IMP	01295	5074LS00H
R3U4	1820-1425	6	2	IC SCHMITT-TRIG TTL LS NAND QUAD 2-IMP	01295	5074LS120H
R3U5	1820-2358	6	1	IC-65600	2646H	1820-2358
R3U6	1810-0280	9		NETWOPI-RES 10-SIP10 0 OHM 9	01121	2104103
R3U7	1818-0990	3	4	IC CMOS 4096 (4K) STAT PWR 32W-NS 3-8	34371	H01-6514-9
R3U8	1818-0990	3		IC CMOS 4096 (4K) STAT PWR 32W-NS 3-8	34371	H01-6514-9
R3U9	08250-80004	7	1	E FROM 1241 PROGRAMMED	2646H	08250-80004
R3U10	08250-80005	6	1	E FROM 641 PROGRAMMED	2646H	08250-80005
R3U11	08250-80006	9	1	E FROM 641 PROGRAMMED	2646H	08250-80006
R3U12	08250-80003	6	1	CLOCK FROM PROGRAMMED	2646H	08250-80003
R3U13	1810-0280	8		NETWOPI-RES 10-SIP10 0 OHM 9	01121	2104103
R3U14	1818-0990	3		IC CMOS 4096 (4K) STAT PWR 32W-NS 3-8	34371	H01-6514-9
R3U15	1818-0990	3		IC CMOS 4096 (4K) STAT PWR 32W-NS 3-8	34371	H01-6514-9
R3U16	1820-1730	6		IC BFF TTL LS D-TYPE FOR-EDGE-TRIG COM	01295	5074LS273H
R3U17	1820-0681	4	2	IC GATE TTL LS NAND QUAD 2-IMP	01295	5074LS00H
R3U18	1820-1199	1	4	IC INVT TTL LS HE 1-IMP	01295	5074LS04H
R3U19	1820-1204	9	1	IC GATE TTL LS NAND QUAD 4-IMP	01295	5074LS20H
R3U20	1820-1917	1	6	IC BFF TTL LS LINE DRVR OCTL	01295	5074LS24H1
R3U21	1820-0681	4		IC GATE TTL LS NAND QUAD 2-IMP	01295	5074LS00H
R3U22	1820-2075	4	2	IC HISC TTL LS	01295	5074LS245H
R3U23	1820-121e	3		IC DCAF TTL LS 3-TO-3-LINE 3-IMP	01295	5074LS135H
R3U24	1820-121e	3		IC DCAF TTL LS 3-TO-3-LINE 3-IMP	01295	5074LS135H
R3U25	1820-2075	4		IC HISC TTL LS	01295	5074LS245H
R3U26	1820-1917	1		IC BFF TTL LS LINE DRVR OCTL	01295	5074LS24H1
R3U27	1820-1917	1		IC BFF TTL LS LINE DRVR OCTL	01295	5074LS24H1
R3U28	1810-0280	8		NETWOPI-RES 10-SIP10 0 OHM 9	01121	2104103
R3U29	1820-1917	1		IC BFF TTL LS LINE DRVR OCTL	01295	5074LS24H1
R3U30	1810-0238	7	3	NETWOPI-RES 16-DIP100 0 OHM 8	11236	761-7-9100
R3U31	1810-0338	7		NETWOPI-RES 16-DIP100 0 OHM 8	11236	761-7-9100
R3U32	1820-1917	1		IC BFF TTL LS LINE DRVR OCTL	01295	5074LS24H1
R3U33	1810-0338	7		NETWOPI-RES 16-DIP100 0 OHM 8	11236	761-7-9100
R3U34	1820-1425	6		IC SCHMITT-TRIG TTL LS NAND QUAD 2-IMP	01295	5074LS120H
R3U35	08250-80007	11	1	E FROM 641 PROGRAMMED	2646H	08250-80007
R3U36	1820-1197	9		IC GATE TTL LS NAND QUAD 2-IMP	01295	5074LS00H
R3U37	1902-0551	1		DIODE-ZNF 6 2V SW PD=1W IF=100W	2646H	1902-0551
R3W1	0159-0005	11	1	RESISTOR-ZEPO OHMS 22 5W LG LEAD DIA	2646H	0159-0005
R3X1	0410-0787	1	1	CRYSTAL-QUARTZ 10 7 MHZ HC-16 U-HOLDER	2646H	0410-0787
				NO MISCELLANEOUS PARTS		
	1480-0073	6	2	PIN-POLL 062-IN-DIA 25-IN-LG BE-CU	2646H	1480-0073
	4040-0751	6	1	E TR-PC BD ORN PCLIC 062-BD-TH MS	2646H	4040-0751

See introduction to this section for ordering information  
 \*Indicates factory selected value

### A3 MICROPROCESSOR, CIRCUIT DESCRIPTION

The circuits on the A3 Microprocessor assembly form a microprocessor-based machine that controls the internal operation of the 8350B and RF Plug-in installed. A block diagram of A3 is shown in Figure 8-25. Control of the 8350B is implemented over two separate bus systems— the Front Panel Bus and Instrument Bus. Each bus consists of the following logic lines.

- Control Lines — Control direction and timing of data transfer and provide status information.
- Address Lines — Designates device or memory location of data transfer to/from microprocessor.
- Data Lines — Bi-directional logic lines used for communicating between the microprocessor and memory or input/output devices.

The Microprocessor uses the Front Panel Bus to read information from the front panel keyboard and Rotary Pulse Generators (RPGs), and write information to the front panel displays and annunciators. The Instrument Bus is used for communicating with the A4 Scaling and Marker, A5 Sweep Generator, A8 HP-IB Interface, and the RF Plug-in.

The Clock Generation circuit provides the two-phase clock for the microprocessor and other timing signals for the remaining circuits on the A3 assembly.

The microprocessor executes a 40K byte program stored in ROM (Read Only Memory). Three types of instructions are implemented.

- Read Data — Transfer data from ROM, RAM, or input device to internal registers in microprocessor.
- Write Data — Transfer data from internal registers to a specific location in RAM or an output device.
- Process Data — Perform arithmetic or logic operations on data loaded in internal registers.

The microprocessor address lines determine the source/destination of microprocessor data. The Address Decoder circuit decodes the high level bits of the address lines into control lines used to enable data transfers between the microprocessor and specific blocks of memory or other sections of the instrument.

The Front Panel Bus Buffer circuit provides the interface between the microprocessor and the A2 Front Panel Interface. The Instrument Bus Buffer circuit provides the interface between the microprocessor and the rest of the instrument.

Figure 8-24 is a flow chart of the program executed by the microprocessor. When the 8350B is “powered on”, or the INSTR PRESET key is pressed, the self test routine is executed. After completing this routine, the microprocessor enters an “idle” loop. The microprocessor continues in the idle loop until there is an interrupt or a status change in the front panel. The cause of an interrupt request can be the HP-IB Interface, RF Plug-in, sweep retrace, or Front Panel

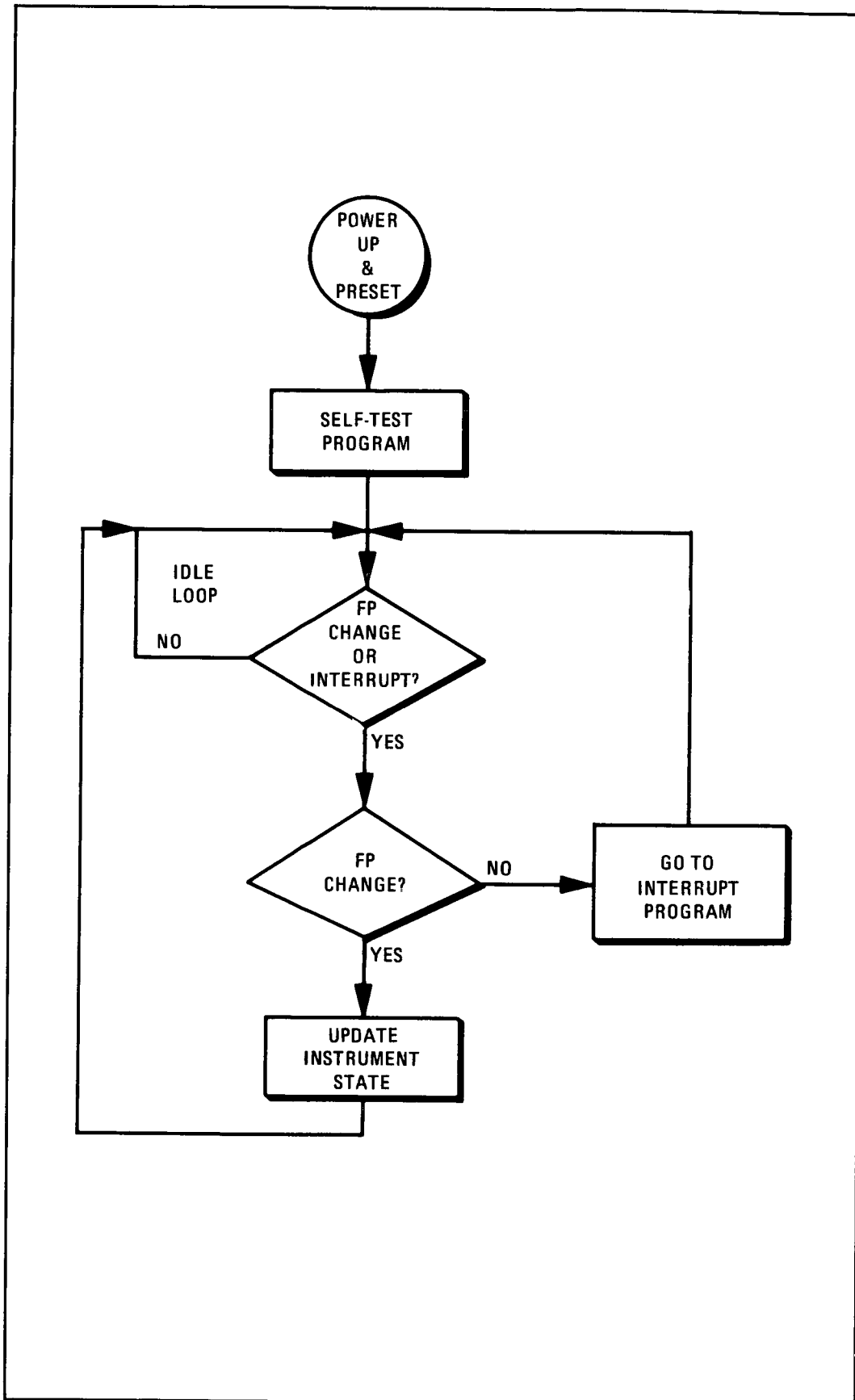

Figure 8-24. 8350B Simplified Program Routine (1 of 2)

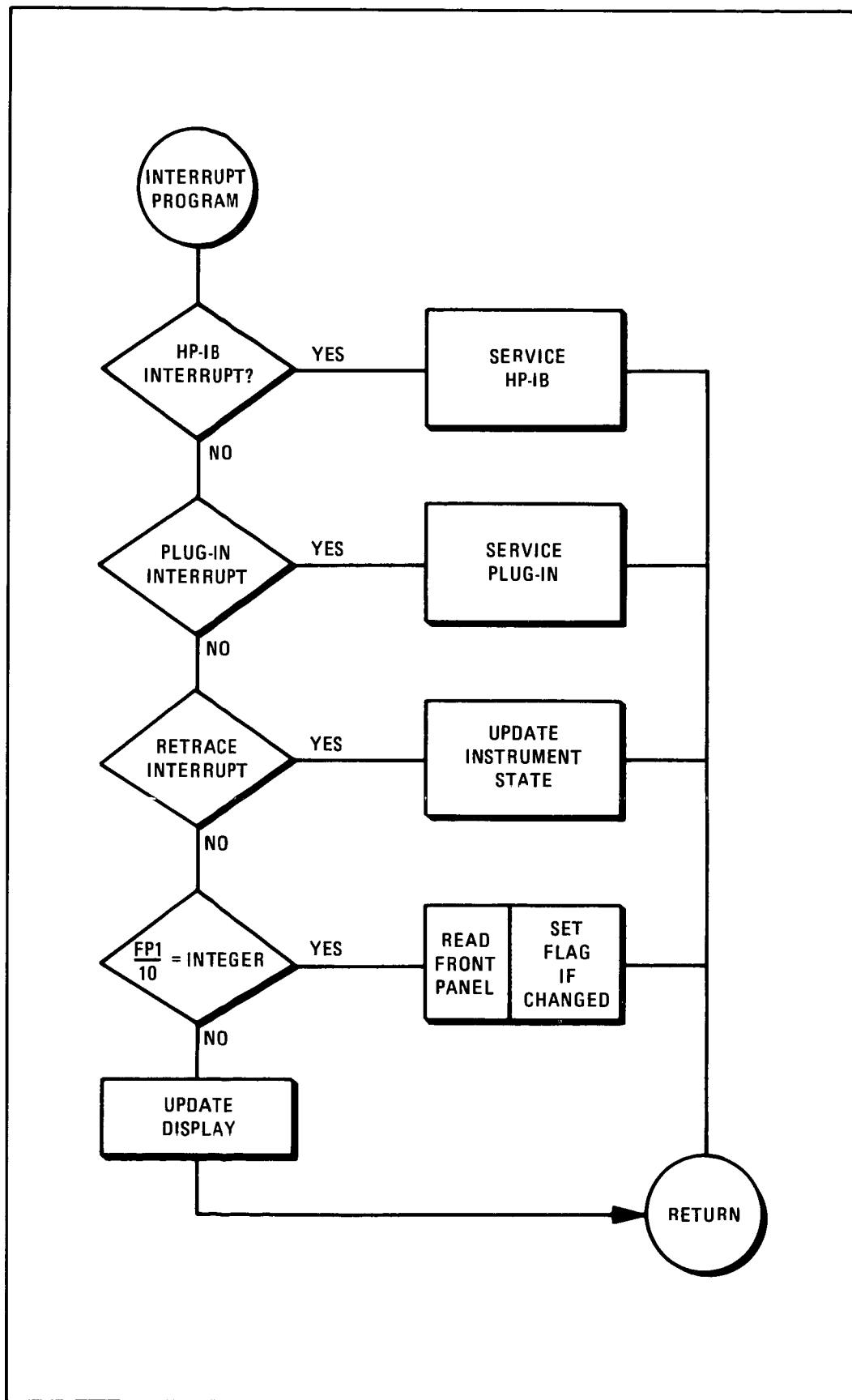

Figure 8-24. 8350B Simplified Program Routine (2 of 2)

timed interrupt. When the microprocessor is interrupted, it completes the present instruction before jumping to the interrupt service routine. During this routine, the microprocessor reads the Status Buffer to determine the source of the interrupt. The microprocessor then jumps to a service routine to communicate with the interrupting device.

### **Clock Generation** (A)

The Clock Generation circuit produces five timing signals for use on the A3 Microprocessor assembly. Phase 1 ( $\phi 01$ ) and Phase 2 ( $\phi 02$ ) outputs are a two-phase clock signal for microprocessor U5. The I/O Strobe (IOS) output is used for timing of most I/O (Input/Output) operations. The Address Valid Strobe (AVS) indicates when the microprocessor address lines are valid for decoding. The microprocessor will place data on the data lines after receiving the rising edge of the Data Bus Enable (DBE) signal. Figure 8-27 (see A3 schematic foldout) shows the timing relationship of these signals and their relationship to activity on the microprocessor address and data lines (data bus activity is shown for both a read and write operation).

**Clock Oscillator.** Crystal Y1 and logic gates U21A, U21C, and U21D form a crystal oscillator with two feedback loops. The basic oscillator is comprised of U21C, Y1, and RC phase shifters R1/C5 and R2/C6. This circuit oscillates at approximately the crystal resonant frequency of 10.7 MHz. At the oscillation frequency, the two RC phase shifters provide enough phase shift to ensure a total loop phase shift of about 360 degrees. Logic gates U21A and U21D provide bias, and stabilization. Logic gate U21B inverts and buffers the oscillator output to the Clock Generator circuit.

**Clock Generator.** Latch U16 and 32-by-8 PROM U12 form a small state machine that generates the five main timing signals. The clock oscillator output provides the time base for the state machine operation. Eleven consecutive address locations of U12 contain data that define the state of the five timing signals over eleven clock oscillator cycles. For each address, the lower four bits of data are the logic state of the PROM  $\phi 01$ , PROM  $\phi 02$ , DBE, and AVS signals. The four higher data bits address the PROM for the next clock oscillator cycle (PROM A0, PROM A1, PROM A2, and IOS). IOS is also used by the Address Decoder and Instrument Bus circuits. U16 latches and buffers the U12 outputs during each clock oscillator cycle.

**Clock Drivers.** Clock drivers Q1/Q3 and Q2/Q4 invert and buffer the PROM  $\phi 01$  and PROM  $\phi 02$  to provide the microprocessor U5 with its two-phase clock signals ( $\phi 01$  and  $\phi 02$ ). The drivers are identical, so only the circuit for  $\phi 01$  is explained. If the PROM  $\phi 01$  input is a logic low, Q1 is on and Q3 is turned off; this causes a high  $\phi 01$  output (nominally +5V). When PROM  $\phi 01$  changes state to a logic high, Q1 is turned off and Q3 is turned on; this causes  $\phi 01$  to go low (nominally 0.2V). RC combinations R3/C10 and R54/C37 at the base of Q1 and Q3 ensure fast desaturation of the transistor base-emitter junction when the transistor is turned off. Without this RC combination, the switching speed of each transistor would be much slower.

## Microprocessor D

The Microprocessor circuit executes the program stored in ROM to control the 8350B and RF Plug-in. Microprocessor U5 is the main element in this circuit, which utilizes the following signals to execute the program stored in ROM.

- **Address Lines (A0–A15)** – The microprocessor outputs sixteen address lines that specify an address location, between hexadecimal 0000 and FFFF, for the source or destination of any data transfer. Unless instructed to do otherwise, the microprocessor automatically increments the address location after each read or write operation.
- **Data Lines (D0–D7)** – The eight data lines are bi-directional and are used by the microprocessor to communicate with the address location specified by the address bus.
- **L WRITE Line** – The microprocessor L WRITE (Low=Write) output controls the direction of the data transfer on the data bus. A logic high, read, indicates a data transfer from the addressed device to the microprocessor. A logic low, write, indicates a data transfer from the microprocessor to the addressed device.
- **VMA** – The VMA (Valid Memory Address) output indicates when the Address Bus has a stable and valid address for a data transfer.

Address lines A0–A9, all data lines, and the L WRITE line all use pull-up resistors (U6, U13, and R21) to pull their high logic levels to +3.6Vdc. This ensures that the logic levels on these lines does not exceed the supply voltage of the CMOS RAM.

A low PWON input at TP23 resets microprocessor U5 at initial “power on” or whenever the front panel INSTR PRESET key is pressed. An active low L RES (Low=Reset) input to microprocessor U5, resets the microprocessor, which initializes program execution at address FFFE. (The address of the first program instruction is stored at addresses FFFE and FFFF.) The PWON (Power On) input from the A6 Rectifier is buffered by Schmitt trigger logic gates U4B and U4A to provide fast rise and fall time of the L RES microprocessor input. RC combination R14/C30 filters transient noise spikes on the PWON line.

The Data Bus Enable (DBE) input must be a logic high to enable the microprocessor to read or write data. The microprocessor has two interrupt inputs, LNMI (Low=Non-Maskable Interrupt) and LIRQ (Low=Interrupt Request). The difference between the two signals is that LIRQ is ignored (masked) by the microprocessor if an internal flag is cleared, but an active low LNMI always requires a response. When either interrupt input is active low, the microprocessor completes the instruction it is executing then immediately jumps to the Interrupt Service Routine stored in ROM.

A “Free Run Test” of the microprocessor can be performed by setting all eight sections of S1 open and grounding TP9, LDSA (Low= Digital Signature Analysis). This “Free Run Test” isolates the microprocessor from the data bus and forces a CLR B (Clear B Accumulator) instruction into the microprocessor. The result is that the microprocessor increments through its entire address field, generating signatures at various nodes of the A3 Assembly. Refer to Microprocessor Troubleshooting for more detailed information on the “Free Run Test”.

**Address Decoder** (E)

The Address Decoder decodes the high level address bits (A10–A15) into control lines that enable data transfers between the microprocessor and specific blocks of memory or other sections of the instrument. Each section that communicates with the microprocessor is given a specific block of address space. Table 8-19 lists the address space allocation for the system.

*Table 8-19. Microprocessor Address Space Allocation*

Address Space (Hex)	Amount of Space	Device	Control Line
0000-03FF	1K	RAM	L RAME2 (Low = RAM Enable 2)
0400-07FF	1K	RAM	L RAME1 (Low = RAM Enable 1)
0800-0FFF	2K	Self Test Counter	L EAC (Low = Error Annunc. Clock)
1000-17FF	2K	Status Buffer	L SBE (Low = Status Buffer Enable)
1800-1FFF	2K	Front Panel Interface	L FPE (Low = Front Panel Enable)
2000-27FF*	2K	A5 Sweep Gen/ A8 HP-IB	L I/OE1 (Low = I/O Enable 1)
2800-2FFF*	2K	RF Plug-in	L I/OE2 (Low = I/O Enable 2)
3000-37FF*	2K	A4 Scaling and Marker	L I/OE3 (Low = I/O Enable 3)
3800-3FFF*	2K	Self Test Counter	L EAR (Low = Error Annunc. Reset)
4000-5FFF*	8K	RF Plug-in ROM	L PIROME (Low = Plug-in ROM Enable)
6000-7FFF	8K	ROM	L ROM5 (Low = ROM 5)
8000-9FFF	8K	ROM	L ROM4 (Low = ROM 4)
A000-BFFF	8K	ROM	L ROM3 (Low = ROM3)
C000-FFFF	16K	ROM	L ROM1,2 (Low = ROM 1,2)
* In each of these cases the L IBE (Low = Instrument Buffer Enable) control line is also true, enabling the address and data buffers of the instrument bus buffer to be active.			



Most of the control line outputs listed in Table 8-19 are generated directly by 3-to-8 decoders U23 and U24. However, additional decoding is provided to generate the following control lines

- L RAM1 and L RAM2 are both developed from the L RAM output of U23 pin 15, and further decoding of the A10 address line (L A10 is used to generate L RAM2). Both signals are gated with IOS (Input Output Strobe) and PWON (Power On) control lines through NAND gates U19A and U19B. Because both RAM enable lines are gated with IOS, they are only allowed to be active during a data transfer. Gating with the PWON control line prevents random data from being written into RAM when the line power is turned off.
- L ROM1,2 is developed through decoding of L ROM2 (U24 pin 9) and L ROM 1 (U24 pin 7) control lines with NAND gate U3C and inverter U18B. If either of these lines is active low, L ROM1,2 goes active low

When AVS (Address Valid Strobe) and VMA (Valid Memory Address) are active high, U24 is enabled to decode address lines A13 through A15 and enable address space in 8K blocks. U23 is enabled when AVS and VMA are active high and both A14 and A15 are low (first 16K of address space). U23 decodes address lines A11 through A13 to enable address space in 2K blocks.

Two other control lines generated by the Address decoder are L IBE (Low=Instrument Buffer Enable) and II/OS (Instrument Input/Output Strobe). L IBE is active low whenever the microprocessor communicates on the Instrument Bus (Addresses 2000H through 5FFFH), and enables the address and data buffers in the Instrument Bus Buffer. The II/OS control line is a gated I/OS signal that is used to strobe data onto the Instrument Bus.

When the microprocessor Free Run test is run, TP12 can be grounded to disable the Address Decoder circuit (see A3 Troubleshooting at the end of this circuit description). The L A10 address line at TP11 is also useful for troubleshooting, and can be used to provide a pulsed source for checking shorted data or control lines.

## ROMS (F)

ROMs U9, U10, U11, and U35 store the 40K by 8 bits of program data that is executed by the microprocessor to control the rest of the 8350B and the RF Plug-in installed. ROMs U10, U11, and U35 store 8K bytes of program, and has a unique ROM enable line that enables each ROM over an 8K block address space. ROM U9 stores 16 K bytes of program information.

L ROM1,2 – Enables ROM U9 for address locations C000 through FFFF.

L ROM3 – Enables ROM U11 for address locations A000 through BFFF.

L ROM4 – Enables ROM U35 for address locations 8000 through 9FFF.

L ROM5 – Enables ROM U10 for address locations 6000 through 7FFF.

**RAMs** (H)

Data that is generated and/or processed during program execution is stored in RAM (Random Access Memory) (U14, U15, U7, and U8). Examples of the types of data stored in RAM are the present state of the front panel, the data associated with the nine SAVEn/RECALLn front panel settings, the data used to control the rest of the 8350B, the HP-IB address, the RF Plug-in code, etc.

The total RAM storage capacity is 2K by 8 bits. Since each RAM can store 1K by 4 bits, two RAMs are combined to form a 1K by 8 bit memory space. The two pair of RAMs combine to form a 2K by 8 bit memory space. One RAM in each pair (U7 and U14) store the low order four bits (D0–D3) of the data bus, and the high order bits (D4–D7) are stored by the other RAM in each pair (U8 and U15). U14 and U15 store the first 1K of data, and are enabled when control line L RAM1 (Low = RAM Enable 1) is active low. L RAM1 is active low for address locations 0000 to 03FF. U7 and U8 store the second 1K bytes of data and are enabled when control line L RAM2 is active low. L RAM2 is active low for address locations 0400 to 07FF.

The logic level of the L WRITE signal for each RAM determines if data is written to the RAM or the data stored is read by the microprocessor. When L WRITE is active low, the microprocessor writes data into the addressed RAM location. When L WRITE is active high, the microprocessor reads data from the addressed RAM location.

All four RAM power supply connections are to  $V_{CCP}$  which is the battery backup supply.

**Front Panel Bus Buffer** (J)

The Front Panel Bus Buffer circuit provides the interface for the address, data, and control lines between the microprocessor and the Front Panel Bus. The Front Panel Bus is used to transfer data between Front Panel circuits and the A3 Microprocessor Assembly. Bi-directional buffer U22 is a 3-state device that provides the interface for the eight front panel data lines (FPD0–FPD7). Transfer of data through U22 is enabled when control line L FPE (Low = Front Panel Enable) is active low. L FPE is active low for microprocessor addresses 1800 through 1FFF. Direction of data flow is determined by the logic state of the microprocessor L WRITE signal. This signal is high when reading data from the front panel and is low when writing data to the front panel. 3-state buffer U32 drives the five address lines (FPA0–FPA4), and three control lines (FPE, L FPRD, and L FPSTB) associated with the Front Panel Bus. U32 is always enabled. The front panel uses the address lines to select the source/destination of information on the data lines. The control lines manage the data flow. A more detailed functional description of these lines is provided in the A2 Front Panel Interface circuit description.

**Interrupt Logic and Status Buffer** (B)

The Interrupt Logic and Status Buffer circuit performs the following functions:

- ORs the following interrupt request signals onto the microprocessor maskable interrupt request control input, L IRQ (Low = Interrupt Request).
  - L PIIRQ (Low = Plug-in Interrupt Request)

- L IBIRQ (Low = HP-IB Interrupt Request)
- L FPIRQ (Low = Front Panel Interrupt Request) L FPIRQ also goes active low when there is a L RTCIRQ (Low = Retrace Interrupt Request). So, there is no need to multiplex L RTCIRQ to develop a L IRQ input to the microprocessor.
- Buffer the L PINMI (Low = Plug-in Nonmaskable Interrupt) signal onto the microprocessor nonmaskable interrupt control input, L NMI (Low = Nonmaskable Interrupt). L PINMI and L NMI are reserved for future use and are not used at this time.
- When addressed by the microprocessor, interface the following control lines onto the microprocessor data bus.
  - Interrupt Requests: L RTCIRQ (Low=Retrace Interrupt Request), L PIIRQ (Low = Plug-in Interrupt Request), and L IBIRQ (Low=HP-IB Interrupt Request)
  - Flags: L PIFLG (Low = Plug-in Flag), and L MFLG (Low=Marker Flag)
  - Power Supply Status: L PSF (Low=Power Supply Failure), and L PST (Low=Air Flow Failure)
  - L TEST (Low=Test): When active (TP20 jumpered to ground), initiates Front Panel Bus self test. Used if keyboard is not operational.

**Interrupt Logic.** Quad Schmitt Trigger NAND gate U34 ORs several interrupt requests onto the microprocessor interrupt request control input (L IRQ). An active low microprocessor interrupt request (L IRQ) is generated any time one of the interrupt request inputs to U34 is active low. If the microprocessor is enabled to accept interrupts, the microprocessor completes the instruction it is executing, then jumps to the Interrupt Service Routine stored in ROM. The interrupt requests may be disabled by grounding TP21, IRQE (High=Interrupt Request Enable). This forces the U34C output (L IRQ) high (not active) regardless of the state of the interrupt requests.

L PINMI (Low=Plug-In Non-Maskable Interrupt) is not used at this time but is connected to the 64 pin Plug-in interface connector for possible future use. L PINMI must never go low. A logic low on this line can only be caused by: a short on the motherboard, a shorted 64 pin Plug-in Connector, or a failure on the A3 assembly. The circuitry that receives L PINMI was designed to operate in the following manner, however, at this time no valid memory instructions reside in the L PINMI Service Routine Address. A logic low on L PINMI will place the 8350B in an undefined state. Schmitt trigger NAND gates U4C and U4D shape and buffer the L PINMI (Low=Plug-in Nonmaskable Interrupt) control line onto the microprocessor nonmaskable interrupt control input, L NMI. When L PINMI is active low, L NMI is active low, causing the microprocessor (after the current instruction is executed) to jump to the Interrupt Service Routine stored in ROM. This interrupt can not be masked, so the microprocessor always responds to an active L PINMI. L PINMI can be disabled by grounding TP16, NMIE (Nonmaskable Interrupt Enable). This forces U4D pin 13 low, causing U4D pin 11 high (not active) regardless of the state of L PINMI.

**Status Buffer.** 3-state buffer U20 buffers and inverts the Plug-in and marker flags, power supply status lines, the L TEST control line, and all but one of the interrupt requests onto the microprocessor data bus. The combination of these lines is called the status byte. When active low, the L SBE (Low=Status Buffer Enable) control line from the Address Decoder enables the status byte onto the data bus. L SBE is active low for address locations 1000 through 17FF. The microprocessor periodically reads the status byte during program execution to check the status of the two power supply status control lines, as well as the Plug-in and marker flags. If either of the power supply status lines is active low for a certain period, the microprocessor writes an error message to the front panel displays. The marker flag is monitored during the Instrument Preset and operator initiated self tests. The marker flag is active low when the marker circuits on the A4 Scaling and Marker assembly have passed the test routine. The Plug-in flag is monitored during the program idle loop, and, when active low, indicates the Plug-in requires a low priority of service (i.e. front panel update).

The microprocessor also reads the status byte following an interrupt request. The microprocessor uses the status byte to determine the source of the interrupt request. Note that L FPIRQ is not included in the status byte. If all other interrupt requests are not active, the microprocessor assumes L FPIRQ caused the interrupt request.

The L TEST input is used for front panel troubleshooting and is active low when TP20 is grounded. If L TEST is active low when the microprocessor reads the status byte, the microprocessor jumps to the Front Panel Bus self test. For more details of this test refer to the troubleshooting section for the A2 Front Panel Interface.

### **Self Test Error Code Indicator** ©

The Self Test Error Code Indicator circuit provides a pass/fail indication for the tests in the Self Test Routine (STR). The STR is initiated by any of the following actions:

- Cycling the ac line power
- Pressing the front panel [INSTR PRESET] key.
- Programming the Instrument Preset function via HP-IB.

Either of the first two actions cause the PWON (Power On) control line input to go low, which resets microprocessor U5 through U4A and U4B. This results in the microprocessor jumping to and executing the Self Test Routine. The L RES output of U4A is also buffered through NAND gate U3A, and resets the Self Test counter U2A. With all of the U2A outputs low, LEDs DS1 through DS4 are turned on. The indicator LEDs are binary weighted (8-4-2-1) with DS1 being the Most Significant Bit (MSB). An LED that is turned on indicates a logical one (1).

At the beginning of the Self Test Routine, the microprocessor ensures that the Self Test Counter is reset by setting L EAR (Low = Error Accumulator Reset) active low. The Self Test Counter remains reset until either a Self Test fails or all tests pass. If a test fails, the microprocessor executes a set of instructions to increment the Self Test Counter with L EAC (Low = Error Accumulator Clock). The microprocessor then continues execution of the test routine for the failed

test. The number of L EAC clock pulses generated is equal to 15 minus the test number. For example, if the Front Panel Bus test (Test number 6) fails, the number of L EAC transitions generated is nine (15 - 6). As a result, the Self Test Counter outputs represent the binary complement of nine and the LEDs indicate:

DS1(MSB) = OFF DS2 = ON DS3 = ON DS4(LSB) = OFF

This indication is interpreted as a six (E006) If all tests pass, the Self Test Routine generates fifteen transitions of L EAC, resulting in all of the indicator LEDs being turned off.

The Self Test Routine may also be initiated by programming the Instrument Preset function through HP-IB. Operation of the Self Test circuit is the same with the following exceptions. The microprocessor is "programmed" to reset instead of using the PWON control line, and Self Test Counter U2A is reset only by the L EAR control line.

### Supply Filtering **(K)**

The Supply Filtering circuit filters the supply voltages used by the A3 Microprocessor, and provides a protected +5V supply ( $V_{CCP}$ ) for RAM. The circuit operates in one of two states.

- When ac line power is applied to the 8350B (LINE switch in ON position), transistors Q5 through Q7 are all biased on. Thus,  $V_{CCP}$  approximately equals +5VF and the battery, BT1 (which connects to the circuit at P1-21, +5V BAT), charges through R18.
- When the 8350B ON/OFF switch is in the OFF position, transistors Q5 through Q7 are all turned off, and the source for the  $V_{CCP}$  supply is BT1. Thus the RAM is kept active when line power is disconnected.

During the transition between battery-backup and internal power for the RAM, Q5 through Q7 ensure that  $V_{CCP}$  does not drop below the battery voltage.

### Instrument Bus Buffer **(I)**

The Instrument Bus Buffer circuit interfaces the microprocessor address, data, and control lines onto the Instrument Bus, which is the main communication bus for the rest of the 8350B (except for the front panel circuits). U25 is a 3-state bi-directional buffer that provides the interface for the eight instrument data lines (ID0-ID7). Transfer of data through U25 is enabled when L IBE (Low=Instrument Bus Enable) is active low (Addresses 2000 through 5FFF). Direction of data flow is determined by the logic state of the microprocessor L WRITE control output (Low=Write, High=Read).

3-state buffers U27 and U29 drive the thirteen address lines (L IA0 through L IA12) and the L IRD (Low=Instrument Bus Read) control line associated with the Instrument Bus. The logic state of the address lines determine the source/destination of the data transfer and the logic state of L IRD determines direction of data flow at the addressed device. U27 and U29 are enabled by the L IBE control line.

3-state buffer U26 drives the remaining control lines associated with the Instrument bus, and is always enabled. Table 8-20 lists these control lines, with definition and function description. All lines associated with the Instrument Bus (except I/OE3) are reverse-terminated by 100 ohm resistors to reduce ringing.

Table 8-20. Instrument Bus Control Signals

Control Line	Definition	Function
L I/OCLK	Low = I/O Clock	Timing Clock for the A8 HP-IB Interface
L I/OSTB	Low = I/O Strobe	Master Data enable pulse for Instrument Bus
I/OE1	I/O Enable 1	Enable line for A5 Sweep Generator and A8 HP-IB Interface
I/OE2	I/O Enable 2	Enable line for RF Plug-in
I/OE3	I/O Enable 3	Enable line for A4 Scaling and Marker
PIROME	Plug-in ROM Enable	Enable line for RF Plug-in ROM

## TROUBLESHOOTING

Since the A3 Microprocessor controls all functions in the 8350B, a component failure on this board assembly generally disables the entire instrument. The most likely indications of an A3 Microprocessor component failure are as follows:

- Instrument Preset self test failure (Error codes E015 through E006)
- Front Panel Lock-up (Some or all the front panel lights are on; push-buttons produce no response.)
- Flashing Lights (Front panel lights flash in a random or periodic fashion; pushbuttons will not function properly, but may have an effect.)
- Partial Failure (The instrument works most of the time, but certain front-panel functions do not work.)

### Instrument Preset Self Test

Begin troubleshooting by initiating the Instrument Preset self test, and checking the four LEDs mounted on top of the A3 Microprocessor for an error code. When **[INSTR PRESET]** is pressed, or when ac line power is initially turned on, the four LEDs should momentarily turn on; then, either an error code should be displayed, or the four LEDs should turn off (indicating the self test is complete). In addition to indicating which Self-Test failed, the error code provides additional information about the tests that passed. Any section of circuitry

exercised by a test before the indicated failure code is very probably functioning properly and can be eliminated from further troubleshooting procedures. Table 8-2 in the General Troubleshooting section lists error codes.

A list of the error codes for the A3 Microprocessor follows:

#### NOTE

**In the event of a Front Panel failure, the four Front Panel SWEEP TRIGGER annunciators used to indicate errors may display an incorrect error code, or none at all. Check the four LEDs on the A3 Microprocessor to be certain of the error code. Press and hold down the Instrument Preset button to light ALL the LEDs and insure that none are burned out. Press Instrument Preset several times to make sure the same error code appears each time.**

**No LEDs turn on.** Self Test not initiated; LEDs do not turn on when [INSTR PRESET] key is pressed.

Check that the Power Supplies are functioning. Check that TP17 is at +5 Vdc and free of excessive digital noise. Power for the RAMs is supplied by a special circuit (Q5, Q6, and Q7) This circuit recharges the battery, and prevents it from discharging through the power supply when the power is off. Check pin 18 of the RAMs (U14, U15, U7, and U8) for slightly under 5 Vdc. Also make sure that pin 1 of U13 or U6 is at approximately 3.6 Vdc.

Next, the Clock Generation block should be checked. The Clock Oscillator output (TP27) should be a 10.7 MHz square wave. The AVS (TP4), IOS (TP10) and DBE lines are driven directly by U16, while the Phase 1 (TP2) and Phase 2 (TP1) lines are buffered by Clock Drivers Q1, Q3, Q2, and Q4. These four clock signals run at approximately 973 kHz, completing one cycle for every eleven cycles of the 10.7 MHz clock. Typical waveforms can be found in the Circuit Description section.

Check the other control lines to the microprocessor. In normal operation, L RES (pin 40), L HALT (pin 2), L NMI (pin 6 or TP8), and VCC (pin 8) should all be at 5.0 Vdc. If L NMI is low, it can be forced back high by grounding TP16. If the microprocessor then functions properly, troubleshoot the interrupt circuitry. In normal operation, L IRQ will show periodic interrupts from the Front Panel at roughly 1370 Hz, plus occasional End-of-Sweep interrupts.

**E015 Microprocessor.** All of the Error Code LEDs turn on if the microprocessor cannot execute the first (RAM) Self-Test. This can be caused by one or more of several different failures. These include malfunctioning of the microprocessor itself, a failure in ROM1,2 (Addresses C000 to FFFF) containing the Self-Test software or its enable line, or a failure in the Address or Data Busses. In most cases, the Free Run Test must be performed to isolate the failure.

**E014, E013, E012, E011 RAM.** These codes indicate a failure in RAM according to Table 8-21.

Table 8-21. RAM Error Codes

Error Code	Enable Line	Address (Hexidecimal)	Data Lines	RAM
E014	L RAM1	0400-07FF	D4-D7	U15
E013	L RAM1	0400-07FF	D0-D3	U14
E012	L RAM2	0000-03FF	D4-D7	U8
E011	L RAM2	0000-03FF	D0-D3	U7

The RAM Test checks every bit of every RAM address location for both read and write capability. The microprocessor steps through each location, reads its contents, writes the complement, and reads it back. These two words are then checked to assure that the complement was indeed written into RAM and read back. Finally, the original contents of the locations are restored. U8 and U7 are tested simultaneously. U8 contains D0 - D3 information and U7 contains D4 - D7 information. U15 and U14 are also tested simultaneously. U15 contains D0 - D3 information and U14 contains D4 - D7 information. The U8/U7 group is tested first. If an error occurs, the microprocessor determines if the most significant bits (D4-D7) or least significant bits (D0-D3) caused the error, and displays the appropriate error code. When a RAM failure is detected, the microprocessor jumps immediately to the beginning of the RAM test and starts over.

Error codes E014 through E011 occur if a RAM cell is locked high or low, or if the RAM's write capability is lost. However, this error also occurs if the RAM Control section or L WRITE line are malfunctioning. It is especially important that L RAM1, L RAM2, and the L WRITE be checked for activity, since a failure in the Address Decoder could cause a RAM error code. For example, if the error code indicates a failure in U7 or U8, there should at least be a short pulse in L RAM2 to check the first cell. If there is not, the problem is probably not in the RAM at all, but in the Address Decoder. The Free Run Test can be employed to check the Address Decoder outputs appropriate to RAM.

Also bear in mind that RAM has a power supply distinct from the 5.0 V supplies.

**E010, E009, E008, E007 ROM.** These codes indicate ROM failures as follows:

E010 - ROM 5 (6000-7FFF) - U10  
 E009 - ROM 4 (8000-9FFF) - U35  
 E008 - ROM 3 (A000-BFFF) - U11  
 E007 - ROM 1,2 (C000-FFFF) - U9

The ROM Test adds together all 8K or 16K bytes in each ROM, ignores the overflow, and compares the result against a check sum stored in a single location. If the check sum for any ROM doesn't agree, the program jumps immediately back to test the first ROM again, and does not test the remaining ROMs.



The error code isolates the problem down to the individual ROM. However, a failure in the 8K Select section of the Address Decoder could also cause the error, so the enabling lines (L ROM1,2 through L ROM5) should also be checked using the Free Run Test.

**E006 Front Panel Bus.** This error code usually indicates a failure in the A2 Front Panel Interface or A1 Front Panel assemblies. A description of the test can be found in the service section for those assemblies. However, it is possible that a failure in one of the Front Panel Bus Buffer (U22 or U32) can cause this error code.

U32 is an inverting buffer that is always enabled, therefore, the output of each buffer should be the complement of its input.

U22 is a 3-state bi-directional buffer. Check the L WRITE (TP5) and L FPE (TP6) lines for activity, and ensure that identical data appears on both the input and output sides of the buffer when the L FPE is active low.

The Free Run Test can be used to check Front Panel Bus problems related to the A3 Microprocessor. Refer to the Address Decoder and Front Panel Bus sections of the Free Run Test description.

**E005 Instrument Bus.** This error code indicates a problem in the Instrument Bus, using the Self-Test hardware located on the A8 HP-IB assembly. A full description of the test is contained in the service section for that assembly. However, the error code could also be produced by faulty Instrument Bus buffers on the A3 Microprocessor.

U26 is an inverting buffer that is always enabled; hence, inputs and outputs should be complements of each other.

U27 and U28 are inverting 3-state buffers. When enabled by L IBE, outputs should be complements of the inputs.

U25 is a bi-directional 3-state buffer enabled by L IBE and controlled by L WRITE. When enabled, inputs and outputs should be identical.

The Free Run Test can again be employed to isolate Instrument Bus errors traced back to the A3 Board. Refer to the Address Decoder and Instrument Bus sections of the Free Run Test description.

### **Free Run Test**

The "Free Run Test" is used to verify the A3 Microprocessor assembly. This test may also be used to verify portions of the microprocessor (U5) itself, provided the power supplies, power-on circuits, and clock circuits are functioning properly. This mode of testing is useful for checking the Address Decoder, the Address and Data Busses, and the ROM containing self test program instructions (A3U9).

The "Free Run Test" is initiated by setting the eight sections of S1 open, and connecting a jumper from L DSA (TP9) to GND (TP14). This isolates the microprocessor from the Data Bus, so that the program codes from ROM during normal operation have no effect. Instead, the command "Clear Register B" is continuously delivered to, and executed by, the microprocessor. In this free-run mode, the microprocessor repetitively cycles through every address location (0000 to FFFF) in sequence.

**Address Bus.** Since the microprocessor increments through all the address locations in binary sequence, the fifteen address lines should show a "divide by two" relationship. The A0 line (least significant bit) toggles at half the rate of the Phase 1 and Phase 2 clocks. A1 toggles at half the rate of A0, A2 at half that, and so on to A15 (the most significant bit) which has a period of approximately 135 ms. Check each line for activity. Any line locked high or low could be caused by a faulty microprocessor output, shorted or opened bus lines, or a faulty input at an address line termination. If the "divide by two" relationship between two adjacent lines is not observed, these lines may be shorted together.

**Address Decoding.** As the address lines are sequenced through their range, the various I/O Ports, RAMs, and ROMs are selected in turn by the Address Decoder circuitry. The proper location and duration of these pulses in relation to the A15 line is shown in the Address Decoder Timing Diagram below. These can be checked on a dual-trace oscilloscope by using a 20 ms/div sweep speed while triggering off the falling edge of the A15 line. TP12 has been provided to disable the VMA line controlling the Address Decoder. When TP12 is connected to Ground (TP14), all the enabling outputs from the Address Decoder should go high.

**Data Bus.** Since every possible I/O port and memory location is addressed while the microprocessor is in the free run mode, each of the data lines (D0 through D7) should show some activity. TP12 can be connected to GND to disable all ROM, RAM, and I/O outputs. In this condition, none of the 3-state drivers are enabled, and the Data Bus can be driven by an outside source. L A10 (TP11) is a convenient square-wave source while the microprocessor is in the Free Run Test. Connect TP12 to TP14 (DIG GND), and drive each of the data lines (D0 through D7) in turn at J3 with a jumper from TP11. Check each line at one of the Data Bus terminations (e.g. U22 or U25) for the L A10 signal. Also check all other data lines for adjacent shorts.

**Front Panel Bus.** The Front Panel bus is controlled by two buffers on the A3 Board. U32 is a uni-directional inverting buffer that is always enabled to pass five address lines and three control signals. In the Free Run Mode, the addresses cycle in binary sequence, so the "divide-by-two" sequence should be observed continuously on L FPA0 through L FPA4. FPE should show occasional bursts of activity, being an inverted version of L FPE shown in the Address Decoder Timing Diagram. L FPRD should remain in the low (read) state, and L FPSTB should strobe at roughly 973 kHz.

U22 is a bi-directional 3-state buffer passing 8 bits of data. In the Free Run Mode, this buffer is periodically enabled by L FPE to read in data. (Refer to the Address Decoder Timing Diagram.) Data is never written, since L WRITE stays high. The buffers can be easily tested by using L A10 (TP11) as an artificial source of data during Free Run. Pull the A2 Board out of the Motherboard to disconnect its data drivers. Connect TP11 to one of the Front Panel data lines (FPD0-FPD7); the extender board pins are convenient. Trigger the oscilloscope off L FPE, and observe the corresponding data line on the microprocessor side using the Data Bus test pins. The L A10 signal should pass through the buffer only when L FPE goes low and at no other times. Check all data lines for adjacent shorts.

**Instrument Bus.** The Instrument Bus terminations on the A3 Board include four buffers: one for data, two for addressing, and one for control.

U26 is always enabled and passes six inverted control signals. In the Free Run Mode, L I/OCLK should run at 973 kHz. L I/OSTB should run at the same rate, but in bursts corresponding to L IBE going low. The others — I/OE1, I/OE2, I/OE3, and PIROME — are inverted versions of the signals shown by the Address Decoder Timing Diagram.

U27 and U29 pass thirteen inverted address lines, plus L WRITE, to the Instrument Bus when L IBE is low. In the Free Run Mode, the address lines should show the usual "divide-by-two" relationship, but only when L IBE is active low. L IRD should remain low, since the microprocessor only reads during Free Run.

U25 is a bi-directional 3-state buffer also enabled by L IBE. The buffer is easily checked during Free Run. Remove the A4, A5, and A8 Assemblies from the Motherboard and remove the RF Plug-in. Connect L A10 (TP11) to the data line in question on the Instrument Bus side. By triggering off the L IBE line, the L A10 signal should be observed on the corresponding test point of the Data Bus when U25 is enabled. (Note that data is only read in.) Check all lines to eliminate the possibility of adjacent shorts.

full frequency range of the RF plug-in installed. If the 8350A fails one of the self tests, an error code is displayed (see explanation of error codes). Figure 8-8 is a flow diagram showing the tests performed during Instrument Preset. Note that the A3 Microprocessor circuits are checked initially, then the digital busses are checked. Once the digital circuits are verified, the Instrument Preset test checks the power supplies and functional operation of the Tuning Voltage, Marker, and Sweep Ramp circuits. Finally the digital interface with the RF Plug-in is checked.

- **Operator Initiated** — Operator initiated self tests are provided to aid in troubleshooting once a problem is isolated to a particular area. Most tests performed during Instrument Preset can also be initiated from the front panel. No error codes are generated by Operator Initiated self tests. Most of these tests are repetitive, and provide known conditions for exercising and checking specific circuits. Table 8-3 gives a brief explanation of each Operator Initiated self test.

### **Error Codes**

The A3 Microprocessor generates an error code if one of the self tests performed during Instrument Preset fails. An error code may be displayed at each of the following locations (See Figure 8-9).

- **A3 Microprocessor Error Code LEDs.** Primary error code indicator and is used for all error codes. If different error code indication occurs between different displays, the error code indicated by the A3 Microprocessor is correct.
- **SWEEP TRIGGER Annunciators.** Used only for error codes E015 through E006. Provides front panel indication if part of front panel is operational. Error code display is identical to display on the A3 Microprocessor. If error code is displayed, verify the same error code is displayed on the A3 Microprocessor.
- **FREQUENCY Display.** Used for error codes E016 and E005 through E001. Requires that the front panel is operational. If error code is displayed, verify the same error code is displayed on the A3 Microprocessor.

### **Troubleshooting With Self Tests**

Initial troubleshooting should begin by initiating an Instrument Preset self test and checking for error codes. This self test is automatically initiated at power on, or can be selected by pressing the INSTR PRESET key. Depending on the results of the Instrument Preset self test, proceed to the troubleshooting hints for either passing or failing this test.

### **Front Panel Display Failure**

It is possible to have a front panel failure without generating an error code. Initiate the Instrument Preset self test and check for any activity from the A3 Microprocessor LEDs. If the LEDs do not cycle on then off, the Instrument Preset was not initiated. Check the +5V power supply, then refer to the A3 Microprocessor service sheet. If the LEDs cycle on then off, this indicates that the 8350A has passed the Instrument Preset self test. The front panel display problem could be caused by the A1 Front Panel, A2 Front Panel Interface, or the RF Plug-in. Front Panel operation is verified if the front panel displays are operational without the RF Plug-in

installed. Check front panel operation as follows.

1. Remove RF plug-in.
2. Initiate Instrument Preset (Error code E001 should be displayed).
3. Press **START** key. The 8350A front panel displays should indicate a start/stop frequency sweep of 0 MHz to 10.000 GHz.

### Fail Instrument Preset

Refer to Table 8-5 for a list of error codes and troubleshooting hints.

*Table 8-5. 8350A Error Codes*

Error Code	Function Tested	Operator Initiated Test	Troubleshooting Hints
E016	Airflow	None	Check fan filter is clean and clear of obstructions.
E015	Microprocessor	None	Refer to A3 Microprocessor and A3A1 PROM board service sheets. Troubleshoot using the Free Run test.
E011-014	RAM	SHIFT 07	Refer to A3 Microprocessor service sheet. Check RAM power supply and address decoding.
E007-010	ROM	SHIFT 06	Refer to A3A1 PROM board service sheet. Check A3A1 interconnections with A3 Microprocessor. Check address decoding and power supply. Troubleshoot using the Free Run test.
E006	Front Panel Bus	SHIFT 08	Trouble may be either the A2 Front Panel Interface or the A3 Microprocessor. Refer to the A2 Front Panel Interface service sheet for troubleshooting information.
E005	Instrument Bus	SHIFT 09	Shorted or open Instrument bus lines. Isolate to assembly by removing RF Plug-in, A4 Marker and Scaling, A5 Sweep Generator, and disconnecting RF Plug-in interface cable W4 from the 8350A Motherboard. If E005 still occurs, refer to the A8 HP-IB service sheet for further troubleshooting.
E004	Power Supplies	None	Check power supply LEDs on the A7 Regulator to determine faulty power supply. Cycle power on and off with the RF plug-in removed to determine if the problem is caused by the 8350A or the RF Plug-in. Check appropriate fuses.
E003	TV/Marker	SHIFT 10	Trouble is probably with the A4 Scaling and Marker assembly. Refer to the A4 service sheet for further troubleshooting.
E002	Sweep/Marker	SHIFT 11	Marker circuit was verified in previous test. Check VRAMP output from A5 Sweep Generator. Ramp should go from 0V to about +4.2V in 3 steps. If VRAMP is verified, refer to A4 Scaling and Marker service sheet. If VRAMP is not verified, refer to A5 Sweep Generator service sheet.
E001	RF Plug-in Bus	SHIFT 12	Open Instrument Bus between 8350A and RF Plug-in Digital Interface assembly. Ensure RF Plug-in is installed and making good contact. Check RF Plug-in interface cables. Check RF Plug-in cables are making good contact. Refer to RF Plug-in Digital Interface service sheet for further troubleshooting. If 11869A Adapter is installed, refer to Adapter A1 Logic service sheet for further troubleshooting.