

ADJUSTMENTS

Introduction

The procedures in this chapter adjust the analyzer's electrical performance to the specifications of Table 1-1 in the Installation Manual (HP Part Number 08590-90003).

To fully calibrate the analyzer, all seven adjustments listed in Table 2-1 must be completed in the order shown. If one or more analyzer assemblies have been replaced or repaired, the relevant adjustment procedures should be done before performance testing the instrument. The internal CAL FREQ, CAL AMPTD, and CAL YTO DELAY must also be run.

All adjustments require access to the interior of the analyzer.

WARNING

The analyzer contains potentially hazardous voltages. Refer to the safety symbols provided on the analyzer and the general safety instructions in this manual before operating the unit with the cover removed. Ensure that safety instructions are strictly followed. Failure to do so can result in severe or fatal injury.

Table 2-1. HP 8590A Spectrum Analyzer Adjustments

Adjustment Name	Affected Assembly
Second Converter LO and Bandpass Adjustment	Second Converter A5
Third Converter LO and CAL Output Adjustment	Third Converter A9
Second IF Bandpass Amplifier and Bandpass Filter Adjustment	Second IF A10
Step Gain Assembly RF Gain Adjustment	Step Gain A12
Step Amplifier Gain Adjustment	Step Gain A12
Log Amplifier Log and Linear Adjustment	Log Amplifier A14
Crystal and LC Bandwidth Filter Adjustments	Bandwidth Filter No. 1 A11 and Bandwidth Filter No. 2 A13

Before You Start

There are three things you must do *before* attempting the adjustment procedures in this chapter:

1. Remove the analyzer's dust cover. Familiarize yourself with the safety symbols marked on the analyzer and the general safety instructions and symbol definitions given in the front of this manual.
2. Plug the analyzer into the ac power mains. Switch the analyzer on and let it warm up. If the analyzer has been stored at least 2 hours in an area where the ambient temperature is within the specified operating range (0 to 55°C), a 30-minute warmup is required. If the storage temperature was less than 0°C, warm up the analyzer for at least 2 hours.
3. Read the rest of this section before you start any of the adjustment procedures.

Test Equipment You'll Need

Table 1-2 lists the recommended test equipment needed to maintain and adjust the analyzer. Each adjustment procedure includes a list of the equipment and accessories required for that adjustment. Although Hewlett-Packard equipment is recommended, equivalent equipment may be used provided it meets the critical specifications shown in Table 1-2.

Adjustment Tools

For adjustments requiring a nonmetallic tuning tool, use fiber tuning tool, HP Part Number 8170-0033. Never try to force an adjustment control in the analyzer. This is especially critical when tuning slug-tuned inductors and variable capacitors.

Abnormal Indications During Adjustment

If the indications received during calibration do not agree with the normal conditions given in the adjustment procedures, a fault exists in your analyzer. The fault should be repaired *before* proceeding with any further adjustments. Refer to the troubleshooting and repair information in Chapter 5.

Periodically Verifying Calibration

The analyzer requires periodic verification of operation. Under most conditions of use, you should test the analyzer at least once a year. To fully verify analyzer operation and calibration, you should run the entire set of performance tests indicated in Chapter 1. When test results show proper operation and calibration, no adjustments will be needed. However, if test results indicate the instrument doesn't meet specifications, the cause should be determined and rectified. Refer to Chapter 5 before attempting recalibration.

Second Converter LO and Bandpass Adjustments

The second converter LO is adjusted for 1728.7 MHz, and the bandpass filter is adjusted for a 2050-MHz bandpass.

Equipment

Frequency Counter	HP 5342A
Comb Generator	HP 8406A
Test Cable, SMC(f) to BNC(m)	HP 11592-60001
Adapter, Type N(m) to BNC(f)	HP 1250-0780
Adapter, SMC(f) to SMC(f)	HP 1250-1113
Adapter, SMC(m) to SMC(m)	HP 1250-0827
Adapter, SMC(m) to BNC(m)	HP 1250-0831
BNC Cable, 120 cm (48 in)	HP 10503A

Additional Equipment for Option 001

Minimum Loss Adapter, 75- to 50-ohm	HP 08558-60031
BNC Cable, 30 cm (12 in), 75-ohm	HP 11652-60012
Adapter, SMA(f) to SMA(f)	HP 1250-1158
Adapter, BNC(f) to SMA(m)	HP 1250-1200

Adjustment Procedure

1. Set equipment as follows:

Frequency Counter:

Range 1750 MHz

Sample Rate Full CCW

Comb Generator:

Comb Frequency 100 MHz

Interpolation Amplitude OFF

2. Press the following analyzer keys:

PRESET (wait for preset to complete)

FREQUENCY **3** **0** **0** **MHz**

SPAN **1** **0** **0** **MHz**

AMPLITUDE **2** **0** **-dBm**

[ATTEN] **0** **dB**

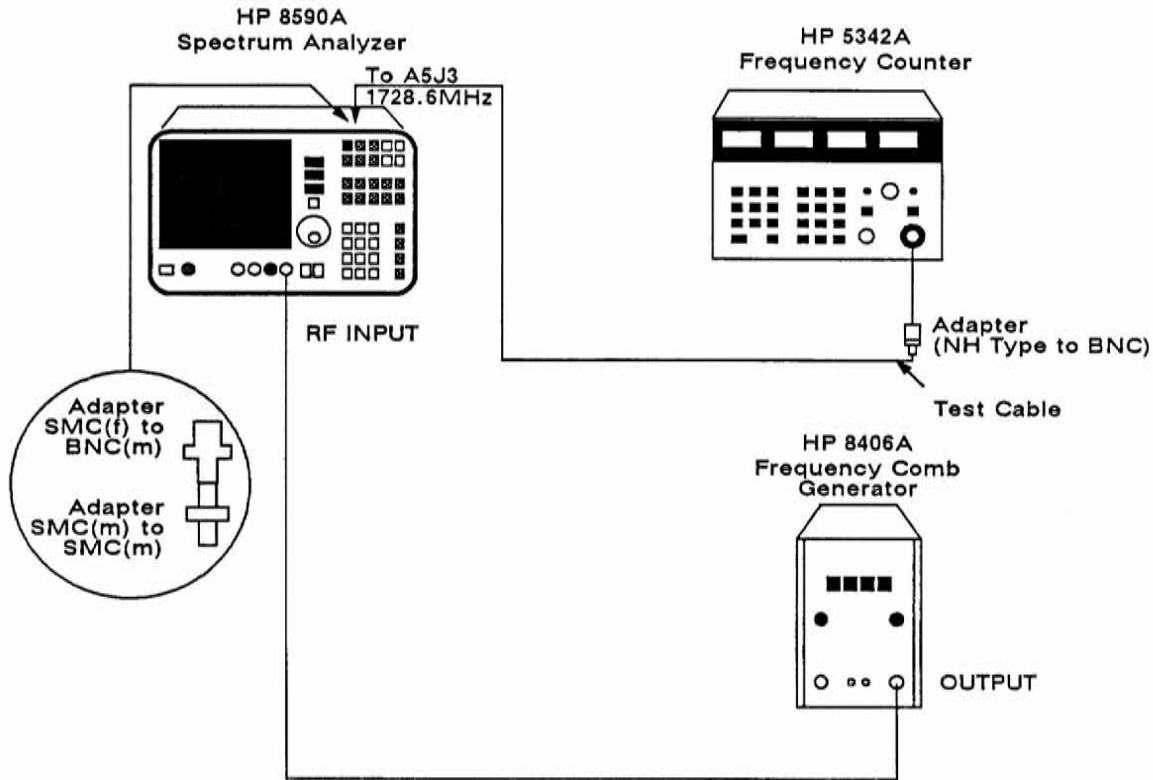

Figure 2-1. Second Converter LO and Bandpass Adjustment

3. Connect the equipment as shown in Figure 2-1. Connect the counter to the second LO test jack A5J3 at the top of Second Converter Assembly A5. Connect the comb generator to the analyzer RF input.

If your analyzer has Option 001 (75-ohm RF input), connect the 75-ohm side of the minimum loss adapter to the 75-ohm cable, connect the other end of the 75-ohm cable to the RF input of the analyzer, and connect the 50-ohm cable from the comb generator to the 50-ohm side of the minimum loss adapter.

4. Adjust the second LO frequency adjustment A5C4 for 1728.7 MHz. Use an Allen wrench through the center of the drilled-out 5/16-inch nut driver to enable the nut to be tightened without shifting frequency.
5. Set the comb generator for a 100-MHz comb.
6. Center the 300-MHz comb tooth with the RPG as necessary. Press the following analyzer keys:
SPAN 2 0 MHz
SWEEP/BW [RES BW] 3 0 0 kHz
7. Loosen the lock nuts on A5C1 and A5C2. Very carefully turn their tuning screws clockwise until they are bottomed on the cavity.

8. Turn the A5C1 and A5C2 tuning screws one turn counterclockwise and lightly tighten their lock nuts.
9. Loosen the lock nut on A5C3 and adjust the A5C3 tuning screw for peak signal on the CRT. Press **AMPLITUDE** [LINEAR] for best resolution while making final adjustments. It may also be necessary to increase amplitude on the CRT to see the signal.
10. Adjust the A5C1 for peak signal on the CRT. Reduce the REF level as necessary to keep a signal on the CRT by pressing **AMPLITUDE** and then the up arrow key (or use the numeric keypad).
11. Adjust the A5C2 for maximum signal on the CRT. Again it may be necessary to reduce the REF level to keep the signal on the CRT.
12. As tuning is completed, carefully tighten the lock nuts on the A5C1, A5C2, and A5C3 so that the signal level does not change on the CRT.
13. Adjust the A5L2 second mixer match adjustment for maximum signal on the CRT.
14. Check the second LO frequency for 1728.7. If the frequency error is greater than ± 0.5 MHz, repeat the procedure, beginning with Step 4.

Third Converter LO and CAL Output Adjustment

The third converter LO power is adjusted for $-20 \text{ dBm} \pm 1.0 \text{ dB}$ CAL output. The third LO frequency is checked for $299.9 \text{ MHz} \pm 300 \text{ kHz}$.

Equipment

Signal Generator	HP 8640B
Low Pass Filter, 300-MHz	Telonic TLP 300-4AB
Power Meter	HP 436A
Power Sensor	HP 8482A
Adapter, Type N(m) to BNC(f) (2 required)	HP 1250-0780
Adapter, Type N(f) to BNC(m)	HP 1250-0077
BNC Cable, 120 cm (48 in) (4 required)	HP 10503A

Additional Equipment for Option 001

Minimum Loss Adapter, 75- to 50-ohm	HP 08558-60031
BNC Cable, 30 cm (12 in), 75-ohm	HP 11652-60012
Adapter, SMA(f) to SMA(f)	HP 1250-1158
Adapter, BNC(f) to SMA(m)	HP 1250-1200

Adjustment Procedure

1. Set the signal generator as follows:

Output Level	-20 dBm
Frequency	299.9 MHz
AM and FM	OFF
RF	ON
Counter Mode	INT

2. Press the following analyzer keys:

(wait for preset to complete)

 [RES BW]

3. Connect the equipment as shown in Figure 2-2. Connect the analyzer CAL output to the RF input jack.
4. Press and use the RPG to center the 299.9-MHz Third LO signal on the CRT.
5. Adjust the A9L1 third converter FREQ adjustment for maximum signal amplitude.

6. Tune the signal generator to the frequency of the third converter LO ($299.9 \text{ MHz} \pm 300 \text{ kHz}$).

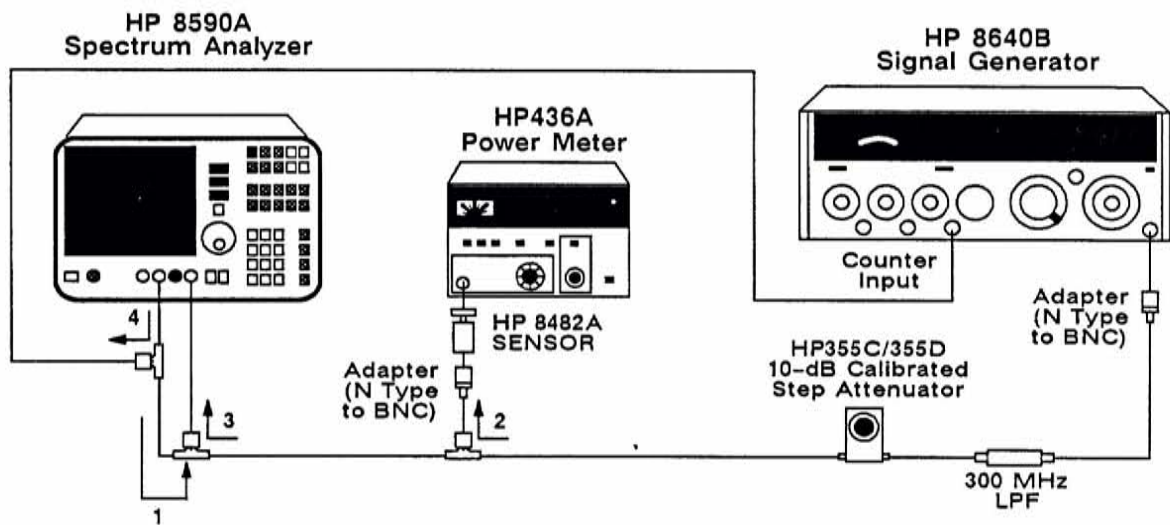

Figure 2-2. Third Converter LO and CAL Output Adjustment

7. Connect the signal generator through a 300-MHz LPF to the calibrated step attenuator. Set the step attenuator to 20 dB. Connect the power meter input to the other side of the attenuator, as shown in Figure 2-2.
8. Set the signal generator output level for $-20 \text{ dBm} \pm 1.0 \text{ dB}$ on the power meter. Leave the signal generator set at this level.
9. Connect the reference signal from Step 8 (attenuator output) to the analyzer RF input connector.
10. Set the signal from the signal generator to a convenient reference level on the analyzer display by pressing the analyzer **AMPLITUDE** key and using the RPG.
11. Adjust the A9R4 third converter calibrator level adjustment to the reference level (signal amplitude set in Step 10).
12. Connect the analyzer CAL output to the counter input of the signal generator. Set the signal generator counter mode to EXT EXPAND X10. The third LO frequency should read $299.9 \text{ MHz} \pm 300 \text{ kHz}$.

Second IF Bandpass Amplifier and Bandpass Filter Adjustment

The second IF 321.3-MHz bandpass amplifier and 321.3-MHz bandpass filter are adjusted for maximum signal amplitude.

Equipment

Signal Generator	HP 8640B
Adapter, Type N(f) to BNC(m)	HP 1250-0077
Test Cable, SMC(f) to BNC(m)	HP 11592-60001

Adjustment Procedure

1. Press the following analyzer keys:
[PRESET] (wait for preset to complete)
[FREQUENCY] [3] [2] [0] [MHz]
[SPAN] [1] [0] [0] [MHz]
[SWEEP/BW] [RES BW] [1] [MHz]
[AMPLITUDE] [1] [0] [-dBm]
[ATTEN] [0] [dB]
2. Set the signal generator to output a 321.3-MHz, -35 dBm, CW signal.
3. Remove the W15 blue cable from the second IF BPF input, A10J1. Connect the signal generator through the test cable to A10J1, as shown in Figure 2-3.
4. Adjust bandpass filter capacitors A10C1, A10C2, and A10C3 on the second IF assembly fully counter-clockwise. Press [AMPLITUDE] and adjust the RPG as necessary for an on-screen display.
5. Adjust the A10C1 for maximum signal amplitude. Make final adjustments by pressing the analyzer [AMPLITUDE] [LINEAR] keys. Use the [AMPLITUDE] setting to keep the signal on the top half of display.
6. Adjust the A10C3 for maximum signal amplitude. There may be a double peak; tune past the first peak to the second peak. The displayed signal will peak, fall off, and then peak again.
7. Repeat Steps 5 and 6, adjusting the A10C1 and A10C3 for maximum amplitude.
8. Adjust the A10C2 for maximum signal amplitude. There may be a double peak; tune to the second peak. Reduce the signal generator input level to keep the signal on the display.

Note: The value of the A10L2 is set at the factory. Its adjustment has very little effect on the signal or performance of the analyzer. In turn, A10L2 doesn't require adjustment since the position of its core is not critical.

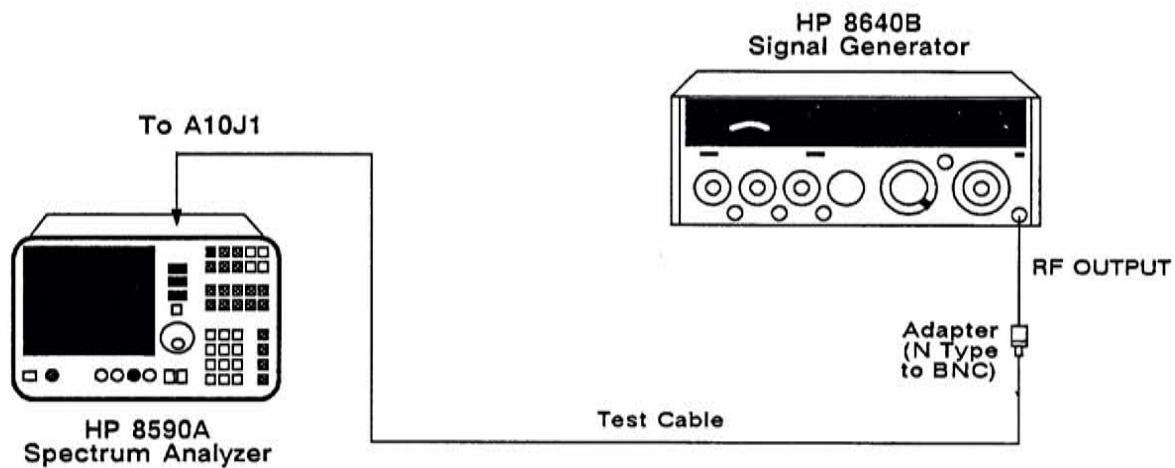

Figure 2-3. Second IF Bandpass and Bandpass Filter Adjustment

Step Gain Assembly IF Gain Adjustment

The IF gain (sensitivity) of the step gain assembly is adjusted by injecting a 21.4 MHz signal at A15XA9. The Third Converter Assembly is removed and replaced with a special extender board, used to inject the 21.4 MHz signal generator output.

Equipment

Signal Generator	HP 8640B
Power Meter	HP 436A
Power Sensor	HP 8482A
Adapter, Type N(m) to BNC(f)	HP 1250-0780
Adapter, Type N(f) to BNC(m)	HP 1250-0077
Adapter, BNC(f) to alligator clips (short leads)	HP 8120-1292
BNC Cable, 120 cm (48 in) (2 required)	HP 10503A
Special Extender Board (w/51.1 ohm resistor)	HP 08505-60109 w/HP 0757-0394

Note: To make the special extender board, solder a 51.1 ohm resistor from pin 1 (GND) to pin 5 of a standard extender board, HP Part Number 08508-60109. Leave the resistor leads long enough for easy connection of clip leads.

Adjustment Procedure

1. Press the following analyzer keys:
PRESET
SPAN 0 **Hz**
SWEEP/BW [RES BW] 3 0 **KHz**
CAL [CORRECT OFF/on]
MKR [MARKER NORMAL]
2. Connect the output of the HP 8640B through adapters to the HP 8482A power sensor. Adjust the power for -11 dBm.
3. Remove the A9 assembly and insert the special extender board. Connect the output of the HP 8640A across the 51.1 ohm resistor on the extender board using the BNC-to-clip-lead adapter. The red lead (center conductor) should be connected to extender board pin 5, and the black lead should be connected to pin 1. Ensure that the cable is run straight up at least 10 inches from the extender board to avoid pickup of unwanted signals.
4. Set the signal generator frequency for peak amplitude on the CRT display
5. Adjust the A12R4 gain (overall IF gain) adjustment for marker level of 0 dBm.
6. Remove the special extender board and replace the A9 assembly. Perform CAL AMP routine.

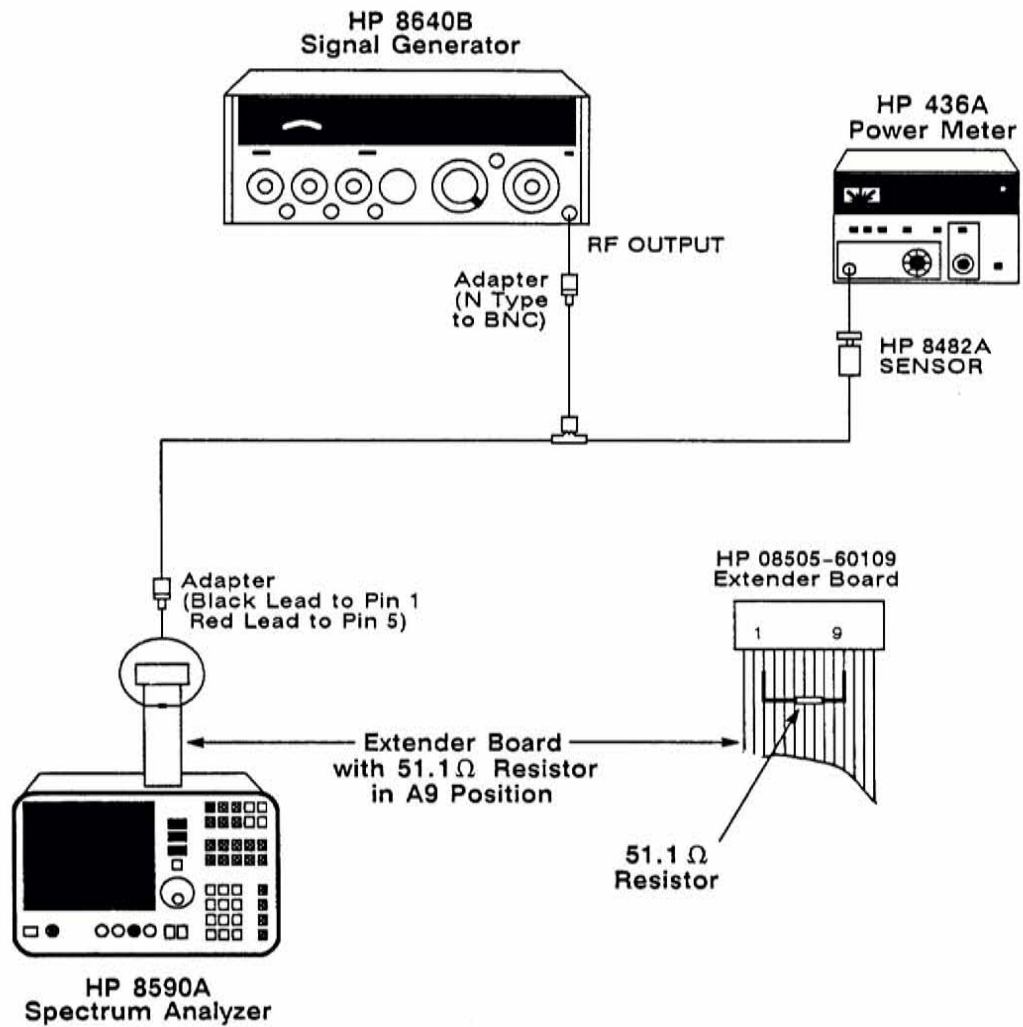

Figure 2-4. Step Gain Assembly RF Gain Adjustment Test Setup

Step Amplifier Gain Adjustments

Amplifier gain steps of 0 dB, 20 dB, and 40 dB are adjusted.

Equipment

Signal Generator	HP 8640B
Power Meter	HP 436A
Power Sensor	HP 8482A
10-dB Step Attenuator	HP 355D-H82
Adapter, Type N(m) to BNC(f)	HP 1250-0780
Test Cable, SMC(f) to BNC(m)	HP 11592-60001
Adapter, SMC(m) to SMC(m)	HP 1250-0827
BNC Cable, 120 cm (48 in) (2 required)	HP 10503A

Adjustment Procedure

1. Press the following analyzer keys:

PRESET (wait for preset to complete)
FREQUENCY **3** **0** **0** **MHz**
PEAK SEARCH [NEXT PEAK]
SIGNAL TRACK
SPAN **1** **0** **MHz**
SWEEP/BW [RES BW] **1** **MHz**
SWEEP/BW [VID BW] **1** **MHz**
AMPLITUDE [LOG dB/DIV] **1** **dB/DIV**

2. Connect the equipment as shown in Figure 2-5. Set the signal generator to output a 321.3-MHz, -14 dBm, CW signal. Connect the signal generator to one side of a 10-dB step attenuator.
3. Disconnect cable W16 from the A9J1. Connect the other side of the 10-dB step attenuator to the A9J1 using the test cable.
4. Tune the signal generator frequency for peak amplitude on the display (near 321.3 MHz). Adjust the signal generator output level for a signal level of -10 dBm on the analyzer display.
5. Set the step attenuator to 10 dB and press the following analyzer keys:
AMPLITUDE **1** **0** **-dBm**.
6. Adjust the A12R19 10 dB adjustment for a signal level of -20 dBm on the analyzer display.
7. Set the step attenuator to 20 dB and press the following analyzer keys:
AMPLITUDE **2** **0** **-dBm**.

8. Adjust the A12R2 20 dB adjustment for a signal level of -30 dBm on the analyzer display.

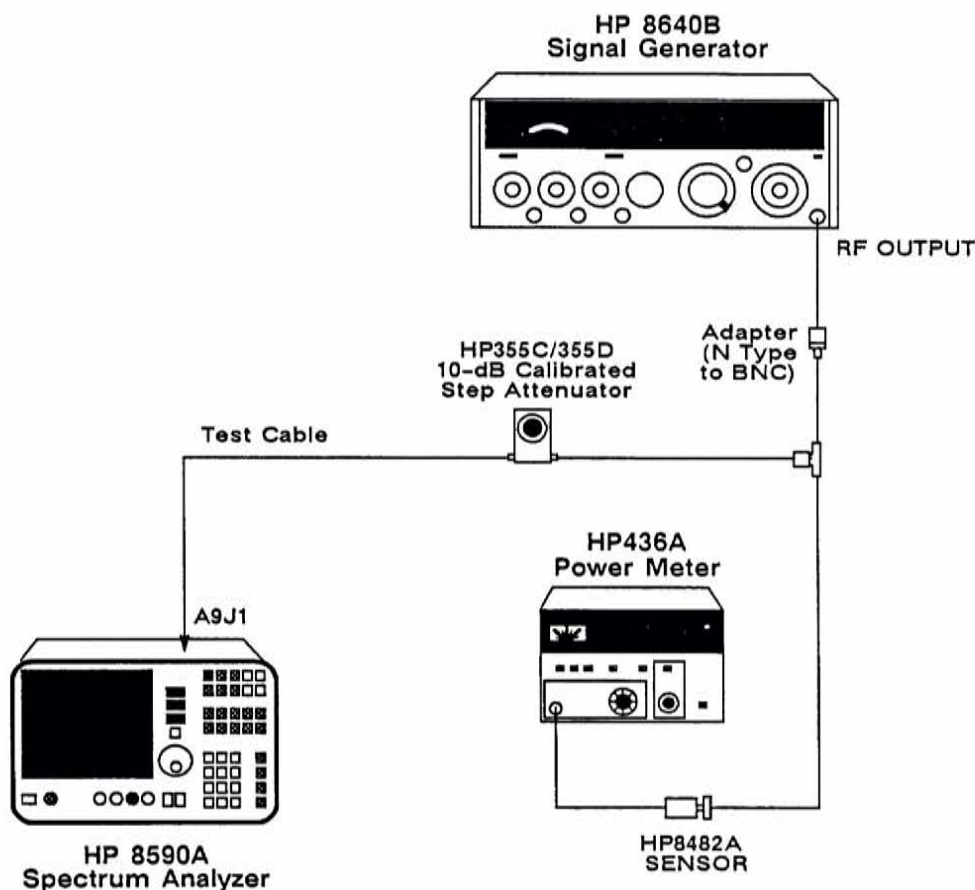

Figure 2-5. Step Amplifier Gain Adjustment Test Setup

9. Set the step attenuator to 40 dB and press the following analyzer keys:
AMPLITUDE 4 0 -dBm.

Note: Increasing the amount of video filtering might help reduce noise. Set the video filter so noise is reduced but the signal amplitude remains unchanged.

10. Adjust the A12R1 40-dB adjustment for a signal level of -50 dBm on the analyzer display.
11. Check the REF level settings from 0 to -50 dBm, as shown in Table 2-2.
12. Disconnect the step attenuator and reconnect cable W16 to the A9J1.

Adjustments

Table 2-2. Reference Level Control Check

Reference level (dBm)	Attenuator Setting (dB)	Reference Deviation
0	0	Ref. _____ mV
-10	10	± 0.5 Division
-20	20	± 0.5 Division
-30	30	± 0.5 Division
-40	40	± 0.5 Division
-50	50	± 0.5 Division

Log Amplifier Log and Linear Adjustment

Step attenuators are used to change, in calibrated steps, the input signal level of the spectrum analyzer. The AUX VIDEO output on the rear panel is monitored, and adjustments are performed to calibrate the Log Amplifier Assembly A14.

Equipment

Signal Generator	HP 8640B
Digital Voltmeter	HP 3456A
10 dB Step Attenuator	HP 355D-H82
1 dB Step Attenuator	HP 355C-H80
Adapter, Type N(m) to BNC(f)	HP 1250-0780
Test Cable, SMC(f) to BNC(m)	HP 11592-60001
Cable Assembly, Banana Plug to Alligator Clip	HP 11102A
BNC Cable, 120 cm (48 in) (2 required)	HP 10503A
BNC Cable, 20 cm (9 in)	HP 10502A

Adjustment Procedure

1. Set the digital voltmeter as follows:

Range	10
Function	DC VOLTS
Trigger	INTERNAL
Math	OFF
Auto Cal	ON

2. Press the following analyzer keys:

```

PRESET
FREQUENCY 2 0 0 1 Hz
CAL [CORRECT OFF] [MORE] [CAL FLATNESS] [STP GAIN ZERO]
TRACE A [CLEAR WRITE A]
SPAN 0 kHz
SWEEP/BW [RES BW] 1 0 kHz
AMPLITUDE 1 0 -dBm [LINEAR]

```

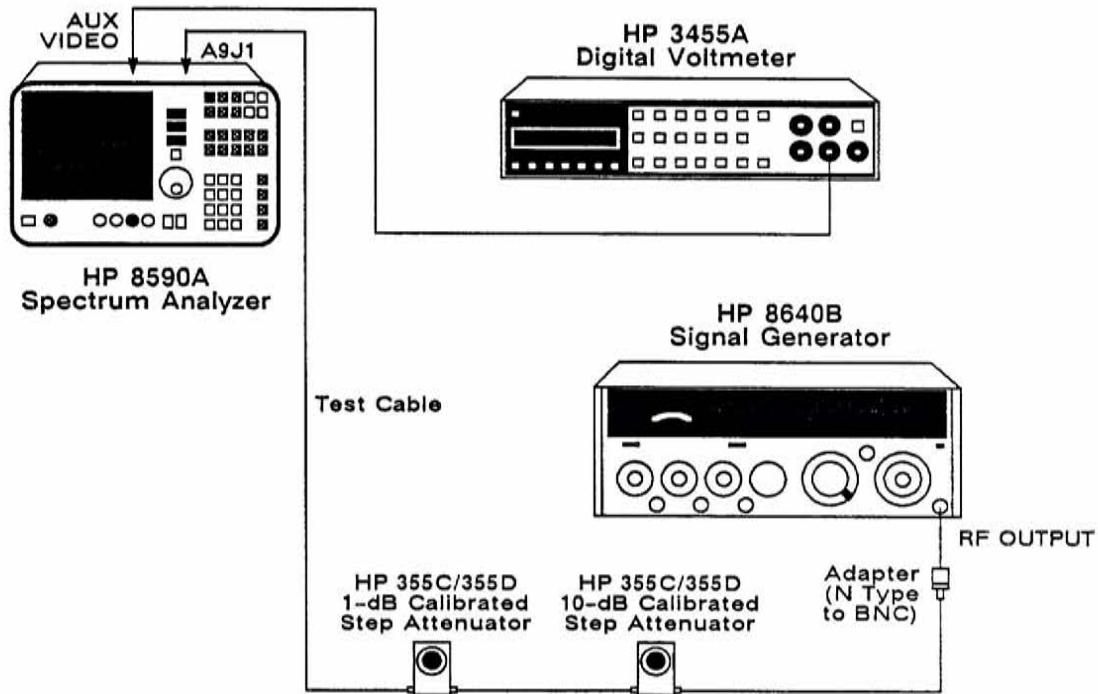

Figure 2-6. Log Amplifier Log and Linear Adjustment

3. Connect the equipment as shown in Figure 2-6. Set the 1-dB step attenuator to 10 dB. Set the signal generator frequency to 321.3 MHz and the output level to -13 dBm. Remove the W16 (red cable) from the A9J1. Connect the signal generator output through the step attenuators and the test cable to the A9J1.
4. Tune the signal generator frequency for maximum signal amplitude on the display, with the 10-dB step attenuator set to 0 dB. It may be necessary to reduce the signal generator output level slightly.
5. Disconnect the signal generator output from the step attenuator. Measure the offset at the AUX VIDEO output on the rear panel and record for later reference: _____ mV.
6. Connect the signal generator to the step attenuator and adjust the signal generator fine-tune control to peak the signal on the analyzer display.
7. Adjust the signal generator output level for DVM reading (± 1.0 mV) of 1000 mV plus the offset recorded in Step 5, as measured at the AUX VIDEO output on the rear panel.
8. Press the following analyzer keys:
AMPLITUDE [LOG dB/DIV] 1 0 dB/DIV.
9. Set the 10-dB step attenuator to 0 dB and adjust the A14R23 slope for a DVM reading (± 1 mV) of 1000 mV plus the offset recorded in Step 5, as measured at the AUX VIDEO output on the rear panel.

10. Set the 10 dB step attenuator to 60 dB and adjust the A14R10 offset for the DVM reading (± 1 mV) of 250 mV plus the offset recorded in Step 5, as measured at the AUX VIDEO output on the rear panel.
11. Repeat Steps 9 and 10 until no further adjustment is necessary.
12. Set the 10 dB step attenuator to 30 dB and adjust the A14R23 slope for a DVM reading (± 1 mV) of 625 mV plus the offset recorded in Step 5, as measured at the AUX VIDEO output on the rear panel.
13. Set the 10 dB attenuator to 0 dB and adjust the A14R69 -30 dB for a DVM (± 1 mV) of 1000 mV plus the offset recorded in Step 5, as measured at the AUX VIDEO output on the rear panel.
14. Repeat Steps 12 and 13 until no further adjustment is necessary.
15. Set the 10 dB step attenuator to 10 dB and adjust the A14R23 slope for a DVM reading of 875 mV ± 1 Mv plus the offset recorded in Step 5, as measured at the AUX VIDEO output on the rear panel.
16. Set the 10 dB step attenuator to 0 dB and adjust the A14R39 -10 dB for a DVM reading (± 1 mV) of 1000 mV plus the offset recorded in Step 5, as measured at the AUX VIDEO output on the rear panel.
17. Repeat Steps 15 and 16 until no further adjustment is necessary.
18. Repeat Steps 9 through 16 until the limits in Table 2-3 are met.

Table 2-3. Log Fidelity Check

Attenuator Setting (dB)	DVM Reading*
0	Ref: 1000 ± 1 mV
10	875 ± 3 mV
20	750 ± 4 mV
30	625 ± 4 mV
40	500 ± 5 mV
50	375 ± 6 mV
60	250 ± 7 mV
70	125 ± 8 mV
* plus offset	

Linear Output and Step Gain

19. Press the following analyzer keys:

AMPLITUDE **5** **0** **-dBm**
[LINEAR]

20. Set the 10 dB step attenuator to 0 dB and adjust the A14R34 LIN for a DVM reading (± 1 mV) of 1000 mV plus the offset recorded in Step 5, as measured at the AUX VIDEO output on the rear panel.

21. Make the adjustments indicated in Table 2-4.

Table 2-4. Linear Gain Adjustments.

Adjustment	Step (dB)	Reference (dBm)	DVM Reading*
A14R34	0	-50	Ref: 1000 \pm 1 mV
A14R33	10	-60	1000 \pm 5 mV
A14R30	20	-70	1000 \pm 5 mV
A14R27	30	-80	1000 \pm 5 mV
None	40	-90	1000 \pm 30 mV

*1000 mV plus offset from Step 5

Crystal and LC Bandwidth Filter Adjustments

The crystal and LC bandwidth filter circuits are adjusted for symmetry, center frequency, and peak amplitude. Checking the 3-dB bandwidths also verifies correct operation of the bandwidth control circuitry on Analog Interface Assembly A7.

Equipment

Crystal Shorts (3 required)	See Figure 2-7
BNC Cable, 120 cm (48 in)	HP 10503A

Additional Equipment for Option 001

BNC Cable, 30cm (12 in), 75-ohm	HP 11652-60012
---------------------------------------	----------------

Note: A crystal short (Figure 2-7) consists of a .01- μ F capacitor (HP Part Number 0160-0161) and a 90.9-ohm resistor (HP Part Number 0757-0400) connected in series. Two square-terminal connectors (HP Part Number 0362-0265) are used to connect the crystal shorts across the test points.

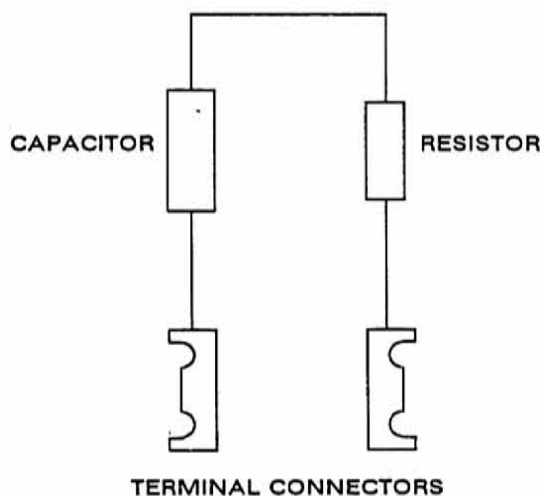

Figure 2-7. Crystal Short Configuration

Procedure

Manual See 2-8

1. Press the following analyzer keys:
PRESET (wait for preset to complete)
FREQUENCY 3 0 0 MHz
PEAK SEARCH [NEXT PK RIGHT]
SIGNAL TRACK
SPAN 2 MHz
SWEEP/BW [RES BW] 1 MHz
AMPLITUDE [ATTEN] 0 dB
AMPLITUDE 1 0 -dBm
MKR [MARKERS OFF]

Crystal Alignment

2. Connect the equipment as shown in Figure 2-8.
3. Press the menu 1 [3 dB points].
4. Check that the signal is 1 MHz \pm 200 kHz.
5. Press the following analyzer keys:
MKR [MARKERS OFF]
SPAN 5 0 kHz
SWEEP/BW [RES BW] 1 0 kHz
Press menu 1 [3 dB points]

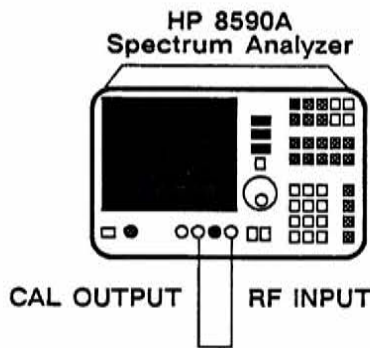

Figure 2-8. Crystal and LC Bandwidth Filter Adjustments

6. Check that the signal is 10 kHz \pm 2 kHz wide at the 3-dB points.
7. Press the following analyzer keys:
MKR [MARKERS OFF]
SPAN 2 0 0 kHz
SWEEP/BW [RES BW] 3 0 kHz

*Adjustments
1/1/1/1/1
UNIT 2-10M
8-1-1A*

8. Press the analyzer **FREQUENCY** key and use the RPG to center the signal.
 9. Press the analyzer **AMPLITUDE** key and use the RPG to place the signal at the sixth graticule line. *10-13*
- Note:** A nonmetallic tuning tool is required for adjustments on the A11 and A13 bandwidth filter assemblies.
10. Connect the crystal shorts (through cover access holes) across the following pairs of adjustment points: A13TP1/TP2, A11TP1/TP2, and A11TP4/TP5.
- Note:** Keep the crystal spike centered during adjustment. The SYM and CTR adjustments for each crystal interact.
11. Press **FREQUENCY** and use the RPG to center the bandpass spike (Figure 2-9) on the analyzer display.
 12. Adjust the A13C54 CTR for minimum signal amplitude. Then adjust the A13C38 SYM and A13C54 CTR for a centered and symmetrical bandpass, as shown in Figure 2-9.

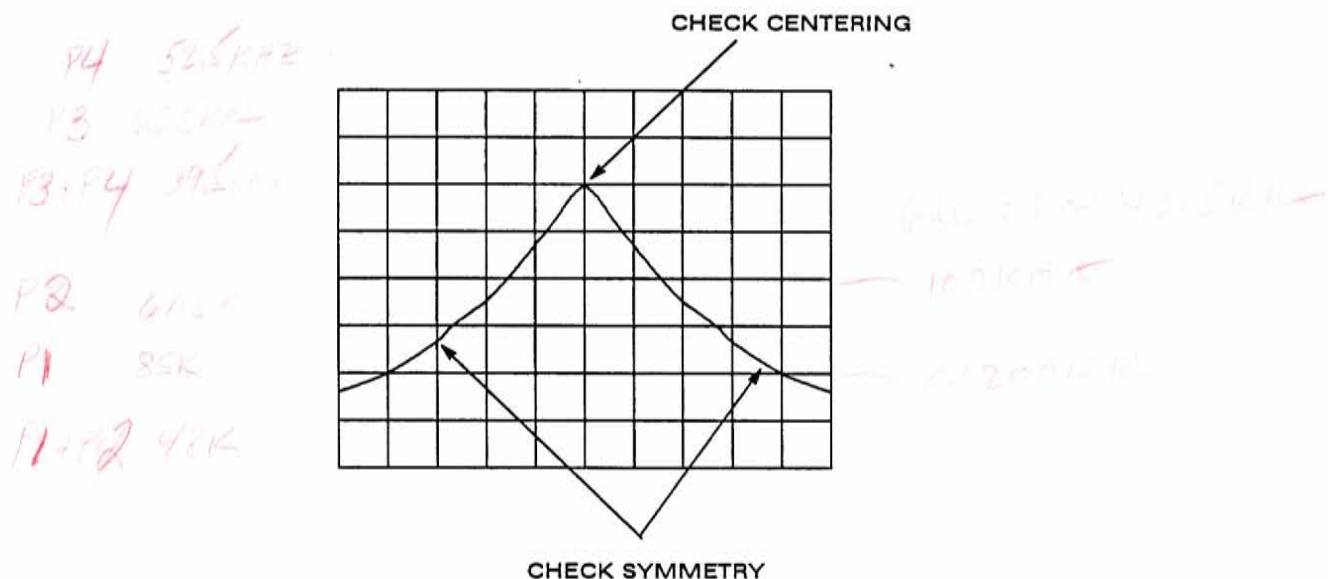

Figure 2-9. Adjusting Crystal Symmetry and Crystal Centering

13. Remove the crystal short from the A13TP1/TP2 and connect it across the A13TP4/TP5.
14. Adjust the A13C25 CTR for minimum signal amplitude. Then adjust the A13C15 SYM and A13C25 CTR for a centered and symmetrical bandpass.

Adjustments

15. Remove the crystal short from the A11TP4/TP5 and connect it across the A13TP1/TP2.
16. Adjust the A11C54 CTR for minimum signal amplitude. Then adjust the A11C38 SYM and A11C54 CTR for a centered and symmetrical bandpass.
17. Remove the crystal short from the A11TP1/TP2 and connect it across the A11TP4/TP5.
18. Adjust the A11C25 CTR minimum signal amplitude. Then adjust the A11C15 SYM and A11C25 CTR for a centered and symmetrical bandpass.
19. Remove the crystal shorts.
20. Press the following analyzer keys:
SPAN **5** **0** **kHz**
SWEEP/BW **[RES BW]** **3** **0** **kHz**
21. Press the analyzer **FREQUENCY** key and use the RPG to center the signal on the display.
22. Press the **SWEEP/BW** **[RES BW]** keys and switch between 30-kHz and 10-kHz resolution bandwidths, and back, several times. Verify that the signal shift does not exceed 3 kHz (0.6 division). If the signal shift is out of tolerance, repeat Steps 11 through 24.

LC Alignment

23. Press the following analyzer keys:
SWEEP/BW **[RES BW]** **1** **0** **0** **kHz**
SPAN **1** **MHz**

Referring to the Analog Interface Assembly A7 schematic shown in Figure 5-15, jumper the BW7 line to +15 V.

Note: When Bandwidth Filter Assemblies A11 and A13 are installed with covers in place, midjet copper alligator clips (HP Part Number 1400- 0483) can be used to short test points to the cover.

24. Perform preliminary LC filter adjustments as follows:

Note: It might be necessary to press the analyzer **AMPLITUDE** key to set the REF level to obtain an on-screen display during the following adjustment.

- a. Remove the A13 cover and install A13 on an extender board.
- b. Short the following adjustment points to ground: A13TP6, A11TP3, and A11TP6. This widens all but one pole of the LC filters.

- c. Center the signal on the analyzer display using the **FREQUENCY** control key and the RPG. Adjust the A13C73 for minimum signal amplitude.
 - d. Disconnect the short from the A13TP6 and short the A13TP3 to ground.
 - e. Adjust the A13C74 for minimum signal amplitude.
 - f. Reinstall the A13 and its cover. Disconnect the short from the A11TP3. Remove the cover from Assembly A11 and install the A11 on the extender board.
 - g. Short the A13TP6 to ground.
 - h. Adjust the A11C73 for minimum signal amplitude.
 - i. Disconnect the short from A11TP6 and short the A11TP3 to ground.
 - j. Adjust the A11C74 for minimum signal amplitude.
 - k. Disconnect the shorts from the adjustment points and reinstall the A11 and its cover.
25. Short the A11TP3, A11TP6, and A13TP3 to ground. Press the following analyzer keys:
- SWEEP/BW** [RES BW] **1** **0** **0** **kHz**
SPAN **2** **0** **0** **kHz**
26. Center the signal on the analyzer display using the **FREQUENCY** key and the RPG. Adjust the A13C451 LC CTR for symmetrical bandpass on the display. Use the RPG to keep the crystal spike centered.
27. Move the short from the A13TP3 to the A13TP6. Leave the other shorts in place. Center the signal on the analyzer display with the RPG. Adjust the A13C23 LC CTR for symmetrical bandpass on the display, keeping the crystal spike centered.
28. Move the short from the A11TP6 to the A11TP3. Leave the other shorts in place. Center the signal on the display with the RPG. Adjust the A11C45 LC CTR for symmetrical bandpass on the display, keeping the crystal spike centered.
29. Move the short from the A11TP3 to the A11TP6. Leave the other shorts in place. Center the signal on the display with the RPG. Adjust the A11C23 LC CTR for symmetrical bandpass on the display, keeping the crystal spike centered.
30. Disconnect the shorts from the A11TP6, A13TP3, A13TP6, and from ground. Ground the BW7 control line at Analog Interface Assembly A7, connector J6, pin 2.
31. Press the following analyzer keys:
- SWEEP/BW** [RES BW] **3** **0** **kHz**
SPAN **1** **0** **0** **kHz**

Press the **FREQUENCY** key and center the signal on the display using the RPG. Then press the following analyzer keys:

SWEEP/BW [RES BW] **1** **0** **0** **kHz**

Adjustments

Note where the signal crosses the center vertical graticule line on the analyzer display.

32. Adjust the A11C23, A11C45, A13C23, and A13C45 in succession, so that the amplitude of the signal is peaked where it crosses the center line on the display. Repeat Step 33 between adjustments, as necessary.
33. Repeat Steps 33 and 34 until the 30-kHz and 100-kHz bandwidths are centered with each other. If the signal shift between the 30-kHz and 100-kHz bandwidths is greater than 10 kHz (one division), repeat steps 25 through 34.

Bandwidth Amplitude

34. Press the following analyzer keys:

SWEEP/BW [RES BW] **1** **0** **0** **kHz**
SPAN **1** **MHz**

Referring to the Analog Interface Assembly A7 schematic shown in Figure 5-10, jumper the BW7 control line at connector J6, pin 2, to +15 Vdc. (A7 J6 PIN 1)

35. Short the A11TP3, A11TP6, A13TP3, and A13TP6 to ground.
36. Press the following analyzer keys:
SPAN **2** **MHz**
37. Center the signal at seven divisions on the analyzer display using the **AMPLITUDE** key and the RPG. *ADJUST AMPLITUDE*
38. Remove the shorts from the A13TP3 and A13TP6, and center the signal with the RPG. Adjust the A13R26 LC for a signal amplitude of seven divisions.
39. Remove the short from the A11TP3 and A11TP6. Adjust the A11R26 LC for a signal amplitude of seven divisions.
40. Repeat Steps 37 through 41 until no further adjustment is necessary.
41. Adjust the A11R31 and A13R31 XTL fully counterclockwise.
42. Press the following analyzer keys:
SWEEP/BW [RES BW] **1** **kHz**
SPAN **5** **0** **kHz**
Press the **FREQUENCY** key and center the signal with the RPG. Adjust the A11R31 XTL and A13R31 XTL equally for a signal amplitude of seven divisions. Each potentiometer should be adjusted to accomplish half the necessary increase in signal amplitude.
43. Remove the jumper from the BW7 line on Analog Interface Assembly A7.
44. Press the following analyzer keys:

SWEEP/BW [RES BW] **3** **MHz**
SPAN **5** **MHz**

Press the analyzer **FREQUENCY** key and use the RPG to center the signal on the display. Press the **AMPLITUDE** key and use the RPG to set the displayed amplitude of the signal to seven divisions.

45. Press the analyzer **SWEEP/BW** [RES BW] keys, and then step down from 3 MHz to 300 kHz using the down arrow key. Variation in signal amplitude should be less than ± 0.4 dB.

46. Press the following analyzer keys:

SWEEP/BW [RES BW] **1** **0** **0** **kHz**
SPAN **2** **0** **kHz**

Press the analyzer **SWEEP/BW** [RES BW] keys, and then step down from 100 kHz to 1 kHz using the down arrow key. Variation in signal amplitude should no less than ± 0.7 dB from the seventh division display reference.

47. Repeat Steps 36 through 48 until the variation in signal amplitude is within limits.

3-dB Bandwidth Check

Center frequency, amplitude, and 3-dB bandwidths of the resolution BW filters are controlled by the processor through the A7 Analog Interface Assembly. The 3-dB bandwidths are not specified, but nominal tolerances are included for purposes of checking the BW's operation and ensuring correct operation of the built-in CAL routines.

Equipment

BNC Cable, 120 cm (48 in) (2 required) HP 10503A

Additional Equipment for Option 001

BNC Cable, 30 cm (12 in), 75-ohm HP 11652-60012

Adjustment Procedure

1. Connect the analyzer CAL output to the RF input.
2. Press the following analyzer keys:
PRESET (wait for preset to complete)
PEAK SEARCH [NEXT PK RIGHT] **SIGNAL TRACK**
SPAN **5** **MHz**
AMPLITUDE **1** **0** **-dBm**
SWEEP/BW [RES BW] **1** **MHz**
[VID BW] **1** **MHz**
3. Press the following analyzer keys:
menu **1** [3 dB POINTS]
The marker Δ readout should be 1 MHz \pm 200 kHz.
4. Press the following analyzer keys:
SWEEP/BW [RES BW] **3** **MHz**
SPAN **10** **MHz**
menu **1** [3 dB POINTS]
The marker Δ readout should be 3 MHz \pm 600 kHz.
5. Press the following analyzer keys:
SWEEP/BW [RES BW] **3** **0** **0** **kHz**
SPAN **1** **MHz**
menu **1** [3 dB POINTS]
The marker Δ readout should be 300 kHz \pm 60 kHz.

6. Press the following analyzer keys:
[SWEEP/BW] [RES BW] [1] [0] [0] [kHz]
[SPAN] [3] [0] [0] [kHz]
menu [1] [3 dB POINTS]
The marker Δ readout should be 100 kHz \pm 20 kHz.
7. Press the following analyzer keys:
[SWEEP/BW] [RES BW] [3] [0] [kHz]
[SPAN] [1] [0] [0] [kHz]
[TRACE A] [VIEW A]
menu [1] [3 dB POINTS]
The marker Δ readout should be 30 kHz \pm 6 kHz.
8. Press the following analyzer keys:
[SWEEP/BW] [RES BW] [1] [0] [kHz]
[SPAN] [5] [0] [kHz]
[TRACE A] [VIEW A]
menu [1] [3 dB POINTS]
The marker Δ readout should be 10 kHz \pm 2 kHz.
9. Press the following analyzer keys:
[SWEEP/BW] [RES BW] [3] [kHz]
[SPAN] [2] [0] [kHz]
[TRACE A] [VIEW A]
menu [1] [3 dB POINTS]
The marker Δ readout should be 3 kHz \pm 600 Hz.
10. Press the following analyzer keys:
[SWEEP/BW] [RES BW] [1] [kHz] [VID BW] [1] [kHz]
[SPAN] [1] [0] [kHz]
[TRACE A] [VIEW A]
menu [1] [3 dB POINTS]
The marker Δ readout should be 1 kHz \pm 200 Hz.

