

Operating
Manual

Model 4275A
Multi-Frequency
LCR Meter



OPERATING MANUAL

MODEL HP 4275A
MULTI-FREQUENCY LCR METER

(Including Options 001, 002 and 004)

SERIAL NUMBERS

This manual applies directly to instruments with serial numbers prefixed 1843J, 1851J, 2016J, 2045J, 2148J, 2517J, 2830J.

© COPYRIGHT: YOKOGAWA-HEWLETT-PACKARD, LTD., 1979
9-1, TAKAKURA-CHO, HACHIOJI-SHI, TOKYO, JAPAN

Manual Part Number: 04275-90004
Microfiche Part Number: 04275-90054

Printed: SEP. 1990

TABLE OF CONTENTS

Section	Title	Page	Section	Title	Page
	PREFACE	1-0	3-25.	Measurement of Grounded Samples	3-18
	INTRODUCTION TO HP 4274A/4275A	1-0	3-27.	Selection of Test Cable Length	3-19
I	GENERAL INFORMATION	1-1	3-29.	Zero Offset Adjustment	3-20
	1-1. Introduction	1-1	3-31.	Actual Measuring Circuit ..	3-22
	1-4. Description	1-1	3-33.	Measured Values and Behavior of Components ..	3-23
	1-9. Specifications	1-3	3-35.	Accuracy	3-24
	1-11. Safety Considerations	1-3	3-37.	Test Signal Level Accuracy	3-24
	1-14. Instruments Covered by Manual	1-3	3-39.	Characteristics of Test Fixtures	3-34
	1-19. Options	1-3	3-41.	Deviation Measurement Function	3-35
	1-21. Option 001	1-13	3-43.	General Component Measurement	3-35
	1-23. Option 002	1-13	3-45.	Semiconductor Device Measurement	3-35
	1-25. Option 003	1-13	3-47.	External DC Bias	3-35
	1-27. Option 004	1-13	3-50.	External Triggering	3-35
	1-29. Option 101	1-13	3-52.	Options	3-51
	1-31. Special Frequency Options	1-13	3-54.	Option Annunciation	3-51
	1-33. Other Options	1-13	3-56.	Option 001 : DC Bias (0-±35V)	3-51
	1-36. Accessories Supplied	1-13	3-58.	Option 002 : DC Bias (0-±99.9V)	3-53
	1-38. Accessories Available	1-13	3-60.	Option 003 : Battery Memory Backup ...	3-54
II	INSTALLATION	2-1	3-62.	Option 004 : 1-3-5 Step Test Frequency	3-54
	2-1. Introduction	2-1	3-64.	Special Test Frequency Option	3-54
	2-3. Initial Inspection	2-1	3-66.	Option 101 : HP-IB Compatibility	3-55
	2-5. Preparation for Use	2-1	3-68.	Connection to HP-IB ...	3-55
	2-6. Power Requirements	2-1	3-70.	HP-IB Status Indicators	3-55
	2-8. Line Voltage and Fuse Selection	2-1	3-72.	LOCAL Switch	3-55
	2-10. Power Cable	2-3	3-74.	HP-IB Control Switch ..	3-55
	2-14. Interconnections	2-3	3-76.	HP-IB Interface Capabilities of 4275A Opt. 101	3-56
	2-16. Operating Environment ..	2-3	3-78.	Remote Program Code	3-56
	2-19. Installation Instructions	2-3	3-80.	DC-Bias Programming	3-56
	2-21. Installation of Options 907, 908 and 909	2-3	3-82.	Data Output	3-56
	2-23. Storage and Shipment	2-3	3-84.	Display A and Display B Data ..	3-56
	2-24. Environment	2-3	3-86.	Recall Reference Data	3-59
	2-26. Packaging	2-3	3-88.	Test Signal Level Monitor Data	3-59
	2-29. Option Installation	2-4	3-90.	Key Status Data ...	3-59
III	OPERATION	3-1	3-92.	Service Request Status Byte	3-60
	3-1. Introduction	3-1	3-94.	Programming Guide for 4275A	3-60
	3-3. Panel Features	3-1			
	3-5. Self Test (Basic Operating Check) ..	3-1			
	3-8. Measurement Function	3-7			
	3-10. Display	3-7			
	3-12. Test Signals	3-9			
	3-14. Measurement Ranges	3-10			
	3-16. Circuit Mode	3-10			
	3-19. Initial Display and Indications	3-17			
	3-21. Initial Control Settings ..	3-17			
	3-23. Unknown Terminals	3-17			

LIST OF TABLES

Number	Title	Page
1-1.	Specifications	1-4
1-2.	General Information	1-11
1-3.	Accessories Available	1-14
3-1.	Available Measurement Functions	3-7
3-2.	Measurement Parameter Formulas	3-8
3-3.	Test Signal Level and Frequencies	3-9
3-4.	Measurement Ranges and Number of Display Digits .	3-12
3-5.	Test Signal Level Check Ranges	3-10
3-6.	Dissipation Factor Equations	3-11
3-7.	Test Signal Level Monitor Accuracy	3-24
3-8.	Typical Characteristics of Test Fixtures and Leads	3-34
3-9.	Annunciation Display Meanings	3-36
3-10.	HP-IB Interface Capabilities	3-56
3-11.	Remote Program Codes	3-57
3-12.	Data Output Codes	3-59
3-13.	Sample 9825A Programs	3-60

LIST OF ILLUSTRATIONS

Number	Title	Page	Number	Title	Page
1-1.	Model 4275A and Accessories .	1-1	3-14.	Typical Impedance Locus of an Inductor	3-23
1-2.	Serial Number Plate	1-3	3-15.	Measurement Accuracies	3-25
1-3.	Dimensions of Test Fixture Contacts	1-16	3-16.	General Component Measurements	3-38
2-1.	Line Voltage and Fuse Selection	2-1	3-17.	Variable Test Parameter Measurement	3-40
2-2.	Power Cables Supplied	2-2	3-18.	Semiconductor Device Measurement	3-42
2-3.	Rack Mount Kits	2-4	3-19.	External DC Bias Circuits ..	3-45
2-4.	Option Installation	2-5	3-20.	Helpful Instructions	3-49
3-0.	Self Test Procedure	3-0	3-21.	Option Annunciation Meanings	3-51
3-1.	Front Panel Features	3-2	3-22.	DC Bias Connector	3-53
3-2.	Rear Panel Features	3-6	3-23.	HP-IB Control Switch	3-55
3-3.	Parallel and Series Parameter Relationships ..	3-11	3-24.	Status Byte of the 4275A ...	3-60
3-4.	Approximate Relationships of Sample Values to Equivalent Circuit	3-11	3-25.	Sample Program 1 with the 9825A	3-61
3-5.	Four Terminal Pair DUT Connections	3-17	3-26.	Sample Program 2 with the 9825A	3-61
3-6.	Four Terminal Pair Measurement Principle	3-18	3-27.	Sample Program 3 with the 9825A	3-62
3-7.	Test Signal Phase on Test Cables	3-19			
3-8.	Residual Parameter Effects .	3-20			
3-9.	Relationships of Residual Parameters on Additional Errors	3-21			
3-10.	Residuals Present in Measuring Circuit	3-22			
3-11.	Parasitic Impedances Incident to DUT Connections	3-23			
3-12.	Effect of Resonance in Sample	3-23			
3-13.	Impedance Vector Representation	3-23			

M A N U A L C H A N G E S

4275A

MULTI-FREQUENCY LCR METER

MANUAL IDENTIFICATION

Model Number:	4275A (OPE)
Date Printed:	JAN. 1983
Part Number:	04275-90004

This supplement contains important information for correcting manual errors and for adapting the manual to instruments containing improvements made after the printing of the manual.

To use this supplement:
 Make all ERRATA corrections.
 Make all appropriate serial number related changes indicated in the tables below.

SERIAL PREFIX OR NUMBER	MAKE MANUAL CHANGES	SERIAL PREFIX OR NUMBER	MAKE MANUAL CHANGES
ALL	ERRATA		
ALL	1		
2045J01243 and above	2		

► NEW ITEM

ERRATA

Page 3-55, Paragraph 3-70, HP-IB Status Indicator:
 Add the following note:

Note: When the 4275A is controlled via the HP-IB, LISTEN lamp may not be lit by the "remote" command (REMOTE or rem).

NOTE

Manual change supplements are revised as often as necessary to keep manuals as current and accurate as possible. Hewlett-Packard recommends that you periodically request the latest edition of this supplement. Free copies are available from all HP offices. When requesting copies quote the manual identification information from your supplement, or the model number and print date from the title page of the manual.

Date/Div: JAN. 17, 1983/33

Page 1 of 4



CHANGE 1

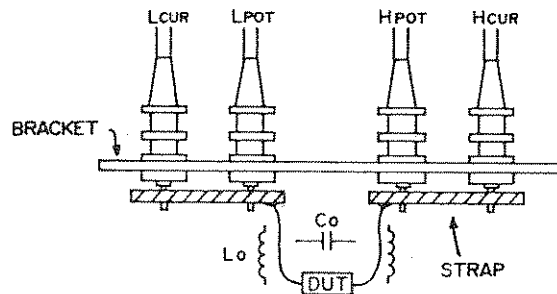
Page 2-5, Figure 2-4, Option Installation,
OPTION 101 HP-IB COMPATIBILITY:

Note

When installing Option 101 in units serial numbered 2045J00863 and above, it is not necessary to install A9U10. These units are already equipped with an Option 101 compatible A9U10.

Page 3-19, paragraph 3-27 Selection of Test Cable Length:
Change the last note on the page to read:

To minimize incremental measurements errors at frequencies above 4MHz when the UNKNOWN terminals are extended using 1 meter cables, the four-terminal-pair must be converted into a three-terminal configuration at the cable ends by shorting the Low side cables and the High side cables with low impedance straps as illustrated below. The error causing residuals, L_o and C_o , are shown in the figure. This method, however, cannot be used for inductance measurements on DUTs of from 400nH to 3 μ H when the test frequency is a special option frequency from 4MHz to 10.7MHz. In this case, the UNKNOWN terminals must not be extended using 1 meter cables; measurement must be made at the UNKNOWN terminals.



Page 3-55, paragraph 3-67:
Add the following Note to the descriptions for HP-IB:

Note

The 4275A may exhibit the following phenomena:

Phenomenon -1.

- (1) The first byte of measurement data is lost when read after Serial Polling.
- (2) The first several bytes of measurement data are lost when read after Serial Polling.

Phenomenon -2. Output measurement data from the 4275A may include two or more spaces in the first part of each string, though each data string should have only one space. Refer to paragraph 3-81 on page 3-56 for data output format.

Phenomenon -3. After Serial Polling, the status byte, which should be cleared, is not cleared from the register in the HP-IB Interface Adapter (Micro Port), A22U3.

Described below are software solutions for the above phenomena.

For Phenomenon -1 - (1):

There is no software solution.

For Phenomenon -1 - (2):

"Serial Polling (read status)" and "read one byte of measurement data" should not be executed sequentially.

For Phenomenon -2:

- 1) Read measurement data with free format.
- 2) Measurement data is read with the procedure: hold trigger--execute (trigger)--read data. However, the first measurement data of sequential measurement data is invalid.

Page 4-13, Table 4-5, Calibration Accuracy Tests:
Change the C test limits for 10pF at 10kHz, 20kHz, 200kHz and 2MHz, as follows:

CHANGE 2

The functions and capabilities of Option 003, Battery Memory Backup, and Option 101, HP-IB Compatibility, are installed in all 4275A instruments with serial numbers listed in the CHANGE table of this manual change supplement. To apply this manual to these instruments, make the following changes:

- 1) Include the specifications for Options 003 and 101, given on pages 1-9 and 1-10, in the specifications for the basic instrument.
- 2) For instructions on Battery Memory Backup and the HP-IB Compatibility, refer to the descriptions for the Options 003 and 101 (Paragraphs 3-61 and those following 3-67).
- 3) Delete "OPTION 101 ONLY" in the title of paragraph 4-27, HP-IB INTERFACE TEST. (Perform this test for all instruments.)

Herstellerbescheinigung

Hiermit wird bescheinigt, daß das Gerät HP 4275A Multi-Frequency LCR Meter in Übereinstimmung mit den Bestimmungen von Postverfügung 1046/84 funkentstört ist.

Der Deutschen Bundespost wurde das Inverkehrbringen dieses Gerätes angezeigt und die Berechtigung zur Überprüfung der Serie auf Einhaltung der Bestimmungen eingeräumt.

Anm: Werden Meß- und Testgeräte mit ungeschirmten Kabeln und/oder in offenen Meßaufbauten verwendet, so ist vom Betreiber sicherzustellen, daß die Funk-Entstörbestimmungen unter Betriebsbedingungen an seiner Grundstücksgrenze eingehalten werden.

GERÄUSCHEMISSION

LpA < 70 dB
am Arbeitsplatz
normaler Betrieb
nach DIN 45635 T. 19

Manufacturer's Declaration

This is to certify that this product, the HP 4275A Multi-Frequency LCR Meter, meets the radio frequency interference requirements of directive 1046/84. The German Bundespost has been notified that this equipment was put into circulation and was granted the right to check the product type for compliance with these requirements.

Note: If test and measurement equipment is operated with unshielded cables and/or used for measurements on open set-ups, the user must insure that under these operating conditions, the radio frequency interference limits are met at the border of his premises.

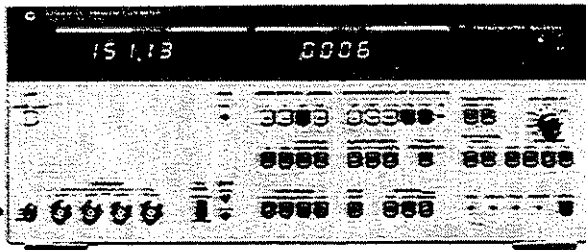
ACOUSTIC NOISE EMISSION

LpA < 70 dB
operator position
normal operation
per ISO 7779

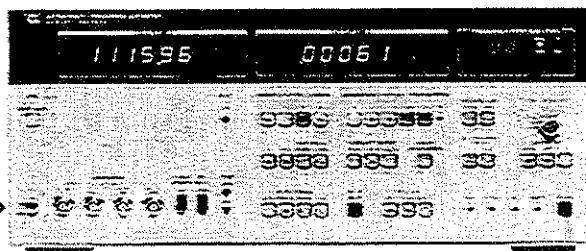
PREFACE

You are now the owner/user of the Hewlett-Packard Model 4275A Multi-frequency LCR Meter. This new component measuring instrument, developed by Hewlett-Packard, satisfies the wider measuring requirements for accuracy, speed, flexibility and versatility. Additionally, a new level of ease of operation is brought to the electronics industry. This operability both helps to up-grade the quality of product design and speeds physical and chemical research of material investigations creating a new measurement capability in these and other scientific fields. The 4275A Multi-frequency LCR Meter is the instrument which embodies these ideas and which provides these measurement advantages. Hewlett-Packard has produced two of these new LCR meters -- Models 4274A and 4275A. These units cover the lower and higher frequency regions, respectively -- and both reflect the new concepts. The Model 4275A, in particular, is an advanced LCR meter which makes high frequency component measurements simple and much easier.

4274A



4275A



INTRODUCTION TO HP MODELS 4274A/4275A

The combination of the HP Models 4274A and 4275A LCR Meter comprises a stand-alone precision LCR measuring system which covers the frequency range of 100Hz to 10MHz with a basic accuracy of 0.1%. Both instruments make the best of microprocessor advantages to achieve fully automated measurements and ease of operation. Measurement capabilities are also enhanced by the microprocessor permitting sophisticated control and powerful calculation capabilities. For all measurements, a choice of the desired test parameters in flexible combinations is enabled. A built-in multimeter displays test frequency setting, or alternatively, the test signal voltage or current for monitoring test signal level applied to DUT.

SAFETY SUMMARY

The following general safety precautions must be observed during all phases of operation, service, and repair of this instrument. Failure to comply with these precautions or with specific warnings given elsewhere in this manual violates safety standards of design, manufacture, and intended use of the instrument. Hewlett-Packard Company assumes no liability for the customer's failure to comply with these requirements.

GROUND THE INSTRUMENT

To minimize shock hazard, the instrument chassis and cabinet must be connected to an electrical ground. The instrument is equipped with a three-conductor ac power cable. The power cable must either be plugged into an approved three-contact electrical outlet or used with a three-contact to two-contact adapter with the grounding wire (green) firmly connected to an electrical ground (safety ground) at the power outlet. The power jack and the mating plug of the power cable meet International Electrotechnical Commission (IEC) safety standards.

DO NOT OPERATE IN AN EXPLOSIVE ATMOSPHERE

Do not operate the instrument in the presence of flammable gases or fumes. Operation of any electrical instrument in such an environment constitutes a definite safety hazard.

KEEP AWAY FROM LIVE CIRCUITS

Operating personnel must not remove instrument covers. Component replacement and internal adjustments must be made by qualified maintenance personnel. Do not replace components with power cable connected. Under certain conditions, dangerous voltages may exist even with the power cable removed. To avoid injuries, always disconnect power and discharge circuits before touching them.

DO NOT SERVICE OR ADJUST ALONE

Do not attempt internal service or adjustment unless another person, capable of rendering first aid and resuscitation, is present.

DO NOT SUBSTITUTE PARTS OR MODIFY INSTRUMENT

Because of the danger of introducing additional hazards, do not install substitute parts or perform any unauthorized modification to the instrument. Return the instrument to a Hewlett-Packard Sales and Service Office for service and repair to ensure that safety features are maintained.

DANGEROUS PROCEDURE WARNINGS

Warnings, such as the example below, precede potentially dangerous procedures throughout this manual. Instructions contained in the warnings must be followed.

WARNING

Dangerous voltages, capable of causing death, are present in this instrument. Use extreme caution when handling, testing, and adjusting.

CERTIFICATION

Hewlett-Packard Company certifies that this product met its published specifications at the time of shipment from the factory. Hewlett-Packard further certifies that its calibration measurements are traceable to the United States National Bureau of Standards, to the extent allowed by the Bureau's calibration facility, and to the calibration facilities of other International Standards Organization members.

WARRANTY

This Hewlett-Packard instrument product is warranted against defects in material and workmanship for a period of one year from date of shipment, except that in the case of certain components listed in Section 1 of this manual, the warranty shall be for the specified period. During the warranty period, Hewlett-Packard Company will, at its option, either repair or replace products which prove to be defective.

For warranty service or repair, this product must be returned to a service facility designated by HP. Buyer shall prepay shipping charges to HP and HP shall pay shipping charges to return the product to Buyer. However, Buyer shall pay all shipping charges, duties, and taxes for products returned to HP from another country.

HP warrants that its software and firmware designated by HP for use with an instrument will execute its programming instructions when properly installed on that instrument. HP does not warrant that the operation of the instrument, or software, or firmware will be uninterrupted or error free.

LIMITATION OF WARRANTY

The foregoing warranty shall not apply to defects resulting from improper or inadequate maintenance by Buyer, Buyer-supplied software or interfacing, unauthorized modification or misuse, operation outside of the environment specifications for the product, or improper site preparation or maintenance.

NO OTHER WARRANTY IS EXPRESSED OR IMPLIED. HP SPECIFICALLY DISCLAIMS THE IMPLIED WARRANTIES OF MERCHANTABILITY AND FITNESS FOR A PARTICULAR PURPOSE.

EXCLUSIVE REMEDIES

THE REMEDIES PROVIDED HEREIN ARE BUYER'S SOLE AND EXCLUSIVE REMEDIES. HP SHALL NOT BE LIABLE FOR ANY DIRECT, INDIRECT, SPECIAL, INCIDENTAL, OR CONSEQUENTIAL DAMAGES, WHETHER BASED ON CONTRACT, TORT, OR ANY OTHER LEGAL THEORY.

ASSISTANCE

Product maintenance agreements and other customer assistance agreements are available for Hewlett-Packard products.

For any assistance, contact your nearest Hewlett-Packard Sales and Service Office. Addresses are provided at the back of this manual.

SAFETY SYMBOLS

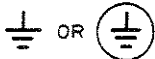
General Definitions of Safety Symbols Used On Equipment or In Manuals.



Instruction manual symbol: the product will be marked with this symbol when it is necessary for the user to refer to the instruction manual in order to protect against damage to the instrument.



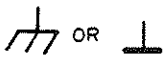
Indicates dangerous voltage (terminals fed from the interior by voltage exceeding 1000 volts must be so marked).



Protective conductor terminal. For protection against electrical shock in case of a fault. Used with field wiring terminals to indicate the terminal which must be connected to ground before operating equipment.



Low-noise or noiseless, clean ground (earth) terminal. Used for a signal common, as well as providing protection against electrical shock in case of fault. A terminal marked with this symbol must be connected to ground in the manner described in the installation (operating) manual, and before operating the equipment.



Frame or chassis terminal. A connection to the frame (chassis) of the equipment which normally includes all exposed metal structures.



Alternating current (power line).



Direct current (power line).



Alternating or direct current (power line).

WARNING

A **WARNING** denotes a hazard. It calls attention to a procedure, practice, condition or the like, which, if not correctly performed or adhered to, could result in injury or death to personnel.

CAUTION

The **CAUTION** sign denotes a hazard. It calls attention to an operating procedure, practice, condition or the like, which, if not correctly performed or adhered to, could result in damage to or destruction of part or all of the product.

Note

A **Note** denotes important information. It calls attention to a procedure, practice, condition or the like, which is essential to highlight.

MANUAL CHANGES

HP 4275A

MULTI-FREQUENCY LCR METER

MANUAL IDENTIFICATION

Model Number: HP 4275A

Date Printed: SEP. 1990

Part Number: 04275-90004

This supplement contains information for correcting manual errors and for adapting the manual to newer instruments that contain improvements or modifications not documented in the existing manual.

To use this supplement

1. Make all ERRATA corrections
2. Make all appropriate serial-number-related changes listed below

SERIAL PREFIX OR NUMBER MAKE MANUAL CHANGES

SERIAL PREFIX OR NUMBER	MAKE MANUAL CHANGES

SERIAL PREFIX OR NUMBER MAKE MANUAL CHANGES

SERIAL PREFIX OR NUMBER	MAKE MANUAL CHANGES

► **New Item**

► ERRATA

Page 3-35, Paragraph 3-71:

Change "Note" as follows;

When the 4275A is controlled via HP-IB, LISTEN lamp may not be lit by the "remote" command (REMOTE or rem).

NOTE

Manual change supplements are revised as often as necessary to keep manuals as current and accurate as possible. Hewlett-Packard recommends that you periodically request the latest edition of this supplement. Free copies are available from all HP offices. When requesting copies, quote the manual identification information from your supplement, or the model number and print date from the title page of the manual.

Date/Div: Sep. 1990/33

Page: 1 of 1



SECTION I GENERAL INFORMATION

1-1. INTRODUCTION.

1-2. This operating manual contains the information required to install, operate, and test the Hewlett-Packard Model 4275A Multi-frequency LCR Meter. Figure 1-1 shows the instrument and supplied accessories. This section covers specifications, instrument identification, description, options, accessories, and other basic information.

1-3. Listed on the title page of this manual is a microfiche part number. This number can be used to order 4 x 6 inch microfilm transparencies of the manual. Each microfiche contains up to 60 photo-duplicates of the manual pages. The microfiche package also includes the latest manual changes supplement as well as all pertinent service notes. To order an additional manual, use the part number listed on the title page of this manual.

1-4. DESCRIPTION.

1-5. The HP Model 4275A Multi-frequency LCR Meter is a high performance, fully automatic test instrument designed to measure the various component measurement parameter values of an impedance element in the relatively high frequency region. The 4275A measures inductance (L), capacitance (C), resistance (R), dissipation factor (D), quality factor (Q), conductance (G), susceptance (B), reactance (X) and, in addition, the absolute value of the vector impedance ($|Z|$) and phase angle (θ) over a wide range with high accuracy and speed. The wide range measurement capabilities of the model 4275A are enhanced by the 12 spot test frequencies selectable from 10kHz up to 10MHz in a 1-2-4-10 sequence, including two optional frequencies.

The test signal level can be flexibly set at the desired amplitude within the range of 1mV

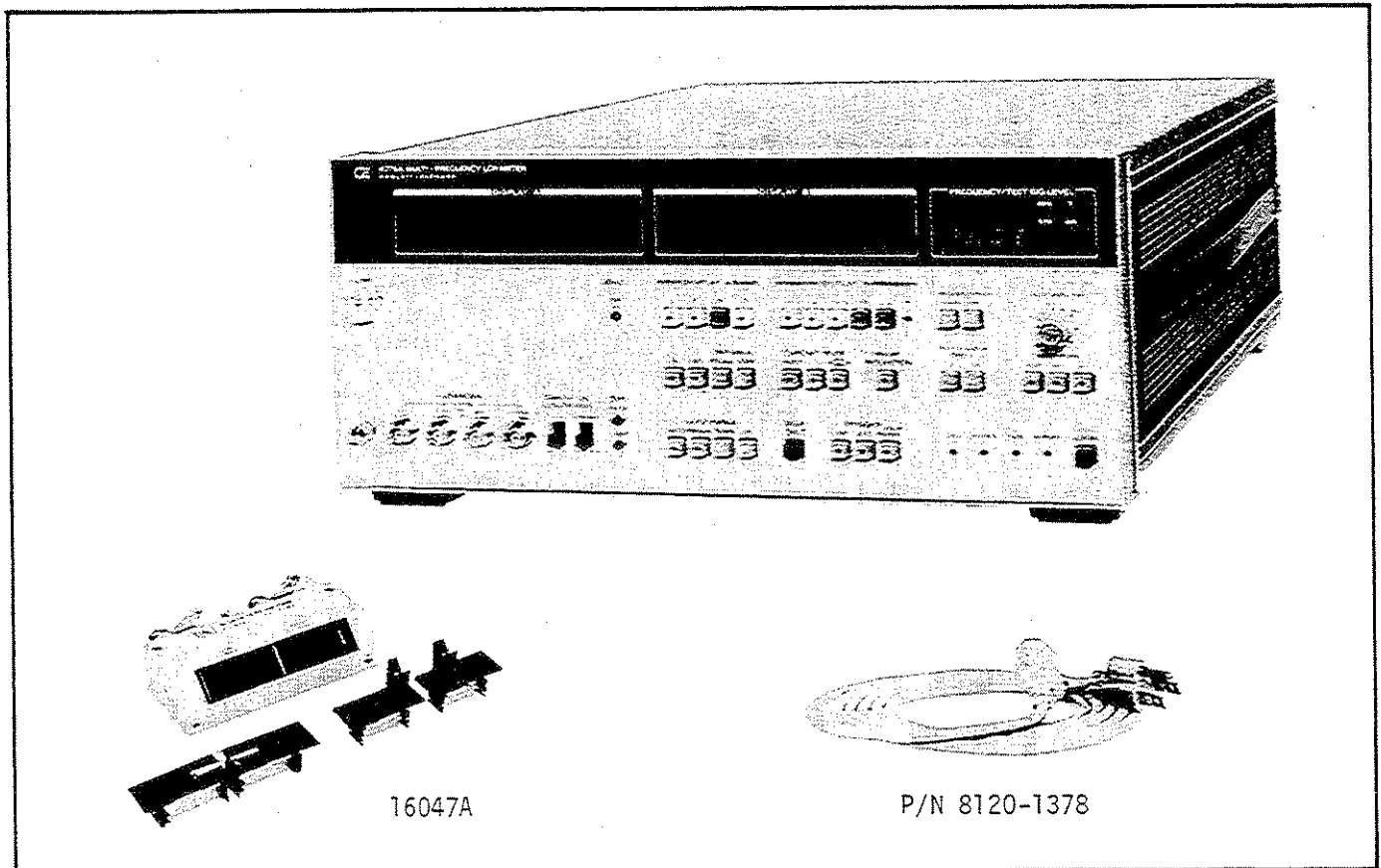


Figure 1-1. Model 4275A and Accessories.

to 1Vrms by front panel controls. The multi-spot test frequency and test level control functions featured in the 4275A permits measuring the device to be tested under the practical test conditions at which it actually operates. When it is desired to test a component for its specified performance, the 4275A can take measurements under normal operating test conditions. Thus, the 4275A is a truly versatile instrument which can respond to the diverse measurement requirements in research, circuit design, production testing and the QA inspection areas.

The other obvious advantage of the variable test signal capability is that it becomes easy to measure non-linear impedance elements whose parameters are strongly dependent on their operating conditions, such as inductors and semiconductor devices. Most significantly, the 4275A can be of particular help in the experimental assessment of devices in the semiconductor testing field.

Measured values are displayed by the two 4-1/2 digit numeric displays along with appropriate units. A high resolution operating mode provides 5-1/2 digit resolution plus lesser significant digit data by averaging the measured values every ten measurements.

The extra display section of the 4275A provides for a display of the test frequency setting, test signal voltage, or current applied to DUT in 3 digits. This built-in multi-function display allows selectable monitoring of the measuring conditions anytime during the test. Thus, the 4275A is tailored as a stand alone test instrument which offers all test parameter inputs (frequency and test voltage or current) without the help of external equipment.

1-6. The measuring range for capacitance is from 0.01fF (femto farads = 10^{-15} farads) to 199.99 μ F, inductance from 0.001nH to 199.99H, and resistance and impedance from 0.01m Ω to 19.999M Ω , all of which are measured with a basic accuracy of 0.1% to 5% depending on test signal level and frequency and at a typical measuring speed of 140 to 180 milliseconds. The measuring circuit for the device to be measured is capable of both parallel and series equivalent circuit measurement. Either dissipation factor, quality factor, equivalent series resistance, conductance, reactance, susceptance or phase angle can be selected in addition to the choice for L, C, R or |Z| measurement. The measuring range for dissipation factor is from 0.00001 to 9.9999, quality factor from 0.01 to 9000, equivalent series resistance

and reactance from 0.01m Ω to 19.999M Ω , conductance and susceptance from 0.01nS to 19.999S, and phase angle from $\pm 0.001^\circ$ to $\pm 180.000^\circ$. The measured values are displayed simultaneously with the L, C, R or |Z| measurement data. The wide range capability of the 4275A enables a measurement range from that for small capacitances such as ceramic chip capacitors and semiconductor junction capacitors to that for high capacitances such as the measurement of electrolytic capacitors to be covered. The high resolution measurement capability enables the measurement of an extremely low dissipation factor such as that of a polystyrene capacitor. A wide range of inductance measurements, from the inductance of a high frequency coil to that of an output transformer, can be made at suitable test frequencies. The wide resistance range permits measurements for low value cable conductor resistances through those for high resistance solid resistors.

1-7. The 4275A employs certain unique functions which make the best use of the intelligence capability of its microprocessor. Two Δ (delta) key functions execute capacitance, inductance, resistance, and impedance deviation measurements. These functions make possible the memorizing of a measured value as a reference value such that the subsequent display is the measurement minus the reference value or the percentage that the measurement deviates from the reference. The reference value is obtained and memorized from the preceding measurement when the instrument is set to "store" mode. A digital offset adjustment function measures residual capacitance, inductance and resistance inherent to the test fixture used, and offsets the effects of these parasitic impedances to zero with respect to the measured values. An appropriate offset compensation quantity is automatically calculated every time a measurement is taken. Any measurement error due to the test fixture is, therefore, automatically eliminated for stray capacitance up to 20pF, residual inductance up to 2000nH, resistance up to 0.5 Ω , and conductance up to 5 μ S. Use of a microprocessor also facilitates the high reliability design of the 4275A. Convenient diagnosis is feasible by merely pressing a panel pushbutton. This confirms functional operation of the instrument.

1-8. The versatile 4275A capabilities are maximized by the availability of special test fixtures, and the installation of options providing internal dc bias supply, memory backup capability, or HP-IB (IEEE-STD-488-1975) compatibility.

1-9. SPECIFICATIONS.

1-10. Complete specifications of the Model 4275A Multi-frequency LCR Meter are given in Table 1-1. These specifications are the performance standards or limits against which the instrument is tested. The test procedures for the specifications are covered in Section IV Performance Tests. Table 1-2 lists general information. General information is not specifications but is typical characteristics included as additional information for the operator. When the 4275A Multi-frequency LCR Meter is shipped from the factory, it meets the specifications listed in Table 1-1.

1-11. SAFETY CONSIDERATIONS.

1-12. The Model 4275A Multi-frequency LCR Meter has been designed to conform to the safety requirements of an IEC (International Electromechanical Committee) Safety Class I instrument and is shipped from the factory in a safe condition.

1-13. This operating and service manual contains information, cautions, and warnings which must be followed by the user to ensure safe operation and to maintain the instrument in a safe condition.

1-14. INSTRUMENTS COVERED BY MANUAL.

1-15. Hewlett-Packard uses a two-section nine character serial number which is marked on the serial number plate (Figure 1-2) attached to the instrument rear panel. The first four digits and the letter are the serial prefix and the last five digits are the suffix. The letter placed between the two sections identifies country where instrument was manufactured. The prefix is the same for all identical instruments; it changes only when a change is made to the instrument. The suffix, however, is assigned sequentially and is different for each instrument. The contents of this manual apply to instruments with the serial number prefix(es) listed under SERIAL NUMBERS on the title page.

1-16. An instrument manufactured after the printing of this manual may have a serial number prefix that is not listed on the title page. This unlisted serial number prefix indicates the instrument is different from those described in this manual. The manual

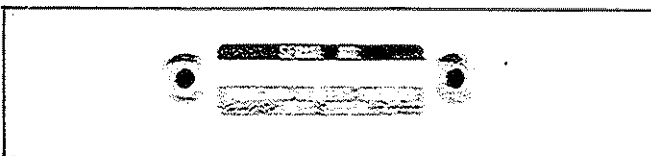


Figure 1-2. Serial Number Plate.

for this new instrument may be accompanied by a yellow Manual Changes supplement or have a different manual part number. This supplement contains "change information" that explains how to adapt the manual to the newer instrument.

1-17. In addition to change information, the supplement may contain information for correcting errors (called Errata) in the manual. To keep this manual as current and accurate as possible, Hewlett-Packard recommends that you periodically request the latest Manual Changes supplement. The supplement for this manual is identified with this manual's print date and part number, both of which appear on the manual's title page. Complimentary copies of the supplement are available from Hewlett-Packard. If the serial prefix or number of an instrument is lower than that on the title page of this manual, see Section VII Manual Changes.

1-18. For information concerning a serial number prefix that is not listed on the title page or in the Manual Change supplement, contact your nearest Hewlett-Packard office.

1-19. OPTIONS.

1-20. A total of nine options for the Model 4275A are available for adding the following capabilities:

- Option 001: Internal DC Bias Supply (0- \pm 35V).
- Option 002: Internal DC Bias Supply (0- \pm 99.9V).
- Option 003: Battery Memory Backup. Memory data protection with standby battery in event instrument loses power.
- Option 004: 1-3-5 Step Test Frequency. Test frequency selection in 1-3-5-10 sequence steps instead of the standard 1-2-4-10 sequence step fashion.
- Option 101: HP-IB Compatibility.
- Options 907, 908 and 909 are handle or rack mount kits. See paragraph 1-36 for details.
- Option 910: Extra Manual.

NOTE

Option 001 and Option 002 are mutually exclusive.

Table 1-1. Specifications (sheet 1 of 8).

SPECIFICATIONS

Parameters Measured: C, L, R, |Z|, D, Q, ESR, G, X, B, θ . Δ (deviation) and $\Delta\%$ (percent deviation) for C, L, R, |Z|.

Measurement Circuit Modes: Auto, Series and Parallel.

Parameter Combinations:

	C-D or Q or ESR
Series circuit mode	L-D or Q or ESR
	R-X or L
	Z - θ

	C-D or Q or G
Parallel circuit mode	L-D or Q or G
	R-B or C
	Z - θ

Display: Normal mode: 4-1/2 digit, maximum display 19999.
High resolution mode: 5-1/2 digit, maximum display 199999.

(Number of significant digits displayed changes depending on measurement frequency, test signal level and measurement range).

Measurement Terminals: Four terminal pair configuration (high and low terminals for current and potential terminals) with guard terminal.

Range Modes: Auto and Manual (up-down).

Measurement Frequencies: 10kHz, 20kHz, 40kHz, 100kHz, 200kHz, 400kHz, 1MHz, 2MHz, 4MHz and 10MHz $\pm 0.01\%$.

Test Signal Level: 1mV to 1Vrms, continuously variable in 3 ranges.
Test voltage and current can be monitored at front panel display.

Deviation Measurement: When REF VALUE STORE button is pressed, the existing measured value is stored as a reference value. Next, pressing Δ or $\Delta\%$ button offsets displayed value to zero. Deviation is displayed as the difference between the referenced value and subsequent result.
(Deviation spread in counts is -199999 to 199999 or from -199.99% to 199.99%).

Offset Adjustment: Stray capacitance, residual inductance, resistance and conductance of test fixture or test leads can be compensated for as follows:

C: up to 20pF
L: up to 2000nH
R: up to 0.5 Ω
G: up to 5 μ S

Self Test: Performs cyclic operation of internal function tests and displays diagnostic code sets (when any abnormality is detected).

DC Bias: Two external DC bias input connectors on rear panel, maximum ± 35 V and ± 200 Vdc.

Bias input characteristics:
100 $\Omega \pm 10\%$, 0.1A max (for max ± 35 V input).
150k $\Omega \pm 10\%$, 1.3mA max (for max ± 200 V input).

DC Bias Monitor: Bias voltage monitor output (for both internal and external biases), BNC connector, output impedance 30k Ω .

Trigger: Internal, external or manual.

GENERAL

Operating Temperature and Humidity: 0 $^{\circ}$ C to 55 $^{\circ}$ C at 95% RH (to 40 $^{\circ}$ C).

Power Requirements: 100/120/220V $\pm 10\%$, 240V +5% - 10%, 48 - 66Hz.

Power Consumption: 165VA max with any option.

Dimensions:

425.5(W) x 188 (H) x 574 (D) mm
(16-3/4" x 7-3/8" x 22-5/8")

Weight: Approximately 18kg (Std).

Table 1-1. Specifications (sheet 2 of 8).

Range and Accuracy:

Accuracies apply under the following measurement conditions for all test parameters:

- 1) Warm-up time: at least 30 minutes.
- 2) Test signal level setting:
MULTIPLIER: X 1 or X 0.1
OSC LEVEL: Fully clockwise
- 3) CABLE LENGTH switch setting:
"0" position.
- 4) ZERO offset adjustment appropriately completed.
- 5) Environmental temperature:
23°C ±5°C
(At 0°C to 55°C, error doubles).

6) Significant display readout should be more than 20 counts.

7) Measurement ranges in normal mode except those specifically noted.

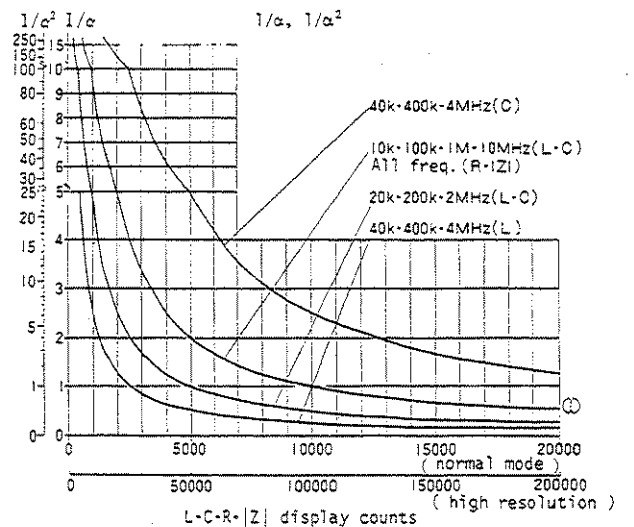
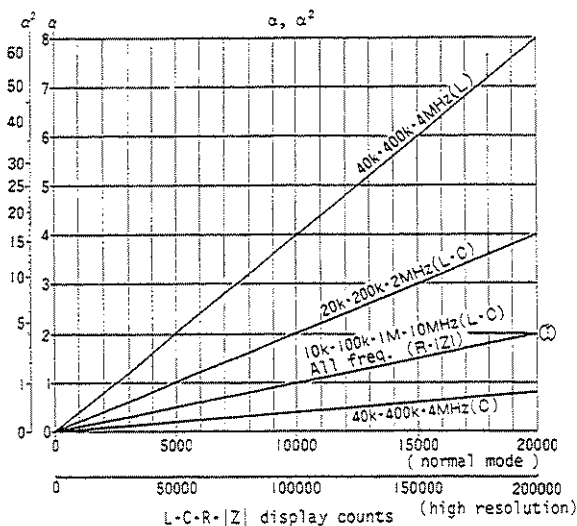
Accuracy in table is ±(% of rdg + error counts + residual counts) except for D and θ:

D accuracy:
±(% of rdg + D error value + count)

θ accuracy:
±degrees

Error count applies to significant display readouts (neglects less significant digit data).

ACCURACY COEFFICIENTS



(Horizontal axis scales represent display counts in DISPLAY A and vertical axis scales represent accuracy coefficients $\alpha, \alpha^2, 1/\alpha$ and $1/\alpha^2$.)

Table 1-1. Specifications (sheet 3 of 8).

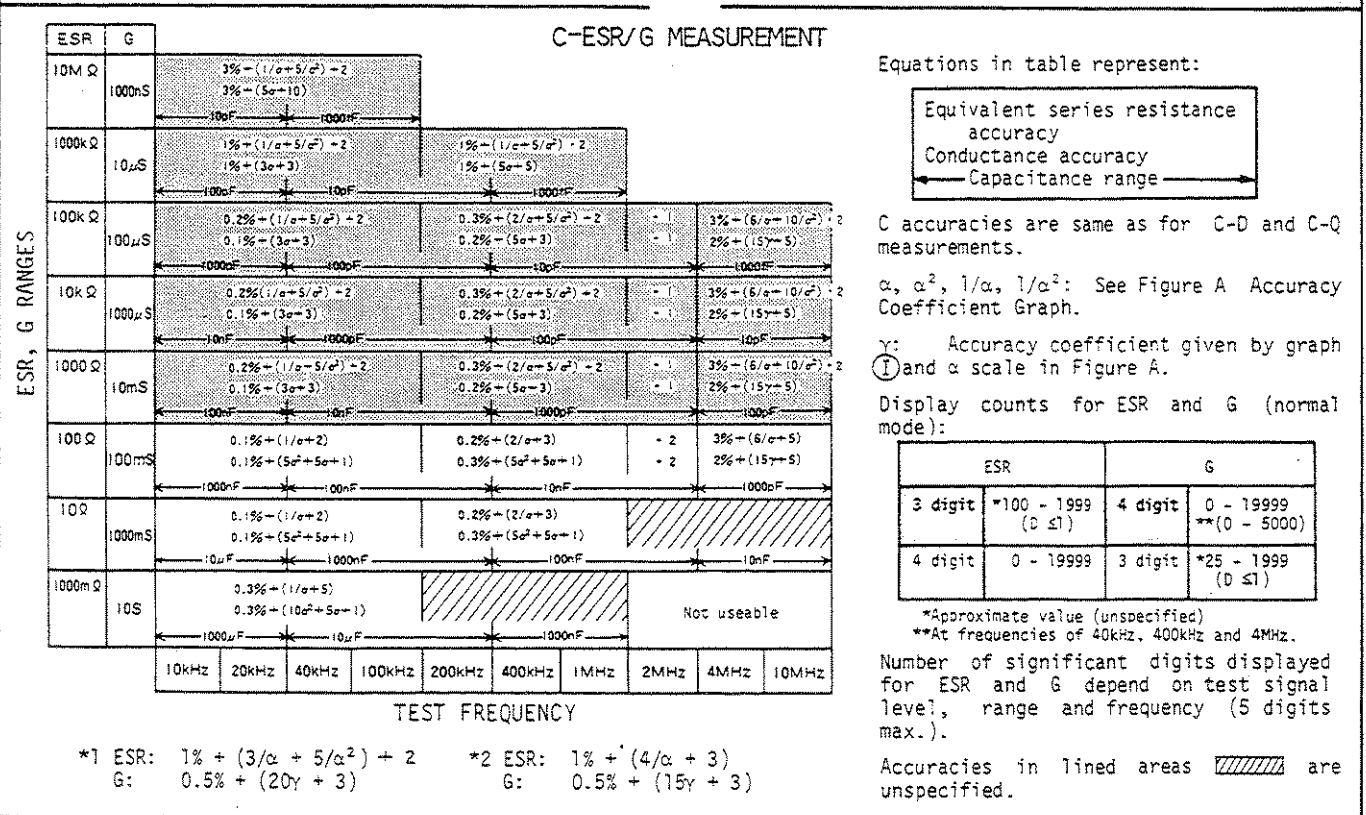
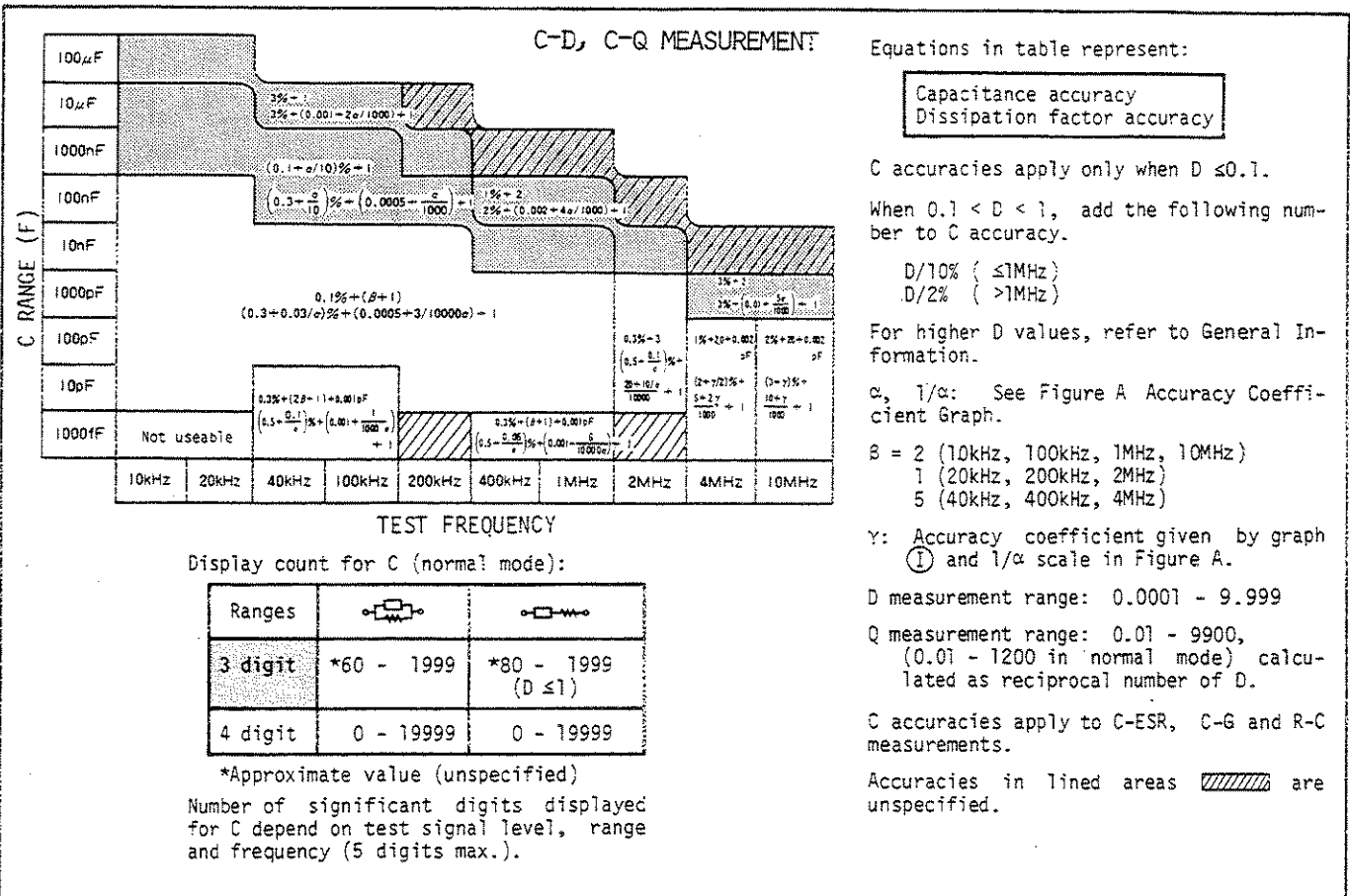


Table 1-1. Specifications (sheet 4 of 8).

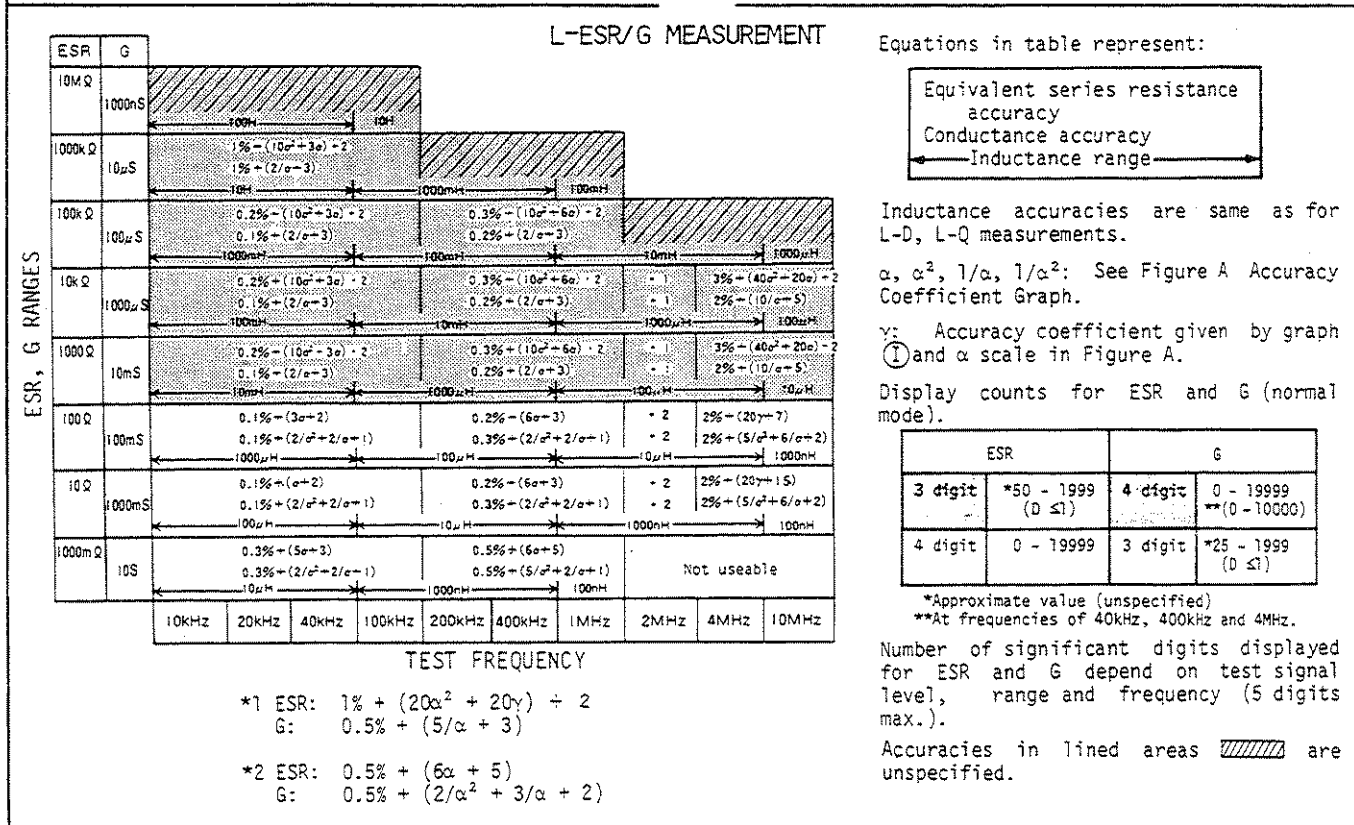
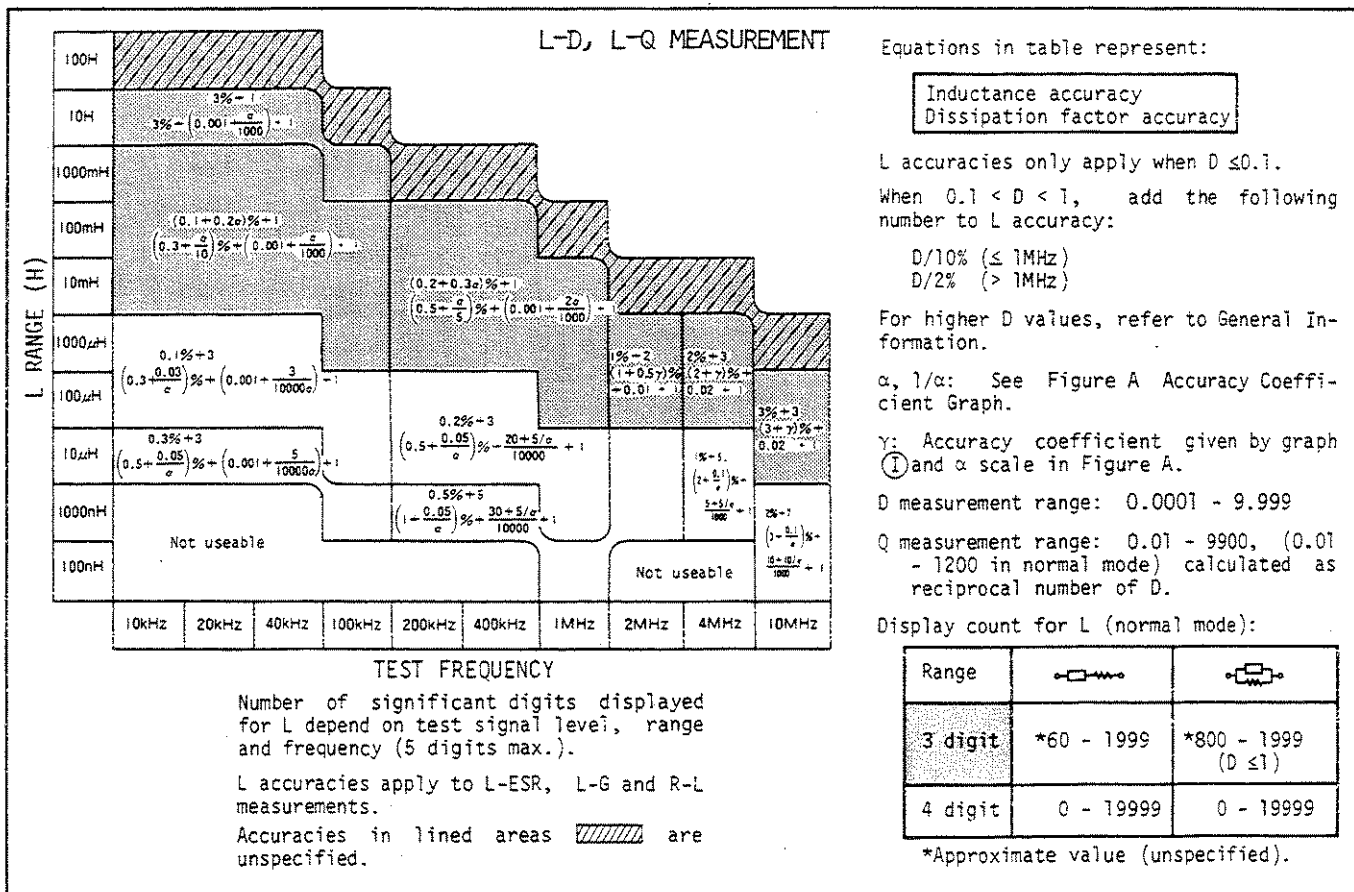


Table 1-1. Specifications (sheet 5 of 8).

R, X, B RANGES		R-X/B & R-L/C MEASUREMENTS										
R, X, B RANGES	10M		5% ± 1									
	10M		5% ± (20α² + 5α + 1)									
		1000n	3% ± (2/α + 10)									
			100n		10n		1000pF		10pF			
			100pF		10000F							
	1000k		3% ± 1									
	1000k		3% ± (20α² + 5α + 1)									
		10μ	1% ± (2/α + 3)				1% ± (2/α + 5)					
			10n		1000nH		1000F		10000F			
			100pF		100F		10000F					
	100k		(0.1 + 0.2α)% ± 1				0.2 - 0.2α)% ± 1					
	100k		(0.1 + 0.2α)% ± (20α² + 3α + 1)				(0.2 - 0.2α)% ± (20α² + 10α + 1)					
		100μ	0.1% ± (2/α + 3)				0.2% ± (2/α + 3)					
			1000nH		100nH		100pF		10nH		1000μH	
			1000pF		1000F		1000F		10000F			
	10k		(0.1 + 0.2α)% ± 1				(0.2 - 0.2α)% ± 1				1% ± 2	
	10k		(0.1 + 0.2α)% ± (20α² + 3α + 1)				(0.2 - 0.2α)% ± (20α² + 10α + 1)				3% ± 3	
		1000μ	0.1% ± (2/α + 3)				0.2% ± (2/α + 3)				1	
			100nH		10nH		1000μH		100pF		10000F	
			10nF		10000F		1000F		10000F			
	1000		(0.1 + 0.2α)% ± 1				(0.2 - 0.2α)% ± 1				1% ± 2	
	1000		(0.1 + 0.2α)% ± (20α² + 3α + 1)				(0.2 - 0.2α)% ± (20α² + 10α + 1)				3% ± 3	
		10m	0.1% ± (2/α + 3)				0.2% ± (2/α + 3)				2	
			10nH		1000μH		1000μH		100μH		100nH	
		100nF		10nF		10000F		10000F				
100		0.1% ± 3				0.2% ± 3				0.5% ± 5		
100		0.1% ± (10α + 3)				0.2% ± (10α + 3)				3		
	100m	0.1% ± (2/α² + 2/α + 1)				0.2% ± (2/α² + 2/α + 1)				3		
		1000μH		100μH		10nF		10μH		1000nH		
		1000nF		100nF		10nF		10000F				
10		0.1% ± 3				0.2% ± 3				0.5% ± 5		
10		0.1% ± (10α + 3)				0.2% ± (10α + 3)				3		
	1000n	0.1% ± (2/α² + 2/α + 1)				0.2% ± (2/α² + 2/α + 1)				3		
		100μH		10μH		1000nH		100nH				
		10μF		10000F		100nH		10nF				
1000m		0.3% ± 3				0.5% ± 5				Not useable		
1000m		0.3% ± (10α + 5)				0.5% ± (10α + 5)						
	10	0.3% ± (2/α² + 2/α + 1)				0.5% ± (3α² + 3/α + 1)						
		10μH		1000nH		100nH						
		100μF		10μF		10000F						
		10kHz	20kHz	40kHz	100kHz	200kHz	400kHz	1MHz	2MHz	4MHz	10MHz	

Equations in table represent:

Resistance accuracy
Reactance accuracy
Susceptance accuracy
L and C ranges

R accuracies apply only when Q ≤ 0.1 (D ≥ 10). For higher Q values, refer to General Information.

α, α², 1/α, 1/α²: See Figure A Accuracy Coefficient Graph.

6: $\frac{X \text{ rdg}}{10000}$ (normal mode)
 $\frac{X \text{ rdg}}{100000}$ (high resolution mode)
(X rdg = reactance reading in counts).

C accuracies are same as for C-D, C-Q measurements.

L accuracies are same as for L-D, L-Q measurements.

Display counts for R, X, B, L and C (normal mode):

	3 digit	4 digit
Rs	*36 - 1999	0 - 19999
X		
Rp	*50 - 1999 (Q ≤ 1)	0 - 19999
L	*56 - 1999	0 - 19999 (D ≤ 2)

	4 digit	3 digit
B	0 - 19999	*36 - 1999
C	0 - 1999 (3 digit)	*56 - 1999 **(140 - 1999)

*Approximate value (unspecified).
**At frequencies of 40kHz, 400kHz, and 4MHz.

Subscripts s and p signify series and parallel modes, respectively.

Number of significant digits displayed for R, X and B depend on test signal level, range and frequency (5 digits max.).

Accuracies in lined areas are unspecified.

- *1 X: $1\% + (20\alpha^2 + 20\alpha + 1)$
B: $0.5\% + (3/\alpha^2 + 3/\alpha + 1)$
- *2 X: $1\% + (20\alpha^2 + 20\alpha + 1)$
B: $0.5\% + (2/\alpha + 3)$
- *3 X: $0.5\% + (10\alpha + 5)$
B: $0.5\% + (2/\alpha + 3)$

Table 1-1. Specifications (sheet 6 of 8).

|Z| - θ MEASUREMENT

 Z RANGE	10M Ω	5% - 1 0.1° - 0.1° α									
	1000k Ω	3% - 1 0.05° - 0.1° α									
	100k Ω	(0.1 - 0.2α)% - 1 0.05° - 0.05° α		(0.2 - 0.2α)% - 1 0.05° - 0.05° α		1% - 2 0.1° - 0.1° α		3% - 3 0.4° - 0.4° α			
	10k Ω										
	1000 Ω										
	100 Ω	0.1% - 3 0.05° - 0.05° / α		0.2% - 3 0.05° - 0.05° / α		2% - 7 0.4° - 0.4° α		2% - 15 0.4° - 0.4° α			
	10 Ω										
	1000m Ω	0.3% - 5 0.1° - 0.1° / α		0.5% - 5 0.1° - 0.1° / α		Not useable					
		10kHz	20kHz	40kHz	100kHz	200kHz	400kHz	1MHz	2MHz	4MHz	10MHz

Equations in table represent:

Impedance accuracy
Phase angle accuracy

α, 1/α: See Figure A Accuracy Coefficient Graph.

θ measurement range:
-180.000° - +180.000°

Display counts for |Z| and θ (normal mode):

Ranges	Z	θ
	*36 - 1999	0 - 18000
	0 - 19999	0 - 18000

*Approximate value (unspecified).

Number of significant digits displayed for |Z| and θ depend on test signal level, range and frequency (5 digits max.).

Accuracies in lined areas are unspecified.

OPTIONS

Option 001: Internal dc bias source remotely controllable from 0V to ±35V in 1mV (minimum) steps.

Bias control range and accuracy:

Range	step	Accuracy
±(.000 - .999)V	1mV	±(0.5% of rdg + 2mV)
±(1.00 - 9.99)V	10mV	±(0.5% of rdg + 4mV)
±(10.0 - 35.0)V	0.1V	±(0.5% of rdg + 20mV)

*Accuracies apply when DC BIAS switch is set to: INT 35V/100V (≤.1μF) position. In INT 35V/100V (≤ 200μF) position, ±(2% of setting + 20mV) on all ranges.

Bias output characteristics:

220Ω ±10%, 40mA max. (C ≤ 0.1μF)
1050Ω ±10%, 10mA max. (C ≤ 200μF)

Control: Remote control by HP 16023B DC Bias Controller or by HP-IB controller.

Control input: 24 pin connector input for 16023B or HP-IB connector. Mating connector: HP part number 1251-0292, AMPHENOL 57-40240.

Option 002: Internal dc bias source remotely controllable from 0V to ±99.9V in 0.1V (minimum) steps.

Bias control range: ±(00.0V - 99.9V), 0.1V steps.

Accuracy: ±(2% of setting + 40mV)

Bias output characteristics:

50kΩ ±10%, 2mA max.

Control: same as Option 001.

Control input: same as Option 001.

Option 003: Provides continuous memorization of control settings powered by stand-by battery. Memorizes the following data and control settings:

- 1) Front panel pushbutton control settings (except SELF TEST function).
- 2) Offset control values for test fixture or leads.

Table 1-1. Specifications (sheet 7 of 8).

3) Reference value of deviation measurement.

These memories are maintained if the instrument loses power. Memorized control settings are restored by turning the instrument on or by pressing front panel keys.

Option 004: 10 spot test signal frequencies selectable in a 1-3-5-10 step sequence instead of standard test signal frequencies. Option frequencies are: 10kHz, 30kHz, 50kHz, 100kHz, 300kHz, 500kHz, 1MHz, 3MHz, 5MHz and 10MHz $\pm 0.01\%$.

Option 101: HP-IB Compatible (data output and remote control per IEEE-STD-488-1975).

Remotely controllable functions:

- 1) Display A functions (L, C, R, $|Z|-\theta$).
- 2) Deviation functions (Δ , $\Delta\%$, RECALL, STORE).
- 3) LCRZ Range.
- 4) Display B functions (D, Q, ESR, G, X, B, L, C).
- 5) Circuit mode.
- 6) High resolution.
- 7) Self test.
- 8) Trigger.
- 9) Test signal frequency.
- 10) Test signal level check functions.
- 11) Test signal level multiplier.
- 12) Zero offset.
- 13) DC bias voltage (options 001 and 002 only).

Data output: L or C with D, Q, ESR or G; R with X, B, L or C; $|Z|$ with θ ; Δ or $\Delta\%$; reference value in deviation measurement; test signal voltage and current; front panel control settings status (circuit mode, test frequency, Display A and Display B functions).

Internal function allowable subsets: SH1, AH1, T5, L4, SR1, RL1, DC1 and DT1.

Data output format: Either of two formats may be selected (switchable on internal circuit board):

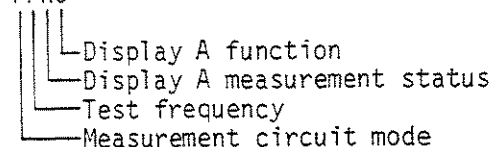
Format A.

PFNC N.NNNNNE NN,ND N.NNNNNE NN (CR) (LF)

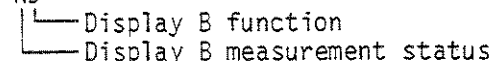
Format B.

PFNC N.NNNNNE NN,
ND N.NNNNNE NN (CR) (LF)

PFNC



ND



Note

The functions and capabilities of Option 003, Battery Memory Backup, and Option 101, HP-IB Compatibility, are installed in all 4275A instruments with serial number 2045J01243 and above.

Option 907: Front handle kit, for front handle installation.

Option 908: Rack flange kit, for mounting in IEC standard rack.

Option 909: Rack flange & handle kit, for rack mounting and front handle installation.

Option 910: Extra manual.

Special frequency option: One or two test frequencies can be installed in addition to standard (or Option 004) 10-spot test frequencies.

Available frequency range:

10kHz - 10.7MHz.

Frequency accuracy: 0.1%.

Measurement accuracy: The accuracy of inductance (L) measurements made at special option frequencies from 4MHz to 10MHz with the UNKNOWN terminals extended using 1 meter cables is not specified for DUTs from 400nH to 3 μ H.

Table 1-1. Specifications (sheet 8 of 8).

<u>ACCESSORIES</u>	
Accessories supplied: 16047A Test Fixture, direct coupled, 4-terminal pair configuration. Three kinds of contact electrode modules are included for components with either axial, radial or radial short leads. Useable on all 4275A ranges.	
Accessories available:	
16047B:	Test Fixture, cable connection type, 4-terminal pair, useable with dc biases up to 200 volts. Protective cover provided as safeguard against high potential hazards. Three kinds of contact electrode modules are furnished (same as for 16047A). Useable on all ranges at frequencies below 2MHz.
16047C:	Test Fixture, direct coupled, 2-terminal. Useable on all 4275A ranges (especially for high frequency measurements requiring high accuracy).
16048A:	Test Leads with BNC connectors, 4-terminal pair, 1m long.
16048B:	Test Leads with miniature rf connectors for system applications, 4-terminal pair, 1m long.
16048C:	Test Clip Cable with special alligator clips, 4 terminal. Useable for low frequency measurements below 100kHz (C>1000pF, L>100μH).
16334A:	Test Fixture, tweezer type, 3 terminal. Useable in high impedance measurements (>50Ω), lead-less components on all 4275A frequency ranges.
16023B:	Bias Controller. For setting internal dc bias voltage of 4275A (option 001 or 002) in three digits (set into control switch).
Bias voltage control range: 0.000V to ±99.9V.	

Table 1-2. General Information (sheet 1 of 2).

<u>GENERAL INFORMATION</u>	
<u>Measurement accuracy:</u>	
Accuracy at Multiplier X 0.01, Osc Level max:	
C-D, C-Q:	Multiplies values of accuracy equation terms that include α by 10.
C-ESR, C-G:	Same as accuracy specifications.
L-D, L-Q:	Multiplies values of accuracy equation terms that include α by 10.
L-ESR, L-G:	Same as accuracy specifications.
R-X, R-B, R-L, R-C:	Multiplies values of % error terms that include α, γ or δ in accuracy equation by 10.
Z -θ:	
Z :	Multiplies values in accuracy equation terms that include α by 10.
θ:	Multiplies specified accuracy by 2.
Accuracy at OSC LEVEL setting other than max. position:	
Multiplies specified accuracy by coefficient given in figure below:	
C and L accuracies at D > 1:	Multiplies specified accuracy by (1 + D ²).
R accuracy at Q > 0.1 (D < 10):	Multiplies specified accuracy by (1 + Q ²).

Table 1-2. General Information (sheet 2 of 2).

Test signal level monitor:

Range: Voltage 0.001V to 1.00V rms.
Current 0.001mA to 10mA rms

Accuracy:

Measurement range	Freq.	Accuracy
Voltage 0.001V to 1.00V	<1MHz	±(3% of rdg + 1 count)
	≥1MHz	±(10% of rdg + 2 counts)
Current 0.001mA to 10.0mA	<1MHz	±(3% of rdg + 1 count)
	≥1MHz	±(10% of rdg + 2 counts)

Measurement Time (typical): 140 - 180ms

(Measurement time depends on range, sample value and offset adjustment values.)

|Z|-θ measurement time: 170 - 210ms.

High resolution: Approximately 8 times the normal measurement time.

Auto ranging time: 100ms - 300ms per range shift.

Test signal settling time:

(Time for test signal to settle when changing frequency, level or dc bias voltage.)

Settling time after frequency change:

Approximately 200ms.

Settling time after level change:

MULTIPLIER (to X 0.1 or X 1):

Approximately 200ms.

(to X0.01):

Approximately 1000ms.

OSC LEVEL control: 2 - 3 s.

Settling time after dc bias change:

The longer of either dc bias settling time or test signal settling time as given in table below:

MULTIPLIER setting	Settling time (E: dc bias voltage)
X 1	200 + E (V) ms
X 0.1	300 + E (V) ms
X 0.01	400 + E (V) ms

Options 001 and 002

DC bias settling time:

Option 001: 20ms (C ≤ 0.1μF)
600 + 6·Cx ms (C ≤ 200μF)

Option 002: less than 300ms (C ≤ 0.1μF)

(*Cx = Capacitance value of sample in μF)

AVAILABLE ACCESSORIES

HP-IB Interface Cable: HP 10833A (1m)
HP 10833B (2m)
HP 10833C (4m)
HP 10833D (0.5m)

Front Handle Kit:

Kit Part Number 5061-0090

Rack Flange Kit:

Kit Part Number 5061-0078

Rack Flange Handle Kit:

Kit Part Number 5061-0084

Fuse:

HP Part Number 2110-0059 (100/120V).
HP Part Number 2110-0360 (220/240V).

Protective fuses:

HP Part Number 2110-0201 (for dc bias)
HP Part Number 2110-0012 (for input circuit)

1-21. OPTION 001.

1-22. The 4275A Option 001 adds an internal dc bias supply controllable from 0 to $\pm 35V$ by the HP 16023B bias controller or HP-IB control device (a calculator) through a rear panel connector. The bias voltage is set in three digits in three decade ranges as follows:

- $\pm(.000$ to $.999V)$
- $\pm(0.00$ to $9.99V)$
- $\pm(00.0$ to $35.0V)$

1-23. OPTION 002.

1-24. The 4275A Option 002 provides internal dc bias supply controllable from 0 to $\pm 99.9V$ by the HP 16023B bias controller or HP-IB control device through a rear panel connector. The bias voltage is set in three digits in one range from $\pm 00.0V$ to $\pm 99.9V$.

1-25. OPTION 003.

1-26. The 4275A Option 003 provides a stand-by battery for maintaining the volatile memory in event the instrument loses power. This continuous memory capability enables the instrument to preserve the memory of the desired front panel control settings and to recall these settings for repeated selection of the same settings anytime and every time the instrument is turned on.

1-27. OPTION 004.

1-28. The 4275A Option 004 provides 10 spot test frequencies selectable in a 1-3-5-10 sequence instead of the standard 1-2-4-10 sequence step fashion. Two extra frequencies are also optionally available along with Option 004.

1-29. OPTION 101.

1-30. The 4275A Option 101 provides an interfacing function for transferring measured data and for receiving remote control signals from HP Interface Bus lines (Hewlett-Packard's implementation of IEEE-STD-488-1975).

Note

The functions and capabilities of Option 003, Battery Memory Backup, and Option 101, HP-IB Compatibility, are installed in all 4275A instruments with serial number 2045J01243 and above.

1-31. Special Frequency Options.

1-32. The 4275A Special Frequency Options and one or two test frequencies in addition to the standard 10 spot test frequencies.

Option code numbers assign the specially installed test frequencies in the following manner:

Options	Frequency range
RXX	10.0kHz to 99.0kHz
SXX	100kHz to 990kHz
TXX	1.00MHz to 9.90MHz

The two digits of the option number following the alpha prefixes (R, S and T) indicate the first and second significant digits of the test frequency. When the option code is prefixed with an F, the option code numbers signify the following particular test frequencies:

Options	Test Frequency
F01	15.7kHz
F02	32.8kHz
F03	455kHz
F04	3.58MHz
F05	4.19MHz
F06	10.7MHz

1-33. OTHER OPTIONS.

1-34. The following options provide the mechanical parts necessary for rack mounting and hand carrying:

- Option 907: Front Handle Kit.
- Option 908: Rack Flange Kit.
- Option 909: Rack Flange and Front Handle Kit.

Installation procedures for these options are detailed in Section II.

1-35. The 4275A Option 910 provides an extra copy of the operating and service manual.

1-36. ACCESSORIES SUPPLIED.

1-37. Figure 1-1 shows the HP Model 4275A Multi-frequency LCR Meter, Model 16047A Test Fixture and power cord (HP Part No. 8120-1378). The 16047A and the power cord are furnished accessories. Additionally, a fuse (HP Part No. 2110-0059 or 2110-0360) is supplied as a service part.

1-38. ACCESSORIES AVAILABLE.

1-39. For convenience and ease of measurement, eight styles of test fixtures and leads are available. Each accessory is designed to be appropriate for a particular use of the instrument and/or the type of DUT. Accessory models and names are listed in Table 1-1. A brief description for each of these fixtures and leads is given in Table 1-3.

Table 1-3. Accessories Available (Sheet 1 of 2).

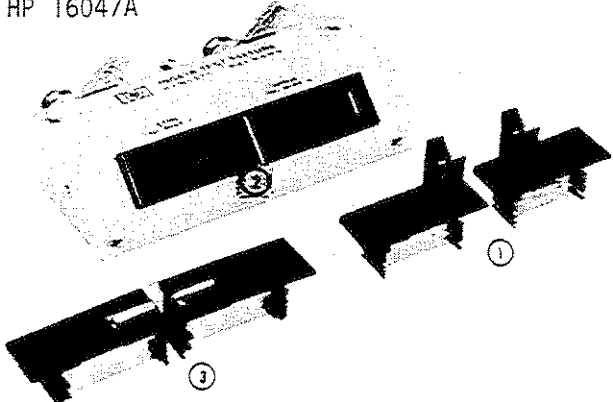
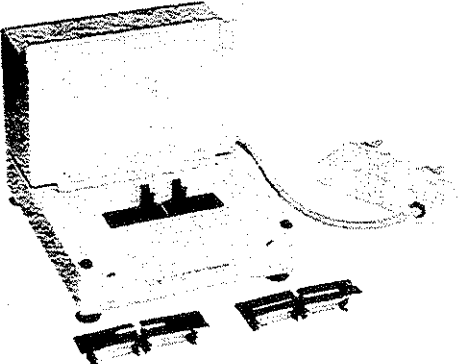
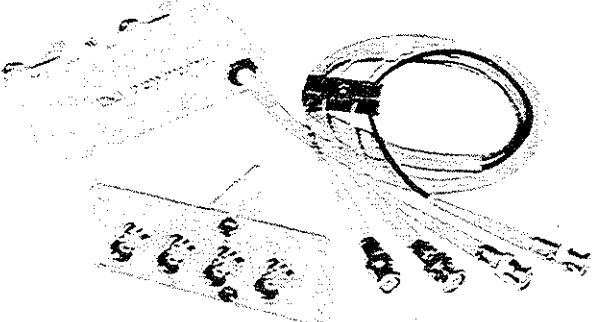
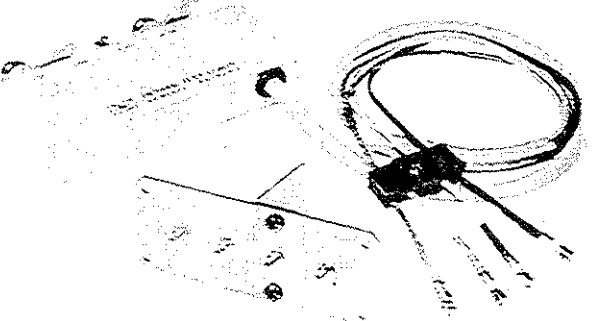
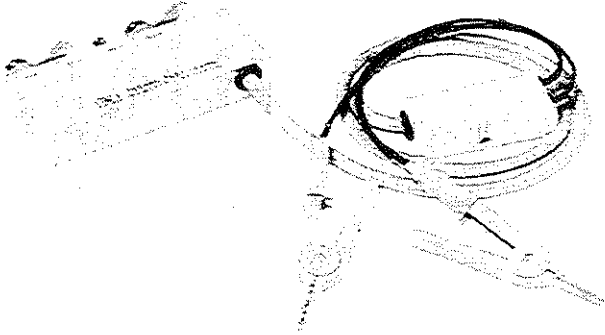
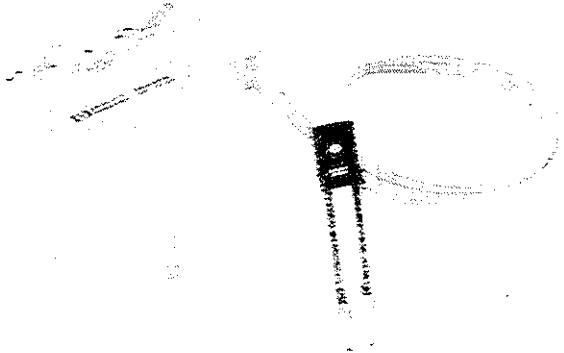

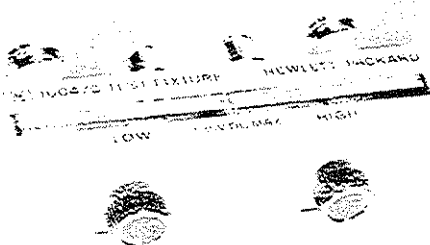
Model	Description
<p>HP 16047A</p>  <p>The image shows the HP 16047A test fixture, a rectangular metal enclosure with a front panel. Three different contact electrode modules are shown separately, labeled with circled numbers 1, 2, and 3. Module 1 is a small black component, module 2 is a larger black component with a central slot, and module 3 is a black component with a different internal structure.</p>	<p>Test Fixture (direct attachment type) for general measurement of both axial and radial lead components. Three kinds of contact electrode modules are furnished:</p> <ul style="list-style-type: none"> ① For axial lead components, (HP P/N 16061-70022). ② For general radial lead components, (HP P/N 16061-70021). ③ For radial short lead components, (HP P/N 16047-65001). <p>A dc bias up to $\pm 35V$ can be applied.</p>
<p>HP 16047B</p>  <p>The image shows the HP 16047B test fixture, which is a larger metal enclosure with a hinged lid. Inside, there are several contact electrode modules and a cable. The lid is open, revealing the internal components.</p>	<p>Test Fixture (cable connection type) for general measurement of both axial and radial lead components at frequencies below 2MHz. Three kinds of contact electrode modules are furnished (same for the 16047A Test Fixture).</p> <p>A dc bias up to $\pm 200V$ can be applied (a protective cover provides for operator safety).</p> <p>Cable length: approximately 40cm</p>
<p>HP 16048A</p>  <p>The image shows the HP 16048A test leads, which consist of a coiled cable with BNC connectors at both ends. The cable is connected to a terminal block with four pairs of terminals.</p>	<p>Test Leads (four terminal pair) with BNC BNC connectors for connecting user-supplied test fixture. Maximum applied dc bias voltage is $\pm 300V$.</p> <p>Cable length setting: 1m Length (Connection terminals - end of fixture): approx. 95cm</p>
<p>HP 16048B</p>  <p>The image shows the HP 16048B test lead, which is similar to the HP 16048A but uses miniature RF connectors instead of BNC connectors. It also consists of a coiled cable connected to a terminal block.</p>	<p>Test Lead (four terminal pair) with miniature RF connectors suitable for connecting user-supplied test fixture in system applications. Maximum applied dc bias voltage is $\pm 300V$.</p> <p>Cable length setting; 1m Length (Connection terminals - end of fixture): approx. 93cm</p>

Table 1-3. Accessories Available (Sheet 2 of 2).

Model	Description
<p>HP 16048C</p>  <p>The image shows a pair of test leads with dual alligator clips at one end and connection terminals at the other. The leads are coiled and appear to be made of a flexible material.</p>	<p>Test Leads with dual alligator clips for conveniently testing various shapes of components at frequencies below 100kHz. Applicable measurement ranges:</p> <ul style="list-style-type: none"> Capacitance > 1000pF Inductance > 100μH <p>Maximum applied dc bias voltage is ±35V.</p> <p>Cable length setting: 1m Length (Connection terminals - end of fixture): approx. 128cm</p>
<p>HP 16334A</p>  <p>The image shows a tweezer-type test fixture with a correction block. It has a long handle and a curved, pointed tip for holding small components.</p>	<p>Test Fixture (tweezer type) for measurement of miniature lead-less components such as chip capacitors. The correction block for ZERO offset adjustment is furnished. Maximum applied dc bias voltage is ±42V.</p> <p>Cable length: 1m Length (Connection terminals - end of fixture): approx. 133cm</p>
<p>HP 16023B</p>  <p>The image shows a DC bias controller unit with a control switch and a cable. The unit is rectangular and has a small display or indicator on the front.</p>	<p>DC Bias Controller used for Option 001 or Option 002 units. Useable for setting dc bias voltages from ±0.000V to ±35V (for Option 001) or from ±00.0V to ±99.9V (for Option 002) in three digits set into control switch.</p>
<p>HP 16047C</p>  <p>The image shows a direct attachment type test fixture with two screw knobs. The fixture is rectangular and has the text 'HP 16047C TEST FIXTURE' and 'HEWLETT PACKARD' printed on it. Below the fixture, there are two circular components, likely electrodes or sample leads.</p>	<p>Test Fixture (direct attachment type) especially appropriate for high frequency measurements requiring high accuracy. Two screw knobs facilitate and ensure optimum contact of electrodes and sample leads. Maximum applied dc bias voltage is ±35V.</p>

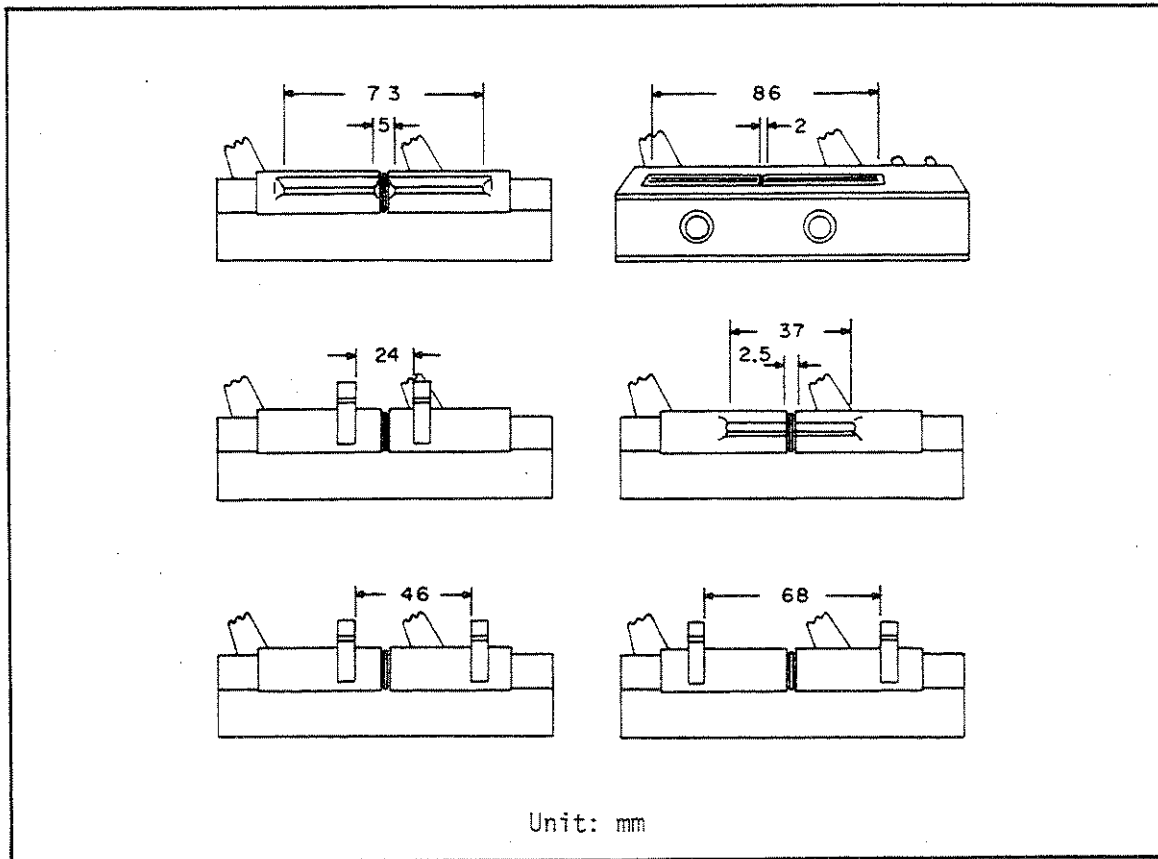


Figure 1-3. Dimensions of Test Fixture Contacts.

SECTION II INSTALLATION

2-1. INTRODUCTION.

2-2. This section provides installation instructions for the Model 4275A LCR Meter. The section also includes information on initial inspection and damage claims, preparation for using the 4275A, packaging, storage, and shipment.

2-3. INITIAL INSPECTION.

2-4. The 4275A LCR Meter, as shipped from the factory, meets all the specifications listed in Table 1-1. On receipt, inspect the shipping container for damage. If the shipping container or cushioning material is damaged, notify the carrier as well as the Hewlett-Packard office and be sure to keep the shipping materials for carrier's inspection until the contents of the shipment have been checked for completeness and the instrument has been checked mechanically and electrically. The contents of the shipment should be as shown in Figure 1-1. The procedures for checking the general electrical operation are given in Section III (Paragraph 3-5 Basic Operating Check) and the procedures for checking the 4275A LCR Meter against its specifications are given in Section IV. Firstly, do the self test. If the 4275A LCR Meter is electrically questionable, then do the Performance Tests to determine whether the 4275A has failed or not.

If contents are incomplete, if there is mechanical damage or defects (scratches, dents, broken switches, etc.), or if the performance does not meet the self test or performance tests, notify the nearest Hewlett-Packard office (see list at back of this manual). The HP office will arrange for repair or replacement without waiting for claim settlement.

2-5. PREPARATION FOR USE.

2-6. Power Requirements.

2-7. The 4275A requires a power source of 100, 120, 220Volts ac $\pm 10\%$, or 240Volts ac $+5\%-10\%$, 48 to 66Hz single phase; power consumption is 165VA maximum.

WARNING

IF THIS INSTRUMENT IS TO BE ENERGIZED VIA AN EXTERNAL AUTOTRANSFORMER FOR VOLTAGE REDUCTION, BE SURE THAT THE COMMON TERMINAL IS CONNECTED TO THE NEUTRAL POLE OF THE POWER SUPPLY.

2-8. Line Voltage and Fuse Selection.

CAUTION

BEFORE TURNING THE 4275A LINE SWITCH TO ON, VERIFY THAT THE INSTRUMENT IS SET TO THE VOLTAGE OF THE POWER SUPPLIED.

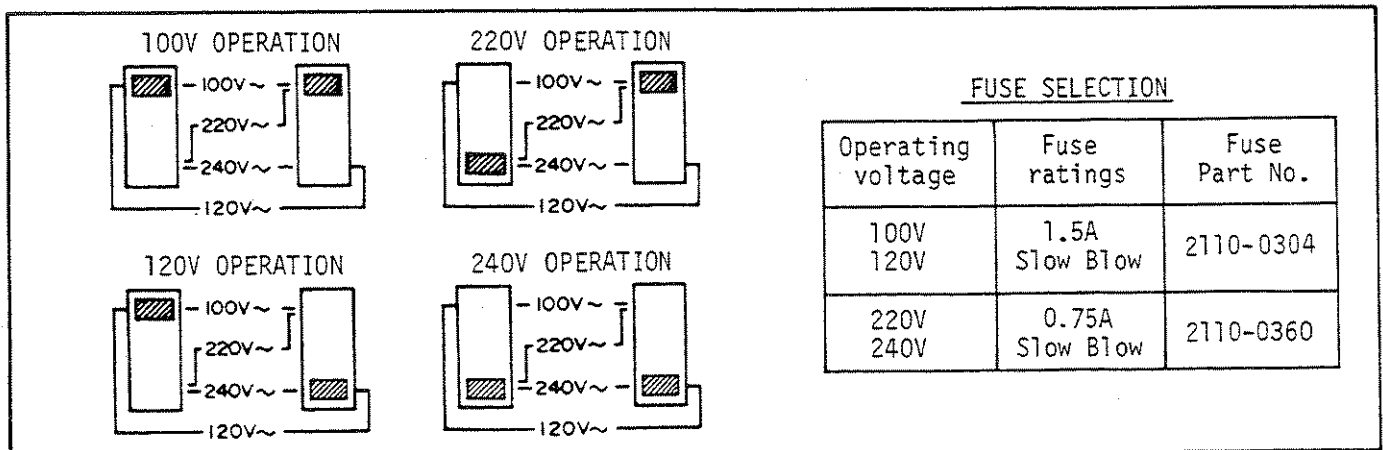


Figure 2-1. Line Voltage and Fuse Selection.

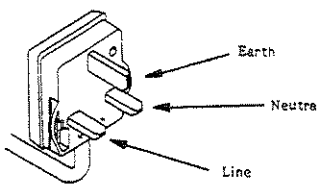
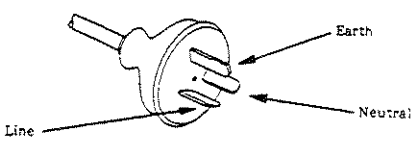
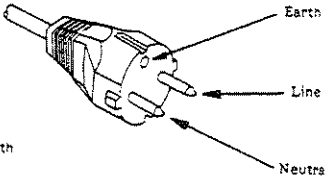
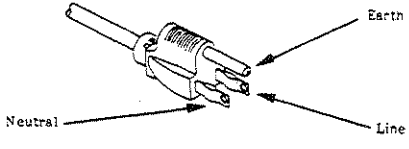
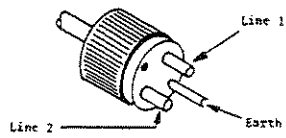
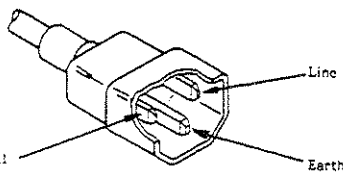
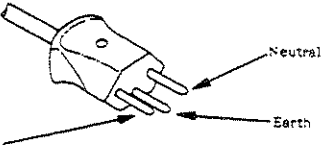
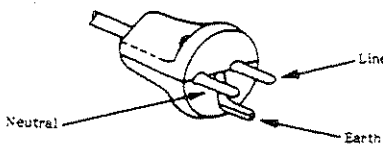
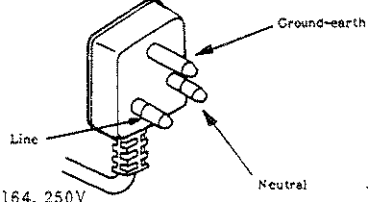
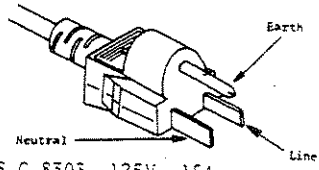
<p>OPTION 900 United Kingdom</p>  <p>Plug: BS 1363A, 250V Cable: HP 8120-1351</p>	<p>OPTION 901 Australia/New Zealand</p>  <p>Plug: NZSS 198/AS C112, 250V Cable: HP 8120-1369</p>
<p>OPTION 902 European Continent</p>  <p>Plug: CEE-VII, 250V Cable: HP 8120-1689</p>	<p>OPTION 903 U.S./Canada</p>  <p>Plug: NEMA 5-15P, 125V, 15A Cable: HP 8120-1378</p>
<p>OPTION 904 U.S./Canada</p>  <p>Plug: NEMA 6-15P, 250V, 15A Cable: HP 8120-0698</p>	<p>OPTION 905* Any country</p>  <p>Plug: CEE 22-VI, 250V Cable: HP 8120-1396</p>
<p>OPTION 906 Switzerland</p>  <p>Plug: SEV 1011.1959-24507 Type 12, 250V Cable: HP 8120-2104</p>	<p>OPTION 912 Denmark</p>  <p>Plug: DHCR 107, 220V Cable: HP 8120-2956</p>
<p>OPTION 917 India/Republic of S.Africa</p>  <p>Plug: SABS 164, 250V Cable: HP 8120-4211</p>	<p>OPTION 918 Japan</p>  <p>Plug: JIS C 8305, 125V, 15A Cable: HP 8120-4755</p>
<p>NOTE: Each option number includes a 'family' of cords and connectors of various materials and plug body configurations (straight, 90° etc.).</p> <p>* Plug option 905 is frequently used for interconnecting system components and peripherals.</p>	

Figure 2-2. Power Cables Supplied

2-9. Figure 2-1 provides instructions for line voltage and fuse selection. The line voltage selection switch and the proper fuse are factory installed for 100 or 120 volts ac operation.

CAUTION

USE PROPER FUSE FOR LINE VOLTAGE SELECTED.

CAUTION

MAKE SURE THAT ONLY FUSES FOR THE REQUIRED RATED CURRENT AND OF THE SPECIFIED TYPE ARE USED FOR REPLACEMENT. THE USE OF MENDED FUSES AND THE SHORT-CIRCUITING OF FUSE-HOLDERS MUST BE AVOIDED.

2-10. Power Cable.

2-11. To protect operating personnel, the National Electrical Manufacturer's Association (NEMA) recommends that the instrument panel and cabinet be grounded. The Model 4275A is equipped with a three-conductor power cable which, when plugged into an appropriate receptacle, grounds the instrument. The offset pin on the power cable is the ground wire.

2-12. To preserve the protection feature when operating the instrument from a two contact outlet, use a three prong to two prong adapter (HP Part No. 1251-8196) and connect the green grounding tab on the adapter to power line ground.

CAUTION

THE MAINS PLUG MUST ONLY BE INSERTED IN A SOCKET OUTLET PROVIDED WITH A PROTECTIVE EARTH CONTACT. THE PROTECTIVE ACTION MUST NOT BE NEGATED BY THE USE OF AN EXTENSION CORD (POWER CABLE) WITHOUT PROTECTIVE CONDUCTOR (GROUNDING).

2-13. Figure 2-2 shows the available power cords, which may be used in various countries including the standard power cord furnished with the instrument. HP Part number, applicable standards for power plug, power cord color, electrical characteristics and countries using each power cord are listed in the figure. If assistance is needed for selecting the correct power cable, contact nearest Hewlett-Packard office.

2-14. Interconnections.

2-15. When an external bias is required, set DC BIAS switch on rear panel to EXT \pm 35V MAX position or to EXT \pm 200V MAX position (de-

pending on the maximum voltage to be applied to sample under test). The output of the external bias source should be connected to appropriate BNC connector (35V or 200V connector).

2-16. Operating Environment.

2-17. Temperature. The instrument may be operated in temperatures from 0°C to +55°C.

2-18. Humidity. The instrument may be operated in environments with relative humidities to 90% to 40°C. However, the instrument should be protected from temperature extremes which cause condensation within the instrument.

2-19. Installation Instructions.

2-20. The HP Model 4275A can be operated on the bench or in a rack mount. The 4275A is ready for bench operation as shipped from the factory. For bench operation, a two-leg instrument stand is used. For use, the instrument stands are designed to be pulled towards the front of instrument.

2-21. Installation of Options 907, 908 and 909.

2-22. The 4275A can be installed in a rack and be operated as a component of a measurement system. Rack mounting information for the 4275A is presented in Figure 2-3.

2-23. STORAGE AND SHIPMENT.

2-24. Environment.

2-25. The instrument may be stored or shipped in environments within the following limits:

Temperature -40°C to +75°C
Humidity to 95%
Altitude 50,000ft

The instrument should be protected from temperature extremes which cause condensation inside the instrument.

2-26. Packaging.

2-27. Original Packaging. Containers and materials identical to those used in factory packaging are available through Hewlett-Packard offices. If the instrument is being returned to Hewlett-Packard for servicing, attach a tag indicating the type of service required, return address, model number, and full serial number. Also mark the container FRAGILE to assure careful handling. In any

correspondence, refer to the instrument by model number and full serial number.

2-28. Other Packaging. The following general instructions should be used for re-packing with commercially available materials:

- a. Wrap instrument in heavy paper or plastic. If shipping to Hewlett-Packard office or service center, attach tag indicating type of service required, return address, model number, and full serial number.
- b. Use strong shipping container. A double-wall carton made of 350 pound test material is adequate.
- c. Use enough shock absorbing material (3 to 4 inch layer) around all sides of

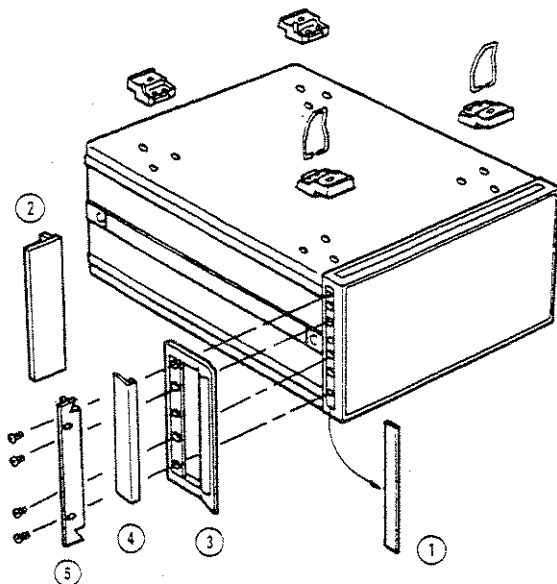
instrument to provide firm cushion and prevent movement inside container. Protect control panel with cardboard.

- d. Seal shipping container securely.
- e. Mark shipping container FRAGILE to ensure careful handling.
- f. In any correspondence, refer to instrument by model number and full serial number.

2-29. OPTION INSTALLATION.

2-30. Installation procedures for dc bias options (Option 001 or 002) and HP-IB option (Option 101) are outlined in Figure 2-4.

Option	Description	Kit Part Number *
907	Handle Kit	5061-9690
908	Rack Flange Kit	5061-9678
909	Rack Flange & Handle Kit	5061-9684



1. Remove adhesive-backed trim strip (1) from sides at right and left front of instrument.
2. HANDLE INSTALLATION: Attach front handle (3) to sides at right and left front of instrument with screws provided and attach trim (4) to handle.
3. RACK MOUNTING: Attach rack mount flange (2) to sides at right and left front of instrument with screws provided.
4. HANDLE AND RACK MOUNTING: Attach front handle (3) and rack mount flange (5) together to sides at right and left front of instrument with screws provided.
5. When rack mounting (3 and 4 above), remove all four feet (lift bar at inner side of foot, and slide foot toward the bar).

* The kit part numbers for the 4275As serial numbered below 2517J03233 are as follows:
 Opt.907 : 5061-0090
 Opt.908 : 5061-0078
 Opt.909 : 5061-0084

Figure 2-3. Rack Mount Kits.

CAUTION: BEFORE PROCEEDING WITH INSTALLATION OF OPTION(S), PUSH LINE BUTTON TO OFF AND REMOVE POWER CORD FROM INSTRUMENT.

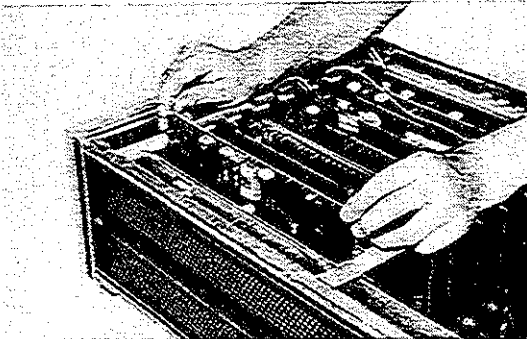
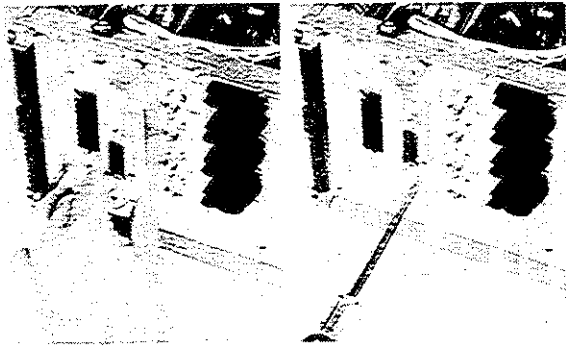
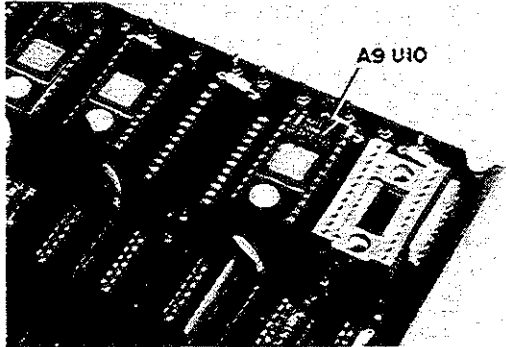
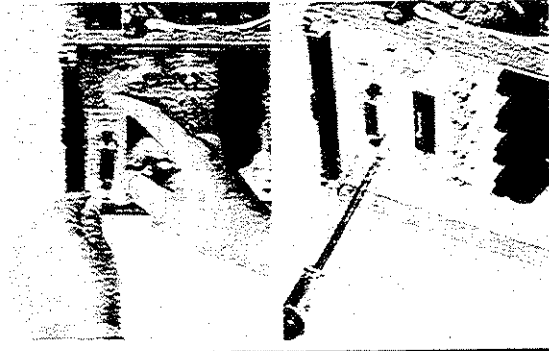
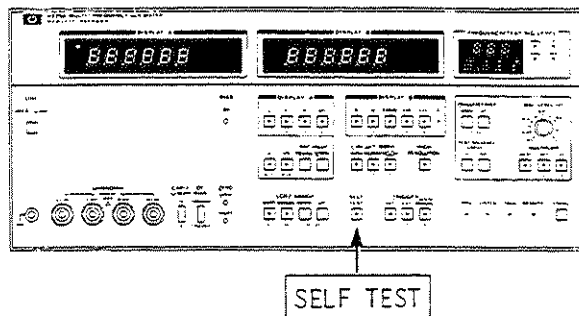
	OPTION 001 DC Bias Supply (0 to ±35V)	OPTION 002 DC Bias Supply (0 to ±99.9V)	OPTION 101 HP-IB COMPATIBILITY
Option Parts	Board Assembly A21 04274-66521 Connector Board Assembly 04274-66516 Screw (2 each) 2360-0115	Board Assembly A23 04274-66523 Connector Board Assembly 04274-66516 Screw (2 each) 2360-0115	Optional ROM A9U10: 04274-85029 (The units serial numbered 2045J00863 and above are already equipped with an Option 101 compatible A9U10.) Board Assembly A22: 04274-66522 Connector Board Assembly: 04274-66515 Screw (2 each): 2360-0115
Installation Procedure (after removing top cover)	<p>1. Install A21 or A23 board assembly.</p>  <p>2. Remove the second-from-left rectangular blind cover from the rear panel.</p> <p>3. Install connector board assembly (04274-66516). Fasten it to the rear panel with the two screws (2360-0115).</p> 	<p>1. Remove A9 Board Assembly from instrument.</p> <p>2. Install optional ROM A9U10 in the proper socket on A9 board.</p>  <p>3. Reinstall A9 board.</p> <p>4. Install board assembly A22.</p> <p>5. Remove left-most rectangular blind cover from the rear panel.</p> <p>6. Install connector board assembly (04274-66515). Fasten it on the rear panel with the two screws (2360-0115).</p> 	

Figure 2-4. Option Installation.

SELF TEST

SELF TEST button is indicated in the figure to the right. When you push the button, the pushbutton lamp lights and the diagnostic test is initiated. The correct operating procedures for the self test are outlined below.



Display Test (first step of SELF TEST): When SELF TEST button is pushed, all front panel indicator lamps except that for the BIAS ON indicator illuminate for approximately 1 second. All segments of the numeric and character displays are also lit. This test is the initial step of the cyclic SELF TEST operation.

Analog Circuit Test (SELF TEST): This test function confirms normal operation of the major analog circuit blocks. The Analog Circuit Test is divided into an "open" and a "short" test performed under their respective (definite) test setups given in table below:

Test Setup	Open test	Short test
Termination of UNKNOWN	Open	Short
DISPLAY A function	C	L or R
OSC LEVEL (V)	1 (fully clockwise)	

Note

Use 16047A Test Fixture for SELF TEST. For an "Open" condition, nothing should be connected; and for a short condition, a low impedance shorting strap (or lead) should be connected across the HIGH and LOW sides of the test fixture contact blocks.

CAUTION

VERIFY THAT BIAS INDICATOR LAMP DOES NOT LIGHT. IF ILLUMINATED, SET BIAS SWITCH ON REAR PANEL TO ITS OFF POSITION.

The open and short tests comprise 20 (1st to 20th) steps and 7 (21st to 27th) steps, respectively, of the diagnostic tests performed on each different circuit block (for different operating conditions). During the respective open and short tests, the DISPLAY A exhibits normal test results as shown below:

OP (OP means that open test is normal)

SH (SH means that short test is normal)

The sequential diagnostic test is repeated, and another Display Test initiated until the SELF TEST button is again pushed. If an abnormal result occurs during the open or short test, the number of the abnormal step is displayed in DISPLAY A as, for example, illustrated below:

OP3 (OP3 means that open test step 3 is abnormal)

SH23 (SH23 means that short test step 23 is abnormal)

If an abnormal display is obtained, first check for test setup. If such display occurs even under proper test conditions, notify the nearest Hewlett-Packard office.

Figure 3-0. Self Test Procedure.

SECTION III OPERATION

3-1. INTRODUCTION.

3-2. This manual section provides the operating instructions for acquainting the user with the Model 4275A Multi-frequency LCR Meter. Instructions for panel controls, functions, operating procedures, basic measuring techniques for the various applications, operational check of the fundamental electrical functions and option information are included in this section. Operating precautions given throughout the text should be carefully observed.

3-3. PANEL FEATURES.

3-4. Front and rear panel features for the 4275A are described in Figures 3-1 and 3-2. Reference numbers in the photos are keyed to the associated descriptions. Other detailed information for panel displays and controls is covered in paragraphs 3-5 and those which follow.

3-5. SELF TEST (Basic Operating Check).

3-6. The 4275A has self-diagnostic functions which are automatically performed or can be done any time desired to confirm the normal operation of the instrument. These functions comprise the following primary tests:

- a. A Program Memory Test
- b. A Display Test (SELF TEST)
- c. An Analog Circuit Test (SELF TEST)

The Program Memory Test is automatically performed each time the LINE button is pushed to turn instrument on. Display and Analog Circuit Tests are enabled by the SELF TEST button and should be performed before beginning measurements.

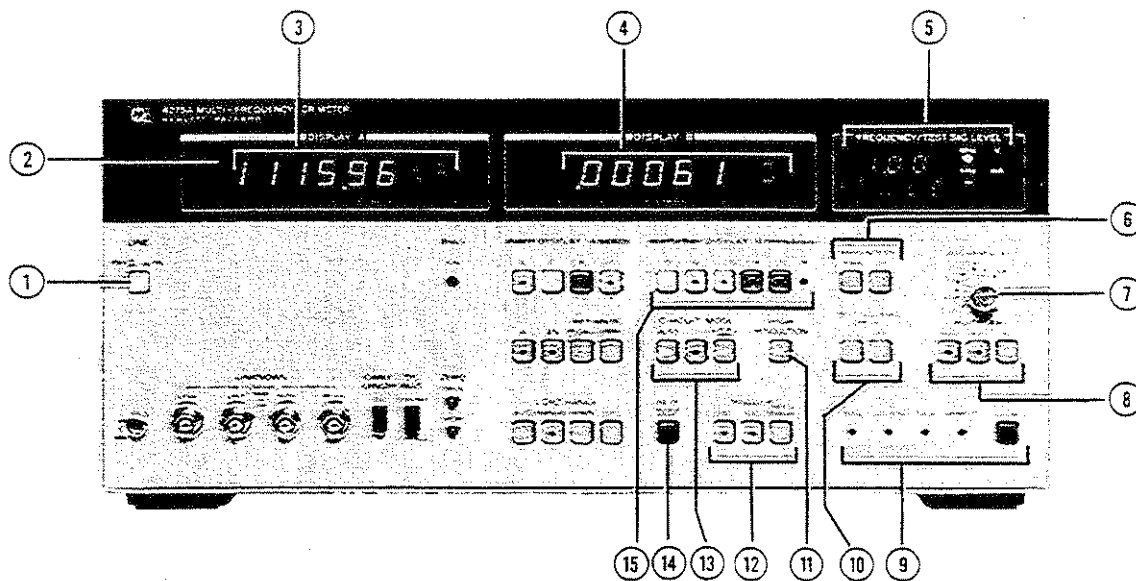
Program Memory Test: During this initial test, the instrument is checked for normal operation of the memorized measurement sequences of the internal program memory. The 4275A display exhibits the correct test result by a left-to-right progression of the figure P as illustrated below:



Display of **P** figure proceeds in a left to right direction

If some abnormality is detected, the display of the **P** figure will not be completed. When a display, in itself, fails the test will, nevertheless, go through its entire sequence. A defective display can be isolated by the test described immediately below.

3-7. Display Test and Analog Circuit Test are combined in a routine of the self-diagnostic tests performed by the Self Test program. The Self Test is a panel pushbutton function for elementary operator checks. Figure 3-0 outlines the setups and operating procedures for the Self Test. When you push the SELF TEST button using the appropriate test setups, the test goes into the diagnostic routine outlined in Figure 3-0.



- ① LINE ON/OFF switch: Turns instrument on and readies instrument for measurement.
- ② Trigger Lamp: Turns on during sample measuring period. Turns off during period when instrument is not taking measurement (or hold period). There is thus one turn-on-and-off cycle per measurement. When TRIGGER (12) is set to INT, the lamp flashes repeatedly at internal measuring rate.
- ③ DISPLAY A: Inductance, capacitance, resistance or impedance values including decimal point and unit is displayed in a maximum 5-1/2 digit decimal number from 00000 to 199999 (the number of digits change depending on instrument control settings). If the sample value exceeds full count number on the selected range, OF (OverFlow) appears in this display. In like manner, if the sample value is too low, an UF (UnderFlow) annunciation appears. If an inappropriate panel control operation is made, one of nine annunciation figures Err1 to Err9 (Error 1 to Error 9) is displayed until the control input demand is automatically released or the erroneous measurement setup is removed.
- ④ DISPLAY B: Dissipation factor, quality factor, equivalent series resistance, conductance, reactance, susceptance, inductance, capacitance or phase angle including decimal point and unit are displayed in a maximum 5-1/2 digit decimal number from 00000 to 199999 (the number of digits change depending on instrument control settings). When DISPLAY A shows OF, UF, or Err, this display becomes blank.
- ⑤ FREQUENCY/TEST SIG LEVEL display: Test frequency, test signal voltage or current is displayed in a 2-1/2 digit decimal number with decimal point. The appropriate unit is indicated by unit lamp indicator adjacent to the numeric display. Test signal voltage or current is displayed only while either of the TEST SIG LEVEL CHECK buttons (10) is being pressed.

Figure 3-1. Front Panel Features (Sheet 1 of 4).



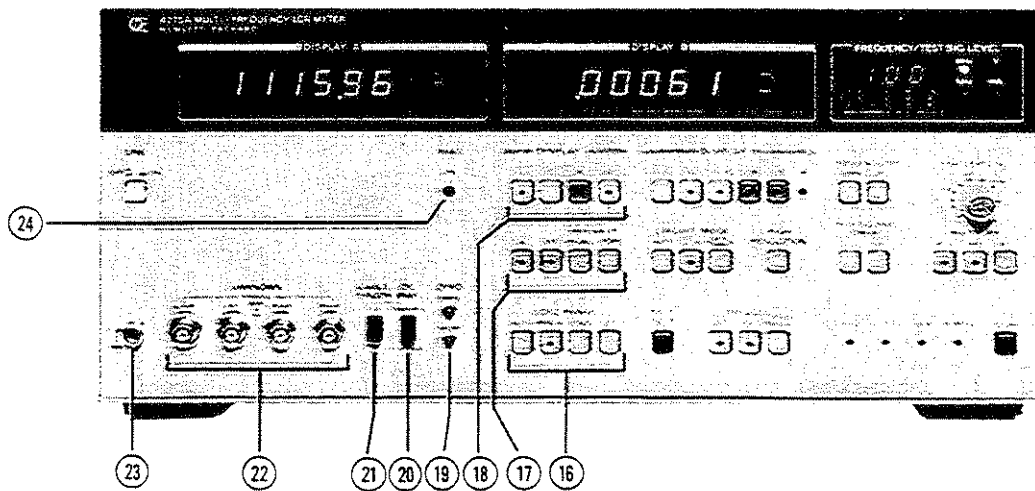
- ⑥ FREQUENCY STEP control: These pushbuttons select the desired test frequency from among a total of 12 available test frequencies (10 standard plus 2 optional). The test frequency changes in a higher frequency direction in a 1-2-4-10 sequence (for option 004 units, 1-3-5-10 sequence) each time UP button is pushed. Pressing DOWN button changes the frequency in the reverse sequence towards a lower frequency. The selected test frequency is displayed in the FREQUENCY/TEST SIG LEVEL display ⑤.
- ⑦ OSC LEVEL control: Continuously varies test signal level in a tenfold ratio from minimum to maximum on the amplitude range selected by MULTIPLIER ⑧.
- ⑧ MULTIPLIER: These pushbuttons select test signal level variable ranges: x 0.01 (1mV to 10mV), x 0.1 (10mV to 100mV) or x 1 (100mV to 1V).
- ⑨ HP-IB Status Indicators and LOCAL button: Four LED lamps for SRQ, LISTEN, TALK and REMOTE indicate status of interface between the 4275A (Option 101 or 102) and HP-IB controller. LOCAL button enables front panel control instead of remote control from HP-IB line.
- ⑩ TEST SIG LEVEL CHECK: These pushbuttons actuate the instrument to monitor the test signal level actually applied to the device under test. The test signal voltage or current is displayed instead of test frequency in FREQUENCY/TEST SIG LEVEL display ⑤ while "V" or "mA" button is being pressed.
- ⑪ HIGH RESOLUTION: This pushbutton enhances measurement resolution by averaging measured values over every ten measurements. Normal digit data plus lesser significant digit data are displayed at 1/8th the normal measuring rate.
- ⑫ TRIGGER: These pushbuttons select trigger mode for triggering measurement, INT, EXT or HOLD/MANUAL. INT key provides internal trigger which enables instrument to make repeated automatic measurements. In external trigger mode (EXT), a trigger signal must be applied to EXT TRIGGER input connector on rear panel. HOLD/MANUAL trigger mode provides a trigger signal for one measurement cycle each time this key is pushed.
- ⑬ CIRCUIT MODE: These pushbuttons select desired measurement circuit mode to be used for taking a measurement. Parallel (labeled ) selects a parallel circuit mode. A series equivalent circuit is set by series () pushbutton. When this function is set to AUTO, the instrument automatically selects appropriate parallel or series equivalent circuit.
- ⑭ SELF TEST: This pushbutton performs automatic check for diagnosing functional operations of the instrument. The diagnostic sequence is normally repeated until this button is again pressed to release the SELF TEST. If the instrument is faulty, a test step number is displayed at the point where the failure is detected.
- ⑮ DISPLAY B function selectors: These pushbuttons select subordinate component parameters to be simultaneously combined with the primary parameter which is set by DISPLAY A function selector ⑬. Each pushbutton selects a parameter as follows:
- D: Dissipation factor together with inductance or capacitance measurement.
 - Q: Quality factor together with inductance or capacitance measurement. Q values are calculated as the reciprocal number of the dissipation factor.
 - ESR/G: Equivalent Series Resistance or Conductance together with inductance or capacitance measurement. ESR is selected with series circuit mode measurement and conductance with parallel circuit mode measurement.

Figure 3-1. Front Panel Features (Sheet 2 of 4).



X/B: Reactance or Susceptance together with resistance measurement. Reactance is selected with series circuit mode measurement and susceptance with parallel circuit mode measurement.

L/C: Inductance or Capacitance together with resistance measurement. Inductance is selected with series circuit mode measurement and capacitance with parallel circuit mode measurement.

θ : This lamp indicates that a phase angle measurement is being made together with an impedance measurement. The lamp automatically lights when an impedance measurement function is set.

① LCRZ RANGE: These pushbuttons select ranging method for inductance, capacitance, resistance or impedance measurements.

AUTO: Optimum range for the sample value is automatically selected.

MANUAL: Measurement range is fixed (even when the sample is changed). Manual ranging is done by pressing adjacent DOWN or UP button.

Note

Pressing DOWN or UP button sets the ranging mode to MANUAL even if the MANUAL button has not previously been pressed.

① DISPLAY A Deviation Keys: These pushbuttons enable taking LCRZ deviation measurements on DISPLAY A ③. The deviation measurement function does not effect DISPLAY B functions.

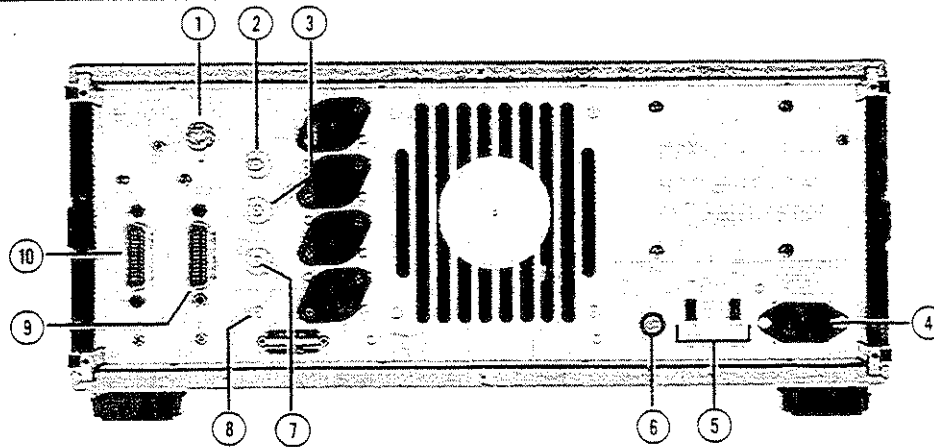
Δ Button: Difference in L, C, R or Z value between the measured value of the sample under test and the reference value obtained from the preceding measurement is displayed (in counts) in DISPLAY A ③ by pressing this button.

$\Delta\%$: The difference in percent deviation of a measured value from the reference value is displayed by pressing this button.

Figure 3-1. Front Panel Features (Sheet 3 of 4).

- RECALL: Reference value memorized in the instrument is displayed in DISPLAY A ③ while this button is being pressed.
- STORE: Measured value displayed in DISPLAY A ③ is stored in the internal memory of the instrument as the reference value when this button is pushed.
- ⑱ DISPLAY A function selector: These pushbuttons select primary component parameter to be measured as follows:
- L: Inductance together with subordinate dissipation factor (D), quality factor (Q), equivalent series resistance (ESR) or conductance (G).
 - C: Capacitance with one of the subordinate measurement parameters (same as those available for inductance measurements).
 - R: Resistance with subordinate reactance (X), susceptance (B), inductance (L) or capacitance (C).
 - |Z|: Absolute value of vector impedance ($|Z|$) with phase angle (θ) in degrees. The combination of these two parameter values is the vector impedance expression for the sample.
- ⑲ ZERO offset compensator: These pushbuttons perform proper compensation for cancelling stray capacitance, residual inductance, conductance, and resistance which is present when a test fixture or leads is connected to the UNKNOWN terminals. Before measurement is begun, the OPEN and SHORT button is pressed when the test fixture (leads) is terminated for the appropriate open and short condition, respectively, to automatically compensate the measured values for the effects of such residual parameters.
- ⑳ DC BIAS: This switch sets the limitation on applied dc bias voltage (either ± 35 volts or ± 200 volts) and qualifies test fixture (test leads) useable under dc bias operation. When this switch is set to $\pm 35V$ MAX, the maximum dc bias voltage is electrically limited to ± 35 volts. When switch is set to $\pm 200V$ MAX position, the connection of HP test fixtures designed for use at $\pm 35V$ and below is physically obstructed.
- ㉑ CABLE LENGTH: This switch is set to facilitate bringing the measuring bridge circuit to its optimum balance and for minimizing incremental measurement errors when standard test leads (1m long) are used. Use the 0 (zero) position for direct attachment type test fixtures and the 1m position for standard test leads. When this switch is set to its 1m position, compensation is appropriately made for high frequency measurements for any propagation loss and phase errors in the test leads.
- ㉒ UNKNOWN: These connectors provide the capability for connecting a sample to be measured in a four terminal pair configuration: High current terminal (H CUR), High potential terminal (H POT), Low potential terminal (L POT) and Low current terminal (L CUR). The four terminal pair configuration is constructed in conjunction with the test fixture or test leads connected to the UNKNOWN connectors.
- ㉓ GUARD Terminal: This terminal is connected to chassis ground of instrument and can be used as ground terminal in measurements which specifically require grounding.
- ㉔ BIAS indicator: This lamp lights and indicates that a dc bias voltage is being applied to the device under test (during dc bias operation).

Figure 3-1. Front Panel Features (Sheet 4 of 4).



- ① DC BIAS Selector Switch: This switch selects internal or external dc bias source to be used and is set for dc bias operating characteristics appropriate to the biasing application as follows:
- INT 35V/100V ($\leq .1\mu\text{F}$): With Option 001 or 002, internal dc bias voltage is applied to the capacitor sample. Bias voltage settling time is short. Capacitance value of sample should be 0.1 μF or less.
- INT 35V/100V ($\leq 200\mu\text{F}$): With Option 001 or 002, internal dc bias voltage can be applied to capacitor sample values up to 200 μF .
- OFF: No dc bias voltage is (internally or externally) applied to sample connected to UNKNOWN terminals.
- EXT $\pm 35\text{V MAX}$ (100mA MAX): External dc bias voltage can be applied to the capacitor sample up to a maximum of ± 35 volts through connector ② (when front panel DC BIAS switch is set to $\pm 35\text{V MAX}$ position).
- EXT $\pm 200\text{V MAX}$: External dc bias voltage can be applied to capacitor sample up to a maximum of ± 200 volts through connector ③ (when front panel DC BIAS switch is set to $\pm 200\text{V MAX}$ position).
- ② EXT $\pm 35\text{V MAX}$ (100mA MAX) Connector: External dc bias voltage can be applied to sample up to a maximum of ± 35 volts through this connector.
- ③ EXT $\pm 200\text{V MAX}$ Connector: External dc bias voltage can be applied to sample up to a maximum of ± 200 volts through this connector.
- ④ LINE Input Receptacle 48 - 66Hz: AC power cord is connected to this receptacle and ac power line.
- ⑤ LINE VOLTAGE SELECTOR Switches: These switches select appropriate ac operating power voltage from among 100, 120, 220V $\pm 10\%$ and 240V $+5\% - 10\%$, 48 - 66Hz.
- ⑥ LINE FUSE Holder: Instrument power line fuse is installed in this holder:
- 100/120V operation:
1.5AT (P/N 2110-0059)
- 220/240V operation:
750mAT (P/N 2110-0360)
- ⑦ INT DC BIAS MONITOR Connector: DC bias monitor output (useable for both internal and external dc bias operations). Output impedance 30k Ω .
- ⑧ EXT TRIGGER Connector: This connector is used for externally triggering the instrument by inputting an external trigger signal. TRIGGER switch on front panel should be set to EXT.
- ⑨ INT DC BIAS CONTROL Connector: With Option 001 or 002, HP 16023B DC BIAS CONTROLLER can be connected for remotely controlling internal dc bias voltage through this connector.
- ⑩ HP-IB Connector: With Option 101, HP-IB cable can be connected to intercommunicate with other HP-IB devices through the bus line cable.

Figure 3-2. Rear Panel Features.

3-8. MEASUREMENT FUNCTION.

3-9. The Model 4275A makes simultaneous measurements of two independent parameters in each measurement cycle. This combination of measurement parameters represents both the resistive and reactive characteristics of the sample. The total of 13 measurement functions (three among them are duplicates) are classified, for display purposes, into two groups: DISPLAY A and DISPLAY B functions. DISPLAY A function group comprises the primary measurement parameters including L (inductance), C (capacitance), R (resistance) and |Z| (impedance). Pushbutton colors correspond with these functions. This correspondence with DISPLAY B functions is described later. Measured values are displayed in DISPLAY A section at top left of front panel. The 4275A is also capable of deviation measurements which are associated with the DISPLAY A functions. When the STORE mode operation is enabled, the 4275A memorizes the measured value (DISPLAY A) as the reference value. The difference between the subsequent measurement and the reference value is displayed in the form of a subtraction as a Δ (delta) measurement or as a percent deviation $\Delta\%$ (delta percent) measurement.

DISPLAY B functions include a group of subordinate measurement parameters, the availabilities of which are partially dependent on the primary function selected. The following parameters are included: D (dissipation factor), Q (quality factor), ESR/G (equivalent series resistance/conductance), X/B (reactance/susceptance), L/C (inductance/capacitance and θ (phase angle). D, Q, ESR and G measurements can be made with L or C measurements. X, B, L and C measurements are possible in R measurements. A θ measurement is possible only with a |Z| measurement. Note that the choice of panel selectable functions combined with a slash (/) are related to CIRCUIT MODE settings. The relationships of the combinability of subordinate parameters to major measurement parameters are summarized in Table 3-1. Measurement parameter formulas for measurement functions are given in Table 3-2.


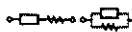
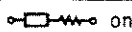


















The Dual function keys ESR/G, X/B and L/C for DISPLAY B function controls are defined with and subject to the selected CIRCUIT MODE. To facilitate selection of the appropriate function keys, pushbutton labels for the ESR, X and L functions as well as for series circuit mode () identification are uniformly colored in mint gray.



Table 3-1. Available Measurement Functions.

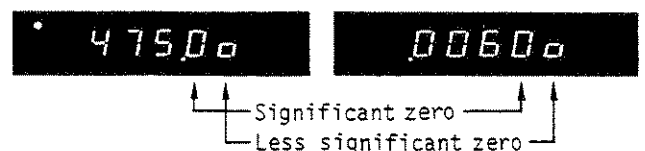
DISPLAY A	DISPLAY B		
		 only	 only
L 	D  	ESR/ 	/G 
C 	D  	ESR/ 	/G 
R 		X/  L/ 	/B  /C 
Z 	θ 		

3-10. DISPLAY.

3-11. Two primary display sections and a sub-display section provide visual data outputs of measurement results as well as of the test parameter values employed for the measurement. DISPLAY A provides a readout of the measured inductance, capacitance, resistance or impedance values in a maximum 6 digit decimal number with decimal point and appropriate unit. If measurement is not achieved because of inappropriate panel control settings or by incorrectly connecting the sample, an alphabetic annunciation (either OF, UF, or Err) is displayed.

DISPLAY B gives subordinate measurement data such as dissipation factor, quality factor, equivalent series resistance or conductance in inductance or capacitance measurements; reactance, susceptance inductance or capacitance in resistance measurements; or the phase angle in impedance measurements. The 6 digit numeric DISPLAY B becomes blank when measurement data for DISPLAY A cannot be properly taken.


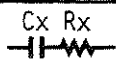
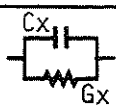
In the numeric displays, lesser significant digit data is represented by a small zero () figure to differentiate it from a significant figure which is represented by a large zero ().


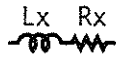
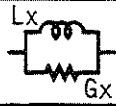




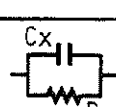
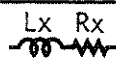
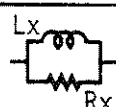
Note

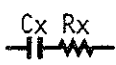
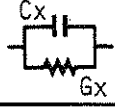
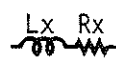

Less significant digit data identify the meaningless numbers related to the uncertainty of the measurement result.

Table 3-2. Measurement Parameter Formulas.

C 	DISPLAY A		DISPLAY B				
	C	Z	D	Q	ESR	G	θ
	Cx	$\sqrt{\frac{1}{\omega^2 Cx^2} + Rx^2}$	$\omega Cx Rx$	$\frac{1}{\omega Cx Rx}$	Rx	—	$-\tan^{-1}\left(\frac{1}{\omega Cx Rx}\right)$
	Cx	$\frac{1}{\sqrt{\omega^2 Cx^2 + Gx^2}}$	$\frac{Gx}{\omega Cx}$	$\frac{\omega Cx}{Gx}$	—	Gx	$-\tan^{-1}\left(\frac{\omega Cx}{Gx}\right)$

L 	DISPLAY A		DISPLAY B				
	L	Z	D	Q	ESR	G	θ
	Lx	$\sqrt{\omega^2 Lx^2 + Rx^2}$	$\frac{Rx}{\omega Lx}$	$\frac{\omega Lx}{Rx}$	Rx	—	$\tan^{-1}\left(\frac{\omega Lx}{Rx}\right)$
	Lx	$\frac{\omega Lx}{\sqrt{1 + \omega^2 Lx^2 Gx^2}}$	$\omega Lx Gx$	$\frac{1}{\omega Lx Gx}$	—	Gx	$\tan^{-1}\left(\frac{1}{\omega Lx Gx}\right)$

R 	DISPLAY A		DISPLAY B				
	R	Z	X	B	L	C	θ
	Rx	$\sqrt{Rx^2 + \frac{1}{\omega^2 Cx^2}}$	$-\frac{1}{\omega Cx}$	—	—	—	$-\tan^{-1}\left(\frac{1}{\omega Cx Rx}\right)$
	Rx	$\frac{Rx}{\sqrt{1 + \omega^2 Cx^2 Rx^2}}$	—	ωCx	—	Cx	$-\tan^{-1}(\omega Cx Rx)$
	Rx	$\sqrt{\omega^2 Lx^2 + Rx^2}$	ωLx	—	Lx	—	$\tan^{-1}\left(\frac{\omega Lx}{Rx}\right)$
	Rx	$\frac{\omega Lx Rx}{\sqrt{Rx^2 + \omega^2 Lx^2}}$	—	$-\frac{1}{\omega Lx}$	—	—	$\tan^{-1}\left(\frac{Rx}{\omega Lx}\right)$

Z				
Z	$\sqrt{\frac{1}{\omega^2 Cx^2} + Rx^2}$	$\frac{1}{\sqrt{\omega^2 Cx^2 + Gx^2}}$	$\sqrt{\omega^2 Lx^2 + Rx^2}$	$\frac{\omega Lx}{\sqrt{1 + \omega^2 Lx^2 Gx^2}}$
θ	$-\tan^{-1}\left(\frac{1}{\omega Cx Rx}\right)$	$-\tan^{-1}\left(\frac{\omega Cx}{Gx}\right)$	$\tan^{-1}\left(\frac{\omega Lx}{Rx}\right)$	$\tan^{-1}\left(\frac{1}{\omega Lx Gx}\right)$

$$Z = R + jx = |Z| (\cos \theta + j \sin \theta), \quad |Z| = \sqrt{R^2 + X^2}$$

The third readout is the FREQUENCY/TEST SIG LEVEL display section and provides for displaying test parameter data, that is, voltage, current or the frequency of the test signal applied to the sample under test. The parameter data displayed by the 3 digit decimal numbers are convenient for monitoring, adjusting and recording the test conditions. When monitoring test current, an OF (Over-Flow) annunciation may be displayed when a very low impedance sample is connected to the UNKNOWN terminals.

3-12. TEST SIGNALS.

3-13. A total of 10 test signal frequencies which have a frequency accuracy of 0.01% are available in a standard instrument. Table 3-3 is a tabulation of available test signal level ranges and spot frequency points. The test frequencies are switchable and can be selected in 1-2-4-10 sequence from 100kHz to 10MHz by the FREQUENCY STEP control. The selected frequency is displayed in a three digit decimal number with appropriate frequency unit indication in the FREQUENCY/TEST SIG LEVEL display. The two additional test frequencies with which the instrument can be optionally equipped can further enhance the multi-frequency measurement capability of the 4275A.

The test signal is a sinusoidal waveform and can be set at the desired amplitude in the range of 1mV to 1Vrms by the OSC LEVEL control and MULTIPLIER buttons. A high level test signal is usually used for the measurement of general capacitors, resistors and certain kinds of inductive components which are normally operated at such high signal level. On the other hand, a low test signal is suitable for the measurement of low signal level operating devices and of non-linear impedance elements, especially semiconductor devices. Furthermore, by using the appropriate test levels and frequencies as test parameters, a particular characteristic or a change in value of the sample can be represented graphically (such as is done to characterize an inductor with a highly permeable core, a transformer or other devices over their operating ranges).

Note

After changing the frequency, MULTIPLIER or OSC LEVEL setting, allow the following times for the test signal to stabilize:

Control		Settling time
MULTIPLIER	X 1	200ms
	X 0.1	
	X 0.01	1000ms
OSC LEVEL		3s
Frequency		200ms

When the TEST SIG LEVEL CHECK button is pushed, an auto-ranged readout of the test signal voltage or current actually applied to the device under test may be observed in the FREQUENCY/TEST SIG LEVEL display. While the V or mA check button is pressed, the test level is monitored. Measurement of the sample is disabled and the measured values obtained in the preceding measurement are held until the check button is released.

While monitoring the values on the display, the test signal level and test frequency may be chosen so that these values can be set near those of the normal operating conditions of the device under test. In this way, data is obtained under the virtual operating conditions of the device. This is especially useful in design or in other objectives where the data gathered should be done so under near-actual operating conditions.

Table 3-3. Test Signal Level and Frequencies.

	MULTIPLIER setting	OSC LEVEL control range
Test Signal Level	X 0.01 X 0.1 X 1	1mV to 10mV 10mV to 100mV 100mV to 1V
Test Frequency	10kHz, 20kHz, 40kHz, 100kHz, 200kHz, 400kHz, 1MHz, 2MHz, 4MHz, 10MHz, and two optional frequencies.	

3-14. MEASUREMENT RANGES.

3-15. The 4275A covers minimum to maximum measurable values in 8 basic ranges for each of the selectable measurement parameters. To span the entire inductance and capacitance range of the instrument, the 8 basic ranges cover 9 virtual ranges depending on the value of the measured parameters and the test frequency (setting). Each range allows a 100% overrange of the 100000 full scale counts (maximum 199999 counts). Table 3-4 shows available measurement ranges for both the parallel and series circuit measurement modes. When the LCRZ RANGE control is set to AUTO, an optimum range is automatically selected for each measurement. Manual ranging is also feasible. Ranging for DISPLAY B functions is fully automated. When range setting is inappropriate, OF (OverFlow) or UF (UnderFlow) is displayed in DISPLAY A or DISPLAY B.

Voltage and current ranges for the TEST SIG LEVEL CHECK are automatically set in accord with the ranging program which is predetermined dependent upon the MULTIPLIER range setting (and, in like manner, LCRZ RANGE for the test current check). The available ranges are shown in Table 3-5.

Table 3-5. Test Signal Level Check Ranges.

	Test Signal Level	
	V	mA
Ranges	.00 - 1.00*	.0 - 10.0*
	.000 - .100*	.00 - 1.00*
	.000 - .010*	.000 - .100*

*Note: Approximate value (unspecified).

3-16. CIRCUIT MODE.

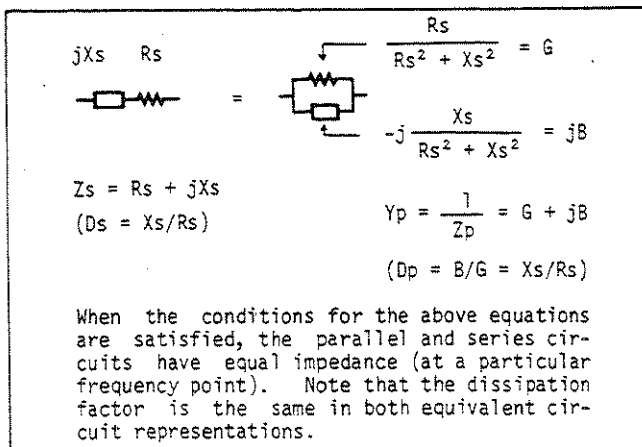
3-17. An impedance element can be represented by a simple equivalent circuit which is comprised of resistive and reactive elements each connected in series with or in parallel with the other. This representation is possible by either of the (series and parallel) equivalents because both have identical impedances at the selected measurement frequency by properly establishing the values of the equivalent circuit elements. The equivalent circuit to be measured is selected by setting the CIRCUIT MODE control. When the CIRCUIT MODE is set to AUTO, the 4275A will automatically select either parallel or series equivalent circuit mode as appropriate to the range and function settings. By setting CIRCUIT MODE manually, either of the circuit modes is useable on all LCR IZID and Q

3-10

3-18. Parameter values for a component measured in a parallel equivalent circuit and that measured in series equivalent circuit are different from each other. The difference in measured values is related to the loss factor of the sample to be measured. Obviously, if no series resistance or parallel conductance is present, the two equivalent circuits are identical.

However, a sample value measured in a parallel measurement circuit can be correlated with that of a series circuit by a simple conversion formula which considers the effect of dissipation factor. See Table 3-6. Figure 3-3 graphically shows the relationships of parallel and series parameters for various dissipation factor values. Applicable diagrams and equations are given in the chart. For example, a parallel capacitance (Cp) of 1000pF with a dissipation factor of 0.5, is equivalent to a series capacitance (Cs) value of 1250pF with an identical dissipation factor. As shown in Figure 3-3, inductance or capacitance values for parallel and series equivalents are nearly equal when the dissipation factor is less than 0.03. The dissipation factor of a component always has the same value at a given frequency for both parallel and series equivalents.

In ordinary LCR measuring instruments, the measurement circuit is set (automatically or manually) to a predetermined equivalent circuit with respect to either the selected range or to the dissipation factor value of the sample. The wider circuit mode selection capability of the 4275A, which is free from these restrictions, permits taking measurements in the desired circuit mode and of comparing such measured values directly with those obtained by another instrument. This obviates the inconvenience and necessity of employing instruments capable of taking measurements with the same equivalent circuit to assure measurement result correspondence.

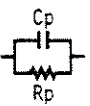

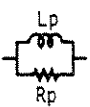



The measurement circuit used should be the one that approximates the actual equivalent circuit of the sample to be measured. However, there is no convenient criteria for reasonably selecting the appropriate measurement circuit for general components. Usually, a series measurement circuit is employed for the measurement of a low impedance sample and a parallel measurement circuit for a sample of high impedance. For example, in a low capacitance sample such as a ceramic capacitor, parallel conductance is the major contributor to loss. On the other hand, for a high capacitance sample such as an electrolytic capacitor, the equivalent series resistance consisting of lead resistance, electrode resistance, dielectric loss, etc. is the main factor which contributes to the loss of the component. For middle range impedances, this reasoning still applies, but the effects are less pronounced. Figure 3-4 shows the rough

relationships between the appropriate measurement circuit mode and sample values.

An empirical method of choosing the appropriate measurement circuit is to infer the actual equivalent circuit of the sample from the results of a trial measurement. Dependency of the dissipation factor (quality factor) upon test frequency offers a theoretical basis for such inference. The loss factor of series capacitance loss increases at a higher frequency. The parallel loss of a capacitor will exhibit the opposite tendency. Also, for inductors, the equivalent circuit can be deduced by a similar course of reasoning. Therefore, the measurement circuit appropriate to the sample can be determined by comparison of the dissipation factor values obtained at the desired test frequency and that obtained at another frequency near to the selected test frequency.

Table 3-6. Dissipation Factor Equations.

Circuit Mode	Dissipation Factor	Conversion to other modes
	$D = \frac{1}{2\pi f C_p R_p} = \frac{1}{Q}$	$C_s = (1 + D^2) C_p$ $R_s = \frac{D^2}{1 + D^2} R_p$
	$D = 2\pi f C_s R_s = \frac{1}{Q}$	$C_p = \frac{1}{1 + D^2} C_s$ $R_p = \frac{1 + D^2}{D^2} R_s$
	$D = \frac{2\pi f L_p}{R_p} = \frac{1}{Q}$	$L_s = \frac{1}{1 + D^2} L_p$ $R_s = \frac{D^2}{1 + D^2} R_p$
	$D = \frac{R_s}{2\pi f L_s} = \frac{1}{Q}$	$L_p = (1 + D^2) L_s$ $R_p = \frac{1 + D^2}{D^2} R_s$

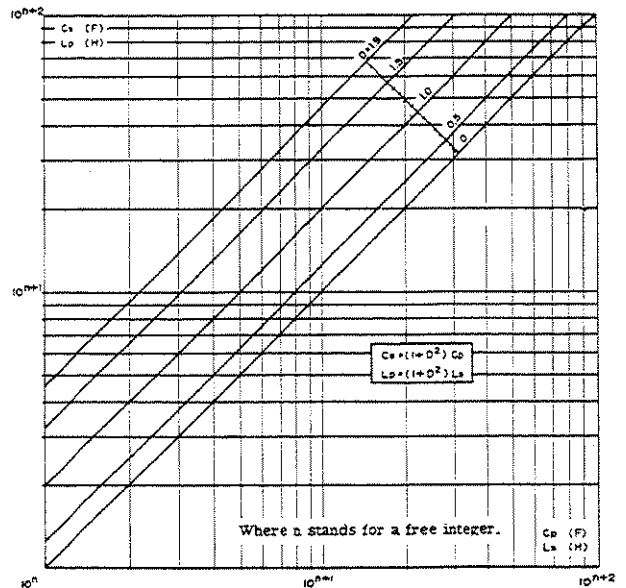


Figure 3-3. Parallel and Series Parameter Relationships.

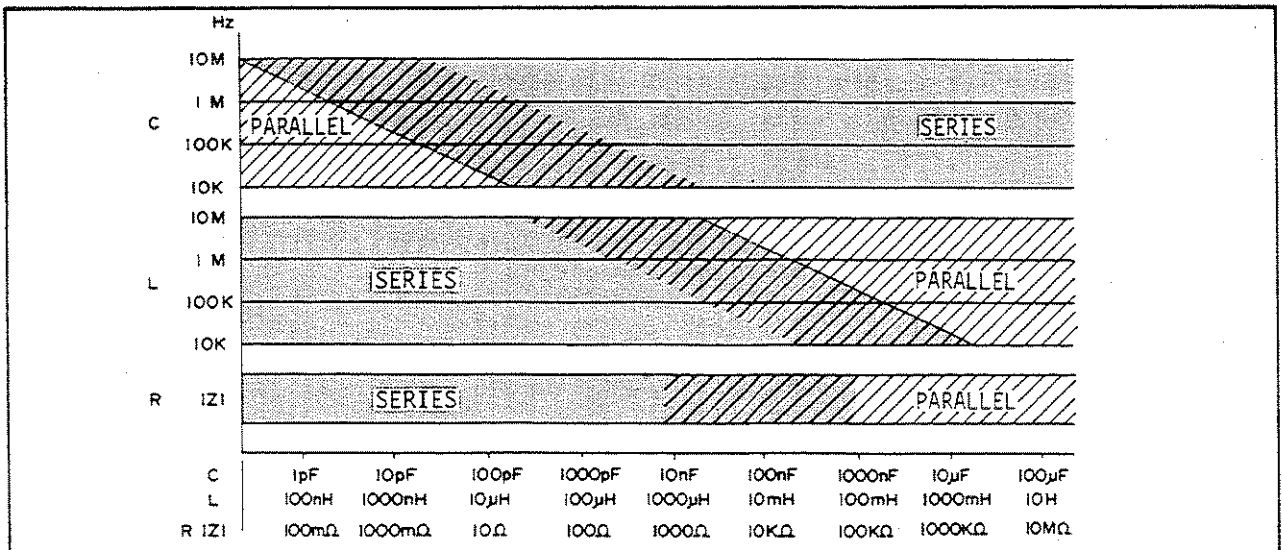
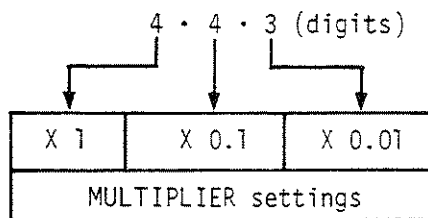


Figure 3-4. Approximate Relationships of Sample Values to Equivalent Circuit.

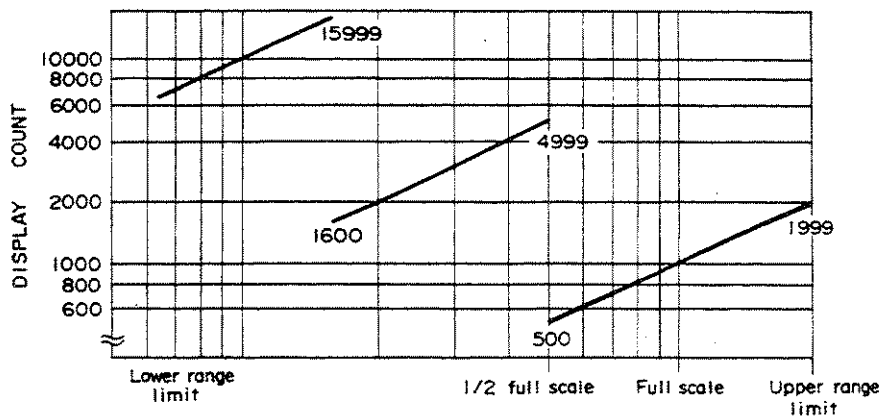
Table 3-4. Measurement Ranges and Number of Display Digits (sheet 1 of 5).

NUMBER OF DISPLAY DIGITS

Tables 1 through 7 show the number of significant digits displayed for each of the 4275A measurement parameters. The three numeral combinations in the tables indicate the numbers of digits displayed in the respective range and test frequency areas. That is, the numerals of each set indicate, respectively, the number of digits displayed depending on test signal level MULTIPLIER settings (X 1, X 0.1 or X 0.01) as follows:



On 3 digit full scale ranges (at MULTIPLIER X 1 settings), when the measured sample value is small compared to full scale range value, the number of digits displayed is automatically increased as illustrated below:



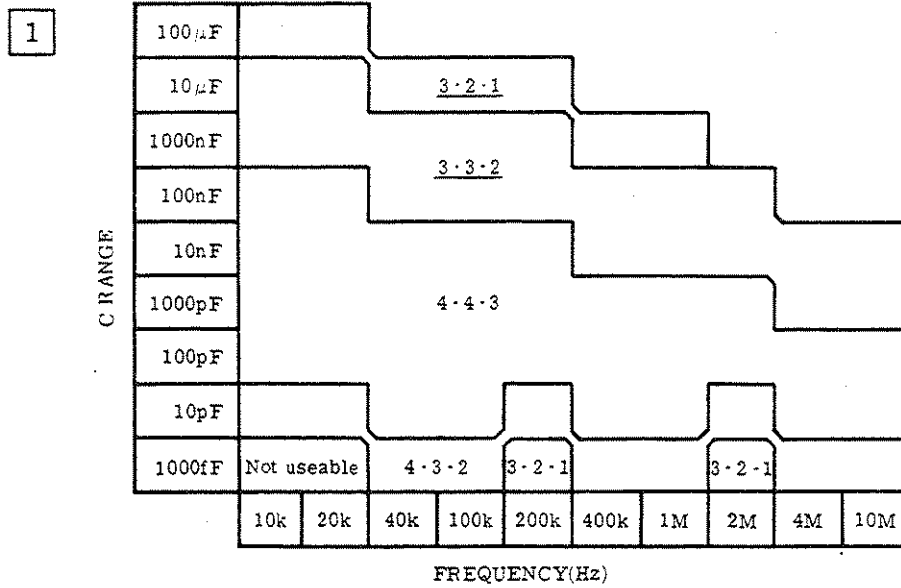
For example, on the 1000nF capacitance range, measurement results are displayed from 500nF to 1999nF in 3-1/2 digits, from 160.0nF to 499.9nF in 4 digits and from the lower range limit to 159.99nF in 4-1/2 digits (note that this is not owing to a change of range but in resolution). Therefore, accuracy and resolution, virtually equal to that on 4 digit full scale ranges, is realized on 3 digit ranges. The display of measured values also follows in the same manner (when MULTIPLIER is set to X 0.1 or X0.01). In Tables 1 through 7, the ranges on which measured values are displayed in such manner are denoted by underlining of the numbers of digits.

Note

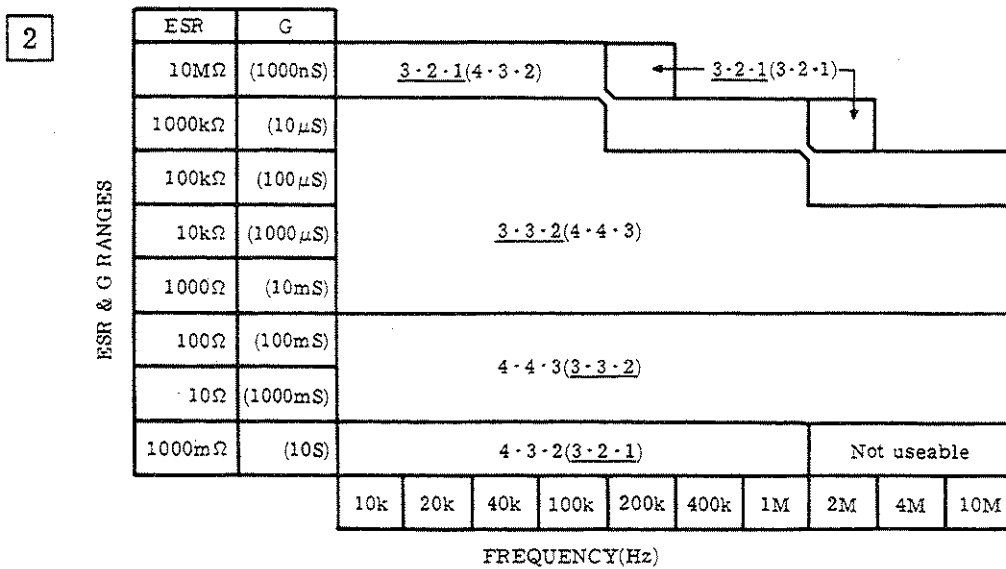
On basic 3 digit ranges, the parameter values to be displayed are obtained from reciprocal parameter measurements. Thus, measurement resolution becomes higher for lower sample values (at the selected range) and, accordingly, the numbers of digits displayed is changed to afford the best of the measurement capabilities.

Table 3-4. Measurement Ranges and Number of Display Digits (sheet 2 of 5).

NUMBER OF CAPACITANCE DISPLAY DIGITS.



NUMBER OF DISPLAY DIGITS FOR ESR AND G IN C-ESR/G MEASUREMENT.



Note: 1) ESR and G ranges are automatically set depending on C range setting.

2) Digit numbers in parentheses apply to conductance ranges.

Table 3-4. Measurement Ranges and Number of Display Digits (sheet 3 of 5).

NUMBER OF INDUCTANCE DISPLAY DIGITS.

L RANGE	100H	3-2-1									
	10H										
	1000mH										
	100mH										
	10mH	3-3-2									
	1000μH										
	100μH										
	10μH	4-4-3									
	1000nH	4-3-2									
	100nH	Not useable					Not useable				
	10k	20k	40k	100k	200k	400k	1M	2M	4M	10M	
FREQUENCY(Hz)											

NUMBER OF DISPLAY DIGITS FOR ESR AND G IN L-ESR/G MEASUREMENT.

ESR & G RANGES	ESR	G										
	10MΩ	(1000nS)	3-2-1(4-3-2)									
	1MΩ	(10μS)										
	100kΩ	(100μS)										
	10kΩ	(1000μS)	3-3-2(4-4-3)									
	1000Ω	(10mS)										
	100Ω	(100mS)	4-4-3(3-3-2)									
	10Ω	(1000mS)										
	1000mΩ	(10S)	4-3-2(3-2-1)					Not useable				
			10k	20k	40k	100k	200k	400k	1M	2M	4M	10M
FREQUENCY(Hz)												

Note: 1) ESR and G ranges are automatically set depending on L range setting.
2) Digit numbers in parentheses apply to conductance ranges.

Table 3-4. Measurement Ranges and Number of Display Digits (sheet 4 of 5).

**NUMBER OF CAPACITANCE DISPLAY DIGITS
IN R-C MEASUREMENT.**

C RANGE	100 μ F											
	10 μ F	3-2-1										
	1000nF	3-3-2										
	100nF	4-4-3										
	10nF	4-4-3										
	1000pF	4-4-3										
	100pF	4-4-3										
	10pF	4-4-3										
	1000fF	Not useable	4-3-2			*				*		
		10k	20k	40k	100k	200k	400k	1M	2M	4M	10M	

FREQUENCY(Hz)

Note: 1) C range is automatically set depending on R range setting.
2) *Not useable ranges.

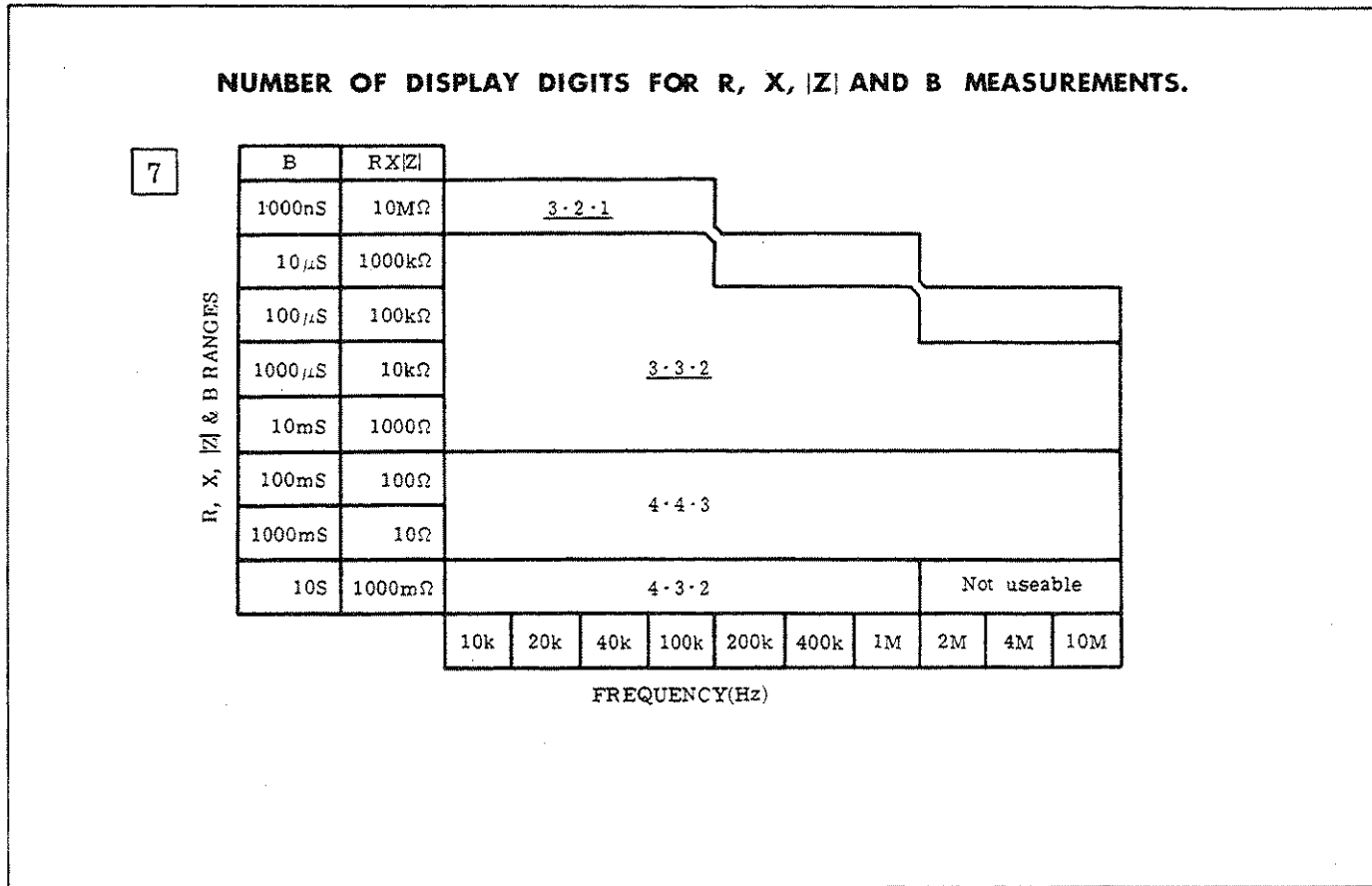
**NUMBER OF INDUCTANCE DISPLAY DIGITS
IN R-L MEASUREMENT.**

L RANGE	100H	3-2-1									
	10H	3-2-1									
	1000mH	3-2-1									
	100mH	3-2-1									
	10mH	3-3-2									
	1000 μ H	3-3-2									
	100 μ H	4-4-3									
	10 μ H	4-4-3									
	1000nH	4-3-2									
	100nH	Not useable						Not useable			
	10k	20k	40k	100k	200k	400k	1M	2M	4M	10M	

FREQUENCY(Hz)

Note: L range is automatically set depending on R range setting.

Table 3-4. Measurement Ranges and Number of Display Digits (sheet 5 of 5).



Note

On three digit display ranges, when DISPLAY A readout is lower than 1599 counts on an automatically selected range and greater than the lower range limit of the next upper range, the measurement data can be given higher resolution by manually setting the range to the upper range.

Example.	Sample value	Range Mode	Range Setting	Display
	10kΩ	AUTO	10kΩ	10.00kΩ
	10kΩ	MANUAL	100kΩ	10.000kΩ

3-19. INITIAL DISPLAY AND INDICATIONS.

3-20. When LINE button is depressed to turn instrument on, the 4275A exhibits the normal test result of initial function test by a left to right progression of the figure **F**. If all of the test results are correct, a total of five **F** figures appear in the DISPLAY A as shown below:




Next, alphabetic annunciation of the option(s), if installed in the instrument, is momentarily displayed. The option annunciation is given for HP-IB Compatible, Internal DC Bias Supply and Battery Memory Back-up options. Installed option contents are displayed as shown below:



The meanings of the option annunciations are outlined in paragraph 3-55.

3-21. INITIAL CONTROL SETTINGS.

3-22. One of the convenient functions which facilitate ease of operation is the automatic initial control settings performed after the instrument is turned on. Initial panel control functions are automatically set as follows:

- DISPLAY A C
- LCRZ RANGE AUTO
- Deviation measurement off
- DISPLAY B D
- CIRCUIT MODE AUTO ()
- HIGH RESOLUTION off
- SELF TEST off
- TRIGGER INT
- Frequency 1.00MHz
- MULTIPLIER X1

These initial settings establish the general capacitance measurement conditions applicable to a broad range of capacitance measurements. After doing ZERO offset control (see Paragraph 3-29) with respect to the test fixture used with the instrument, a capacitance can usually be measured by merely connecting the sample to the test fixture. Inductance, resistance or impedance can be measured by pressing L, R or |Z| buttons as appropriate. When a different measurement is to be attempted, press appropriate pushbuttons and select desired functions.

3-23. UNKNOWN TERMINALS.

3-24. For connecting the sample to be tested, the 4275A employs measurement terminals in a four terminal pair configuration which has a significant measuring advantage for component parameter measurements requiring high accuracy in the high frequency region. Generally, any mutual inductance, interference of the measurement signals and unwanted residual factors in the connection method which are incidental to ordinary terminal methods have significant effects on the measurement at a high frequency. The four terminal pair configuration measurement permits easy, stable and accurate measurements and avoids the measurement limitations inherent in such effects. To construct this terminal architecture, connection of a sample to the instrument requires the use of a test fixture or test leads in a four terminal pair configuration design.

The UNKNOWN terminals consists of four connectors: High current (H_{CUR}), High potential (H_{POT}), Low potential (L_{POT}) and Low current (L_{CUR}). The purpose of the current terminals is to cause a measurement signal current to flow through the sample. The potential terminals are for detecting the voltage drop across the sample. The high side signifies the drive potential (referenced to low side potential) drawn from the internal measurement signal source. To compose a measurement circuit loop in a four terminal pair configuration, the H_{CUR} and H_{POT}, L_{POT} and L_{CUR} terminals must be respectively connected together and, in addition, the shields of all conductors must be connected together (as shown in Figure 3-5). Principle of the four terminal configuration measurement is illustrated in Figure 3-6. At first glance, the arrangement appears to be an expanded four terminal method with a built-in guard structure. This is true. Thus, the four terminal pair method combines the advantages of the

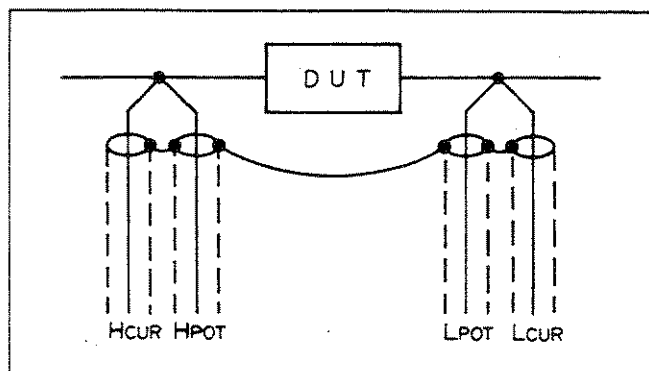


Figure 3-5. Four Terminal Pair DUT Connections.

four terminal method in low impedance measurements while providing the shielding effects required for high impedance measurements. The distinctive feature of the four terminal pair configuration is that the outer shield conductor works as the return path for the measurement signal current. The same current flows through both the center conductors and the outer shield conductors (in opposite directions) yet no external magnetic fields are generated around the conductors (the magnetic fields produced by the inner and outer currents completely cancel each other). Because the measurement signal current does not develop an inductive magnetic field, the test leads do not contribute additional measurement errors due to self or mutual inductance between the individual leads. Hence, the four terminal pair method enables measurements with best accuracy minimizing any stray capacitance and residual inductance in the test leads or test fixture.

Note

If residual inductance does exist in test leads, it affects measurements and the resultant additional measurement error increases, in capacitance measurements, in proportion to the square of the measurement frequency.

3-25. Measurement of Grounded Samples.

3-26. Theoretically, samples which have one terminal (except guard terminal) grounded to earth can not normally be measured by the 4275A. Such measurement conditions are, for example, the distributed capacitance measurement of a coaxial cable with a grounded shield conductor or the input/output impedance measurement of a single ended amplifier. When a one-side-grounded sample is connected for measurement, the 4275A may display an error message or incorrect measurement results. This is because the bridge section cannot achieve a balance with any measurement terminal grounded and, additionally, any grounding modifies the four terminal pair measurement architecture (other than an internal connection of the shield conductor to instrument chassis at one point).

Note

If one terminal is grounded, a signal current of equal magnitude (an operating condition of the four terminal measurement configuration) will not flow in the inner and outer conductors of the measurement cable.

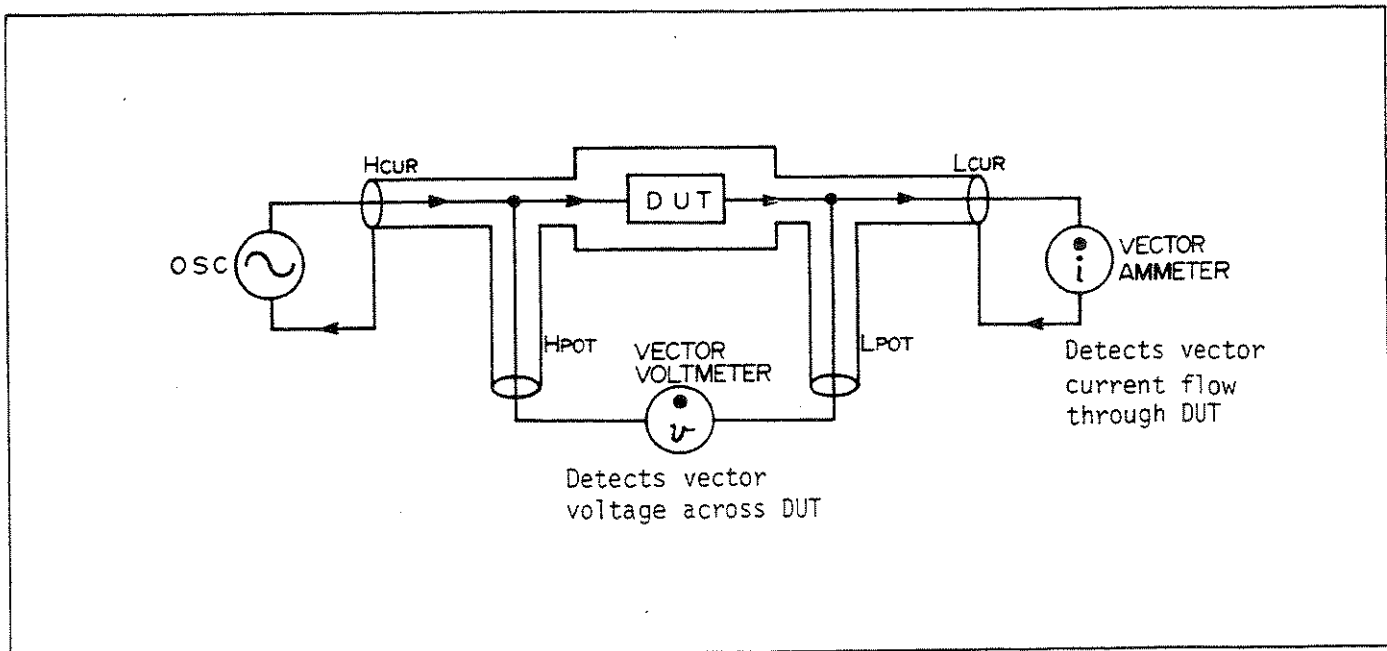


Figure 3-6. Four Terminal Pair Measurement Principle.

Contrary to these theoretical measurement limitations, the 4275A will, in most cases, measure a grounded sample when such an attempt is made. Actually, a measurement can be taken if a certain magnitude of impedance (larger than that of the unknown sample) is present between the grounding point of the sample and instrument ground. Therefore, the measurements cited as examples are feasible with the 4275A. As the measurement of a grounded sample depends on the magnitude of the grounding impedance, measurement accuracy is unspecified. Available measurement range may be restricted (an error message is displayed on unuseable ranges).

3-27. SELECTION OF TEST CABLE LENGTH.

3-28. The propagation signal in a transmission line will develop a change in phase between two points on the line as illustrated in Figure 3-7. The difference in phase corresponds to the ratio of the distance between the two points to the wavelength of the propagating signal. Consequently, owing to their length, test cables for connecting a sample will cause a phase shift and a propagation loss of the test signal. For example, the wavelength of a 10MHz test signal is 30 meters which is 30 times as long as the 1m standard test cables. Here, the phase of the test signal at the end of the test cable will have been shifted by about 12 degrees ($360^\circ \div 30$) as referenced to the phase at the other end of the cable. Since the effect of test cables on measurements and the resultant

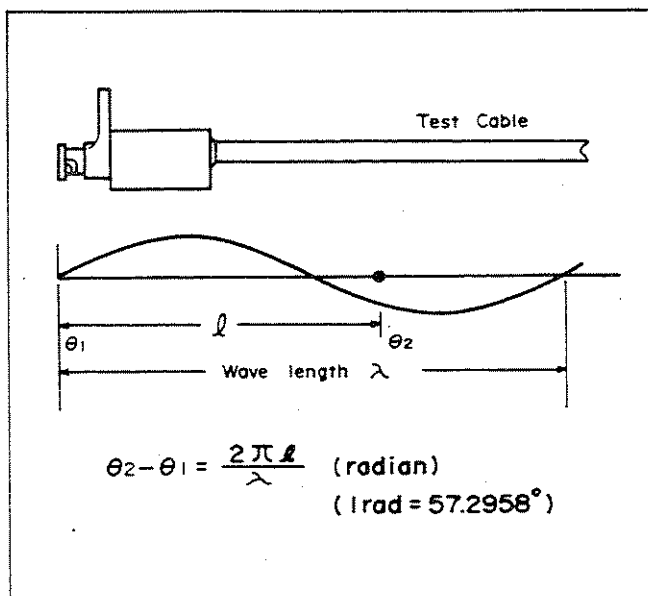


Figure 3-7. Test Signal Phase on Test Cables.

measurement error increase in proportion to test frequency, cable length must be taken into consideration in high frequency measurements. The CABLE LENGTH switch selects measuring circuitry for the 1 meter standard test cables or for a test fixture attached direct to the UNKNOWN terminals. When standard 1m test cables are used for measurements, the CABLE LENGTH switch is set to the "1m" position to properly adapt measuring circuit for the test cables and to minimize additional measurement errors. "0" position is selected for direct attachment type test fixtures.

Note

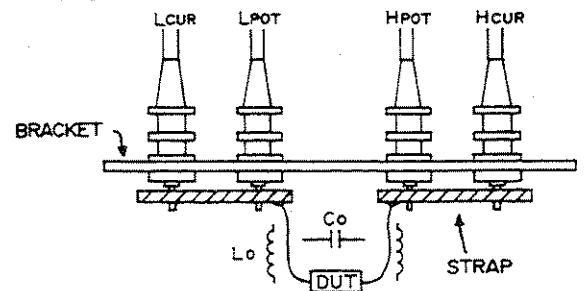
When the HP 16047B Test Fixture is used with the 4275A, set CABLE LENGTH switch to 1m position.

Note

If test cable is longer or shorter than the standard 1m test cable, the additional error contributed is proportional to the square of the frequency and is 3% for each 10cm change at 10MHz. As the characteristic impedance of the test cable is also a factor in the propagation loss and phase shift (and of resultant measurement error), using different type test cables must be avoided. Be sure to use the standard test cables available through Hewlett-Packard.

Note

To minimize incremental measurements errors at frequencies above 4MHz when the UNKNOWN terminals are extended using 1 meter cables, the four-terminal-pair must be converted into a three-terminal configuration at the cable ends by shorting the Low side cables and the High side cables with low impedance straps as illustrated below. The error causing residuals, L_o and C_o , are shown in the figure. This method, however, cannot be used for inductance measurements on DUTs of from 400nH to 3μH when the test frequency is a special option frequency from 4MHz to 10.7MHz. In this case, the UNKNOWN terminals must not be extended using 1 meter cables; measurement must be made at the UNKNOWN terminals.



3-29. ZERO OFFSET ADJUSTMENT.

3-30. Since test fixtures have individual, inherent stray capacitances, residual inductances and resistances, the measured values may be unacceptably influenced depending on the measurement range and the magnitudes of the residual parameters. The ZERO offset adjustment function of the 4275A automatically performs optimum compensation for such residual factors in the test fixture and minimizes the incremental measurement errors. Any measurement error particular to the test fixture used is therefore eliminated. Here is how to cancel out the effect of residuals with the offset adjustment:

CAUTION

BEFORE PROCEEDING WITH ZERO OFFSET ADJUSTMENT, VERIFY THAT BIAS INDICATOR LAMP IS NOT LIT. IF ILLUMINATED, SET REAR PANEL DC BIAS SWITCH TO OFF.

- 1) Connect test fixture or test leads to the 4275A UNKNOWN terminals. Connect nothing to the test fixture or to test leads (as a DUT).
- 2) Set MULTIPLIER to X1 and OSC LEVEL control to its fully cw position, and other controls for the desired function, frequency, circuit mode, etc.
- 3) Press ZERO OPEN button. This automatically sets the instrument to C-G measurement mode. DISPLAY A exhibits "CAL" while stray capacitance and conductance values are being measured at each test frequency. The test frequency display is switched, in turn,

to successingly lower frequencies from 10MHz (10MHz, 4MHz, 2MHz ... 10kHz). Lastly, all panel control functions are restored to the settings given in step 2 (about 5 seconds after pressing OPEN button).

- 4) Short-circuit test fixture or test leads with a low impedance shorting strap.
- 5) Press ZERO SHORT button. This automatically sets instrument to L-ESR measurement mode. A sequential measurement is performed with respect to residual inductance and resistance in the same manner as that in the ZERO OPEN offset adjustment operation (in step 3). The instrument is now ready to take measurements.

(When the ZERO offset adjustments are performed in high resolution mode (to measure small values with high accuracy), "CAL" is displayed about 15 seconds.)

For succeeding measurements, the measured values are now always automatically compensated for the stray capacitance, residual inductance, conductance and resistance which are present in the particular test fixture or test leads being used with the instrument. The 4275A calculates optimum compensation quantities from the memorized residual parameter values each time a measurement is taken and, accordingly, compensates the measured sample value. Offset adjustment ranges are:

- Capacitance: up to 20pF
- Inductance: up to 2000nH
- Resistance: up to 500mΩ
- Conductance: up to 5μS

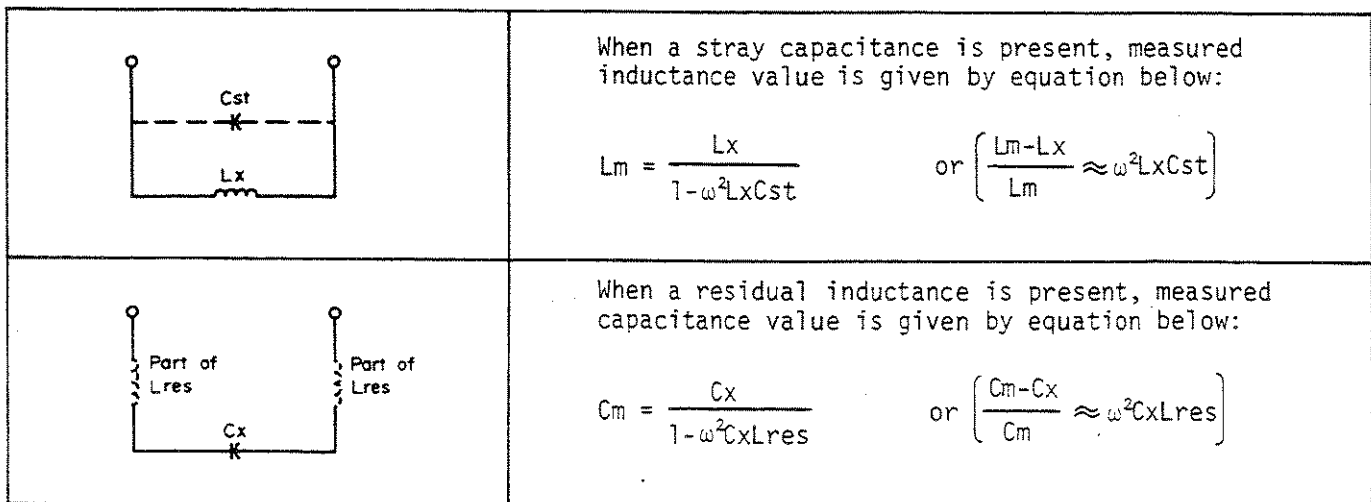


Figure 3-8. Residual Parameter Effects.

If an offset compensation is not performed, it causes two kinds errors:

- 1) Simple additive errors. When a component having a low value is measured, the measured value becomes the sum of the sample value and the residual parameter values. The effects of the residual factors are:

$$\begin{aligned} C_m &= C_x + C_{st} \\ L_m &= L_x + L_{res} \\ R_m &= R_x + R_{res} \\ G_m &= G_x + G_{res} \end{aligned}$$

Where, subscripts are:

- m: measured value
- x: value of sample
- st: stray capacitance
- res: residual inductance
(residual resistance)
(residual conductance)

Residual resistance and conductance in the test fixture affect dissipation factor and quality factor measurements because it is included in the measured values as an additional loss.

- 2) Influence on high capacitance and high inductance measurements. When a high inductance (a high capacitance) is measured, the residual factors in the test fixture also contribute a measurement error. The affect of stray capacitance or residual inductance on the measured parameters are:

Stray capacitance	→	Offsets high inductance measurements.
Residual inductance	→	Offsets high capacitance measurements.

These measurement errors increase in proportion to the square of the test signal frequency. The effects of the residual factors can be expressed as shown in Figure 3-8.

In a 1MHz measurement, for a measurement error to be less than 0.1%, the product of C_x and L_{res} (L_x and C_{st}) should be less than 25×10^{-18} (F.H). The relationship between the residual factors of the test fixture and measurement accuracies is graphically shown in Figure 3-9.

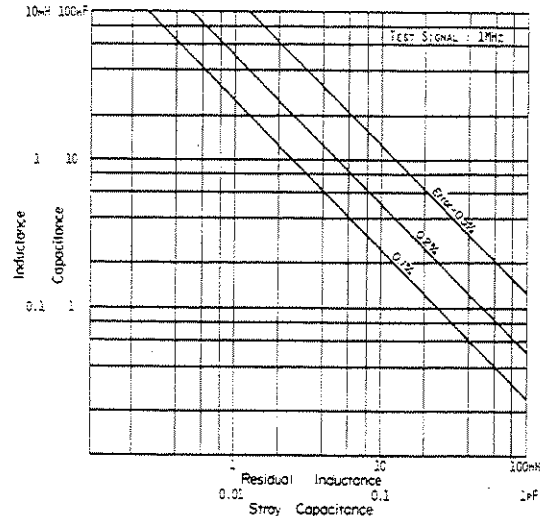


Figure 3-9. Relationships of Residual Parameters on Additional Errors.

Note

ZERO offset adjustment can be performed at one specified test frequency. This function is useful when performing ZERO offset adjustment with a test fixture whose useable frequency range is no as broad as the instrument's - e.g., 16034B, 16047B. The ZERO offset adjustment procedure is as follows:

1. Set the instrument to the desired test frequency.
2. Press the SELF TEST key.
3. Press the ZERO OPEN or ZERO SHORT button. "CAL" will appear on DISPLAY A during the ZERO offset adjustment.
4. Press the SELF TEST key to release the SELF TEST.

To perform the ZERO offset adjustment under remote control via the HP-IB, send remote program code "&9Z0" to initiate ZERO OPEN offset adjustment, or "&9ZS" to initiate ZERO SHORT.

3-31. ACTUAL MEASURING CIRCUIT.

3-32. Measuring circuit for connecting a test sample to the UNKNOWN terminals actually becomes part of the sample which the instrument measures. Diverse parasitic impedances existing in the measuring circuit between the unknown device and the measurement terminals will affect measurement results. These undesired parasitic impedances are present as resistive and reactive factors in parallel and in series with the test component. Figure 3-10 shows an equivalent circuit model of the measuring circuit which includes the parasitic parameters (usually called residual parameters). Reactive factors in the residual impedance have a greater effect on measurements at higher frequencies. The four terminal pair configuration measurement employed for the 4275A offers minimum residual impedance in the measuring circuit. However, the four terminal pair measurement system must be converted to a two terminal configuration at/near to the sample because ordinary components have two terminal leads. Moreover, another stray capacitance appears in the measuring circuit when a sample is connected to the test fixture. Figure 3-11 illustrates such stray capacitances present around the component leads.

In the equivalent measuring circuit (Figure 3-10), L_o represents residual inductances in test component leads. R_o is lead resistance, G_o is conductance between the leads, and C_o is the stray capacitance illustrated in Figure 3-11. Generally, L_o resonates with capa-

citance of sample (series resonance) and C_o resonates with the inductance of sample (parallel resonance), respectively, at a specific high frequency. Thus, impedance of the test sample will have some extreme corresponding to resonant peaks as shown in Figure 3-12. The presence of L_o and C_o causes measurement errors, as the phase of the test signal current varies over a broad frequency region around the resonant frequencies. Additional errors, due to the resonance, increase in proportion to the square of the measurement frequency (below resonant frequency) and can be theoretically approximated as follows:

$$C_{ERROR} \approx \omega^2 L_o C_x \cdot 100 (\%)$$

$$L_{ERROR} \approx \omega^2 C_o L_x \cdot 100 (\%)$$

Where, $\omega = 2\pi f$ (f : test frequency)
 C_x = Capacitance value of sample.
 L_x = Inductance value of sample.

At low frequencies, L_o and C_o affect the measured inductance and capacitance values, respectively, as simple additive errors. These measurement errors can not be fully eliminated by the offset adjustment (which permit compensating for residual factors inherent in the test fixture used). This is because L_o and C_o are peculiar to the component measured. Their values depend on component lead length and on the distance between the sample and test fixture. The measurement results, then, are substantially the sample values including the parasitic impedances present under the conditions necessary to connect and hold the sample.

	<p>Measured impedance $R_m + jX_m$ is:</p> $R_m = \frac{R(1 + R G_o) + G_o X^2}{(1 - \omega C_o X + R G_o)^2 + (\omega R C_o + G_o X)^2} + R_o$ $jX_m = j \left\{ \frac{X(1 - \omega C_o X) - \omega C_o R^2}{(1 - \omega C_o X + R G_o)^2 + (\omega R C_o + G_o X)^2} + \omega L_o \right\}$
	<p>Effect of lead impedance on C-G measurement.</p> $C_m \approx C_x(1 + \omega^2 L_o C_x - 2R_o G_x - L_o G_x^2 / C_x)$ $G_m \approx G_x(1 + 2\omega^2 L_o C_x - R_o G_x + \omega^2 R_o C_x^2 / G_x)$
	<p>Effect of stray admittance on L - ESR measurement.</p> $L_m \approx L_x(1 - 2G_o R_x + \omega^2 C_o L_x - C_o R_x^2 / L_x)$ $R_m \approx R_x(1 - G_o R_x + 2\omega^2 C_o L_x + \omega^2 L_x^2 G_o / R_x)$

Figure 3-10. Residuals Present in Measuring Circuit.

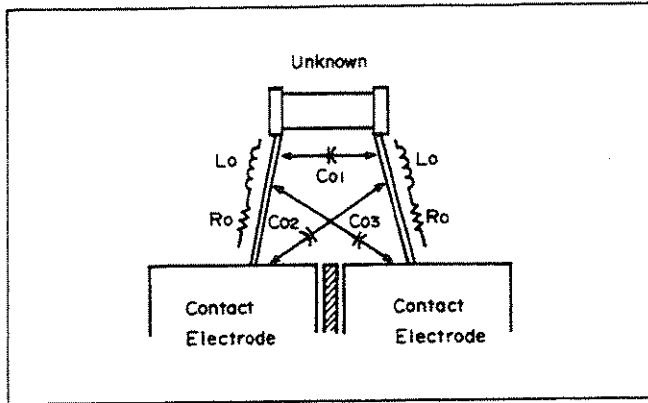


Figure 3-11. Parasitic Impedances Incident to DUT Connections.

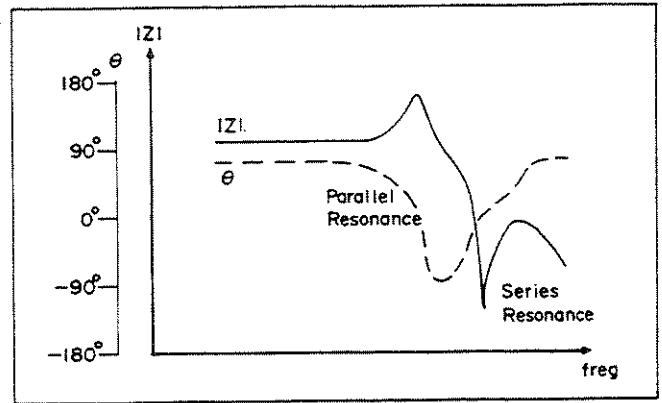


Figure 3-12. Effect of Resonance in sample (example).

3-33. MEASURED VALUES AND BEHAVIOR OF COMPONENTS.

3-34. Measured resistive and reactive parameter values of a component are not always close to their respective nominal values. In addition, certain electrical effects can cause the measurement to vary widely. Measured sample values include factors which vary such values because of electromagnetic effects such as the well-known skin effect of a conductor, the general characteristics of ferromagnetic inductor cores, and effects of dielectric materials in capacitors. Here, let's discuss only the effects which result from the interaction of the reactive parameter elements of a component.

Impedance of a component can be expressed in vector representation by a complex number as shown in Figure 3-13. In such representation, the effective resistance and effective reactance correspond to the projections of the impedance vector $|Z| \angle \theta$, that is, the real (R) axis and the imaginary (jX) axis, respectively.

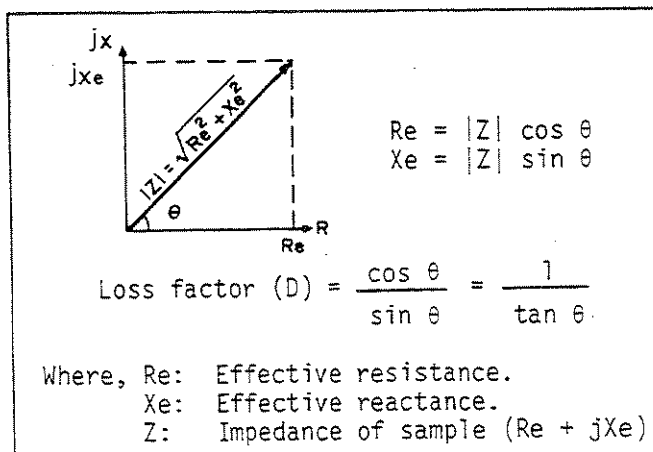


Figure 3-13. Impedance Vector Representation.

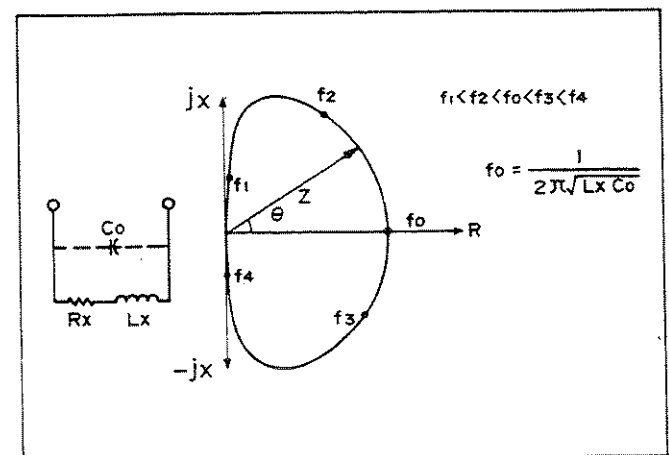


Figure 3-14. Typical Impedance Locus of an Inductor.

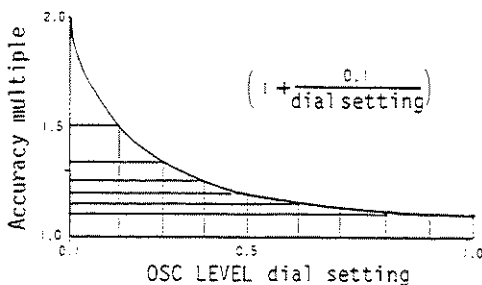
3-35: ACCURACY.

3-36. Measurement accuracies of the 4275A are graphically shown in Figure 3-15. Accuracy readings in the graph represent the maximum error counts of the measurement readouts under given measurement conditions. Measured values have lesser accuracies when a low level test signal and/or a high measurement frequency are used. Accuracy representation applies to a basic instrument. Actual measurement error is the sum of the instrument error and the error peculiar to the test fixture (leads) used. Refer to paragraph 3-39 for the errors due to test fixtures (at frequencies above 1MHz). Measurement accuracy of the 4275A is specified under the following measurement conditions:

- 1) Warm-up time: at least 30 minutes.
- *2) Test signal level setting:
 MULTIPLIER: X 1 or X 0.1
 OSC LEVEL: Fully clockwise
- 3) CABLE LENGTH switch setting: "0" position.
- 4) ZERO offset adjustment appropriately completed.
- *5) Environmental temperature:
 23°C ±5°C
- 6) Significant display readout should be more than 20 counts.
- 7) Measurement readouts in normal mode.

Note

- *2) Accuracy in MULTIPLIER X 0.01 range is unspecified (provided as general information). When OSC LEVEL is set to a position other than fully cw, accuracy is unspecified (multiplies by number given in figure below).
- *5) At temperature range of 0°C to 55°C, error doubles.



3-37. TEST SIGNAL LEVEL ACCURACY.

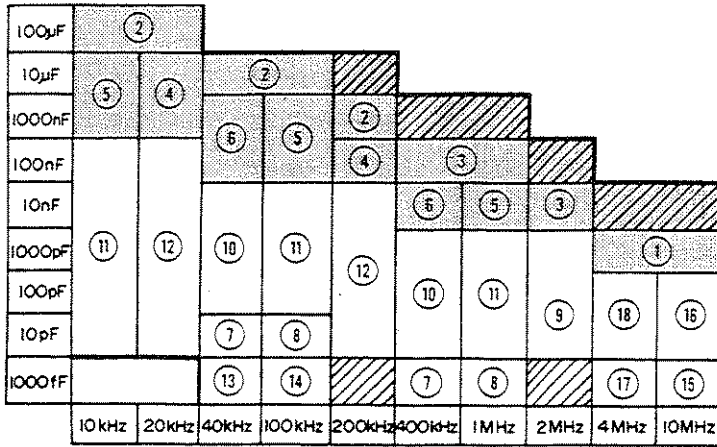
3-38. Accuracies for the test signal voltage and current displayed by pressing TEST SIG LEVEL CHECK buttons are shown in Table 3-7 (these accuracies are not specifications but rather are typical values). A readout of the test signal voltage will normally be close to a reading of the OSC LEVEL control dial and MULTIPLIER settings. However, when a low impedance component (less than approximately 1kΩ) is connected to the UNKNOWN terminals as a DUT, the test signal voltage decreases because of internal loading. Actual test signal voltage is thus a lower value than the OSC LEVEL control dial reading. The displayed value, nevertheless, is the correct voltage/current readout for the test signal level actually being used in the measurement.

When test cables are used in high frequency measurements, the displayed test voltage may have lesser accuracy. This is because the propagation loss in the test cables decreases the level of the test signal applied to the sample. The typical accuracies at frequencies above 1MHz given in the table apply when a direct attachment type test fixture is used.

Table 3-7. Test Signal Level Monitor Accuracy

Measurement range	Freq.	Accuracy
Voltage 0.001V to 1.00V	<1MHz	±(3% of rdg + 1 count)
	≥1MHz	±(10% of rdg + 2 counts)
Current 0.001mA to 10.0mA	<1MHz	±(3% of rdg + 1 count)
	≥1MHz	±(10% of rdg + 2 counts)

CAPACITANCE ACCURACY



-ACCURACY GRAPH NOTES-

1. Accuracy graphs apply when MULTIPLIER is set to X 1 and also apply to MULTIPLIER X0.1 setting when number of significant display digits is the same as that for X 1 setting.
2. Horizontal axes of the graphs represent DISPLAY A readings in counts.
3. In 3 digit display ranges (shaded areas of range tabulation), number of significant display digits (resolution) for DISPLAY A increases for measured values less than 1/2 full scale value, and allowable error counts are calculated for significant display values. Thus, these accuracy graphs show different curves for lower and higher measurement values.
4. C, L, R, |Z|, θ error counts: error counts per C, L, R, or |Z| display counts.
5. Capacitance accuracies apply to C-D, C-Q, C-ESR, C-G and R-C measurements.
6. Accuracies in lined areas / are unspecified.

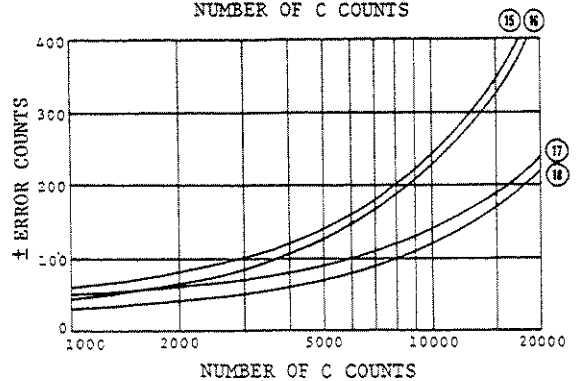
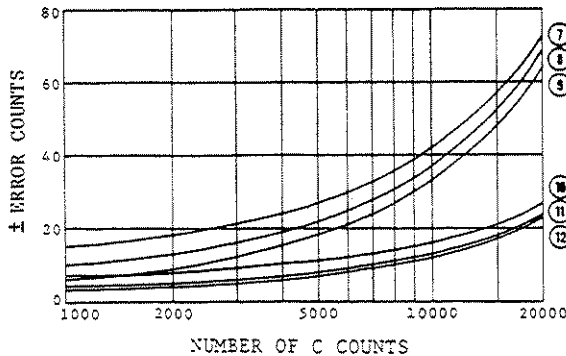
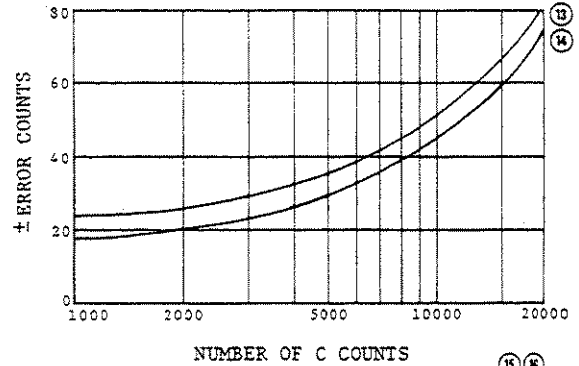
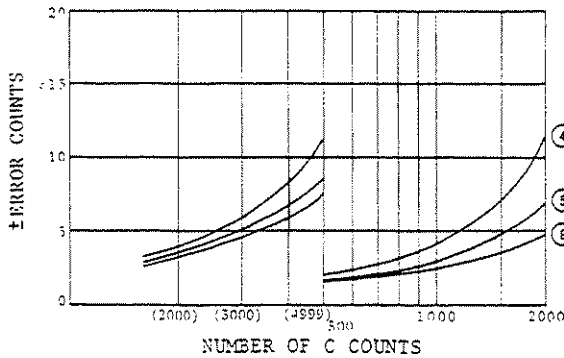
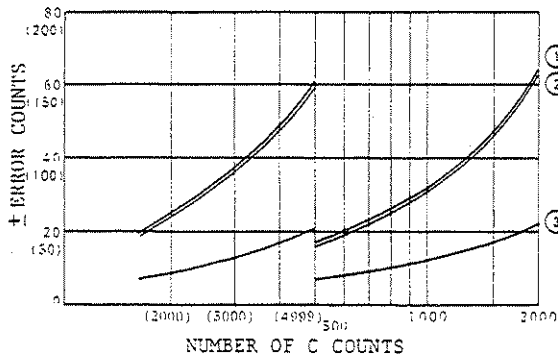



Figure 3-15. Measurement Accuracies (sheet 1 of 9).

**DISSIPATION FACTOR ACCURACY
IN C-D MEASUREMENT**

100μF	②	①								
10μF			③	②						
1000nF	⑧	⑦			①					
100nF			⑨	⑧	⑦	⑥	⑤			
10nF						⑨	⑧	④		
1000pF	⑬	⑭	⑫	⑬	⑭			⑪	⑩	
100pF						⑫	⑬			
10pF								⑰		
1000fF			⑳	㉑		⑮	⑯			
	10kHz	20kHz	40kHz	100kHz	200kHz	400kHz	1MHz	2MHz	4MHz	10MHz

-ACCURACY GRAPH NOTES-

1. Accuracy graphs apply when MULTIPLIER is set to X 1 and also apply to MULTIPLIER X0.1 setting when number of significant display digits is the same as that for X 1 setting.
2. Horizontal axes of the graphs represent DISPLAY A readings in counts.
3. D accuracy: Accuracy graphs show % error and residual error counts for D per capacitance display counts.
 $D \text{ error} = D \text{ rdg} \times \% \text{ error} + \text{error counts}$
 Less significant zero for D readings is included in the error count numbers of D accuracy graphs.
4. Accuracies in lined areas  are unspecified.

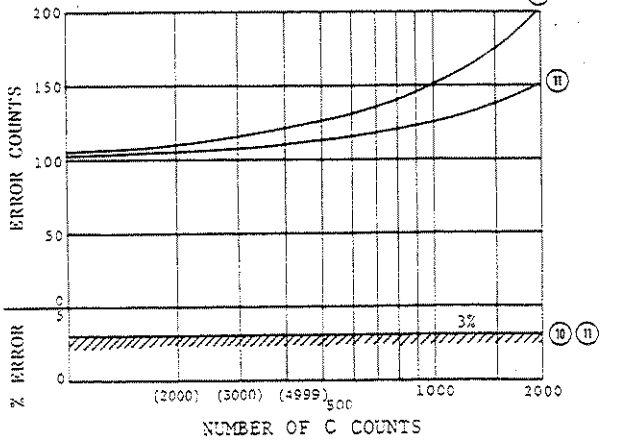
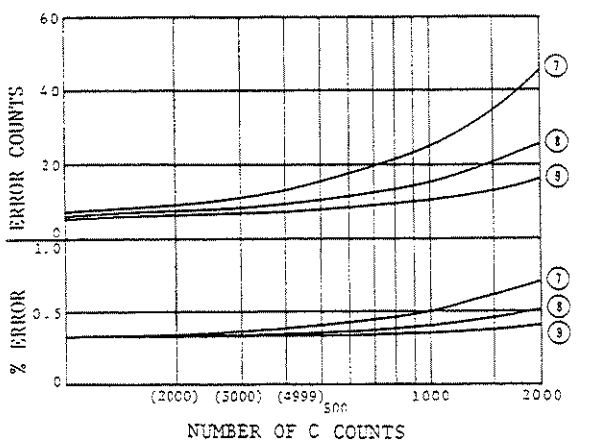
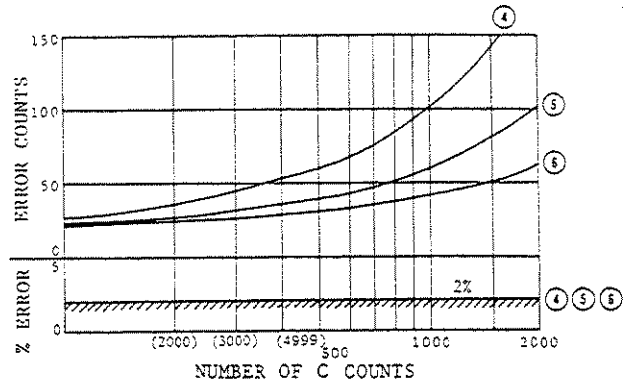
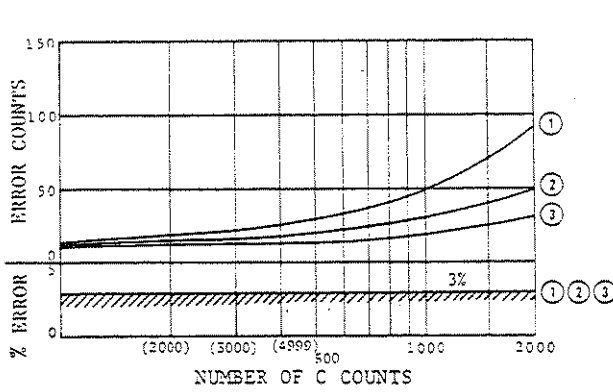
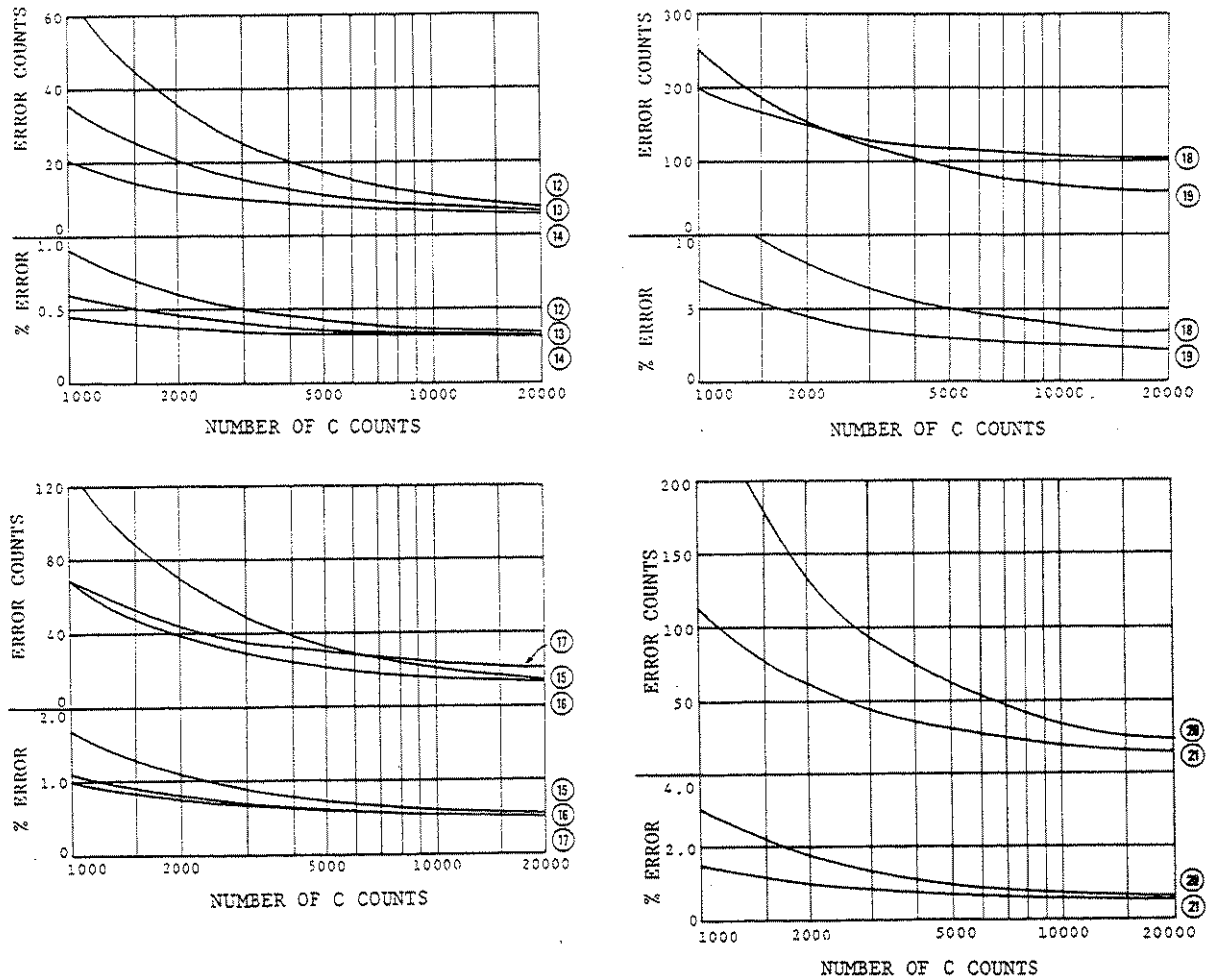


Figure 3-15. Measurement Accuracies (sheet 2 of 9).



IMPORTANT !

Note

On three digit display ranges in C, L, R and |Z| measurements, specified accuracy applies to the first through fourth significant digit data.

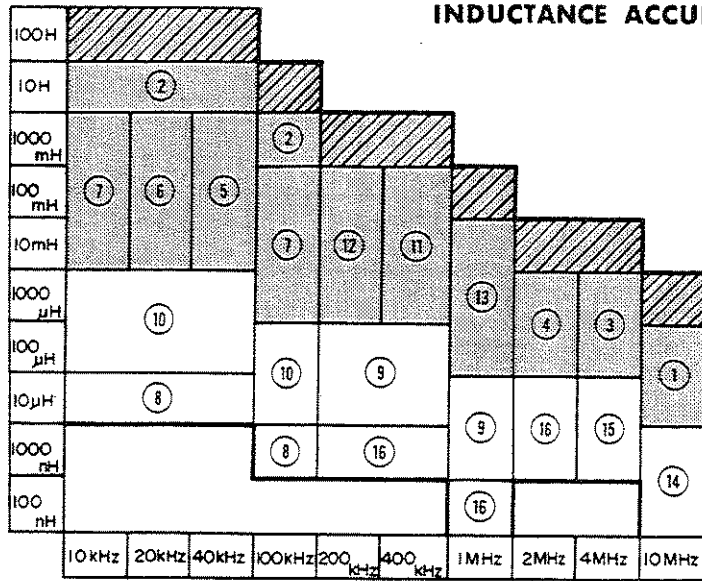
$$\underline{N_1 N_2 N_3 N_4 N_5}$$

Specifies accuracy for N_1 through N_4 digit data

When DISPLAY A readout is less than 16% of full scale value on the (manually) selected range, displayed digit data will be given by digits N_1 through N_5 or digits N_2 through N_5 . Here, the accuracy does not apply to N_5 digit data.

Figure 3-15. Measurement Accuracies (sheet 3 of 9).

INDUCTANCE ACCURACY



-ACCURACY GRAPH NOTES-

1. Accuracy graphs apply when MULTIPLIER is set to X 1 and also apply to MULTIPLIER X0.1 setting when number of significant display digits is the same as that for X 1 setting.
2. Horizontal axes of the graphs represent DISPLAY A readings in counts.
3. In 3 digit display ranges (shaded areas of range tabulation), number of significant display digits (resolution) for DISPLAY A increases for measured values less than 1/2 full scale value, and allowable error counts are calculated for significant display values. Thus, these accuracy graphs show different curves for lower and higher measurement values.
4. C, L, R, |Z|, θ error counts: error counts per C, L, R, or |Z| display counts.
5. Inductance accuracies apply to L-D, L-Q, L-ESR, L-G and R-L measurements.
6. Accuracies in lined areas are unspecified.

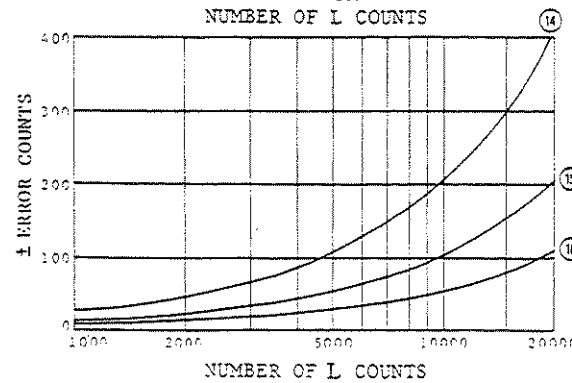
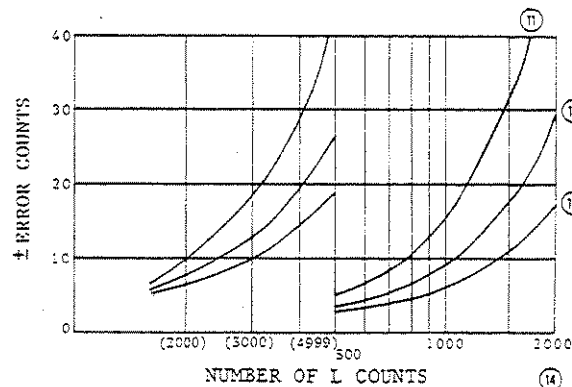
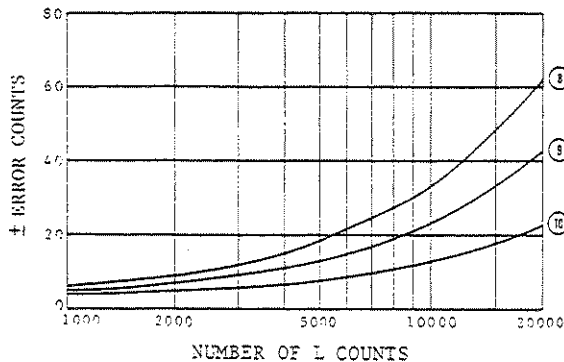
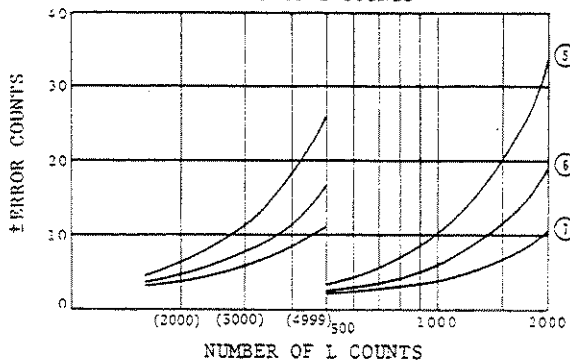
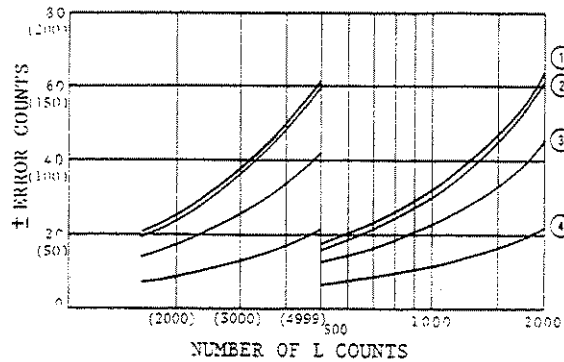


Figure 3-15. Measurement Accuracies (sheet 4 of 9).

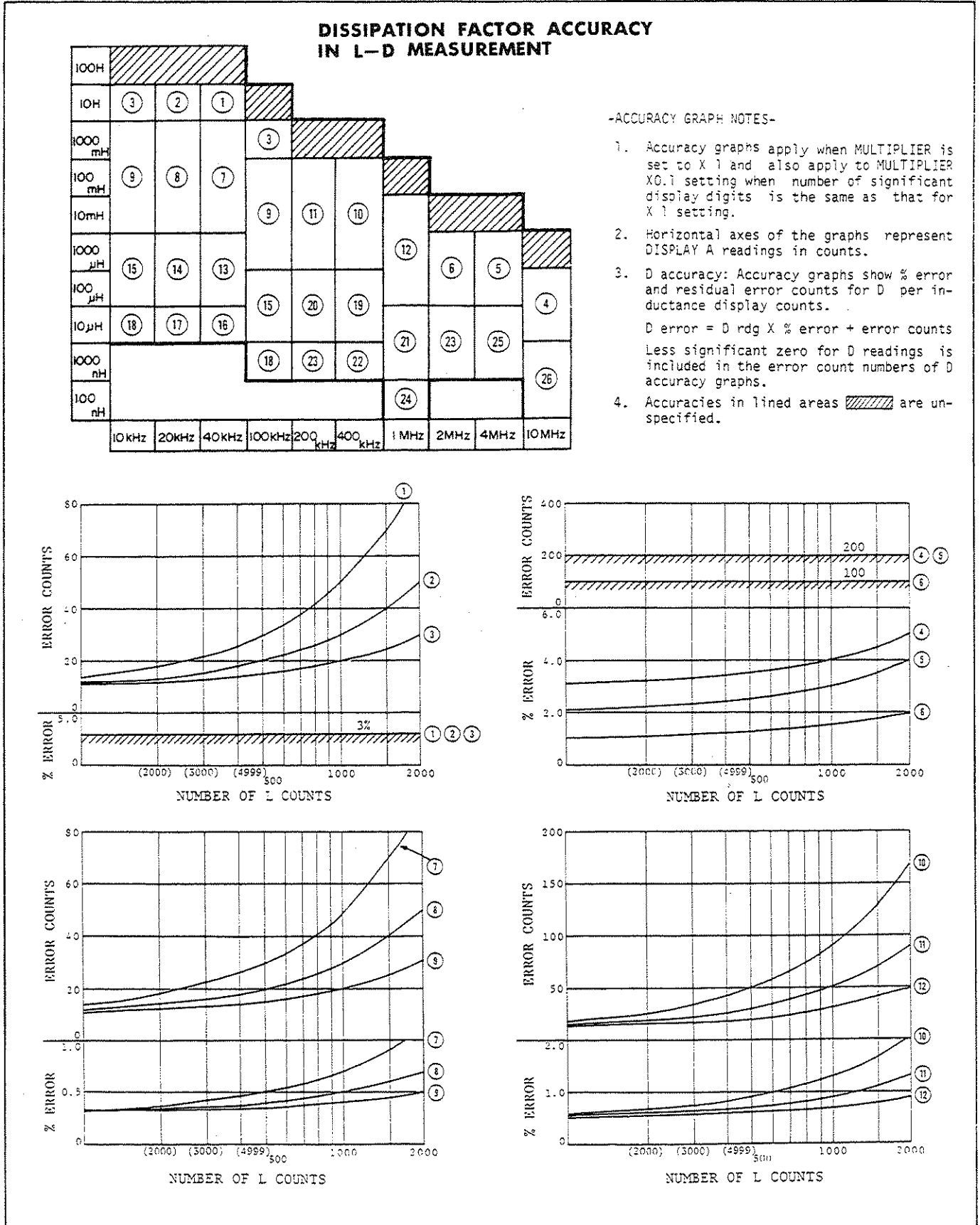


Figure 3-15. Measurement Accuracies (sheet 5 of 9).

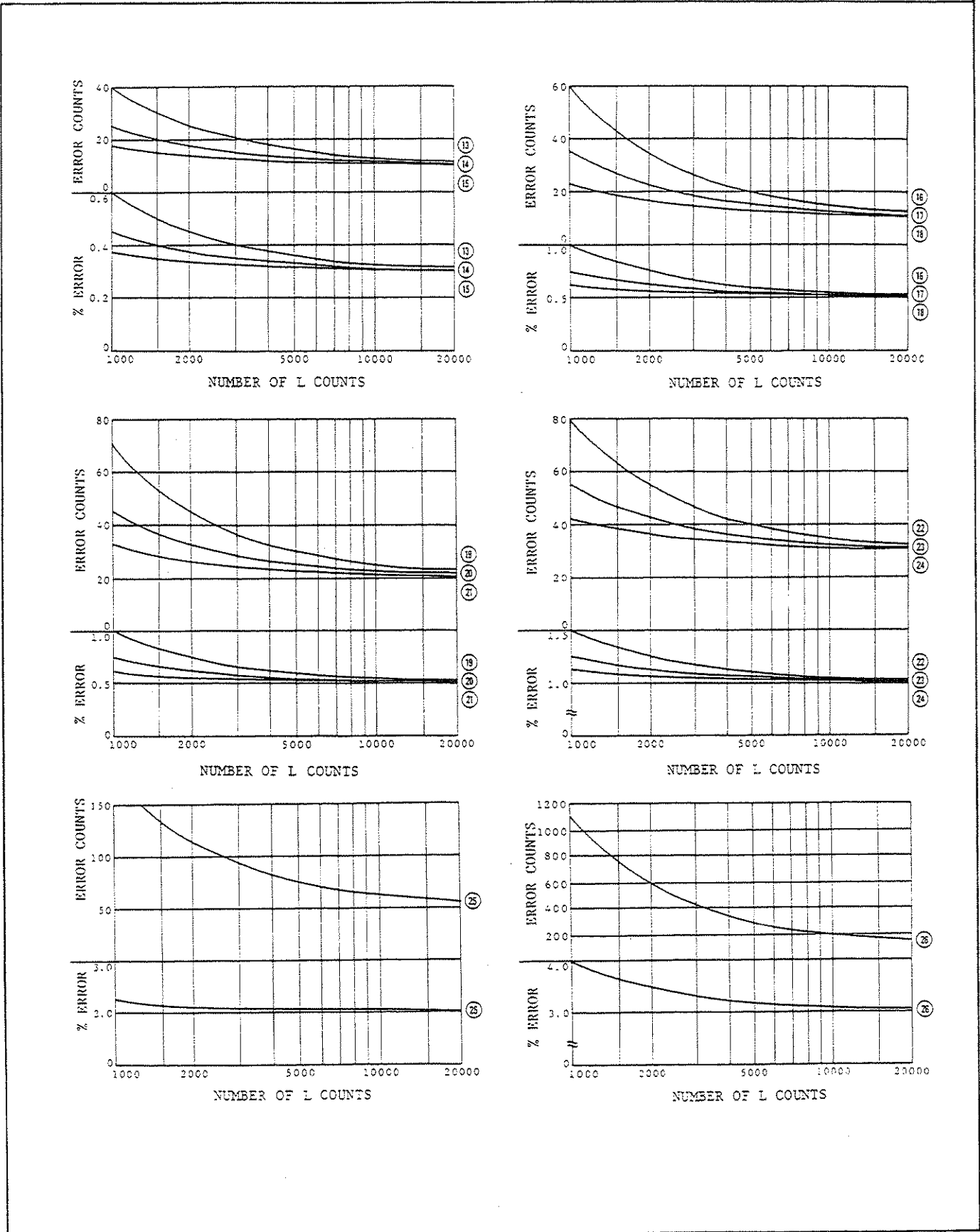
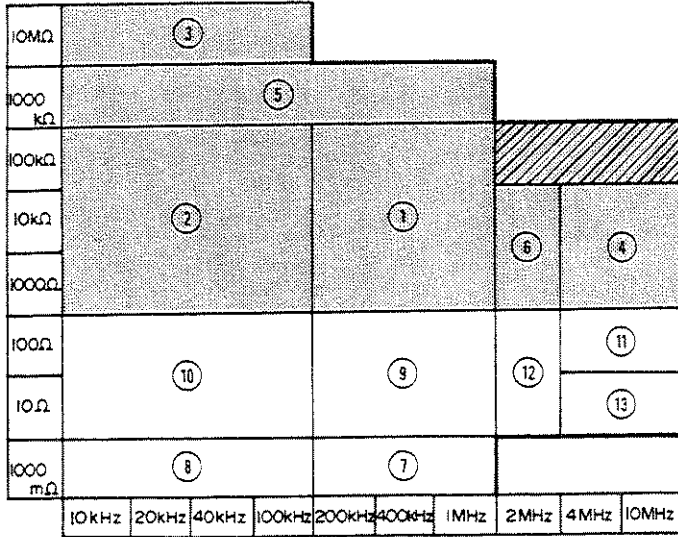



Figure 3-15. Measurement Accuracies (sheet 6 of 9).

RESISTANCE ACCURACY



-ACCURACY GRAPH NOTES-

1. Accuracy graphs apply when MULTIPLIER is set to X 1 and also apply to MULTIPLIER X0.1 setting when number of significant display digits is the same as that for X 1 setting.
2. Horizontal axes of the graphs represent DISPLAY A readings in counts.
3. In 3 digit display ranges (shaded areas of range tabulation), number of significant display digits (resolution) for DISPLAY A increases for measured values less than 1/2 full scale value, and allowable error counts are calculated for significant display values. Thus, these accuracy graphs show different curves for lower and higher measurement values.
4. C, L, R, |Z|, θ error counts: error counts per C, L, R, or |Z| display counts.
5. Accuracies in lined areas  are unspecified.

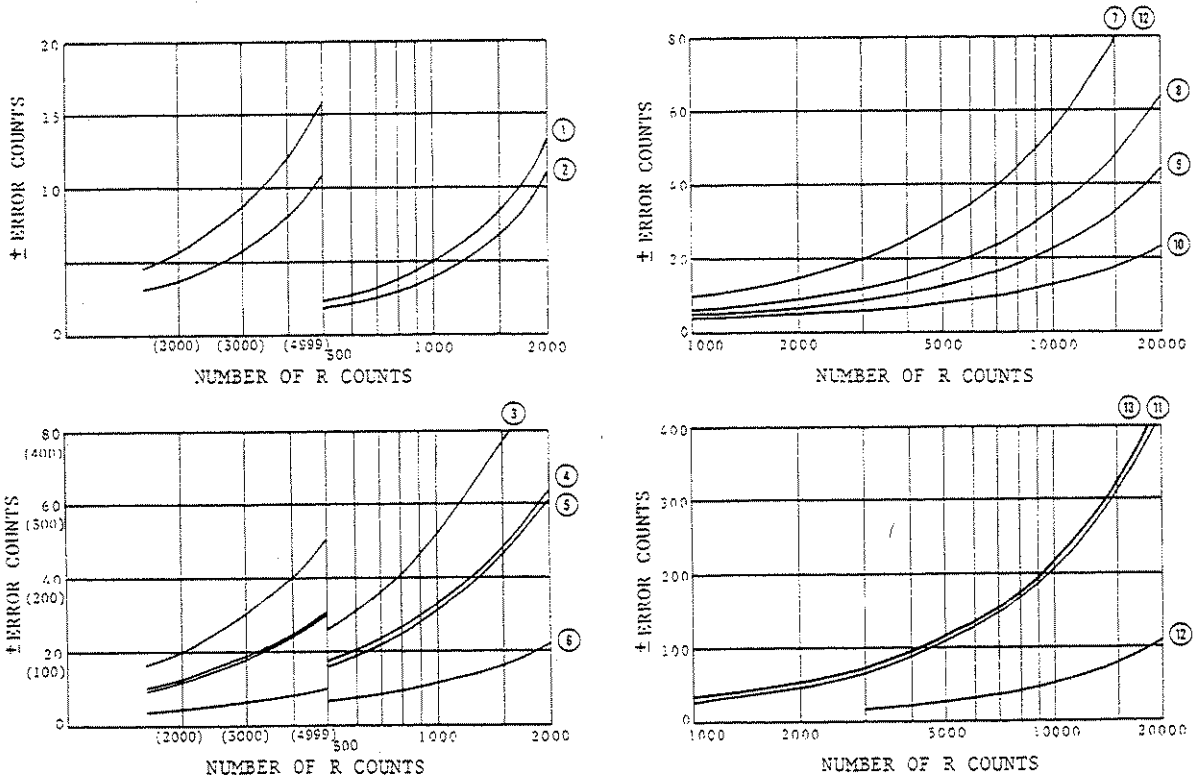


Figure 3-15. Measurement Accuracies (sheet 7 of 9).

IMPEDANCE ACCURACY

10MΩ	①									
1000 kΩ	③									
100kΩ										
10kΩ	⑥		⑤				④	②		
1000Ω										
100 Ω	⑩		⑨				⑦	⑪		
10 Ω										
1000 mΩ	⑧		⑦							
	10 kHz	20kHz	40kHz	100kHz	200kHz	400kHz	1MHz	2MHz	4MHz	10MHz

-ACCURACY GRAPH NOTES-

1. Accuracy graphs apply when MULTIPLIER is set to X 1 and also apply to MULTIPLIER X0.1 setting when number of significant display digits is the same as that for X 1 setting.
2. Horizontal axes of the graphs represent DISPLAY A readings in counts.
3. In 3 digit display ranges (shaded areas of range tabulation), number of significant display digits (resolution) for DISPLAY A increases for measured values less than 1/2 full scale value, and allowable error counts are calculated for significant display values. Thus, these accuracy graphs show different curves for lower and higher measurement values.
4. C, L, R, |Z|, θ error counts: error counts per C, L, R, or |Z| display counts.
5. Accuracies in lined areas are unspecified.

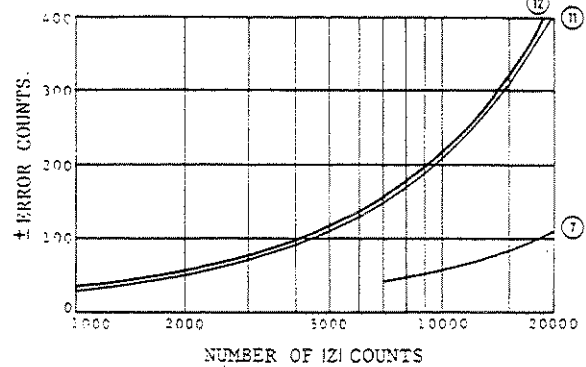
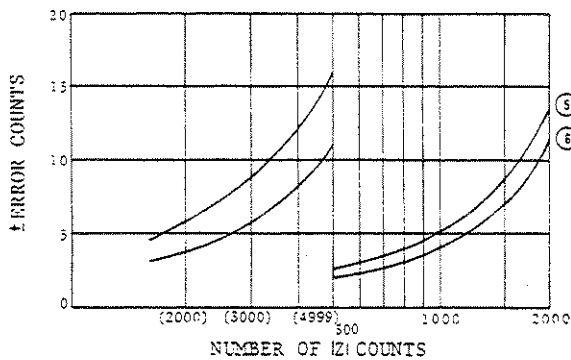
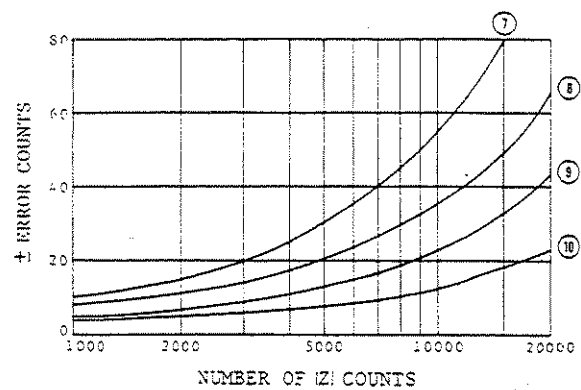
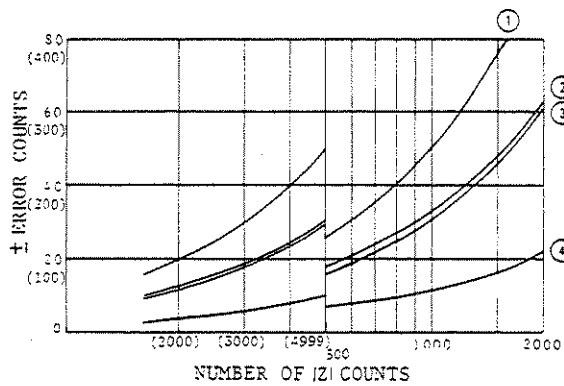


Figure 3-15. Measurement Accuracies (sheet 8 of 9).

PHASE ANGLE ACCURACY

10MΩ	①													
1000 kΩ	②													
100kΩ	③										①		④	
1000Ω											①		④	
100Ω	⑤										⑤		⑦	
10Ω											⑤		⑦	
1000 mΩ	⑤													
	10kHz	20kHz	40kHz	100kHz	200kHz	400kHz	1MHz	2MHz	4MHz	10MHz				

-ACCURACY GRAPH NOTES-

1. Accuracy graphs apply when MULTIPLIER is set to X 1 and also apply to MULTIPLIER X0.1 setting when number of significant display digits is the same as that for X 1 setting.
2. Horizontal axes of the graphs represent DISPLAY A readings in counts.
3. C, L, R, |Z|, θ error counts: error counts per C, L, R, or |Z| display counts.
4. Accuracies in lined areas are unspecified.

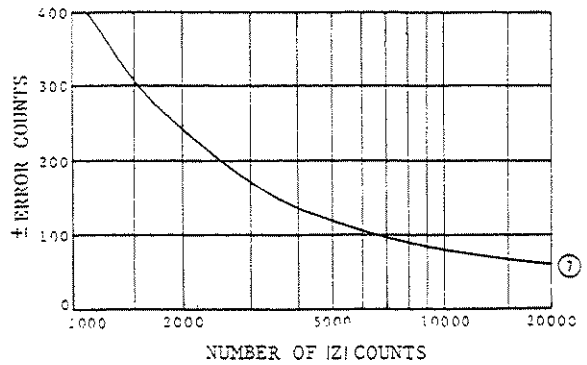
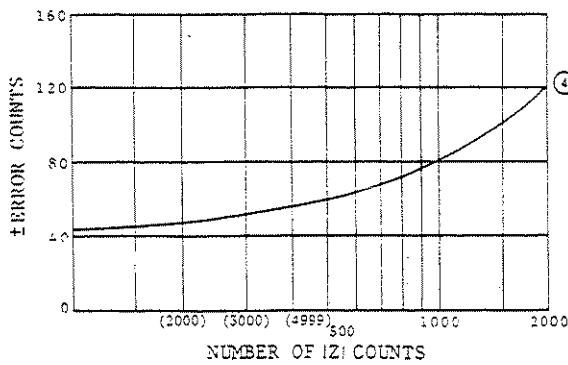
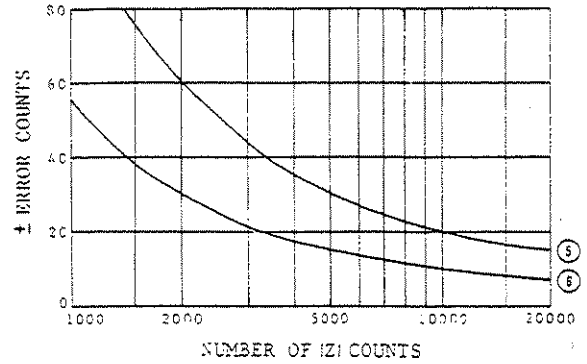
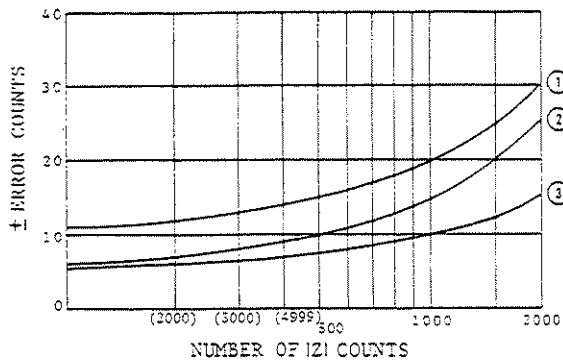


Figure 3-15. Measurement Accuracies (sheet 9 of 9).

3-39. CHARACTERISTICS OF TEST FIXTURES.

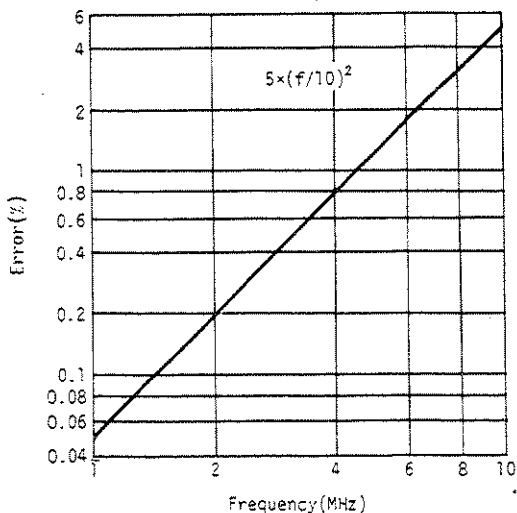
3-40. Characteristics and applicable measurement ranges of HP test fixtures and test leads are summarized in Table 3-8. To facilitate measurement and for minimum contribution to measurement errors, a test fixture appropriate to the measurement objective should be chosen from among HP's standard accessories. Select a test fixture or leads type having the desired performance characteristics.

Note : f is measurement frequency in megahertz. The incremental errors calculated from the equations in the table for measurements at frequencies above 1MHz are additive.

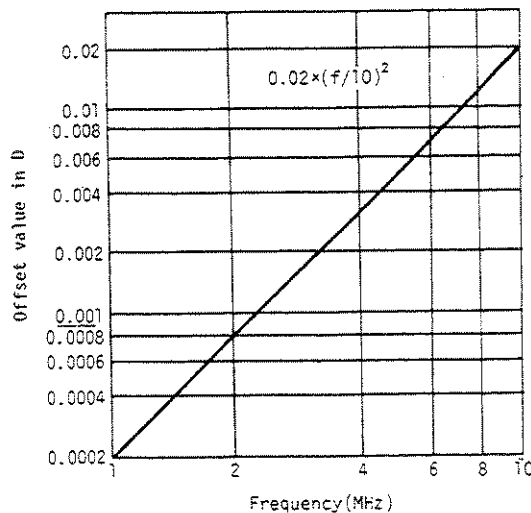
Table 3-8. Typical Characteristics of Test Fixtures and Leads.

Model	Applicable measurement ranges		Incremental error at freq. ≥1MHz	
	Parameter value	Measurement frequency	Parameter reading error	Offset value in D
16047A	Full range	Full range	$\pm 5 \times \left(\frac{f}{10}\right)^2 \%$	$\pm 0.02 \times \left(\frac{f}{10}\right)^2$
16047B	Full range	below 2MHz	—	—
16047C	Full range	Full range	$\pm 1 \times \left(\frac{f}{10}\right)^2 \%$	$\pm 0.01 \times \left(\frac{f}{10}\right)^2$
16048A 16048B	Full range	Full range	$\pm 5 \times \left(\frac{f}{10}\right)^2 \%$	$\pm 0.02 \times \left(\frac{f}{10}\right)^2$
16048C	C > 1000pF L > 100μH	below 100kHz	Residual parameter values : C < 5pF, L < 200nH, R < 10mΩ	
16334A	Full range	Full range	$\pm 2 \times \left(\frac{f}{10}\right)^2 \%$ *	$\pm 0.02 \times \left(\frac{f}{10}\right)^2$ *

* There are some cases where the actual incremental error exceeds this limit.



Parameter reading error vs frequency.



Offset value in D vs frequency.

3-41. DEVIATION MEASUREMENT FUNCTION.

3-42. When many components of similar value are to be tested, it is sometimes more practicable to measure the difference between the value of the sample and a predetermined reference value. Besides, when the measurement purpose is to observe sample values versus the variance of the sample per degree temperature, unit time or other test variables, a direct measurement of this difference makes examination much more meaningful and easier. The deviation measurement function permits such repetitive calculations of the difference between the reference and each individual sample and displays the result on DISPLAY A. When the STORE button is pressed, the inductance, capacitance, resistance or impedance value of the sample is stored in an internal memory. Next, Δ button or $\Delta\%$ button is pressed to enable the deviation measurement. The $\Delta\%$ button permits calculation of the difference in percent deviation (instead of a subtractive measurement). The 4275A will now display the deviation between the stored value and the measured value of a sample connected to the UNKNOWN as selected above. The reference value stored in the instrument can be rechecked at anytime by pressing the RECALL button. To change the reference value to a new value, press Δ button (or $\Delta\%$ button) to release the deviation measurement function, measure the new reference sample, and again press the STORE button.

3-43. General Component Measurement.

3-44. General operating procedures for measuring an inductance, capacitance or resistance circuit component are outlined in Figure 3-16. Almost all discrete circuit components (inductors, capacitors or resistors) except for components having special shapes or dimensions can be measured with this setup. Special components may be measured by using test leads 16048A, 16048B or the 16034B, or by specially designed user built fixtures instead of the 16047B Test Fixture.

3-45. Semiconductor Device Measurement.

3-46. The procedures for making semiconductor device measurements with the 4275A are described in Figure 3-18. The junction (inter-terminal) capacitance of diodes, collector output capacitance of transistors, etc., can easily and accurately be measured (with or without dc bias). The 1pF full scale capacitance measurement capability is

adequate for the measurement of low order capacitances of RF detector diodes, PIN diodes and so on. Since the test signal is controllable from the minimum level of 1mVrms, it permits measuring the capacitance of a semiconductor junction which has a low potential barrier such as in hot carrier (Schottky) diodes.

3-47. External DC Bias.

3-48. A special biasing circuit using external voltage or current bias, as needed for capacitor or inductor measurements, is illustrated in Figure 3-19. The figure shows sample circuitry appropriate to 4275A applications. When applying a dc voltage to capacitor samples, be sure applied voltage does not exceed maximum working voltage and that you are observing polarity of capacitor. Note that the external bias voltage is present at H_{POT} and H_{CUR} terminals.

3-49. Bias Voltage Settling Time. When a measurement with dc bias voltage superposed is performed, it takes some time for voltage across sample to reach a certain percentage of applied (desired) voltage. Figure 3-19 shows time for dc bias voltage to reach more than 90% of applied voltage and for 4275A to display a stable value. If the bias voltage across sample is not given sufficient time to settle, the displayed value may fluctuate or Err4 may be displayed. Read measured value after display settles.

3-50. External Triggering.

3-51. For triggering the 4275A externally, connect an external triggering device to the rear panel EXT TRIGGER connector (BNC type) and press EXT TRIGGER button. The 4275A can be triggered by a TTL level signal that changes from low (0V) to high level (+5V). Trigger pulse width must be greater than 20us. Triggering can be also done by alternately shorting and opening the center conductor of the EXT TRIGGER connector to ground (chassis).





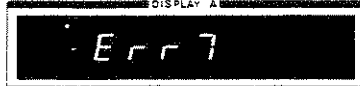





Note

The center conductor of the EXT TRIGGER connector is normally at high level (no input).

Table 3-9. Annunciation Display Meanings (Sheet 1 of 2).

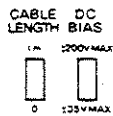
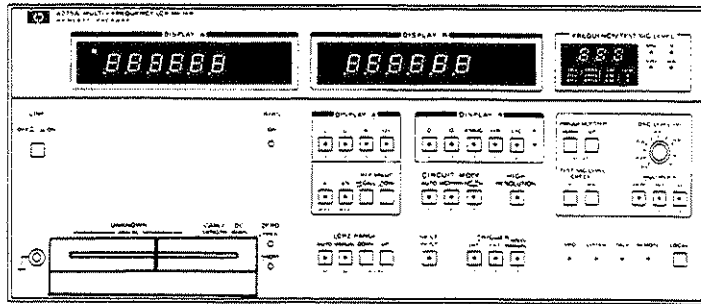
DISPLAY A	DISPLAY B	Indicated Condition
	 (blank)	DISPLAY A function has been inappropriately set. Measured L, C, R or Z value exceeds the upper range limit.
	 (blank)	Measured L, C, R or Z value is too low compared to the selected range.
 (any reading)	 (blank)	Measured value in the selected DISPLAY B function exceeds the upper range limit. Accuracy of LCR reading may not be within specifications. "CF" display implies that measurement function should be changed, as appropriate, to measure the sample.
	 (blank)	Error in ZERO offset adjustment. The value of the residual parameter present in measuring circuit exceeds offset control range limit.
	 (blank)	Error in DISPLAY B function setting. A DISPLAY B function, incompatible with selected DISPLAY A function, has been actuated.
	 (blank)	Error in range selection. Ranging operation has actuated a range on which the measurement can not be taken at the selected test frequency.
	 (blank)	Error in measuring circuit configuration. <ol style="list-style-type: none"> ① Measuring circuit has an open-circuit or a short-circuit in the test lead or test fixture being used. ② Protective hinged cover of 16047B Test Fixture was opened while a measurement was being taken. ③ Ranging operation has actuated a range on which the measurement can not be taken under DC bias operation.

Table 3-9. Annunciation Display Meanings (Sheet 2 of 2).

DISPLAY A	DISPLAY B	Indicated Condition
	 (blank)	Error in deviation measurement control operation. ① STORE function was actuated while OF or UF was displayed. ② STORE function was actuated without releasing Δ or $\Delta\%$ measurement function.
	 (blank)	Error in deviation measurement control operation. Δ or $\Delta\%$ function was actuated in the measurement of a parameter value which has a different unit from that of the stored reference value.
	 (blank)	Error in dc bias operation. ① Internal DC bias function has been set without dc bias supply being installed. ② DC bias voltage setting exceeds voltage control range limit of ± 35.0 volts (Option 001 only). *See note below table.
 <p>This error message appears only for Option 001 or 002 units.</p>	 (blank)	Error in dc bias operation. Front or rear panel DC BIAS switch has been inappropriately set for the internal DC bias operation to be attempted. *See note below table.
 <p>This error message appears only for an Option 003 unit.</p>	 (blank)	Error in continuous memory function. ① Memory data to be continuously preserved has been lost. ② Stand-by battery for continuous memory preservation has been exhausted.
Minus (-) is displayed.		① A minus display sometimes occurs when a sample value around zero is measured. ② A capacitor (or inductor) is being measured in L (or C) measurement function.

*Note: This error message is displayed just after an attempt has been made to set dc bias voltage under the improper operating conditions outlined above.

MEASUREMENT PROCEDURE FOR GENERAL COMPONENTS



1. Set DC BIAS switch to $\pm 35VMAX$ position and CABLE LENGTH switch to 0 position. Connect the 16047A Test Fixture to 4275A UNKNOWN terminals.

Note


Other type test fixtures may also be connected. Guard terminal is sometimes used in high impedance measurement.

2. Depress LINE button to turn instrument on. An initial function test is automatically performed before measurement begins.

Note

Verify that BIAS indicator lamp does not light. If illuminated, set rear panel DC BIAS switch to OFF position.

3. Check that 4275A trigger lamp begins to flash. The 4275A control functions are automatically set as follows (automatic initial settings):

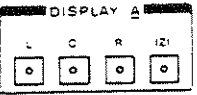
DISPLAY A C
 Deviation measurement function off
 LCR IZI RANGE AUTO
 DISPLAY B D
 CIRCUIT MODE AUTO ()
 HIGH RESOLUTION off
 SELF TEST off
 TRIGGER INT
 Frequency 1.00MHz
 MULTIPLIER X1

Note

To check fundamental operating conditions of instrument, perform SELF TEST (refer to Paragraph 3-5 for SELF TEST details). Press SELF TEST button again to release the function.

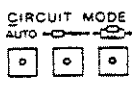


Figure 3-16. General Component Measurements (sheet 1 of 3).



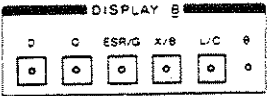
DISPLAY A

L C R |Z|



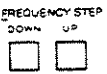
CIRCUIT MODE

AUTO



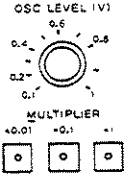
DISPLAY B

D C ESR/G X/B L/C 0



FREQUENCY STEP

DOWN UP




OSC LEVEL (V)

0.4 0.6 0.8

0.2 0.1


MULTIPLIER

+0.01 +0.1 +1



ZERO OPEN

SHORT



TEST SIG LEVEL CHECK

V mA

4. Select desired DISPLAY A function, either L, C, R or |Z|.
5. If necessary, manually select CIRCUIT MODE, either series or parallel mode.

Note

For selecting the desired DISPLAY B function, it is sometimes necessary to select appropriate CIRCUIT MODE. See Para. 3-8.

6. Select the desired DISPLAY B function (compatible with the DISPLAY A function selected in step 4).
7. Select the desired measurement frequency with FREQUENCY STEP DOWN and UP buttons.
8. Set test signal MULTIPLIER to X1 and OSC LEVEL control to its fully cw position.

Note

When the 16047B Test Fixture is being used, close protective cover to enable measurement. Closing cover electrically connects UNKNOWN terminals to fixture. Opening cover disconnects fixture from terminals.

9. Connect nothing to Test Fixture as a DUT. Push ZERO OPEN button. Capacitance and conductance offset adjustments are automatically performed. DISPLAY A shows the letters "CAL" and it will change to a small value (nearly zero) approximately five seconds after the button is pushed.
10. Connect a shorting strap to Test Fixture to short-circuit the UNKNOWN terminals to zero ohms (zero microhenries).
11. Push ZERO SHORT button. Inductance and resistance offset adjustments are automatically performed. DISPLAY A shows the letters "CAL" and it will change to a small value (nearly zero) approximately five seconds after the button is pushed.
12. Remove shorting strap from Test Fixture.
13. Set test signal to the desired amplitude with MULTIPLIER buttons and OSC LEVEL control.
14. Connect sample to be measured (L, C or R) to Test Fixture.

Note

If needed to accurately set the test signal level, continue pressing TEST SIG LEVEL CHECK V or mA button to monitor the actual test signal level applied to the sample and adjust OSC LEVEL control for the appropriate test voltage or current value on the FREQUENCY/TEST SIG LEVEL display.

Figure 3-16. General Component Measurements (sheet 2 of 3).

15. The 4275A will automatically display measured values of unknown.

Note

If OF, UF, minus (-) or blank display occurs, see Table 3-9 for annunciation meanings. For semiconductor measurements, the special care needed for making reliable measurement is described in Figure 3-18.

When dissipation factor of a very low loss sample is measured, a negative value (within allowable measurement error limits) such as, for example, -0.00011 may occasionally be displayed. Such low dissipation factors can be measured with higher accuracy by using a low loss sample whose dissipation is known or which has an extremely (a negligible) low dissipation as a reference. The correct dissipation factor is calculated by the following equation:

$$D = D_2 - (D_1 - D_s)$$

Where, D is correct D value of sample tested.
D₂ is measured D value of sample tested.
D₁ is measured D value of reference sample.
D_s is D value of known reference sample (for extremely low loss references, D_s is zero).

Figure 3-16. General Component measurements (sheet 3 of 3).

APPLICATION

VARIABLE TEST PARAMETER
MEASUREMENT

When a measurement is taken of a test sample using various test levels and various test signal frequencies, the measurement readouts may occasionally exhibit singular variations in sample values. Such peculiar variations in measured value are frequently observed during the measurement of inductive components which have ferromagnetic cores. What are the major reasons for these changes in sample values? Let's discuss it by taking an inductor as an example and look into the significance of taking a measurement of the component under its normal operating conditions.

The inherent values of an inductor which has a ferromagnetic inductive core are influenced by the permeability of its core material. Intensity of magnetization (magnetic flux density) of a ferromagnetic core varies along and with its magnetization characteristic curve (B-H curve) in response to the cyclic current flowing through the inductor coil. A typical magnetization curve for an inductive core is shown in Figure A.

The dotted curve in the figure is a graph for a magnetic material which has a high hysteresis coefficient such as that of a ferrite core. When a static magnetic field is applied to magnetic core material, the increase in magnetization caused by the increase in the applied magnetic field (inductor coil current) follows the characteristic curve shown in Figure B.

Figure 3-17. Variable Test Parameter Measurement (sheet 1 of 2)

In the initial permeability region near the origin (of the coordinate axes), the magnetization increases gently; thus an inductor operating in this region has a low inductance value. The inductance value increases with an increase in inductor coil current and decreases when magnetization of the inductor core exceeds its saturation point.

* Permeability (μ) is the ratio of magnetic flux density (B) to the magnetic field (H).

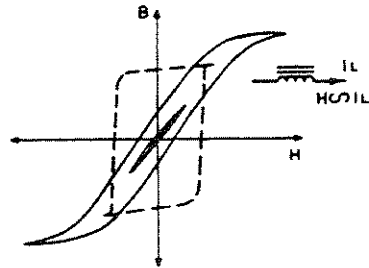


Figure A. B-H Curve for Cyclic Magnetization.

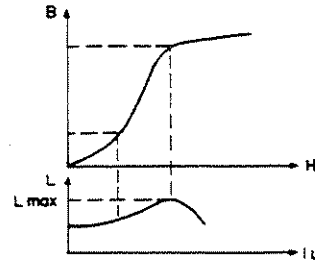


Figure B. Relationship of Magnetization and Inherent Inductance.

On the other hand, the core loss (consisting of hysteresis and eddy current losses) increases in the high frequency region above a specific frequency and is determined by the material and structure of the inductor core. Measurement readings of an inductor may thus differ widely depending on the test level and test frequency.

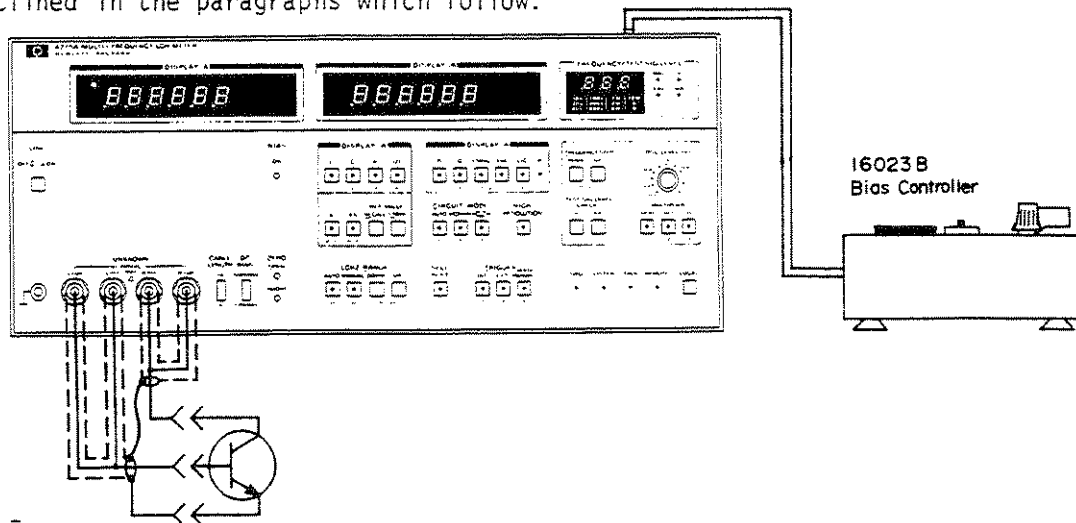
The above discussion is meaningful for general component measurements. Figure C shows typical characteristics of LCR components. As may be seen in the figure, a component may have different effective parameter values dependent upon its operating conditions. The overall characteristics of sample can be clarified from these kinds of measurements. The measured values most useful to actual applications can be gained by such measurements taken under normal operating conditions of the sample.

DUT	Equivalent Circuit	Measurement Parameter	Characteristic Example
C		C-D C-ESR C-G $ Z -\theta$	
L		L-Q L-ESR $ Z -\theta$	
R		R-X R-C R-L $ Z -\theta$	
Circuit		$ Z -\theta$ R-X R-C R-L	

Figure C. Typical Component Measurements.

MEASUREMENT PROCEDURE FOR SEMICONDUCTOR DEVICES

Parameter values of semiconductor devices intrinsically have a strong dependency on the applied voltage and device temperature. Because of the non-linear impedance characteristics of semiconductor devices, a semiconductor measurement is subject to exact establishment of the test conditions to make measured values meaningful. For a detailed analysis of the device under its operating test conditions, a low level test signal is employed in order to obtain measured values with respect to a local region around the operating test point selected for plotting characteristic parameter curves of the sample. A typical procedure for measuring semiconductor junction capacitance in P-N and MOS junction devices is outlined in the paragraphs which follow.



Setup -

The figure above is a typical test setup used for measuring the base-collector junction capacitance (C_{ob}) of an NPN transistor. For this measurement, the appropriate test fixture may be user designed. A 4275A unit equipped with option 001 (or option 002) is suitable for controlling the accurate dc bias required for the measurement. If dc bias is not necessary, setup arrangement and procedures associated with this measurement may be deleted.

Procedure-

1. Set DC BIAS switch to $\pm 35V$ MAX position and CABLE LENGTH switch as appropriate to test fixture used.
2. Connect test fixture or test leads to the UNKNOWN terminals.
3. Press LINE button to turn instrument on. After the initial function test is performed, the 4275A functions are automatically set for a C-D measurement and 1MHz test frequency (automatic initial settings). Trigger lamp will begin to flash.
4. Perform ZERO offset adjustment procedure (as outlined in Figure 3-16 General Component Measurements steps 7 through 12).
5. Set test signal level for an appropriate amplitude with OSC LEVEL control and MULTIPLIER button. If desired, test frequency may be set to a higher or lower frequency.

Note

If Option 002 dc bias (up to $\pm 99.9V$) or an external dc bias supply is used to apply bias voltages more than ± 35 volts, set DC BIAS switch to $\pm 200V$ MAX position.

Note

Use lowest possible test signal level which meets measurement accuracy requirement. Usually, MULTIPLIER is set to X 0.1 (or X 0.01, as necessary). Pressing TEST SIG LEVEL V button allows monitoring of the test signal voltage on FREQUENCY/TEST SIG LEVEL display.

Figure 3-18. Semiconductor Device Measurement (sheet 1 of 3).

Note
If necessary, apply DC bias voltage internally or externally at rear panel EXT ±35V MAX bias connector (or to EXT ±200V MAX connector if higher dc bias voltages are used). External dc bias source should be stable with low noise. Set rear panel DC BIAS switch properly so as to enable dc bias operation and ensure operator safety.

CAUTION
BEFORE OPERATING DC BIAS SWITCH, VERIFY THAT NO SAMPLE HAS BEEN CONNECTED TO TEST FIXTURE OR THAT DC BIAS VOLTAGE HAS BEEN SET TO ZERO VOLTS. BE SURE TO SET THE DC BIAS SWITCH TO APPROPRIATE POSITION.

CAUTION
THE CENTER OF BNC CONNECTOR MAY BE LIVE UNLESS DUT IS REMOVED.

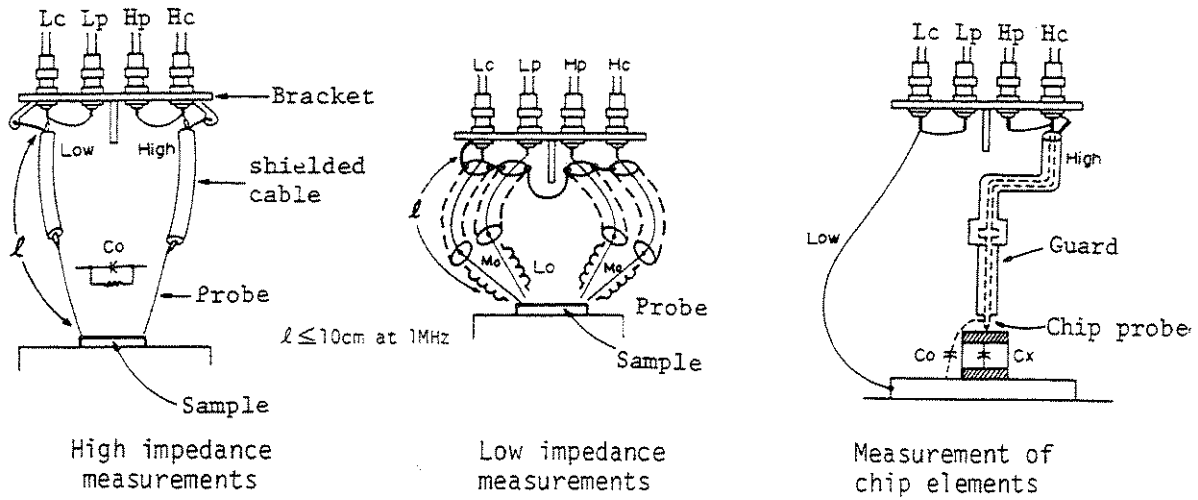
6. Connect semiconductor device to test fixture. To obtain reliable measurement results, observe the following:
 - a. If a forward current flows through P-N junction when test signal is at its peak voltage, a correct measurement result will not be obtained.
 - b. If an accurate test signal level is desired, press and hold TEST SIG LEVEL V button and readjust OSC LEVEL control for the desired voltage.
7. Read displayed capacitance value. Loss factor of the sample will be simultaneously displayed on DISPLAY B.

Typical measurement applications for semiconductor P-N and MOS junction capacitances are summarized in the tabulation below. For these measurement applications, the use of dc bias expands the variety of test parameter settings and affords a wider scope of measurement data. Polarities of the dc biases normally applied to the sample as well as connections of the measuring circuit are shown in the table.

The measurement setups for measuring micro-circuit components (such as an integrated circuit device) are illustrated below. Residual parameters which contribute measurement errors are also denoted in the figure. Use connection configuration appropriate for the sample.

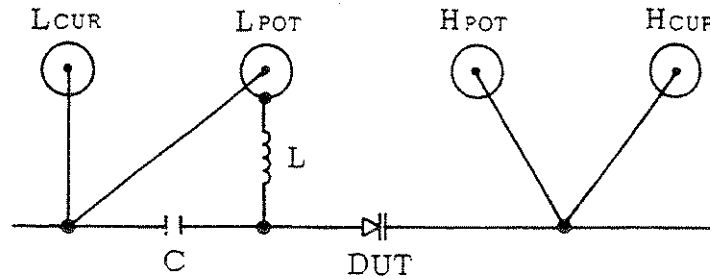
Parameter Measured	Connections to 4275A
Base-collector junction capacitance (C _{ob}) - Emitter current = 0	
Base-collector junction capacitance (C _{re}) - Common emitter	
FET gate capacitance	
Diode junction capacitance	

Figure 3-18. Semiconductor Device Measurement (sheet 2 of 3)



Note

When measuring certain types of semiconductor devices--e.g., MOS structures --under dc-biased conditions, keep in mind that, depending on the amount of dc leakage current through the device under test, the voltage across the device may be slightly lower than the specified bias voltage. This occurs because the L_{CUR} terminal is tied to circuit common through the range resistors. The resulting dc equivalent circuit is a voltage divider consisting of the device under test and the range resistor. Thus, if a range change occurs during measurement, the dc bias across the device under test will change. There are two ways to ensure that the dc bias across the device under test remains constant at the specified value. The first way is to set the instrument to MANUAL range before the measurement. The second method is to connect a capacitor and inductor to the device under test, as shown below.



C: Test Signal Coupling Capacitor
L: DC Bias Bypass Inductor

Figure 3-18. Semiconductor Device Measurement (sheet 3 of 3).

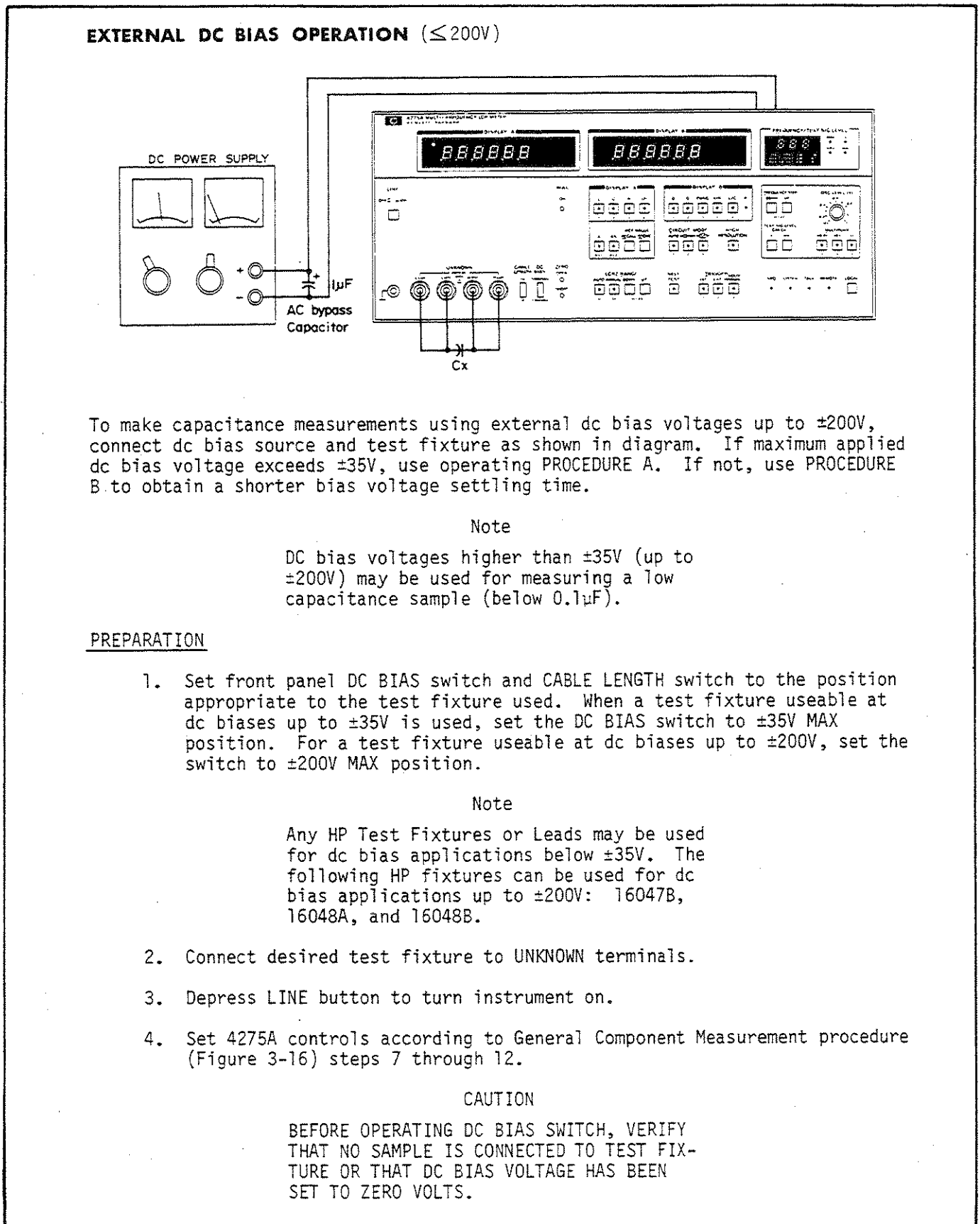


Figure 3-19. External DC Bias Circuits (sheet 1 of 4).

PROCEDURE A ($\leq 200V$)

1. Connect external dc bias source to 4275A rear panel EXT $\pm 200V$ MAX connector.
2. Set rear panel DC BIAS switch to EXT $\pm 200V$ MAX position. Front panel BIAS indicator lamp will illuminate.

CAUTION

NEVER APPLY AN EXTERNAL DC BIAS OVER $\pm 200V$.

Proceed to step 3 described below PROCEDURE B.

PROCEDURE B ($\leq 35V$).

1. Connect external dc bias source to 4275A rear panel EXT $\pm 35V$ MAX connector.
2. Set rear panel DC BIAS switch to EXT $\pm 35V$ MAX position. Front panel BIAS indicator lamp will illuminate.

CAUTION

NEVER APPLY AN EXTERNAL DC BIAS OVER $\pm 35V$.
LIMIT MAXIMUM (SURGE) BIAS CURRENT FLOW
INTO INSTRUMENT AT 100mA (OR INTERNAL
PROTECTIVE FUSE BLOWS).

Proceed to step 3 described below.

3. Connect sample to test fixture.

CAUTION

NEVER SHORT BETWEEN HIGH AND LOW TERMINALS.

CAUTION

WHEN A POSITIVE BIAS VOLTAGE IS USED, POSITIVE POLE OF ELECTROLYTIC CAPACITOR MUST BE CONNECTED TO HIGH TERMINALS. WHEN USING A NEGATIVE BIAS VOLTAGE, CONNECT POSITIVE POLE TO LOW TERMINALS.

4. Read 4275A capacitance display after allowing time for bias voltage to settle.

 WARNING

THE CENTER OF BNC CONNECTOR MAY BE LIVE UNLESS DUT IS REMOVED.

Figure 3-19. External DC Bias Circuits (sheet 2 of 4).

Note

When sample value is greater than 0.1 μ F, a dc bias applied at EXT \pm 200V MAX terminal may cause readout to fluctuate and sometimes an "Err 4" annunciation to occur.

Note

If the 16047B Test Fixture is being used, capacitor is discharged through a 10 Ω resistor when protective cover is opened.

BIAS VOLTAGE SETTling TIME

The following time should be allowed for dc voltage across capacitor sample to reach more than 90% of the applied bias voltage:

Bias voltage range	Settling time
\pm 35V MAX	less than 50ms (\leq 200 μ F)
\pm 200V MAX	less than 40ms (\leq 0.1 μ F)

Note: EXT \pm 35V MAX and EXT \pm 200V MAX inputs feed external dc bias to sample through resistors of approximately 100 Ω and 150k Ω , respectively.

CAUTION

NEVER APPLY A DC VOLTAGE MORE THAN \pm 35V DIRECT BETWEEN ANY OF THE UNKNOWN TERMINAL CENTER CONDUCTORS OR BETWEEN ANY UNKNOWN CENTER CONDUCTOR AND GROUND.

Figure 3-19. External DC Bias Circuits (sheet 3 of 4).

External DC Current Bias

General. A dc bias current can be caused to flow directly through an inductive or a resistive sample connected to the UNKNOWN terminals. This paragraph outlines the proper method and procedures for establishing such bias current through an inductive (resistive) sample from an external dc bias supply. The basic current bias method can be used to feed a bias current up to 100mA through the rear panel EXT $\pm 35V$ MAX connector (otherwise, a low bias current up to 1.3mA can be used at the EXT $\pm 200V$ MAX connector).

Current bias method:

1. Set front panel DC BIAS switch and CABLE LENGTH switch to the position appropriate to the test fixture used. Connect desired test fixture to UNKNOWN terminals.
2. Depress LINE button to turn instrument on.
3. Set 4275A controls according to General Component Measurement Procedure (Figure 3-16) steps 7 through 12 (Push DISPLAY A function "L" button).
4. Connect an external dc bias supply to rear panel EXT $\pm 35V$ MAX connector.
5. Set rear panel DC BIAS switch to EXT $\pm 35V$ MAX position.
6. Connect sample to test fixture.
7. Increase dc bias supply output voltage while monitoring readout on output current meter until desired bias current is obtained.

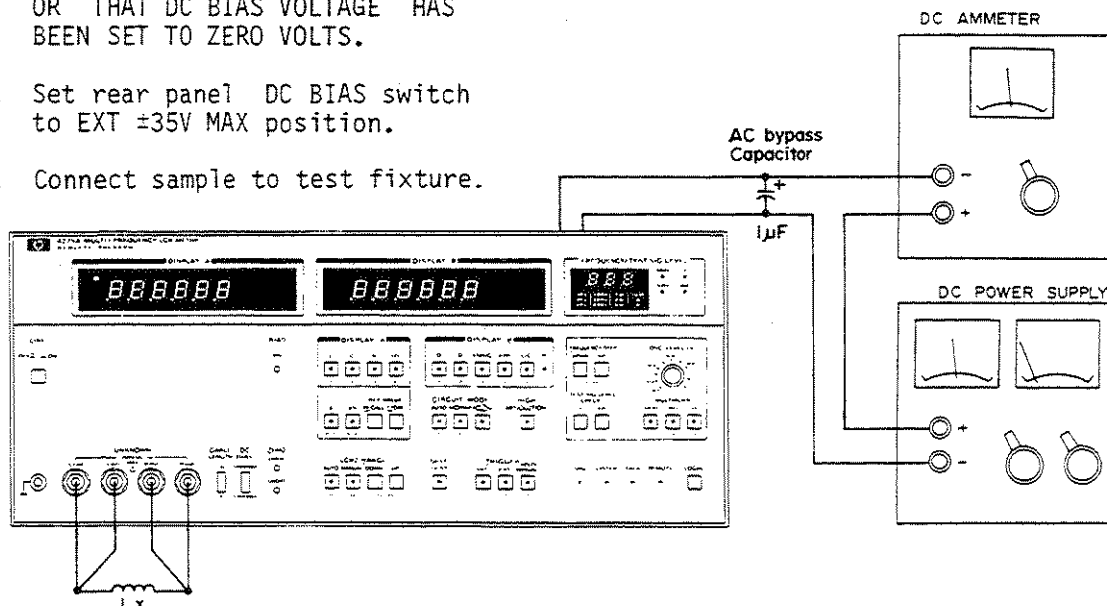
CAUTION

DO NOT ALLOW A BIAS CURRENT MORE THAN 100mA (60mA AT 10kHz TEST FREQUENCY) TO FLOW. BIAS SUPPLY OUTPUT VOLTAGE SHOULD NOT EXCEED $\pm 35V$.

CAUTION

BEFORE OPERATING DC BIAS SWITCH, VERIFY THAT NO SAMPLE IS CONNECTED TO TEST FIXTURE OR THAT DC BIAS VOLTAGE HAS BEEN SET TO ZERO VOLTS.

5. Set rear panel DC BIAS switch to EXT $\pm 35V$ MAX position.
6. Connect sample to test fixture.



HELPFUL INSTRUCTIONS
FOR CERTAIN MEASUREMENTS

INDUCTANCE MEASUREMENT

When an inductive sample with a ferromagnetic core is measured in AUTO range mode, the instrument repeats range selection and may not complete the measurement depending upon test signal level or test frequency.

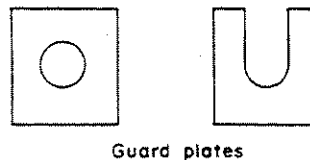
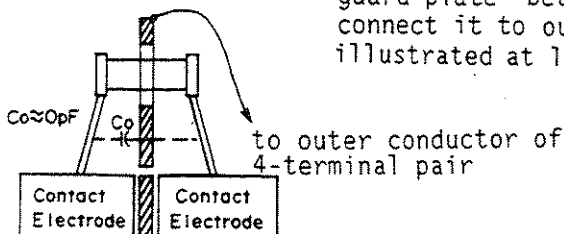
This symptom occurs when inductance of an inductor with a core changes value because of the current flowing through the coil. Permeability of inductor cores vary with measurement signal level (current) which differs with range and frequency.

To measure such samples, set LCR RANGE to MANUAL. Manually settle the instrument on an appropriate range. It is suggested that test signal current be monitored by pressing TEST SIG LEVEL CHECK mA button.

LOW CAPACITANCE MEASUREMENT

Stray capacitances present around component leads and test fixture contact electrodes contribute to additional measurement errors with more significance in low capacitance measurements.

To reduce such stray capacitances, insert the component leads deeply into the test fixture. Measurement accuracy for low capacitance sample can be improved by using a guard to eliminate the stray capacitances. Place guard plate between component leads of the sample and connect it to outer conductor of 4-terminal pair as illustrated at left:



Perform ZERO offset adjustment in high resolution mode (guard plate should be in place).

HIGH FREQUENCY MEASUREMENT

Measurements at frequencies higher than 1MHz should consider connection methods which can minimize the residual impedances present in the measuring circuit.

To reduce component lead impedance, make the lead length short by inserting leads deeply into test fixture. Use contact module for short lead components or the 16047C Test Fixture (designed especially for high frequency measurements).

Figure 3-20. Helpful Instructions (sheet 1 of 2).

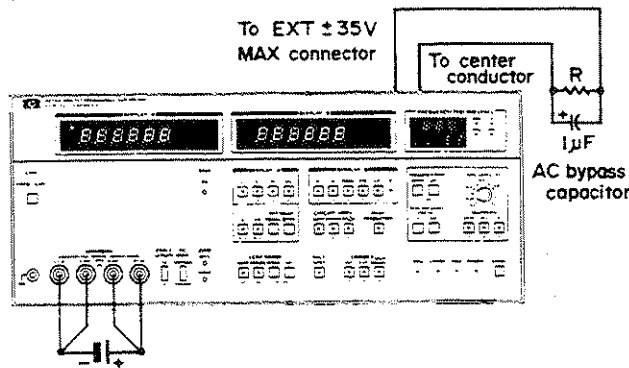
LOW IMPEDANCE MEASUREMENT

Because of their lead impedances, when low impedance samples such as high value capacitors, low value inductors or low value resistors (below 100Ω in impedance) are measured, display outputs with respect to the same sample may differ each time the measurement is attempted.

To obtain reliable measurement results, reduce the effects of component lead impedance by the same methods outlined in the paragraph for High Frequency Measurement.

BATTERY RESISTANCE MEASUREMENT

Internal resistance of batteries up to ±35V can be measured by using measurement setup illustrated below:



Set 4275A controls as follows:

- DISPLAY A function R
- DISPLAY B function L or C
- Rear panel DC BIAS switch EXT ±35V MAX

Connect positive pole of 1μF capacitor to center conductor of rear panel EXT ±35V MAX connector and negative pole to outer conductor.

CAUTION

DO NOT APPLY A DC VOLTAGE OF MORE THAN 35V.

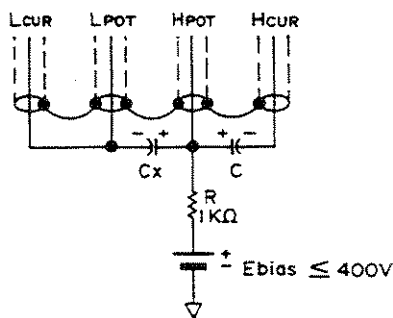
CAUTION

DO NOT ALLOW A BATTERY CURRENT OF OVER 100mA TO FLOW.

If it is desired to load battery during test, connect appropriate value resistor in parallel with the capacitor.

DC BIAS APPLICATION (400V ≥, >200V)

A circuit for dc bias applications up to 400V is illustrated below:



Capacitance value of the dc blocking capacitor C should satisfy the following condition:

$$C \geq \frac{1}{10\pi f}$$

Where, f is test frequency. If 10kHz test frequency is used, C value should be greater than 4μF.

CAUTION

MAXIMUM DC WITHSTAND VOLTAGE OF CAPACITOR MUST BE OVER 400V.

Figure 3-20. Helpful Instructions (sheet 2 of 2).

3-52. OPTIONS.

3-53. Options are standard modifications to the instrument that implement user's special requirements for minor functional changes. Operating instructions for the 4275A options (except rack mount and handle installation kit options) and associated information are described in the following paragraphs.

3-54. OPTION ANNUNCIATION

3-55. Installed option content is momentarily displayed in the front panel display just after the initial function test is performed to let users know what options are available in the instrument. Option annunciation is given in an abbreviation code representing each option. The display format and annunciation meanings are illustrated in Figure 3-21.

Note

Options other than those illustrated are not displayed.

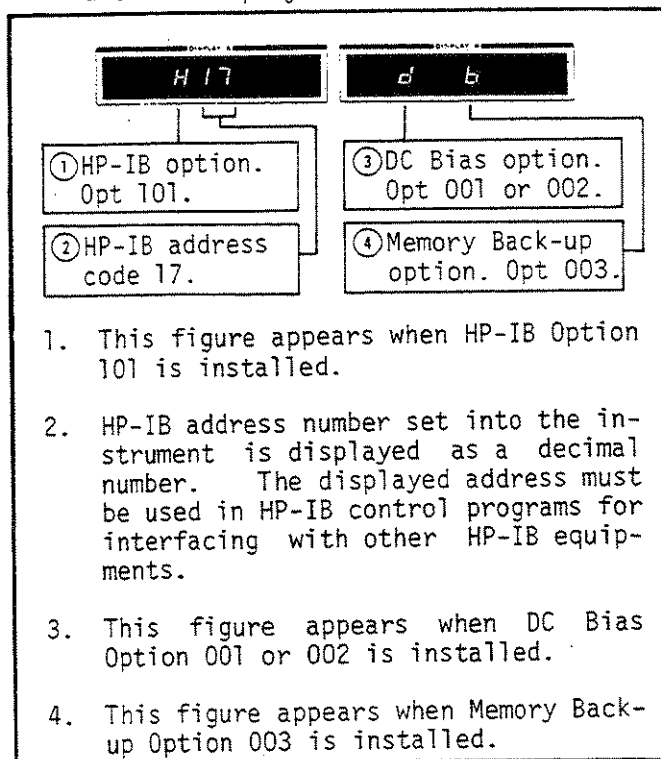


Figure 3-21. Option Annunciation Meanings.

3-56. OPTION 001 : DC BIAS (0-±35V).

3-57. The 4275A Option 001 adds an internal remotely controllable dc bias supply variable from .000 to ±35.0 volts. The 1mV step minimum voltage control as well as the accurate voltage setting capability of 0.5% (2% for high capacitance measurements) is useful for dc bias applications in semiconductor measurements. Bias voltage control is facilitated by using the Model 16023B Bias Controller or an HP-IB control signal through the rear panel connector. This paragraph describes operating procedures for Option 001 when using the 16023B controller. For dc bias applications using HP-IB control, refer to paragraph 3-64 Option 101 HP-IB Compatibility.

Note

Instructions for dc current bias applications are provided below dc (voltage) bias operating procedure.

PROCEDURE

1. Set front panel DC BIAS switch to ±35V MAX and CABLE LENGTH switch to the position appropriate to the test fixture used.

Note

DC BIAS switch may be set to ±200V MAX position when using a test fixture useable at dc biases up to ±200 volts.

2. Connect desired test fixture to UNKNOWN terminals.

Note

Any HP Test Fixtures or Leads may be used in this dc bias application.

3. Depress LINE button to turn instrument on.
4. Set 4275A controls according to General Component Measurement procedure (Figure 3-16) steps 7 through 12.
5. Connect 16023B Bias Controller to rear panel INT DC BIAS CONTROL connector.

CAUTION

BEFORE OPERATING DC BIAS SWITCH, VERIFY THAT NO SAMPLE HAS BEEN CONNECTED TO TEST FIXTURE OR THAT DC BIAS VOLTAGE HAS BEEN SET TO 0 VOLTS.

- 3) To monitor dc bias voltage, connect a DVM to rear panel INT DC BIAS MONITOR connector.

DC BIAS SETTling TIME.

DC BIAS Setting	Settling Time
INT 35V/100V ($\leq .1\mu\text{F}$)	Less than 20ms
INT 35V/100V ($\leq 200\mu\text{F}$)	$600 + 6 \cdot C_x$ ms

*Note: C_x = Capacitance reading in μF .

Note

DC bias is applied to sample through an internal 220Ω ($\leq .1\mu\text{F}$) or $1.05\text{k}\Omega$ ($\leq 200\mu\text{F}$) resistor.

6. When a low capacitance (below $0.1\mu\text{F}$) is to be measured using a dc bias, set rear panel DC BIAS switch to INT 35V/100V ($\leq .1\mu\text{F}$) position (to obtain shorter bias voltage settling time). To apply an internal dc bias to a high capacitance sample ($0.1\mu\text{F}$ to $200\mu\text{F}$), set the switch to INT 35V/100V ($\leq 200\mu\text{F}$) position.
7. Set 16023B MULTIPLIER switch to select appropriate bias voltage control range (X 0.1, X 1 or X 10). Set the desired voltage (positive or negative) into the three digit thumbwheel switch.
8. Connect sample to test fixture.

CAUTION

WHEN A POSITIVE BIAS VOLTAGE IS USED, POSITIVE POLE OF ELECTROLYTIC CAPACITOR MUST BE CONNECTED TO HIGH TERMINALS. WHEN USING A NEGATIVE BIAS VOLTAGE, CONNECT POSITIVE POLE TO LOW TERMINALS.

9. Press 16023B ENTER button to apply dc bias voltage to the sample.
10. Read 4275A capacitance display after allowing time for bias voltage to settle.

Note

- 1) When rear panel DC BIAS switch is set to INT 35V/100V ($\leq .1\mu\text{F}$) position, the measurement of capacitance greater than $0.1\mu\text{F}$ may cause readouts to fluctuate and "Err 4" annunciation is sometimes displayed.
- 2) When 16023B controls are set for a dc voltage greater than ± 35.0 volts, "Err7" annunciation is displayed and the dc bias is not applied to sample.

3-58. OPTION 002: DC BIAS (0-±99.9V).

3-59. The 4275A Option 002 adds a remotely controllable internal dc bias supply variable from 00.0 to ±99.9 volts at a basic voltage accuracy of 2%. This wide range voltage control capability is suitable for dc bias applications in general capacitance measurements. Bias voltage control is facilitated either by the Model 16023B Bias Controller or via an HP-IB control signal through the rear connector. This paragraph describes the operating procedures for Option 002 when using the 16023B controller. For dc bias applications with HP-IB control, refer to paragraph 3-64 Option 101 HP-IB Compatibility.

Note

Option 002 internal dc bias should be used for capacitance measurements below 0.1µF.

PROCEDURE

1. Set front panel DC BIAS switch to ±200V MAX and CABLE LENGTH switch to the position appropriate to the test fixture used.

CAUTION

WHEN A TEST FIXTURE USEABLE AT DC BIASES UP TO ±35 VOLTS IS USED, SET DC BIAS SWITCH TO ±35V MAX POSITION. THIS ACTION AUTOMATICALLY LIMITS DC BIAS TO ±35 VOLTS AND "Err 7" WILL BE DISPLAYED IF DC BIAS IS SET FOR OVER ±35 VOLTS.

2. Connect desired test fixture to the UNKNOWN terminals.
3. Depress LINE button to turn instrument on.
4. Set 4275A controls according to General Component Measurement procedure (Figure 3-16) steps 7 through 12.
5. Connect 16023B Bias Controller to rear panel INT DC BIAS CONTROL connector.

CAUTION

BEFORE OPERATING DC BIAS SWITCH, VERIFY THAT NO SAMPLE HAS BEEN CONNECTED TO TEST FIXTURE OR THAT DC BIAS VOLTAGE HAS BEEN SET TO ZERO VOLTS.

6. Set 4275A rear panel DC BIAS switch to either INT 35V/100V ($\leq 0.1\mu F$) or INT 35V/100V ($\leq 200\mu F$) position.
7. Set 16023B MULTIPLIER switch to X10 position. Set the desired voltage (positive or negative) into the three digit thumbwheel switch.
8. Connect sample to test fixture.
9. Press 16023B ENTER button to apply dc bias voltage to the sample.
10. Read 4275A capacitance display after allowing time for bias voltage to settle.

Note

- 1) When a capacitance greater than 0.1µF is measured, the capacitance reading may fluctuate and "Err 4" annunciation may sometimes be displayed.
- 2) To monitor dc bias voltage, connect a DVM to rear panel INT DC BIAS MONITOR connector.
- 3) If the 16047B Test Fixture is being used, capacitor is discharged through a 10Ω resistor when protective cover is opened.

DC BIAS SETTLING TIME

Bias settling time is less than 300ms.

Note

DC bias is applied to sample through an internal 50kΩ resistor.

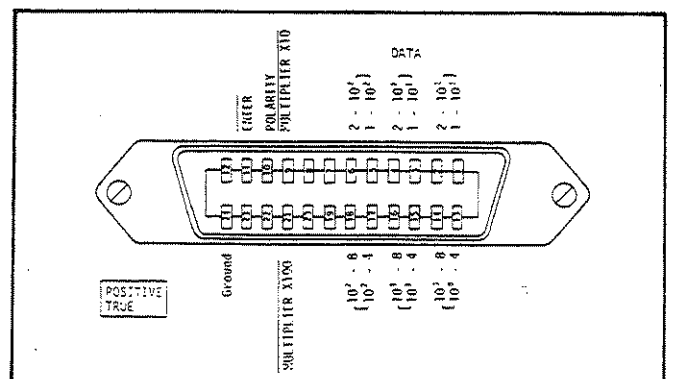


Figure 3-22. DC Bias Connector.

**3-60. OPTION 003:
BATTERY MEMORY BACKUP.**

3-61. The 4275A Option 003 provides continuous memory capability for retaining the memory of desired instrument control settings. Front panel control settings which are specially used for a particular application or are frequently used can be memorized by the instrument for repeated use of the same settings. The stored memory of the control settings is continuously held in event the instrument loses its operating power, and automatically so sets the instrument when normal operating power is restored. In other cases, the memorized panel control settings can, at anytime, be again set into the instrument as its actual control settings by merely pushing two buttons (LOCAL and RECALL). For storing the desired control settings in the memory, proceed as follows:

- 1) Set front panel controls as appropriate for making the desired measurement.
- 2) Press and hold LOCAL button at least 1 second. Figures **55** (memory back-up operation) will begin to flash in DISPLAY A.
- 3) Press REF VALUE STORE button before the display ceases flashing. If the STORE button is not pressed, the memory mode operation is automatically deactivated after an elapse of five seconds (display continues flashing) and the instrument resumes normal measurements. To reactivate the memory mode operation, again press LOCAL button.
- 4) The instrument has now memorized the front panel control settings. This setting status will again be enabled (instead of standard initial control settings) when the instrument is turned on. To restore the memorized control settings in place of temporary setting, press LOCAL button for one second and then REF VALUE RECALL button.

Note

Offset control values for a particular test fixture and the reference value in deviation measurements are also stored in the continuous memory.

Note

SELF TEST setting is not memorized.

TYPICAL LIFE OF STANDBY BATTERY IS 40,000 HOURS (CUMULATIVE BATTERY OPERATING TIME DURING MEMORY PROTECTION OPERATION). FOR BATTERY REPLACEMENT, REFER TO INSTRUCTIONS IN SERVICE MANUAL.

Note

The functions and capabilities of Option 003, Battery Memory Backup, are installed in all 4275A instruments with serial number 2045J01243 above.

**3-62. OPTION 004:
1-3-5 STEP TEST FREQUENCY.**

3-63. The 4275A Option 004 provides the following test frequencies instead of 10 step standard test frequencies (unit: hertz):

10k	100k	1M	10M
30k	300k	3M	*
50k	500k	5M	*

The above test frequencies are labeled on the FREQUENCY/TEST SIG LEVEL display window (* mark indicates that one or two special test frequencies can be optionally added). The desired test frequency is selected from among these 10 spot optional frequencies by pushing FREQUENCY STEP DOWN or UP button in the same manner as that in selection of test frequency for the standard 4275A. Other functions and performance is the same as those of the standard instrument (for accuracies at the optional frequencies, refer to specifications in Section I).

3-64. Special Test Frequency Option.

3-65. The 4275A Special Test Frequency Option adds one or two test frequencies desired in the frequency range of 10kHz to 10.7MHz. The special test frequencies are selected by pushing FREQUENCY STEP DOWN or UP button in the same manner as that in selection of standard test frequencies. The optional frequencies appear, irrespective of their individual values, after 10MHz test frequency when higher test frequencies are, in turn, selected by pushing UP button. This corresponds to the * mark position in the test frequency tabulation shown in the FREQUENCY/TEST SIG LEVEL display. The test frequency setting is also displayed in the FREQUENCY/TEST SIG LEVEL display when the special frequency is selected.

3-66. OPTION 101: HP-IB COMPATIBILITY.

3-67. The Model 4275A Opt.101 can be remotely controlled by means of the HP-IB which is a carefully defined instrumentation interfacing method that simplifies the integration of instruments and a calculator or computer into a system. HP-IB is Hewlett-Packard's implementation of IEEE Std. 488-1975 Standard Digital Interface for Programmable Instrumentation.

Note

The functions and capabilities of Option 101, HP-IB Compatibility, are installed in all 4275A instruments with serial number 2045J01243 and above.

3-68. Connection to HP-IB.

3-69. The 4275A Opt. 101 may be connected into an HP-IB bus configuration with or without a controller (e.g. with or without a HP calculator). In an HP-IB system without a controller, the 4275A Opt.101 can function as a talk only device (refer to paragraph 3-74).

3-70. HP-IB Status Indicators.

3-71. The HP-IB Status Indicators are four LED lamps on the front panel. These lamps show the status of the 4275A in an HP-IB system as follows:

- SRQ : SRQ signal on HP-IB line from 4275A (refer to paragraph 3-92).
- LISTEN : The 4275A is set to be listener.
- TALK : The 4275A is set to be talker.
- REMOTE : The 4275A is remotely controlled.

Note

The functions and capabilities of Option 003, Battery Memory Backup, are installed in all 4275A instruments with serial number 2045J01243 above.

3-72. LOCAL Switch.

3-73. The LOCAL switch disables remote control from HP-IB control and enables setting measurement conditions at front panel controls (pushbutton switches). REMOTE HP-IB Status Indicator lamp turns off when LOCAL switch is depressed. This function can not be used when the 4275A is set to local lockout status by controller.

3-74. HP-IB Control Switch.

3-75. The S1 HP-IB Control Switch on A22 HP-IB board controls seven digits and three capabilities as follows:

- (1) Bit 1~5 : The HP-IB address is established by these five digits of the Control Switch.

- (2) Bit 6 (delimiter form bit) : This bit determines delimiter form of output data which are:

- 0: Comma (,)
- 1: Carriage return Line feed (CR LP)

Refer to paragraph 3-84.

- (3) Bit 7 (talk only bit) : This bit determines instrument capabilities which are:

- 0: Addressable
- 1: Talk Only

Note

The 4275A Opt.101 is set at the factory as given in Figure 3-23.

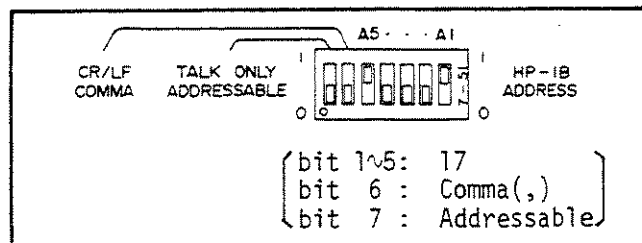


Figure 3-23. HP-IB Control Switch.

WARNING

If an external DC bias source is to be connected to EXT $\pm 200V$ MAX DC BIAS connector on rear panel, use the following procedures to change A22S1 HP-IB Control Switch to avoid an electric shock hazard:

1. Set external DC bias to 0V.
2. Disconnect external DC bias from 4275A.
3. Remove 4275A power cable from instrument.
4. Remove 4275A top cover.
5. Change A22S1 HP-IB Control Switch to appropriate setting.
6. Replace top cover and reinstall power cable.
7. Connect external DC bias source to EXT $\pm 200V$ MAX DC BIAS connector on rear panel.
8. Set bias source for desired DC bias.
9. Instrument is now ready for use at $\pm 200V$ DC biases.

3-76. HP-IB Interface Capabilities of 4275A Opt.101.

3-77. The interface capability of a device connected to the HP-IB is specified by the interface functions built into the device. The 4275A Opt.101 has eight HP-IB interface functions as given in Table 3-10.

Table 3-10. HP-IB Interface Capabilities.

Code	Interface Function* (HP-IB Capabilities)
SH1**	Source Handshake.
AH1	Acceptor Handshake.
T5	Talker (basic talker, serial poll, talk only mode, unaddress to talk if addressed to listen).
L4	Listener (basic listener, unaddress to listen if addressed to talk).
SR1	Service Requests.
RL1	Remote/Local (with local lockout).
DC1	Device Clear.
DT1	Device Trigger.

*Interface functions provide the means for a device to receive, process and transmit messages over the bus.

**The suffix number of the interface code indicates the limitation of the function capability as defined in Appendix C of IEEE Std. 488-1975.

3-78. Remote Program Code.

3-79. Remote program codes for the 4275A Opt.101 are listed in Table 3-11.

3-80. DC-Bias Programming.

3-81. A 4275A Opt.101 with options 001 or 002 can be set to a DC-Bias setting by remote programming as follows:

BI ±NNN E ±NN V
 (1) (2)

- (1) 3 digits for mantissa
- (2) 2 digits for exponent

Note

If not set, polarity of mantissa (or exponent) is automatically set to plus(+).

3-82. Data Output.

3-83. Data outputted by the model 4275A Opt.101 consists of:

- (1) Display A and Display B
- (2) Recall Reference
- (3) Test Signal Level
- (4) Key Status
- (5) Service Request Status Byte

In the following several paragraphs, output data form is described.

3-84. Display A and Display B Data.

3-85. Two output formats are possible with the 4275A Opt.101:

a. Format A.

To output either display A data and display B data in a continuous string, the delimiter form bit (the HP-IB Control Switch Bit 6) on the A22 board is set to 0 (see paragraph 3-74). In this mode, data is outputted in the following format:

X X X X ±N.NNNNE±NN , X X ±N.NNNNE±NN (CR) (LF)
 (1)(2)(3)(4)(5) (6) (7)(8)(9) (10) (11)

Note

The 4275A Opt.101 is set at the factory for output Format A.

b. Format B.

To break the data into two groups (limits line length) for outputting to certain peripherals such as to an HP Model 5150A Thermal Printer, the delimiter form bit on A22 board is set to 1 (see paragraph 3-74). All data is then outputted in the following format:

X X X X ±N.NNNNE±NN (CR) (LF)
 (1)(2)(3)(4)(5) (6) (11)

X X ±N.NNNNE±NN (CR) (LF)
 (8)(9) (10) (11)

- (1) Space.
- (2) Circuit Mode.
- (3) Measuring Frequency.
- (4) Data Status of Display A.
- (5) Function of Display A.
- (6) Value of Display A.
- (7) Comma.
- (8) Data Status of Display B.
- (9) Function of Display B.
- (10) Value of Display B.
- (11) Data Terminator.

Circuit Mode, Measuring Frequency, Data Status and Function are expressed by a letter of the alphabet as given in Table 3-12.

Table 3-11. Remote Program Codes (sheet 1 of 2).





	Control	Program Code	Description																				
Display A Function	L	A1	Combinations of A and B are listed in the table below:																				
	C	A2																					
	R	A3																					
	Z	A4																					
Display B Function	D	B1	<table border="1"> <thead> <tr> <th>A \ B</th> <th>1</th> <th>2</th> <th>3</th> </tr> </thead> <tbody> <tr> <th>1</th> <td>L - D</td> <td>L - Q</td> <td>L - ESR/G</td> </tr> <tr> <th>2</th> <td>C - D</td> <td>C - Q</td> <td>C - ESR/G</td> </tr> <tr> <th>3</th> <td>R - X/B</td> <td>R - L/C</td> <td>R - X/B</td> </tr> <tr> <th>4</th> <td> Z - θ</td> <td> Z - θ</td> <td> Z - θ</td> </tr> </tbody> </table>	A \ B	1	2	3	1	L - D	L - Q	L - ESR/G	2	C - D	C - Q	C - ESR/G	3	R - X/B	R - L/C	R - X/B	4	Z - θ	Z - θ	Z - θ
	A \ B	1		2	3																		
	1	L - D		L - Q	L - ESR/G																		
	2	C - D		C - Q	C - ESR/G																		
	3	R - X/B		R - L/C	R - X/B																		
	4	Z - θ		Z - θ	Z - θ																		
Q	B2																						
ESR/G	B3																						
X/B	B1, B3																						
L/C	B2																						
θ	B1, B2, B3																						
Circuit Mode	AUTO	C1																					
		C2																					
		C3																					
Deviation Measurement	OFF	D0	These program codes can not be used if reference data is not stored.																				
	Δ	D1																					
	$\Delta\%$	D2																					
Frequency Step	10kHz	F11	The frequency spots in parentheses are used in Option 004.																				
	20(30)kHz	F12																					
	40(50)kHz	F13																					
	100kHz	F14																					
	200(300)kHz	F15																					
	400(500)kHz	F16																					
	1MHz	F17																					
	2(3)MHz	F18																					
	4(5)MHz	F19																					
	10MHz	F20																					
	*1	F21																					
*2	F22																						
High Resolution	OFF	H0																					
	ON	H1																					
Data Ready	OFF	I0	If Data Ready is set to ON, SRQ signal is outputted when measurement data is provided.																				
	ON	I1																					

Table 3-11. Remote Program Codes (sheet 2 of 2).

Key State Out		K	This program code can be used to recognize the state of key settings.
Level Monitor	V A	LV LA	These program codes can be used to monitor the oscillator level at unknown terminals.
Multiplier	X0.01 X0.1 X1	M1 M2 M3	
LCRZ Range	AUTO MANUAL 1000fF/100nH 10pF/1000nH/100mΩ 100pF/10μH/10Ω 1000pF/100μH/100Ω 10nF/100μH/10kΩ 100nF/1mH/100kΩ 1000nF/10mH/10kΩ 10μF/1000mH/1000kΩ 100μF/10H/10MΩ 100H	R31 R32 R11 R12 R13 R14 R15 R16 R17 R18 R19 R20	Depending on DISPLAY A, DISPLAY B and Measuring Frequency settings: If range is set to a range which can not make the measurement, range is automatically reset to the nearest range capable of making the measurement.
Recall Reference Value		RE	This program code can not be used if reference data is not stored.
Self Test	OFF ON	S0 S1	
Store Reference Value		ST	
Trigger	INT EXT HOLD/ MANUAL	T1 T2 T3	When external trigger is used, set the 4275A to local by pressing the LOCAL key or via HP-IB programming (HP-85: LOCAL 717).
ZERO	OPEN SHORT	Z0 ZS	
Execute		E	This program code is used to trigger the instrument from HP-IB.

Table 3-12. Data Output Codes.

	Setting	Data Output Code
Circuit Mode		P
		S
Measuring Frequency	10kHz	H
	20(30)kHz	I
	40(50)kHz	J
	100kHz	K
	200(300)kHz	L
	400(500)kHz	M
	1MHz	N
	2(3)MHz	O
	4(5)MHz	P
	10MHz	Q
	*1	R
	*2	S
Data Status	Normal	N
	Overflow	O
	Underflow	U
	Change Function	C
Measuring Function	Self Test	SPACE
	L	L
	C	C
	R	R
	Z	Z
	%	P
	ΔL	H
	ΔC	F
	ΔR	W
	ΔZ	Y
	V	V
	A	A
	D	D
	Q	Q
	ESR	R
	G	G
	X	X
B	B	
θ	T	

3-86. Recall Reference Data.

3-87. This data is outputted from 4275A when the program code "RE" is used (refer to Figure 3-27). The data is outputted in the following format:

X±N.NNNNE±NN (CR) (LF)
(1)(2) (3) (4)

- (1) Space.
- (2) Function of Display A.
- (3) Value of Reference Data.
- (4) Data Terminator.

3-88. Test Signal Level Monitor Data.

3-89. This data is outputted from 4275A when Program Codes "LV" or "LA" are used (refer to Figure 3-27). The data is outputted in the following format:

X X±N.NNE±NN (CR) (LF)
(1)(2)(3) (4) (5)

- (1) Space.
- (2) Status of Level Measurement.
- (3) Measuring Function.
- (4) Value of Level Measurement Data.
- (5) Data Terminator.

3-90. Key Status Data.

3-91. This data is outputted from 4275A when the Program Code "K" is used (refer to Figure 3-26). The data is outputted in the following format:

ANBNCNDNFNNHNINMNRNNSN TN (CR) (LF)
(1)(2)(3)(4)(5) (6)(7)(8)(9)(10)(11)(12) (13)

- (1) Space.
- (2) A1~A4: Display A Function.
- (3) B1~B3: Display B Function.
- (4) C1~C3: Circuit Mode.
- (5) D0~D2: Delta Measure.
- (6) F11~F23: Frequency Step.
- (7) H0, H1: High Resolution.
- (8) I0, I1: Data Ready.
- (9) M1~M4: Multiplier.
- (10) R31, R32, R11~R23: LCRZ Range.
- (11) S0, S1: Self Test.
- (12) T1~T3: Trigger.
- (13) Data Terminator.

3-92. Service Request Status Byte.

3-93. The 4275A Opt.101 sends RQS (Request Service) signal whenever it is set in one of the four possible service request states. Figure 3-24 shows the Status Byte make up of the 4275A.

Bit	8	7	6	5	4	3	2	1
Information	0	0/1	0	0	0/1	0/1	0/1	0/1

Signal bit 7 (RQS signal) establishes whether or not service request exists. Signal bits 1 thru 4 identify the character of the service request states.

Service request status of the 4275A:

- (1) Bit 1 : If Data Ready is set to ON, this state is set when measurement data is provided.
- (2) Bit 2 : When the 4275A receives an erroneous Remote Program Code or an erroneous Internal DC Bias setting, this state is set.
- (3) Bit 3 : When Offset Zero or Self Test is completed, this state is set.
- (4) Bit 4 : This state is set in one of following states of the 4275A:
 - 1 Error 1, 5, 6, 7, or 8.
 - 2 Self Test is faulty.

Figure 3-24. Status Byte of the 4275A.

3-94. Programming Guide for 4275A.

3-95. Sample programs for the HP Series 80 or Series 200 Computers are provided in Figures 3-25 thru 3-27. These programs are listed in Table 3-13.

Note

Specific information for HP-IB programming with the HP Series 80 or Series 200 are provided in those programming manuals.

Note

The equipment required for these sample programs include:

4275A Opt.101

HP Series 80 Personal Computer (with 0085-15003 I/O ROM, 82937A HP-IB Interface) or HP Series 200 Desktop Computer (with 98601A or 98611A BASIC 2.0 Language System)

Table 3-13. Sample Programs.

Sample Program	Figure	Description
1	3-25	Basic remote program for 4275A.
2	3-26	How to use remote program code "K".
3	3-27	How to use remote program codes "RE", "LV" and "LA".

The 4275A may exhibit the following phenomena:

Phenomenon -1.

- (1) The first byte of measurement data is lost when read after Serial Polling.
- (2) The first several bytes of measurement data are lost when read after Serial Polling.

Phenomenon -2.

Out put measurement data from the 4275A may include two or more spaces in the first part of each string, though each datastring should have only one space. Refer to paragraph 3-81 on page 3-56 for data output format.

Phenomenon -3.

After Serial Polling, the status byte, which should be cleared, is not cleared from the register in the HP-IB Interface Adapter (Micro Port), A22U3.

Described below are software solutions for the above phenomena.

For Phenomenon -1 - (1):

There is no software solution.

For Phenomenon -1 - (2):

"Serial Polling (read status)" and "read one byte of measurement data" should not be executed sequentially.

For Phenomenon -2:

- 1) Read measurement data with free format.
- 2) Measurement data is read with the procedure: hold trigger--execute (trigger)--read data. However, the first measurement data of sequential measurement data is invalid.

Sample Program 1.

Description:

This program is a basic remote program for the 4275A. The program has three capabilities which are:

- (1) Control of the 4275A via HP-IB.
- (2) Trigger of the 4275A via HP-IB.
- (3) Data output from the 4275A via HP-IB.

Program:

```

10 REMOTE 717 (1) Select code of HP-IB Interface.
20 CLEAR 717 (2) Address code of 4275A.
30 OUTPUT 717 : "A2I3" (3) Program codes for 4275A (refer to Table 3-11).
40 OUTPUT 717 : "E" (4) This line means the as same as following program:
50 ENTER 717 : A.B TRIGGER 717
60 DISP A.B
70 PRINT A.B
80 END

```

By using string variables, complete output information from the 4275A Opt.101 is stored by the following program:

Program:

```

10 DIM AS[50]
20 REMOTE 717
30 CLEAR 717
40 OUTPUT 717 : "A2I3"
50 OUTPUT 717 : "E"
60 ENTER 717 : AS
70 DISP AS
80 PRINT AS
90 END

```

Figure 3-25. Sample Program 1

Sample Program 2.

Description:

The remote program code "K" can be used to recognize the status of key settings. This program shows how to use "K".

Note

Key setting information for the LCRZ Range using "K" is "R31" when the LCRZ Range is set to "R31 (AUTO)". Therefore, the LCRZ Range should be set to "R32 (MANUAL)" for recognizing the true LCRZ measuring range.

Program:

```

10 DIM AS[50]
20 REMOTE 717
30 OUTPUT 717 : "K"
40 ENTER 717 : AS
50 DISP AS
60 END

```

Note

The statements on lines 30 and 40 should be continuously programmed.

Figure 3-26. Sample Program 2

Sample Program 3.

Description:

This program shows how to use program codes "RE", "LV", and "LA":

- "RE" : This program code can be used to recall a display A reference value.
- "LV" : This program code can be used to monitor the test signal voltage across unknown terminals.
- "LA" : This program code can be used to monitor the test signal current through unknown terminals.

Note

"RE" can not be used if reference data was not stored.

Program:

```
10 REMOTE 717
20 OUTPUT 717 : "RE"  
    (1)
30 ENTER 717 : A
40 PRINT A
50 END
```

Note

The statements on lines 20 and 30 should be continuously programmed.

By using a string variable complete output information from the 4275A Opt.101 is stored by the following program:

Program:

```
10 DIM AS(60),BS(60)
20 REMOTE 717
30 CLEAR 717
40 OUTPUT 717 : "A2T3"  
    (1)
50 OUTPUT 717 : "E"
60 ENTER 717 : AS
70 DISP AS
80 OUTPUT 717 : "LV"  
    (2)
90 ENTER 717 : BS
100 DISP BS
110 END
```

Note

The statements on lines 50 and 60 are necessary before the statement on line 80 appears. If this is not done, wrong output data may be sent to the Bus.


Figure 3-27. Sample Program 3

OPERATING GUIDE

BASIC OPERATING PROCEDURE

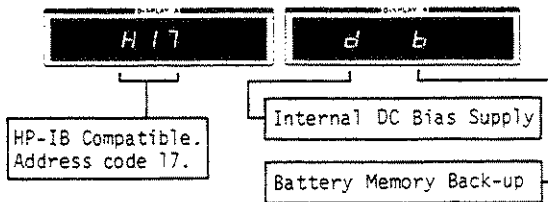
1. Set front panel DC BIAS switch and CABLE LENGTH switch as appropriate for using desired test fixture or test leads.

Setting switches qualify useable test fixture or test leads.

2. Connect desired test fixture or test leads to UNKNOWN terminals.
3. Press LINE button.
4. Automatic initial memory test is initiated. Five  figures appear in DISPLAY A:



5. Option content is, if any option is installed, displayed as:




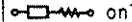

6. Automatic initial control settings. Instrument controls are automatically set as follows:

DISPLAY A function	C
Deviation measurement function	off
LCRZ RANGE	AUTO
DISPLAY B function	D
CIRCUIT MODE	AUTO
HIGH RESOLUTION	off
SELF TEST	off
TRIGGER	INT
Test frequency	1.00MHz
MULTIPLIER	x1

7. Select desired measurement function, and test frequency.

FREQUENCY STEP DOWN UP <input type="checkbox"/> <input type="checkbox"/>	Select desired test frequency (10kHz to 10MHz, std 10 spots)
--	--

Available Measurement Functions

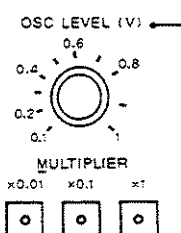
DISPLAY A	DISPLAY B		
		 only	 only
L <input type="checkbox"/>	D <input type="checkbox"/>	O <input type="checkbox"/>	ESR/ <input type="checkbox"/>
C <input type="checkbox"/>	D <input type="checkbox"/>	O <input type="checkbox"/>	ESR/ <input type="checkbox"/>
R <input checked="" type="checkbox"/>			X/ <input checked="" type="checkbox"/>
Z <input type="checkbox"/>			L/ <input checked="" type="checkbox"/>
			/B <input checked="" type="checkbox"/>
			/C <input checked="" type="checkbox"/>

8. Set MULTIPLIER to x1 and OSC LEVEL to fully CW position.
9. Perform zero offset adjustment.

IF BIAS INDICATOR LAMP LIGHTS, SET REAR PANEL DC BIAS SWITCH TO OFF.

1. Press ZERO OPEN button with no sample connected to test fixture.
2. "CAL" letters appear in DISPLAY A for about 5 seconds.
3. With a shorting strap connected to test fixture, press ZERO SHORT button.
4. "CAL" letters appear for about 5 seconds.
5. Remove shorting strap.

10. Set test signal for the desired amplitude.



Set OSC LEVEL control for desired test signal level amplitude.

X1	0.1V - 1V rms
X0.1	0.01V - 0.1V rms
X0.01	0.001V - 0.01V rms

To monitor test signal level, press and hold TEST SIG LEVEL CHECK V or mA button.

11. Connect sample to test fixture.
12. Read display outputs. If OF, UF, CF or Err is displayed, refer to pages 3-36 and 3-37 Annunciation display meanings. If negative D value is displayed, refer to Figure 3-16 step 15.

SELF TEST

IF BIAS INDICATOR LAMP LIGHTS, SET REAR PANEL DC BIAS SWITCH TO OFF.

1. Set front panel DC BIAS switch to $\pm 35V$ MAX and CABLE LENGTH switch to "0" position.
2. Connect 16047A Test Fixture to UNKNOWN terminals.
3. Set DISPLAY A function to C and OSC LEVEL control to fully cw position.
4. Press SELF TEST button.
5. Display Test is initiated. All front panel displays and indicator lamps, except BIAS indicator, illuminate for 1 second.
6. Successively, the Analog Circuit Test is initiated. Nothing should be connected to test fixture.

-OPEN TEST-

The letters **OP** appear in DISPLAY A during open test.



If an abnormality is detected, the respective test step (from 1 to 20) is displayed.



The sequential diagnostic test is repeated after the Display Test.

-SHORT TEST-

7. Set DISPLAY A function to L or R.
8. Connect a shorting strap to test fixture.
9. The letters **SH** appear in DISPLAY A during short test.



If an abnormality is detected, the respective test step (from 21 to 27) is displayed.



The sequential diagnostic test including Display Test is continuously repeated.

10. To stop cyclic self test operation, again press SELF TEST button.

ANNUNCIATION DISPLAY MEANINGS (Brief summary)

DISPLAY A	DISPLAY B	Indicated Condition	DISPLAY A	DISPLAY B	Indicated Condition
OP	—	Inappropriate DISPLAY A function setting. Measured L, C, R or Z value exceeds upper range limit.	Err 5	—	Error in deviation measurement control operation. STORE function actuated while annunciation or Δ or $\Delta\%$ value was being displayed.
UF	—	Measured L, C, R or Z value is too low.	Err 6	—	Error in deviation measurement control operation. Δ or $\Delta\%$ function actuated in measurement of parameter values not comparable with reference value.
(Any reading)	DF	Measured value in DISPLAY B function exceeds upper range limit.	Err 7	—	Error in dc bias operation: 1. Internal dc bias operation without internal bias supply installed. 2. Bias voltage setting exceeds maximum bias voltage limit.
	LF	Improper selection of DISPLAY B function (choose another).	Err 8	—	Error in dc bias operation. Inappropriate setting of front or rear panel DC BIAS switch.
Err 1	—	Error in ZERO offset adjustment. Residual parameter value exceeds offset control range limit.	Err 9	—	Error in memory back-up operation: 1. Memory data to be preserved has been lost. 2. Stand-by battery (for retaining memory) has become exhausted.
Err 2	—	Error in DISPLAY B function setting. The function incompatible with DISPLAY A setting.			
Err 3	—	Error in ranging operation. Ranging operation has actuated unuseable range.			
Err 4	—	Error in measuring circuit configuration: 1. Measuring circuit is open or short circuited. 2. 16047B protective cover open. 3. Ranging operation has actuated unuseable range with dc bias.			

