

## Oscilloscope HM407-2

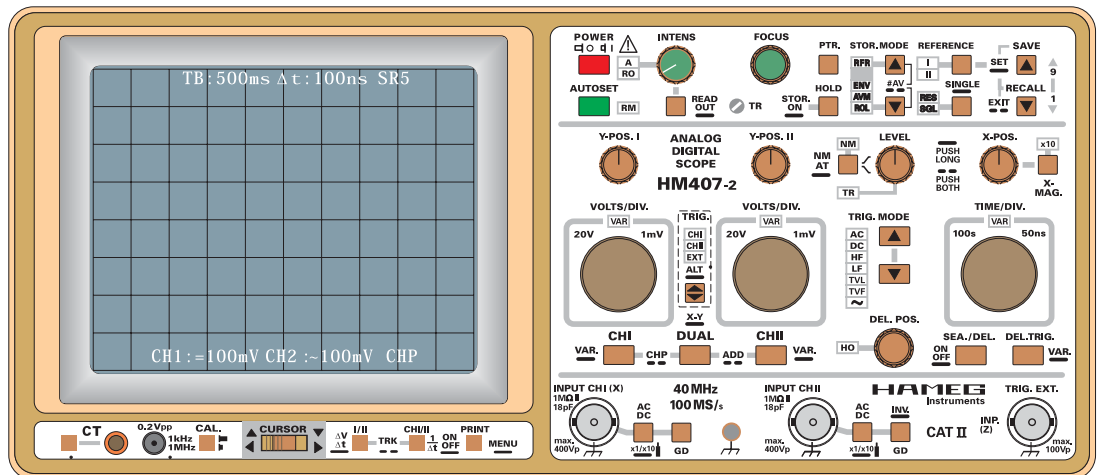



**CE - Declaration of conformity ..... 4**

**Technical Data ..... 5**

**ATT ..... 6**

**MB ..... 10**

**YF ..... 18**

**FC ..... 20**

**DIGI ..... 23**

**CCT ..... 29**

**CRT ..... 32**

**PS ..... 34**

**IF ..... 37**



Herstellers  
Manufacturer  
Fabricant

HAMEG GmbH  
Kelsterbacherstraße 15-19  
D - 60528 Frankfurt

Bezeichnung / Product name / Designation:

Oszilloskop/Oscilloscope/Oscilloscope

Typ / Type / Type: HM407-2

mit / with / avec: -

Optionen / Options / Options: HO79-6

mit den folgenden Bestimmungen / with applicable regulations / avec les directives suivantes

EMV Richtlinie 89/336/EWG ergänzt durch 91/263/EWG, 92/31/EWG  
EMC Directive 89/336/EEC amended by 91/263/EWG, 92/31/EEC  
Directive EMC 89/336/CEE amendée par 91/263/EWG, 92/31/CEE

Niederspannungsrichtlinie 73/23/EWG ergänzt durch 93/68/EWG  
Low-Voltage Equipment Directive 73/23/EEC amended by 93/68/EEC  
Directive des équipements basse tension 73/23/CEE amendée par 93/68/CEE

KONFORMITÄTSERKLÄRUNG  
DECLARATION OF CONFORMITY  
DECLARATION DE CONFORMITE

**HAMEG**  
Instruments

Angewendete harmonisierte Normen / Harmonized standards applied / Normes harmonisées utilisées

Sicherheit / Safety / Sécurité

EN 61010-1: 1993 / IEC (CEI) 1010-1: 1990 A 1: 1992 / VDE 0411: 1994  
EN 61010-1/A2: 1995 / IEC 1010-1/A2: 1995 / VDE 0411 Teil 1/A1: 1996-05  
Überspannungskategorie / Overvoltage category / Catégorie de surtension: II  
Verschmutzungsgrad / Degree of pollution / Degré de pollution: 2

Elektromagnetische Verträglichkeit / Electromagnetic compatibility /  
Compatibilité électromagnétique

EN 61326-1/A1  
Störaussendung / Radiation / Emission: Tabelle / table / tableau 4; Klasse / Class /  
Classe B.  
Störfestigkeit / Immunity / Imunitee: Tabelle / table / tableau A1.

EN 61000-3-2/A14  
Oberschwingungsströme / Harmonic current emissions / Émissions de courant  
harmonique: Klasse / Class / Classe D.

EN 61000-3-3  
Spannungsschwankungen u. Flicker / Voltage fluctuations and flicker /  
Fluctuations de tension et du flicker.

Datum /Date /Date

15.01.2001

Unterschrift / Signature / Signatur

E. Baumgartner  
Technical Manager / Directeur Technique

## General information regarding the CE marking

HAMEG instruments fulfill the regulations of the EMC directive. The conformity test made by HAMEG is based on the actual generic- and product standards. In cases where different limit values are applicable, HAMEG applies the severer standard. For emission the limits for residential, commercial and light industry are applied. Regarding the immunity (susceptibility) the limits for industrial environment have been used.

The measuring- and data lines of the instrument have much influence on emission and immunity and therefore on meeting the acceptance limits. For different applications the lines and/or cables used may be different. For measurement operation the following hints and conditions regarding emission and immunity should be observed:

### 1. Data cables

For the connection between instruments resp. their interfaces and external devices, (computer, printer etc.) sufficiently screened cables must be used. Without a special instruction in the manual for a reduced cable length, the maximum cable length of a dataline must be less than 3 meters and not be used outside buildings. If an interface has several connectors only one connector must have a connection to a cable.

Basically interconnections must have a double screening. For IEEE-bus purposes the double screened cables HZ72S and HZ72L from HAMEG are suitable.

### 2. Signal cables

Basically test leads for signal interconnection between test point and instrument should be as short as possible. Without instruction in the manual for a shorter length, signal lines must be less than 3 meters and not be used outside buildings.

Signal lines must be screened (coaxial cable - RG58/U). A proper ground connection is required. In combination with signal generators double screened cables (RG223/U, RG214/U) must be used.

### 3. Influence on measuring instruments.

Under the presence of strong high frequency electric or magnetic fields, even with careful setup of the measuring equipment an influence of such signals is unavoidable.

This will not cause damage or put the instrument out of operation. Small deviations of the measuring value (reading) exceeding the instruments specifications may result from such conditions in individual cases.

### 4. RF immunity of oscilloscopes.

#### 4.1 Electromagnetic RF field

The influence of electric and magnetic RF fields may become visible (e.g. RF superimposed), if the field intensity is high. In most cases the coupling into the oscilloscope takes place via the device under test, mains/line supply, test leads, control cables and/or radiation. The device under test as well as the oscilloscope may be effected by such fields.

Although the interior of the oscilloscope is screened by the cabinet, direct radiation can occur via the CRT gap. As the bandwidth of each amplifier stage is higher than the total -3dB bandwidth of the oscilloscope, the influence RF fields of even higher frequencies may be noticeable.

#### 4.2 Electrical fast transients / electrostatic discharge

Electrical fast transient signals (burst) may be coupled into the oscilloscope directly via the mains/line supply, or indirectly via test leads and/or control cables. Due to the high trigger and input sensitivity of the oscilloscopes, such normally high signals may effect the trigger unit and/or may become visible on the CRT, which is unavoidable. These effects can also be caused by direct or indirect electrostatic discharge.

HAMEG GmbH

## Specifications

### Vertical Deflection

**Operating modes:** Channel I or CH II separate, Channel I and II: alternate or chopped (Chopper Frequency approx. 0.5MHz)  
**Sum or Difference** from Channel I and  $\pm$  Ch. II,  
**XY-Mode:** via CH I (X) and CH II (Y).  
**Frequency range:** 2x DC to 40MHz (-3dB).  
 Risetime: <8.75ns. Overshoot:  $\leq 1\%$ .  
**Deflection coefficient:** 14 calibrated positions variable 2.5:1 to min. **50V/div.**  
**1mV/div and 2mV/div:**  $\pm 5\%$  (0 to 10MHz (-3dB))  
**5mV/div to 20V/div:**  $\pm 3\%$  (1-2-5sequence).  
**Input impedance:** 1M $\Omega$  II 18pF.  
 Input coupling: DC - AC - GD (Ground)  
 Input voltage: max. 400V (DC + peak AC).

### Triggering

**Automatic** (peak to peak):  **$\leq 20\text{Hz}$ -**100MHz**** ( $\geq 0.5\text{div}$ ),  
 Normal: **DC-100MHz**, LED for trigger indication.  
**Slope:** positive or negative.  
**Sources:** CH I or II, line, ext.  
 CH I alternate CH II ( $\geq 0.8\text{div}$ )  
 Coupling: **AC** ( $\geq 10\text{Hz}$  - 100MHz), **DC** (0 - 100MHz),  
**HF** (50kHz - 100MHz), **LF** (0 -  $\leq 1.5\text{kHz}$ ).  
**Triggering ext.:**  $\geq 0.3\text{Vpp}$  from DC to 40MHz  
**Active TV-Sync-Separator** (field & line, pos, neg.)  
**2nd triggering (Del. Trig.):** normal with level control DC to 100 MHz.

### Horizontal Deflection

**Time coefficients:** 1-2-5 sequence, Accuracy  $\pm 3\%$   
**Analog:** 22 cal. positions from **0.5s** - 50ns/div.  
**Digital:** 27 cal. positions from **100s** - **0.2 $\mu$ s/div.**  
 Variable (analog) 2.5:1 up to 1.25s/div.  
**X-MAG.x10:** analog to 10ns/div., dig. to 20ns/div  $\pm 5\%$ .  
**Delay:** 120ms - 200ns, variable,  
**Hold-off time** (analog): variable to approx. 10:1.  
**Bandwidth X-amplifier** (analog): 0-3MHz (-3dB).  
 Input X-amplifier via Channel II, Sensitivity see Channel II.  
**X-Y-phase shift** :  $< 3^\circ$  below 120kHz.

### Digital Storage

**Operating modes:** Refresh, Roll, Single, XY, Envelope, Average (2 to 512 waveforms).  
**Automatic Dot Join** function  
**Sample Rate:** max. **100MSa/s** (8 bit)  
**Refresh rate:** max. 180/s  
**Record length:** 2048 x 8 bit per channel.  
**Reference memory:** 2 x 2k x 8bit (EEPROM).  
**Resolution:** Y: **25 points/div.**, X: **200 points/div.**  
**Pre-/Posttriggerer:** 25, 50, 75, 100, -25, -50, -75%.

### Operation / Control

**Manual** (front panel switches);  
**Auto Set** (automatic parameter selection).  
**Save / Recall** of 9 user-defined parameter settings  
**RS232 interface** for remote control via a PC.  
 Remote control (Option) **HZ68**.  
**Multifunction-Interface** HO79-6(Option): RS232, IEEE-488, Centronics (Postscript, HPGL, PCL, EPSON).  
**Readout:** Display of parameter settings.  
**Cursor measurement** of  $\Delta V$ ,  $\Delta t$  or  $\Delta 1/t$  (frequency), separate or in tracking mode.

### Component Tester

**Test voltage:** approx. 7V<sub>rms</sub> (open circuit).  
**Test current:** max. 7mA<sub>rms</sub> (short circuit).  
**Test frequency:** approx. 50Hz  
 One test lead is grounded (Safety Earth).

### General Information

**CRT:** D14-364GY/123 or ER151-GH/-, rectangular screen (8x10cm) internal graticule  
**Acceleration voltage:** approx 2000V  
**Trace rotation:** adjustable on front panel  
**Calibrator:** square-wave generator ( $t_r < 4\text{ns}$ )  $\approx 1\text{kHz}/1\text{MHz}$ ; Output: 0.2V  $\pm 1\%$ .  
**Analog Intensity modulation,** max. +5V (TTL).  
**Line voltage:** 100-240V AC  $\pm 10\%$ , 50/60Hz  
**Power consumption:** approx. 42 Watt at 50Hz.  
 Min./Max. ambient temperature: 0°C...+40°C  
**Protective system:** Safety class I (IEC1010-1)  
 Weight: approx. 6.0kg, color: techno-brown  
 Cabinet: W 285, H 125, D 380 mm

4/00

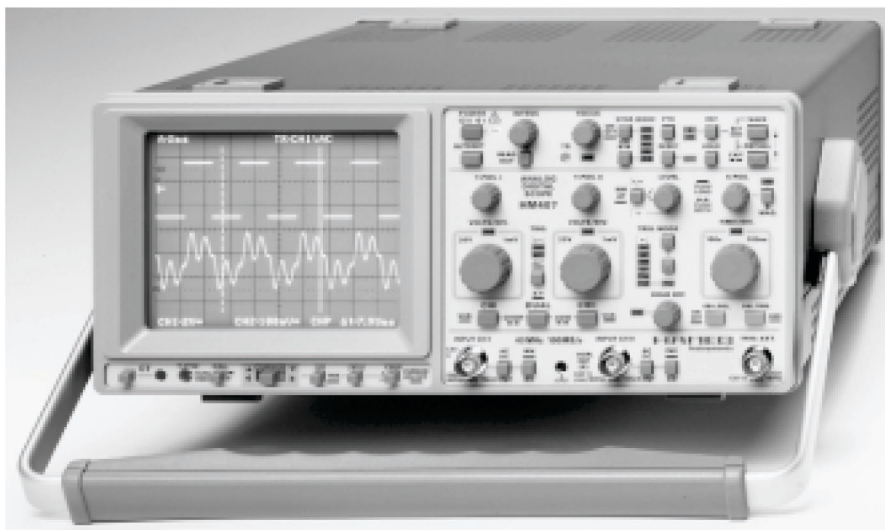

## 40MHz Analog-/Digital-Scope HM407-2

Auto-Set, Save/Recall, Readout/Cursor, RS232 Interface

**Analog:** 2 x DC-40MHz, max. 1mV/div, Timebase 0.5s/div - 10ns/div  
**Triggering** DC - 100MHz, Component Tester, 1MHz Calibrator  
**Digital:** Max. Sampling Rate 100MSa/s, Timebase 100s/div - 20ns/div  
**Storage** 2 x 2048 x 8 bit, Reference Memory, Post/Pre-Trigger  
**Storage Modes:** Refresh, Single, Roll, Average and Envelope

The worldwide success of HAMEG's HM205 and HM305 has led to the introduction of the new microprocessor controlled HM407-2 Analog/Digital oscilloscope. This instrument offers much more performance and specifications over its predecessors. The HM407-2 incorporates a microprocessor-based system that extensively automates operation. The majority of signals can be displayed by simply pressing the "Autoset" button. A "Save/Recall" function is available for storing frequently used setup parameters.

The increased maximum sampling rate of 100MSa/s now allows to capture a 10MHz signal in "Single" mode with 10 samples (dots) per period. The automatic Dot-Join function provides linear connections between the captured points, ensuring that all digitized signals are displayed without gaps. New features are the two reference memories, allowing their contents to be compared with the live signal at any time. Cursors can be activated for waveform measurements. All important parameter settings are displayed on the CRT screen. The built-in RS232-Interface enables remote control operation and signal processing via a PC.

Unique in its price range is also the analog section of the HM407-2. The increased bandwidth of 40MHz (-3dB) allows the stable display of signals up to 100MHz. As always, the Component Tester with one-button control is a standard feature in the HM407-2. This is also true for the switchable 1kHz/1MHz Calibrator which permits you to check the transient characteristics from probe tip to the screen at any time.

All in all, the new HM407-2 presents itself as a practical hands-on oscilloscope for today's progressive measurement requirements offering a price/performance ratio that sets new standards world-wide.

### Accessories supplied:

Line Cord, Operators Manual and PC software on CD-ROM, 2 Probes 1:1/ 10:1

Screen photo of stored sinewave signals.

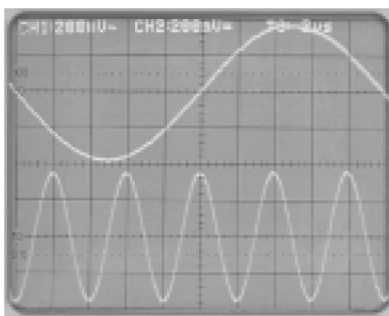

Screen shot of measurement software.

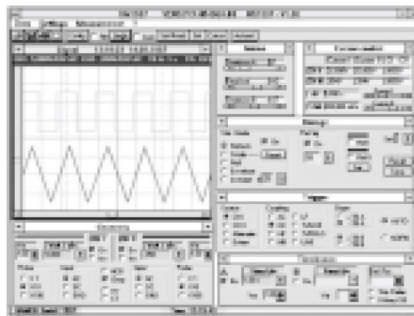





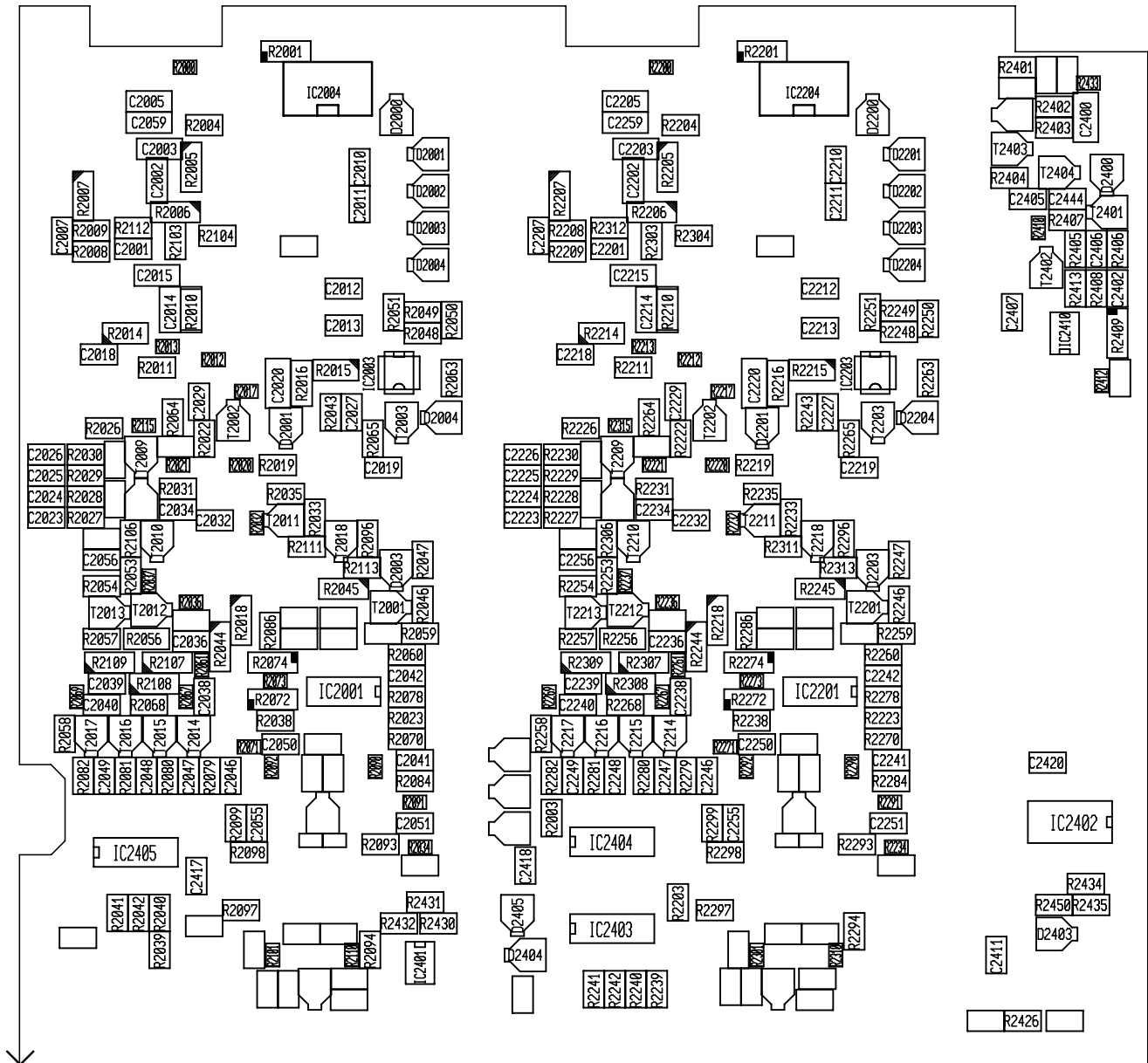

35-ATC0-5034R04



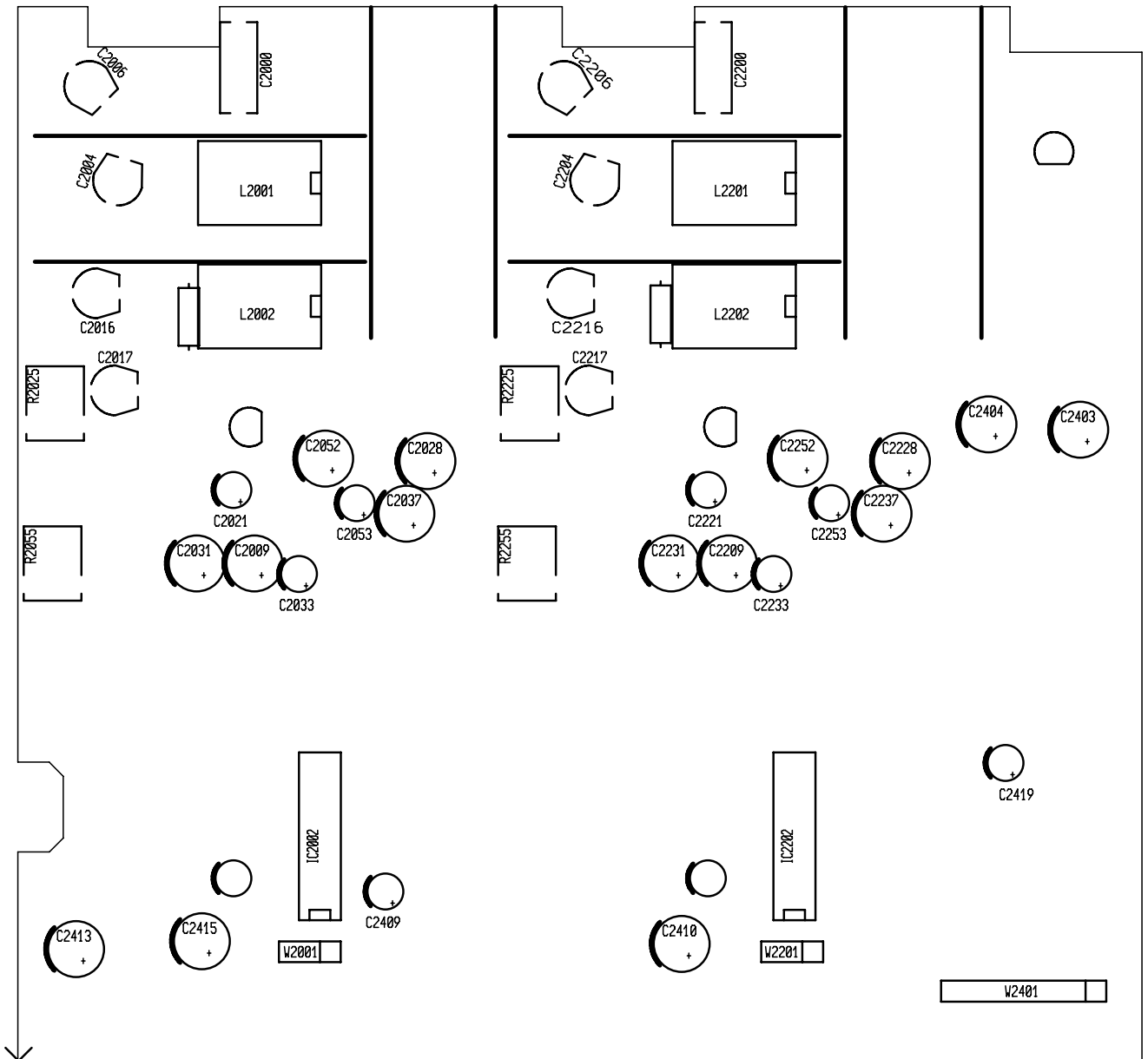

35-ATC0-5034R04

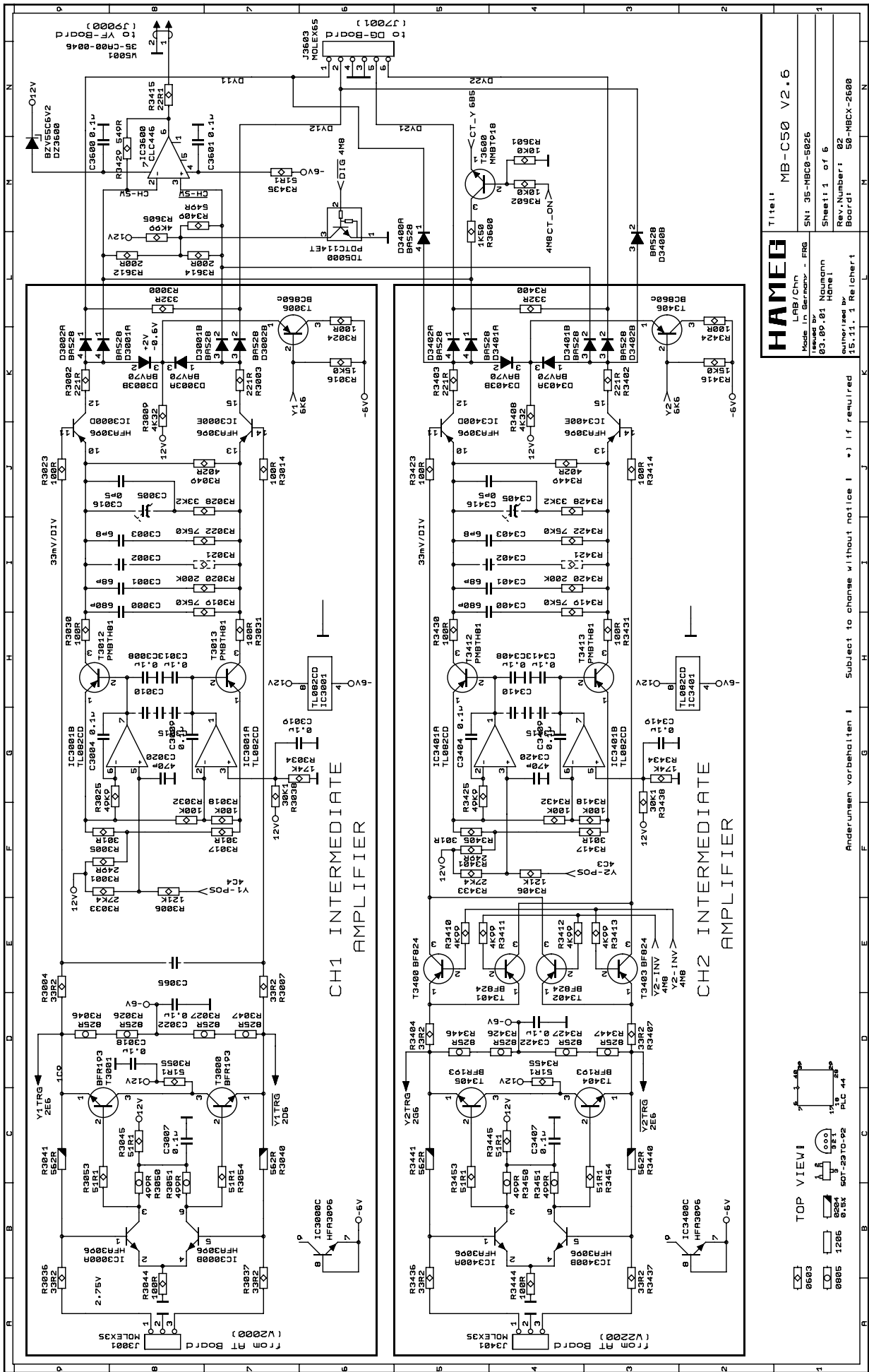

**HAMEG**  
 LAB/Chn - FRG  
 Made in Germany - FRG  
 Issued by Naumann  
 Rev. Number: 02  
 authorized by 15.11.1 Reichert

Titel: MB-C50 V2.6  
 SNI: 35-MBC0-5026  
 Sheet: 1 of 02  
 Rev. Number: 02  
 Board: 50-MBCX-2600

Subject to change without notice !  
 Änderungen vorbehalten !

TOP VIEW

5663 1/8  
 8885 0.5x  
 1286 0.5x  
 50T-23 10-02  
 ALC 44

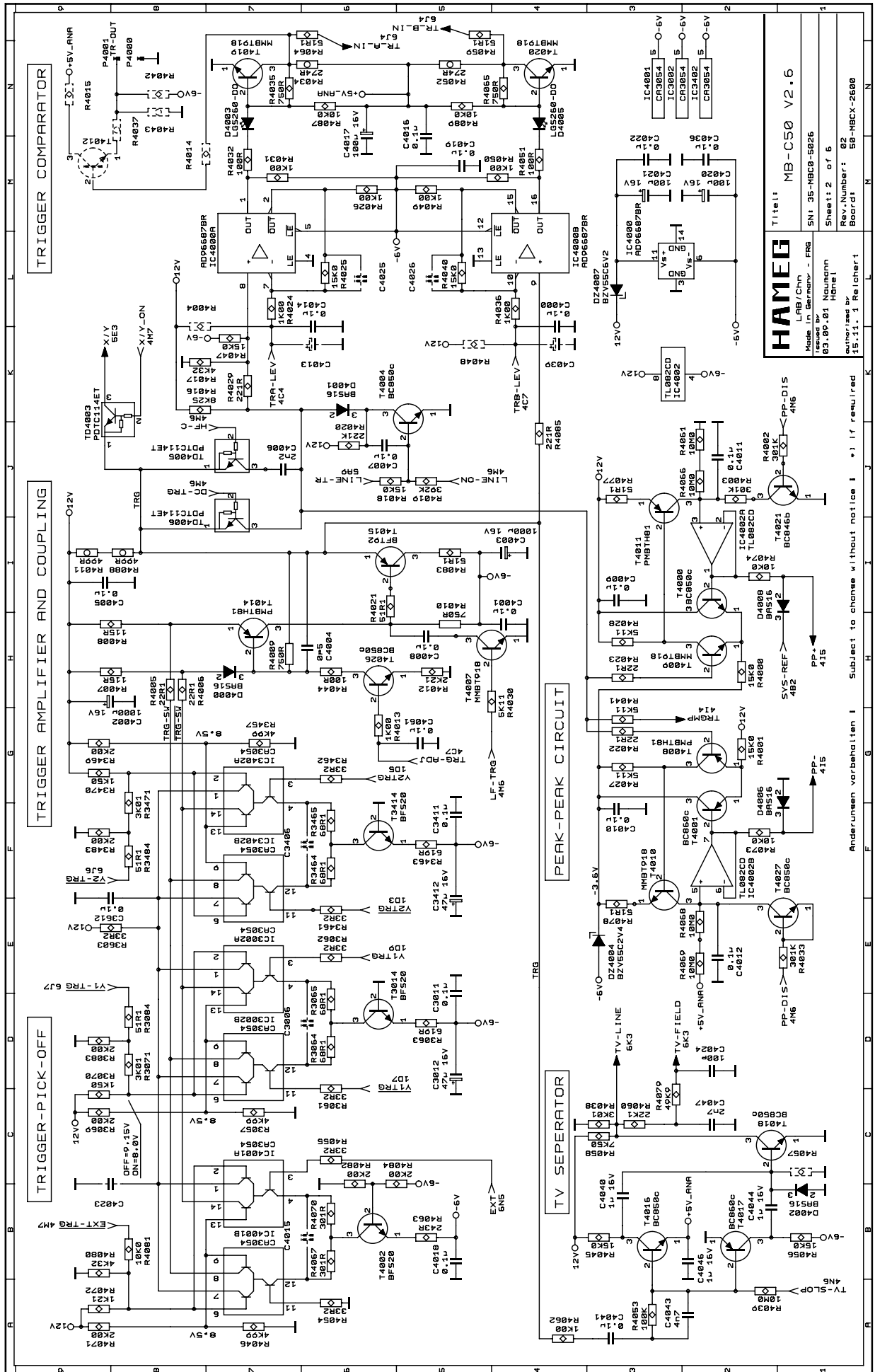

Titel: MB-C50 V2.6  
LAB/Chr  
Made in Germany - FRG  
SN 35-MBC0-5026  
Sheet 2 of 6  
Rev. Number: 02  
authorized by Hameg  
15.11.1 Reicherth  
Board: 50-MBCX-2600



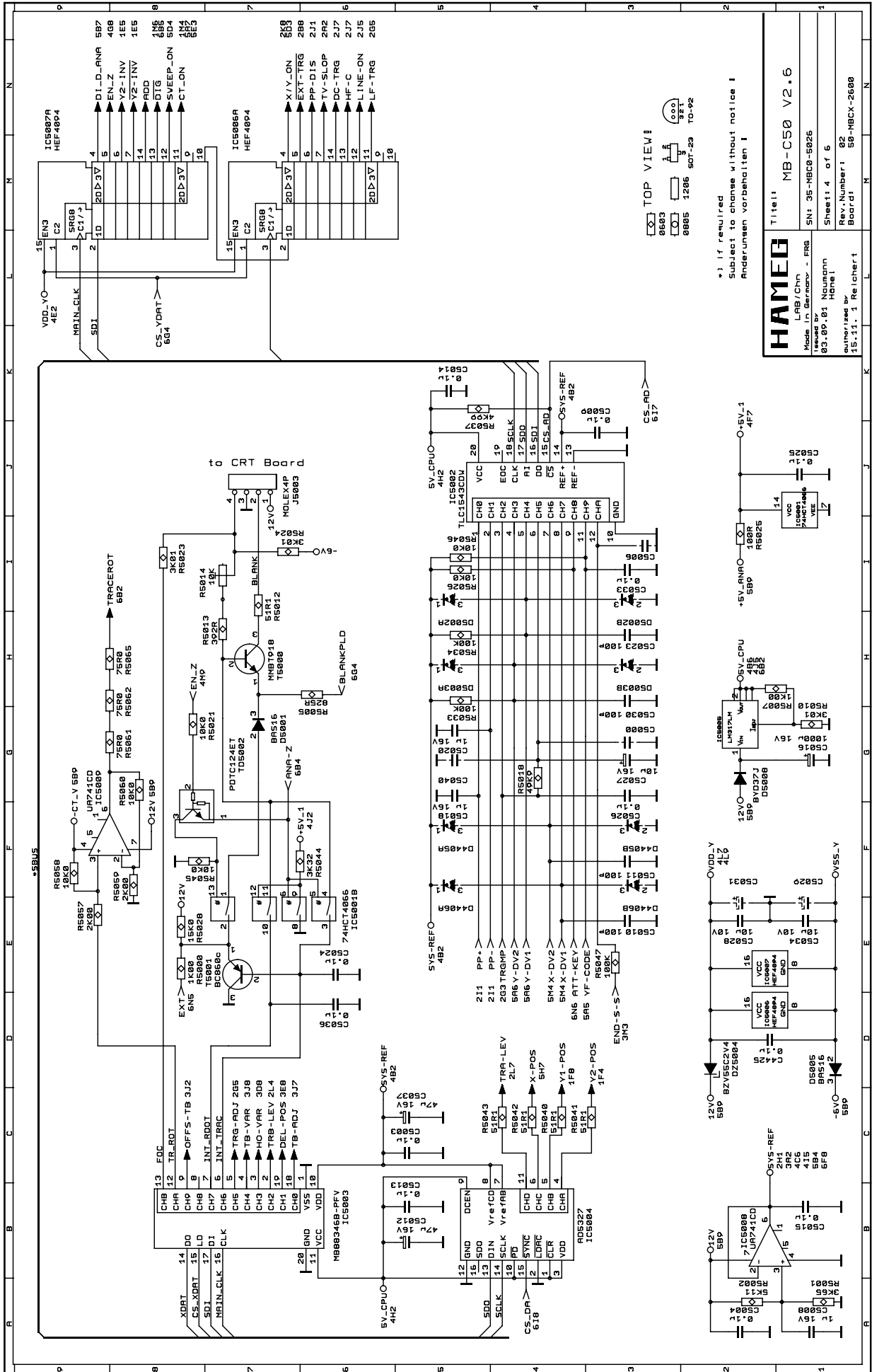









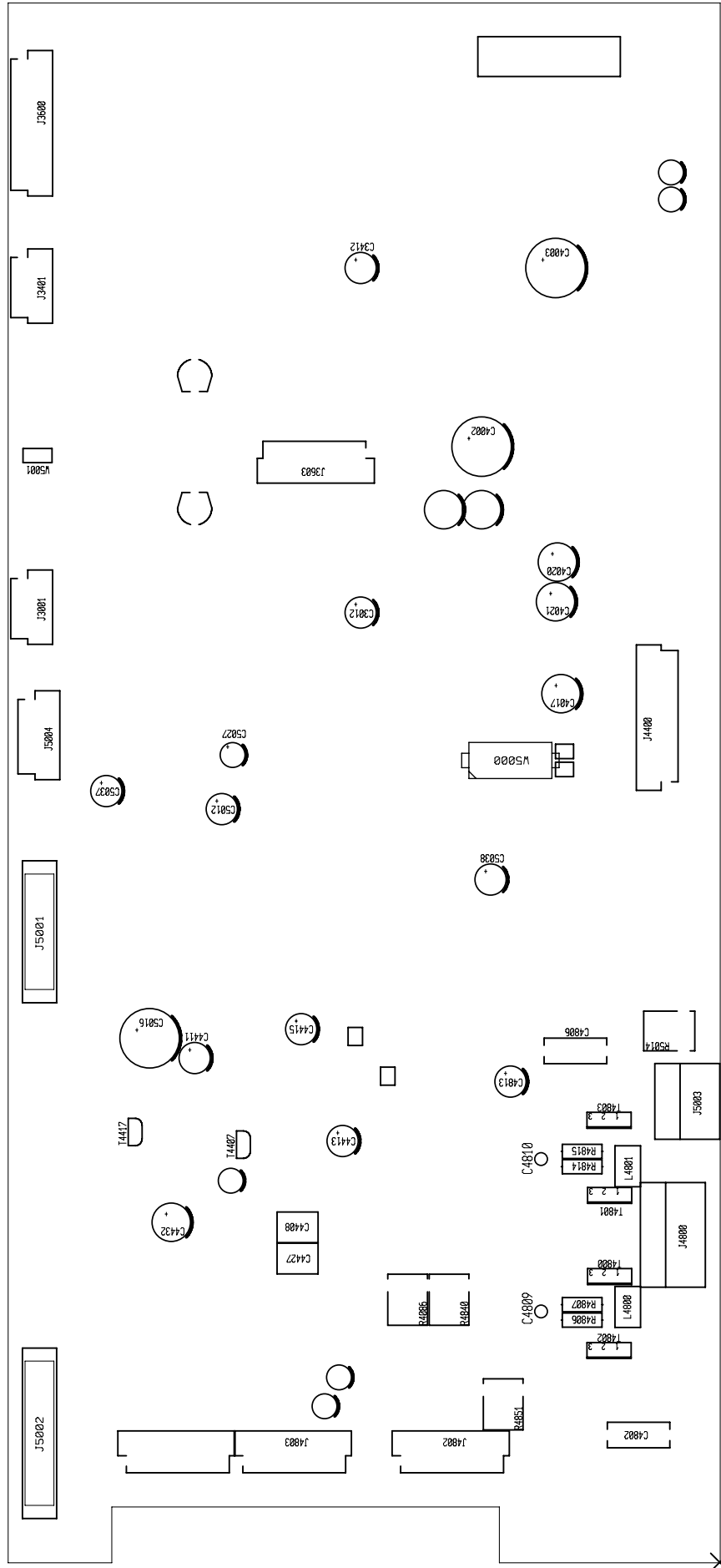

MB-C50V2.6R02 issued by: Naumann Home 1

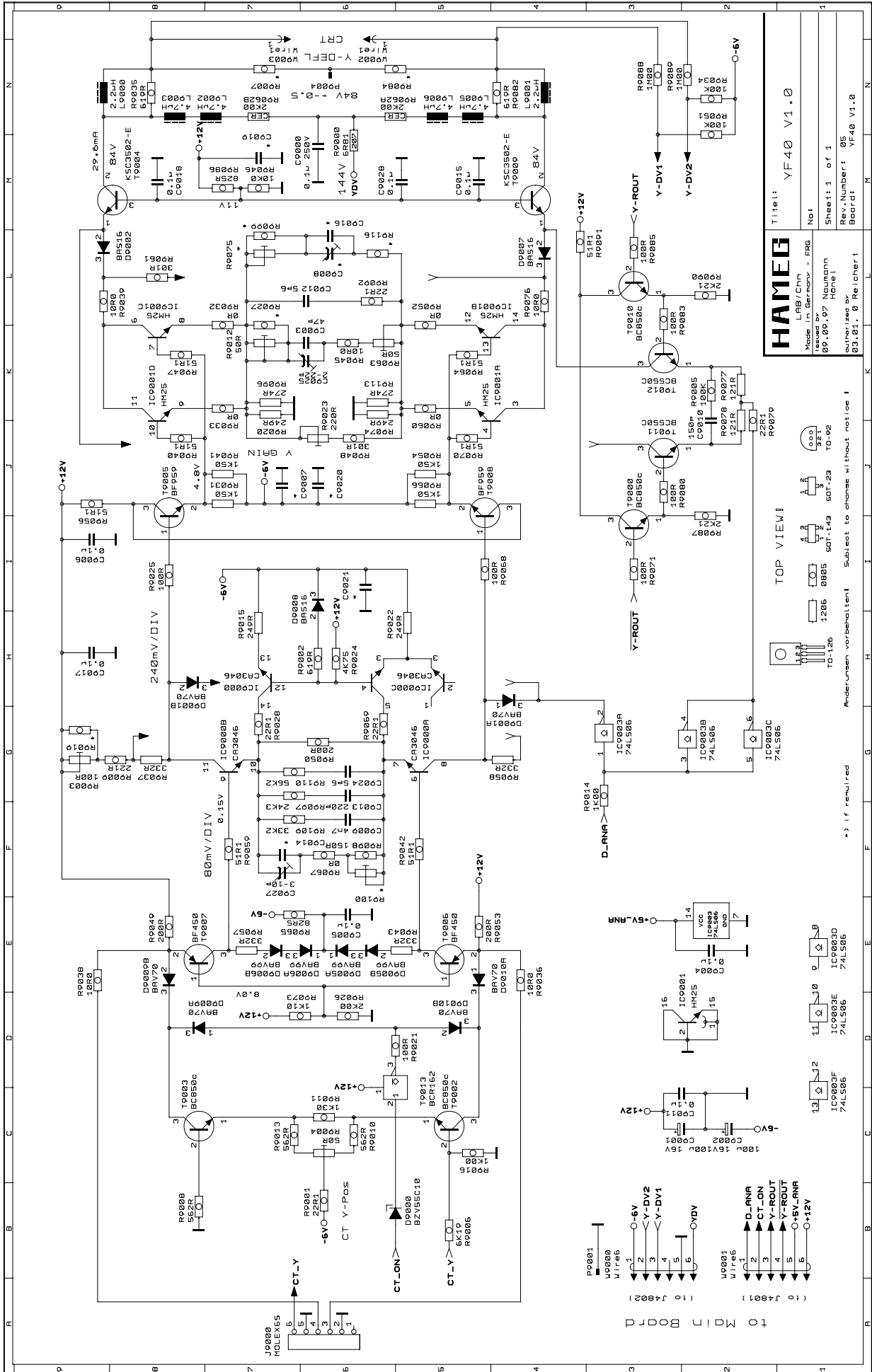



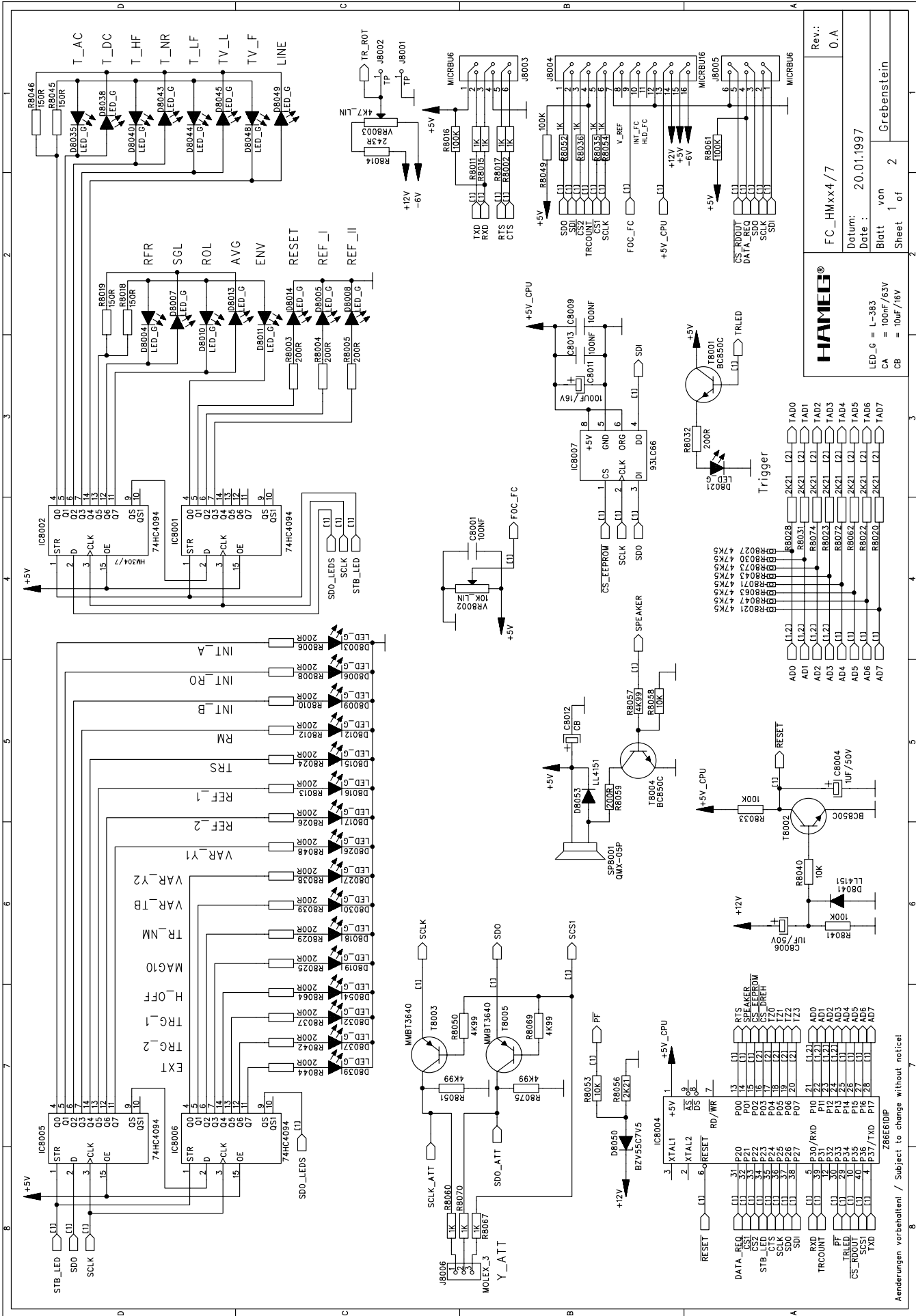

**HAMEES®**

FC\_HMxx4/7

Datum: 20.01.1997

Blatt von 2

Sheet 1 of 2

Rev.: 0.A

LED\_S = L-383  
CA = 100nF/63V  
CB = 10uF/16V

Grebenstein

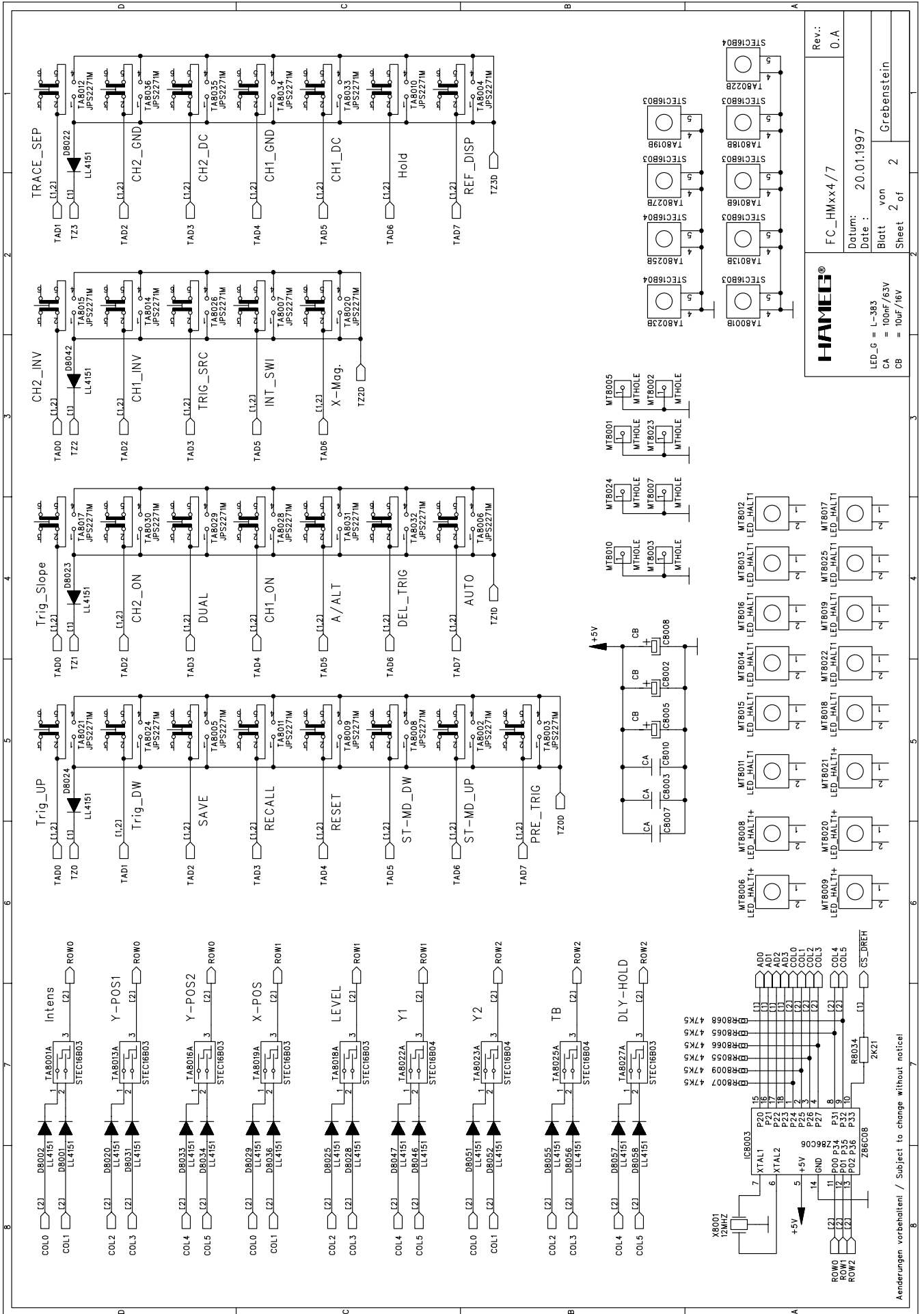

**HAMEL®**

FC\_HMxx4 / 7

Rev.: 0.A

Datum: 20.01.1997

Date: 20.01.1997

Blatt von 2

Sheet 2 of 2

LED\_g = L-383

CA = 100nF/63V

CB = 10nF/16V

Grebenstein

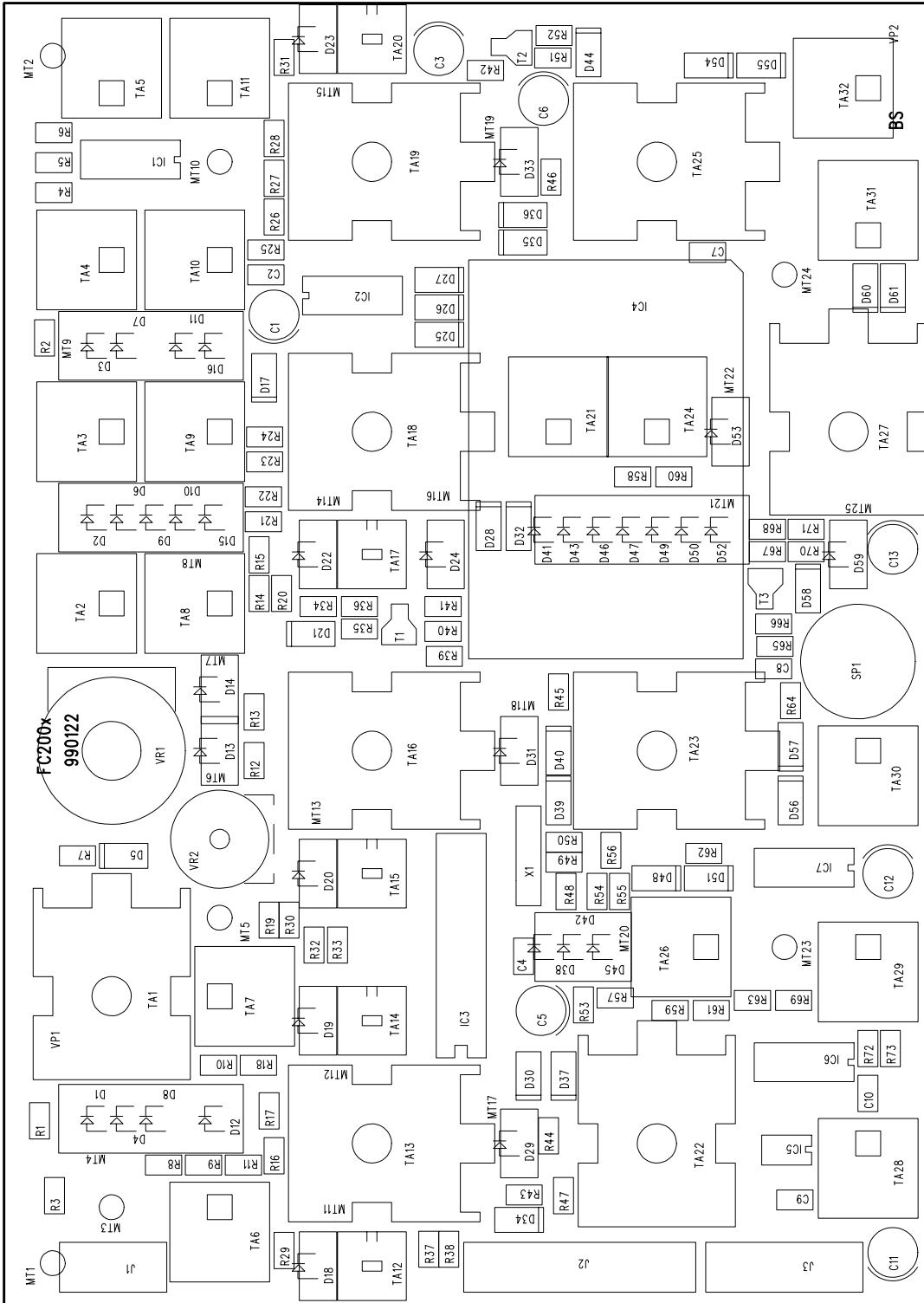

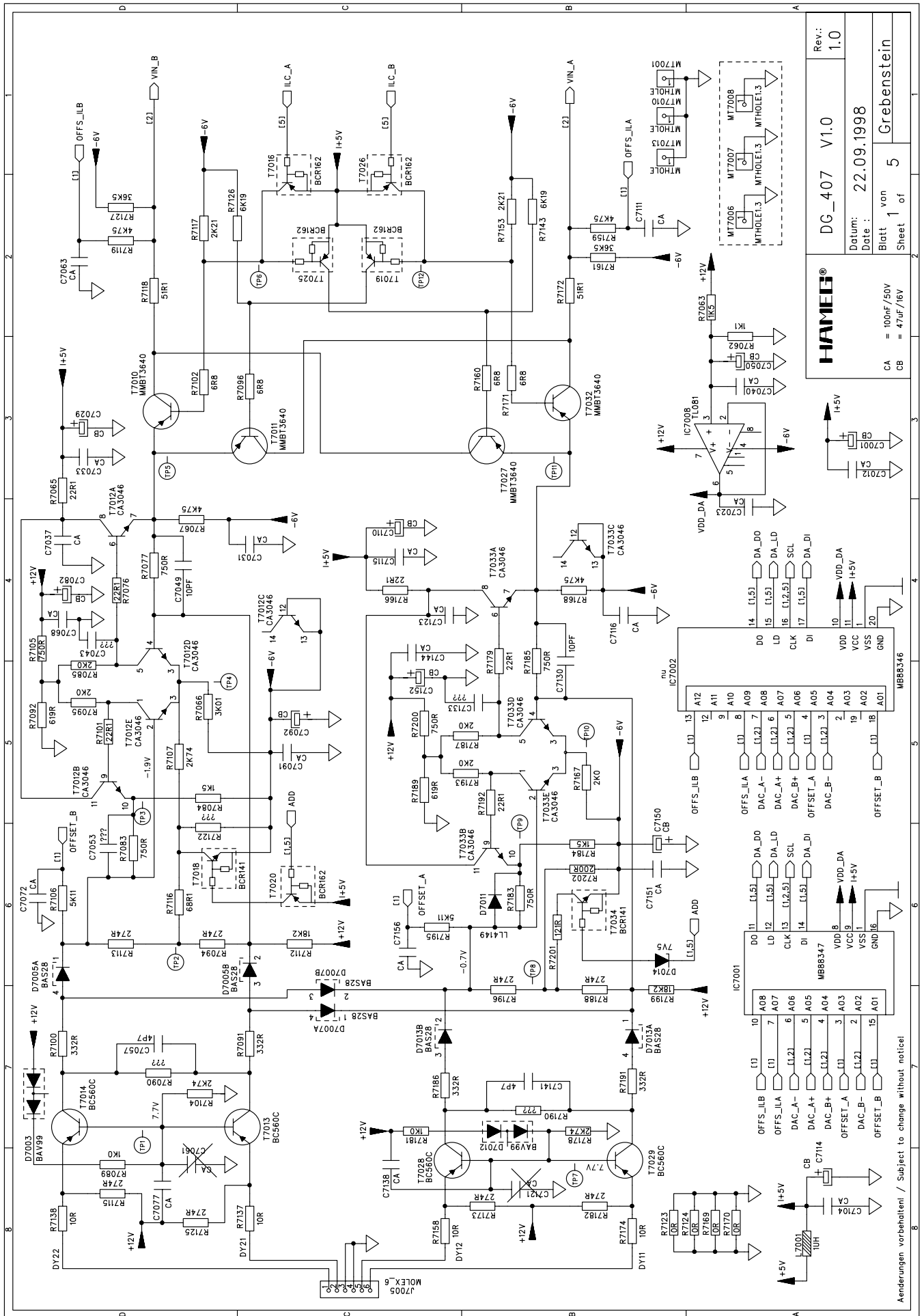

**HAMEE®**

Datum: 22.09.1998  
 Rev.: 1.0

Blatt 1 von 5  
 Grebenstein

CA = 100nF/50V  
 CB = 47uF/16V







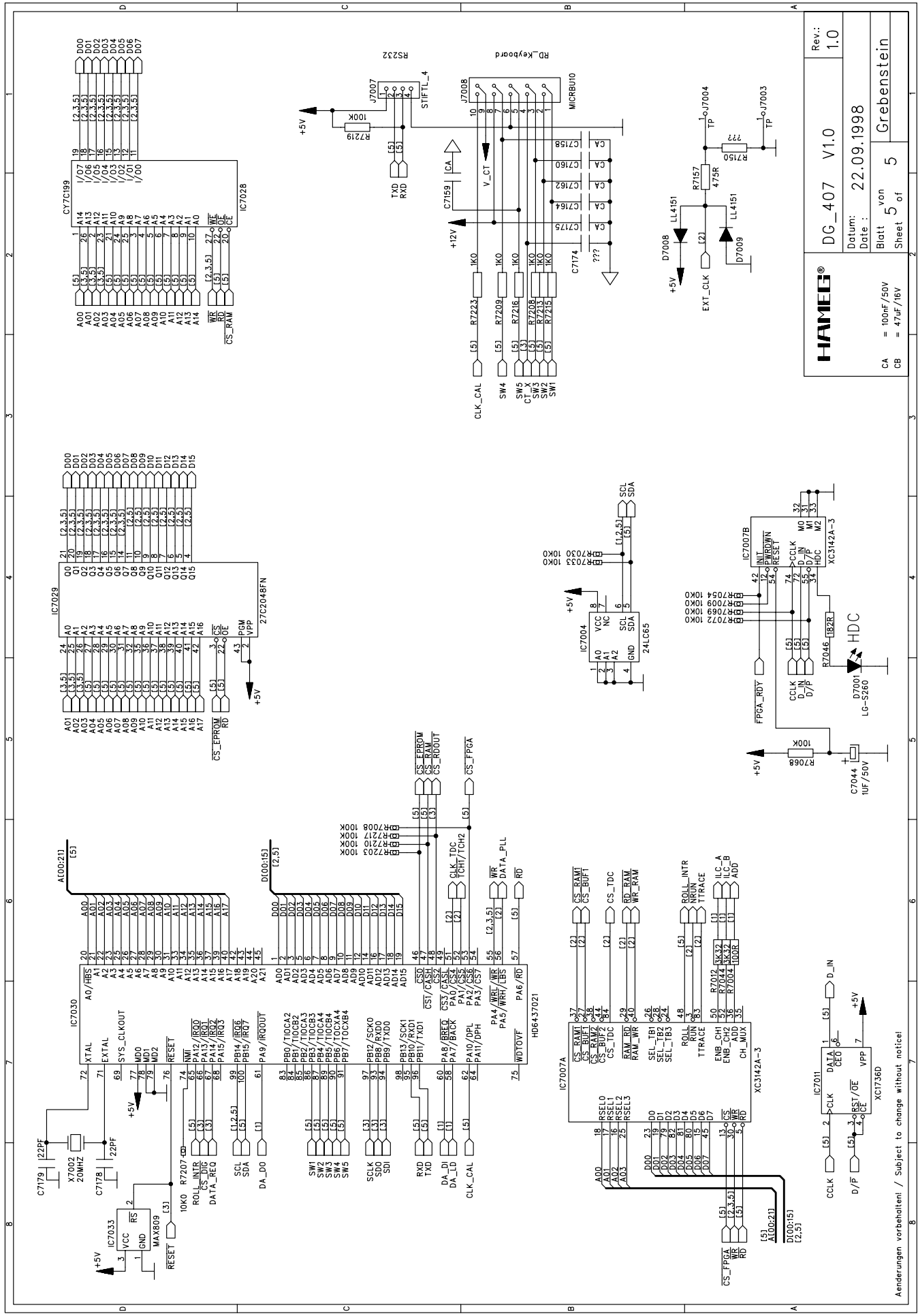

**HAMEL®**

Rev.: 1.0

Datum: 22.09.1998

Blatt 5 von 5

Sheet 5 of 5

CA = 100nF/50V

CB = 47uF/16V

Grebenstein









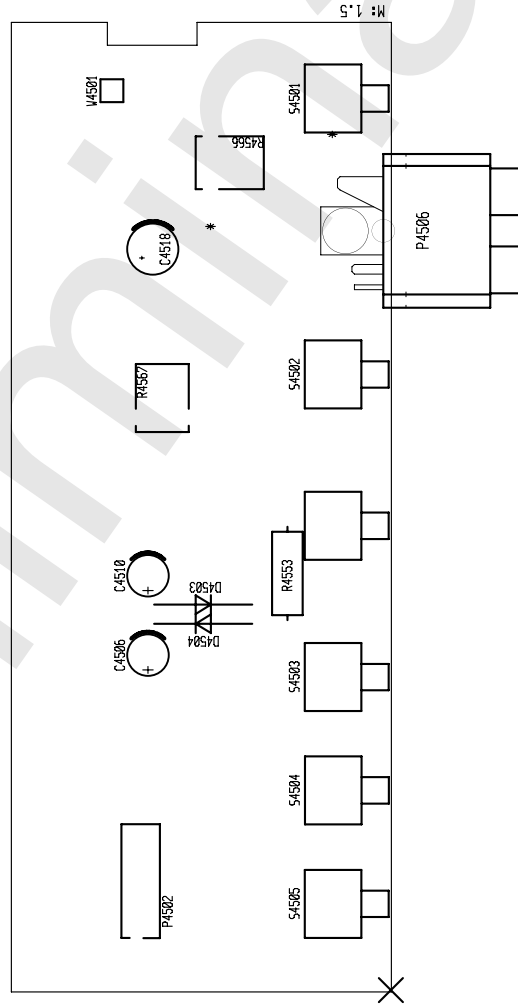

35-CCD0-0010 Rxx

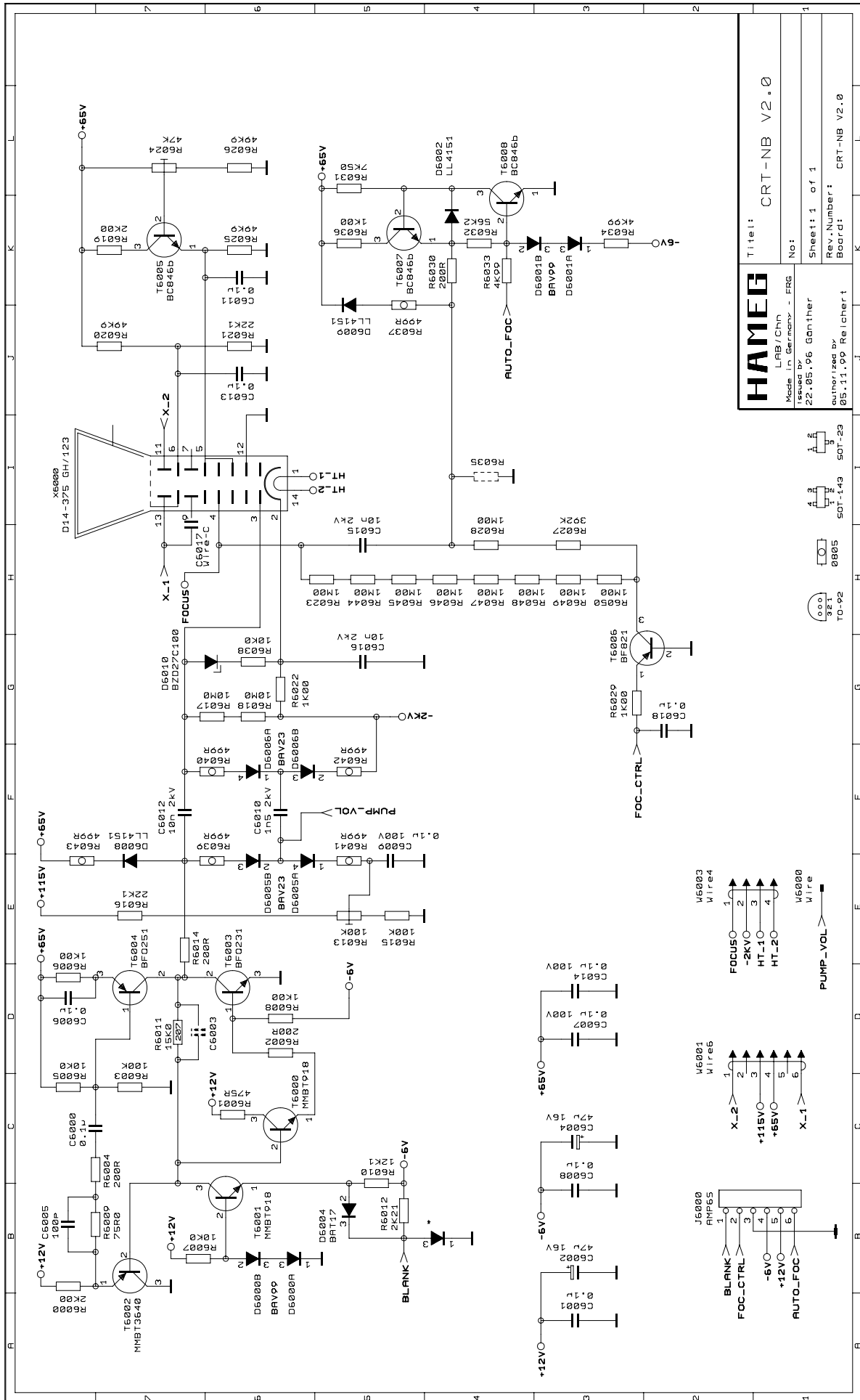

**HAMEG**  
 Made in Germany - FRG  
 Issued by: 22.05.96 Gonthier  
 authorized by: 05.11.99 Reicher 1

Titel: CRT-NB V2.0  
 No: Sheet 1 of 1  
 Rev. Number: CRT-NB V2.0  
 Board: SOT-143 SOT-23 TO-92



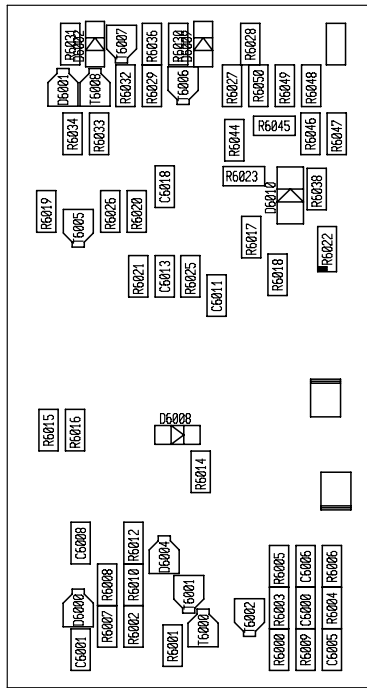

C6007 nicht bestückt !

CRT-NBV2.0R00

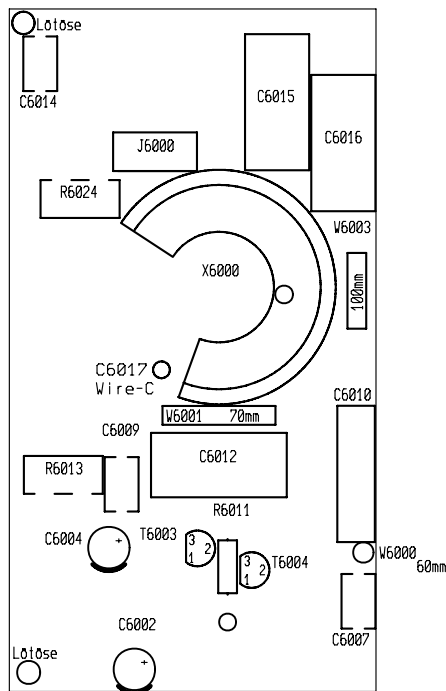

CRT-NBV2.0R00



# PS-MD-A40

Version: 1.0  
28.10.97

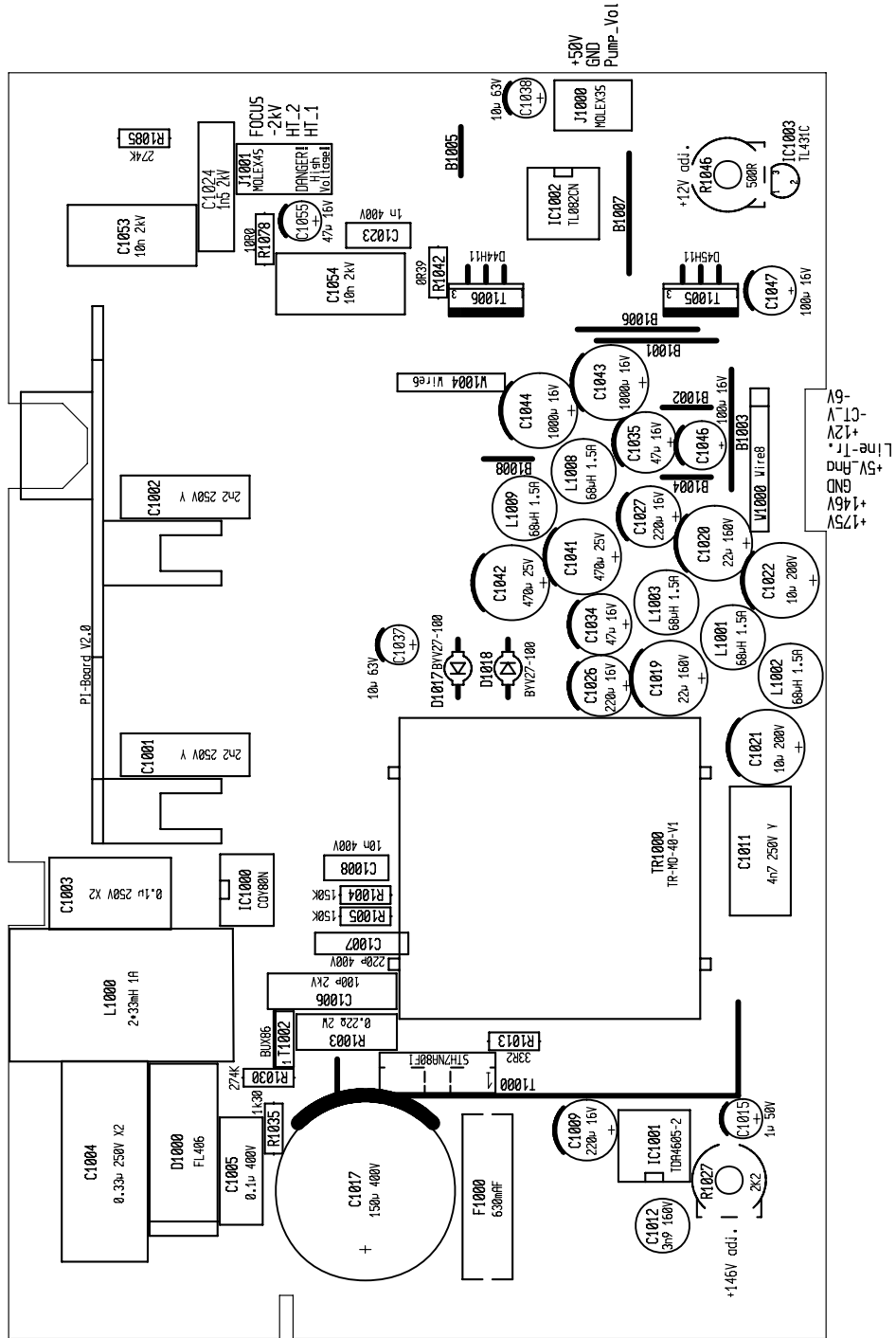



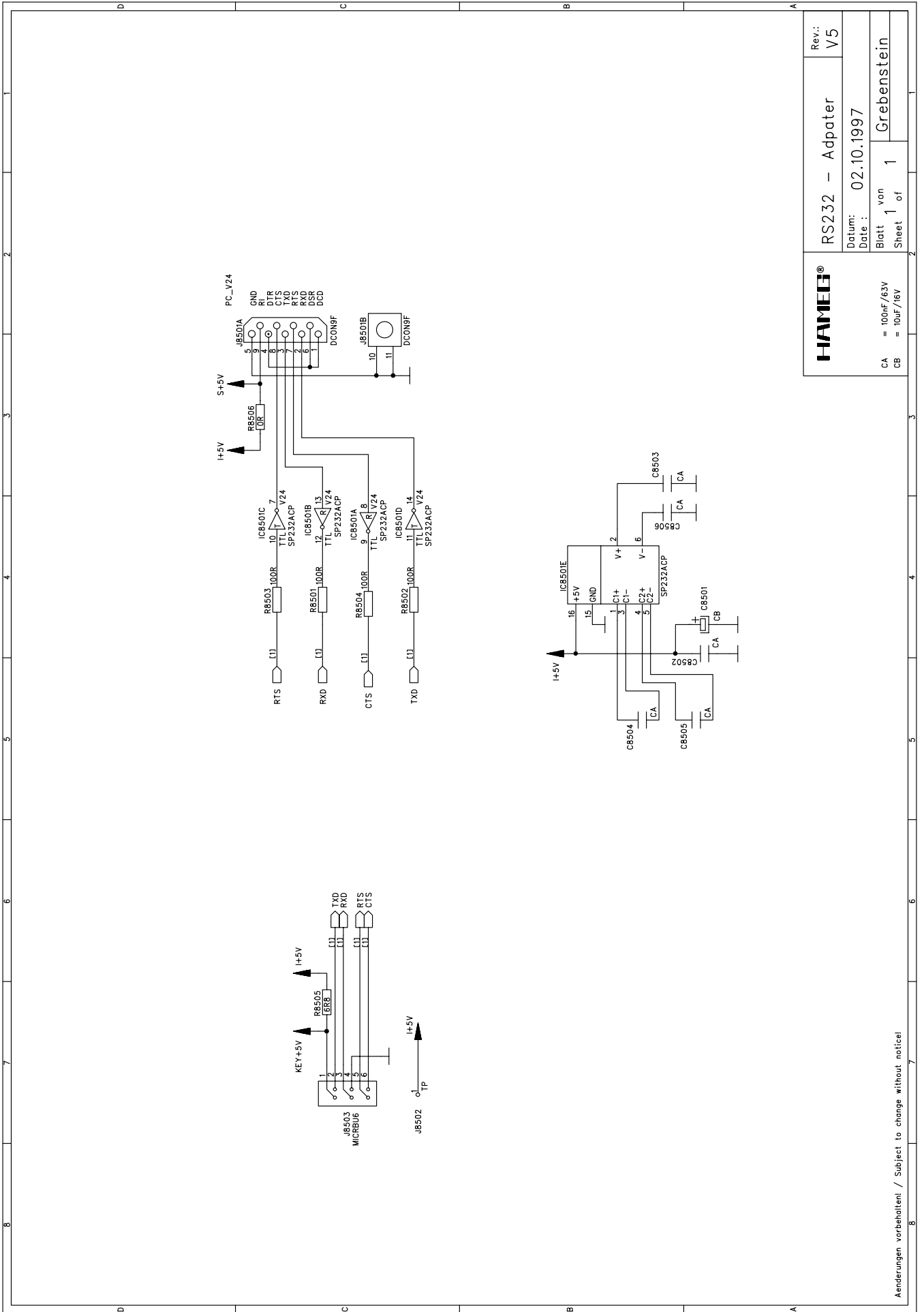

<b>HAMEL®</b>	RS232 – Adpater		Rev.: V5
	Datum: Date :		02.10.1997
	Blatt Sheet	von of	Grebenstein
	CA CB	= 100nF/63V = 10uF/16V	

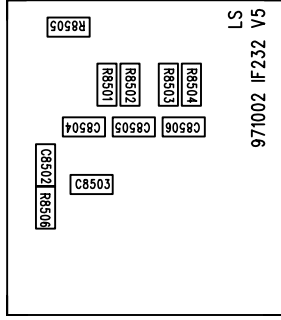



# **HAMEG<sup>®</sup>**

## **Instruments**

**Oscilloscopes**

**Multimeters**

**Counters**

**Frequency Synthesizers**

**Generators**

**R- and LC-Meters**

**Spectrum Analyzers**

**Power Supplies**

**Curve Tracers**

**Time Standards**

4S-0407-02E0

**HAMEG GmbH**

Industriestraße 6

63533 Mainhausen

Telefon: (0 61 82) 89 09-0

Telefax: (0 61 82) 89 09-30

E-mail: [sales@hameg.de](mailto:sales@hameg.de)

Internet:

**[www.hameg.de](http://www.hameg.de)**

Printed in Germany